

T-BERD®/MTS-5800 Handheld Network Tester

Enabling Carrier Ethernet, Advanced IP, SONET/SDH, and PDH Field Test



Key Benefits

- All-in-one handheld tool designed to reduce complexity of multi-technology testing
- Optimized for field ease-of-use while addressing emerging network technologies
- Guarantees maximum efficiency and success in the evolution of Carrier Ethernet and Mobile Backhaul networks
- Ensures service life cycle management, integrating both installation and troubleshooting capabilities in one instrument
- Automates services verification with support of J-Complete suite of test tools
- Latest addition to the leading portfolio of T-BERD/MTS portable test solutions – created by experts to simplify network deployment and trusted by leading service providers worldwide

Platform Highlights

- Handheld instrument that supports 10G Ethernet, SONET/SDH, and PDH testing with fixed interfaces
- LEDs on top panel indicate where to plug in for test
- Six hardware configurations to choose from
- Dual port operation enables performing two tests simultaneously
- Rapid boot-up from power on to start of test
- Four hours of battery test time
- Bluetooth support for easily offloading results
- WiFi for test set connectivity
- Remote control with VNC
- FiberScope connectivity



The T-BERD/MTS-5800 Handheld Network Tester addresses the challenges of the Carrier Ethernet evolution. It supports both legacy and emerging technologies required to handle various network applications including Metro/Core, Mobile Backhaul, and Business Services installations.

The industry's smallest 10G handheld instrument supports testing throughout the entire service life cycle including installation, troubleshooting, and maintenance. It is designed for field technicians who must verify network configurations, including network transparency, tunneling, and Ethernet OAM designs, as well as ensuring end-customer service level agreements (SLAs). Integrated J-Complete functionality, such as capture/decode and automated J-Mentor, helps field technicians perform guided troubleshooting without having to carry a separate analyzer instrument.

The T-BERD/MTS-5800 is a cost-effective field instrument that not only covers your test needs of today but also supports the cutting-edge technologies of tomorrow, namely Synchronous Ethernet and 1588v2 PTP. It ensures successful mobile backhaul transitions by validating new Ethernet synchronization deployments that guarantee successful mobile handoff between cell sites, thereby avoiding new service degradation.

Ethernet IP Testing Lifecycle

Installation

- Enhanced RFC 2544, including frame delay variation, asymmetric rates, and concurrent results to reduce overall test time
- Carrier Ethernet testing with Link and Service OAM (Y.1731), PBB/PBT, MPLS/VPLS, MPLS-TP, VLAN, Q-in-Q, and J-Proof Ethernet transparency
- Verify Ethernet synchronization using 1588v2 PTP or G.826x-based Synchronous Ethernet

Troubleshooting

- Line rate packet capture up to 10 Gbps
- Packet decodes with integrated WireShark
- J-Mentor provides expert troubleshooting post-capture analysis

2

Ethernet IP Applications

- Troubleshoots Ethernet/IP networks, captures and analyzes packets, and identifies network problems
- Tests Carrier Ethernet transport to verify class of service (CoS), Triple-Play Service, and Ethernet circuit transparency
- Emulates a 1588v2 master clock/slave recovery to ensure proper PTP message propagation and guarantee accurate timing with packet delay variation (PDV) with background traffic loads
- Verifies accurate SyncE frequency synchronization as well as ESMC message propagation
- Supports Packet Transport Network (PTN) testing with MPLS-TP traffic generation and QoS analysis, along with simultaneous verification of OAM Label 13 or 14 operation
- Confirms higher-layer Ethernet data applications and services at 10 Mbps to 10 Gbps rates with IPv4 and IPv6
- Tests Layer 1-4 Ethernet/IP SLAs with RFC 2544 for up to 8 VLAN tags, Q-in-Q, VPLS, and MPLS/VPLS encapsulation
- Tests 10 GigE LAN and WAN-PHY interfaces at 850, 1310, and 1550 nm wavelengths, and supports 50 GHz C-Band Tunable XFPs

Additional Transport Applications

- Tests SONET/SDH at OC-3/STM-1 through OC-192/STM-64 line rates including service disruption measurements and POH capture with triggers
- Conducts BER testing, service disruption, and circuit monitoring on T-carrier and PDH interfaces and mappings (T1, E1, E3, DS3, and E4)
- Provides fractional T1/E1, DS0 BER, signaling analysis, including Nx56 and Nx64 framing rates
- Confirms ISDN DS1 PRI interfaces by emulating TE and NT equipment, decoding D Channel, and placing/receiving voice calls
- Proves transport quality of 3.1 Gbps optical links using BER stress test patterns and latency measurements

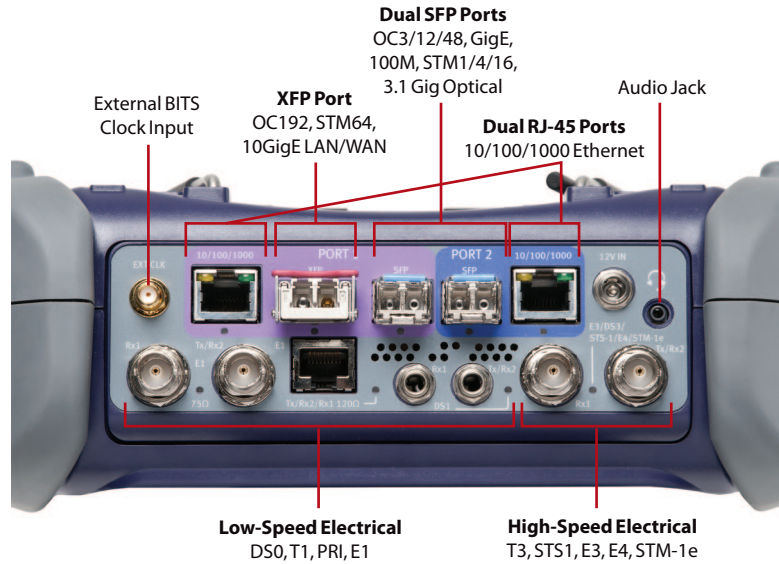

Test Interfaces

PDH	SONET/SDH	Ethernet	CPRI
DS0-PRI ISDN	OC3/STM-1	10/100/1000BaseT	3.1 Gbps Layer 1
DS1/E1	OC12/STM-4	100M Optical	
DS3/E3/STS-1e	OC48/STM-16	1GE Optical	
E4/STM-1e	OC192/STM-64	10GE LAN/WAN	

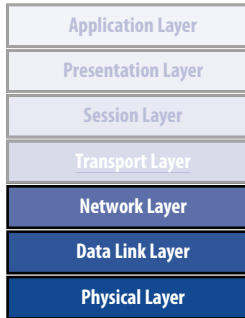

Carrier Ethernet Installation Testing

For years Ethernet/IP has been transported throughout carrier networks encapsulated in other data-link layer technologies that evolved into a carrier-grade technology because of operations, administration, and maintenance (OAM) standards such as ITU-T Y.1731, IEEE 802.1ag, and 802.3ah. Ethernet now possesses many of the characteristics that made SONET/SDH the transport technology of choice: end-to-end circuit transparency, redundancy, and full-featured OAM for circuit-based performance management and alarming. The T-BERD/MTS-5800 delivers a much-needed tool set for provisioning and troubleshooting Ethernet networks that substantially improves installation and troubleshooting times, thereby guaranteeing error-free operation and a significant reduction in operating expense (OpEx).

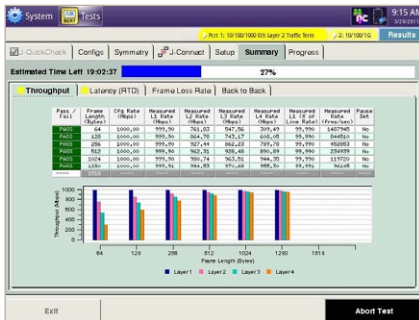

Enhanced RFC 2544 Testing

Enhanced RFC 2544 Testing

The T-BERD/MTS-5800 delivers all the Carrier Ethernet testing needed to qualify Ethernet-based transport networks. RFC 2544 is the defacto industry standard for Ethernet circuit installation. In addition to supporting Ethernet throughput or committed information rate (CIR), frame delay (FD) or latency, frame loss (FLR), and back-to-back burst testing as called out in the RFC, the T-BERD/MTS-5800 also tests for packet jitter or frame delay variation (FDV) to ensure the circuit is ready to transport time-sensitive services such as IPTV and VoIP. JDSU-enhanced RFC testing enables the measurement of CIR, FD, and FDV concurrently to reduce test time by more than 60 percent as well as delivers a new zeroing-in algorithm that more quickly establishes the maximum throughput of an Ethernet virtual circuit (EVC). Using a pair of test sets and Asymmetric RFC testing, users can validate EVCs with different upstream and downstream CIRs, or they can test sequentially in both directions to ensure that key performance indicators (KPIs) are met across any connection type.

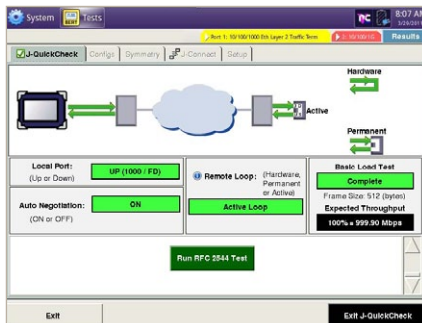

J-QuickCheck

J-QuickCheck your circuit prior to RFC

J-QuickCheck performs a fast pre-configuration test prior to running an RFC test that quickly confirms the port duplex setting and end-to-end circuit connectivity and estimates the attainable throughput, thus saving technicians valuable time. Too often these basic issues halt or delay the workflow of installation testing negatively impacting OpEx.

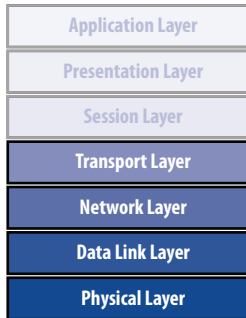

Triple-Play Service Test

The JDSU Triple-Play Service test simplifies the setup and interpretation of results for voice, video, and data services. This test also lets users emulate multiple voice calls, two video streams, and two different data streams, enabling them to quickly configure a test without having to calculate per-service stream bandwidth and characteristics. Quick configurations include the number of voice calls, the codec, and the number of standard (SDTV) and high definition television (HDTV) streams, including compression used as well as two different data streams with constant or ramp traffic patterns. QoS results, such as throughput, delay, loss, and jitter, are measured per CoS to verify that the network is properly prioritizing each service type.

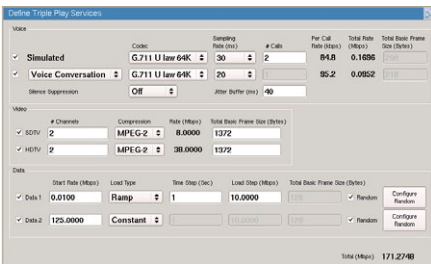

Configuring triple-play profiles

Verifying CoS with Multiple Streams

Multi-Stream testing generates several streams of traffic at the Ethernet, IP, and TCP/UDP layers (Layers 2-4) to emulate various types of traffic with the appropriate CoS mappings so that users can assess the impact of traffic prioritization on the overall network architecture while confirming proper network element queuing, policing, and shaping. Up to 10 individually configured streams enable generation and analysis of per stream key parameters such as VLAN ID and priority, TOS/DSCP marking, packet size, source/destination IP and MAC address, and source/destination TCP/UDP ports. Users can configure constant or ramp traffic to simulate near real-world traffic before actually delivering a service. This level of testing confirms the network design as well as drastically reduces post-installation troubleshooting.

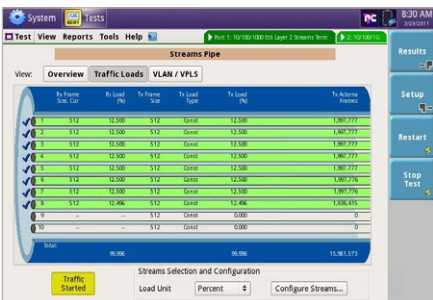

Triple-play summary network pipe screen

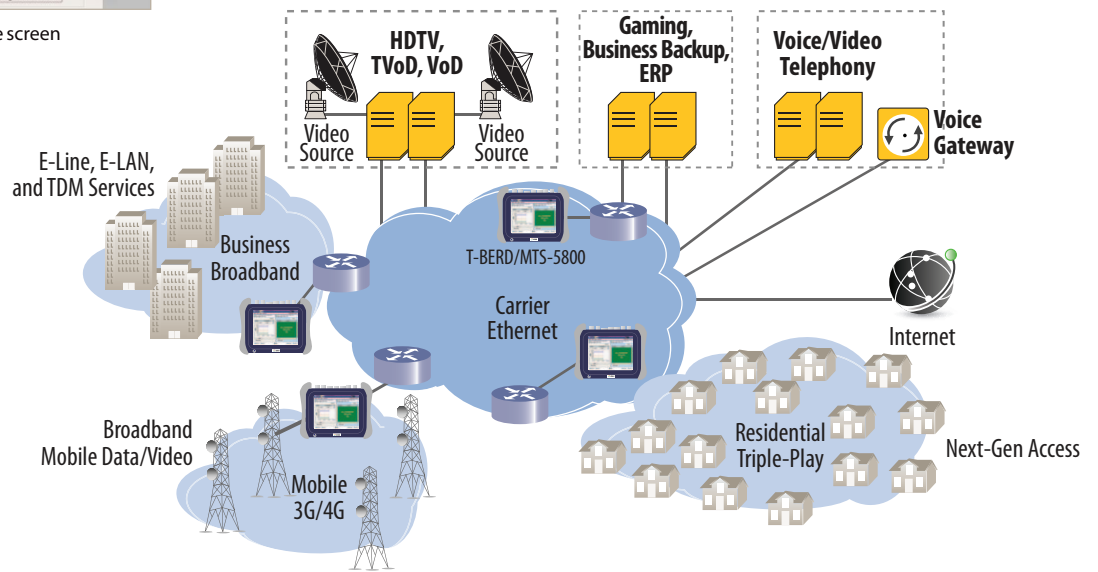

Carrier Ethernet Network

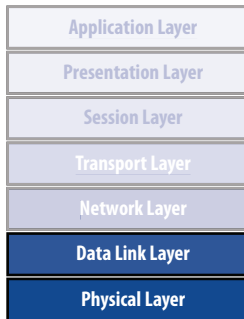

Ethernet OAM, VLAN, Q-in-Q, VPLS, MPLS, and PBB/PBT Tunneling Technologies

Ethernet tagging and encapsulation is commonly used to improve the scalability of Ethernet networks by isolating customer traffic and, in the case of provider backbone bridging (PBB), minimizing the number of MAC addresses that equipment must learn. Regardless of the encapsulation and tagging used, the T-BERD/MTS-5800 tests CoS to confirm KPIs such as CIR, FD, FDV, and FLR. Support for virtual local area network (VLAN) tags, Q-in-Q VLAN tags, PBB (also known as MAC-in-MAC) and multi-protocol label switching (MPLS)/virtual private LAN service (VPLS), the T-BERD/MTS-5800 enables testing at any part of the Metro network.

J-Proof Ethernet Transparency Test

J-Proof is a Carrier Ethernet test that can confirm end-to-end transparency of Ethernet between two end points anywhere on a network using slow protocol data unit (PDU) generation that will not interrupt an existing service. Service providers can use J-Proof to confirm the transparent transport of control plane messages such as STP, GARP, and many of the Cisco proprietary protocols in use today, such as CDP and VTP. A powerful, customizable Ethernet frame generator tests the transparency of almost any Ethernet control plane message, even when a pre-defined frame is not available. Testing with J-Proof enables customers to guarantee that an intermediate network is not filtering their control plane traffic.

Link and Service Ethernet OAM (Y.1731)

The Ethernet OAM features of the T-BERD/MTS-5800 were designed for technicians who install and troubleshoot Ethernet circuits to deliver end-to-end connectivity fault management (CFM) including connectivity check messages, Ethernet loopback, and link trace generation and analysis. For testing cell site Ethernet backhaul and Ethernet business services, technicians can install and troubleshoot Ethernet circuits using CFM tests based on IEEE 802.1ag and ITU Y.1731 standards.

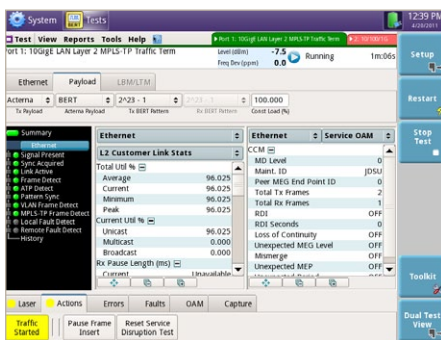

Verifying MPLS-TP with OAM

MPLS-TP – PTN Ready

MPLS-TP, an emerging Layer 2 packet-based transport technology, is critical to the successful deployment of Carrier Ethernet services driven by high-bandwidth, high-performance applications such as LTE, Internet Protocol (IP) Video, and Mobile Backhaul. The T-BERD/MTS-5800 gives providers confidence that MPLS-TP services are delivered with true carrier-class QoS; with properly functioning end-to-end operations, administration, and maintenance (OAM); as well as protection switching. By providing both customer data and control plane traffic verification in one easy-to-use tool means that the MPLS-TP test suite saves both installation and troubleshooting time and efforts. Simple to understand pass (green)/fail (red) results as well as detailed traffic and OAM statistics appeal to both expert and novice users. MPLS-TP testing includes the ability to generate and analyze full line rate MPLS-TP data traffic for 10 Mbps to 10 Gbps PTN links. As

a terminate or passive monitor application, it verifies key SLA and QoS metrics. It also supports comprehensive MPLS-TP OAM in compliance with both ITU-T pre-standard G.8114 and IETF draft MPLS-TP OAM based on Y.1731. Generating and monitoring OAM messages at pseudowire, Label Switched Path (LSP), or section layer, operating with both Label 13 or Label 14, enables verification of proper OAM operation can be verified.

Ethernet Timing Synchronization Verification using 1588v2 PTP and G.826x SyncE

Critical network timing and frequency synchronization testing enables service providers to analyze emerging 1588v2 PTP and Synchronous Ethernet (SyncE) protocols greatly reducing expenses for mobile backhaul and LTE by eliminating the need for TDM/GPS. Wireless backhaul providers can now verify whether Ethernet links can transfer PTP protocols by connecting to a PTP master and measuring critical packet parameters such as PDV with simultaneous network traffic loading. SyncE testing recovers the timing of an incoming Ethernet interface for the tester's transmitter. Capturing and decoding the 1588v2 PTP and Ethernet Synchronization Messaging Channel (ESMC) messages allows operators to verify and troubleshoot proper configuration and operation of synchronization networks.

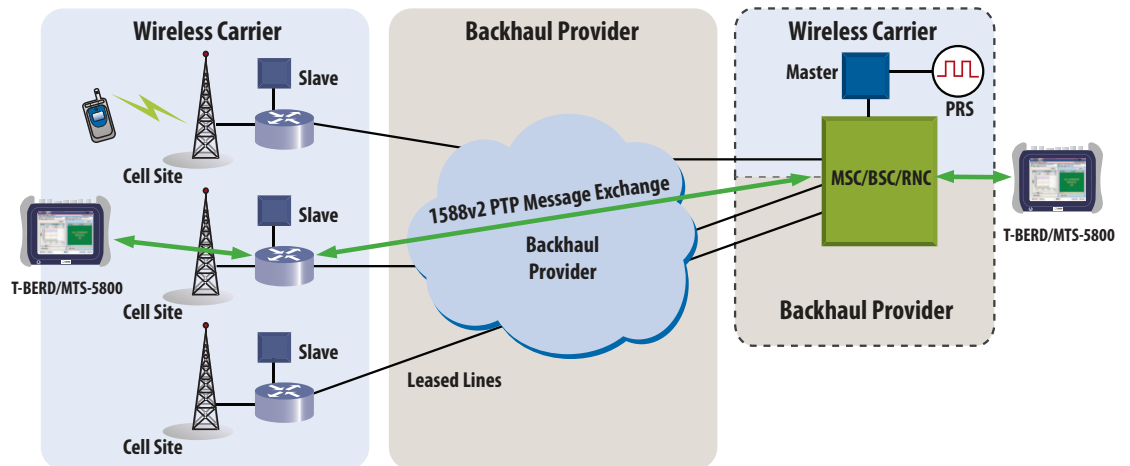

1588v2 PTP testing in Mobile Backhaul network

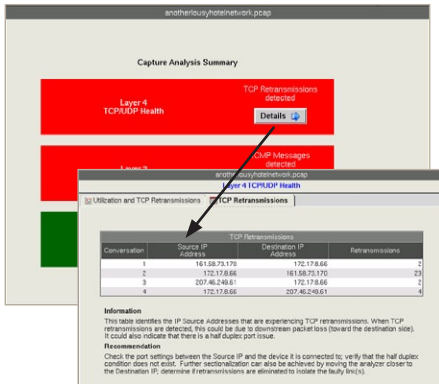
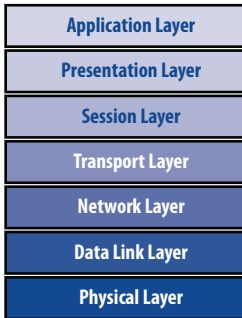

Troubleshoot with J-Mentor

Carrier Ethernet Fault Isolation Testing

Packet Capture, WireShark Decode, J-Mentor Expert Analysis Troubleshooting

In the ever-changing Ethernet and IP world providers must quickly, cost-efficiently, and reliably troubleshoot problems at all layers of the stack. The T-BERD/MTS-5800 provides powerful line-rate packet capture at all Ethernet speeds (10 Mbps to 10 GigE) without dropping a single packet. When troubleshooting problems occur intermittently or inconsistently, it supports multiple traffic filters and triggers, including 16-byte pattern identification, to isolate the exact problem and minimize the amount of information gathered.

The T-BERD/MTS-5800 natively supports WireShark for on-instrument packet decode. Additionally, users can save captured traffic in a standard pcap file format and export it via USB for further analysis.

J-Mentor Expert Analysis provides the visibility needed to lower the costs and difficulties associated with resolving problems such as incorrect priority provisioning, misconfigured IP addresses, TCP retransmissions, unresolved ARPs, and routing issues. J-Mentor Expert enables analysis of pcap files on the T-BERD/MTS-5800. It also automatically makes recommendations to users for resolving problems discovered. Likewise, it makes available a list of top talkers to expose top bandwidth hogs.

Application Layer
Presentation Layer
Session Layer
Transport Layer
Network Layer
Data Link Layer
Physical Layer

3.1 Gbps Optical Transport

3.1 Gbps Optical Application Overview

Long-term evolution (LTE) and 3G/4G wireless backhaul deployments are increasingly using the Common Public Radio Interface (CPRI) protocol to implement more cost-effective distributive wireless base station architectures. Smaller, lower-cost radio heads (antennas) located at cell sites are connected via 3.1 Gbps Optical links transporting CPRI to a single radio controller located at the central office, reducing Wireless Operator OpEx/CapEx. CPRI is the communication protocol that is used to synchronize, control, and transport data between the radio controller and remote radio heads. The 3.1 Gbps Optical test application enables technicians to validate correct configuration of the transport equipment and underlying dark fiber/DWDM network to transport this protocol reliably and meet CPRI service requirements.

BER and Latency Testing

The T-BERD/MTS-5800 3.1 Gbps Optical application supports optical Layer 1 (L1) BER testing for stress testing the underlying physical transport link. A standard 2^{23} pattern is used to obtain key QoS measurements including bit error rates, pattern sync, latency, line coding, and signal/power levels

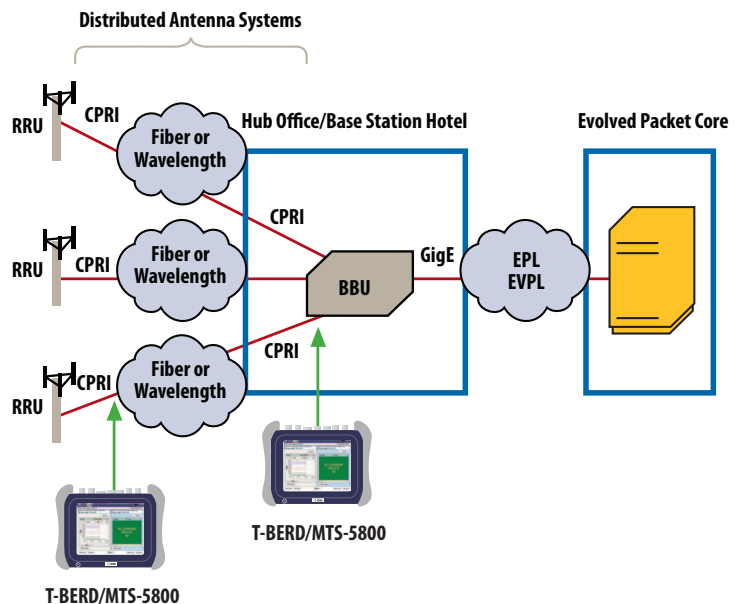

Service Disruption Measurements



SONET/SDH and PDH/T-Carrier

DS0 to 10 G SONET/SDH Testing

The T-BERD/MTS-5800 performs BER testing on all line interfaces in end-to-end or loopback applications, inserts errors and alarms to verify NE conformance and connectivity, and measures BERs from DS1 (1.5M)/E1 (2.048M) rates to OC-192/STM-64. Support for ISDN PRI and T1 signaling as well as fractional (Nx56k, Nx64k) T1/E1 and VF tone generation and measurement are included from the electrical interfaces. For STM/OC interfaces, J-Scan provides automated tributary/channel scanning and alarm reporting enabling drill down into the errored tributary/channel. E4, STM1e, and STS-1e electrical interfaces are also available.

SONET/SDH Overhead Byte Manipulation and Analysis

Using the overhead byte manipulation and analysis capability, users can modify K1 and K2 bytes to test automatic protection switching (APS) to specify and identify user-configurable path trace messages and payloads. The path overhead (POH) capture feature facilitates troubleshooting end-to-end problems. The T-BERD/MTS-5800 supports manual capture, capture on alarm, and capture based on user-defined triggers.

Service Disruption Measurements

The T-BERD/MTS-5800 measures the protection switch times of SONET/SDH rings and their effects on tributaries. Simultaneous monitoring of various error conditions on the tributaries, lets providers verify that their transport network is providing adequate redundancy to guarantee SLAs shown below.

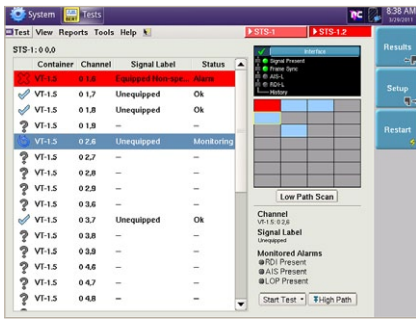

J-Scan

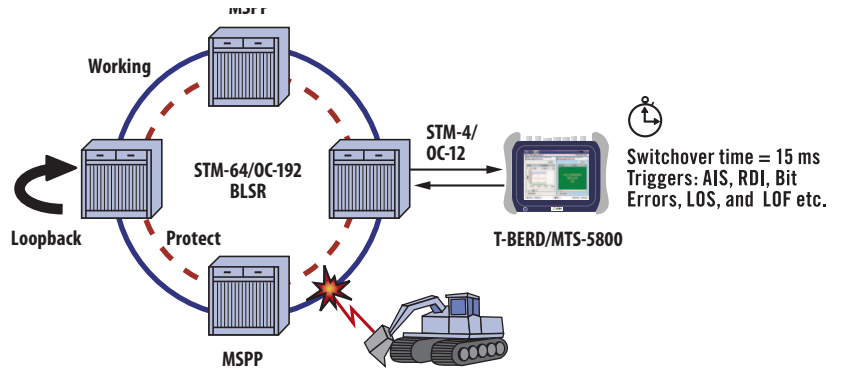

Service Disruption

10

Specifications

Physical

Dimension	5801/5802/5812	5801P/5802P/5812P
Height	17.02 cm (6.7 in)	17.02 cm (6.7 in)
Width	21.34 cm (8.4 in)	21.34 cm (8.4 in)
Depth	4.06 cm (1.6 in)	8.13 cm (3.2 in)
Weight	1.47 kg (3.25 lb)	1.72 kg (3.8 lb)

Power*

Parameter	
Operating time	Up to 4 hours (depending on type of test)
Charging time	Approximately 7 hours from empty
Unit power input	12 VDC, 60 W Max
Power supply input	100 to 240 VAC, 50/60 Hz, autosensing
Power supply output	12 VDC, 5 AMP Max

*Standard removable Li-ion battery and AD/DC adapter

Environmental

Operating temperature	0 to 50°C
Operating humidity	10–90% RH non-condensing
Storage temperature	–10 to 60°C
Storage humidity	10-95% RH non-condensing
Shock/Drop/Vibe	
Shock	per IEC 68-2-27 and 68-2-29 Ed. 2.0
Drop	per IEC 721-3-7 2nd Ed. /IEC 61010-1
Vibration	per IEC 68-2-6 and MIL-PRF-28800F (Class 2)

General

Touch screen	7-inch LCD Resolution 800x600 high visibility
Storage and I/O Interfaces	
Internal Memory	Minimum of 1G (thousands of reports)
Ports	2x USB 2.0, 1x RJ45 Ethernet, 1x serial RS-232, 1x Bluetooth, 1x WiFi with USB adaptor, 1x Analog headset jack

Test & Measurement Regional Sales

NORTH AMERICA TEL: 1 866 228 3762 FAX: +1 301 353 9216	LATIN AMERICA TEL: +1 954 688 5660 FAX: +1 954 345 4668	ASIA PACIFIC TEL: +852 2892 0990 FAX: +852 2892 0770	EMEA TEL: +49 7121 86 2222 FAX: +49 7121 86 1222	WEBSITE: www.jdsu.com/test
---	--	---	---	--