

# WaveRunner® 6 Zi Series

400 MHz–4 GHz  
(8-bit and 12-bit Resolution)

The Ultimate  
Debug Machine



# THE ULTIMATE DEBUG MACHINE



## Superior Validation, Debug, Analysis

The WaveRunner® 6 Zi defines superiority in a test instrument with a powerful feature set including a wide range of application packages, advanced triggering to isolate events, a user interface developed for quick and easy navigation, a wide range of probing options, and lightning-fast performance.

## Most Comprehensive Serial Data Analysis

WaveRunner 6 Zi offers the most tools for serial data analysis. With over 17 trigger, decode, and compliance solutions, WaveRunner 6 Zi can address problems with unique, powerful views and automated tools. The unique measurement toolset, ProtoSync™, combines the oscilloscope view with a simultaneous view of data link layer decodes on the same instrument.

## Excellent Signal Fidelity

The WaveRunner 6 Zi oscilloscope family features a pristine signal path that offers unmatched signal fidelity with low noise. The WaveRunner HRO offers a 12-bit ADC, resulting in up to 55 dB Signal-to-Noise Ratio (SNR). This performance is augmented by a huge offset and timebase delay adjustment to allow easy signal and amplifier performance assessment and zooming on vertical and horizontal signal characteristics.





# Unbelievable Performance

*The WaveRunner 6 Zi oscilloscope is the most versatile scope in the 400 MHz to 4 GHz class. The performance offered is unmatched, offering deep memory, 40 GS/s sample rate, low noise and fast operation to help get the job done quickly and accurately.*

*The WaveRunner HRO 6Zi defines the best in class noise performance with a 12 bit ADC to provide the best resolution. The HRO 6Zi also features deep memory options up to 256 Mpts/Ch.*

*The toolset provides every necessity for an engineer to validate a design, debug errors at board bring up, and offer powerful analysis to characterize an embedded system. The WaveRunner 6 Zi is the ultimate debug machine.*



## A New Way to Navigate and View

The WavePilot control area provides convenient control of Cursors, Decode, WaveScan,™ History, LabNotebook,™ and Spectrum by their respective function buttons on the front panel.

The SuperKnob is a joystick-like knob in the center of the WavePilot control area used to easily navigate through tables, zoom and position waveforms, and quickly document and annotate your setups.

Simply slide the button on the left side of the display and rotate upwards 90°. The display will automatically change from landscape to portrait mode. The display will also pivot upwards and downwards to optimize viewing angle.



# COMPLETE DEBUG SOLUTION FROM 400 MHz–4 GHz

**WaveRunner 6 Zi combines the power of a fully featured multi-purpose oscilloscope, a dedicated logic analyzer for mixed signal design, and a protocol analyzer for serial data debug.**

1. Industry leading performance—400 MHz–4 GHz, 40 GS/s, 256 Mpts of analysis memory
2. 12.1" Widescreen (16x9) high resolution WXGA color touch screen display
3. 90° rotating and tilting display for optimal viewing of signals
4. Small footprint, only 8.1" deep
5. Easy connectivity with two convenient USB ports on the front, two on the side
6. USBTMC (Test and Measurement Class) port simplifies programming
7. X-Stream™ II streaming architecture 10–100 times faster analysis and better responsiveness than other oscilloscopes

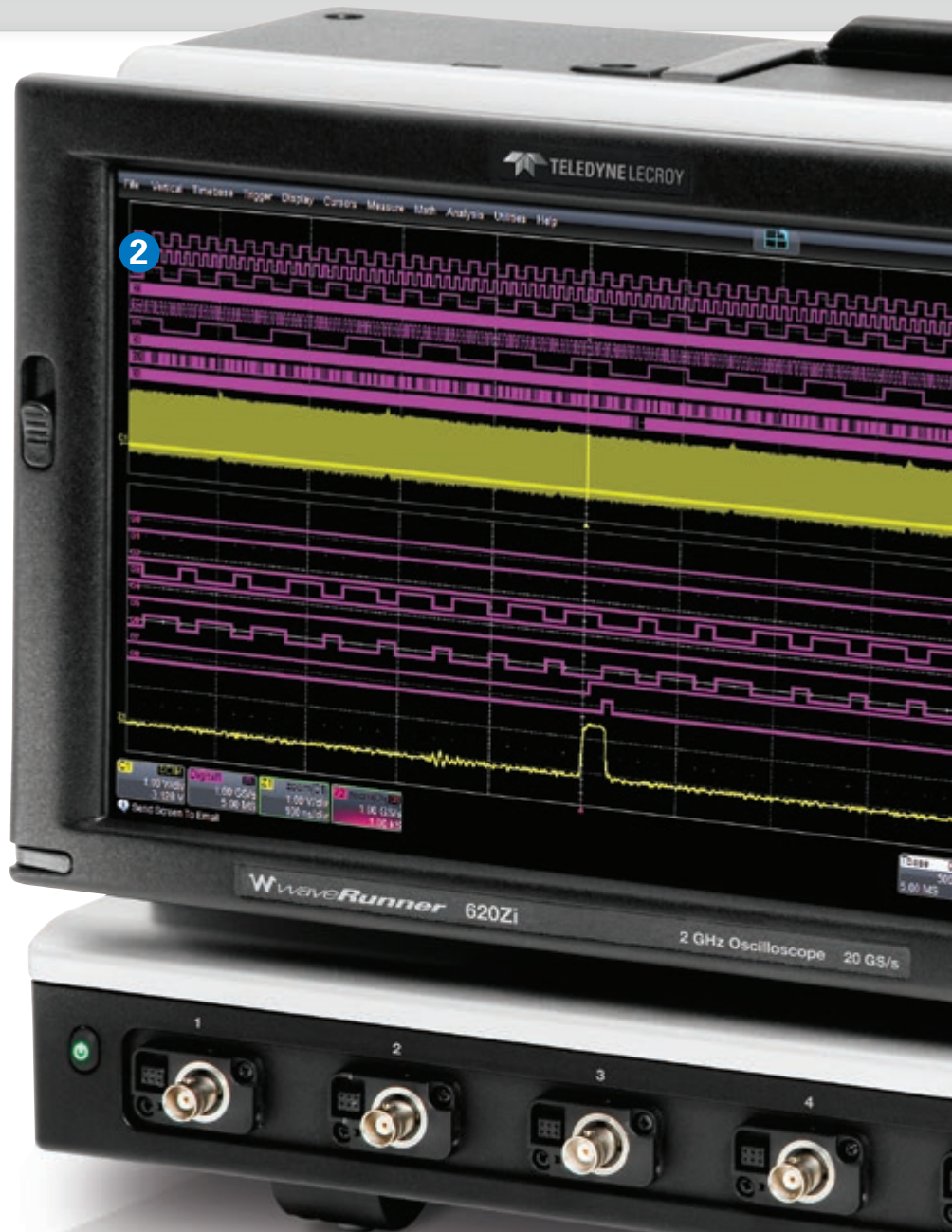

Accessory pouch option available.





- 8. Deepest toolbox with more measurement, more math, more power
- 9. Largest selection of serial triggers and decoders—more than 17—available to provide a total system view
- 10. Serial trigger captures signals up to 3 Gb/s
- 11. WavePilot consolidates important oscilloscope debug features in one place. LEDs illuminate to indicate navigation options and active oscilloscope features
- 12. The SuperKnob provides joystick control to easily navigation to key debug and documentation features
- 13. LBUS provides easy connection to the optional mixed signal feature, providing up to 36 digital channels
- 14. Wide array of probes and accessories to accommodate any probing challenge

4



# 12-BIT HIGH RESOLUTION OSCILLOSCOPE

## Features

- 12-bit ADC resolution
- 400 MHz and 600 MHz models
- 256 Mpts/Ch
- $\pm 0.5\%$  F.S. DC gain accuracy
- 55 dB SNR
- 1 mV vertical Sensitivity @ full bandwidth
- Up to  $\pm 400$  V offset capability
- 20 MHz, 100 MHz, 200 MHz, 350 MHz filters for additional noise filtering

## WaveRunner HRO 6 Zi

The WaveRunner HRO features an industry leading 12-bit Analog to Digital Convertor (ADC), deep memory of 256 Mpts/Ch, and superior DC accuracy specifications. These features are in addition to the extensive analysis features of the WaveRunner 6 Zi. Engineers no longer have to compromise high resolution for deep analysis.

ADC Resolution	Number of Steps	Dynamic Range
8	256	48 dB
12	4096	72 dB

*Resolution refers to the number of levels available.  
Number of levels =  $2^{\text{bits of resolution}}$*

Designed for the medical, automotive, power, and electro-mechanical markets, the WaveRunner HRO has higher resolution and measurement precision than 8-bit alternatives. Traditional oscilloscopes use 8-bit ADCs to digitize the data, which is not enough for many applications that require viewing signals with both a large and small voltage component. The reduced noise and improved resolution of the 12-bit ADC architecture provides finer measurement accuracy and better waveform clarity. This can be seen with the superb 55 dB signal to noise ratio (SNR) and  $\pm 0.5\%$  DC vertical gain accuracy, which is up to four times better than typical 8-bit oscilloscopes.

Full Scale	Smallest Voltage Step	
	8-bits	12-bits
80 V	312.5 mV	19.5 mV
40 V	156.2 mV	9.76 mV
20 V	78.1 mV	4.88 mV
8 V	31.3 mV	1.95 mV
4 V	15.6 mV	976 $\mu$ V
1.6 V	6.3 mV	390 $\mu$ V
800 mV	3.1 mV	195 $\mu$ V
400 mV	1.56 mV	97.6 $\mu$ V
160 mV	625 $\mu$ V	39 $\mu$ V
80 mV	313 $\mu$ V	19.5 $\mu$ V
40 mV	156 $\mu$ V	9.76 $\mu$ V
16 mV	62.5 $\mu$ V	3.9 $\mu$ V
8 mV	31.2 $\mu$ V	1.95 $\mu$ V

## 16 Times More Resolution

12-bits of vertical resolution provides sixteen times more resolution than 8-bits. The 4096 discrete levels reduce the quantization error and improve the voltage accuracy. The difference in accuracy is shown below. The lower resolution waveform shows a higher level of quantization error, while the higher resolution waveform shows a more accurate representation of the actual waveform.

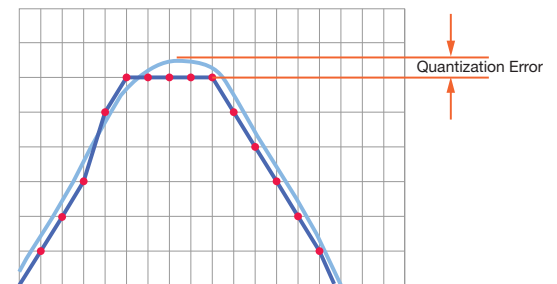

Lower resolution

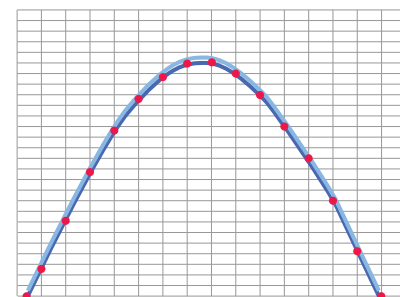

Higher resolution

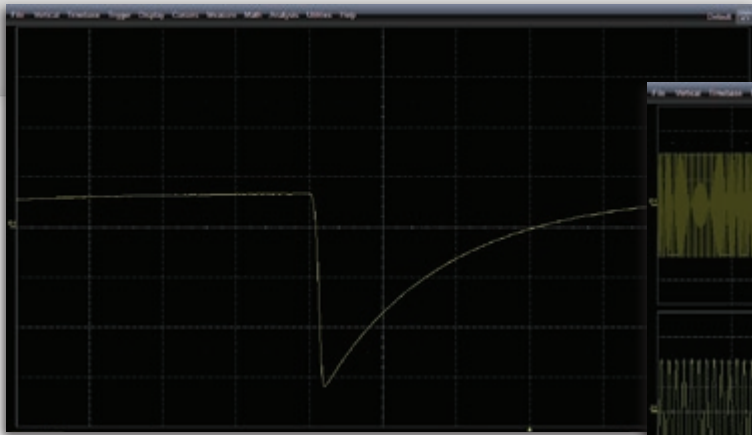

Capture a fast transient signal at the highest sample rate for the best resolution.

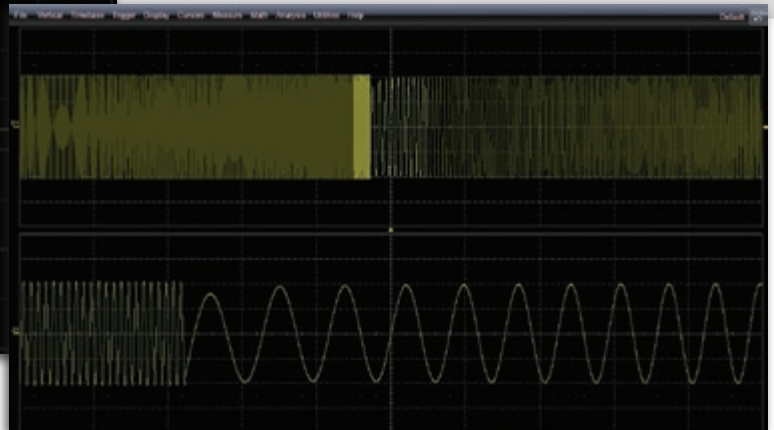

Capture up to 30 seconds of data at sample rates as high as 10 MS/s for trending and searching for events.

### 256 Mpts/Ch Deep Memory

High resolution applications typically require a very long acquisition, capturing up to 30 seconds of data to detect very slow or gradual changes. The 2 GS/s, 256 Mpts/Ch architecture provides the ability to capture a fast transient or a long acquisition.

### 12-bit High Resolution

A common application for high resolution products is the ability to view a small amplitude signal within a larger voltage signal. The 4096 discrete amplitude levels and 55 dB SNR of the WaveRunner HRO 6 Zi can detect much smaller voltage signals with more clarity than an 8-bit oscilloscope.

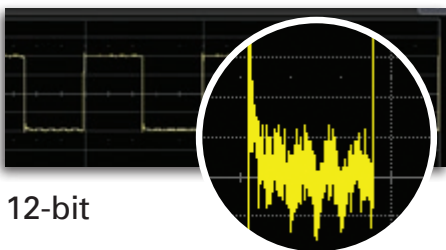

12-bit

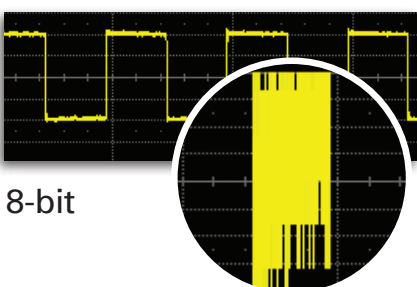

8-bit

### WaveRunner HRO 6 Zi Analysis Tools

Conventional high resolution products have very limited analysis tools, such as FFT, math, measurements, and triggers. The WaveRunner HRO 6 Zi offers a full suite of analysis tools to address the most challenging test needs.

#### Spectrum Analysis

#### 16 Multiple Grids

#### Pass Fail Testing

#### Power Analysis

#### SDA II Serial Data Analysis

#### JitKit Clock Jitter Analysis

#### History Mode

#### Measurement Trigger

#### All Instance Measurements

#### WaveScan

#### Full Customization with XDEV

#### TriggerScan – Rare Event Capture

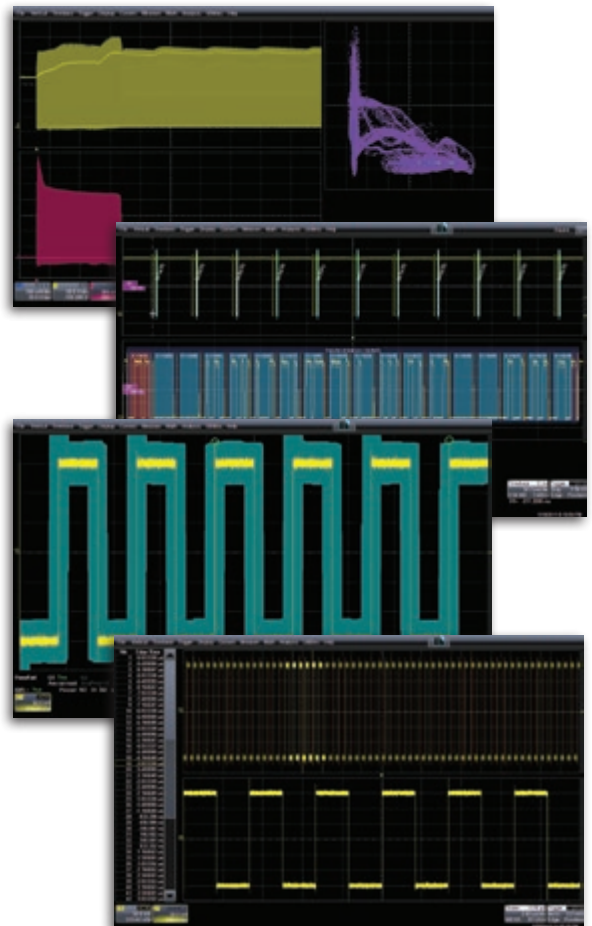



# DEEP INSIGHT TO CLARIFY COMPLEX SIGNALS

## More Trigger Capability Isolates More Problems More Quickly

A powerful combination of high bandwidth edge and 10 different SMART triggers, four stage cascade triggering, measurement trigger, and triggerscan are all standard and allow you to isolate the problem quickly and begin focus on the cause. The measurement trigger offers a powerful option to qualify a trigger event based on a qualified measurement with great resolution. A high-speed serial trigger enables triggering on up to 3 Gb/s serial patterns of up to 80-bits in length. A full range of serial triggers (I<sup>2</sup>C, SPI, UART, RS-232, Audio (I<sup>2</sup>S, LJ, RJ, TDM), CAN, LIN, FlexRay, MIL-STD-1553, SATA, 8b/10b, USB2 and many others) are also available.

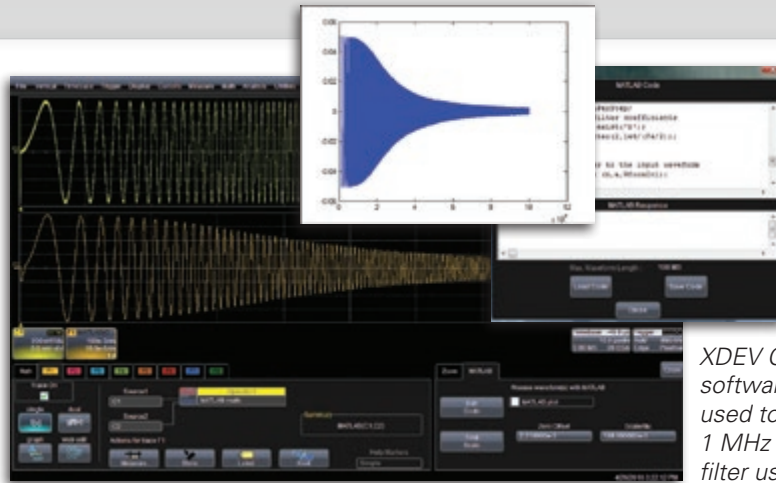
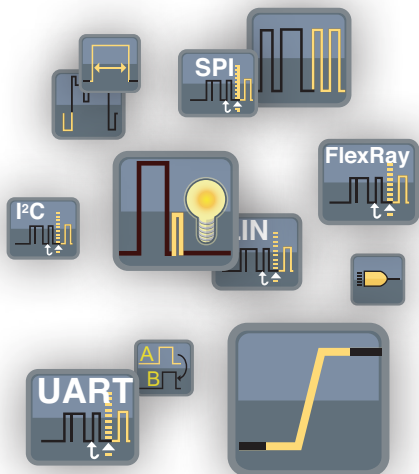

*XDEV Customization software package being used to implement a 1 MHz Butterworth filter using MATLAB.*

## Customized Tools

Only Teledyne LeCroy completely integrates third party programs into the oscilloscope's processing stream by allowing you to create and deploy a new measurement or math algorithm directly into the oscilloscope environment and display the result on the oscilloscope in real-time! Use C/C++, MATLAB®, Excel, JScript (JAVA), and Visual Basic to create your own customized math functions, measurement parameters, or other control algorithms.

## History Mode

History mode lets you scroll back in time to isolate those anomalies, measure them with parameters or cursors, and quickly find the source of the problem. History mode is always buffering waveforms, so no user action is required to save traces, only to invoke the viewer.

## TriggerScan™

TriggerScan uses high-speed hardware triggering capability with persistence displays to capture only the signals of interest and provide answers up to 100 times faster than other methods. Traditional fast display update modes work best on frequent events occurring on slow edge rates while TriggerScan excels in finding infrequent events on fast edge rates.



*A 1 in a billion rare event seems fast but is only 5 seconds of circuit operation on a 200 MHz clock. TriggerScan finds the rare event in 4 minutes while an oscilloscope with 400,000 waveforms/second capture rate misses 99.8% of the signals and could spend nearly 42 minutes to find the error.*

## X-Stream II Architecture

### Optimized for Fast Throughput

X-Stream II architecture enables high throughput of data. X-Stream II uses variable waveform segment lengths to enable all processing intensive calculations to take place in fast CPU cache memory.

Learn More  
[teledynelecroy.com/dl/5213](http://teledynelecroy.com/dl/5213)

### Optimized for Long Memory

X-Stream II has no analysis memory length restrictions, regardless of analysis type, since the variable waveform segment length can always be limited to a size that can fit in CPU cache memory.

### Optimized for Responsiveness

By dynamically allocating buffers to maximize memory availability, the WaveRunner 6 Zi Series embodies the fastest front panel responsiveness.

Learn More  
[teledynelecroy.com/dl/5214](http://teledynelecroy.com/dl/5214)



# DISPLAY OPTIMIZED FOR ANALYSIS

## Graphical Track, Trend, and Histogram Views

Track plots measurement values on the Y-axis and time on the X-axis to display a measurement change time-correlated to the original channel acquisition—perfect for intuitive understanding of behaviors in frequency modulated (FM) or pulse width modulated (PWM) circuits and jitter measurements, including modulation or spikes. Histograms provide a visual distribution representation of a large sample of measurements, allowing faster insight. Trends are ideal for plotting slow changes in measurement values.

## Rotating Display

The 12.1" high resolution WXGA wide screen is designed to provide the best view of any signal type on the display.

The widescreen is ideal for a variety of signals where long records are required and zooming or scrolling results in a large block of data.

Rotate the screen 90° degrees to optimize the display for viewing digital signals, jitter tracks, eye diagrams, and frequency plots. The screen image will adjust automatically when rotated.

Tilt the display up or down in either orientation to minimize reflections or glare.

*View 36 digital traces with the MS500-36 in portrait mode to clarify timing relationships*



*Rotate the display to view harmonic peaks in more detail.*

*Portrait mode shows eye diagrams and jitter histograms in greater detail.*

# A TOTAL SOLUTION FOR SERIAL DATA

The WaveRunner 6 Zi features the most complete serial data solutions. Solving serial data problems requires intimate knowledge of the protocol to get started. With the WaveRunner 6 Zi, the oscilloscope is the expert. Simply connect your probes or cables and the scope can provide correct level of detail needed to view, debug, and analyze the serial data signals.

Solutions address the Embedded, Military and Avionics, Handset/Mobile/ Cellular, and Storage/ Peripherals/Interconnects, with a combination of decode, trigger, measure/ graph, ProtoSync, and compliance tools.

Whether the protocol under test is a new emerging standard requiring jitter end eye diagram testing, a mature standard requiring compliance testing, or an embedded standard requiring protocol and measurement and timing analysis, WaveRunner 6 Zi has it all.



## View

### Decode

Viewing the protocol layer has never been easier with the intuitive color overlay. Advanced software algorithms understand the selected protocol and deconstruct the waveform into protocol information, then overlay the decoded data on the waveform.

### Table

The table feature turns your oscilloscope into a protocol analyzer. Custom configure the Table to display only the information you want, and export table data to an excel file. Touch a message in the table and automatically zoom for detail. This feature is standard with decode options.

### Search

Serial data messages can be quickly located by searching on Address, Data, and other attributes specific to a particular protocol. This feature is standard with decode options.

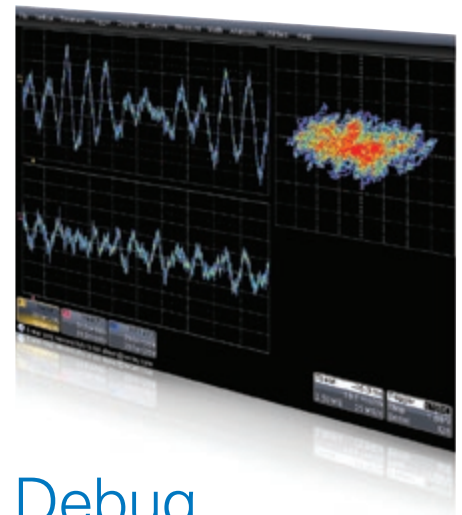

## Debug

### Measure

Timing and bus measurements allow quick and easy characterization of a serial data system. The PROTObus MAG toolkit is the basic building block upon which many other serial trigger and decoder options can be added.

### Graph

Extract data from the serial protocol message stream and use the track functions to graphically plot that data on the display. The digital data is used to create an analog waveform that can then be compared to other electrical signals.

Learn More  
<http://lcry.us/oHoltC>

### True Hardware Protocol Trigger

An 80-bit serial trigger for serial data signals up to 3 Gb/s (including SATA, 8b/10b and USB2.0) and a conditional trigger (I<sup>2</sup>C, SPI, UART, CAN, LIN, FlexRay,<sup>TM</sup> I<sup>2</sup>S, Mil-STD-1553) can completely isolate specific message events.



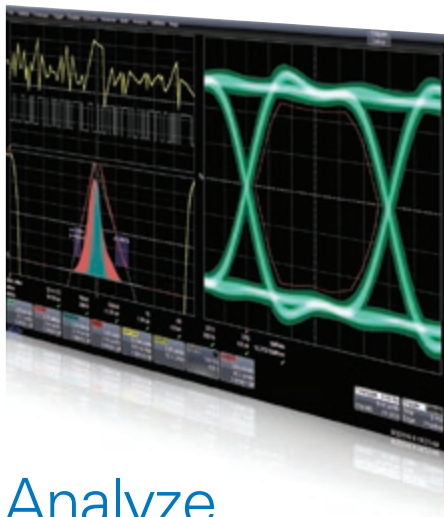

## Analyze

### Eye Diagrams

Create eye diagrams utilizing the full memory for maximum statistical significance. Unique eye diagram features such as IsoBER and eye violation locator provide powerful insight into physical layer analysis.

### Jitter

The integrated clock and jitter analysis tools use advanced jitter decomposition methodologies and tools to provide more information about root cause. TJ analysis, RjBUj analysis and DDj analysis is made simple with the deepest toolset dedicated to

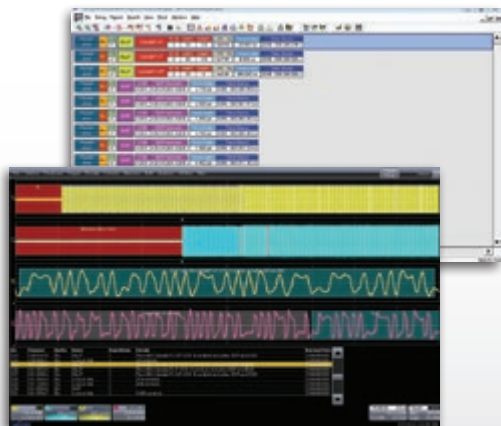

providing the highest level of insight into your serial data signals.

Learn More  
<http://lcry.us/n10mTV>

### Compliance

Automated compliance and testing is simplified with the QPHY software option. QPHY features automated scripts, connection diagrams, and test reports to greatly simplify the compliance process.

Learn More  
[teledynelecroy.com/serialdata](http://teledynelecroy.com/serialdata)

### ProtoSync

ProtoSync combines the oscilloscope view with a simultaneous view of data link layer decodes on the same instrument. This combination makes ProtoSync very effective in debugging PCI Express negotiation rates.

Compatible with PCI Express, USB 2, SAS, SATA, and Fibre Channel.

# WaveRunner 6 Zi Serial Data Protocol Support

	Decode	Trigger	Measure/Graph	ProtoSync	QuaiPHY	
Embedded	I <sup>2</sup> C	•	•	•		
	SPI	•	•	•		
	I <sup>2</sup> S	•	•	•		
	UART, RS-232	•	•	•		
	Automotive	CAN	•	•	•	
		LIN	•	•	•	
		SENT	•		•	
		FlexRay	•	•	•	
		MOST50e/150o				•
	Military & Avionics	ARINC 429	•		•	
MIL-STD-1553		•	•	•		
Handset Cellular Mobile	DigRF 3G	•		•		
	MIPI D-PHY /CSI-2/DSI	•			•	
	MIPI M-PHY	•		•		
Storage / Peripherals Interconnects	DigRF v4	•		•		
	8b/10b	•	•			
	BroadR-Reach				•	
	Fibre Channel	•		•		
	SATA (1.5 & 3 Gb/s)	•	•	•	•	
	SAS (1.5 & 3 Gb/s)	•		•		
	PCI Express (Gen1)	•		•	•	
	USB 2.0	•	•	•	•	
	USB2-HSIC	•				
	Serial Data Composition	LPDDR2				•
DDR2					•	
Ethernet					•	
Manchester		•				
NRZ		•				

# APPLICATION SPECIFIC SOLUTIONS

In addition to the general purpose WaveShape Analysis tools, application specific solutions are available for Serial Data Compliance, Embedded Design, Digital Design, and Automotive. These options extend the Teledyne LeCroy standard measurement and analysis capabilities and expand your oscilloscope's utility as your needs change.

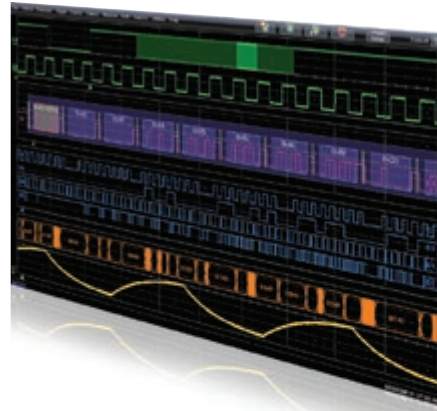

## Digital Filter Software Option (WR6Zi-DFP2)

DFP2 lets you implement Finite or Infinite Impulse Response filters to eliminate undesired spectral components, such as noise, and enhances your ability to examine important signal components. You can choose from a standard set of FIR or IIR filters. You can also design your own filters.

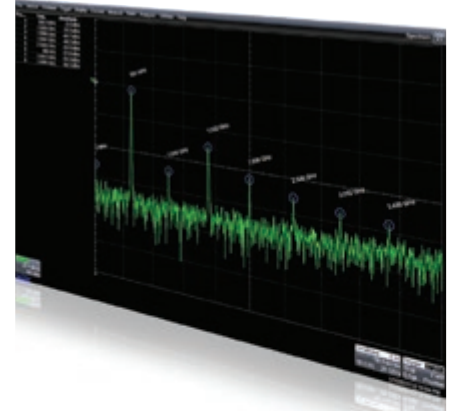

## Spectrum Analyzer Option (WR6Zi-SPECTRUM)

Spectrum analyzer style user interface with controls for start/stop frequency or center frequency and span. Utilize up to 20 markers to automatically identify harmonics and quickly analyze frequency content. Monitor how the spectrum changes over time by viewing the spectrogram in 2D or 3D.

## SDA II – Advanced Tools to Isolate and Analyze Option (WR6Zi-SDAII)

Unleash the power of serial data analysis for understanding and characterizing your design, proving compliance and understanding why a device or host fails

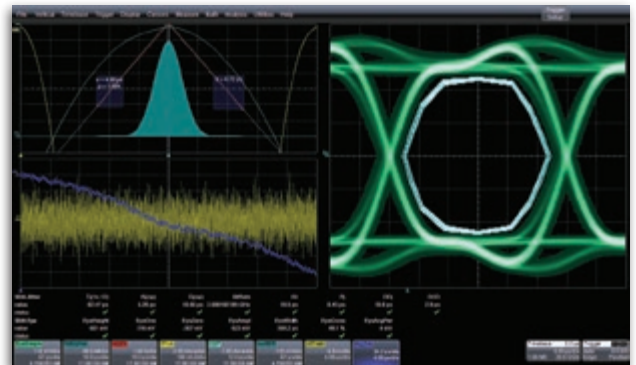

compliance. The X-Stream II architecture provides fast updates and creates eye diagrams 100 times faster than other instruments. Combined with up to 128 Mpts record lengths and more complete jitter decomposition tools, SDA II provides the fastest and most complete understanding of why serial data fails a compliance test. Whether debugging eye pattern or other compliance test failures, the WaveRunner 6 Zi Series rapidly isolates the source of the problem in your design. Advanced jitter decomposition methodologies and tools provide more information about root cause. Tj Analysis, RjBUj Analysis and DDj Analysis is made simple with the deepest toolset dedicated to providing the highest level of insight into your serial data signals.



Before

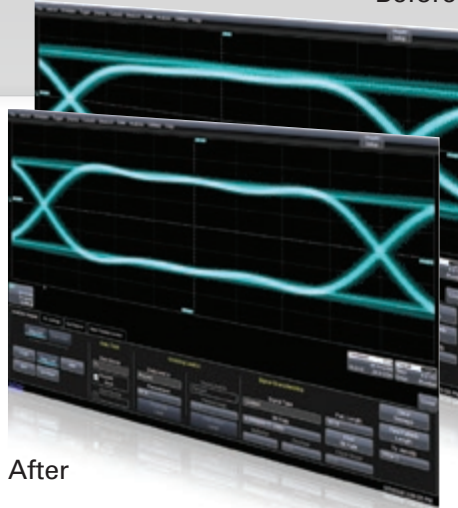
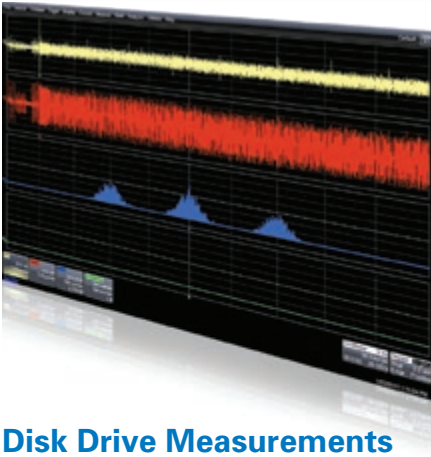

After

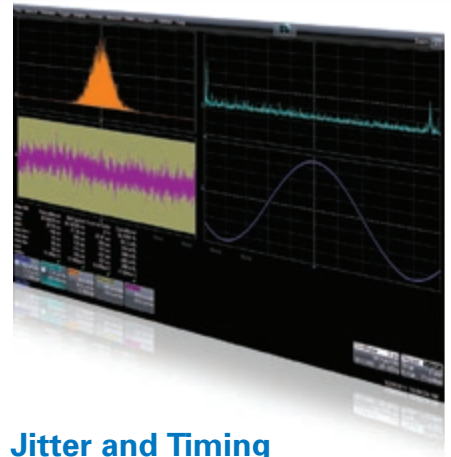

### Disk Drive Measurements Software Option (WR6Zi-DDM2)

DDM2 converts your oscilloscope into a Disk drive analysis machine providing 28 custom measurements. Use the PWxx, amplitude, pulse shape, and ACSN parametric measurement toolset to accelerate design and debug.

### Cable De-Embedding Option (WR6Zi-CBL-DE-EMBED)

Even expensive, high-performance cabling can have an adverse effect on measurements and decrease margin from a design. Cable losses and slow rise times can lead to intersymbol interference causing you to counter these measurement effects. The cable de-embedding feature removes these adverse effects providing more accurate measurements.

### Jitter and Timing Analysis Option (WR6Zi-JITKIT)

JITKIT makes it simple and easy to understand the basic system jitter performance of clock signals and clock-data activities, including period, half period, cycle-cycle, skew, amplitude, differential voltage crossing, slew rate, and a wide variety of other common jitter measurements.

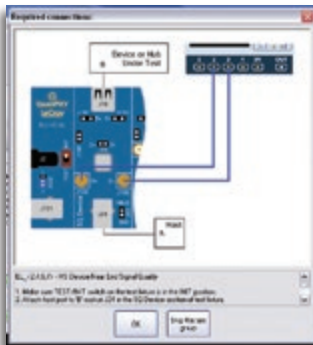

### Serial Data Compliance Option

Teledyne LeCroy's QualiPHY compliance test suite provides the best available solutions to automate, configure and document standardized tests. The QualiPHY compliance test suite provides step-by-step instructions for testing compliance on a wide array of serial data standards. Complete test reporting is also provided.

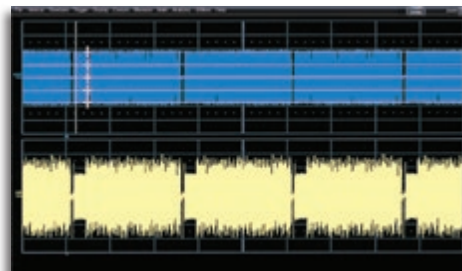

### Disk Drive Analyzer Software Option (WR6Zi-DDA)

DDA enables on button access to all the tools needed to accurately debug and analyze disk drive operation. The DDA user interface and tool set provides specific drive triggers (Sector, Servo gate, Read Gate), and advanced analysis tools (Head filter Equalizer Emulation, Channel Emulation, SAM histograms, and Analog Compare).

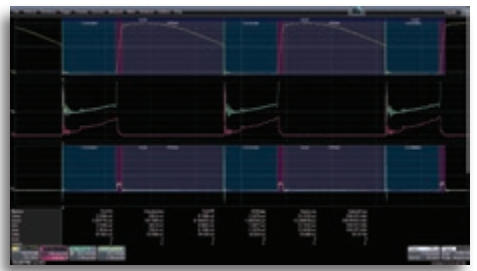

### Power Analyzer Software Option (WR6ZI-PWR)

Quickly measure and analyze operating characteristics of power conversion circuits. Make automatic switching device measurements and identify areas of loss and conduction with color-coded overlay. Control loop modulation analysis and line power harmonic testing are all simplified with a dedicated user interface.

# PROBES

High-performance probes are an essential tool for accurate signal capture. Consequently Teledyne LeCroy offers an extensive range of probes to meet virtually every application need. Optimized for use with Teledyne LeCroy oscilloscopes, these probes set new standards for responsiveness and signal detection.

## WaveLink® Differential Probes (4 GHz– 6 GHz)

D610/D620, D410/D420  
D600A-AT, D300A-AT



WaveLink® probes provide industry leading technology for wideband signal connection to test instruments. The first differential probes to employ SiGe technology, they deliver full system bandwidth when used with WaveRunner, WavePro, WaveMaster, DDA, and SDA oscilloscopes up to 6 GHz.

## Differential Probes (200 MHz– 1.5 GHz)

ZD1500, ZD1000, ZD500,  
ZD200



High bandwidth, excellent common-mode rejection ratio (CMRR) and low noise make these active differential probes ideal for applications such as automotive development (e.g. FlexRay) and failure analysis, as well as wireless and data communication design. The ProBus interface allows sensitivity, offset and common-mode range to be displayed on the oscilloscope screen.

## ZS Series High Impedance Active Probes

ZS2500, ZS1500, ZS1000,  
ZS2500-QUADPAK,  
ZS1500-QUADPAK,  
ZS1000-QUADPAK



The ZS Series probes provide high impedance and an extensive set of probe tips and ground accessories to handle a wide range of probing scenarios. The high 1 M $\Omega$  input resistance and low 0.9 pF input capacitance mean this probe is ideal for all frequencies. The ZS Series probes provide full system bandwidth for all Teledyne LeCroy oscilloscopes having bandwidths of 1 GHz and lower.

## High Voltage Differential Probes

ADP305, ADP300, AP031



Low cost active differential probes are intended for measuring higher voltages. The differential techniques employed permit measurements to be taken at two points in a circuit without reference to the ground, allowing the oscilloscope to be safely grounded without the use of opto-isolators or isolating transformers.

## Current Probes

CP031, CP030, AP015,  
CP150, CP500, DCS015



Teledyne LeCroy current probes reach bandwidths of 100 MHz, peak currents of 700 A and sensitivities of 10 mA/div. Use multiple current probes to make measurements on three-phase systems or a single current probe with a voltage probe to make instantaneous power measurements. Teledyne LeCroy current probes enable the design and testing of switching power supplies, motor drives, electric vehicles, and uninterruptible power supplies.

## High Voltage Passive Probes

PPE1.2KV, PPE20KV,  
PPE2KV, PPE4KV, PPE5KV,  
PPE6KV



The PPE Series includes five fixed-attenuation probes covering a range from 2 kV to 20 kV, and one switchable probe providing  $\div 10/\div 100$  attenuation for voltage inputs up to 1.2 kV. All fixed-attenuation, standard probes automatically rescale compatible Teledyne LeCroy oscilloscopes for the appropriate attenuation of the probe.

## Passive Probes

PP008-1, PP009-1,  
PP007-WR-1, PP007-WS-1,  
PP005A, PP006A,  
PP010-1, PP011-1



Teledyne LeCroy passive probes automatically scale the oscilloscope waveforms without user input. Passive probes are the ideal tool for low frequency signals since circuit loading at these frequencies is minimized. Passive probes are designed to handle voltages of at least 400 V, some as high as 600 V.



# WaveLink Probes

## D410/D420 Differential Probes

The D410/D420 probes boast excellent noise performance that is essential for making precise jitter and other signal integrity measurements. The high DC and midband impedance make them ideal for many serial data and memory applications such as PCI Express, FireWire, and DDR. With  $\pm 4$  volt offset capability and  $\pm 3$  volt common mode control, the WaveLink probes are designed for multi-purpose applications for single-ended needs (such as DDR memory) and serial data applications (such as HDMI).

## D600A-AT Browser

WaveLink browser solutions offer adjustable tip widths and varying form factors and a hand held x-y-z positioner for accurate probe placement.



*The WaveLink Differential Probe Series is a high bandwidth active differential probes series. These probes are suited for signal integrity measurements in high-speed digital systems.*

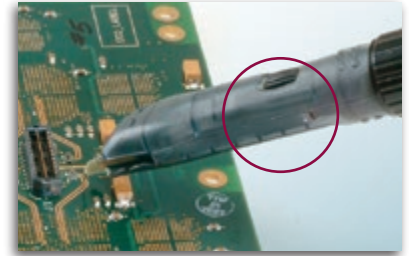

## Five Different Tips for Interconnect Flexibility



### A. Solder-In Lead (SI)

The Solder-In interconnect lead features the smallest physical tip size of any high bandwidth differential probe and the highest level of electrical performance.



### B. Quick Connect (QC) (D6xx only)

The Quick Connect interconnect lead enables you to quickly move the probe between multiple test points on the test circuit.



### C. Square Pin (SP)

Many applications, such as IC characterization boards, use standard 0.025" square pins for interconnect. The Square Pin interconnect lead directly mates with a pair of 0.025" (0.635 mm) square pins that are mounted on standard 0.100" (2.54 mm) centers.



### D. Positioner Tip (PT)

The PT positioner tips provides spring loaded leads to allow for easy probing. The adjustable wheel allows for precise probing, allowing a spread up to 0.14".



### E. High Temperature (HiTemp) Cables and Solder-In Lead

The 90 cm HiTemp cables and Solder-In lead is ideally suited for testing scenarios there the temperature can fluctuate from  $-40^{\circ}\text{C}$  to  $+105^{\circ}\text{C}$ .

# SPECIFICATIONS

	WaveRunner HRO 64 Zi	WaveRunner HRO 66 Zi	WaveRunner 604Zi	WaveRunner 606Zi
<b>Vertical System</b>				
Analog Bandwidth @ 50 Ω (-3 dB)	400 MHz	600 MHz	400 MHz (≥ 2 mV/div)	600 MHz (≥ 2 mV/div)
Analog Bandwidth @ 1 MΩ (-3 dB)	400 MHz (typical)	500 MHz (typical)	400 MHz (typical)	500 MHz (typical)
Rise Time (10–90%, 50 Ω)	875 ps (typical)	625 ps (typical)	875 ps (typical)	580 ps (typical)
Rise Time (20–80%, 50 Ω)	650 ps (typical)	435 ps (typical)	650 ps (typical)	435 ps (typical)
Input Channels	4			
Bandwidth Limiters	20 MHz, 100 MHz, 200 MHz	20 MHz, 100 MHz, 200 MHz, 350 MHz	20 MHz, 200 MHz	20 MHz, 200 MHz
Input Impedance	50 Ω ±2% or 1 MΩ    17pF, 10 MΩ    9.5 pF with supplied Probe			
Input Coupling	1 MΩ: AC, DC, GND; 50 Ω: DC, GND			
Maximum Input Voltage	50 Ω: 5 V <sub>rms</sub> ±10 V peak 1 MΩ: 400 V max. (DC + peak AC < 10 kHz)			
Channel-Channel Isolation	> 300:1		> 100:1 up to rated BW	
Vertical Resolution	12-bits; up to 15-bits with enhanced resolution (ERES)		8-bits; up to 11-bits with enhanced resolution (ERES)	
Sensitivity	50 Ω: 1 mV/div–1 V/div, fully variable 1 MΩ: 1 mV/div–10 V/div, fully variable			
DC Vertical Gain Accuracy (Gain Component of DC Accuracy)	±(0.5%) F.S, offset at 0 V		±1% F.S. (typical), offset at 0 V; ±1.5% F.S. (test limit), offset at 0 V	
Offset Range	<b>50 Ω:</b> ±1.6 V @ 1 mV–4.95 mV ±4 V @ 5 mV–9.9 mV ±8 V @ 10 mV–19.8 mV ±10 V @ 20 mV–1 V <b>1 MΩ:</b> ±1.6 V @ 1 mV–4.95 mV ±4 V @ 5 mV–9.9 mV ±8 V @ 10 mV–19.8 mV ±16 V @ 20 mV–100 mV ±80 V @ 102 mV–198 mV ±160 V @ 200 mV–1 V ±400 V @ 1.02 V–10 V		<b>50 Ω:</b> ±1.6 V @ 1 mV–4.95 mV ±4 V @ 5 mV–9.9 mV ±8 V @ 10 mV–19.8 mV ±10 V @ 20 mV–1 V <b>1 MΩ:</b> ±1.6 V @ 1 mV–4.95 mV ±4 V @ 5 mV–9.9 mV ±8 V @ 10 mV–19.8 mV ±16 V @ 20 mV–140 mV ±80 V @ 142 mV–1.4 V ±160 V @ 1.42 V–10 V	
DC Vertical Offset Accuracy	±(1% of offset setting + 0.2% F.S. + 0.02% max offset + 1 mV)		±(1.5% of offset setting + 1% of full scale + 1 mV) (test limit)	

## Horizontal System

Timebases	Internal timebase common to 4 input channels; an external clock may be applied at the auxiliary input			
Time/Division Range	20 ps/div - 12.8 ks/div with standard memory (up to 25.6 ks/div with -L memory, 51.2 ks/div with -XL memory) RIS available at ≤ 10 ns/div; Roll Mode available at ≥ 100 ms/div and ≤ 5 MS/s.		20 ps/div - 1.6 ks/div with standard memory (up to 3.2 ks/div with -S memory, 6.4 ks/div with -M memory) RIS available at ≤ 10 ns/div; Roll Mode available at ≥ 100 ms/div and ≤ 5 MS/s	
Clock Accuracy	≤ 1.5 ppm +(aging of 1.0 ppm/yr from last calibration)			
Trigger and Interpolator Jitter	≤ 6 ps <sub>rms</sub> (typical) < 1.0 ps <sub>rms</sub> (typical, software assisted)	≤ 5.5 ps <sub>rms</sub> (typical) < 1.0 ps <sub>rms</sub> (typical, software assisted)	≤ 4.5 ps <sub>rms</sub> (typical) < 0.1 ps <sub>rms</sub> (typical, software assisted)	≤ 4 ps <sub>rms</sub> (typical) < 0.1 ps <sub>rms</sub> (typical, software assisted)
Channel-Channel Deskew Range	±9 x time/div. setting, 100 ms max., each channel			
External Timebase Reference (Input)	10 MHz ±25 ppm via optional LBUS BNC adapter			
External Timebase Reference (Output)	10 MHz 3.5 dBm ±1 dBm, synchronized to reference being used by user (internal or external reference) via optional LBUS BNC adaptor			
External Clock	DC to 100 MHz; (50 Ω/1 MΩ), Ext. BNC input, Minimum rise time and amplitude requirements apply at low frequencies			



# SPECIFICATIONS

	WaveRunner 610Zi	WaveRunner 620Zi	WaveRunner 625Zi	WaveRunner 640Zi
<b>Vertical System</b>				
Analog Bandwidth @ 50 $\Omega$ (-3 dB)	1 GHz ( $\geq 2$ mV/div)	2 GHz ( $\geq 5$ mV/div)	2.5 GHz ( $\geq 5$ mV/div)	4 GHz ( $\geq 5$ mV/div)
Analog Bandwidth @ 1 M $\Omega$ (-3 dB)	500 MHz (typical)	500 MHz (typical)	500 MHz (typical)	500 MHz (typical)
Rise Time (10–90%, 50 $\Omega$ )	375 ps (typical)	175 ps (typical)	160 ps (typical)	100 ps (typical)
Rise Time (20–80%, 50 $\Omega$ )	280 ps (typical)	130 ps (typical)	120 ps (typical)	75 ps (typical)
Input Channels	4			
Bandwidth Limiters	20 MHz, 200 MHz	20 MHz, 200 MHz, 1 GHz	20 MHz, 200 MHz, 1 GHz	20 MHz, 200 MHz, 1 GHz
Input Impedance	50 $\Omega$ $\pm$ 2% or 1 M $\Omega$    17pF, 10 M $\Omega$    9.5 pF with supplied Probe			
Input Coupling	1 M $\Omega$ : AC, DC, GND; 50 $\Omega$ : DC, GND			
Maximum Input Voltage	50 $\Omega$ : 5 V <sub>rms</sub> $\pm$ 10 V peak 1 M $\Omega$ : 400 V max. (DC + peak AC < 10 kHz)			
Channel-Channel Isolation	> 100:1 up to rated BW			> 100:1 up to 2.5 GHz > 30:1 from 2.5 GHz to rated BW
Vertical Resolution	8-bits; up to 11-bits with enhanced resolution (ERES)			
Sensitivity	50 $\Omega$ : 1 mV/div–1 V/div, fully variable 1 M $\Omega$ : 1 mV/div–10 V/div, fully variable			
DC Vertical Gain Accuracy (Gain Component of DC Accuracy)	$\pm$ 1% F.S. (typical), offset at 0 V; $\pm$ 1.5% F.S. (test limit), offset at 0 V			
Offset Range	<b>50 <math>\Omega</math>:</b> $\pm$ 1.6 V @ 1 mV–4.95 mV $\pm$ 4 V @ 5 mV–9.9 mV $\pm$ 8 V @ 10 mV–19.8 mV $\pm$ 10 V @ 20 mV–1 V <b>1 M<math>\Omega</math>:</b> $\pm$ 1.6 V @ 1 mV–4.95 mV $\pm$ 4 V @ 5 mV–9.9 mV $\pm$ 8 V @ 10 mV–19.8 mV $\pm$ 16 V @ 20 mV–140 mV $\pm$ 80 V @ 142 mV–1.4 V $\pm$ 160 V @ 1.42 V–10 V		<b>50 <math>\Omega</math>:</b> <b>BWL <math>\leq</math> 1 GHz</b> $\pm$ 1.6 V @ 1 mV–4.95 mV $\pm$ 4 V @ 5 mV–9.9 mV $\pm$ 8 V @ 10 mV–19.8 mV $\pm$ 10 V @ 20 mV–1 V <b>BWL &gt; 1 GHz</b> $\pm$ 1.4 V @ 5 mV–122 mV/div $\pm$ 10 V @ 124 mV–1 V/div <b>1 M<math>\Omega</math>:</b> $\pm$ 1.6 V @ 1 mV–4.95 mV $\pm$ 4 V @ 5 mV–9.9 mV $\pm$ 8 V @ 10 mV–19.8 mV $\pm$ 16 V @ 20 mV–140 mV $\pm$ 80 V @ 142 mV–1.4 V $\pm$ 160 V @ 1.42 V–10 V	
DC Vertical Offset Accuracy	$\pm$ (1.5% of offset setting + 1% of full scale + 1 mV) (test limit)			

## Horizontal System

Timebases	Internal timebase common to 4 input channels; an external clock may be applied at the auxiliary input			
Time/Division Range	20 ps/div - 1.6 ks/div with standard memory (up to 3.2 ks/div with -S memory, 6.4 ks/div with -M memory) RIS available at $\leq 10$ ns/div; Roll Mode available at $\geq 100$ ms/div and $\leq 5$ MS/s			
Clock Accuracy	$\leq 1.5$ ppm +(aging of 1.0 ppm/yr from last calibration)			
Trigger and Interpolator Jitter	$\leq 3.5$ ps <sub>rms</sub> (typical) < 0.1 ps <sub>rms</sub> (typical, software assisted)	$\leq 3$ ps <sub>rms</sub> (typical) < 0.1 ps <sub>rms</sub> (typical, software assisted)	$\leq 2.5$ ps <sub>rms</sub> (typical) < 0.1 ps <sub>rms</sub> (typical, software assisted)	$\leq 2$ ps <sub>rms</sub> (typical) < 0.1 ps <sub>rms</sub> (typical, software assisted)
Channel-Channel Deskew Range	$\pm 9$ x time/div. setting, 100 ms max., each channel			
External Timebase Reference (Input)	10 MHz $\pm$ 25 ppm via optional LBUS BNC adapter			
External Timebase Reference (Output)	10 MHz 3.5 dBm $\pm$ 1 dBm, synchronized to reference being used by user (internal or external reference) via optional LBUS BNC adaptor			
External Clock	DC to 100 MHz; (50 $\Omega$ /1 M $\Omega$ ), Ext. BNC input, Minimum rise time and amplitude requirements apply at low frequencies			

# SPECIFICATIONS

	WaveRunner HRO 64 Zi	WaveRunner HRO 66 Zi	WaveRunner 604Zi	WaveRunner 606Zi
<b>Acquisition System</b>				
Single-Shot Sample Rate/Ch	2 GS/s on 4 Ch		10 GS/s on 4 Ch 20 GS/s on 2 Ch	
Random Interleaved Sampling (RIS)	100 GS/s, user selectable for repetitive signals (20 ps/div to 10 ns/div)		200 GS/s, user selectable for repetitive signals (20 ps/div to 10 ns/div)	
Maximum Trigger Rate	500,000 waveforms/second (in Sequence Mode, up to 4 channels)		1,000,000 waveforms/second (in Sequence Mode, up to 4 channels)	
Intersegment Time	2 $\mu$ s		1 $\mu$ s	
Max. Acquisition Memory Points/Ch	L-128 Option: 128M XL-256 Option: 256M		S-32 Option: 32M / 64M / 64M M-64 Option: 64M / 128M / 128M	
Standard Memory (4 Ch / 2 Ch / 1 Ch) (Number of Segments)	64M (30,000)		16M / 32M / 32M (5,000)	
Memory Options (4 Ch / 2 Ch / 1 Ch) (Number of Segments)	L-128 Option: 128M (60,000) XL-256 Option: 256M (65,000)		S-32 Option: 32M / 64M / 64M (15,000) M-64 Option: 64M / 128M / 128M (15,000)	

## Acquisition Processing

Averaging	Summed averaging to 1 million sweeps; continuous averaging to 1 million sweeps			
Enhanced Resolution (ERES)	From 12.5- to 15-bits vertical resolution		From 8.5- to 11-bits vertical resolution	
Envelope (Extrema)	Envelope, floor, or roof for up to 1 million sweeps			
Interpolation	Linear or Sin x/x			

## Triggering System

Modes	Normal, Auto, Single, and Stop			
Sources	Any input channel, Ext, Ext/10, or line; slope and level unique to each source (except line trigger)			
Coupling Mode	DC, AC, HFRej, LFRej			
Pre-trigger Delay	0 - 100% of memory size (adjustable in 1% increments or 100 ns)			
Post-trigger Delay	0 - 10,000 divisions in real time mode, limited at slower time/div settings or in roll mode			
Hold-off by Time or Events	From 2 ns up to 20 s or from 1 to 99,999,999 events			
Internal Trigger Range	$\pm 4.1$ div from center (typical)			
Trigger Sensitivity with Edge Trigger (Ch 1-4)	2 div @ < 400 MHz 1.5 div @ < 200 MHz 0.9 div @ < 10 MHz (DC, AC, and LFRej coupling)	2 div @ < 600 MHz 1.5 div @ < 300 MHz 1 div @ < 200 MHz 0.9 div @ < 10 MHz (DC, AC, and LFRej coupling)	2 div @ < 400 MHz 1.5 div @ < 200 MHz 0.9 div @ < 10 MHz (DC, AC, and LFRej coupling)	2 div @ < 600 MHz 1.5 div @ < 300 MHz 1 div @ < 200 MHz 0.9 div @ < 10 MHz (DC, AC, and LFRej coupling)
External Trigger Sensitivity, (Edge Trigger)	2 div @ < 600 MHz 1.5 div @ < 300 MHz 1 div @ < 200 MHz 0.9 div @ < 10 MHz (DC, AC, and LFRej coupling)		2 div @ 1 GHz 1.5 div @ < 500 MHz 1 div @ < 200 MHz 0.9 div @ < 10 MHz (DC, AC, and LFRej coupling)	
Max. Trigger Frequency, SMART Trigger	400 MHz @ $\geq$ 10 mV/div 1.9 ns (minimum triggerable width 1.9 ns)	600 MHz @ $\geq$ 10 mV/div 1.2 ns (minimum triggerable width 1.2 ns)	400 MHz @ $\geq$ 10 mV/div 1.9 ns (minimum triggerable width 1.9 ns)	600 MHz @ $\geq$ 10 mV/div 1.2 ns (minimum triggerable width 1.2 ns)
External Trigger Input Range	Ext ( $\pm 0.4$ V); Ext/10 ( $\pm 4$ V)			

## Basic Triggers

Edge	Triggers when signal meets slope (positive, negative, or either) and level condition
Window	Triggers when signal exits a window defined by adjustable thresholds
TV-Composite Video	Triggers NTSC or PAL with selectable line and field; HDTV (720p, 1080i, 1080p) with selectable frame rate (50 or 60 Hz) and Line; or CUSTOM with selectable Fields (1-8), Lines (up to 2000), Frame Rates (25, 30, 50, or 60 Hz), Interlacing (1:1, 2:1, 4:1, 8:1), or Synch Pulse Slope (Positive or Negative)

# SPECIFICATIONS

	WaveRunner 610Zi	WaveRunner 620Zi	WaveRunner 625Zi	WaveRunner 640Zi
<b>Acquisition System</b>				
Single-Shot Sample Rate/Ch	10 GS/s on 4 Ch 20 GS/s on 2 Ch		20 GS/s on 4 Ch 40 GS/s on 2 Ch	
Random Interleaved Sampling (RIS)	200 GS/s, user selectable for repetitive signals (20 ps/div to 10 ns/div)			
Maximum Trigger Rate	1,000,000 waveforms/second (in Sequence Mode, up to 4 channels)			
Intersegment Time	1 $\mu$ s			
Max. Acquisition Memory Points/Ch	S-32 Option: 32M / 64M / 64M M-64 Option: 64M / 128M / 128M			
Standard Memory (4 Ch / 2 Ch / 1 Ch) (Number of Segments)	16M / 32M / 32M (5,000)			
Memory Options (4 Ch / 2 Ch / 1 Ch) (Number of Segments)	S-32 Option: 32M / 64M / 64M (15,000) M-64 Option: 64M / 128M / 128M (15,000)			
<b>Acquisition Processing</b>				
Averaging	Summed averaging to 1 million sweeps; continuous averaging to 1 million sweeps			
Enhanced Resolution (ERES)	From 8.5- to 11-bits vertical resolution			
Envelope (Extrema)	Envelope, floor, or roof for up to 1 million sweeps			
Interpolation	Linear or Sin x/x or cubic (using math tool)			
<b>Triggering System</b>				
Modes	Normal, Auto, Single, and Stop			
Sources	Any input channel, Ext, Ext/10, or line; slope and level unique to each source (except line trigger)			
Coupling Mode	DC, AC, HFRej, LFRej			
Pre-trigger Delay	0 - 100% of memory size (adjustable in 1% increments or 100 ns)			
Post-trigger Delay	0 - 10,000 divisions in real time mode, limited at slower time/div settings or in roll mode			
Hold-off by Time or Events	From 2 ns up to 20 s or from 1 to 99,999,999 events			
Internal Trigger Range	$\pm$ 4.1 div from center (typical)			
Trigger Sensitivity with Edge Trigger (Ch 1–4) ProBus Inputs	2 div @ < 1 GHz 1.5 div @ < 500 MHz 1 div @ < 200 MHz 0.9 div @ < 10 MHz (DC, AC, and LFRej coupling)	2 div @ < 2 GHz 1.5 div @ < 1 GHz 1 div @ < 200 MHz 0.9 div @ < 10 MHz (DC, AC, and LFRej coupling)	2 div @ < 2.5 GHz 1.5 div @ < 1.25 GHz 1 div @ < 200 MHz 0.9 div @ < 10 MHz (DC, AC, and LFRej coupling)	2 div @ < 4 GHz 1.5 div @ < 2 GHz 1 div @ < 200 MHz 0.9 div @ < 10 MHz (DC, AC, and LFRej coupling)
External Trigger Sensitivity, (Edge Trigger)	2 div @ 1 GHz 1.5 div @ < 500 MHz 1 div @ < 200 MHz 0.9 div @ < 10 MHz (DC, AC, and LFRej coupling)			
Max. Trigger Frequency, SMART Trigger	1.0 GHz @ $\geq$ 10 mV/div (minimum triggerable width 750 ps)	2.0 GHz @ $\geq$ 10 mV/div (minimum triggerable width 400 ps)	2.0 GHz @ $\geq$ 10 mV/div (minimum triggerable width 300 ps)	2.0 GHz @ $\geq$ 10 mV/div (minimum triggerable width 200 ps)
External Trigger Input Range	Ext ( $\pm$ 0.4 V); Ext/10 ( $\pm$ 4 V)			
<b>Basic Triggers</b>				
Edge	Triggers when signal meets slope (positive, negative, or either) and level condition			
Window	Triggers when signal exits a window defined by adjustable thresholds			
TV-Composite Video	Triggers NTSC or PAL with selectable line and field; HDTV (720p, 1080i, 1080p) with selectable frame rate (50 or 60 Hz) and Line; or CUSTOM with selectable Fields (1–8), Lines (up to 2000), Frame Rates (25, 30, 50, or 60 Hz), Interlacing (1:1, 2:1, 4:1, 8:1), or Synch Pulse Slope (Positive or Negative)			



# SPECIFICATIONS

**WaveRunner**  
**HRO 64 Zi**  
**HRO 66 Zi**

**WaveRunner**  
**604 Zi**  
**606 Zi**

**WaveRunner**  
**610 Zi**  
**620 Zi**

**WaveRunner**  
**625 Zi**  
**640 Zi**

## SMART Triggers

State or Edge Qualified	Triggers on any input source only if a defined state or edge occurred on another input source. Delay between sources is selectable by time or events
Qualified First	In Sequence acquisition mode, triggers repeatably on event B only if a defined pattern, state, or edge (event A) is satisfied in the first segment of the acquisition. Holdoff between sources is selectable by time or events
Dropout	Triggers if signal drops out for longer than selected time between 1 ns and 20 s
Pattern	Logic combination (AND, NAND, OR, NOR) of 5 inputs (4 channels and external trigger input. Each source can be high, low, or don't care. The High and Low level can be selected independently. Triggers at start or end of the pattern

## SMART Triggers with Exclusion Technology

Glitch	Triggers on positive or negative glitches with widths selectable as low as 200 ps (depending on oscilloscope bandwidth) to 20 s, or on intermittent faults
Width (Signal or Pattern)	Triggers on positive or negative glitches with widths selectable as low as 200 ps (depending on oscilloscope bandwidth) to 20 s, or on intermittent faults
Interval (Signal or Pattern)	Triggers on intervals selectable between 1 ns and 20 s
Timeout (State/Edge Qualified)	Triggers on any source if a given state (or transition edge) has occurred on another source. Delay between sources is 1 ns to 20 s, or 1 to 99,999,999 events
Runt	Trigger on positive or negative runts defined by two voltage limits and two time limits. Select between 1 ns and 20 ns
Slew Rate	Trigger on edge rates. Select limits for dV, dt, and slope. Select edge limits between 1 ns and 20 ns
Exclusion Triggering	Trigger on intermittent faults by specifying the expected behavior and triggering when that condition is not met

## Measurement Trigger

Trigger on measurement values, Edge, Serial Pattern, Bus Pattern, Non-monotonic

## Cascade (Sequence) Triggering

Capability	Arm on "A" event, then Trigger on "B" event. Or Arm on "A" event, then Qualify on "B" event, and Trigger on "C" event. Or Arm on "A" event, then Qualify on "B" then "C" event, and Trigger on "D" event
Types	A, B, C, or D event: Edge, Glitch, Width, Window, Dropout, Interval, Runt, Slew Rate, or Pattern (analog), Measurement Trigger
Holdoff	Holdoff between A and B, B and C, C or D, or any is selectable by time or number of events
Reset	Reset between A and B, B and C, C and D, or any combination is selectable in time or number of events

## Optional High-speed Serial Protocol Triggering (WR6Zi-80B-8B10B TD)

Data Rates	N/A	150 Mb/s–3 Gb/s
Pattern Length	N/A	80-bits, NRZ or 8b/10b
Clock and Data Outputs	N/A	Not available
Clock Recovery Jitter	N/A	$1 \text{ ps}_{\text{rms}} + 0.3\%$ Unit Interval RMS for PRBS data patterns with 50% transition density
Hardware Clock Recovery Loop BW	N/A	PLL Loop BW = Fbaud/5500, 100 Mb/s to 2.488 Gb/s (typical)

## Color Waveform Display

Type	Color 12.1" widescreen flat panel TFT-Active Matrix with high resolution touch screen
Resolution	WXGA; 1280 x 800 pixels
Number of Traces	Display a maximum of 16 traces. Simultaneously display channel, zoom, memory and math traces
Grid Styles	Auto, Single, Dual, Quad, Octal, X-Y, Single+X-Y, Dual+X-Y
Waveform Representation	Sample dots joined, or sample dots only

# SPECIFICATIONS

## WaveRunner HRO 64 Zi HRO 66 Zi

## WaveRunner 604 Zi 606 Zi

## WaveRunner 610 Zi 620 Zi

## WaveRunner 625 Zi 640 Zi

### Processor/CPU

Type	Intel® E5300 Pentium Dual Core 2.6 GHz or greater		
Processor Memory	4 GB standard	2 GB standard, up to 4 GB optional	
Operating System	Microsoft Windows® 7 Professional for Embedded Systems, 64-bit		
Real Time Clock	Date and time displayed with waveform in hardcopy files. SNTP support to synchronize to precision internal clocks		

### Interface

Remote Control	Via Windows Automation, or via Teledyne LeCroy Remote Command Set		
Network Communication Standard	VXI-11 or VICP, LXI Class C (v1.2) Compliant		
GPIB Port (Optional)	Supports IEEE—488.2 (External)		
Ethernet Port	Supports 10/100/1000Base-T Ethernet interface (RJ45 port)		
USB	Minimum 4 total (Including 2 front panel) USB 2.0 ports support Windows compatible devices		
USB Device Port	1 USBTMC Port		
External Monitor Port	15-pin D-Type SVGA compatible DB-15 to support customer-supplied external monitor. Includes support for extended desktop operation with WXGA resolution on second monitor		
Peripheral Bus	Teledyne LeCroy LBUS standard		

### Power Requirements

Voltage	100–240 VAC ±10% at 45–66 Hz; 100–120 VAC ±10% at 380–420 Hz; Automatic AC Voltage Selection; Installation Category: 300 V CAT II		
Power Consumption (Nominal)	325 W / 325 VA	400 W / 400 VA	
Max Power Consumption	425 W / 425 VA (with all PC peripherals, active probes connected to 4 channels, and MSO active)	500 W / 500 VA (with all PC peripherals, active probes connected to 4 channels, and MSO active)	

### Environmental

Temperature (Operating)	+5 °C to +40 °C		
Temperature (Non-Operating)	–20 °C to +60 °C		
Humidity (Operating)	5% to 80% relative humidity (non-condensing) up to +31 °C Upper limit derates to 50% relative humidity (Non-condensing) at +40 °C		
Humidity (Non-Operating)	5% to 95% relative humidity (non-condensing) as tested per MIL-PRF-28800F		
Altitude (Operating)	Up to 10,000 ft. (3,048 m) at or below +25 °C		
Random Vibration (Operating)	0.31 g <sub>rms</sub> 5 Hz to 500 Hz, 15 minutes in each of three orthogonal axes		
Random Vibration (Non-Operating)	2.4 g <sub>rms</sub> 5 Hz to 500 Hz, 15 minutes in each of three orthogonal axes		
Functional Shock	30 g <sub>peak</sub> , half sine, 11 ms pulse, 3 shocks (positive and negative) in each of three orthogonal axes, 18 shocks total		

### Physical Dimensions

Dimensions (HWD)	11.6929" H x 16.4567" W x 8.937" D (297 x 418 x 227 mm)		
Weight	25.4 lbs. (11.52 kg)		
Shipping Weight	36 lbs. (16.36 kg)	39 lbs. (17.69 kg)	

### Certifications

CE Compliant, UL and cUL listed; Conforms to EN 61326-1, EN 61010-1, UL 61010-1 2nd edition, and CSA C22.2 No. 61010-1-04

### Warranty and Service

3-year warranty; calibration recommended annually. Optional service programs include extended warranty, upgrades, and calibration services

# SPECIFICATIONS

## Standard

### Math Tools

Display up to 8 math function traces (F1–F8). The easy-to-use graphical interface simplifies setup of up to two operations on each function trace, and function traces can be chained together to perform math-on-math.

absolute value	exp (base e)	log (base 10)
average (summed)	exp (base 10)	product (x)
average (continuous)	fft (power spectrum,	reciprocal
correlation	power average,	rescale (with units)
(two waveforms)	magnitude, phase,	roof
cubic interpolation	up to 128 Mpts)	(sinx)/x
derivative	floor	sparse
deskew (resample)	integral	square
difference (–)	interpolate (cubic,	square root
enhanced resolution	quadratic, sinx/x)	sum (+)
(to 11 bits vertical)	invert (negate)	zoom (identity)
envelope	log (base e)	

### Measure Tools

Display any 8 parameters together with statistics, including their average, high, low, and standard deviations. Histograms provide a fast, dynamic view of parameters and wave shape characteristics. Parameter Math allows addition, subtraction, multiplication, or division of two different parameters.

amplitude	level @ x	rms
area	maximum	std. deviation
base	mean	top
cycles	median	width
data	minimum	median
delay	narrow band phase	phase
Δ delay	narrow band power	time @ minimum (min.)
duty cycle	number of points	time @ maximum (max.)
duration	+ overshoot	Δ time @ level
falltime (90–10%,	– overshoot	Δ time @ level from
80–20%, @ level)	peak-to-peak	trigger
frequency	period	x @ max.
first	risetime (10–90%,	x @ min.
last	20–80%, @ level)	

## Standard (cont'd)

### Pass/Fail Testing

Simultaneously test multiple parameters against selectable parameter limits or pre-defined masks. Pass or fail conditions can initiate actions including document to local or networked files, e-mail the image of the failure, save waveforms, send a pulse out at the front panel auxiliary BNC output, or (with the GPIB option) send a GPIB SRQ.

### Jitter and Timing Analysis

This package provides jitter timing and analysis using time, frequency, and statistical views for common timing parameters, and also includes other useful tools. Includes:

- “Track” graphs of all parameters, no limitation of number
  - Cycle-Cycle Jitter
  - N-Cycle
  - N-Cycle with start selection
  - Frequency @ level
  - Period @ level
  - Half Period
  - Width @ level
  - Time Interval
  - Error @ level
  - Setup
  - Hold
  - Skew
  - Duty Cycle @ level
  - Duty Cycle Error
- Edge @ lv parameter (counts edges)
- Histograms expanded with 19 histogram parameters and up to 2 billion events
- Trend (datalog) of up to 1 million events
- Track graphs of all parameters
- Persistence histogram, persistence trace (mean, range, sigma)

## Software Options

### SDA II Serial Data Analysis Option (WR6ZI-SDAII)

#### Total Jitter

A complete toolset is provided to measure total jitter. Eye Diagrams with millions of UI are quickly calculated from up to 128 Mpts records, and advanced tools may be used on the Eye Diagram to aid analysis. Complete TIE and Total Jitter (Tj) parameters and analysis functions are provided.

- Time Interval Error (TIE) Measurement Parameter, Histogram, Spectrum and Jitter Track
- Total Jitter (Tj) Measurement Parameter, Histogram, Spectrum
- Eye Diagram Display (sliced)
- Eye Diagram IsoBER (lines of constant Bit Error Rate)
- Eye Diagram Mask Violation Locator
- Eye Diagram Measurement Parameters
  - Eye Height
  - One Level
  - Zero Level
  - Eye Amplitude
  - Eye Width
  - Eye Crossing
  - Avg. Power
  - Extinction Ratio
  - Mask hits
  - Mask out
  - Bit Error Rate
  - Slice Width (setting)
- Q-Fit Tail Representation
- Bathtub Curve
- Cumulative Density Function (CDF)
- PLL Track



# SPECIFICATIONS

## Software Options (cont'd)

### SDA II Serial Data Analysis Option (WR6Zi-SDAII) - *continued*

#### Jitter Decomposition Models

Two jitter decomposition methods are provided and simultaneously calculated to provide maximum measurement confidence. Q-Scale, CDF, Bathtub Curve, and all jitter decomposition measurement parameters can be displayed using either method.

- Spectral Method
- NQ-Scale Method

#### Random Jitter (Rj) and Non-Data Dependent Jitter (Rj+BUj)

- Random Jitter (Rj) Measurement Parameter
- Rj+BUj Histogram
- Rj+BUj Spectrum
- Rj+BUj Track

#### Deterministic Jitter (Dj)

- Deterministic Jitter (Dj) Measurement Parameter

#### Data Dependent Jitter (DDj)

- Data Dependent Jitter (DDj) Measurement Parameter
- DDj Histogram
- DDj Plot (by Pattern or N-bit Sequence)

### Power Analyzer Option (WR6Zi-PWR)

Power switching device measurements, control loop modulation analysis, and line power harmonic testing are all simplified with a dedicated user interface and automatic measurements.

#### Device Analysis

- Losses – Automatic measurement of turn-on, turn-off, and conduction losses as well as off-state power, total losses and switching frequency
- Safe Operating Area
- B-H-Hysteresis Curve
- Dynamic On-Resistance
- Dv/dt and di/vt

#### Control Loop Analysis

- Closed loop time-domain – Duty cycle, width, period or frequency

#### Line Power Analysis

- Power – Vrms, Irms, real-power, apparent power, power factor, crest factor
- Harmonics – EN61000-3-2 pre-compliance, Total Harmonic Distortion

#### Measurement Setup

- Controls for Deskew, DC fine adjust, probe integration, device zone identification

### Cable De-embedding Option (WR6Zi-CBL-DE-EMBED)

Removes cable effects from your measurements. Simply enter the S-parameters or attenuation data of the cable(s) then all of the functionality of the WR6Zi can be utilized with cable effects de-embedded.

### 8b/10b Decode and 80-bit High Speed Serial Trigger Option (WR6Zi-80B-8B10B TD)\*

Intuitive, color-coded serial trigger decode with powerful search capability enables captured waveforms to be searched for user-defined sequences of symbols. Multi-lane analysis decodes up to four simultaneously captured lanes. Includes 150 Mb/s to 3.125 Gb/s High-speed 80-bit Serial Pattern Trigger Option

\* Not available on WaveRunner HRO 6Zi models.

## Software Options (cont'd)

### 8b/10b Decode Option (WR6Zi-HRO-80B-8B10B D)

Intuitive, color-coded serial decode with powerful search capability enables captured waveforms to be searched for user-defined sequences of symbols. Multi-lane analysis decodes up to four simultaneously captured lanes.

### Serial Data Mask Option (WR6Zi-SDM)

Create eye diagrams using a comprehensive list of standard eye pattern masks, or create a user-defined mask. Mask violations are clearly marked on the display for easy analysis.

### Electrical Telecom Pulse Mask Test Option (WR6Zi-ET-PMT)

Performs automated compliance mask tests on a wide range of electrical telecom standards.

### Spectrum Analyzer Option (WR6Zi-SPECTRUM)

Spectrum analyzer style user interface and advanced FFT capabilities.

- Automatic oscilloscope setup when selecting start/stop frequency or center frequency and span
- Resolution bandwidth automatically or manually controlled
- FFT Reference and vertical scale in dBm, dBV, dBmV, dBuV, Vrms or Arms
- Spectrogram provides 2D or 3D spectral history display
- Up to 100 automatic peak markers
- Up to 20 markers, either manually controlled or automatic which mark fundamental frequency and harmonics
- Math waveform analysis, additional output types:
  - Power density
  - Real
  - Imaginary
  - Magnitude squared

### Disk Drive Measurements Option (WR6Zi-DDM2)

This package provides disk drive parameter measurements and related mathematical functions for performing disk drive WaveShape Analysis.

- Disk Drive Parameters are as follows:

– amplitude	– local time	– overwrite
– assymetry	– at minimum	– pulse width 50
– local base	– local time	– pulse width 50 –
– local baseline	– at maximum	– pulse width 50 +
– separation	– local time	– resolution
– local maximum	– peak-trough	– track average
– local minimum	– local time	– amplitude
– local number	– over threshold	– track average
– local peak-peak	– local time	– amplitude –
– local time	– trough-peak	– track average
– between events	– local time	– amplitude +
– local time	– under threshold	– auto-correlation s/n
– between peaks	– narrow band phase	– non-linear
– local time	– narrow band power	– transition shift
– between troughs		

# ORDERING INFORMATION

Product Description	Product Code
---------------------	--------------

## WaveRunner 6 Zi Series Oscilloscopes

400 MHz, 2 GS/s, 4 Ch, 64 Mpts/Ch 12-bit DSO with 12.1" WXGA Color Display	WaveRunner HRO 64Zi
600 MHz, 2 GS/s, 4 Ch, 64 Mpts/Ch 12-bit DSO with 12.1" WXGA Color Display	WaveRunner HRO 66Zi
400 MHz, 10 GS/s, 4 Ch, 16 Mpts/Ch DSO with 12.1" WXGA Color Display. 50 Ω and 1 MΩ Input 20 GS/s and 32 Mpts/Ch in Interleaved Mode	WaveRunner 604Zi
600 MHz, 10 GS/s, 4 Ch, 16 Mpts/Ch DSO with 12.1" WXGA Color Display. 50 Ω and 1 MΩ Input 20 GS/s and 32 Mpts/Ch in Interleaved Mode	WaveRunner 606Zi
1 GHz, 10 GS/s, 4 Ch, 16 Mpts/Ch DSO with 12.1" WXGA Color Display. 50 Ω and 1 MΩ Input 20 GS/s and 32 Mpts/Ch in Interleaved Mode	WaveRunner 610Zi
2 GHz, 10 GS/s, 4 Ch, 16 Mpts/Ch DSO with 12.1" WXGA Color Display. 50 Ω and 1 MΩ Input 20 GS/s and 32 Mpts/Ch in Interleaved Mode	WaveRunner 620Zi
2.5 GHz, 20 GS/s, 4 Ch, 16 Mpts/Ch DSO with 12.1" WXGA Color Display. 50 Ω and 1 MΩ Input 40 GS/s and 32 Mpts/Ch in Interleaved Mode	WaveRunner 625Zi
4 GHz, 20 GS/s, 4 Ch, 16 Mpts/Ch DSO with 12.1" WXGA Color Display. 50 Ω and 1 MΩ Input 40 GS/s and 32 Mpts/Ch in Interleaved Mode	WaveRunner 640Zi

## Included with Standard Configuration

÷10, 500 MHz Passive Probe (Qty. 4)
Optical 3-button Wheel Mouse, USB 2.0
Printed Quick Reference Guide
Printed Getting Started Manual
Product Manual in PDF Format on Oscilloscope Desktop
Anti-virus Software (Trial Version)
Microsoft Windows® 7 for Embedded Systems 64-bit License
Commercial NIST Traceable Calibration with Certificate
Power Cable for the Destination Country
3-year Warranty

## Oscilloscope Synchronization

8 Channel Simultaneous Acquisition- Capture and Transfer Waveforms Between Two WR 6Zi or HRO 6Zi Oscilloscopes	WR6ZI-8CH-SYNCH
---	-----------------

Product Description	Product Code
---------------------	--------------

## Memory Options

128 Mpts/Ch Memory. Includes 4 GB of RAM.	WR6Zi-HRO-L-128
256 Mpts/Ch Memory. Includes 4 GB of RAM	WR6Zi-HRO-XL-256
32 Mpts/Ch (64 Mpts/Ch Interleaved) Standard Memory. Includes 4 GB of RAM	WR604Zi-S-32
32 Mpts/Ch (64 Mpts/Ch Interleaved) Standard Memory. Includes 4 GB of RAM	WR606Zi-S-32
32 Mpts/Ch (64 Mpts/Ch Interleaved) Standard Memory. Includes 4 GB of RAM	WR610Zi-S-32
32 Mpts/Ch (64 Mpts/Ch Interleaved) Standard Memory. Includes 4 GB of RAM	WR620Zi-S-32
32 Mpts/Ch (64 Mpts/Ch Interleaved) Standard Memory. Includes 4 GB of RAM	WR625Zi-S-32
32 Mpts/Ch (64 Mpts/Ch Interleaved) Standard Memory. Includes 4 GB of RAM	WR640Zi-S-32
64 Mpts/Ch (128 Mpts/Ch Interleaved) Standard Memory. Includes 4 GB of RAM	WR604Zi-M-64
64 Mpts/Ch (128 Mpts/Ch Interleaved) Standard Memory. Includes 4 GB of RAM	WR606Zi-M-64
64 Mpts/Ch (128 Mpts/Ch Interleaved) Standard Memory. Includes 4 GB of RAM	WR610Zi-M-64
64 Mpts/Ch (128 Mpts/Ch Interleaved) Standard Memory. Includes 4 GB of RAM	WR620Zi-M-64
64 Mpts/Ch (128 Mpts/Ch Interleaved) Standard Memory. Includes 4 GB of RAM	WR625Zi-M-64
64 Mpts/Ch (128 Mpts/Ch Interleaved) Standard Memory. Includes 4 GB of RAM	WR640Zi-M-64

# ORDERING INFORMATION

## Product Description Product Code

### Memory and Sample Rate Options

20 GS/s (40 GS/s Interleaved) Sampling Rate Option	WR610Zi-STD-4x20GS
32 Mpts/Ch (64 Mpts/Ch Interleaved) Standard Memory. Includes 4 GB of RAM. 20 GS/s (40 GS/s Interleaved) Sampling Rate Option	WR610Zi-S-32+4x20GS
64 Mpts/Ch (128 Mpts/Ch Interleaved) Standard Memory. Includes 4 GB of RAM. 20 GS/s (40 GS/s Interleaved) Sampling Rate Option	WR610Zi-M-64+4x20GS
20 GS/s (40 GS/s Interleaved) Sampling Rate Option	WR620Zi-STD-4x20GS
32 Mpts/Ch (64 Mpts/Ch Interleaved) Standard Memory. Includes 4 GB of RAM. 20 GS/s (40 GS/s Interleaved) Sampling Rate Option	WR620Zi-S-32+4x20GS
64 Mpts/Ch (128 Mpts/Ch Interleaved) Standard Memory. Includes 4 GB of RAM. 20 GS/s (40 GS/s Interleaved) Sampling Rate Option	WR620Zi-M-64+4x20GS

### Computer Upgrade

Upgrade From 2 GB RAM to 4 GB RAM	WR6Zi-UPG-4GBRAM
Removable Hard Drive Option	WR6Zi-160GB-RHD
Removable 500 GB Hard Drive Option	WR6Zi-500GB-RHD
Additional 160 GB Hard Drive for Use With RHD Option. Includes Windows 7 Pro for Embedded Systems OS, Teledyne LeCroy Oscilloscope Software and Critical Scope Operational File Duplicates	WR6Zi-160GB-RHD-02
Additional 500 GB Hard Drive for Use With RHD Option. Includes Windows 7 Pro for Embedded Systems OS, Teledyne LeCroy Oscilloscope Software and Critical Scope Operational File Duplicates	WR6Zi-500GB-RHD-02
Upgrade From Standard Size Hard Drive to 500 GB Hard Drive	WR6Zi-500GB-HD

### Serial Trigger and Decode

ARINC 429 Bus Symbolic Decode Option	WR6Zi-ARINCbus DSymbolic
UART and RS-232 Trigger and Decode Option	WR6Zi-UART-RS232bus TD
CANbus TD Trigger and Decode Option	WR6Zi-CANbus TD
CANbus TDM Trigger, Decode and Measure/Graph Option	WR6Zi-CANbus TDM

## Product Description Product Code

### Serial Trigger and Decode (cont'd)

FlexRay Trigger and Decode Option	WR6Zi-FlexRaybus TD
FlexRay Trigger, Decode, and Physical Layer Test Option	WR6Zi-FlexRaybus TDP
SENT Bus Decode Option	WR6Zi-SENT D
LIN Trigger and Decode Option	WR6Zi-LINbus TD
Vehicle Bus Analyzer Package - Includes CANBus TDM, FlexRay TDP, LINBus TD, and ProtoBus MAG	WR6Zi-VBA
8b/10b Trigger and Decode Option	WR6Zi-80B-8B10B TD
MIL-STD-1553 Trigger and Decode Option	WR6Zi-1553 TD
Audiobus Trigger and Decode for I <sup>2</sup> S, Option LJ, RJ, and TDM	WR6Zi-Audiobus TD
Audiobus Trigger, Decode, and Graph Option for I <sup>2</sup> S, LJ, RJ, and TDM	WR6Zi-Audiobus TDG
USB 1.x/2.0 Trigger/Decode Option	WR6Zi-USB2bus TD
USB2-HSIC Trigger and Decode Option	WR6Zi-USB2-HSICbus TD
PCI Express Gen1 Decode Option	WR6Zi-PClebus D
SATA Trigger Decode Annotation Option Supports SATA Gen1, 2, and 3	WR6Zi-SATAbus TD
SAS Decode Annotation Option	WR6Zi-SASbus D
Fibre Channel Decode Annotation Option	WR6Zi-FCbus D
DigRF 3G Decode Option	WR6Zi-DigRF3Gbus D
DigRF v4 Decode Option	WR6Zi-DigRFv4bus D
MIPI D-PHY Decode Option	WR6Zi-DPHYbus D
MIPI D-PHY Decode and Physical Layer Test Option	WR6Zi-DPHYbus DP
MIPI M-PHY Decode Option	WR6Zi-MPHYbus D
MIPI M-PHY Decode and Physical Layer Test Option	WR6Zi-MPHYbus DP
PROTObus MAG Serial Debug Toolkit	WR6Zi-PROTObus MAG
Decode Annotation and Protocol Analyzer Synchronization Software Option	WR6Zi-ProtoSync
I <sup>2</sup> C Bus Trigger and Decode Option	WR6Zi-I2Cbus TD
I <sup>2</sup> C, SPI and UART Trigger and Decode Option	WR6Zi-EMB
SPI Bus Trigger and Decode Option	WR6Zi-SPIbus TD
MS-500-36 with I <sup>2</sup> C, SPI and UART Trigger and Decode Option	WR6Zi-MSO-EMB
ENET Decode Option	WR6Zi-ENETbus D
Manchester Decode Option	WR6Zi-Manchesterbus D
NRZ Decode Option	WR6Zi-NRZbus D



# ORDERING INFORMATION

## Product Description Product Code

### Serial Data Compliance

QualiPHY Enabled Ethernet 10/100/1000BT Software Option	QPHY-ENET*
QualiPHY Enabled USB 2.0 Software Option	QPHY-USB ‡
QualiPHY Enabled SATA Software Option	QPHY-SATA-TSG-RSG
QualiPHY Enabled MIPI D-PHY Software Option	QPHY-MIPI-DPHY
QualiPHY Enabled DDR2 Software Option	QPHY-DDR2
QualiPHY Enabled LPDDR2 Software Option	QPHY-LPDDR2
QualiPHY Enabled MOST150o Software Option	QPHY-MOST150o
QualiPHY Enabled MOST50e Software Option	QPHY-MOST50e
QualiPHY Enabled BroadR-Reach Software Option	QPHY-BroadR-Reach
10/100/1000Base-T Ethernet Test Fixture	TF-ENET-B**
Telecom Adapter Kit 100 Ω Bal., 120 Ω Bal., 75 Ω Unbal.	TF-ET
SATA 1.5 Gb/s, 3.0 Gb/s and 6.0 Gb/s Compliance Test Fixture	TF-SATA-C
USB 2.0 Compliance Test Fixture	TF-USB-B

\* TF-ENET-B required. ‡ TF-USB-B required.

\*\* Includes ENET-2CAB-SMA018 and ENET-2ADA-BNCSMA.

### Serial Data Analysis

Cable De-Embedding Option	WR6Zi-CBL-DE-EMBED
Eye Doctor (Virtual Probe and Equalizer Emulation Bundle), Serial Data Analyzers, and Disk Drive Analyzers	WR6Zi-EYEDRII
Serial Data Mask Software Option	WR6Zi-SDM
SDA II Serial Data Analysis Option	WR6Zi-SDAII

### Mixed Signal Solutions

250 MHz, 1 GS/s, 18 Ch, 10 Mpts/Ch Mixed Signal Oscilloscope Option	MS-250
500 MHz, 2 GS/s, 18 Ch, 50 Mpts/Ch Mixed Signal Oscilloscope Option	MS-500
250 MHz, 1 GS/s, 36 Ch, 25 Mpts/Ch (500 MHz, 18 Ch, 2 GS/s, 50 Mpts/Ch Interleaved) Mixed Signal Oscilloscope Option	MS-500-36

## Product Description Product Code

### Data Storage Software

Disk Drive Measurements Software Option	WR6Zi-DDM2
Disk Drive Analyzer Software Option	WR6Zi-DDA
Advanced Optical Recording Measurement Option	WR6Zi-AORM

### Power Analysis Software

Power Analyzer Software Option	WR6Zi-PWR
--------------------------------	-----------

### Jitter Analysis Software

Clock Jitter Analysis with Four Views Software Option	WR6Zi-JITKIT
---	--------------

### Spectrum Analysis Software

Spectrum Analyzer Option	WR6Zi-SPECTRUM
--------------------------	----------------

### Other Software Options

Advanced Customization Option	WR6Zi-XDEV
EMC Pulse Parameter Software Option	WR6Zi-EMC
Electrical Telecom Mask Test Software Option	WR6Zi-ET-PMT

### Digital Filtering Software

Digital Filter Software Option	WR6Zi-DFP2
--------------------------------	------------

### Remote Control/Network Options

External USB2 to GPIB Adaptor	USB2-GPIB
-------------------------------	-----------

### General Accessories

Oscilloscope Cart with Additional Shelf and Drawer	OC1024
Oscilloscope Cart	OC1021
Accessory Pouch	WR6Zi-POUCH
Rackmount, 8U Adaptor Kit	WR6Zi-RACK
Keyboard, USB	KYBD-1
MIL Calibration Certification	WR6Zi-CCMIL
Soft Carrying Case	WR6Zi-SOFTCASE
Protective Hard Cover	WR6Zi-COVER
Hard Case	WR6Zi-HARDCASE
External Adaptor for Reference In and Out (To be applied at the Lbus Connector)	WR6Zi-ExtRef-IN/OUT

# ORDERING INFORMATION

## Product Description Product Code

### Probes

±10, 500 MHz 10 MΩ Passive Probe	PP009
±10, 500 MHz 10 MΩ Passive Probe	PP008
200 MHz, 3.5 pF, 1 MΩ Active Differential Probe	ZD200
500 MHz, 1.0 pF, 1 MΩ Active Differential Probe	ZD500
1 GHz, 1.0 pF, 1 MΩ Active Differential Probe	ZD1000
1.5 GHz, 1.0 pF, 1 MΩ Active Differential Probe	ZD1500
1 GHz, 0.9 pF, 1 MΩ High Impedance Active Probe	ZS1000
Set of 4 ZS1000, 1 GHz, 0.9 pF, 1 MΩ High Impedance Active Probe	ZS1000-QUADPAK
1.5 GHz, 0.9 pF, 1 MΩ High Impedance Active Probe	ZS1500
Set of 4 ZS1500, 1.5 GHz, 0.9 pF, 1 MΩ High Impedance Active Probe	ZS1500-QUADPAK
2.5 GHz, 0.9 pF, 1 MΩ High Impedance Active Probe	ZS2500
Set of 4 ZS2500, 2.5 GHz, 0.9 pF, 1 MΩ High Impedance Active Probe	ZS2500-QUADPAK
WaveLink 6 GHz Differential Amplifier Module with Adjustable Tip	D600A-AT
WaveLink 3 GHz Differential Amplifier Module with Adjustable Tip	D300A-AT
WaveLink 5 GHz Differential Amplifier Module with Positioner Tip	D500PT
Optical-to-Electrical Converter, 500-870 nm ProBus BNC Connector	OE425
Optical-to-Electrical Converter, 950-1630 nm ProBus BNC Connector	OE455
1,400 V, 20 MHz High-Voltage Differential Probe	ADP300
1,400 V, 100 MHz High-Voltage Differential Probe	ADP305
10:1/100:1 200/300 MHz 50 MΩ High-Voltage Probe 600 V/1.2 kV Max. Volt. DC	PPE1.2KV
100:1 400 MHz 50 MΩ 2 kV High-Voltage Probe	PPE2KV
100:1 400 MHz 50 MΩ 4 kV High-Voltage Probe	PPE4KV
1000:1 400 MHz 50 MΩ 5 kV High-Voltage Probe	PPE5KV

## Product Description Product Code

### Probes (cont'd)

1000:1 400 MHz 5 MΩ / 50 MΩ 6 kV High-Voltage Probe	PPE6KV
1000:1 100 MHz 100MΩ High-Voltage Probe 20 kV Max. Volt. DC + 40 kV Peak AC	PPE20KV
30 A; 50 MHz Current Probe – AC/DC; 30 A <sub>rms</sub> ; 50 A <sub>peak</sub> Pulse	AP015
30 A; 50 MHz Current Probe – AC/DC; 30 A <sub>rms</sub> ; 50 A <sub>peak</sub> Pulse	CP030
30 A; 100 MHz Current Probe – AC/DC; 30 A <sub>rms</sub> ; 50 A <sub>peak</sub> Pulse	CP031
150 A; 10 MHz Current Probe – AC/DC; 150 A <sub>rms</sub> ; 500 A <sub>peak</sub> Pulse	CP150
500 A; 2 MHz Current Probe – AC/DC; 500 A <sub>rms</sub> ; 700 A <sub>peak</sub> Pulse	CP500
700 V, 15 MHz High-Voltage Differential Probe (±10, ±100)	AP031
1 Ch, 100 MHz Differential Amplifier with Precision Voltage Source	DA1855A
DA1855A with Rackmount	DA1855A-RM
2 Ch, 100 MHz Differential Amplifier with Precision Voltage Source	DA1855A-PR2
DA1855A with Rackmount (must be ordered at time of purchase, no retrofit)	DA1855A-PR2-RM
WaveLink 4 GHz, 2.5 Vp-p Differential Probe System	D410-PS
WaveLink 4 GHz, 5 Vp-p Differential Probe System	D420-PS
WaveLink ProBus Platform/Cable Assembly (4 GHz)	WL-PBus-CASE

\* For a complete probe, order a WL-PBUS-CASE Platform/Cable Assembly with the Adjustable Tip Module



1-800-5-LeCroy  
[teledynelecroy.com](http://teledynelecroy.com)

**Local sales offices are located throughout the world.  
Visit our website to find the most convenient location.**

© 2011 by Teledyne LeCroy, Inc. All rights reserved. Specifications, prices, availability, and delivery subject to change without notice.  
Product or brand names are trademarks or requested trademarks of their respective holders.

PCI Express® is a registered trademark and/or service mark of PCI-SIG.

MATLAB® is a registered trademark of The MathWorks, Inc. All other product or brand names are trademarks or requested trademarks of their respective holders.

waverunner6zi-ds-21jun13