



WaveRunner® Xi-A Series

Performance Reimagined
400 MHz to 2 GHz



OUTSTANDING CAPABILITIES FOR EVERYDAY TESTING

LeCroy's "out-of-the-box" thinking about oscilloscopes provides a great form factor and no compromises. It's loaded with capability and features that will provide more insight and help you complete your testing faster.

1. Bright, 10.4" Display

You'll never use a small display oscilloscope again. A fantastic viewing angle makes it easy to view.

2. Only 15 cm (6") Deep

The most space-efficient oscilloscope for your bench from 400 MHz to 2 GHz.

3. Dedicated Cursor Knobs

Select type of cursor, position them on your signal, and read values without ever opening a menu.

4. Zoom Control Knobs

Four dedicated knobs make it easy to navigate any zoom or math trace without opening menus.

5. Touch Screen with Built-in Stylus

The most time-efficient user interface is even easier to use with a built-in stylus.

6. High Impedance Active Probes

1 GHz and 1.5 GHz active probes with 0.9 pF, 1 M Ω input impedance and an extensive probe tip and ground accessory selection.





7. LeCroy WaveStream™ Fast Viewing Mode

Provides a lively, analog-like feel similar to a phosphor trace. Adjust “trace” intensity with the front panel control, or toggle between LeCroy WaveStream and real-time modes.

8. LeCroy WaveScan™ Advanced Search & Analysis

Use more than 20 modes to capture and search, or “scan” for anomalous events over thousands or millions of acquisitions. Use ScanHisto or ScanOverlay to display intuitive scanned results.

9. Serial Triggering & Decoding

I²C SPI, UART, RS-232, AudioBus (I²S, LJ, RJ, TDM), CAN, LIN, FlexRay™ and MIL-STD-1553 serial triggers, available for WaveRunner Xi-A.

10. “Push” Knobs

Trigger level, delay, and offset knobs all provide shortcuts to common actions when pushed.

11. Local Language User Interface

Select from 10 language preferences. Add a front panel overlay with your local language.

COMPLETE CAPABILITY—100% TEST COVERAGE

The LeCroy WaveRunner Xi-A is the most powerful and capable scope available in its class. Basic system validation using advanced triggers, fast viewing modes, measurement parameters, or serial decodes is simple and easy. Advanced debug, multi-domain analysis, and waveshape analysis are possible with tools unique to WaveRunner Xi-A. Optional application packages help you make sense of well-defined problems.

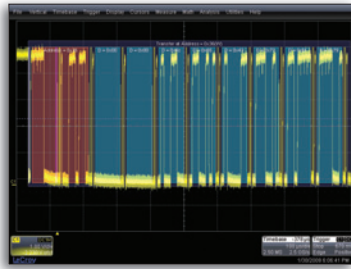

Enhanced Understanding of Serial Data Signals

Trigger on I²C, SPI, UART, RS-232, AudioBus (I²S, LJ, RJ, TDM), CAN, LIN, FlexRay or MIL-STD-1553 serial data patterns. Intuitively decode values on the oscilloscope grid.

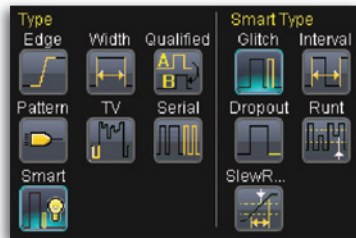

Powerful Triggers Isolate Events

An extensive collection of SMART, Serial, and Digital (MS Series) triggers enables users to quickly and easily isolate events of interest (some optional).

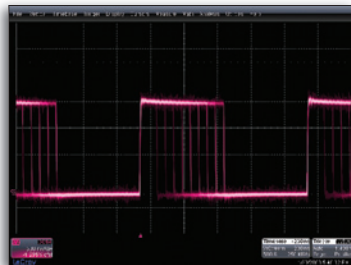

WaveStream™ Fast Viewing Mode

Use the high sampling rate and WaveStream fast viewing mode to characterize signal shape, rise time, overshoot, etc., and verify the presence or absence of high-speed transients.



Advanced Acquisition Modes

Sequence Mode allows you to partition your acquisition memory into segments and capture specific events over long periods of time. Then, view and analyze each segment individually.



WaveScan™ Advanced Search and Analysis

WaveScan provides the ability to locate unusual events in a single capture, or scan for an event in many acquisitions over a long period of time using more than 20 different search/scan modes. Use ScanHisto or ScanOverlay to display intuitive scanned results.



Completely Customizable

Quickly create your own measurement parameters or math functions using Excel, MATLAB®, or VBScripts (some capability optional).

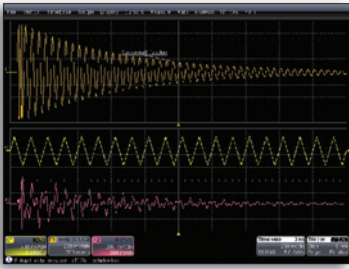

Advanced Application Packages

Use a variety of application packages to provide detailed, fast solutions for specific problems.

Fast Long Memory with Front Panel Zoom Controls

WaveRunner Xi-A's long memory is optimized for calculation of more information 10–100x faster than other oscilloscopes, while enabling easy access to simple zooming and positioning from the front panel.

Extensive Math and Measurement Capability

More standard and optional measurements and more powerful math capabilities are provided with results returned faster than in other oscilloscopes.

Complete Probing Solutions

A wide variety of active FET probes, current probes, differential probes, HV probes, etc. with complete tip and ground accessories make it easy to probe your signals.

Mixed Signal Oscilloscope Option

The MS Series can capture digital signals with speeds up to 500 MHz. View up to 36 digital channels with up to 50 Mpts/Ch memory and analyze analog and digital events together.

Actions for P1



Beyond Time Domain Analysis

Amplify your understanding with multidomain analysis of your signals. Convert signal information into Statistical domain (Histogram), Spectral domain (long memory FFTs), Jitter, Modulation, or other Measurement Parameter domains (Tracks of measurement parameters). (Some capability is optional.)

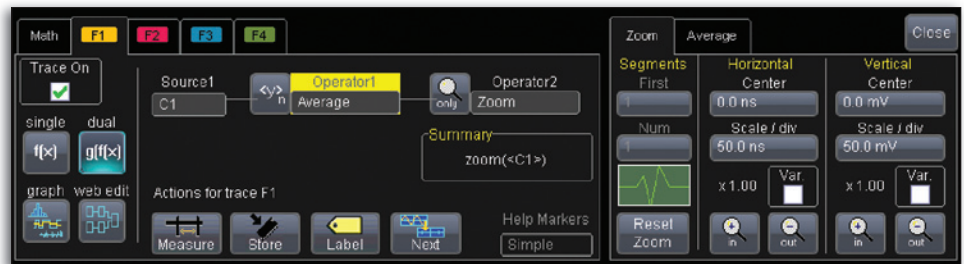

Integrated Tool Sets

LeCroy math, measure, and analysis tools are tightly integrated with basic scope operations. It's easy to link capabilities and expand understanding. Free yourself from constraints!

Power/Amplifier Measurements

Excellent overdrive recovery and signal integrity make WaveRunner Xi-A ideal for high-voltage switching loss, conduction loss, ripple, switching power supply, and other amplifier measurements. Use with LeCroy Differential Amplifiers for high-performance 100,000:1 Common-Mode Rejection Ratio.

Timing Characterization

Extensive triggers allow fast event isolation. Measure timing statistically and view behavior graphically using histograms. Gain real understanding of root cause.

Slow/High-speed Signal Mix

Long memory, HFREJ trigger coupling, built-in noise filtering, etc. enable fast understanding of signal behavior in circuits with a mix of slow-speed (sensor, actuator, power supply, mechanical) and high-speed signals.

THE MOST COMPLETE PROBLEM SOLVING OSCILLOSCOPES

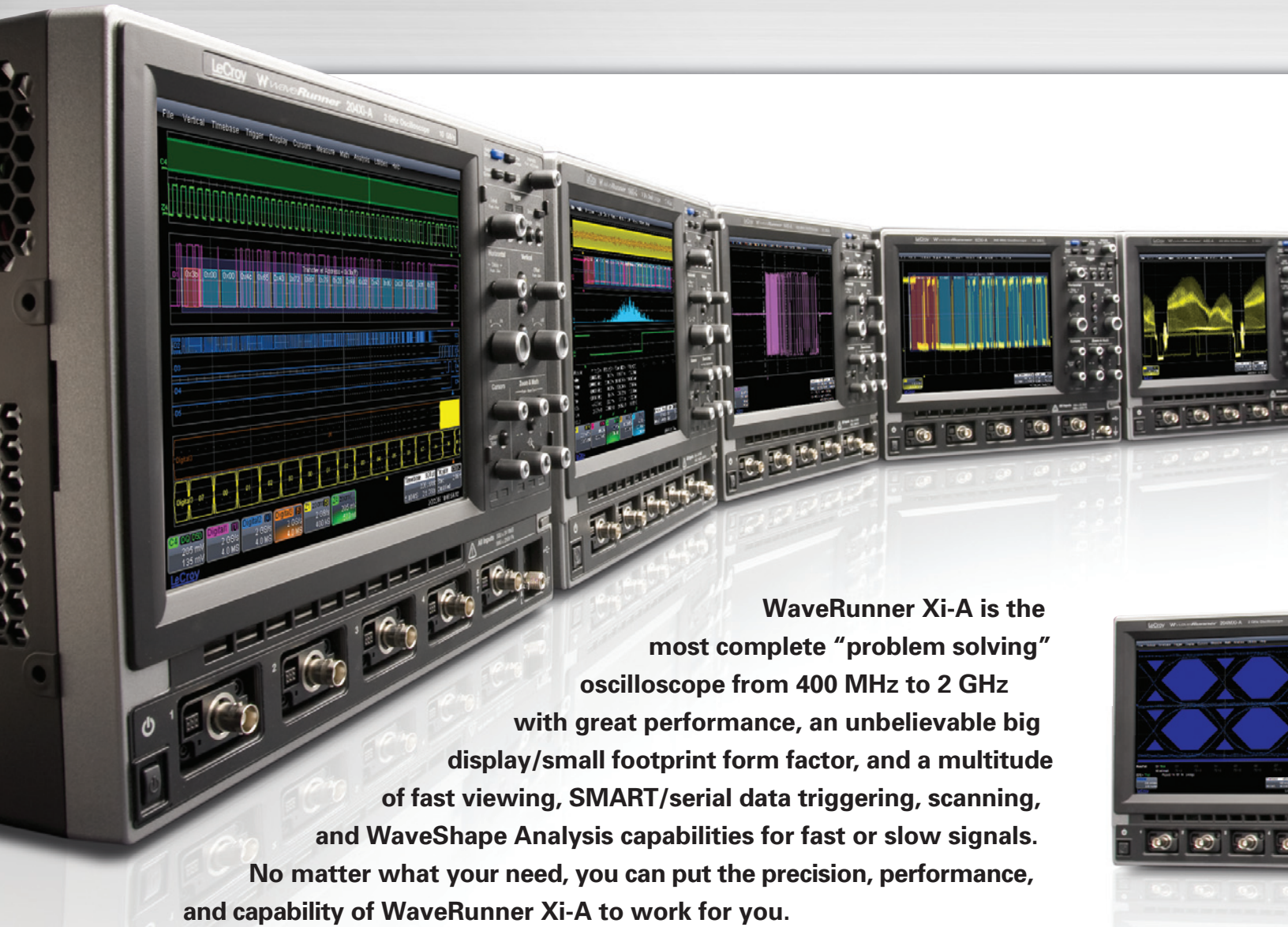

WaveRunner Xi-A is the most complete “problem solving” oscilloscope from 400 MHz to 2 GHz with great performance, an unbelievable big display/small footprint form factor, and a multitude of fast viewing, SMART/serial data triggering, scanning, and WaveShape Analysis capabilities for fast or slow signals. No matter what your need, you can put the precision, performance, and capability of WaveRunner Xi-A to work for you.

Great Performance

With 5 GS/s and 12.5 Mpts standard on every channel (up to 10 GS/s interleaved with 64Xi-A, 104Xi-A, and 204Xi-A), you can be assured of precise measurements of fast signals, and long captures of slow-speed events.

Big Display/Small Footprint

A big display is crucial to understanding circuit behaviors, especially when working with a combination of analog, digital, and serial data signals. That’s

why we use a big, bright 10.4" color display to allow room for everything, including time-correlated views of mixed-signal systems and non-time domain analysis. You’ll love the impressive display viewing angle; and the very small instrument footprint makes it easy to work anywhere.

Powerful WaveShape Analysis Capability

WaveRunner Xi-A has the best problem-solving capability, whether you are gathering statistical data

on thousands or millions of events, converting signal information into a statistical, modulation, or frequency domain for better understanding, or using WaveScan™ to find anomalous events. In addition, WaveRunner Xi-A’s has numerous application packages to solve specific test and measurement challenges.

WaveRunner MXi-A Series

The Essential Tools for Efficient Validation and Debug

The WaveRunner® MXi-A not only provides the performance and tools required to debug and validate your signals, it goes deeper into your testing to help you understand the causes of complex problems.

The WaveRunner MXi-A oscilloscopes provide all of the powerful debug and analysis tools of the

MXi-A models, with the addition of advanced Math and measurements, jitter and timing analysis, and customized math and measurements.

The WaveRunner MXi-A provides all of the essential tools for efficient validation and debug.

Leading Features

- 400 MHz – 2 GHz Analog Bandwidths
- Advanced Math and Measurement Capabilities
- Jitter and Timing Analysis
- Customized Math and Measurements

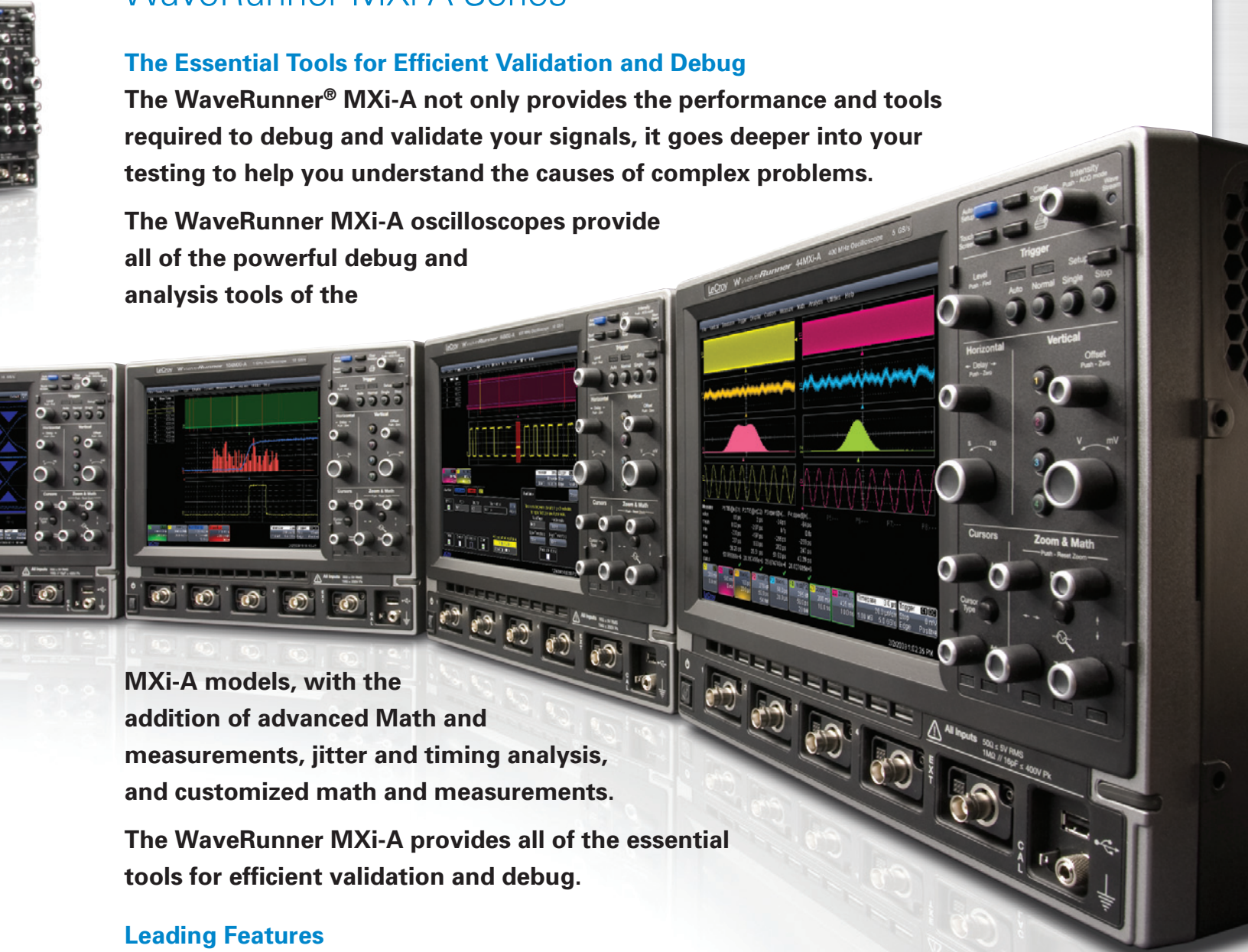

EMBEDDED CONTROLLER VALIDATION AND DEBUG

LeCroy's powerful WaveRunner Xi-A oscilloscopes can be turned into high-performance mixed signal oscilloscopes (MSOs) with the addition of the MS-500 or MS-250 mixed signal oscilloscope options. In addition, I²C, SPI, UART, RS-232, AudioBus (I²S, LJ, RJ, TDM), CAN, LIN, FlexRay, and MIL-STD-1553 triggering and decoding options turn the WaveRunner Xi-A into an all-in-one analog, digital, and serial data trigger, acquisition, and analysis machine.

High-performance Mixed Signal Capabilities

Embedded controller design and debug involves capturing and viewing a number of different types of signals. These signals are typically a mix of analog, digital, and serial data waveforms from a combination of analog sensors, microcontrollers and peripheral devices. With the ability to capture digital signals with speeds up to 500 MHz and long

memory of 50 Mpts/Ch the MS-500 provides unmatched mixed signal performance. For added flexibility the MS-500 supports 36 channels allowing you to view all the signals if a 16-bit micro controller plus some control lines. For applications not requiring the highest performance the MS-250 is a great value, providing 250 MHz maximum signal speed, 18 channels and 10 Mpts/Ch.

Extensive Triggering

The MS-500 and MS-250 enhance the WaveRunner Xi-A trigger capabilities. Normal oscilloscope triggers will operate on digital inputs. Cross-pattern triggering allows for simple or complex trigger patterns to be setup with any combination of analog and digital channels. Event triggering can be configured to arm on an analog signal and trigger on a digital pattern.

Quick Mixed Signal Setup, Easy-to-use

Unlike a traditional Logic Analyzer, the MS-500 and MS-250 are easy to use. A simple connection links the oscilloscope with the digital inputs so users can start viewing signals and begin debugging quickly. In addition, all standard oscilloscope tools are readily accessible. Signal debug is simple, using standard oscilloscope tools, such as cursors, measurement parameters, and zooming.

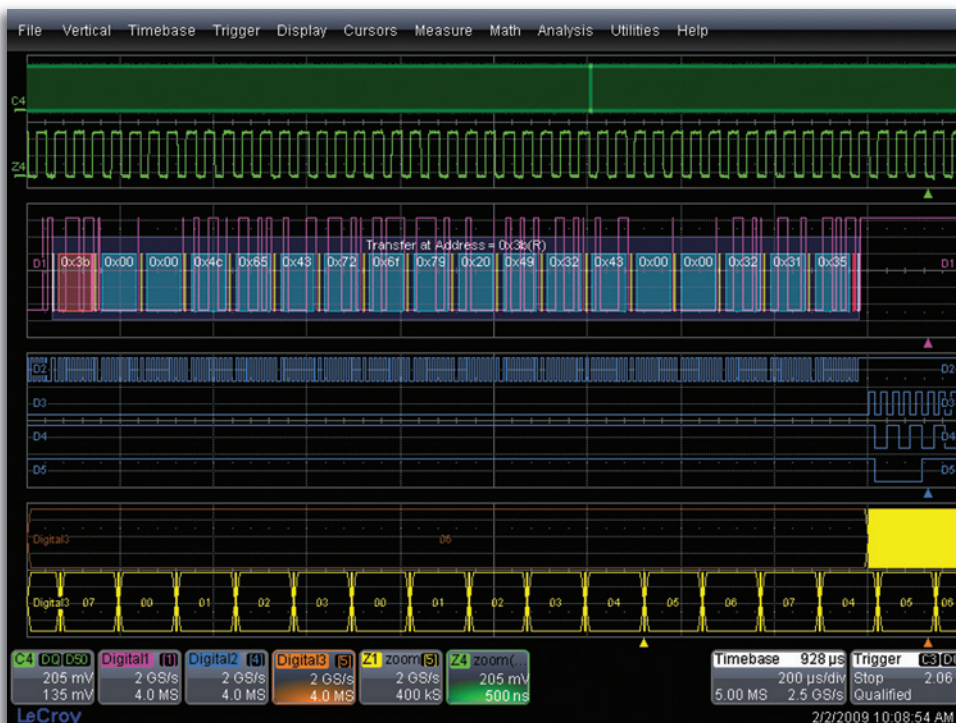

Complete I²C, SPI, UART, RS-232, AudioBus (I²S, LJ, RJ, TDM), CAN, LIN, FlexRay, and MIL-STD-1553 Serial Triggering

Quickly and easily isolate specific serial data events on your embedded controller for better understanding and faster debug. Set up trigger conditions in binary, hexadecimal (Symbolic for CAN) formats. Use the MS-500 or MS-250 to capture serial data busses keeping the analog oscilloscope channels open for other uses. Trigger on DATA in specific locations of long I²C EEPROM reads. Get complete control of your debug process and finish faster.



Powerful Conditional Data Triggering

Completely isolate specific message events for better understanding and debug. Use a conditional I²C SPI, UART, RS-232, AudioBus (I²S, LJ, RJ, TDM),

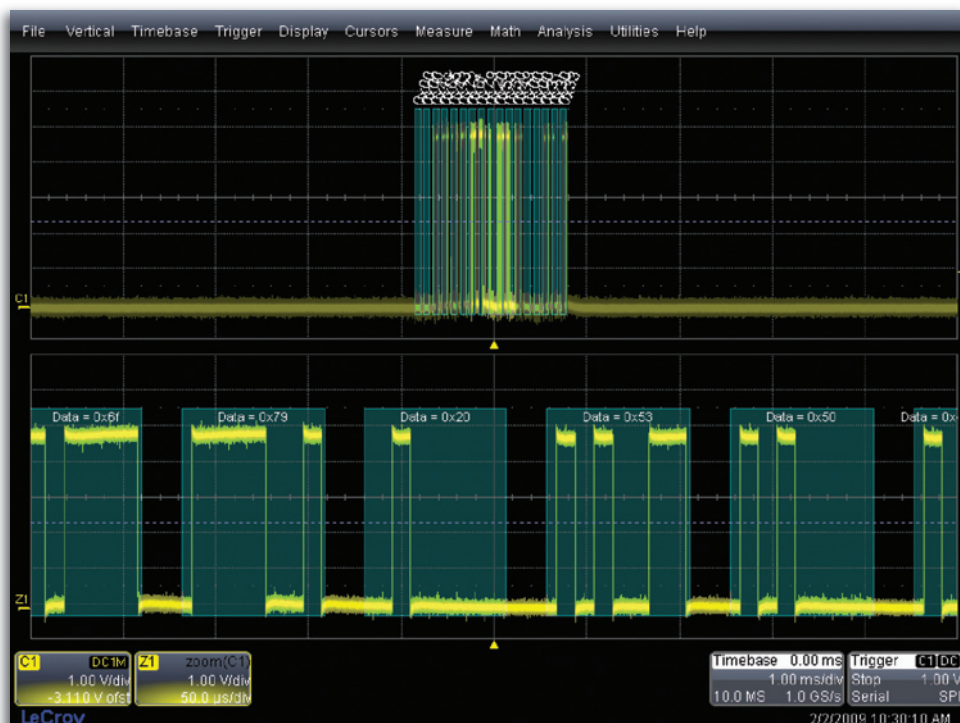

CAN, LIN, FlexRay, and MIL-STD-1553 DATA trigger to select a range of DATA values to trigger on, not just a single DATA value. Oftentimes, I²C utilizes DATA bytes to specify sub-addresses for accessing memory locations in EEPROMs. Conditional DATA trigger allows triggering on a range of DATA bytes that correspond to reads or writes to specific sub-address memory blocks in the EEPROM. It can also aid in monitoring DATA outputs from sensors, such as analog-to-digital converters, and triggering when DATA is outside a safe operating range. In both cases, verifying proper operation becomes a simple task.

Intuitive, Color-Coded Decode Overlay

Advanced software algorithms deconstruct the waveform into binary, hex, or

ASCII protocol information, then overlay the decoded data on the waveform. Various sections of the protocol are color-coded to make it easy to understand. The decode operation is fast—even with long acquisitions.

Table Summary and Search/Zoom

Turn your oscilloscope into a protocol analyzer with the Table display of protocol information. Customize the table, or export Table data to an Excel file. Touch a message in the table and automatically zoom for detail. Search for specific address or data values in the acquisition.

Idx	Time	Addr Length	Address	R/W	Length	Data
8	240.494 ms	7	0x21	1	2	0x0f 00 00
9	360.555 ms	7	0x21	0	1	0x00
10	380.698 ms	7	0x21	1	2	0x49 00 00
11	481.865 ms	7	0x21	0	1	0x0a
12	482.007 ms	7	0x21	1	2	0x00 00 00
13	608.294 ms	7	0x20	0	3	0x01 35 00
14	721.235 ms	7	0x20	0	1	0x00
15	721.377 ms	7	0x20	1	2	0x12 35 00
16	841.266 ms	7	0x20	0	1	0x02

EXCELLENCE IN ACQUISITION

X-Stream II Architecture

Optimized for Fast Throughput

X-Stream II architecture enables high throughput of data. X-Stream II uses variable waveform segment lengths to enable all processing intensive calculations to take place in fast CPU cache memory, thus improving calculation speed and efficiency. The result—faster processing compared to other oscilloscopes.

Optimized for Long Memory

X-Stream II essentially has no analysis memory length restrictions, regardless of analysis type, since the variable waveform segment length can always be limited to a size that can fit in CPU cache memory. Other oscilloscopes with conventional architectures cannot make this claim, and often have limitations on analysis memory of 5–20% the length of their acquisition memory under the best conditions.

Optimized for Responsiveness

By dynamically allocating buffers to maximize memory availability, the WaveRunner Xi-A Series embodies the fastest front panel responsiveness. A built-in processing abort makes front panel control changes instant by stopping the current process and allowing new waveforms to be positioned or zoomed—all without a lengthy recalculation. Meanwhile, waveform previewing shows interim calculation results.

SMART Triggers Isolate Events

The WaveRunner Xi-A oscilloscope provides a multitude of basic and advanced (SMART) triggers to meet any need. Advanced triggers isolate specific events of interest, and (when combined with long memory) provide a complete view of the signal activity around that event. WaveRunner Xi-A excels in this regard.

Trigger on what you expect (widths, glitches, video, logic patterns, etc.) and also trigger on unusual signals (dropouts, intervals, runts, slew rates). LeCroy's exclusion triggering can exclude normal signals and capture only the abnormal ones, speeding up the debug of your circuits and systems. Trigger on signals down to 1 ns in width (500 ps for width and glitch trigger), or use an "A" condition to qualify a "B" trigger.

TriggerScan™

TriggerScan uses high-speed hardware triggering capability with persistence displays to capture only the signals of interest and provide answers up to 100x faster than other methods. Traditional fast display update modes work best on frequent events occurring on slow edge rates while TriggerScan excels in finding infrequent events on fast edge rates.

Since hardware triggering is used to capture only the elusive events, TriggerScan is more effective at finding anomalies quickly compared to simple display technologies.

A built-in automated Trigger Trainer analyzes the waveforms, identifies normal behavior, and then sets up a large set of rare event smart trigger setups that target abnormal behavior. It then rapidly sequences through each individual trigger with a user-defined dwell time, and captures and displays any anomalous signals that meet the trigger conditions.

Sequence Mode Extends Long Memory and SMART Triggering Capability

Use Sequence mode to store up to 10,000 triggered events as "segments" into oscilloscope memory. This can be ideal when capturing many fast pulses in quick succession (i.e., trigger re-arm time is most important) or when capturing few events separated by long time periods (i.e., longest capture time is most important).

Sequence mode can acquire 4 channels simultaneously, provide timestamps for each acquisition (to 1 ns resolution), minimize capture dead-time (to ≤ 800 ns), and allow various ways to view and analyze the captured segmented data.

Combine sequence mode with an advanced trigger to isolate a rare event, capture all instances over hours or days, and view and analyze each event afterwards.

LeCroy WaveStream™ Fast Viewing Mode

WaveStream provides a vibrant, intensity graded (256 levels) display with a fast update to closely simulate the look and feel of an analog oscilloscope. WaveStream is most helpful in viewing signals that have signal jitter or signal anomalies, or for applying a visual check before creating an advanced trigger or WaveScan setup to locate an unusual event.

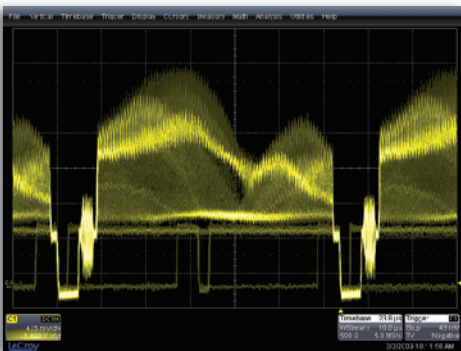

Since the sample rate in WaveStream mode can be as high as 10 GS/s (up to 5x that of other oscilloscopes), it is an excellent runt or glitch finder. Timing jitter is often visually assessed to understand approximate behavior. WaveStream makes it easy to understand jitter on edges or in eye diagrams. WaveStream also excels in allowing you to relate composite (WaveStream) to single-event (real-time sampled) behaviors. Just capture in WaveStream mode, toggle to view or zoom a single trace, then toggle back to WaveStream mode.

WaveScan™ Advanced Search and Analysis Finds Problems that Triggers Won't Find.

The best trigger won't find all unusual events—a more powerful capability is sometimes needed. WaveScan provides the ability to locate unusual events in a single capture (i.e., capture and search), or “scan” for an event in many acquisitions over a long period of time. Select from more than 20 search modes (frequency, rise time, runt, duty cycle, etc.), apply a search condition and begin scanning. Since the scanning “modes” are not simply copies of the hardware triggers, the utility and capability is much higher. For instance, there is no “frequency” trigger in any oscilloscope, yet WaveScan allows “frequency” to be quickly “scanned” for. This allows the user to accumulate a data set of unusual events that are separated by hours or days, enabling faster debugging.

When used in multiple acquisitions, WaveScan builds on the traditional LeCroy strength of fast processing of data. A LeCroy X-Stream oscilloscope will quickly “scan” millions of events, looking for unusual occurrences, and do it much faster and more efficiently than other oscilloscopes can.

WaveScan in WaveRunner Xi-A also contains ScanHisto and ScanOverlay capability. Found events can be overlaid in a ScanOverlay view to provide a quick and simple comparison of events. In addition, measurement-based scanning modes (like the frequency example given above), permit ScanHistograms to show the statistical distribution of the found events. These analysis tools simplify understanding and enable faster debug.

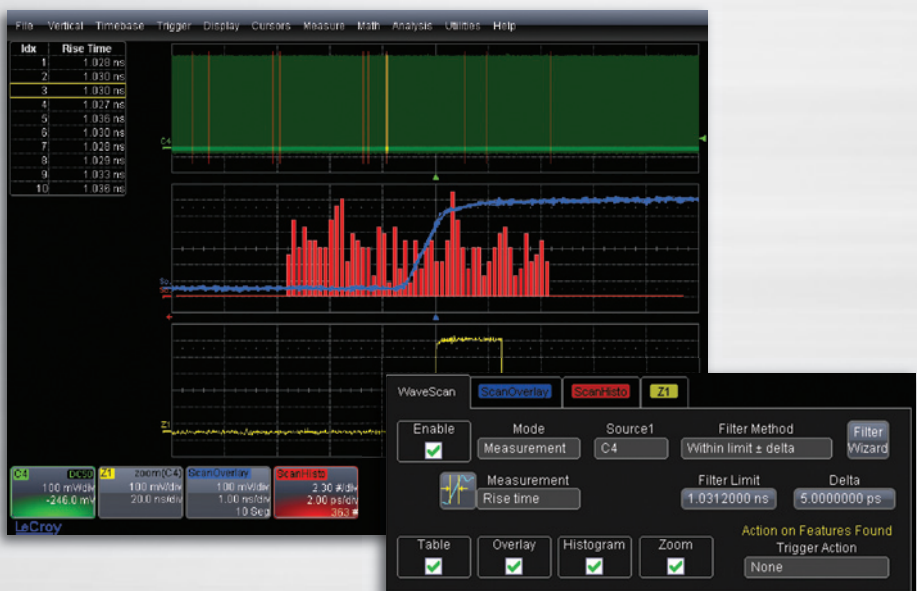

UNMATCHED MEASUREMENT AND VALIDATION CAPABILITY

WaveRunner Xi-A provides the highest value for every-day characterization, validation, and debug, and the best capability for quickly debugging advanced problems. Whether you are debugging circuits with a mix of slow- and high-speed signals, performing signal integrity checks on high-speed clock and data signals, or doing advanced debugging of complex problems, WaveRunner Xi-A has the right toolset that is easily applied to the problem.

Oftentimes, only viewing signals does not provide the level of precision that is required for validating designs. At those times, the ability of WaveRunner Xi-A to quickly provide precise statistical data becomes vital. With WaveRunner



Xi-A, you can quickly accumulate data on thousands of measurements in a single shot (WaveRunner Xi-A does not limit its measurements to a single value in an acquisition) or in multiple acquisitions.

Touch a button, and display statistical information. Touch another button to

display a Histogram graphical view of the measurement distribution. Expand this view into a larger histogram of measurement data. Accumulate up to 2 billion measurement events, or create measurable persistence traces of signals with the optional WRXi-STAT.

Advanced Math Characterization

Most oscilloscopes contain only a few simple math functions to subtract waveforms or to perform coarse resolution FFTs on short record length acquisitions. Or, they provide long memory, but limited ability to process the memory and perform WaveShape

Analysis that leads to detailed understanding and faster debug.

WaveRunner Xi-A oscilloscopes contain dozens of standard math functions, and powerful capabilities, such as long memory FFTs, Trending, Tracking (optional), Sparsing, Interpolation selection, a variety of Persistence

Views, user customized math and measurements (MATLAB or Visual Basic formats), and numerous other specialized capabilities (optional Application Packages). The toolset is rich and deep, and sure to solve any complex problem.

LABNOTEBOOK™

A UNIQUE TOOL FOR DOCUMENTATION AND REPORT GENERATION

The LabNotebook feature of WaveRunner Xi-A provides a report generation tool to save and document all your work. Saving all displayed waveforms, relevant WaveRunner Xi-A settings, and screen images is all done through LabNotebook, eliminating the need to navigate multiple menus to save all these files independently.

The screen images saved can be annotated with freehand notes using the stylus and touch screen, and then included in your report.

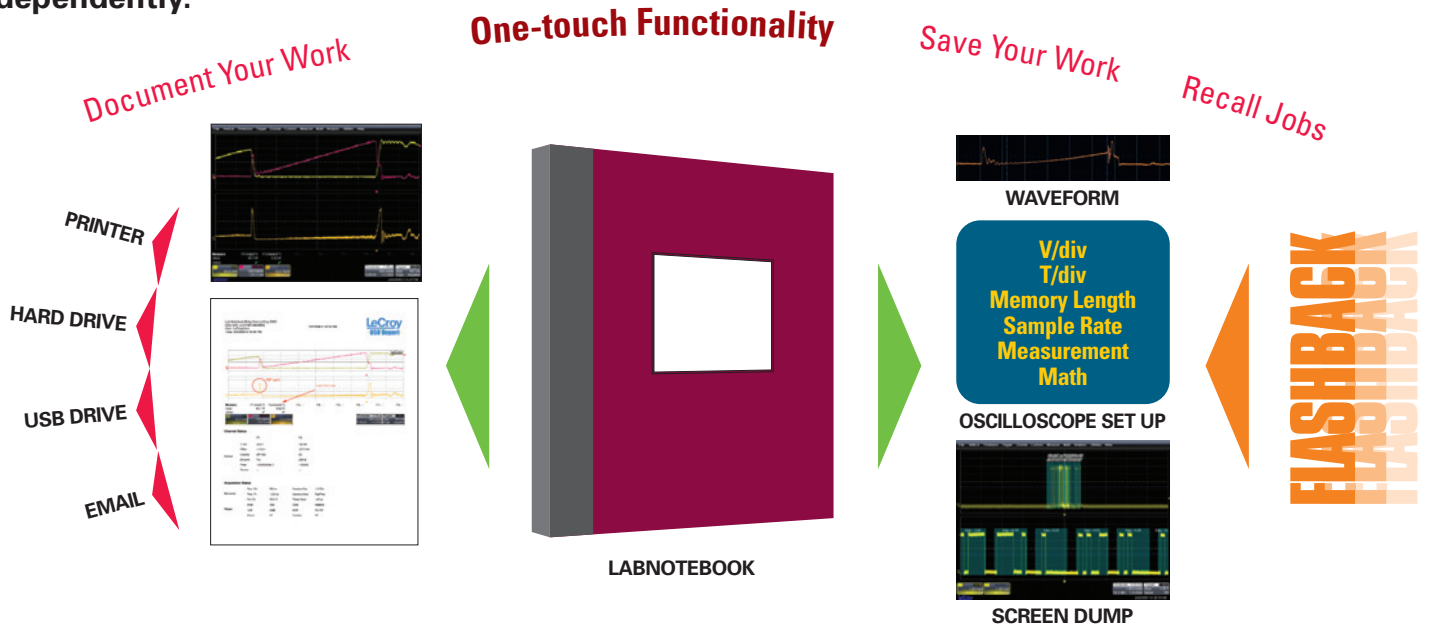

Easy report generation helps you share your findings and communicate important results.

LabNotebook adds a simple way to report your work and save all essential waveforms, settings, and screen images.

Quickly save all the necessary files with LabNotebook in a single button press.

Recall your settings from any report by using the Flashback capability.

The WaveRunner Xi-A touch screen and stylus allow for easy annotation of the screen. LabNotebook allows you to add freehand text and graphics in multiple colors along with printed text and arrows to help identify important parts of your waveforms and measurements.

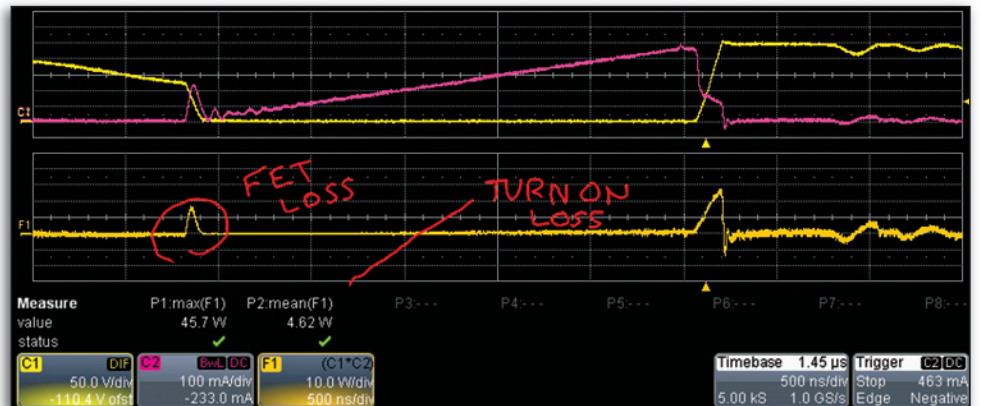

MULTIDOMAIN WAVESHAVE ANALYSIS IMPROVES UNDERSTANDING

The most difficult electrical circuit problems are rarely obvious in the time domain. Long memory with zooming, searching, and scanning is an important part of the solution. However, serious design professionals understand the importance of converting time-domain information into statistical, parameter, or frequency domains so as to get to the root of the problem quicker. WaveRunner Xi-A provides you with the tools necessary to understand complex circuit problems and solve them faster.

Trend Views Turn Your Oscilloscope Into a Strip Chart Recorder

Slowly sample at 1000 seconds/div to capture hours of slow speed signal data. Using Trend Views, plot measurement values of high-speed signals with slower speed signals, such as transducer or voltage values.

Track Views Provide Graphical Display of Parameter Values vs. Time

Track in WaveRunner Xi-A (optional) uses every instance of a measurement in an acquisition to create a plot of measurement values on the Y-axis and time on the X-axis. The result is a graphical plot of a measurement

change time-correlated to the original channel acquisition—perfect for intuitive understanding.

Some examples include:

- Measuring a signal's Frequency over a 100 ms interval, and understanding whether the correct frequency shifts are present at the right times.
- Measuring a pulse width modulated (PWM) signal's Width over a 1 second interval, and determining if the modulation circuit is correctly reacting to system changes.
- Measuring the cycle-cycle jitter values in a micro processor and understanding how cycle-cycle jitter peaks correlate to spikes in power supply lines.

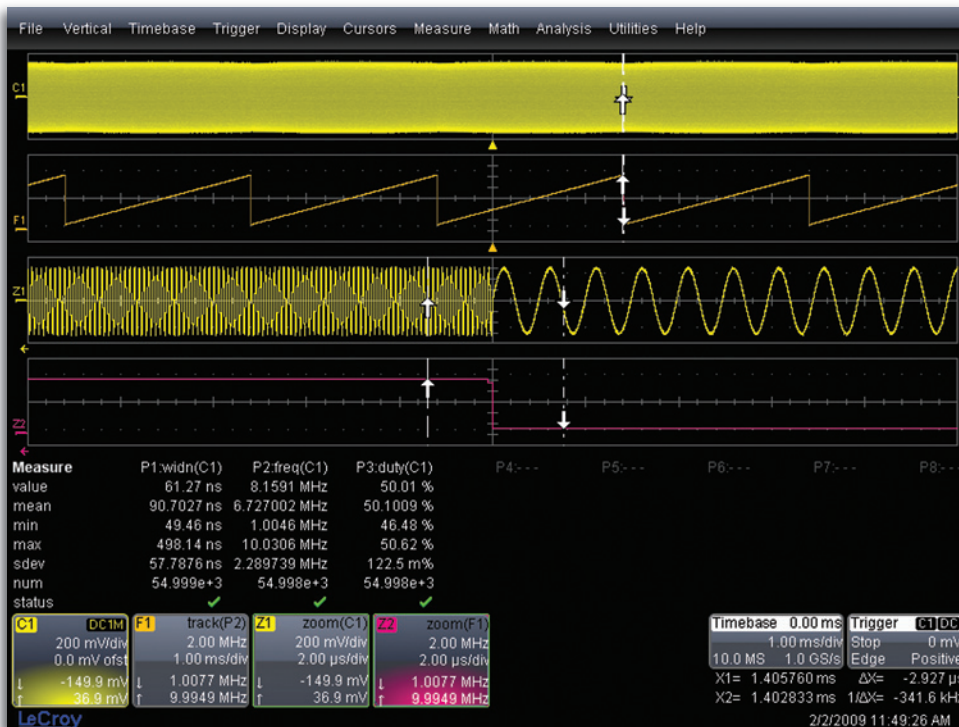

The PWM signal for a power tool motor speed controller is monitored during start-up. The Width parameter is used. All instances of Width during the acquisition are measured. Then, Track was applied to determine when the speed plateaued (i.e., when the tool rotation reached steady-state).

Histograms Graphically Present Statistical Data

LeCroy oscilloscopes excel in capturing hundreds or thousands times more measurements per acquisition than other oscilloscopes do. With this much data, it is essential to provide more than just a list of mean, min, max, sdev, etc. Histograms provide an intuitive way to view the distribution of statistical data and gain real insight into underlying problems. For instance:

- Measure millions of jitter values in seconds, understand whether the measurement distribution is Gaussian or non-Gaussian, and correct timing problems to stay within a timing budget.
- Improve validation of timing budgets when measuring embedded controller response times. Measure hundreds of thousands of timing events instead of just hundreds, and easily view real-world worst-case timing situations.

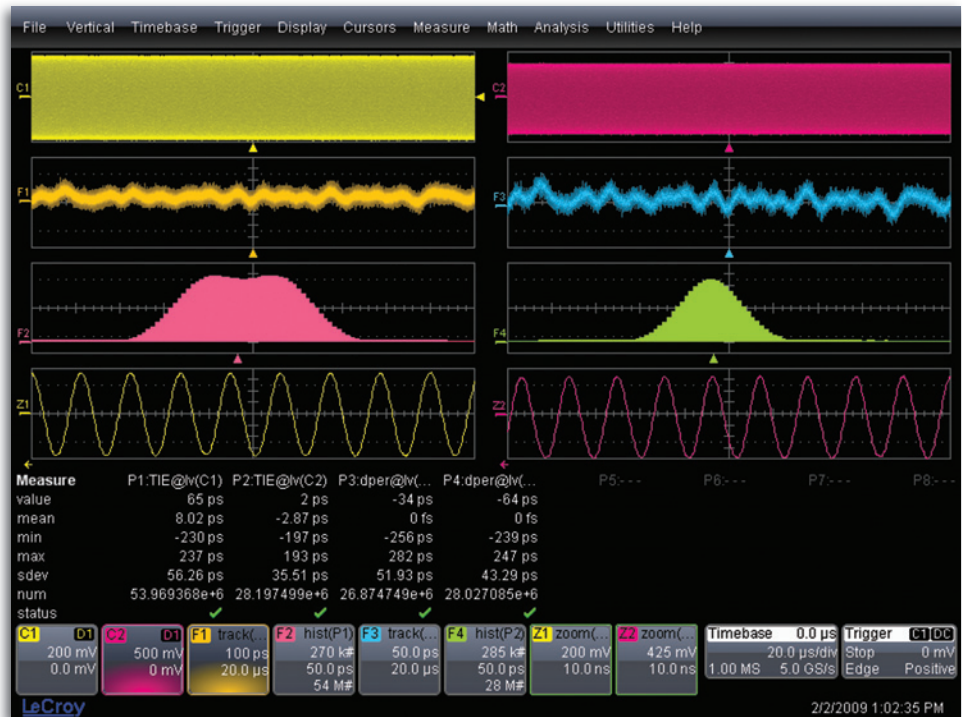

A 200 MHz clock signal is acquired at 10 GS/s using 20 Mpts of acquisition data (400,000 cycles). Cycle-Cycle and Period Jitter are measured and analyzed with Tracks and Histograms. Cycle-Cycle jitter shows a distinctive modality. Other signals could now be acquired and time-correlated to understand the histogram modality.

Fast Fourier Transforms (FFTs) Provide Spectral Views for Advanced Troubleshooting

LeCroy's long memory (up to 25 Mpts) FFTs increase your ability to understand signal behaviors in the frequency domain. The long memory allows users to obtain 5–100x the frequency resolution possible with FFTs available in other oscilloscopes, which allows more precise troubleshooting. Built-in averaging of FFTs helps to eliminate random events from the calculations. In addition, LeCroy FFTs can be applied to any channel or math function, which greatly expands the ability to gather useful information.

Some examples include:

- Capture power supply, clock, and data signals with 1 kHz frequency resolution. Correlate power supply noise to signal integrity.
- Apply an FFT to a Track of Cycle-Cycle Jitter and gain insight into the frequency components and root cause of the jitter.
- Quickly capture hundreds of acquisitions and average the FFTs to increase frequency signal-noise ratio and to separate random from deterministic events.

SPECIFIC SOLUTIONS FOR TOUGH PROBLEMS

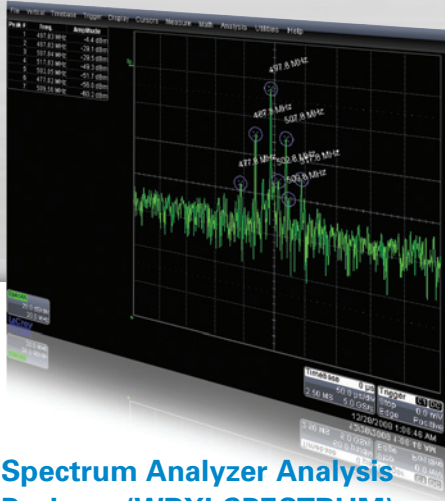

Spectrum Analyzer Analysis Package (WRXi-SPECTRUM)

SPECTRUM converts the controls of your oscilloscope to those of a spectrum analyzer. Adjust the frequency span, resolution and center frequency. Apply filtering to your signal and watch the frequency signature change in real time. A unique peak search labels spectral components and presents frequency and level in a table. Touch any line to move to that peak.

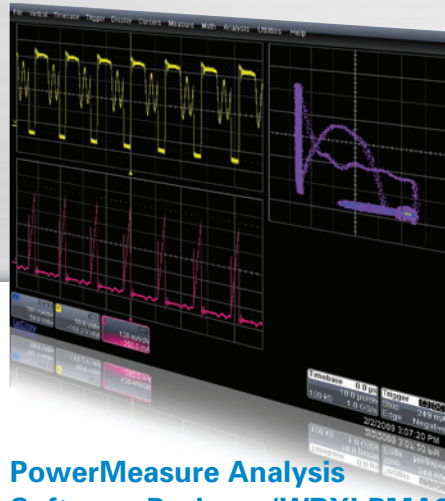

PowerMeasure Analysis Software Package (WRXi-PMA2)

The PMA2 software package enhances your ability to analyze power conversion devices and circuits. Measure switching and conduction losses with high accuracy. Capture power supply start-up events using long memory, view changes in the PWM signals using Track, and correlate PWM changes to other circuit signals. Measure power frequency harmonics and apparent/ real power and power factor. Optional accessories, such as differential amplifiers, differential probes, current probes, and deskew fixtures complete the solution.

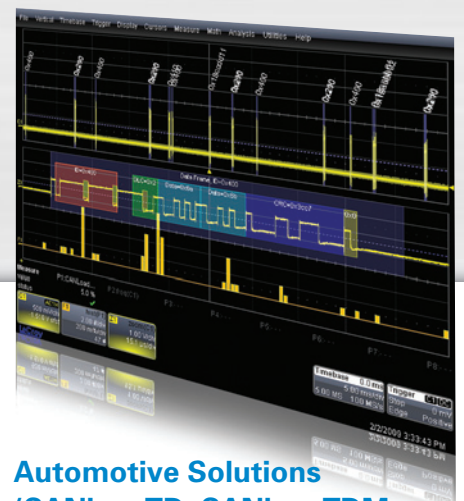

Automotive Solutions (CANbus TD, CANbus TDM, WRXi-FlexRaybus TD/TDP, WRXi-LINbus TD)

Flexible trigger on CAN, FlexRay, or LIN bus messages. Decode and display hexadecimal data values next to the signal on the screen. Statistically analyze performance with histograms and determine root cause of timing irregularities. Vehicle Bus Analyzer (VBAs) provide CAN symbolic level trigger and decoding, as well as FlexRay TDP and LIN trigger and decodes.

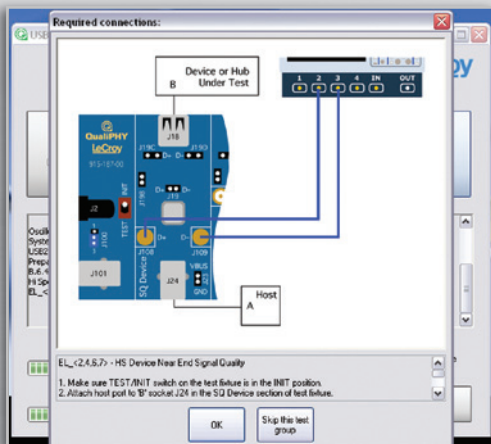

Serial Data Compliance Packages

QualiPHY serial data compliance packages provide easy to use step by step instructions for a broad set of serial data standards, such as USB 2.0 and Ethernet. With fast automated performance, illustrated instructions and comprehensive reporting capability, QualiPHY packages are the best solution for compliance testing.

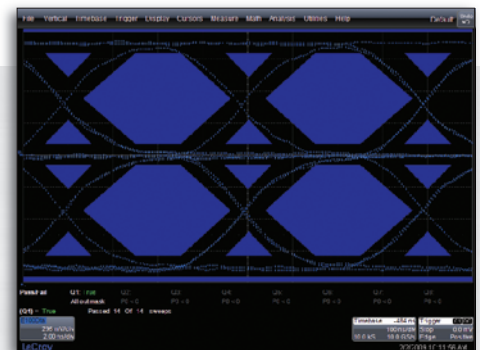

QPHY-ENET – 100Base-TX twisted pair active output interface mask test result.

Ethernet Application Software Package (QPHY-ENET)

QPHY-ENET performs electrical compliance testing for 1000Base-T,

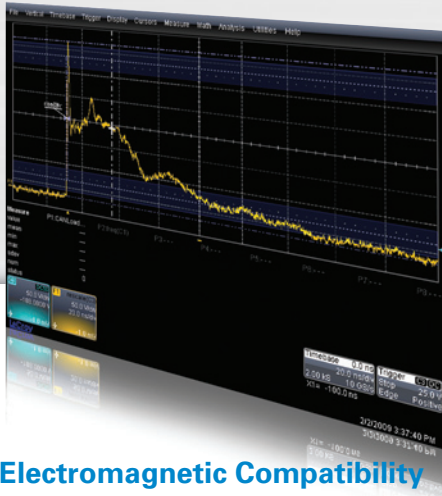

Electromagnetic Compatibility Software Package (WRXi-EMC)

The EMC software package adds flexibility to the rise time, fall time, and width parameters necessary to accurately measure ESD pulses, EFT bursts, surges, and transients common in EMC testing. In addition, the EMC package allows histogramming of up to 2 billion events, parameter math, and measurement filtering. Combine this with LeCroy's unbeatable standard statistics and measurement capability and you have a winning combination.



Jitter and Timing Analysis Software Package (WRXi-JTA2)

Use specialized timing parameters to measure period, cycle-cycle, half period, width, etc. jitter on a variety of signals. Use the three views of jitter (statistical, time, and frequency) to understand root cause and to debug problems. Histograms (statistical view) provide understanding of statistical distributions. Tracks (time view) provide a means to show time-correlated peaks or modulations of jitter, and to compare it to other signals. FFTs (frequency view) provide the ability to debug root causes of high in-circuit jitter.



Digital Filter Software Package (WRXi-DFP2)

DFP2 lets you implement Finite or Infinite Impulse Response filters to eliminate undesired spectral components, such as noise, and enhances your ability to examine important signal components. The DFP2 option allows you to choose from a standard set of FIR or IIR filters and also gives you the ability to design your own filters.

100Base-TX, and 10Base-T standards with LeCroy's QualiPHY automated test and report software. Jitter and pulse mask tests are performed with automatic waveform alignment, and all test results feature pass/fail indicators corresponding to the standard being tested. LeCroy's test fixture provides all three standard test loads and conditions as described in the IEEE and ANSI specifications.

USB 2.0 Compliance Test Software Package (QPHY-USB)

The QPHY-USB package provides a complete acquisition and analysis system for USB 2.0 devices, hosts, and hubs, as specified in the USB-IF USB 2.0 Electrical Test Specification. The test software implements a full set of electrical tests for USB 2.0, including High-, Full-, and Low-speed tests and is supported by LeCroy's

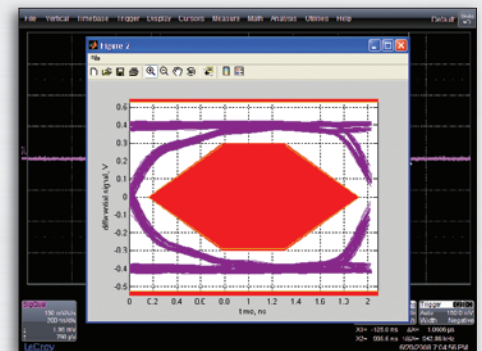

QPHY-USB – Eye diagram created using the integrated USB-IF MATLAB® test scripts.

QualiPHY automated test and reporting software.

PROBES

High-performance probes are an essential tool for accurate signal capture. Consequently LeCroy offers an extensive range of probes to meet virtually every application need. Optimized for use with LeCroy oscilloscopes, these probes set new standards for responsiveness and signal detection.

ZS Series High Impedance Active Probes

Leading Features:

- 1 GHz (ZS1000) and 1.5 GHz (ZS1500) bandwidths
- High Impedance (0.9 pF, 1 M Ω)
- Extensive standard and available probe tip and ground connection accessories
- ± 12 Vdc offset (ZS1500)
- LeCroy ProBus system



ADP305, ADP300

Leading Features:

- 20 MHz and 100 MHz bandwidth
- 1,000 V_{rms} common mode voltage
- 1,400 V_{peak} differential voltage
- EN 61010 CAT III
- 80 dB CMRR at 50/60 Hz
- LeCroy ProBus system only



PPE1.2KV, PPE2KV, PPE4KV, PPE5KV, PPE6KV, PPE20KV

Leading Features:

- Suitable for safe, accurate high-voltage measurements
- 1.2 kV to 20 kV
- Works with any 1 M Ω input oscilloscope



CP030 and CP031

Leading Features:

- 30 A_{rms} continuous current
- 50 or 100 MHz bandwidth
- Measure pulses up to 50 A_{peak}
- Small form factor accommodates large conductors with small jaw size
- LeCroy ProBus system



AP031

Leading Features:

- Lowest priced differential probe
- 15 MHz bandwidth
- 700 V maximum input voltage
- Works with any 1 M Ω input oscilloscope



AP033 and AP034

Leading Features:

- 500 MHz and 1 GHz bandwidth
- 10,000:1 CMRR
- Wide dynamic range, low noise
- LeCroy ProBus System



HFP2500

Leading Features:

- 2.5 GHz bandwidth, 0.7 pF input capacitance
- Interchangeable tips for a variety of probing needs
- Hands free probing with probe holder
- AutoColor ID matches probe color to channel
- LeCroy ProBus system

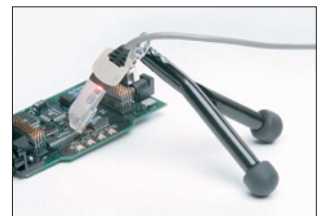

SPECIFICATIONS

Standard

Math Tools

Display up to four math function traces (F1-F4). The easy-to-use graphical interface simplifies setup of up to two operations on each function trace; and function traces can be chained together to perform math-on-math.

absolute value	integral
average (summed)	invert (negate)
average (continuous)	log (base e)
custom (MATLAB) – limited points	product (x)
derivative	ratio (I)
deskew (resample)	reciprocal
difference (–)	rescale (with units)
enhanced resolution (to 11 bits vertical)	roof
envelope	(sinx)/x
exp (base e)	square
exp (base 10)	square root
fft (power spectrum, magnitude, phase, up to 50 kpts)	sum (+)
floor	trend (datalog) of 1000 events
histogram of 1000 events	zoom (identity)

Measure Tools

Display any 6 parameters together with statistics, including their average, high, low, and standard deviations. Histicons provide a fast, dynamic view of parameters and wave-shape characteristics.

amplitude	frequency	risetime (10–90%, 20–80%, @ level)
area	last	rms
base	level @ x	std. deviation
cycles	maximum	time @ level
custom (MATLAB, VBScript) – limited points	mean	top
delay	median	Δ time @ level
Δ delay	minimum	Δ time @ level from trigger
duration	number of points	width (positive + negative)
duty cycle	+overshoot	x@ max.
falltime (90–10%, 80–20%, @ level)	–overshoot	x@ min.
first	peak-to-peak	
	period	
	phase	

Pass/Fail Testing

Simultaneously test multiple parameters against selectable parameter limits or pre-defined masks. Pass or fail conditions can initiate actions including document to local or networked files, e-mail the image of the failure, save waveforms, send a pulse out at the rear panel auxiliary BNC output, or (with the GPIB option) send a GPIB SRQ.

Jitter and Timing Analysis Software Package (WRXi-JTA2) (Standard with MXi-A model oscilloscopes)

- Jitter and timing parameters, with “Track” graphs of
 - Cycle-Cycle Jitter
 - N-Cycle
 - N-Cycle with start selection
 - Frequency
 - Period
 - Half Period
 - Width
 - Time Interval Error
 - Setup
 - Hold
 - Skew
 - Duty Cycle
 - Duty Cycle Error
- Edge@lv parameter (counts edges)
- Persistence histogram, persistence trace (mean, range, sigma)

Software Options – Advanced Math and WaveShape Analysis

Statistics Package (WRXi-STAT)

This package provides additional capability to statistically display measurement information and to analyze results:

- Histograms expanded with 19 histogram parameters/up to 2 billion events.
- Persistence Histogram
- Persistence Trace (mean, range, sigma)

Master Analysis Software Package (WRXi-XMAP) (Standard with MXi-A model oscilloscopes)

This package provides maximum capability and flexibility, and includes all the functionality present in XMATH, XDEV, and JTA2.

Advanced Math Software Package (WRXi-XMATH) (Standard with MXi-A model oscilloscopes)

This package provides a comprehensive set of WaveShape Analysis tools providing insight into the wave shape of complex signals. Includes:

- Parameter math – add, subtract, multiply, or divide two different parameters. Invert a parameter and rescale parameter values.
- Histograms expanded with 19 histogram parameters/up to 2 billion events.
- Trend (datalog) of up to 1 million events
- Track graphs of any measurement parameter
- FFT capability includes: power averaging, power density, real and imaginary components, frequency domain parameters, and FFT on up to 24 Mpts.
- Narrow-band power measurements
- Auto-correlation function
- Sparse function
- Cubic interpolation function

Advanced Customization Software Package (WRXi-XDEV) (Standard with MXi-A model oscilloscopes)

This package provides a set of tools to modify the scope and customize it to meet your unique needs. Additional capability provided by XDEV includes:

- Creation of your own measurement parameter or math function, using third-party software packages, and display of the result in the scope. Supported third-party software packages include:
 - VBScript – MATLAB – Excel
- CustomDSO – create your own user interface in a scope dialog box.
- Addition of macro keys to run VBScript files
- Support for plug-ins

Value Analysis Software Package (WRXi-XVAP) (Standard with MXi-A model oscilloscopes)

Measurements:

- Jitter and Timing parameters (period@level,width@level, edge@level, duty@level, time interval error@level, frequency@level, half period, setup, skew, Δ period@level, Δ width@level).

Math:

- Persistence histogram
- Persistence trace (mean, sigma, range)
- 1 Mpts FFTs with power spectrum density, power averaging, real, imaginary, and real+imaginary settings)

Statistical and Graphical Analysis

- 1 Mpts Trends and Histograms
- 19 histogram parameters
- Track graphs of any measurement parameter

Intermediate Math Software Package (WRXi-XWAV)

Math:

- 1 Mpts FFTs with power spectrum density, power averaging, real, and imaginary components

Statistical and Graphical Analysis

- 1 Mpts Trends and Histograms
- 19 histogram parameters
- Track graphs of any measurement parameter

SPECIFICATIONS

	WaveRunner 44Xi-A 44MXi-A	WaveRunner 64Xi-A 64MXi-A	WaveRunner 62Xi-A	WaveRunner 104Xi-A 104MXi-A	WaveRunner 204Xi-A 204MXi-A
Vertical System					
Nominal Analog Bandwidth @ 50 Ω, 10 mV–1 V/div	400 MHz	600 MHz	600 MHz	1 GHz	2 GHz
Rise Time (Typical)	875 ps	500 ps	500 ps	300 ps	180 ps
Input Channels	4	4	2	4	4
Bandwidth Limiters	20 MHz; 200 MHz				
Input Impedance	1 MΩ 16 pF or 50 Ω			1 MΩ 20 pF or 50 Ω	
Input Coupling	50 Ω: DC, 1 MΩ: AC, DC, GND				
Maximum Input Voltage	50 Ω: 5 V _{rms} , 1 MΩ: 400 V max. (DC + Peak AC ≤ 5 kHz)			50 Ω: 5 V _{rms} , 1 MΩ: 250 V max. (DC + Peak AC ≤ 10 kHz)	
Vertical Resolution	8 bits; up to 11 with enhanced resolution (ERES)				
Sensitivity	50 Ω: 2 mV/div–1 V/div fully variable; 1 MΩ: 2 mV–10 V/div fully variable				
DC Gain Accuracy	±1.0% of full scale (typical); ±1.5% of full scale, ≥ 10 mV/div (warranted)				
Offset Range	50 Ω: ±1 V @ 2–98 mV/div, ±10 V @ 100 mV/div–1 V/div; 1 MΩ: ±1 V @ 2–98 mV/div, ±10 V @ 100 mV/div–1 V/div, ±100 V @ 1.02 V/div–10 V/div			50 Ω: ±400 mV @ 2–4.95 mV/div, ±1 V @ 5–99 mV/div, ±10 V @ 100 mV–1 V/div 1 MΩ: ±400 mV @ 2–4.95 mV/div, ±1 V @ 5–99 mV/div, ±10 V @ 100 mV–1 V/div, ±100 V @ 1.02–10 V/div	

Input Connector ProBus/BNC

Timebase System

Timebases	Internal timebase common to all input channels; an external clock may be applied at the auxiliary input
Time/Division Range	Real time: 200 ps/div–10 s/div, RIS mode: 200 ps/div to 10 ns/div, Roll mode: up to 1,000 s/div
Clock Accuracy	≤ 5 ppm @ 25 °C (typical) (≤ 10 ppm @ 5–40 °C)
Sample Rate and Delay Time Accuracy	Equal to Clock Accuracy
Channel to Channel Deskew Range	±9 x time/div setting, 100 ms max., each channel
External Sample Clock	DC to 600 MHz; (DC to 1 GHz for 104Xi-A/104MXi-A and 204Xi-A/204MXi-A) 50 Ω, (limited BW in 1 MΩ), BNC input, limited to 2 Ch operation (1 Ch in 62Xi-A), (minimum rise time and amplitude requirements apply at low frequencies)
Roll Mode	User selectable at ≥ 500 ms/div and ≤ 100 kS/s

	44Xi-A 44MXi-A	64Xi-A 64MXi-A	62Xi-A	104Xi-A 104MXi-A	204Xi-A 204MXi-A
Acquisition System					
Single-Shot Sample Rate/Ch	5 GS/s				
Interleaved Sample Rate (2 Ch)	5 GS/s	10 GS/s	10 GS/s	10 GS/s	10 GS/s
Random Interleaved Sampling (RIS)	200 GS/s				
RIS Mode	User selectable from 200 ps/div to 10 ns/div			User selectable from 100 ps/div to 10 ns/div	
Trigger Rate (Maximum)	1,250,000 waveforms/second				
Sequence Time Stamp Resolution	1 ns				
Minimum Time Between Sequential Segments	800 ns				
Acquisition Memory Options	Max. Acquisition Points (4 Ch/2 Ch, 2 Ch/1 Ch in 62Xi-A)			Segments (Sequence Mode)	
Standard	12.5M/25M			10,000	

	44Xi-A 44MXi-A	64Xi-A 64MXi-A	62Xi-A	104Xi-A 104MXi-A	204Xi-A 204MXi-A
Acquisition Processing					
Time Resolution (min, Single-shot)	200 ps (5 GS/s)	100 ps (10 GS/s)	100 ps (10 GS/s)	100 ps (10 GS/s)	100 ps (10 GS/s)
Averaging	Summed and continuous averaging to 1 million sweeps				
ERES	From 8.5 to 11 bits vertical resolution				
Envelope (Extrema)	Envelope, floor, or roof for up to 1 million sweeps				
Interpolation	Linear or (Sinx)/x				

Trigger System

Trigger Modes	Normal, Auto, Single, Stop
Sources	Any input channel, External, Ext/10, or Line; slope and level unique to each source, except Line
Trigger Coupling	DC, AC (typically 7.5 Hz), HF Reject, LF Reject
Pre-trigger Delay	0–100% of memory size (adjustable in 1% increments, or 100 ns)
Post-trigger Delay	Up to 10,000 divisions in real time mode, limited at slower time/div settings in roll mode
Hold-off	1 ns to 20 s or 1 to 1,000,000,000 events

SPECIFICATIONS

Trigger System (cont'd)	WaveRunner 44Xi-A 44MXi-A	WaveRunner 64Xi-A 64MXi-A	WaveRunner 62Xi-A	WaveRunner 104Xi-A 104MXi-A	WaveRunner 204Xi-A 204MXi-A
Internal Trigger Level Range	±4.1 div from center (typical)				
Trigger and Interpolator Jitter	≤ 3 ps rms (typical)				
Trigger Sensitivity with Edge Trigger (Ch 1–4 + external, DC, AC, and LFrej coupling)	2 div @ < 400 MHz 1 div @ < 200 MHz	2 div @ < 600 MHz 1 div @ < 200 MHz	2 div @ < 600 MHz 1 div @ < 200 MHz	2 div @ < 1 GHz 1 div @ < 200 MHz	2 div @ < 2 GHz 1 div @ < 200 MHz
Max. Trigger Frequency with SMART Trigger™ (Ch 1–4 + external)	400 MHz @ ≥ 10 mV	600 MHz @ ≥ 10 mV	600 MHz @ ≥ 10 mV	1 GHz @ ≥ 10 mV	2 GHz @ ≥ 10 mV
External Trigger Range	EXT/10 ±4 V; EXT ±400 mV				

Basic Triggers

Edge	Triggers when signal meets slope (positive, negative, either, or Window) and level condition
TV-Composite Video	Triggers NTSC or PAL with selectable line and field; HDTV (720p, 1080i, 1080p) with selectable frame rate (50 or 60 Hz) and Line; or CUSTOM with selectable Fields (1–8), Lines (up to 2000), Frame Rates (25, 30, 50, or 60 Hz), Interlacing (1:1, 2:1, 4:1, 8:1), or Synch Pulse Slope (Positive or Negative)

SMART Triggers

State or Edge Qualified	Triggers on any input source only if a defined state or edge occurred on another input source. Delay between sources is selectable by time or events
Qualified First	In Sequence acquisition mode, triggers repeatedly on event B only if a defined pattern, state, or edge (event A) is satisfied in the first segment of the acquisition. Delay between sources is selectable by time or events
Dropout	Triggers if signal drops out for longer than selected time between 1 ns and 20 s.
Pattern	Logic combination (AND, NAND, OR, NOR) of 5 inputs (4 channels and external trigger input – 2 Ch+EXT on WaveRunner 62Xi-A). Each source can be high, low, or don't care. The High and Low level can be selected independently. Triggers at start or end of the pattern

SMART Triggers with Exclusion Technology

Glitch and Pulse Width	Triggers on positive or negative glitches with widths selectable from 500 ps to 20 s or on intermittent faults (subject to bandwidth limit of oscilloscope)
Signal or Pattern Interval	Triggers on intervals selectable between 1 ns and 20 s
Timeout (State/Edge Qualified)	Triggers on any source if a given state (or transition edge) has occurred on another source. Delay between sources is 1 ns to 20 s, or 1 to 99,999,999 events
Runt	Trigger on positive or negative runts defined by two voltage limits and two time limits. Select between 1 ns and 20 s
Slew Rate	Trigger on edge rates. Select limits for dV, dt, and slope. Select edge limits between 1 ns and 20 s
Exclusion Triggering	Trigger on intermittent faults by specifying the normal width or period

LeCroy WaveStream Fast Viewing Mode

Intensity	256 Intensity Levels, 1–100% adjustable via front panel control
Number of Channels	up to 4 simultaneously
Max Sampling Rate	5 GS/s (10 GS/s for WR 62Xi-A, 64Xi-A/64MXi-A, 104Xi-A/104MXi-A, 204Xi-A/204MXi-A in interleaved mode)
Waveforms/second (continuous)	Up to 20,000 waveforms/second
Operation	Front panel toggle between normal real-time mode and LeCroy WaveStream Fast Viewing mode

Automatic Setup

Auto Setup	Automatically sets timebase, trigger, and sensitivity to display a wide range of repetitive signals
Vertical Find Scale	Automatically sets the vertical sensitivity and offset for the selected channels to display a waveform with maximum dynamic range

Probes	44Xi-A 44MXi-A	64Xi-A 64MXi-A	62Xi-A	104Xi-A 104MXi-A	204Xi-A 204MXi-A
Probes	One Passive probe per channel; Optional passive and active probes available				
Probe System; ProBus	Automatically detects and supports a variety of compatible probes				
Scale Factors	Automatically or manually selected, depending on probe used				

Color Waveform Display

Type	Color 10.4" flat-panel TFT-LCD with high resolution touch screen
Resolution	SVGA; 800 x 600 pixels; maximum external monitor output resolution of 2048 x 1536 pixels
Number of Traces	Display a maximum of 8 traces. Simultaneously display channel, zoom, memory, and math traces
Grid Styles	Auto, Single, Dual, Quad, Octal, XY, Single + XY, Dual + XY
Waveform Styles	Sample dots joined or dots only in real-time mode

SPECIFICATIONS

Zoom Expansion Traces

Display up to 4 Zoom/Math traces with 16 bits/data point

Internal Waveform Memory

M1, M2, M3, M4 Internal Waveform Memory (store full-length waveform with 16 bits/data point) or store to any number of files limited only by data storage media

Setup Storage

Front Panel and Instrument Status Store to the internal hard drive, over the network, or to a USB-connected peripheral device

Interface

Remote Control	Via Windows Automation, or via LeCroy Remote Command Set
Network Communication Standard	VXI-11 or VICP, LXI Class C Compliant
GPIB Port (Accessory)	Supports IEEE – 488.2
Ethernet Port	10/100/1000Base-T Ethernet interface (RJ-45 connector)
USB Ports	5 USB 2.0 ports (one on front of instrument) supports Windows-compatible devices
External Monitor Port	Standard 15-pin D-Type SVGA-compatible DB-15; connect a second monitor to use extended desktop display mode with XGA resolution
Serial Port	DB-9 RS-232 port (not for remote oscilloscope control)

Auxiliary Input	44Xi-A 44MXi-A	64Xi-A 64MXi-A	62Xi-A	104Xi-A 104MXi-A	204Xi-A 204MXi-A
Signal Types	Selected from External Trigger or External Clock input on front panel				
Coupling	50 Ω: DC, 1 MΩ: AC, DC, GND				
Maximum Input Voltage	50 Ω: 5 V _{rms} , 1 MΩ: 400 V max. (DC + Peak AC ≤ 5 kHz)			50 Ω: 5 V _{rms} , 1 MΩ: 250 V max. (DC + Peak AC ≤ 10 kHz)	

Auxiliary Output

Signal Type	Trigger Enabled, Trigger Output, Pass/Fail, or Off
Output Level	TTL, ≈3.3 V
Connector Type	BNC, located on rear panel

General

Auto Calibration	Ensures specified DC and timing accuracy is maintained for 1 year minimum
Calibrator	Output available on front panel connector provides a variety of signals for probe calibration and compensation
Power Requirements	90–264 V _{rms} at 50/60 Hz; 115 V _{rms} (±10%) at 400 Hz, Automatic AC Voltage Selection Installation Category: 300 V CAT II; Max. Power Consumption: 340 VA/340 W; 290 VA/290 W for WaveRunner 62Xi-A

Environmental

Temperature: Operating	+5 °C to +40 °C
Temperature: Non-Operating	-20 °C to +60 °C
Humidity: Operating	Maximum relative humidity 80% for temperatures up to 31 °C decreasing linearly to 50% relative humidity at 40 °C
Humidity: Non-Operating	5% to 95% RH (non-condensing) as tested per MIL-PRF-28800F
Altitude: Operating	Up to 3,048 m (10,000 ft.) @ ≤ 25 °C
Altitude: Non-Operating	Up to 12,190 m (40,000 ft.)

Physical

Dimensions (HWD)	260 mm x 340 mm x 152 mm Excluding accessories and projections (10.25" x 13.4" x 6")
Net Weight	7.26 kg. (16.0 lbs.)

Certifications

CE Compliant, UL and cUL listed; Conforms to EN 61326, EN 61010-1, UL 61010-1 2nd Edition, and CSA C22.2 No. 61010-1-04

Warranty and Service

3-year warranty; calibration recommended annually. Optional service programs include extended warranty, upgrades, calibration, and customization services

ORDERING INFORMATION

Product Description

Product Code

WaveRunner Xi-A Series Oscilloscopes

2 GHz, 4 Ch, 5 GS/s, 12.5 Mpts/Ch (10 GS/s, 25 Mpts/Ch in interleaved mode) with 10.4" Color Touch Screen Display	WaveRunner 204Xi-A
1 GHz, 4 Ch, 5 GS/s, 12.5 Mpts/Ch (10 GS/s, 25 Mpts/Ch in interleaved mode) with 10.4" Color Touch Screen Display	WaveRunner 104Xi-A
600 MHz, 4 Ch, 5 GS/s, 12.5 Mpts/Ch (10 GS/s, 25 Mpts/Ch in interleaved mode) with 10.4" Color Touch Screen Display	WaveRunner 64Xi-A
600 MHz, 2 Ch, 5 GS/s, 12.5 Mpts/Ch (10 GS/s, 25 Mpts/Ch in interleaved mode) with 10.4" Color Touch Screen Display	WaveRunner 62Xi-A
400 MHz, 4 Ch, 5 GS/s, 12.5 Mpts/Ch (25 Mpts/Ch in interleaved mode) with 10.4" Color Touch Screen Display	WaveRunner 44Xi-A

WaveRunner MXi-A Series Oscilloscopes

2 GHz, 4 Ch, 5 GS/s, 12.5 Mpts/Ch (10 GS/s, 25 Mpts/Ch in Interleaved Mode) with 10.4" Color Touch Screen Display	WaveRunner 204MXi-A
1 GHz, 4 Ch, 5 GS/s, 12.5 Mpts/Ch (10 GS/s, 25 Mpts/Ch in Interleaved Mode) with 10.4" Color Touch Screen Display	WaveRunner 104MXi-A
600 MHz, 4 Ch, 5 GS/s, 12.5 Mpts/Ch (10 GS/s, 25 Mpts/Ch in Interleaved Mode) with 10.4" Color Touch Screen Display	WaveRunner 64MXi-A
400 MHz, 4 Ch, 5 GS/s, 12.5 Mpts/Ch (25 Mpts/Ch in Interleaved Mode) with 10.4" Color Touch Screen Display	WaveRunner 44MXi-A

Included with Standard Configuration

±10, 500 MHz, 10 MΩ Passive Probe (Total of 1 Per Channel)
Standard Ports; 10/100/1000Base-T Ethernet, USB 2.0 (5), SVGA Video out, Audio in/out, RS-232
Optical 3-button Wheel Mouse – USB 2.0
Protective Front Cover
Accessory Pouch
Getting Started Manual
Quick Reference Guide
Anti-virus Software (Trial Version)
Commercial NIST Traceable Calibration with Certificate
3-year Warranty

General Purpose Software Options

Statistics Software Package	WRXi-STAT
Master Analysis Software Package (Standard with MXi-A model oscilloscopes)	WRXi-XMAP
Advanced Math Software Package (Standard with MXi-A model oscilloscopes)	WRXi-XMATH
Intermediate Math Software Package (Standard with MXi-A model oscilloscopes)	WRXi-XWAV
Value Analysis Software Package (Includes XWAV and JTA2) (Standard with MXi-A model oscilloscopes)	WRXi-XVAP
Advanced Customization Software Package (Standard with MXi-A model oscilloscopes)	WRXi-XDEV
Spectrum Analyzer and Advanced FFT Option	WRXi-SPECTRUM
Processing Web Editor Software Package	WRXi-XWEB

Product Description

Product Code

Application Specific Software Options

Jitter and Timing Analysis Software Package (Standard with MXi-A model oscilloscopes)	WRXi-JTA2
Digital Filter Software Package	WRXi-DFP2
Disk Drive Measurement Software Package	WRXi-DDM2
PowerMeasure Analysis Software Package	WRXi-PMA2
Serial Data Mask Software Package	WRXi-SDM
QualiPHY Enabled Ethernet Software Option	QPHY-ENET*
QualiPHY Enabled USB 2.0 Software Option	QPHY-USB†
EMC Pulse Parameter Software Package	WRXi-EMC
Electrical Telecom Mask Test Package	ET-PMT

* TF-ENET-B required. † TF-USB-B required.

Serial Data Options

I ² C Trigger and Decode Option	WRXi-I2Cbus TD
SPI Trigger and Decode Option	WRXi-SPIbus TD
UART and RS-232 Trigger and Decode Option	WRXi-UART-RS232bus TD
LIN Trigger and Decode Option	WRXi-LINbus TD
CANbus TD Trigger and Decode Option	CANbus TD
CANbus TDM Trigger, Decode, and Measure/Graph Option	CANbus TDM
FlexRay Trigger and Decode Option	WRXi-FlexRaybus TD
FlexRay Trigger and Decode Physical Layer Test Option	WRXi-FlexRaybus TDP
Audiobus Trigger and Decode Option for I ² S, LJ, RJ, and TDM	WRXi-Audiobus TD
Audiobus Trigger, Decode, and Graph Option for I ² S LJ, RJ, and TDM	WRXi-Audiobus TDG
MIL-STD-1553 Trigger and Decode Option	WRXi-1553 TD

A variety of Vehicle Bus Analyzers based on the WaveRunner Xi-A platform are available. These units are equipped with a Symbolic CAN trigger and decode.

Mixed Signal Oscilloscope Options

500 MHz, 18 Ch, 2 GS/s, 50 Mpts/Ch Mixed Signal Oscilloscope Option	MS-500
250 MHz, 36 Ch, 1 GS/s, 25 Mpts/Ch (500 MHz, 18 Ch, 2 GS/s, 50 Mpts/Ch Interleaved) Mixed Signal Oscilloscope Option	MS-500-36
250 MHz, 18 Ch, 1 GS/s, 10 Mpts/Ch Mixed Signal Oscilloscope Option	MS-250

Probes and Amplifiers*

Set of 4 ZS1500, 1.5 GHz, 0.9 pF, 1 MΩ High Impedance Active Probe	ZS1500-QUADPAK
Set of 4 ZS1000, 1 GHz, 0.9 pF, 1 MΩ High Impedance Active Probe	ZS1000-QUADPAK
2.5 GHz, 0.7 pF Active Probe	HFP2500
1 GHz Active Differential Probe (±1, ±10, ±20)	AP034
500 MHz Active Differential Probe (x10, ±1, ±10, ±100)	AP033
30 A; 100 MHz Current Probe – AC/DC; 30 A _{rms} ; 50 A _{rms} Pulse	CP031
30 A; 50 MHz Current Probe – AC/DC; 30 A _{rms} ; 50 A _{rms} Pulse	CP030
30 A; 50 MHz Current Probe – AC/DC; 30 A _{rms} ; 50 A _{peak} Pulse	AP015
150 A; 10 MHz Current Probe – AC/DC; 150 A _{rms} ; 500 A _{peak} Pulse	CP150
500 A; 2 MHz Current Probe – AC/DC; 500 A _{rms} ; 700 A _{peak} Pulse	CP500
1,400 V, 100 MHz High-Voltage Differential Probe	ADP305
1,400 V, 20 MHz High-Voltage Differential Probe	ADP300
1 Ch, 100 MHz Differential Amplifier	DA1855A

*A wide variety of other passive, active, and differential probes are also available. Consult LeCroy for more information.

ORDERING INFORMATION

Product Description

Product Code

Hardware Accessories*

10/100/1000Base-T Compliance Test Fixture	TF-ENET-B†
USB 2.0 Compliance Test Fixture	TF-USB-B
External GPIB Interface	WS-GPIB
Soft Carrying Case	WRXi-SOFTCASE
Hard Transit Case	WRXi-HARDCASE
Mounting Stand – Desktop Clamp Style	WRXi-MS-CLAMP
Rackmount Kit	WRXi-RACK
Mini Keyboard	WRXi-KYBD
Removable Hard Drive Package (Includes removeable hard drive kit and two hard drives)	WRXi-A-RHD
Additional Removable Hard Drive	WRXi-A-RHD-02

* A variety of local language front panel overlays are also available.

† Includes ENET-2CAB-SMA018 and ENET-2ADA-BNCSMA.

Customer Service

LeCroy oscilloscopes and probes are designed, built, and tested to ensure high reliability. In the unlikely event you experience difficulties, our digital oscilloscopes are fully warranted for three years, and our probes are warranted for one year.

This warranty includes:

- No charge for return shipping
- Long-term 7-year support
- Upgrade to latest software at no charge



1-800-5-LeCroy
www.lecroy.com

Local sales offices are located throughout the world.
Visit our website to find the most convenient location.