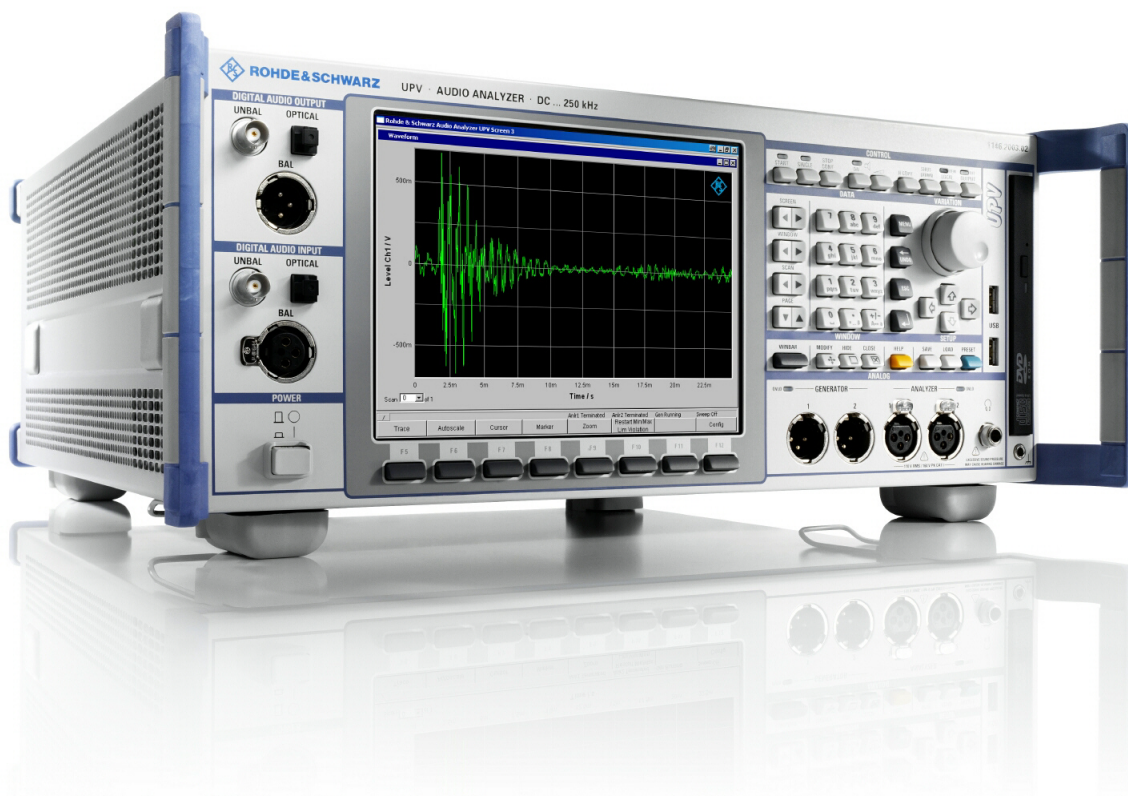


R&S®UPV

Audio Analyzer

Operating Manual



1146.2084.32 – 13

This user manual describes the Audio Analyzers

- R&S®UPV
- R&S®UPV66

© 2015 Rohde & Schwarz GmbH & Co. KG

Mühlhofstr. 15, 81671 München, Germany

Phone: +49 89 41 29 - 0

Fax: +49 89 41 29 12 164

Email: info@rohde-schwarz.com

Internet: www.rohde-schwarz.com

Subject to change – Data without tolerance limits is not binding.

R&S® is a registered trademark of Rohde & Schwarz GmbH & Co. KG.

Trade names are trademarks of the owners.

The following abbreviations are used throughout this manual: R&S®UPV is abbreviated as R&S UPV. Dolby ist ein eingetragenes Warenzeichen von Dolby Laboratories.

Basic Safety Instructions

Always read through and comply with the following safety instructions!

All plants and locations of the Rohde & Schwarz group of companies make every effort to keep the safety standards of our products up to date and to offer our customers the highest possible degree of safety. Our products and the auxiliary equipment they require are designed, built and tested in accordance with the safety standards that apply in each case. Compliance with these standards is continuously monitored by our quality assurance system. The product described here has been designed, built and tested in accordance with the EC Certificate of Conformity and has left the manufacturer's plant in a condition fully complying with safety standards. To maintain this condition and to ensure safe operation, you must observe all instructions and warnings provided in this manual. If you have any questions regarding these safety instructions, the Rohde & Schwarz group of companies will be happy to answer them.

Furthermore, it is your responsibility to use the product in an appropriate manner. This product is designed for use solely in industrial and laboratory environments or, if expressly permitted, also in the field and must not be used in any way that may cause personal injury or property damage. You are responsible if the product is used for any purpose other than its designated purpose or in disregard of the manufacturer's instructions. The manufacturer shall assume no responsibility for such use of the product.

The product is used for its designated purpose if it is used in accordance with its product documentation and within its performance limits (see data sheet, documentation, the following safety instructions). Using the product requires technical skills and, in some cases, a basic knowledge of English. It is therefore essential that only skilled and specialized staff or thoroughly trained personnel with the required skills be allowed to use the product. If personal safety gear is required for using Rohde & Schwarz products, this will be indicated at the appropriate place in the product documentation. Keep the basic safety instructions and the product documentation in a safe place and pass them on to the subsequent users.

Observing the safety instructions will help prevent personal injury or damage of any kind caused by dangerous situations. Therefore, carefully read through and adhere to the following safety instructions before and when using the product. It is also absolutely essential to observe the additional safety instructions on personal safety, for example, that appear in relevant parts of the product documentation. In these safety instructions, the word "product" refers to all merchandise sold and distributed by the Rohde & Schwarz group of companies, including instruments, systems and all accessories. For product-specific information, see the data sheet and the product documentation.

Safety labels on products

The following safety labels are used on products to warn against risks and dangers.

Symbol	Meaning	Symbol	Meaning
	Notice, general danger location Observe product documentation		ON/OFF Power
	Caution when handling heavy equipment		Standby indication
	Danger of electric shock		Direct current (DC)

Basic Safety Instructions

Symbol	Meaning	Symbol	Meaning
	Caution ! Hot surface		Alternating current (AC)
	Protective conductor terminal To identify any terminal which is intended for connection to an external conductor for protection against electric shock in case of a fault, or the terminal of a protective earth		Direct/alternating current (DC/AC)
	Earth (Ground)		Class II Equipment to identify equipment meeting the safety requirements specified for Class II equipment (device protected by double or reinforced insulation)
	Frame or chassis Ground terminal		EU labeling for batteries and accumulators For additional information, see section "Waste disposal/Environmental protection", item 1.
	Be careful when handling electrostatic sensitive devices		EU labeling for separate collection of electrical and electronic devices For additional information, see section "Waste disposal/Environmental protection", item 2.
	Warning! Laser radiation For additional information, see section "Operation", item 7.		

Signal words and their meaning

The following signal words are used in the product documentation in order to warn the reader about risks and dangers.



Indicates a hazardous situation which, if not avoided, will result in death or serious injury.



Indicates a hazardous situation which, if not avoided, could result in death or serious injury.



Indicates a hazardous situation which, if not avoided, could result in minor or moderate injury.



Indicates information considered important, but not hazard-related, e.g. messages relating to property damage.

In the product documentation, the word ATTENTION is used synonymously.

These signal words are in accordance with the standard definition for civil applications in the European Economic Area. Definitions that deviate from the standard definition may also exist in other economic areas or military applications. It is therefore essential to make sure that the signal words described here are always used only in connection with the related product documentation and the related product. The use of signal words in connection with unrelated products or documentation can result in misinterpretation and in personal injury or material damage.

Basic Safety Instructions

Operating states and operating positions

The product may be operated only under the operating conditions and in the positions specified by the manufacturer, without the product's ventilation being obstructed. If the manufacturer's specifications are not observed, this can result in electric shock, fire and/or serious personal injury or death. Applicable local or national safety regulations and rules for the prevention of accidents must be observed in all work performed.

1. Unless otherwise specified, the following requirements apply to Rohde & Schwarz products: predefined operating position is always with the housing floor facing down, IP protection 2X, use only indoors, max. operating altitude 2000 m above sea level, max. transport altitude 4500 m above sea level. A tolerance of $\pm 10\%$ shall apply to the nominal voltage and $\pm 5\%$ to the nominal frequency, overvoltage category 2, pollution degree 2.
2. Do not place the product on surfaces, vehicles, cabinets or tables that for reasons of weight or stability are unsuitable for this purpose. Always follow the manufacturer's installation instructions when installing the product and fastening it to objects or structures (e.g. walls and shelves). An installation that is not carried out as described in the product documentation could result in personal injury or even death.
3. Do not place the product on heat-generating devices such as radiators or fan heaters. The ambient temperature must not exceed the maximum temperature specified in the product documentation or in the data sheet. Product overheating can cause electric shock, fire and/or serious personal injury or even death.

Electrical safety

If the information on electrical safety is not observed either at all or to the extent necessary, electric shock, fire and/or serious personal injury or death may occur.

1. Prior to switching on the product, always ensure that the nominal voltage setting on the product matches the nominal voltage of the mains-supply network. If a different voltage is to be set, the power fuse of the product may have to be changed accordingly.
2. In the case of products of safety class I with movable power cord and connector, operation is permitted only on sockets with a protective conductor contact and protective conductor.
3. Intentionally breaking the protective conductor either in the feed line or in the product itself is not permitted. Doing so can result in the danger of an electric shock from the product. If extension cords or connector strips are implemented, they must be checked on a regular basis to ensure that they are safe to use.
4. If there is no power switch for disconnecting the product from the mains, or if the power switch is not suitable for this purpose, use the plug of the connecting cable to disconnect the product from the mains. In such cases, always ensure that the power plug is easily reachable and accessible at all times. For example, if the power plug is the disconnecting device, the length of the connecting cable must not exceed 3 m. Functional or electronic switches are not suitable for providing disconnection from the AC supply network. If products without power switches are integrated into racks or systems, the disconnecting device must be provided at the system level.
5. Never use the product if the power cable is damaged. Check the power cables on a regular basis to ensure that they are in proper operating condition. By taking appropriate safety measures and carefully laying the power cable, ensure that the cable cannot be damaged and that no one can be hurt by, for example, tripping over the cable or suffering an electric shock.

Basic Safety Instructions

6. The product may be operated only from TN/TT supply networks fuse-protected with max. 16 A (higher fuse only after consulting with the Rohde & Schwarz group of companies).
7. Do not insert the plug into sockets that are dusty or dirty. Insert the plug firmly and all the way into the socket provided for this purpose. Otherwise, sparks that result in fire and/or injuries may occur.
8. Do not overload any sockets, extension cords or connector strips; doing so can cause fire or electric shocks.
9. For measurements in circuits with voltages $V_{rms} > 30$ V, suitable measures (e.g. appropriate measuring equipment, fuse protection, current limiting, electrical separation, insulation) should be taken to avoid any hazards.
10. Ensure that the connections with information technology equipment, e.g. PCs or other industrial computers, comply with the IEC 60950-1 / EN 60950-1 or IEC 61010-1 / EN 61010-1 standards that apply in each case.
11. Unless expressly permitted, never remove the cover or any part of the housing while the product is in operation. Doing so will expose circuits and components and can lead to injuries, fire or damage to the product.
12. If a product is to be permanently installed, the connection between the protective conductor terminal on site and the product's protective conductor must be made first before any other connection is made. The product may be installed and connected only by a licensed electrician.
13. For permanently installed equipment without built-in fuses, circuit breakers or similar protective devices, the supply circuit must be fuse-protected in such a way that anyone who has access to the product, as well as the product itself, is adequately protected from injury or damage.
14. Use suitable overvoltage protection to ensure that no overvoltage (such as that caused by a bolt of lightning) can reach the product. Otherwise, the person operating the product will be exposed to the danger of an electric shock.
15. Any object that is not designed to be placed in the openings of the housing must not be used for this purpose. Doing so can cause short circuits inside the product and/or electric shocks, fire or injuries.
16. Unless specified otherwise, products are not liquid-proof (see also section "Operating states and operating positions", item 1). Therefore, the equipment must be protected against penetration by liquids. If the necessary precautions are not taken, the user may suffer electric shock or the product itself may be damaged, which can also lead to personal injury.
17. Never use the product under conditions in which condensation has formed or can form in or on the product, e.g. if the product has been moved from a cold to a warm environment. Penetration by water increases the risk of electric shock.
18. Prior to cleaning the product, disconnect it completely from the power supply (e.g. AC supply network or battery). Use a soft, non-linting cloth to clean the product. Never use chemical cleaning agents such as alcohol, acetone or diluents for cellulose lacquers.

Operation

1. Operating the products requires special training and intense concentration. Make sure that persons who use the products are physically, mentally and emotionally fit enough to do so; otherwise, injuries or material damage may occur. It is the responsibility of the employer/operator to select suitable personnel for operating the products.

Basic Safety Instructions

2. Before you move or transport the product, read and observe the section titled "Transport".
3. As with all industrially manufactured goods, the use of substances that induce an allergic reaction (allergens) such as nickel cannot be generally excluded. If you develop an allergic reaction (such as a skin rash, frequent sneezing, red eyes or respiratory difficulties) when using a Rohde & Schwarz product, consult a physician immediately to determine the cause and to prevent health problems or stress.
4. Before you start processing the product mechanically and/or thermally, or before you take it apart, be sure to read and pay special attention to the section titled "Waste disposal/Environmental protection", item 1.
5. Depending on the function, certain products such as RF radio equipment can produce an elevated level of electromagnetic radiation. Considering that unborn babies require increased protection, pregnant women must be protected by appropriate measures. Persons with pacemakers may also be exposed to risks from electromagnetic radiation. The employer/operator must evaluate workplaces where there is a special risk of exposure to radiation and, if necessary, take measures to avert the potential danger.
6. Should a fire occur, the product may release hazardous substances (gases, fluids, etc.) that can cause health problems. Therefore, suitable measures must be taken, e.g. protective masks and protective clothing must be worn.
7. Laser products are given warning labels that are standardized according to their laser class. Lasers can cause biological harm due to the properties of their radiation and due to their extremely concentrated electromagnetic power. If a laser product (e.g. a CD/DVD drive) is integrated into a Rohde & Schwarz product, absolutely no other settings or functions may be used as described in the product documentation. The objective is to prevent personal injury (e.g. due to laser beams).
8. EMC classes (in line with EN 55011/CISPR 11, and analogously with EN 55022/CISPR 22, EN 55032/CISPR 32)
 - Class A equipment:
Equipment suitable for use in all environments except residential environments and environments that are directly connected to a low-voltage supply network that supplies residential buildings
Note: Class A equipment is intended for use in an industrial environment. This equipment may cause radio disturbances in residential environments, due to possible conducted as well as radiated disturbances. In this case, the operator may be required to take appropriate measures to eliminate these disturbances.
 - Class B equipment:
Equipment suitable for use in residential environments and environments that are directly connected to a low-voltage supply network that supplies residential buildings

Repair and service

1. The product may be opened only by authorized, specially trained personnel. Before any work is performed on the product or before the product is opened, it must be disconnected from the AC supply network. Otherwise, personnel will be exposed to the risk of an electric shock.

Basic Safety Instructions

- Adjustments, replacement of parts, maintenance and repair may be performed only by electrical experts authorized by Rohde & Schwarz. Only original parts may be used for replacing parts relevant to safety (e.g. power switches, power transformers, fuses). A safety test must always be performed after parts relevant to safety have been replaced (visual inspection, protective conductor test, insulation resistance measurement, leakage current measurement, functional test). This helps ensure the continued safety of the product.

Batteries and rechargeable batteries/cells

If the information regarding batteries and rechargeable batteries/cells is not observed either at all or to the extent necessary, product users may be exposed to the risk of explosions, fire and/or serious personal injury, and, in some cases, death. Batteries and rechargeable batteries with alkaline electrolytes (e.g. lithium cells) must be handled in accordance with the EN 62133 standard.

- Cells must not be taken apart or crushed.
- Cells or batteries must not be exposed to heat or fire. Storage in direct sunlight must be avoided. Keep cells and batteries clean and dry. Clean soiled connectors using a dry, clean cloth.
- Cells or batteries must not be short-circuited. Cells or batteries must not be stored in a box or in a drawer where they can short-circuit each other, or where they can be short-circuited by other conductive materials. Cells and batteries must not be removed from their original packaging until they are ready to be used.
- Cells and batteries must not be exposed to any mechanical shocks that are stronger than permitted.
- If a cell develops a leak, the fluid must not be allowed to come into contact with the skin or eyes. If contact occurs, wash the affected area with plenty of water and seek medical aid.
- Improperly replacing or charging cells or batteries that contain alkaline electrolytes (e.g. lithium cells) can cause explosions. Replace cells or batteries only with the matching Rohde & Schwarz type (see parts list) in order to ensure the safety of the product.
- Cells and batteries must be recycled and kept separate from residual waste. Rechargeable batteries and normal batteries that contain lead, mercury or cadmium are hazardous waste. Observe the national regulations regarding waste disposal and recycling.

Transport

- The product may be very heavy. Therefore, the product must be handled with care. In some cases, the user may require a suitable means of lifting or moving the product (e.g. with a lift-truck) to avoid back or other physical injuries.
- Handles on the products are designed exclusively to enable personnel to transport the product. It is therefore not permissible to use handles to fasten the product to or on transport equipment such as cranes, fork lifts, wagons, etc. The user is responsible for securely fastening the products to or on the means of transport or lifting. Observe the safety regulations of the manufacturer of the means of transport or lifting. Noncompliance can result in personal injury or material damage.
- If you use the product in a vehicle, it is the sole responsibility of the driver to drive the vehicle safely and properly. The manufacturer assumes no responsibility for accidents or collisions. Never use the product in a moving vehicle if doing so could distract the driver of the vehicle. Adequately secure the product in the vehicle to prevent injuries or other damage in the event of an accident.

Instrucciones de seguridad elementales

Waste disposal/Environmental protection

1. Specially marked equipment has a battery or accumulator that must not be disposed of with unsorted municipal waste, but must be collected separately. It may only be disposed of at a suitable collection point or via a Rohde & Schwarz customer service center.
2. Waste electrical and electronic equipment must not be disposed of with unsorted municipal waste, but must be collected separately.
Rohde & Schwarz GmbH & Co. KG has developed a disposal concept and takes full responsibility for take-back obligations and disposal obligations for manufacturers within the EU. Contact your Rohde & Schwarz customer service center for environmentally responsible disposal of the product.
3. If products or their components are mechanically and/or thermally processed in a manner that goes beyond their intended use, hazardous substances (heavy-metal dust such as lead, beryllium, nickel) may be released. For this reason, the product may only be disassembled by specially trained personnel. Improper disassembly may be hazardous to your health. National waste disposal regulations must be observed.
4. If handling the product releases hazardous substances or fuels that must be disposed of in a special way, e.g. coolants or engine oils that must be replenished regularly, the safety instructions of the manufacturer of the hazardous substances or fuels and the applicable regional waste disposal regulations must be observed. Also observe the relevant safety instructions in the product documentation. The improper disposal of hazardous substances or fuels can cause health problems and lead to environmental damage.

For additional information about environmental protection, visit the Rohde & Schwarz website.

Instrucciones de seguridad elementales

¡Es imprescindible leer y cumplir las siguientes instrucciones e informaciones de seguridad!

El principio del grupo de empresas Rohde & Schwarz consiste en tener nuestros productos siempre al día con los estándares de seguridad y de ofrecer a nuestros clientes el máximo grado de seguridad. Nuestros productos y todos los equipos adicionales son siempre fabricados y examinados según las normas de seguridad vigentes. Nuestro sistema de garantía de calidad controla constantemente que sean cumplidas estas normas. El presente producto ha sido fabricado y examinado según el certificado de conformidad de la UE y ha salido de nuestra planta en estado impecable según los estándares técnicos de seguridad. Para poder preservar este estado y garantizar un funcionamiento libre de peligros, el usuario deberá atenerse a todas las indicaciones, informaciones de seguridad y notas de alerta. El grupo de empresas Rohde & Schwarz está siempre a su disposición en caso de que tengan preguntas referentes a estas informaciones de seguridad.

Además queda en la responsabilidad del usuario utilizar el producto en la forma debida. Este producto está destinado exclusivamente al uso en la industria y el laboratorio o, si ha sido expresamente autorizado, para aplicaciones de campo y de ninguna manera deberá ser utilizado de modo que alguna persona/cosa pueda sufrir daño. El uso del producto fuera de sus fines definidos o sin tener en cuenta las instrucciones del fabricante queda en la responsabilidad del usuario. El fabricante no se hace en ninguna forma responsable de consecuencias a causa del mal uso del producto.















Instrucciones de seguridad elementales

Se parte del uso correcto del producto para los fines definidos si el producto es utilizado conforme a las indicaciones de la correspondiente documentación del producto y dentro del margen de rendimiento definido (ver hoja de datos, documentación, informaciones de seguridad que siguen). El uso del producto hace necesarios conocimientos técnicos y ciertos conocimientos del idioma inglés. Por eso se debe tener en cuenta que el producto solo pueda ser operado por personal especializado o personas instruidas en profundidad con las capacidades correspondientes. Si fuera necesaria indumentaria de seguridad para el uso de productos de Rohde & Schwarz, encontraría la información debida en la documentación del producto en el capítulo correspondiente. Guarde bien las informaciones de seguridad elementales, así como la documentación del producto, y entréguelas a usuarios posteriores.

Tener en cuenta las informaciones de seguridad sirve para evitar en lo posible lesiones o daños por peligros de toda clase. Por eso es imprescindible leer detalladamente y comprender por completo las siguientes informaciones de seguridad antes de usar el producto, y respetarlas durante el uso del producto. Deberán tenerse en cuenta todas las demás informaciones de seguridad, como p. ej. las referentes a la protección de personas, que encontrarán en el capítulo correspondiente de la documentación del producto y que también son de obligado cumplimiento. En las presentes informaciones de seguridad se recogen todos los objetos que distribuye el grupo de empresas Rohde & Schwarz bajo la denominación de "producto", entre ellos también aparatos, instalaciones así como toda clase de accesorios. Los datos específicos del producto figuran en la hoja de datos y en la documentación del producto.

Señalización de seguridad de los productos

Las siguientes señales de seguridad se utilizan en los productos para advertir sobre riesgos y peligros.

Símbolo	Significado	Símbolo	Significado
	Aviso: punto de peligro general Observar la documentación del producto		Tensión de alimentación de PUESTA EN MARCHA / PARADA
	Atención en el manejo de dispositivos de peso elevado		Indicación de estado de espera (standby)
	Peligro de choque eléctrico		Corriente continua (DC)
	Advertencia: superficie caliente		Corriente alterna (AC)
	Conexión a conductor de protección		Corriente continua / Corriente alterna (DC/AC)
	Conexión a tierra		El aparato está protegido en su totalidad por un aislamiento doble (reforzado)
	Conexión a masa		Distintivo de la UE para baterías y acumuladores Más información en la sección "Eliminación/protección del medio ambiente", punto 1.

Instrucciones de seguridad elementales

Símbolo	Significado	Símbolo	Significado
	Aviso: Cuidado en el manejo de dispositivos sensibles a la electrostática (ESD)		Distintivo de la UE para la eliminación por separado de dispositivos eléctricos y electrónicos Más información en la sección "Eliminación/protección del medio ambiente", punto 2.
	Advertencia: rayo láser Más información en la sección "Funcionamiento", punto 7.		

Palabras de señal y su significado

En la documentación del producto se utilizan las siguientes palabras de señal con el fin de advertir contra riesgos y peligros.



Indica una situación de peligro que, si no se evita, causa lesiones graves o incluso la muerte.



Indica una situación de peligro que, si no se evita, puede causar lesiones graves o incluso la muerte.



Indica una situación de peligro que, si no se evita, puede causar lesiones leves o moderadas.



Indica información que se considera importante, pero no en relación con situaciones de peligro; p. ej., avisos sobre posibles daños materiales.

En la documentación del producto se emplea de forma sinónima el término CUIDADO.

Las palabras de señal corresponden a la definición habitual para aplicaciones civiles en el área económica europea. Pueden existir definiciones diferentes a esta definición en otras áreas económicas o en aplicaciones militares. Por eso se deberá tener en cuenta que las palabras de señal aquí descritas sean utilizadas siempre solamente en combinación con la correspondiente documentación del producto y solamente en combinación con el producto correspondiente. La utilización de las palabras de señal en combinación con productos o documentaciones que no les correspondan puede llevar a interpretaciones equivocadas y tener por consecuencia daños en personas u objetos.

Estados operativos y posiciones de funcionamiento

El producto solamente debe ser utilizado según lo indicado por el fabricante respecto a los estados operativos y posiciones de funcionamiento sin que se obstruya la ventilación. Si no se siguen las indicaciones del fabricante, pueden producirse choques eléctricos, incendios y/o lesiones graves con posible consecuencia de muerte. En todos los trabajos deberán ser tenidas en cuenta las normas nacionales y locales de seguridad del trabajo y de prevención de accidentes.

Instrucciones de seguridad elementales

1. Si no se convino de otra manera, es para los productos Rohde & Schwarz válido lo que sigue: como posición de funcionamiento se define por principio la posición con el suelo de la caja para abajo, modo de protección IP 2X, uso solamente en estancias interiores, utilización hasta 2000 m sobre el nivel del mar, transporte hasta 4500 m sobre el nivel del mar. Se aplicará una tolerancia de $\pm 10\%$ sobre el voltaje nominal y de $\pm 5\%$ sobre la frecuencia nominal. Categoría de sobrecarga eléctrica 2, índice de suciedad 2.
2. No sitúe el producto encima de superficies, vehículos, estantes o mesas, que por sus características de peso o de estabilidad no sean aptos para él. Siga siempre las instrucciones de instalación del fabricante cuando instale y asegure el producto en objetos o estructuras (p. ej. paredes y estantes). Si se realiza la instalación de modo distinto al indicado en la documentación del producto, se pueden causar lesiones o, en determinadas circunstancias, incluso la muerte.
3. No ponga el producto sobre aparatos que generen calor (p. ej. radiadores o calefactores). La temperatura ambiente no debe superar la temperatura máxima especificada en la documentación del producto o en la hoja de datos. En caso de sobrecalentamiento del producto, pueden producirse choques eléctricos, incendios y/o lesiones graves con posible consecuencia de muerte.

Seguridad eléctrica

Si no se siguen (o se siguen de modo insuficiente) las indicaciones del fabricante en cuanto a seguridad eléctrica, pueden producirse choques eléctricos, incendios y/o lesiones graves con posible consecuencia de muerte.

1. Antes de la puesta en marcha del producto se deberá comprobar siempre que la tensión preseleccionada en el producto coincida con la de la red de alimentación eléctrica. Si es necesario modificar el ajuste de tensión, también se deberán cambiar en caso dado los fusibles correspondientes del producto.
2. Los productos de la clase de protección I con alimentación móvil y enchufe individual solamente podrán enchufarse a tomas de corriente con contacto de seguridad y con conductor de protección conectado.
3. Queda prohibida la interrupción intencionada del conductor de protección, tanto en la toma de corriente como en el mismo producto. La interrupción puede tener como consecuencia el riesgo de que el producto sea fuente de choques eléctricos. Si se utilizan cables alargadores o regletas de enchufe, deberá garantizarse la realización de un examen regular de los mismos en cuanto a su estado técnico de seguridad.
4. Si el producto no está equipado con un interruptor para desconectarlo de la red, o bien si el interruptor existente no resulta apropiado para la desconexión de la red, el enchufe del cable de conexión se deberá considerar como un dispositivo de desconexión. El dispositivo de desconexión se debe poder alcanzar fácilmente y debe estar siempre bien accesible. Si, p. ej., el enchufe de conexión a la red es el dispositivo de desconexión, la longitud del cable de conexión no debe superar 3 m). Los interruptores selectores o electrónicos no son aptos para el corte de la red eléctrica. Si se integran productos sin interruptor en bastidores o instalaciones, se deberá colocar el interruptor en el nivel de la instalación.
5. No utilice nunca el producto si está dañado el cable de conexión a red. Compruebe regularmente el correcto estado de los cables de conexión a red. Asegúrese, mediante las medidas de protección y de instalación adecuadas, de que el cable de conexión a red no pueda ser dañado o de que nadie pueda ser dañado por él, p. ej. al tropezar o por un choque eléctrico.

Instrucciones de seguridad elementales

6. Solamente está permitido el funcionamiento en redes de alimentación TN/TT aseguradas con fusibles de 16 A como máximo (utilización de fusibles de mayor amperaje solo previa consulta con el grupo de empresas Rohde & Schwarz).
7. Nunca conecte el enchufe en tomas de corriente sucias o llenas de polvo. Introduzca el enchufe por completo y fuertemente en la toma de corriente. La no observación de estas medidas puede provocar chispas, fuego y/o lesiones.
8. No sobrecargue las tomas de corriente, los cables alargadores o las regletas de enchufe ya que esto podría causar fuego o choques eléctricos.
9. En las mediciones en circuitos de corriente con una tensión $U_{\text{eff}} > 30 \text{ V}$ se deberán tomar las medidas apropiadas para impedir cualquier peligro (p. ej. medios de medición adecuados, seguros, limitación de tensión, corte protector, aislamiento etc.).
10. Para la conexión con dispositivos informáticos como un PC o un ordenador industrial, debe comprobarse que éstos cumplan los estándares IEC60950-1/EN60950-1 o IEC61010-1/EN 61010-1 válidos en cada caso.
11. A menos que esté permitido expresamente, no retire nunca la tapa ni componentes de la carcasa mientras el producto esté en servicio. Esto pone a descubierto los cables y componentes eléctricos y puede causar lesiones, fuego o daños en el producto.
12. Si un producto se instala en un lugar fijo, se deberá primero conectar el conductor de protección fijo con el conductor de protección del producto antes de hacer cualquier otra conexión. La instalación y la conexión deberán ser efectuadas por un electricista especializado.
13. En el caso de dispositivos fijos que no estén provistos de fusibles, interruptor automático ni otros mecanismos de seguridad similares, el circuito de alimentación debe estar protegido de modo que todas las personas que puedan acceder al producto, así como el producto mismo, estén a salvo de posibles daños.
14. Todo producto debe estar protegido contra sobretensión (debida p. ej. a una caída del rayo) mediante los correspondientes sistemas de protección. Si no, el personal que lo utilice quedará expuesto al peligro de choque eléctrico.
15. No debe introducirse en los orificios de la caja del aparato ningún objeto que no esté destinado a ello. Esto puede producir cortocircuitos en el producto y/o puede causar choques eléctricos, fuego o lesiones.
16. Salvo indicación contraria, los productos no están impermeabilizados (ver también el capítulo "Estados operativos y posiciones de funcionamiento", punto 1). Por eso es necesario tomar las medidas necesarias para evitar la entrada de líquidos. En caso contrario, existe peligro de choque eléctrico para el usuario o de daños en el producto, que también pueden redundar en peligro para las personas.
17. No utilice el producto en condiciones en las que pueda producirse o ya se hayan producido condensaciones sobre el producto o en el interior de éste, como p. ej. al desplazarlo de un lugar frío a otro caliente. La entrada de agua aumenta el riesgo de choque eléctrico.
18. Antes de la limpieza, desconecte por completo el producto de la alimentación de tensión (p. ej. red de alimentación o batería). Realice la limpieza de los aparatos con un paño suave, que no se deshilache. No utilice bajo ningún concepto productos de limpieza químicos como alcohol, acetona o diluyentes para lacas nitrocelulósicas.

Instrucciones de seguridad elementales

Funcionamiento

1. El uso del producto requiere instrucciones especiales y una alta concentración durante el manejo. Debe asegurarse que las personas que manejen el producto estén a la altura de los requerimientos necesarios en cuanto a aptitudes físicas, psíquicas y emocionales, ya que de otra manera no se pueden excluir lesiones o daños de objetos. El empresario u operador es responsable de seleccionar el personal usuario apto para el manejo del producto.
2. Antes de desplazar o transportar el producto, lea y tenga en cuenta el capítulo "Transporte".
3. Como con todo producto de fabricación industrial no puede quedar excluida en general la posibilidad de que se produzcan alergias provocadas por algunos materiales empleados —los llamados alérgenos (p. ej. el níquel)—. Si durante el manejo de productos Rohde & Schwarz se producen reacciones alérgicas, como p. ej. irritaciones cutáneas, estornudos continuos, enrojecimiento de la conjuntiva o dificultades respiratorias, debe avisarse inmediatamente a un médico para investigar las causas y evitar cualquier molestia o daño a la salud.
4. Antes de la manipulación mecánica y/o térmica o el desmontaje del producto, debe tenerse en cuenta imprescindiblemente el capítulo "Eliminación/protección del medio ambiente", punto 1.
5. Ciertos productos, como p. ej. las instalaciones de radiocomunicación RF, pueden a causa de su función natural, emitir una radiación electromagnética aumentada. Deben tomarse todas las medidas necesarias para la protección de las mujeres embarazadas. También las personas con marcapasos pueden correr peligro a causa de la radiación electromagnética. El empresario/operador tiene la obligación de evaluar y señalar las áreas de trabajo en las que exista un riesgo elevado de exposición a radiaciones.
6. Tenga en cuenta que en caso de incendio pueden desprenderse del producto sustancias tóxicas (gases, líquidos etc.) que pueden generar daños a la salud. Por eso, en caso de incendio deben usarse medidas adecuadas, como p. ej. máscaras antigás e indumentaria de protección.
7. Los productos con láser están provistos de indicaciones de advertencia normalizadas en función de la clase de láser del que se trate. Los rayos láser pueden provocar daños de tipo biológico a causa de las propiedades de su radiación y debido a su concentración extrema de potencia electromagnética. En caso de que un producto Rohde & Schwarz contenga un producto láser (p. ej. un lector de CD/DVD), no debe usarse ninguna otra configuración o función aparte de las descritas en la documentación del producto, a fin de evitar lesiones (p. ej. debidas a irradiación láser).
8. Clases de compatibilidad electromagnética (conforme a EN 55011 / CISPR 11; y en analogía con EN 55022 / CISPR 22, EN 55032 / CISPR 32)
 - Aparato de clase A:
Aparato adecuado para su uso en todos los entornos excepto en los residenciales y en aquellos conectados directamente a una red de distribución de baja tensión que suministra corriente a edificios residenciales.
Nota: Los aparatos de clase A están destinados al uso en entornos industriales. Estos aparatos pueden causar perturbaciones radioeléctricas en entornos residenciales debido a posibles perturbaciones guiadas o radiadas. En este caso, se le podrá solicitar al operador que tome las medidas adecuadas para eliminar estas perturbaciones.
 - Aparato de clase B:
Aparato adecuado para su uso en entornos residenciales, así como en aquellos conectados directamente a una red de distribución de baja tensión que suministra corriente a edificios residenciales.

Instrucciones de seguridad elementales

Reparación y mantenimiento

1. El producto solamente debe ser abierto por personal especializado con autorización para ello. Antes de manipular el producto o abrirlo, es obligatorio desconectarlo de la tensión de alimentación, para evitar toda posibilidad de choque eléctrico.
2. El ajuste, el cambio de partes, el mantenimiento y la reparación deberán ser efectuadas solamente por electricistas autorizados por Rohde & Schwarz. Si se reponen partes con importancia para los aspectos de seguridad (p. ej. el enchufe, los transformadores o los fusibles), solamente podrán ser sustituidos por partes originales. Después de cada cambio de partes relevantes para la seguridad deberá realizarse un control de seguridad (control a primera vista, control del conductor de protección, medición de resistencia de aislamiento, medición de la corriente de fuga, control de funcionamiento). Con esto queda garantizada la seguridad del producto.

Baterías y acumuladores o celdas

Si no se siguen (o se siguen de modo insuficiente) las indicaciones en cuanto a las baterías y acumuladores o celdas, pueden producirse explosiones, incendios y/o lesiones graves con posible consecuencia de muerte. El manejo de baterías y acumuladores con electrolitos alcalinos (p. ej. celdas de litio) debe seguir el estándar EN 62133.

1. No deben desmontarse, abrirse ni triturarse las celdas.
2. Las celdas o baterías no deben someterse a calor ni fuego. Debe evitarse el almacenamiento a la luz directa del sol. Las celdas y baterías deben mantenerse limpias y secas. Limpiar las conexiones sucias con un paño seco y limpio.
3. Las celdas o baterías no deben cortocircuitarse. Es peligroso almacenar las celdas o baterías en estuches o cajones en cuyo interior puedan cortocircuitarse por contacto recíproco o por contacto con otros materiales conductores. No deben extraerse las celdas o baterías de sus embalajes originales hasta el momento en que vayan a utilizarse.
4. Las celdas o baterías no deben someterse a impactos mecánicos fuertes indebidos.
5. En caso de falta de estanqueidad de una celda, el líquido vertido no debe entrar en contacto con la piel ni los ojos. Si se produce contacto, lavar con agua abundante la zona afectada y avisar a un médico.
6. En caso de cambio o recarga inadecuados, las celdas o baterías que contienen electrolitos alcalinos (p. ej. las celdas de litio) pueden explotar. Para garantizar la seguridad del producto, las celdas o baterías solo deben ser sustituidas por el tipo Rohde & Schwarz correspondiente (ver lista de recambios).
7. Las baterías y celdas deben reciclarse y no deben tirarse a la basura doméstica. Las baterías o acumuladores que contienen plomo, mercurio o cadmio deben tratarse como residuos especiales. Respete en esta relación las normas nacionales de eliminación y reciclaje.

Transporte

1. El producto puede tener un peso elevado. Por eso es necesario desplazarlo o transportarlo con precaución y, si es necesario, usando un sistema de elevación adecuado (p. ej. una carretilla elevadora), a fin de evitar lesiones en la espalda u otros daños personales.

Instrucciones de seguridad elementales

2. Las asas instaladas en los productos sirven solamente de ayuda para el transporte del producto por personas. Por eso no está permitido utilizar las asas para la sujeción en o sobre medios de transporte como p. ej. grúas, carretillas elevadoras de horquilla, carros etc. Es responsabilidad suya fijar los productos de manera segura a los medios de transporte o elevación. Para evitar daños personales o daños en el producto, siga las instrucciones de seguridad del fabricante del medio de transporte o elevación utilizado.
3. Si se utiliza el producto dentro de un vehículo, recae de manera exclusiva en el conductor la responsabilidad de conducir el vehículo de manera segura y adecuada. El fabricante no asumirá ninguna responsabilidad por accidentes o colisiones. No utilice nunca el producto dentro de un vehículo en movimiento si esto pudiera distraer al conductor. Asegure el producto dentro del vehículo debidamente para evitar, en caso de un accidente, lesiones u otra clase de daños.

Eliminación/protección del medio ambiente

1. Los dispositivos marcados contienen una batería o un acumulador que no se debe desechar con los residuos domésticos sin clasificar, sino que debe ser recogido por separado. La eliminación se debe efectuar exclusivamente a través de un punto de recogida apropiado o del servicio de atención al cliente de Rohde & Schwarz.
2. Los dispositivos eléctricos usados no se deben desechar con los residuos domésticos sin clasificar, sino que deben ser recogidos por separado.
Rohde & Schwarz GmbH & Co.KG ha elaborado un concepto de eliminación de residuos y asume plenamente los deberes de recogida y eliminación para los fabricantes dentro de la UE. Para desechar el producto de manera respetuosa con el medio ambiente, dirijase a su servicio de atención al cliente de Rohde & Schwarz.
3. Si se trabaja de manera mecánica y/o térmica cualquier producto o componente más allá del funcionamiento previsto, pueden liberarse sustancias peligrosas (polvos con contenido de metales pesados como p. ej. plomo, berilio o níquel). Por eso el producto solo debe ser desmontado por personal especializado con formación adecuada. Un desmontaje inadecuado puede ocasionar daños para la salud. Se deben tener en cuenta las directivas nacionales referentes a la eliminación de residuos.
4. En caso de que durante el trato del producto se formen sustancias peligrosas o combustibles que deban tratarse como residuos especiales (p. ej. refrigerantes o aceites de motor con intervalos de cambio definidos), deben tenerse en cuenta las indicaciones de seguridad del fabricante de dichas sustancias y las normas regionales de eliminación de residuos. Tenga en cuenta también en caso necesario las indicaciones de seguridad especiales contenidas en la documentación del producto. La eliminación incorrecta de sustancias peligrosas o combustibles puede causar daños a la salud o daños al medio ambiente.

Se puede encontrar más información sobre la protección del medio ambiente en la página web de Rohde & Schwarz.

Quality management and environmental management

Certified Quality System
ISO 9001

Certified Environmental System
ISO 14001

Sehr geehrter Kunde,

Sie haben sich für den Kauf eines Rohde&Schwarz Produktes entschieden. Sie erhalten damit ein nach modernsten Fertigungsmethoden hergestelltes Produkt. Es wurde nach den Regeln unserer Qualitäts- und Umweltmanagementsysteme entwickelt, gefertigt und geprüft. Rohde&Schwarz ist unter anderem nach den Managementsystemen ISO9001 und ISO 14001 zertifiziert.

Der Umwelt verpflichtet

- Energie-effiziente, RoHS-konforme Produkte
- Kontinuierliche Weiterentwicklung nachhaltiger Umweltkonzepte
- ISO 14001-zertifiziertes Umweltmanagementsystem

Dear customer,

You have decided to buy a Rohde&Schwarz product. This product has been manufactured using the most advanced methods. It was developed, manufactured and tested in compliance with our quality management and environmental management systems. Rohde&Schwarz has been certified, for example, according to the ISO9001 and ISO 14001 management systems.

Environmental commitment

- Energy-efficient products
- Continuous improvement in environmental sustainability
- ISO 14001-certified environmental management system

Cher client,

Vous avez choisi d'acheter un produit Rohde&Schwarz. Vous disposez donc d'un produit fabriqué d'après les méthodes les plus avancées. Le développement, la fabrication et les tests de ce produit ont été effectués selon nos systèmes de management de qualité et de management environnemental. La société Rohde&Schwarz a été homologuée, entre autres, conformément aux systèmes de management ISO 9001 et ISO 14001.

Engagement écologique

- Produits à efficience énergétique
- Amélioration continue de la durabilité environnementale
- Système de management environnemental certifié selon ISO 14001



Customer Support

Technical support – where and when you need it

For quick, expert help with any Rohde & Schwarz equipment, contact one of our Customer Support Centers. A team of highly qualified engineers provides telephone support and will work with you to find a solution to your query on any aspect of the operation, programming or applications of Rohde & Schwarz equipment.

Up-to-date information and upgrades

To keep your instrument up-to-date and to be informed about new application notes related to your instrument, please send an e-mail to the Customer Support Center stating your instrument and your wish. We will take care that you will get the right information.

Europe, Africa, Middle East

Phone +49 89 4129 12345
customersupport@rohde-schwarz.com

North America

Phone 1-888-TEST-RSA (1-888-837-8772)
customer.support@rsa.rohde-schwarz.com

Latin America

Phone +1-410-910-7988
customersupport.la@rohde-schwarz.com

Asia/Pacific

Phone +65 65 13 04 88
customersupport.asia@rohde-schwarz.com

China

Phone +86-800-810-8228 /
+86-400-650-5896
customersupport.china@rohde-schwarz.com



Contents

1	Contents of the Customer Documentation.....	21
2	Startup.....	23
2.1	Description of Front View.....	23
2.1.1	Screen with softkeys.....	24
2.1.2	Navigation keys.....	26
2.1.3	Data entry keys.....	26
2.1.4	CONTROL panel.....	27
2.1.5	VARIATION panel.....	29
2.1.6	USB Sockets.....	29
2.1.7	CD/DVD Combo drive.....	30
2.1.8	Ground socket.....	30
2.1.9	Headphone Connector.....	30
2.1.10	WINDOW / SETUP panel.....	30
2.1.11	Analog Audio Interfaces.....	31
2.1.12	Digital Audio Interfaces.....	32
2.1.13	Power Switch.....	33
2.1.14	Status LEDs.....	33
2.2	Description of the Rear Panel.....	34
2.2.1	Remote control connectors.....	35
2.2.2	PC Interfaces.....	35
2.2.3	USB Sockets.....	36
2.2.4	BNC Phone Out.....	37
2.2.5	Trigger, Aux ports.....	37
2.2.6	Digital synchronization and expansion interfaces.....	37
2.2.7	IEC/IEEE-bus socket.....	38
2.2.8	Mains Voltage Connector.....	39
2.2.9	Slots for extension units.....	39
2.2.10	I2S interface.....	39
2.2.11	LAN RESET Pushbutton.....	40
2.3	Putting into Operation.....	41
2.3.1	Unpacking the instrument	41

2.3.2	Setting Up the Instrument.....	42
2.3.3	Connecting the R&S UPV to the AC Supply.....	44
2.4	Function Check.....	48
2.5	Presets.....	48
2.6	Windows Operating System.....	49
2.6.1	Retrieving Computer Hardware Information and Windows Operating System.....	50
2.7	Connecting External Keyboard and Mouse.....	51
2.7.1	Connecting an External Keyboard.....	51
2.7.2	Connecting an External Mouse.....	51
2.8	Connecting an External Monitor.....	51
2.8.1	Changing Screen Resolution of External Monitor under Windows XP.....	52
2.8.2	Changing Screen Resolution of External Monitor under Windows 7.....	65
2.9	Installing Options.....	67
2.10	Connect R&S UPV to a Network (LAN).....	67
2.10.1	Connection to the Network.....	68
2.10.2	Configuration of R&S UPV for Network Operation.....	68
2.10.3	Configuration via LXI.....	73
2.10.4	Configuration for manual remote operation.....	80
2.11	Firmware Update.....	83
2.11.1	Troubleshooting during a Firmware Update.....	84
2.12	Windows XP Recovery and Backup.....	84
2.12.1	Calling the Windows XP Recovery and Backup Partition Menu.....	85
2.12.2	Backup Current System Partition.....	86
2.12.3	Restoring a Selected Version of the System Partition.....	86
2.12.4	Recover Factory Default.....	87
2.12.5	Deleting Backups.....	88
2.13	Windows 7 Recovery and Backup.....	89
2.13.1	Calling Windows 7 Recovery and Backup Partition Menu.....	90
2.13.2	Restoring Factory Default.....	91
2.13.3	Restoring a "User Backup".....	91
2.13.4	Creating a "User Backup".....	91
2.13.5	Deleting Backups.....	93
3	Getting Started.....	94

3.1	Introduction - Getting Started.....	94
3.2	Important Information for Measurements.....	94
3.2.1	Maximum Output Voltage of the R&S UPV Generator.....	94
3.2.2	Rapid Deactivation of Outputs.....	95
3.2.3	Avoiding Hum Loops.....	95
3.2.4	Help System.....	96
3.3	Brief Introduction to Operation.....	96
3.3.1	Windows User Interface and Controls.....	96
3.3.2	The Display.....	97
3.3.3	Panels and Display Windows.....	99
3.3.4	Quickstart Panel.....	100
3.3.5	Structure of the Panels and Display Windows.....	104
3.3.6	Basic Rules of Operation.....	106
3.3.7	Function Selection and Value Entry.....	106
3.3.8	Input Help.....	110
3.3.9	Measurement Functions and Displaying Measurement Results.....	111
3.4	Introduction to Instrument Operation Using Examples.....	114
3.4.1	Measuring the Frequency Response of an Amplifier, Equalizer, etc.....	114
3.4.2	Measuring Total Harmonic Distortion (THD+N) of a DUT.....	126
3.5	Loading Predefined Instrument Setups.....	134
4	Manual Operation.....	136
4.1	Introduction - Manual Operation.....	136
4.2	Functional Division of the Audio Analyzer.....	137
4.2.1	Instrument Concept.....	137
4.2.2	Generators.....	137
4.2.3	Analyzers.....	139
4.3	General Information on Operation.....	144
4.3.1	Windows User Interface.....	144
4.3.2	Using the Rotary Knob.....	144
4.3.3	Operation Using the Mouse.....	145
4.3.4	Operation Using an External Computer Keyboard.....	146
4.4	The Display.....	147
4.4.1	The Screens.....	147

4.4.2	WINBAR and Softkeys.....	148
4.4.3	Moving and Resizing Panels and Graphical Windows.....	150
4.4.4	Status Displays and Messages.....	152
4.5	Panels.....	153
4.5.1	Opening, Operating, Hiding and Closing Panels.....	154
4.5.2	Panel Structure.....	155
4.5.3	Navigating in the Panels.....	158
4.6	Settings on the Audio Analyzer.....	159
4.7	Settings in the Panels.....	160
4.7.1	Focus.....	160
4.7.2	Changing the Instrument.....	161
4.7.3	Changing Functions.....	161
4.7.4	Hiding Parameter Fields.....	162
4.7.5	Highlighting Controls.....	163
4.7.6	Activating/Deactivating Functions – Checkboxes.....	163
4.7.7	Toggling Functions – Radio Buttons.....	163
4.7.8	Selecting a Parameter – Selection Fields.....	164
4.7.9	Numeric Entries – Numeric Entry Fields.....	165
4.7.10	Alphanumeric Entries – Text Entry Fields.....	169
4.7.11	Display Fields.....	170
4.7.12	Adopting Parameters – Track Box.....	171
4.7.13	Input Help.....	171
4.7.14	Completing Settings.....	172
4.7.15	Entries during Measurement or Data Output.....	173
4.8	Measurement Displays.....	173
4.8.1	Measurement Functions and Displaying Measurement Results.....	174
4.8.2	Numeric Display Field.....	174
4.8.3	Combo Display.....	176
4.8.4	Graphical window.....	182
4.9	Settings in the Menu Bar.....	203
4.10	Settings on the Toolbar.....	209
4.11	Settings in the Operating System.....	210
4.12	Auxiliaries Panel.....	211

4.12.1	Audio Monitor Function.....	211
4.12.2	Auxiliary analog output.....	213
4.12.3	Trigger Input, Trigger Output.....	213
4.13	Rapid Deactivation of Outputs.....	213
4.14	Help System.....	214
4.14.1	Operating Help.....	215
4.14.2	Help Text Language.....	215
4.15	File Management.....	217
4.15.1	Selecting the File Select Window.....	218
4.15.2	Integrated File Select Window.....	218
4.15.3	File Manager.....	219
4.15.4	Loading and Saving Instrument Settings.....	220
4.15.5	List of File Extensions Used	220
4.16	Manual Remote Operation.....	221
4.17	Units.....	223
4.17.1	Units in Measurement Result Displays.....	223
4.17.2	Units for Value Entries.....	226
4.18	Overview of Keys.....	229
4.19	Overview of Panels and Measurement Displays (Graphical Windows).....	232
4.20	Overview of Status Messages.....	235
5	Instrument Functions.....	237
5.1	Selecting the Generator.....	237
5.1.1	Generator Configuration Panel.....	237
5.2	Configuring Analog Generator.....	238
5.2.1	Analog Generator Config Panel.....	238
5.2.2	Outputs of the universal generator.....	242
5.2.3	Output power of the universal generator.....	249
5.3	Configuring the Digital Generator.....	250
5.3.1	Digital Generator Configuration Panel.....	250
5.3.2	Digital Impairments Configuration Panel.....	258
5.3.3	Interface Assignment.....	260
5.4	Configuring the I²S Generator.....	262
5.4.1	I ² S Generator Configuration Panel.....	262

5.4.2	Timing Diagrams.....	266
5.4.3	Interface Assignment.....	268
5.5	Configuring the USI Dual Channel Generator.....	269
5.5.1	USI Dual Channel Generator Configuration Panel.....	269
5.5.2	Meaning of the TX_DATA 1 to TX_DATA 4 setting line strings.....	280
5.5.3	Timing Diagrams.....	284
5.5.4	Interface Assignment.....	285
5.6	Generator Signals.....	287
5.6.1	Sine.....	287
5.6.2	Stereo Sine.....	290
5.6.3	Multisine.....	294
5.6.4	Sine Burst.....	297
5.6.5	Sine ² Burst.....	300
5.6.6	Mod Dist.....	302
5.6.7	DFD.....	305
5.6.8	DIM.....	307
5.6.9	Random.....	309
5.6.10	Arbitrary.....	316
5.6.11	Play.....	317
5.6.12	Play+Anlr.....	324
5.6.13	Polarity.....	331
5.6.14	Modulation.....	332
5.6.15	DC (Direct-Current Voltage).....	333
5.6.16	Square.....	334
5.6.17	Chirp.....	336
5.7	Amplitude Variation.....	338
5.8	Equalization.....	339
5.9	Protocol Generator.....	340
5.9.1	Higher-Level Settings.....	340
5.9.2	Setting Bytes as Numerical Values.....	342
5.9.3	Setting Bytes in Remote-Control Mode.....	344
5.9.4	Displaying and Setting Parameters in Plain Text	345
5.10	Sweeps.....	346

5.10.1	Activating / Deactivating the Sweep System.....	348
5.10.2	One-Dimensional Sweep.....	349
5.10.3	Two-Dimensional Sweep.....	350
5.10.4	Automatic Sweep.....	352
5.10.5	Linear and Logarithmic Sweep.....	354
5.10.6	List sweep.....	358
5.10.7	Behavior after Sweep End.....	359
5.10.8	Sweep Speed.....	360
5.11	Selecting the Analyzer.....	364
5.11.1	Analyzer Configuration Panel.....	364
5.12	Configuring the Analog Analyzer.....	366
5.12.1	Analog Analyzer Config Panel.....	366
5.13	Configure Analog Multi Channel Analyzer.....	376
5.13.1	Multi Channel Analyzer Configuration Panel.....	376
5.14	Configuring the Digital Analyzer.....	385
5.14.1	Digital Analyzer Configuration Panel.....	385
5.15	Configuring the I²S Analyzer.....	393
5.15.1	I ² S Analyzer Configuration Panel.....	393
5.15.2	Timing Diagrams.....	397
5.15.3	Interface Assignment.....	398
5.16	Configuring the USI Dual Channel Analyzer.....	400
5.16.1	USI Dual Channel Analyzer Configuration Panel.....	400
5.16.2	Timing Diagrams.....	412
5.16.3	Interface Assignment.....	413
5.17	Configuring the USI 8 Channel Analyzer.....	415
5.17.1	USI 8 Channel Analyzer Configuration Panel.....	415
5.17.2	Timing Diagrams.....	426
5.17.3	Interface Assignment.....	426
5.18	Configuring the Dig Bitstream Analyzer.....	427
5.18.1	Dig Bitstream Analyzer Configuration Panel.....	427
5.18.2	Timing Diagrams.....	435
5.18.3	Interface Assignment.....	436
5.19	Starting Measurements.....	438

5.19.1	Overview of the Measurement System.....	438
5.19.2	Activating and Deactivating Measurement Types.....	439
5.19.3	States of the Measurement System.....	440
5.20	Start Conditions.....	444
5.21	Setting Start Condition.....	445
5.22	Time-Controlled Measured value Recording.....	452
5.23	External Sweeps and Level-Controlled Measured value Triggering.....	453
5.24	Sweep Options.....	456
5.24.1	Overview of Sweep Options.....	456
5.24.2	Activating and Deactivating Sweeps.....	457
5.24.3	States of the Sweep System.....	457
5.24.4	Several Sweep Traces in One Diagram.....	463
5.25	Level Measurements.....	463
5.25.1	Filter Settings.....	464
5.25.2	RMS Measurement, Broadband.....	467
5.25.3	RMS Measurement, Selective.....	470
5.25.4	Rub & Buzz Measurement.....	481
5.25.5	Peak Measurement.....	485
5.25.6	Quasi Peak Measurement.....	487
5.25.7	DC voltage measurement.....	488
5.26	Signal-to-Noise Measurements.....	488
5.26.1	S/N Measurement Function.....	490
5.26.2	S/N Sequence in Level Measurements.....	494
5.27	Distortion Measurements.....	494
5.27.1	General Settings.....	496
5.27.2	THD.....	499
5.27.3	THD+N & SINAD.....	504
5.27.4	MOD DIST.....	511
5.27.5	DFD.....	513
5.27.6	DIM (dynamic intermodulation distortion analysis).....	516
5.28	Polarity Measurement.....	518
5.29	Frequency Band Analysis.....	519
5.29.1	Nth Octave Analysis.....	519

5.30	FFT Analysis.....	526
5.30.1	Size of the FFT.....	526
5.30.2	Window Function.....	527
5.30.3	Post FFT.....	529
5.30.4	FFT Measurement Function.....	530
5.31	Perceptual evaluation of speech quality (PESQ).....	541
5.31.1	PESQ Value and MOS Value	542
5.31.2	Electrical PESQ Measurements	543
5.31.3	Acoustic PESQ Measurements	544
5.31.4	PESQ Graphs.....	545
5.31.5	PESQ Measurement Function.....	546
5.32	Audio quality measurements (PEAQ).....	552
5.32.1	DI value and ODG value.....	553
5.32.2	PEAQ measurements.....	554
5.32.3	PEAQ graphics.....	555
5.32.4	PEAQ measurement function.....	555
5.33	Objective listening quality measurements (POLQA).....	559
5.33.1	Electrical POLQA measurements	561
5.33.2	Acoustic POLQA measurements	562
5.33.3	POLQA measuring function.....	563
5.34	Chirp-Based Measurement.....	569
5.34.1	Settings.....	570
5.34.2	Data Buffers.....	574
5.35	Analysis in the Time Domain.....	576
5.35.1	Waveform Monitor.....	577
5.35.2	Delay Measurement.....	584
5.36	Offline Analysis Record.....	587
5.36.1	Applications.....	588
5.36.2	Recording Format.....	589
5.36.3	Monitoring the Recording.....	590
5.36.4	Recording Modes of the Record Function.....	591
5.36.5	Operating the Record Function.....	591
5.36.6	Create WAV files for external sweeps.....	597

5.37	Infrasound Measurements.....	598
5.37.1	Infrasound Signals.....	598
5.37.2	Infrasound Analysis.....	598
5.38	Protocol Analysis.....	601
5.38.1	Activating and Configuring the Protocol Analysis.....	601
5.38.2	Channel-Status Information Display.....	604
5.38.3	Error Flag Display.....	605
5.39	Frequency, Phase and Group Delay Measurement.....	606
5.40	Input Monitor.....	611
5.41	Level Monitor.....	612
5.42	Settling Methods.....	614
5.42.1	Applications.....	614
5.42.2	Settling Algorithms.....	615
5.42.3	Settling for Measurement Functions.....	616
5.42.4	Settling for Frequency Measurements.....	619
5.42.5	Settling for Phase Measurements.....	621
5.42.6	Settling for Start Conditions (Event-Triggered Measurements).....	623
5.42.7	Examples of Settling	626
5.43	Filter.....	626
5.43.1	Analyzer Prefilter.....	627
5.43.2	Analyzer Function Filters.....	627
5.43.3	Generator Filters.....	627
5.43.4	Filter Table.....	628
5.44	User-Definable Filters.....	628
5.44.1	Filters 01 to 09.....	629
5.44.2	Lowpass Filter and Highpass Filter.....	630
5.44.3	Bandpass Filters and Bandstop Filters.....	631
5.44.4	Notch Filter, Third-Octave Filter and Octave Filter.....	632
5.44.5	File-Defined Filter.....	634
5.44.6	Parameters Common to All Filters.....	636
5.44.7	Filter Settling Time.....	637
5.45	Weighting Filters.....	637
5.46	Highpass and Lowpass.....	643

5.47	Signal Monitoring	644
5.47.1	Auxiliaries Panel.....	644
5.48	Switcher Panel	653
5.48.1	Connecting Switcher to R&S UPV.....	653
5.48.2	Default Setting.....	655
5.48.3	Operation.....	655
5.49	Config panel	658
5.50	Curve, Spectrum and Bar Graph Display	664
5.50.1	Graphical Display, Explanation of the Elements.....	664
5.50.2	Calling Up.....	671
5.50.3	Parameter Fields of the Panel.....	673
5.50.4	Softkey Menu.....	726
5.50.5	Single Scan.....	731
5.50.6	Trace Group.....	732
5.50.7	Interpolation on the Common x-axis.....	735
5.51	Result List	735
5.51.1	Graphical Display, Explanation of the Elements.....	735
5.51.2	Calling Up.....	737
5.51.3	Parameter Fields of the Panel.....	738
5.51.4	Softkey Menu.....	740
5.52	Numeric display	741
5.52.1	Graphical Display, Explanation of the Elements.....	742
5.52.2	Calling Up.....	744
5.52.3	Parameter Fields of the Panel.....	744
5.52.4	Softkey Menu.....	745
5.53	Combo Display	745
5.53.1	Graphical Display, Explanation of the Elements.....	745
5.53.2	Calling Up.....	747
5.53.3	Parameter Fields of the Panel.....	749
5.53.4	Softkey Menu.....	763
5.54	Limit Monitoring	764
5.54.1	Traces and Bar Graphs.....	764
5.54.2	Measurement Results.....	767

5.55 Measured value Sequences.....	768
5.56 Store.....	769
5.56.1 Trace Files.....	769
5.56.2 Equalization Files.....	769
5.56.3 Sweep Lists.....	770
5.56.4 Limit Files.....	771
5.57 Load.....	771
5.57.1 Trace Files.....	771
5.57.2 Equalization Files.....	779
5.57.3 Sweep Lists.....	779
5.57.4 Limit Files.....	779
5.58 Format.....	780
5.58.1 Trace Files.....	780
5.58.2 Equalization Files.....	784
5.58.3 Sweep Lists.....	785
5.58.4 Limit Files.....	786
5.59 Editing.....	788
5.60 Export.....	793
5.61 Loading and Saving.....	796
5.61.1 Integrated File selection box.....	796
5.61.2 File Manager.....	797
5.61.3 Windows File Selection Box.....	798
5.62 Loading and Saving Setups.....	798
5.62.1 Saving Setups.....	798
5.62.2 Loading Setups.....	799
5.63 Printing and Saving.....	799
5.63.1 Printing and Saving the Display Screen.....	799
5.63.2 Configuring Print and Save Operations.....	800
5.63.3 Starting Print and Save Operations.....	800
6 Remote Control - Fundamentals.....	802
6.1 Remote Control - Fundamentals.....	802
6.1.1 Introduction - Remote Control Fundamentals.....	802
6.2 Brief Instructions.....	803

6.2.1	IEC Bus.....	803
6.3	Changing to Remote Control.....	804
6.3.1	Remote Control by IEC/IEEE Bus	804
6.3.2	Remote Control via LAN Interface.....	805
6.3.3	Remote Control via the USB Device Interface.....	810
6.4	Messages.....	812
6.4.1	Interface Messages.....	812
6.4.2	Device-Dependent Messages.....	813
6.5	SCPI Command Structure and Syntax.....	814
6.5.1	Structure of a Program Message.....	817
6.5.2	Responses to Queries.....	818
6.5.3	Parameter.....	819
6.5.4	Overview of Syntax Elements.....	820
6.6	Device Model and Command Processing.....	821
6.6.1	Input Unit.....	822
6.6.2	Parser Analyzes.....	822
6.6.3	Database and Device Hardware.....	823
6.6.4	Command Sequence (IEC/IEEE).....	823
6.6.5	Status Reporting System.....	824
6.6.6	Output Unit.....	825
6.6.7	Triggering Measurement or Sweep.....	825
6.6.8	Command Synchronization.....	825
6.7	Command Recording.....	826
6.7.1	Starting Recording.....	827
6.7.2	Recording Commands.....	827
6.7.3	Editing Commands.....	828
6.8	Status Reporting System.....	828
6.8.1	Structure of SCPI Status Register.....	829
6.8.2	Overview of Status Registers.....	831
6.8.3	Status Byte (STB) and Service Request Enable (SRE) Register.....	832
6.8.4	IST Flag and Parallel Poll Enable (PPE) Register.....	833
6.8.5	STATus:EVENT Register (ESR).....	833
6.8.6	STATus:OPERation Register.....	834

6.8.7	STATus:QUEStionable Register.....	836
6.8.8	STATus:QUEStionable:UNDErRange Register.....	837
6.8.9	STATus:QUEStionable:OVerRange Register.....	838
6.8.10	STATus:QUEStionable:MEASuring Register.....	839
6.8.11	STATus:XQUEStionable Register.....	840
6.8.12	Use of Status Reporting System.....	841
6.8.13	Initializing the Status Reporting System.....	845
7	Remote Control - Command Description.....	847
7.1	Notation of Device-Specific Commands.....	848
7.1.1	SCPI Parameters.....	849
7.2	Common Commands.....	851
7.3	Generator Settings.....	855
7.3.1	Selecting the Generator.....	855
7.3.2	Configuring the Generators.....	856
7.3.3	Generator Signals.....	868
7.3.4	Amplitude Variation.....	884
7.3.5	Digital Audio Protocol Generator.....	884
7.3.6	Sweeps.....	886
7.3.7	Rapid Deactivation of Outputs.....	890
7.4	Analyzer Settings.....	891
7.4.1	Selecting the Analyzer.....	891
7.4.2	Configuring the Analog Analyzer.....	891
7.4.3	Configuring the Analog Multi Channel Analyzer.....	892
7.4.4	Configuring the Digital Analyzer.....	895
7.4.5	Configuring the I ² S Analyzer.....	897
7.4.6	Configuring the USI Dual/Eight Channel Analyzer.....	898
7.4.7	Configure Dig Bitstream Analyzer.....	903
7.5	Triggering Measurements and Reading Results.....	904
7.5.1	Starting Measurements.....	904
7.5.2	Start Conditions.....	909
7.5.3	External Sweeps and Level-Controlled Measurement Value Triggering.....	910
7.5.4	Reading Measurement Results.....	911
7.5.5	Output of Trace Data Sets.....	913

7.5.6	Reading out Multi-channel Records.....	924
7.5.7	Output of Protocol Data.....	927
7.5.8	Output of Protocol Errors.....	927
7.6	Sweep Options.....	929
7.7	Selecting Measurement and Mode.....	929
7.8	Level Measurements.....	931
7.8.1	Filter Settings.....	931
7.8.2	RMS and RMS Selective Measurement.....	932
7.8.3	Rub & Buzz Measurement.....	934
7.8.4	Peak Measurement.....	935
7.8.5	DC Voltage Measurement.....	935
7.9	Signal-to-Noise Measurements.....	935
7.9.1	S/N Measurement Function.....	935
7.9.2	S/N Sequence in Level Measurements.....	936
7.10	Distortion Measurements.....	936
7.10.1	General Settings.....	936
7.10.2	THD.....	937
7.10.3	THD+N / SINAD.....	938
7.10.4	MOD DIST.....	939
7.10.5	DFD.....	939
7.10.6	DIM (dynamic intermodulation distortion analysis).....	939
7.11	Polarity Measurement.....	939
7.12	Frequency Band Analysis.....	939
7.12.1	Nth Octave Analysis.....	939
7.13	FFT Analysis.....	940
7.14	Speech Quality Measurements (PESQ).....	943
7.15	Audio quality measurements (PEAQ).....	944
7.16	Objective Listening Measurements (POLQA).....	946
7.17	Chirp Based Measurement.....	948
7.18	Analysis in the Time Domain.....	950
7.19	Offline Analysis.....	952
7.20	Protocol Analysis.....	953
7.21	Frequency, Phase and Group Delay Measurement.....	954

7.22	Input and Level Monitor	955
7.23	Settling Methods	955
7.24	Filters	957
7.25	Audio Monitoring	961
7.26	Switcher	964
7.27	Traces, Spectrum Displays and Bargraphs	966
7.27.1	Display Configuration.....	966
7.28	Combi Display	993
7.28.1	Measurement Result Configuration.....	993
7.29	Generation of Protocol Data	1001
7.30	Softkey Commands of the Graphical Display	1002
7.31	Transferring trace data	1014
7.32	User-definable data buffers	1016
7.33	Hardcopy	1018
7.34	MMEMory Subsystem	1020
7.34.1	File Naming Conventions.....	1021
7.34.2	Load and store setups.....	1022
7.34.3	Common MMEMory commands.....	1022
7.35	STATus Subsystem	1025
7.36	SYSTem Subsystem	1034
8	Maintenance and Instrument Interfaces	1039
8.1	Introduction - Maintenance and Interfaces	1039
8.2	Maintenance	1039
8.3	Changing the AC Supply Fuse	1039
8.4	Instrument Interfaces	1040
8.4.1	IEC/IEEE-Bus Interface (IEC 625 / IEEE 488).....	1040
8.4.2	Ethernet Interface (LAN).....	1043
8.4.3	RS-232-C Interface (COM).....	1046
8.4.4	USB Connectors (USB).....	1049
8.4.5	USB Device Port.....	1050
8.4.6	Printer Connector (LPT).....	1050
8.4.7	Monitor Connector (MONITOR).....	1052
8.4.8	Monitor connection (DVI-D).....	1052

List of Commands.....	1054
Index.....	1078

1 Contents of the Customer Documentation

The customer documentation for the R&S UPV consists of:

- Quick Start Guide
- Operating manual for the base unit and the options
- Service manual (English only)
- Context-sensitive online help
- Release Notes

The respective current version of the documentation is always available on the Internet (www.rohde-schwarz.com/downloads/manuals/upv.html).

Quick Start Guide

The printed quick start guide is part of the equipment supplied of the device. It contains information about the technical properties of the device, its commissioning, the fundamental operating steps and controls. The quick start guide is divided into three chapters:

- Commissioning
- Getting Started
- Manual Operation

Operating manual

The operating manual is located on the supplied CD-ROM. In addition to the chapters of the quick start guide, it contains the description of all device functions and the remote control of the device. Furthermore, it features notes for the preventive maintenance of the R&S UPV and for locating errors based on the warnings and error messages issued by the device. It is divided into the following chapters:

- Putting into Operation
- Getting Started
- Manual Operation
- Instrument Function
- Remote Control - Fundamentals
- Remote Control - Commands
- Maintenance and Instrument Interfaces

Service Manual

The service manual in English is located on the supplied CD-ROM. It contains all the necessary information to maintain the R&S UPV by replacing modules and to expand its functionality by installing options. The service manual is divided into the following chapters:

- Performance Test
- Adjustment

- Repair
- Firmware Update / Installing Options
- Documents

Context-sensitive online help

The context-sensitive online help provides support for the operation of the R&S UPV and its options – it describes the manual operation and the remote control. The online help is installed on the R&S UPV by default and is also supplied as external .chm file on the documentation CD-ROM.

Release Notes

The release notes describe the installation of the firmware, new and improved functions, problems solved and last-minute changes to the documentation. The corresponding firmware version can be seen on the cover sheet of the release notes. The current version of the release notes is available on the Internet (www.rohde-schwarz.com/downloads/firmware/upv.html).

2 Startup

The R&S UPV audio analyzer is available in two models. The R&S UPV standard model and an R&S UPV66 model which is specifically designed for use in systems and has no display, no front panel controls and no CD/DVD drive. Except for the operation via front panel, the R&S UPV66 variant is largely identical to the standard model with respect to functionality. This manual therefore describes both instruments in parallel, and any differences are indicated at the appropriate points in the text.

This chapter describes the controls and ports of the R&S audio analyzer UPV based on the front and rear view and shows how to put the instrument into operation. It also describes the connection of peripherals such as printer, keyboard, mouse and monitor. Specifications for the interfaces can be found in the data sheet.

The introduction to [chapter 3.1, "Introduction - Getting Started"](#), on page 94 provides an overview of the functions and the operating concept of the audio analyzer. Detailed operating instructions and an overview of the menus are provided in [chapter 4.1, "Introduction - Manual Operation"](#), on page 136.

The CD-ROM contains the entire manual complete with the other chapters in printable PDF format: The individual menus and functions of the instrument including the associated remote-control commands are explained in detail in the reference section of chapter "Device Functions." Basic information on remote control of the instrument is provided in the chapters "Remote Control - Fundamentals" and "Remote Control - Commands". A detailed description of the instrument interfaces can be found in the chapter "Maintenance and Interfaces".



The audio analyzer has the Windows XP® operating system. No special knowledge of the operating system used is required for operating the instrument.

Basic PC knowledge, such as what a file, a directory, etc. is, or how data is transferred using Windows Explorer® is assumed and, therefore, not discussed in any detail.

The R&S UPV audio analyzer can be fully operated via the controls on the front panel. It is, however, also possible to operate the instrument using an external keyboard and mouse. Operation follows the same basic rules which apply to other Windows programs in use today. It is also assumed that users are familiar with these basic rules. This information is therefore not specified in detail here.

The R&S UPV66 model does not feature a front panel keyboard and has no display or CD/DVD drive; but similar to the R&S UPV standard model, it can be operated by means of a keyboard or mouse after an external monitor is connected.

2.1 Description of Front View

This section provides an overview of the controls and ports on the front of the R&S UPV/R&S UPV66.

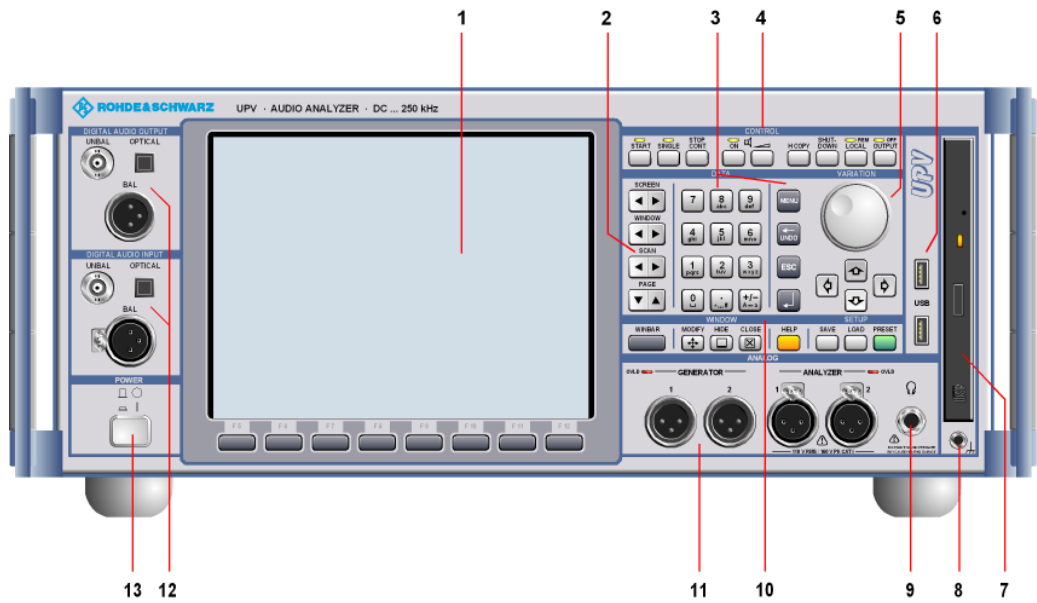


Fig. 2-1: Front Panel R&S UPV

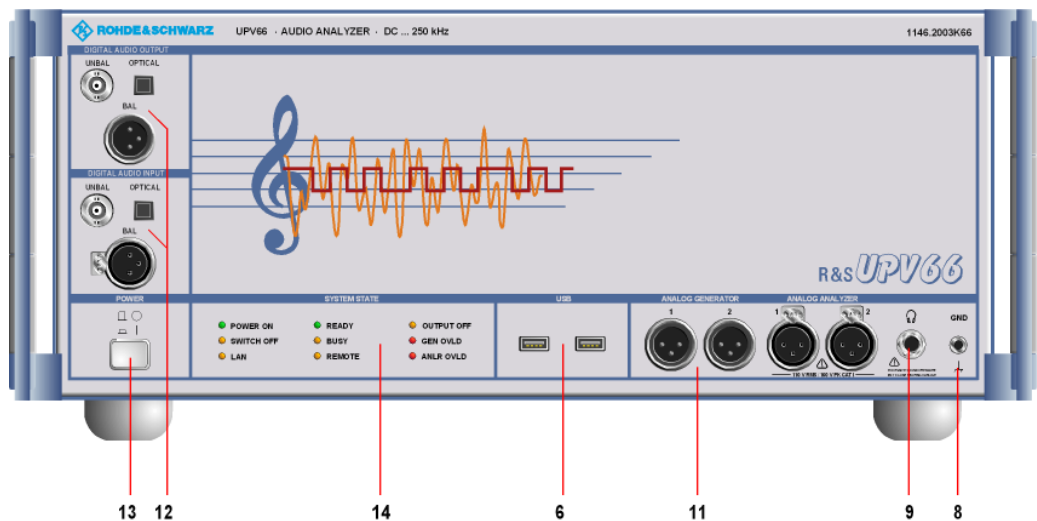
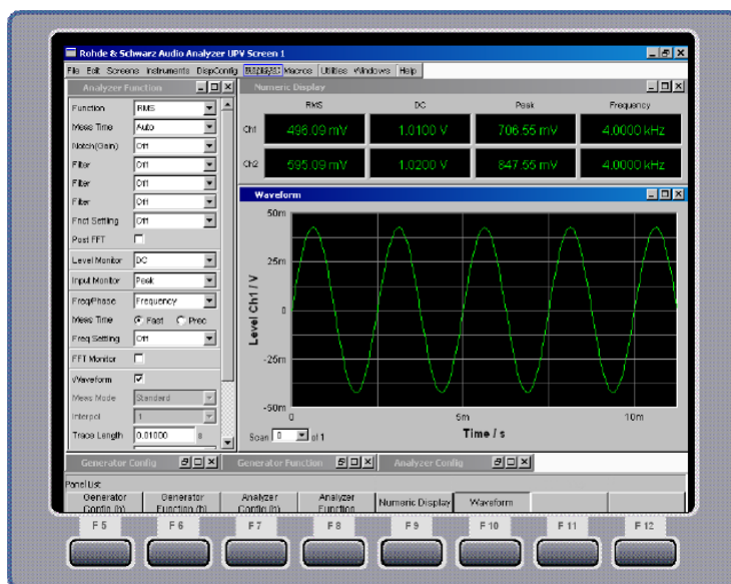


Fig. 2-2: Front Panel R&S UPV66

2.1.1 Screen with softkeys

The large screen shows all of the important settings and states of the audio analyzer in a clearly organized display. 5 displays ("screens") are provided to ensure clearer organization of the many possible panels and display windows.



The **screen** is divided into the following sections:

- menu bar
- operating and display area
- **WINBAR** with softkey labeling
- Softkeys

The **menu bar**

- contains a row of pull-down menus which can be used to, for example, load instrument settings, select panels and screens or call up help functions.
- The menu bar appears when the MENU key is pressed or the mouse pointer is moved to the left of the screen. It otherwise remains hidden in order to save space.

In the **operating and display area**

- - the Audio Analyzer R&S UPV is operated using numerous panels which can be selected by the user
- - the measurement results are displayed numerically and/or graphically in the format selected by the user

The **Softkey/WINBAR bar** at the bottom of the screen has two functions:

- In normal operating mode, the softkey bar is visible; it contains the functions available in the selection windows of the panels; the softkeys permit rapid selection without needing to use the mouse.
- When the WINBAR key is pressed, the WINBAR containing the names of all opened panels / graphical windows is displayed in place of the softkey bar. Pressing the associated softkey puts the focus on the corresponding panel / graphical window, i.e. it becomes active. At the same time, the system returns to normal operating mode (see above).
- It is possible to toggle between the softkey bar and WINBAR at any time by pressing the WINBAR key.

The **softkeys**

- corresponds to the label on the softkey bar and WINBAR. The softkeys can also be operated using the function keys on the external keyboard or by clicking the associated button.

2.1.2 Navigation keys

The **navigation keys** consist of 4 rocker buttons that are used for switching forward and back:



SCREEN

Switches between the individual display settings (the "screens").

WINDOW

Switches the focus to each of the panels open in the visible screen in sequence (the panel with the focus is active).

SCAN

Changes between the individual traces ("scans") in graphical displays so that, for example, measured values can be read off from the traces using the cursor.

PAGE

Scrolls back and forward in the tables one page at a time.

2.1.3 Data entry keys



0 ... 9

Entry of numeric values

.

Entry of decimal point

+/-

Entry of sign

abc

Entry of letters for file names and/or directory names in the file selector in the mobile phone method (see [chapter 4.15.2, "Integrated File Select Window"](#), on page 218), provided that it appears in the R&S UPV style. The appearance of the file selector can be changed via the Config panel under the "File Selector" heading. To switch on the R&S UPV style, the "Win Style" checkmark must not be set (see [chapter 4.15.1, "Selecting the File Select Window"](#), on page 218).

BLANK

Entry of a space

* ... #

Entry of special characters

A <---> a

Switching between uppercase and lowercase letters

MENU

Displays the menu bar on the screen

<--- / UNDO

Deletes the character to the left of the cursor

Undoes the action last performed

ESC

Closes the open window; the old value or parameter is retained

ENTER

Completes the data entry; the new value is adopted

Confirms (OK) and closes open entry windows

Pressing the rotary knob has the same effect

2.1.4 CONTROL panel



The CONTROL panel features the following control functions:

- Starting measurements / sweeps

- Adjusting the loudspeaker
- Printing out the screen contents
- Shutting down the operating system
- Switch between remote / manual operation
- Switch off outputs

START

Starts continuous measurements and sweeps (the LED is on); resets Min/Max values for bargraph displays, averaging for measurement results, and limit overshoots

SINGLE

Starts a single measurement or a single sweep (the LED is on during execution)

STOP / CONT

Measurement/sweep is stopped or continued (toggle function)

ON

Switches the loudspeaker or connected headphones on and off (toggle function)

Volume

Opens a window for adjusting the audio monitoring volume

H COPY

Depending on the settings under Utilities, printout of the screen contents on the connected printer is started or the screen contents are stored in a file

SHUTDOWN

Stores the current settings on the hard disk and then shuts down the Windows operating system

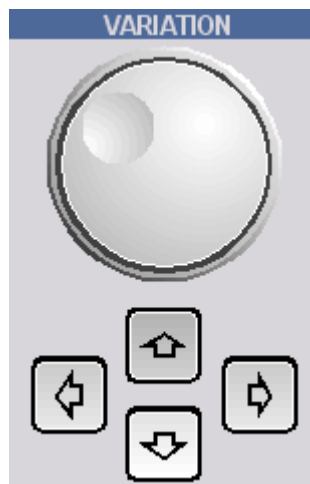
LOCAL

Switches from remote control to manual operation (the LED is on with remote control)

OUTPUT

Switches all outputs of the measuring instrument off or on again (the LED is on when the outputs are switched off)

2.1.5 VARIATION panel



Rotary Knob

Moves the focus in the panels, selection windows and tables

Varies the entry value at the cursor position

Moves the active cursor in the graphical windows

Pressing the rotary knob has the same effect as pressing the ENTER key

CURSOR UP / DOWN

Move the focus in the panels, selection windows and tables

Varies the entry value at the cursor position

CUSOR LEFT / RIGHT

Moves the active cursor inside the graphical windows

Moves the cursor position in entered values

2.1.6 USB Sockets



USB (Universal Serial Bus) interfaces of type A (host USB) for:

- Connecting peripherals such as mouse, keyboard, printer
- Connecting a USB stick for transferring files
- There are two additional USB interfaces (type A) at the rear of the instrument.

2.1.7 CD/DVD Combo drive



The integrated combined CD/DVD drive is used to

- install software updates on the R&S UPV
- install sequence programs and macros
- import data and instrument settings from other R&S UPVs
- store data on a CD

2.1.8 Ground socket



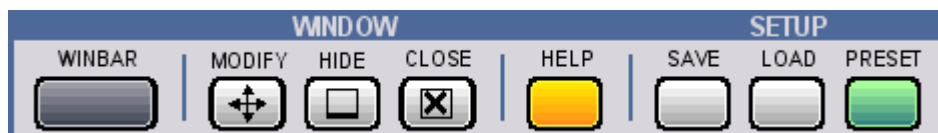
Ground socket that is connected with the instrument housing.

2.1.9 Headphone Connector



Connection of headphones for audio monitoring of the analysis or generator signal

2.1.10 WINDOW / SETUP panel



WINBAR

The **WINBAR** key is used to toggle between the softkey bar and WINBAR at any time:

- In normal operating mode, the softkey bar is visible; it contains the functions available in the selection windows of the panels; the softkeys permit rapid selection without needing to use the mouse.

- When the WINBAR key is pressed, the WINBAR containing the names of all opened panels or graphical windows is displayed in place of the softkey bar. Pressing the associated softkey puts the focus on the corresponding panel or graphical window, i.e. it becomes active. At the same time, the system returns to normal operating mode (see above).

MODIFY

Opens a selection of functions on the softkey bar; these functions can be used in conjunction with the rotary knob to move or resize the active panel or graphical window

HIDE

Minimizes ("hides") the active panel or graphical window

CLOSE

Closes the active panel or graphical window

HELP

Pressing this key displays a context-sensitive help text

SAVE

Opens a window for storing instrument settings

LOAD

Opens a window for loading predefined instrument settings

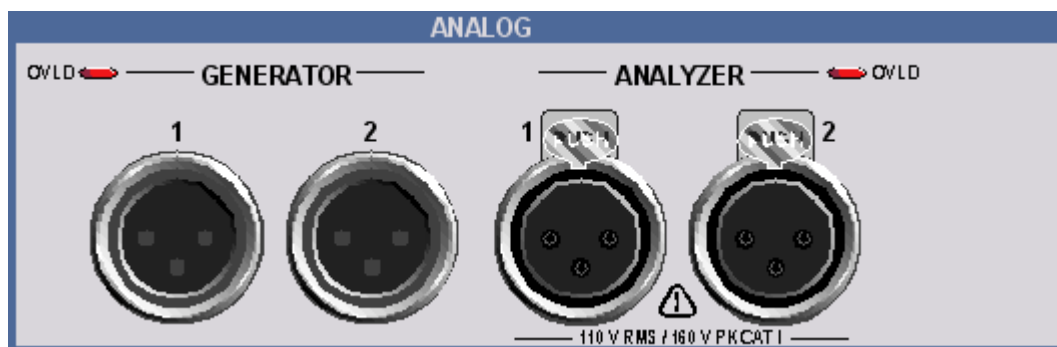
PRESET

Loads the **factory default settings** of the instrument or carries out a **Master PRESET**.

- **Factory setting:**
Pressing the button briefly displays the security prompt "Do you want to preset the UPV?". If you answer this question with "Yes", the factory default settings are restored immediately.
- **Master PRESET:**
With the Master PRESET, you can easily get out of an unsuitable screen and monitor configuration and back to an operable instrument: Switch the instrument off and on again. During the software start, the OUTPUT Off-LED is illuminated briefly in yellow. As soon as this LED is illuminated in yellow, press the PRESET button briefly. The LED flashes for confirmation. Within the next 5 seconds, press the PRESET key again briefly. The Master PRESET is now carried out and forces a switchover to the external monitor with a screen resolution of 800 x 600 pixels and the factory default settings.

2.1.11 Analog Audio Interfaces

Output and input sockets of the analog generators and analyzers



NOTICE

Possible instrument damage due to incorrect input voltages

The instrument complies with measuring category I; make sure that the input voltage at the sockets of the analog analyzers does not exceed 110 V (RMS, sine wave) and 160 V (peak value).

Do not use the instrument in measuring categories II, III and IV.

Explanation: Measuring circuits as defined in section 6.7.4 of EN61010-1: Measuring category I is intended for measurements on circuits which are not connected to the high-voltage current system.

Meaning of the LEDs: Generator OVLD: Generator is overloaded. Analyzer OVLD: The low-impedance input resistors (300 Ohm or 600 Ohm) are overloaded and have been switched off.

The output stage can be damaged by an unacceptably high external signal feed. The frontend can be damaged by an unacceptably high external signal feed from a low-impedance source in the analyzer.

2.1.12 Digital Audio Interfaces

Inputs and outputs for connecting digital consumer instruments and professional studio equipment.

Requires the R&S UPV-B2 option (digital audio interfaces)



UNBAL

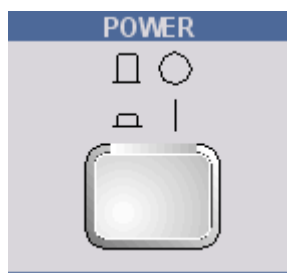
BNC sockets

OPTICAL

Optical interface conforming to EIAJ CP-340, TOSLINK system

BAL

XLR female and male connector

2.1.13 Power Switch

The ON/OFF switch switches the R&S UPV on and starts the booting process. When switched off, there is immediate bipolar disconnection of the R&S UPV from the mains supply.

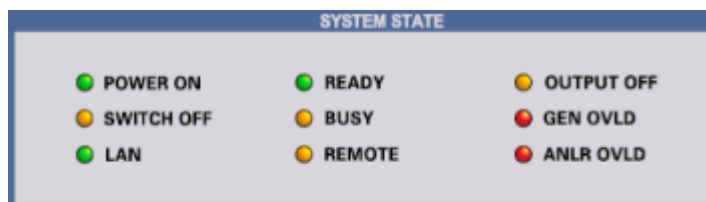
NOTICE**Risk of data loss**

There is a risk of data loss if the R&S UPV is switched off without first shutting down the operating system.

It is urgently recommended to shut down the operating system **before** switching off the instrument (SHUT-DOWN key or via mouse operation). Shutting down the operating system ensures that open files are closed properly.

2.1.14 Status LEDs

With the R&S UPV66 audio analyzer, the instrument's state is indicated via LEDs.



The individual LEDs have the following meaning:

POWER ON

The instrument is switched on

SWITCH OFF

The operating system has been shut down; you can now switch off the instrument.

LAN

The instrument is connected to a local area network.

READY

The measurement instrument is ready for operation

BUSY

Lights as long as a measurement is running

REMOTE

The instrument is in remote operation

OUTPUT OFF

All outputs of the R&S UPV66 audio analyzer are switched off

GEN OVLD

Generator is overloaded

ANLR OVLD

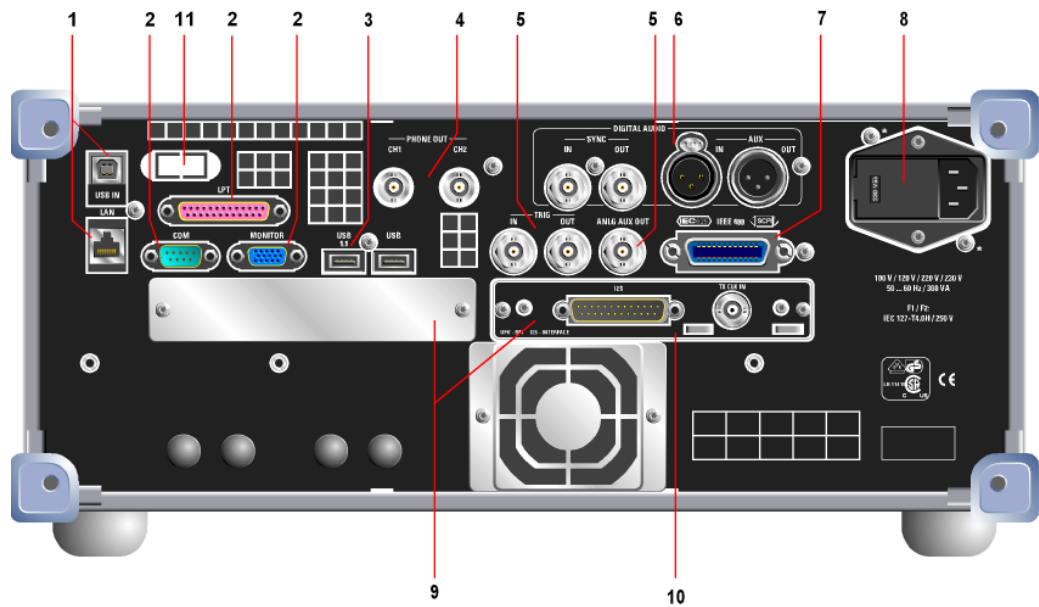
The low-impedance input resistors (300 Ohm or 600 Ohm) are overloaded and have been switched off.

UNBAL

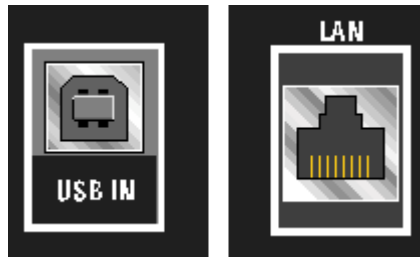
BNC sockets

2.2 Description of the Rear Panel

This section provides an overview of the ports on the rear panel of the R&S UPV / R&S UPV66.



2.2.1 Remote control connectors



USB IN

USB device socket for remote operation of the audio analyzer (with the R&S UPV-K4 option)

LAN

LAN interface for

- Integration of the audio analyzer in a network
- Remote operation of the audio analyzer from a remote computer
- Remote control of the audio analyzer (with the R&S UPV-K4 option)

2.2.2 PC Interfaces



COM

RS 232-C interface, 9-pin D-Sub connector (**not** with internal control computer FMR9. For R&S UPV, the FMR9 is installed for serial number 103000 or higher; for R&S UPV-66, it is installed for serial number 101000 or higher; see [chapter 2.6.1, "Retrieving Computer Hardware Information and Windows Operating System"](#), on page 50).

It is recommended to use an extremely well shielded cable for connecting the R&S UPV via the RS 232-C interface.

LPT

Parallel printer interface, 25-pin D-Sub socket (**not** with internal control computer FMR9. For R&S UPV, the FMR9 is installed for serial number 103000 or higher; for R&S UPV-66, it is installed for serial number 101000 or higher; see [chapter 2.6.1, "Retrieving Computer Hardware Information and Windows Operating System"](#), on page 50).

To connect a printer, use a well-shielded cable.

MONITOR

Connector for an external monitor, 15-pin D-Sub socket, 3-tier.

Use an extremely well shielded cable with ferrite cores to connect the external monitor to the R&S UPV.

DVI-D

Connector for an external digital monitor, 24-pin D-Sub socket, 3-tier (**only** with internal control computer FMR9. For R&S UPV, the FMR9 is installed for serial number 103000 or higher; for R&S UPV-66, it is installed for serial number 101000 or higher; see [chapter 2.6.1, "Retrieving Computer Hardware Information and Windows Operating System"](#), on page 50).

Use an extremely well shielded cable with ferrite cores to connect the external digital monitor to the R&S UPV.

2.2.3 USB Sockets

USB (Universal Serial Bus) interfaces of type A (host USB).

- Connecting peripherals such as mouse, keyboard, printer
- Connecting a USB stick for transferring files

There are additional USB interfaces on the front of the instrument.

2.2.4 BNC Phone Out



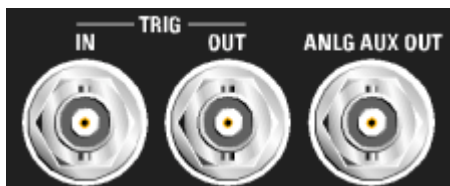
The signal that is output on these BNC sockets is the same as the signal on the head-phone output on the front panel.



Note

Requires the R&S UPV-U2 option (BNC audio monitoring outputs).

2.2.5 Trigger, Aux ports



TRIG IN

Input for triggering measurements

TRIG OUT

Trigger output and clock output

ANLG AUX OUT

Additional analog output for special applications

- DC output, e.g. for supplying power to hearing aids
- Output for the analog generator signal via an integrated amplifier for the direct actuation of small loudspeakers

2.2.6 Digital synchronization and expansion interfaces

Inputs and outputs for reference and sync signals for the R&S UPV-B2 option (digital audio interfaces)

**Note**

These interfaces are only available if the R&S UPV-B2 option is installed.

SYNC IN

Synchronization input for word-clock signals

SYNC OUT

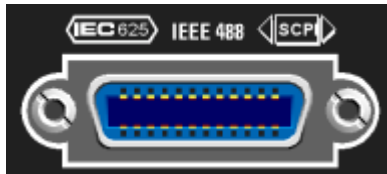
Output for synchronizing external digital devices with the word clock or bitphase clock of the R&S UPV

AUX IN

Input for a digital audio reference signal (DARS)

AUX OUT

Output for a digital audio reference signal (DARS) generated by the R&S UPV

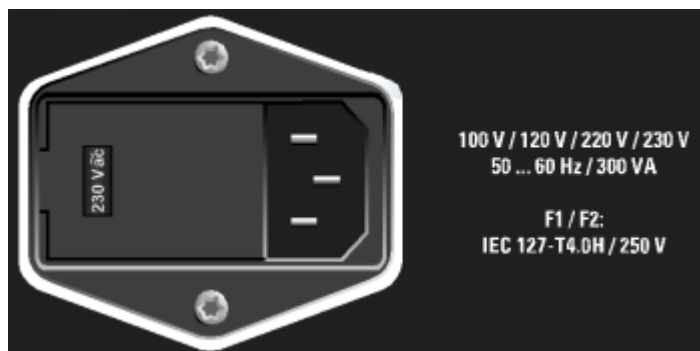
2.2.7 IEC/IEEE-bus socket

IEC bus socket (IEC 625/IEEE 488) for remote control of the R&S UPV

**Note**

Requires the R&S UPV-K4 option (remote control).

2.2.8 Mains Voltage Connector



Mains voltage connector with indication of the set nominal mains voltage

NOTICE

Caution

The R&S UPV must be set to the nominal voltage of the AC system used. Before switching on the instrument for the first time, check whether the correct mains voltage is set.

2.2.9 Slots for extension units

Two slots are provided on the rear panel of the R&S UPV for extension units (see Chap. 4 and data sheet). The following can be installed in addition to or as an alternative to the UPV-B2 option (digital audio interfaces AES/EBU, S/P DIF) on the front panel:

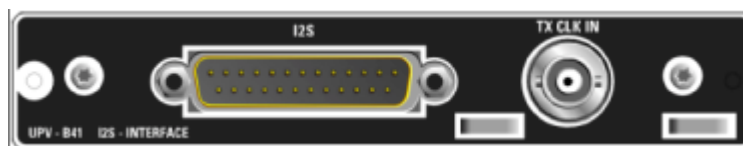
- 1 x UPV-B41 (I²S interfaces)
- 1 x UPV-B42 (Universal Serial Interface)
- 2 x UPV-B48 (Eight-Channel Analog Inputs).

If both slots are occupied by the UPV-B48, 16 analog input channels are available.

The left plug-in slot at the rear panel of the R&S UPV is designated as Slot 1, and the right one as Slot 2. The installation manual included with the option refers to this designation.

2.2.10 I²S interface

The R&S UPV-B41 option, which is an I²S interface, is shown here as an example of how an extension unit can be installed in addition to or as an alternative to the UPV-B2 (digital audio interfaces AES/EBU, S/P DIF).



I²S

25-contact D-Sub connector for connecting the input and output lines of the I²S interfaces. The interface assignment is described in Chapter 4. To connect the DUT, use a well-shielded cable.

TX CLK IN

Additional BNC connector for connecting an external master clock signal. Details are provided in Chapter 4.

2.2.11 LAN RESET Pushbutton



Note

This pushbutton is present only on the R&S UPV66 model.

The LAN RESET pushbutton has three functions:

- Resets the LAN default settings:
To do this, you have to press the pushbutton for 5 seconds until the READY LED switches off on the front panel of the R&S UPV66.
- Shuts down the operating system:
If the operating system of the R&S UPV66 is to be shut down manually without using a mouse, this is done by pressing the LAN RESET pushbutton three times within 5 seconds.
- Master PRESET:
With the Master PRESET, you can easily get out of an unsuitable screen and monitor configuration and back to an operable instrument: Switch the instrument off and on again. During the software start, the OUTPUT Off-LED is illuminated briefly in yellow. As soon as this LED is illuminated in yellow, press the LAN RESET pushbutton briefly. The LED flashes for confirmation. Within the next 5 seconds, press the LAN RESET pushbutton again briefly. The Master PRESET is now carried out and forces a switchover to the external monitor with a screen resolution of 800 x 600 pixels and the factory default settings.

2.3 Putting into Operation

The following section describes how to put the instrument into operation, connect external devices such as printer and monitor, and a connection of the audio analyzer with a network. It contains general safety instructions for instrument operation.

For information about installing options, see [chapter 2.9, "Installing Options"](#), on page 67.

For information about the firmware update, see [chapter 2.11, "Firmware Update"](#), on page 83.

CAUTION

Safety precautions

Be absolutely sure to follow the instructions in the sections below to prevent injury to people or damage to the instrument. This is particularly important if the instrument is used for the first time. The general safety instructions at the beginning of this manual must also be observed.

2.3.1 Unpacking the instrument

The instrument is delivered together with the accessories in one box. Proceed as follows to unpack its contents:

1. Remove the instrument from its packaging and check the shipment for completeness using the shipping document and the accessory lists for the various items.
2. First, pull off the protective plastic pads from the rear feet of the instrument and then from the front handles.
3. Remove the protective cover made of corrugated board from the rear of the instrument.
4. Carefully unthread the corrugated cardboard cover at the front that protects the instrument handles and remove it.
5. Check the instrument for any damage. If there is damage, immediately contact the carrier who delivered the instrument. In this case, do not discard the box and packaging material.



Packaging material

It is recommended to retain the packaging. It is advisable to keep the original packing material in order to prevent control elements and connectors from being damaged in case the instrument is to be transported or shipped at a later date.

2.3.2 Setting Up the Instrument

The instrument is intended for indoor use. It can either be set up as a separate unit or mounted in a 19" rack.

The following ambient conditions at the location must be ensured:

- The ambient temperature must comply with the range specified in the data sheet.
- All fan openings must be clear, and the airflow at the openings of the side walls must not be impeded. The distance to the wall must be at least 10 cm.

NOTICE

Possible damage from electrostatic discharge



Electrical discharges can damage components of the instrument or a connected device under test.

For this reason, the instrument may be operated only at a workplace that is protected against electrostatic discharge.

The following methods can be used separately or in combination to protect against electrostatic discharges:

- Protective armband with grounding cable
- Conductive floor covering combined with use of a heel grounder

NOTICE

EMI Suppression

To suppress electromagnetic interference (EMI), the instrument may be operated only if it is closed and all covers are in place. The EMC class is listed on the data sheet.

The following conditions must be maintained to avoid interference:

- Use suitable double-shielded cables that are no longer than 3 m.
 - Use only USB cables that are no longer than 1 m.
 - Use only USB devices that adhere to the permissible EMC values.
 - Terminate the outputs and cables with 50 Ω .
 - Use only the cables R&S UP-Z2, R&S UP-Z3 and R&S UP-Z4 for the digital interfaces.
 - Use the cable R&S UP-Z8A for the analog interface of option R&S UPP-B8, and cable R&S UP-Z8D for the digital interface.
 - Use only doubled shielded CAT6 or CAT7 cables for the LAN interface.
-

2.3.2.1 Separate installation

The R&S UPV can be set up on a level surface in horizontal position and with unfolded instrument feet.

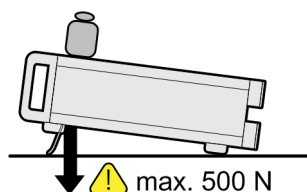
⚠ CAUTION

Risk of injury with unfolded instrument feet

The instrument feet can suddenly fold back if the instrument is being moved or the feet are not completely folded out. This can lead to personal injuries or damage to the instrument.

Instrument stability, and thus safe operation, is only ensured when the instrument's feet are completely folded out. Do not move the instrument and avoid performing work under it when the feet are folded out. Secure the instruments from slipping (e.g. by locking the instrument feet to the top of the front-panel frame).

If excessive loads are applied, the feet might break. The uniformly applied load to the feet when folded out must not exceed 500 N (including the weight of the instrument itself along with any equipment set on top of it).



2.3.2.2 Rack installation

A rack adapter (refer to data sheet for Order No.) is required for installation in a 19" rack. The mounting instructions are supplied with the adapter.

NOTICE

Possible damage to the instrument from overheating

Restricted airflow at the side wall openings can cause the instrument to overheat.

To ensure sufficient air supply, all fan openings must be clear and the airflow at the openings of the side walls must not be impeded. The distance to the wall must be at least 10 cm.

2.3.3 Connecting the R&S UPV to the AC Supply

NOTICE

Possible damage to the instrument

Before connecting and switching on the instrument, observe the following items to avoid any damage to the instrument:

- The tube for the housing has to be attached and screwed in place.
- The ventilation openings must be clear; ensure that air can freely exit at the holes on the sides. The minimum distance to the wall should therefore be at least 10 cm.
- The instrument must be dry.
- The instrument should only be operated in the horizontal position on an even surface.
- The ambient temperature must not exceed the range specified in the data sheet.
- It must be ensured that none of the voltage levels at the inputs exceed permissible limits.
- The instrument complies with measuring category I; the input voltage at the connectors of the analog analyzers should not exceed 110 V (effective, sinusoidal) and 160 V (peak value). Do not use the instrument in measuring categories II, III and IV.

Explanation:

Measuring circuits as defined in section 6.7.4 of EN61010-1

Measuring category I is intended for measurements on circuits which are not connected to the high-voltage current system.

- The outputs of the instrument should not be overloaded and correct polarity must be ensured.

The AC supply connector socket is at the rear of the instrument. The instrument can be set up for connection to AC supply systems of 100 V, 120 V, 220 V and 230 V and can be operated with $\pm 10\%$ tolerance and an AC supply frequency of 47 Hz to 63 Hz. The instrument is also suitable for operation with power supply systems with the other nominal voltages specified in the table below

Nominal AC supply voltage	Voltage selector setting	Tolerance of instrument
110 V	100 V	+4 %
		-18 %
	120 V	+20 %
		-6 %
115 V	120 V	+15 %
		-10 %
127 V	120 V	+4 %
		-18 %

Nominal AC supply voltage	Voltage selector setting	Tolerance of instrument
240 V	230 V	+10 %
		-14 %

2.3.3.1 Setting the Supply Voltage

NOTICE

Possible damage to the instrument from incorrect AC supply voltage

An incorrect AC supply voltage setting can lead to damages to the instrument when the instrument is connected to the AC supply.

For this reason, check whether the correct AC supply voltage is set before switching on the instrument for the first time.

The AC supply voltage can be changed as follows:

1. Disconnect the power cable.
2. Open the flap covering the voltage selector using a small screwdriver (or similar).
3. Remove the cylinder labeled with the nominal voltages and reinsert it so that the value visible through the hole in the cover flap when refitted corresponds to the desired nominal voltage. If the desired voltage is not printed on the cylinder, select the nearest suitable value according to the table above.
4. Close the flap.



The R&S audio analyzer UPV is operated with the same AC fuses for all specified rated AC supply voltages. The precise designation of the fuses is indicated on the rear of the instrument.

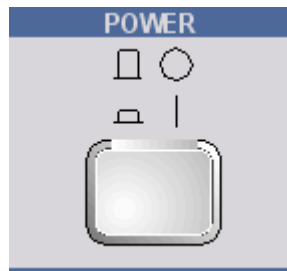
2.3.3.2 Switching on the Instrument

1. Connect the audio analyzer to the AC supply by means of the supplied power cable.

The R&S UPV is in compliance with safety class EN61010-1, it should only be connected to a socket with grounding contact.



2. Press the power switch on the front of the instrument. The instrument starts the booting process and all modules are supplied with power.




2.3.3.3 Start Screen and Booting of the R&S UPV

After the instrument is turned on, the BIOS version that is installed and the computer characteristics are displayed on the screen for several seconds.

Afterwards, the Windows operating system boots first followed by the instrument firmware. A self-test is carried out while instrument firmware is booted. The most recent instrument settings saved automatically at power-off are then loaded so that the instrument is in the same state as it was before power-off. After booting is completed, the audio analyzer screen is displayed and the instrument can be operated manually or via remote control.

2.3.3.4 Restarting the R&S UPV

If the R&S UPV firmware was closed without shutting down the operating system (e.g. by clicking on the  icon in the title bar or ALT F4 on the keyboard), the program can be restarted with the mouse in two ways:

- Clicking on the "R&S UPV" icon on the desktop
- Clicking on the Start button in the taskbar, and then selecting the folders "All Programs, Rohde & Schwarz, UPV" and clicking on the "R&S UPV" icon



If the software should crash unexpectedly and the instrument is operated via the front panel, it can only be rebooted by pressing the power switch. When using an external keyboard and a mouse, we recommend carrying out a warm start first using the shortcut Ctrl+Alt+Del (restart) or trying the Restart icon with the green arrow.

2.3.3.5 Switching Off

NOTICE

Risk of data loss

There is a risk of data loss if the R&S UPV is shut down without shutting down the operating system first. This may cause trouble during the boot process the next time the instrument is switched on.

We strongly recommend shutting down the operating system **before** switching off the instrument (SHUTDOWN button or via mouse operation). Shutting down the operating system ensures that open files are closed properly.

Model R&S UPV

1. Press the SHUTDOWN button on the front of the instrument.



The R&S UPV stores the current settings on the hard disk and then shuts down the operating system.

2. Power switch POWER on the front of the instrument

The instrument is disconnected from the AC supply, and power is removed from all modules.



Alternatively, the operating system can also be shut down in the same way as other Windows applications by using the mouse: Start, Shut Down, OK or the red Shutdown icon.

Model R&S UPV66

1. Press the LAN RESET button at the rear of the instrument three times within 5 seconds.

The R&S UPV stores the current settings on the hard disk and then shuts down the operating system.

2. Wait until the operating system has shut down and the SWITCH OFF LED is on.

SYSTEM STATE		
● POWER ON	● READY	● OUTPUT OFF
● SWITCH OFF	● BUSY	● GEN OVLD
● LAN	● REMOTE	● ANLR OVLD

- Press the POWER switch on the front of the instrument.

The instrument is disconnected from the AC supply, and power is removed from all modules.



For remote control, you can also shut down the operating system by using the `SYSTem:SHUTdown` SCPI command.

Alternatively, the operating system can also be shut down in the same way as other Windows applications by using the mouse: Start, Shut Down, OK or the red Shutdown icon.

2.4 Function Check

The audio analyzer monitors the most important instrument functions automatically when it is switched on.

2.5 Presets

Pressing the PRESET key loads a set of defined instrument settings.



The preset function sets all parameters and settings, even those of inactive operating modes.

The most important parameters set here are:

Generator frequency (analog)	1 kHz
Generator level (analog)	0.1 V
Generator signal	Sinusoidal
Generator frequency (digital)	997 Hz
Generator level (digital)	0.1 FS
Generator signal	Sinusoidal
Generator output impedance	5 Ω
Analyzer interface (analog)	XLR measuring input (analog)
Analyzer interface (digital)	XLR measuring input (digital)
Analyzer function	RMS

Analyzer input impedance	200 kΩ
Frequency measurement	ON

2.6 Windows Operating System

NOTICE

Possible malfunction of the instrument function due to external software

The instrument operates under the Windows operating system. This allows external software programs to be installed on the instrument. The use and installation of commercial off-the-shelf (COTS) software may impair the instrument's functionality.

For this reason, we recommend that you only execute programs tested by Rohde & Schwarz with regard to their compatibility with the instrument software. In certain cases, the use of these programs may also impair the performance of the instrument.

The drivers and programs used in the instrument under Windows have been adapted to the measuring instrument. Existing instrument software must only be modified with update software released by Rohde & Schwarz.

Only the settings described below may be performed.

In its delivery state, the configuration of Windows is optimized to the functions of the audio analyzer. Changes in the system setup are only required when peripherals like a keyboard or printer are installed or in the event that the network configuration does not correspond to the default settings (see sections below). After switching on the audio analyzer, the operating system boots and the instrument firmware is started automatically without a password prompt (auto login).

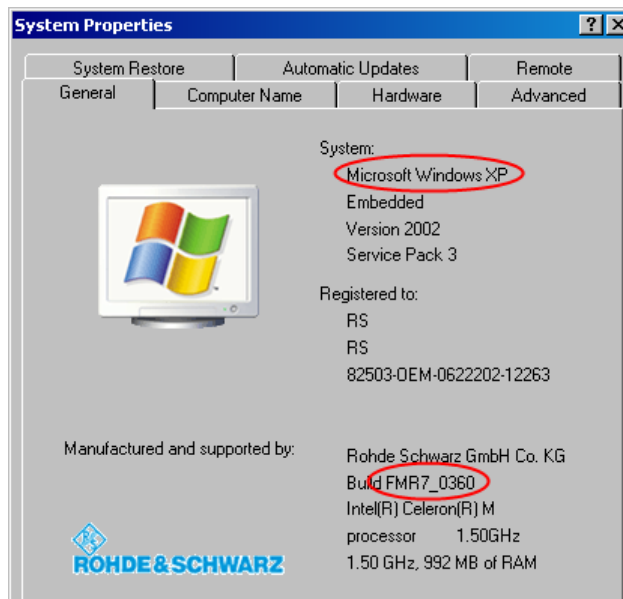


Auto login is performed with the user name and the password "instrument". The standard user has administrator rights so that printer and network installations are possible.

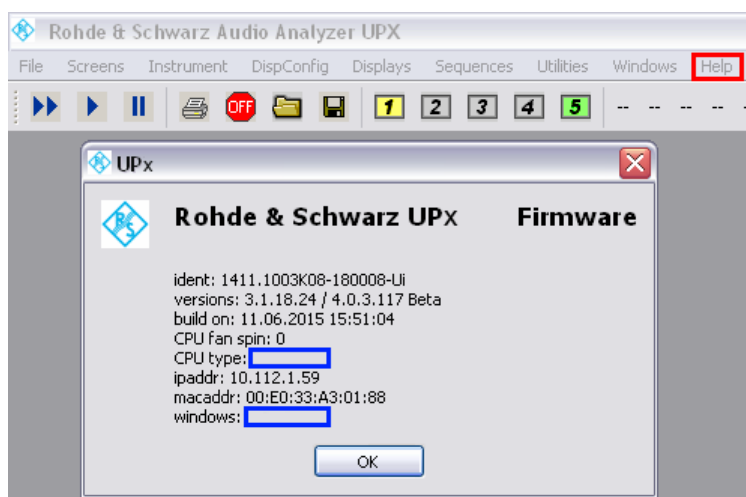
The operating system can only be accessed if an external keyboard is connected. The Windows key on the external keyboard (next to the STRG key) opens the Windows start menu; the Windows programs can then be called from this menu. Connecting a mouse makes Windows easier to use. The system settings under Windows are entered in the menu "Start – Control Panel" (see the description of Windows and the hardware for information on the necessary settings). The R&S UPV does not feature a diskette drive. Data is exchanged using a USB stick which is inserted into one of the USB interfaces. The USB stick is automatically assigned a free drive letter and the data can be transferred in Windows Explorer.

2.6.1 Retrieving Computer Hardware Information and Windows Operating System

The function of some interfaces depends on which internal computer hardware the R&S UPV has been equipped with. This description makes reference to the computer hardware at some points. With **firmware versions 3.x** and older, the **Windows version** and the **computer hardware information** can be retrieved as follows: Call up the system settings under Windows via the menu "Start – Control Panel – System". This opens a window with the name "System Properties". The desired information can be found under the "General" tab:



With **firmware version 4.x**, the **computer hardware information** can be checked directly in the firmware via "Help" – "About" under "CPU type:", and the **Windows version** can be checked under "Windows:".



2.7 Connecting External Keyboard and Mouse

2.7.1 Connecting an External Keyboard.

The R&S UPV allows connecting a commercially available, external keyboard with USB interface. A keyboard simplifies the input of list entries, comment texts, file names, etc. and is required for operating Windows.

The keyboard is connected to one of the USB interfaces at the front or rear of the instrument.

The keyboard is detected automatically when it is connected. The US keyboard assignment is the default setting. A change of the keyboard language assignment and special settings, such as the repeat rate etc., can be performed in the Windows menu "Start - Control Panel - Keyboard" or "Regional and Language Options". The menu is opened by pressing the Windows key on the external keyboard.

2.7.2 Connecting an External Mouse

The R&S UPV allows connecting a commercially available mouse with USB interface. The mouse makes it easier to move and resize the panels / graphical windows on the screen and provides alternative operating modes. This is recommended for convenient operation of Windows.

The mouse is connected to one of the USB interfaces on the front or rear of the instrument.

The mouse is detected automatically when it is connected. Special settings, such as the speed of the mouse cursor etc., can be performed in the Windows menu "Start - Control Panel - Mouse". The menu is opened by pressing the Windows key on the external keyboard.

2.8 Connecting an External Monitor

NOTICE

Possible Impairments to Instrument Function

Make sure that the instrument is switched off before connecting the monitor. Otherwise, the monitor or the R&S UPV may be damaged.

Do not modify the screen driver (Display type) and the display configuration since this will impair instrument operation.

For instruments with computer hardware FMR9 and FMR11, the R&S UPV provides the possibility of connecting an external monitor with analog interface to the MONITOR

port or with digital interface to the DVI-D socket on the rear of the instrument (see [chapter 2.6.1, "Retrieving Computer Hardware Information and Windows Operating System"](#), on page 50).

For the interface description of the connecting socket, see [chapter 8.4.7, "Monitor Connector \(MONITOR\)"](#), on page 1052.

Connection


To prevent damage to the monitor and R&S UPV, the instrument must be switched off before an external monitor is connected. After connection, the external monitor is detected when the instrument is started (but not if it is connected while the instrument is in operation). The screen contents with all elements, e.g. panels, measurement displays, softkey bar, etc., appear on the external monitor. No further settings are needed.

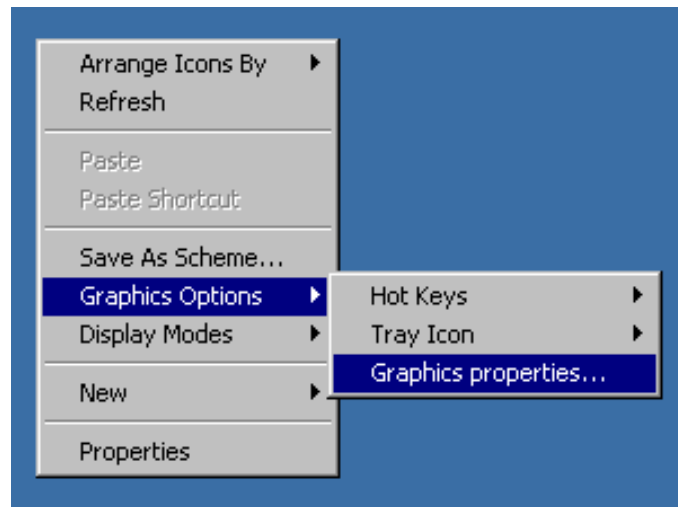
2.8.1 Changing Screen Resolution of External Monitor under Windows XP

The R&S UPV audio analyzer is equipped with an internal computer. Up to February 2007, the instruments were supplied with a computer bearing the internal Rohde & Schwarz designation FMR6, from March 2007 with FMR7, from March 2012 with FMR9 and from February 2015 with FMR11 (see also [chapter 2.6.1, "Retrieving Computer Hardware Information and Windows Operating System"](#), on page 50). Instruments with FMR11 support Windows 7 only; see the next chapter. The procedure for setting the screen resolution when using an external monitor is different for the three computer models. The procedure for each is described separately below.

Devices with FMR6

Setting external monitor resolution to higher than 800 x 600 pixels

1. Switch off R&S UPV.
2. Connect the external monitor, keyboard and mouse.
3. Switch on R&S UPV.
4. After starting the R&S UPV, exit or minimize the UPV program by clicking on the  buttons on the right in the title bar.
5. Right-click on the desktop to open the following context menu.



6. Select "Graphics properties...".
7. Click on the "Monitor" icon.



8. Place the focus on the "True Color" field.



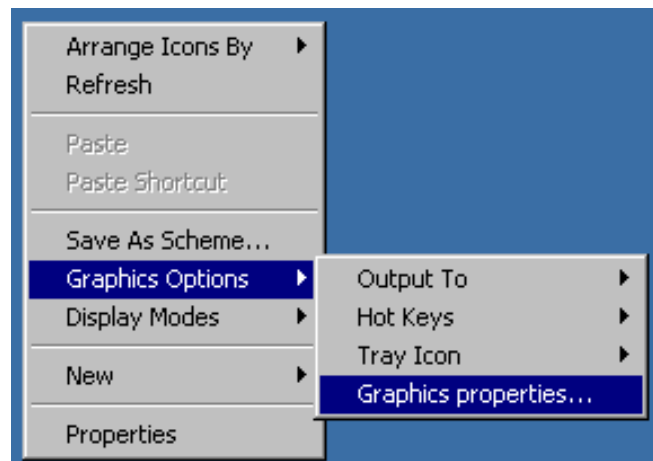
9. Select the hidden button (press the TAB key three times, then press the spacebar and click the "Apply" button).

The internal LC screen (digital display) will be switched off.

- Click on "OK" to confirm the change, then on "OK" to close the window.

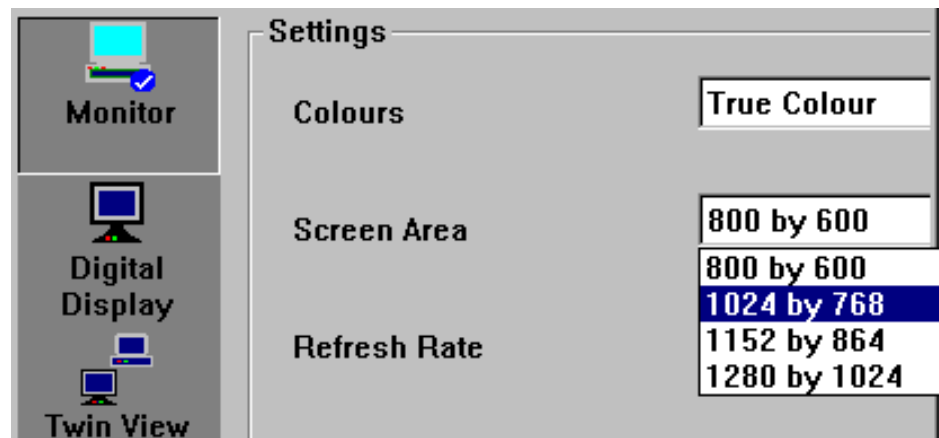
You can now set the external monitor to a resolution higher than 800 x 600 pixels.

- Right-click on the desktop to open the following context menu again:



- Select "Graphics properties..."

- In the Screen Area field, select the desired resolution, e.g. "1024 by 768".




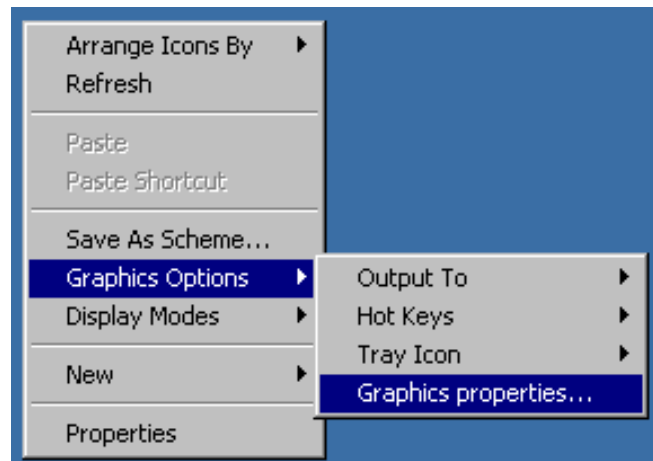
- Click on "Apply".

- Click "OK" to confirm the change, and then click "OK" again to close the window.

Resetting the External Monitor to a Resolution of 800 x 600 Pixels

The external monitor, mouse and keyboard are connected to the R&S UPV, the R&S UPV is switched on.

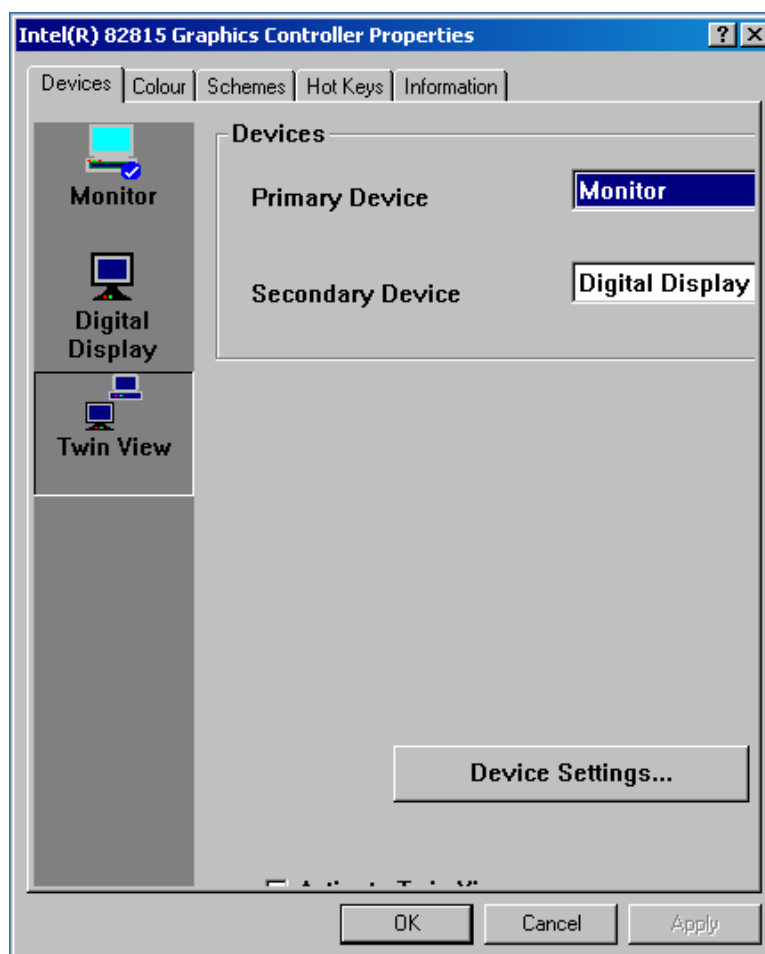
- Exit or minimize the UPV program by clicking on the  buttons on the right in the title bar.
- Right-click on the desktop to open the following context menu again:



3. Select "Graphics properties...".
4. Click on the "Twin View" icon.



5. Place the focus on the "Monitor" field as shown in the figure below.




6. Select the hidden button (press the TAB key three times), then press the spacebar and click the "Apply" button.

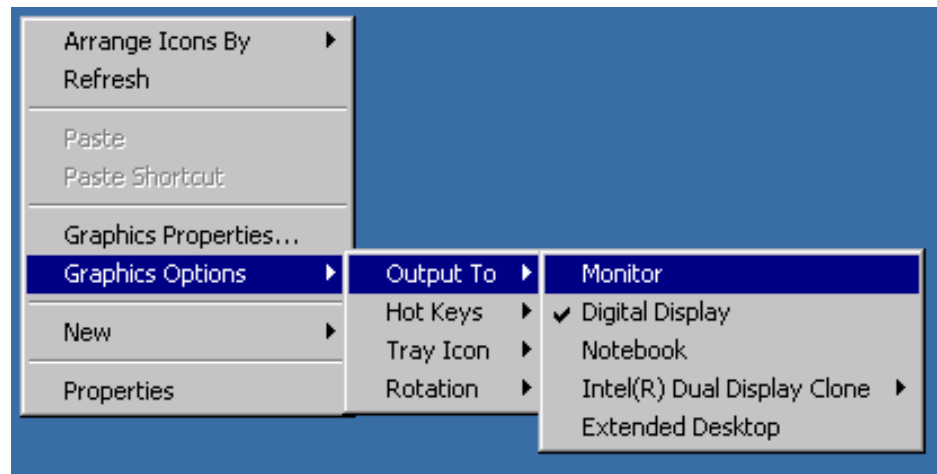
The resolution is reset to 800 x 600 pixels. This is the same as for the internal LC display, which is switched on again.

7. Click on "OK" to confirm the change, then on "OK" to close the window.

Devices with FMR7

Setting external monitor resolution to higher than 800 x 600 pixels

1. Switch off R&S UPV.
2. Connect the external monitor, keyboard and mouse.
3. Switch on R&S UPV.
4. After starting the R&S UPV, exit or minimize the UPV program by clicking on the  buttons on the right in the title bar.
5. Right-click on the desktop to open the following context menu.

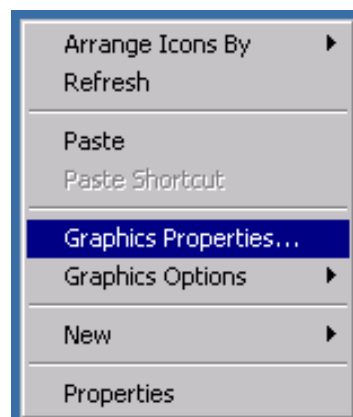


6. Select "Monitor".

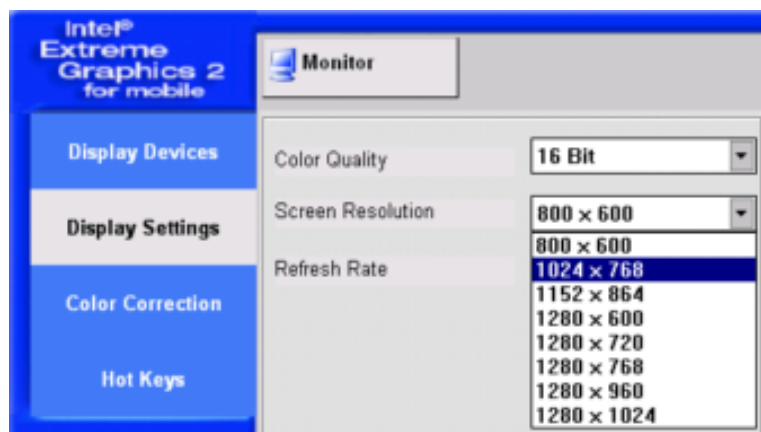
Switch off the internal LC screen and switch on the external monitor if it was previously switched off.

You can now set the external monitor to a resolution higher than 800 x 600 pixels.

7. Right-click on the desktop to open the following context menu.




8. Select "Graphics Properties ...".
9. Select "Display Settings" and then choose the desired resolution, e.g. "1024 x 768".

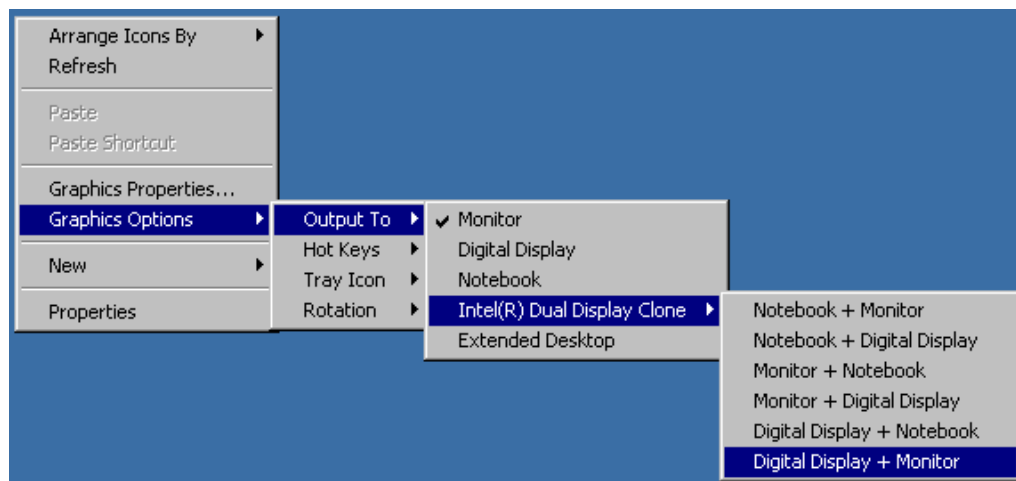


10. Click on "Apply".
11. Click "OK" to confirm the change, and then click "OK" again to close the window.

Resetting the External Monitor to a Resolution of 800 x 600 Pixels

The external monitor, mouse and keyboard are connected to the R&S UPV, the R&S UPV is switched on.

1. Exit or minimize the UPV program by clicking on the  buttons on the right in the title bar.
2. Right-click on the desktop to open the following context menu again:



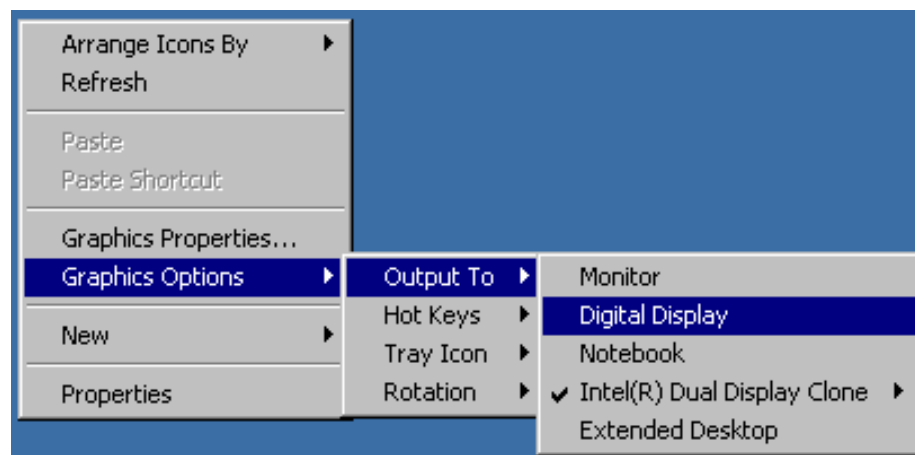
3. Select "Digital Display + Monitor".

The resolution is reset to 800 x 600 pixels. This is the same as for the internal LC display, which is switched on again.

Switching Off the External Monitor

The external monitor, mouse and keyboard are connected to the R&S UPV, the R&S UPV is switched on.

1. Right-click on the desktop to open the following context menu again:




2. Select "Digital Display".
The external monitor is switched off.

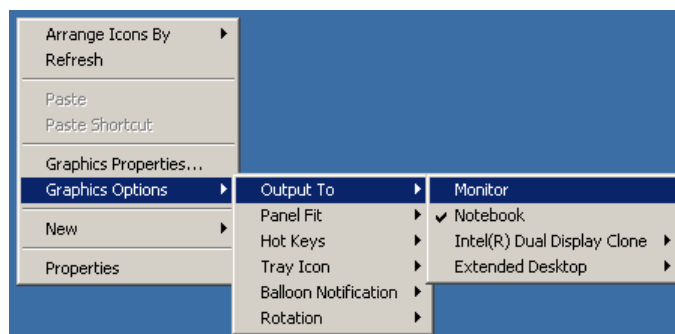
Devices with FMR9

Special features with the FMR9:

The Windows XP operating system used is only able to support a maximum of two monitors simultaneously. One of the two monitors is the internal LC display, which means that only one external monitor can be controlled even if the R&S UPV with FMR9 has an analog VGA **and** a digital DVI port. The default setting assumes that the internal monitor and one external analog VGA monitor will be used. The connected external monitor determines the behavior during the boot procedure depending on the selected setting under Windows: If an external analog VGA monitor is connected and "Notebook + Monitor" has been selected under Windows, both screens will show the same content during the boot procedure and when Windows is running. If a digital DVI monitor is connected, the internal display will remain dark during the boot procedure until Windows becomes active, regardless of its Windows setting. Only after this will both displays show the same content in parallel if "Notebook + Digital Display" was selected under Windows. Otherwise only the internal display becomes active under Windows.

Setting the External Monitor Resolution to Higher than 800 x 600 Pixels

1. Switch off R&S UPV.
2. Connect the external monitor, keyboard and mouse.
3. Switch on R&S UPV.
4. After starting the R&S UPV, exit or minimize the UPV program by clicking on the  buttons on the right in the title bar.
5. Right-click on the desktop to open the following context menu.

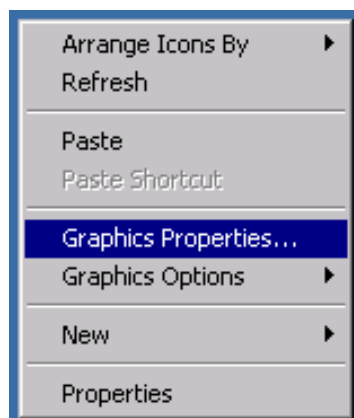


6. Select "Monitor".

Switch off the internal LC screen and switch on the external monitor if it was previously switched off.

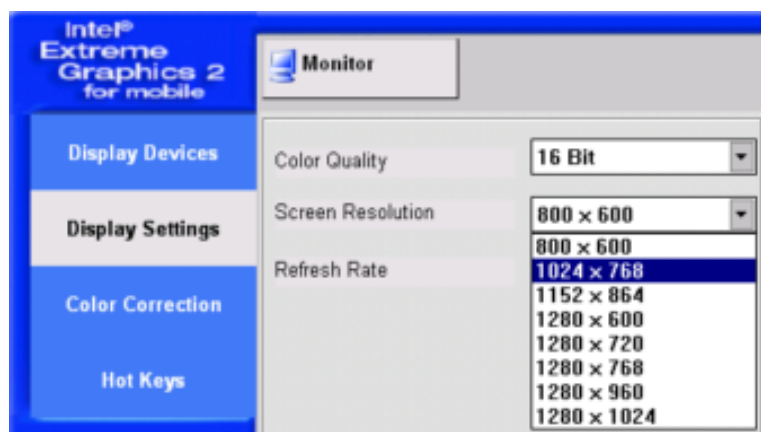
You can now set the external monitor to a resolution higher than 800 x 600 pixels.

7. Right-click on the desktop to open the following context menu.



8. Select "Graphics properties..."

9. Select "Display Settings", then select the desired resolution, e.g. "1024 by 768".




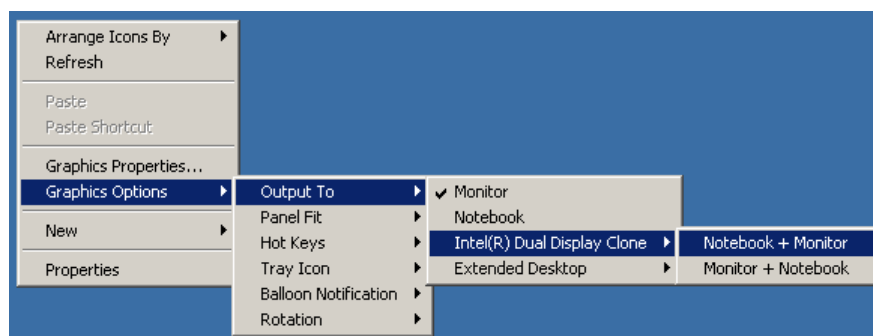
10. Click on "Apply".

11. Click "OK" to confirm the change, and then click "OK" again to close the window.

Resetting the External Monitor to a Resolution of 800 x 600 Pixels

The external monitor, mouse and keyboard are connected to the R&S UPV, the R&S UPV is switched on.

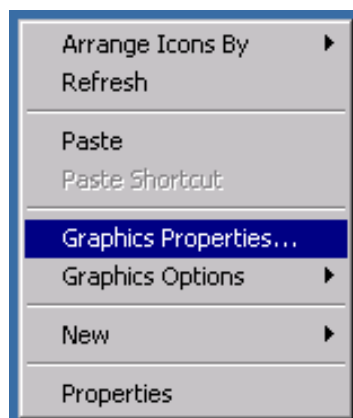
1. Exit or minimize the UPV program by clicking on the  buttons on the right in the title bar.
2. Right-click on the desktop to open the following context menu again:



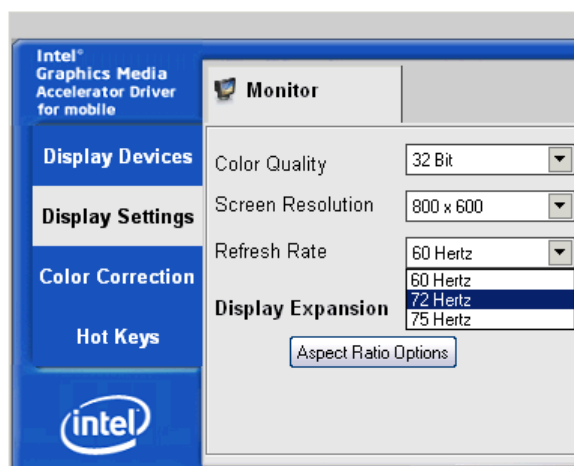
3. Select "Notebook + Monitor".

The resolution is reset to 800 x 600 pixels. This is the same as for the internal LC display, which is switched on again.

On some monitors, it may be possible to utilize only a limited part of the screen – and not the entire screen – after switching the resolution. To expand the contents to match the entire screen area, the following settings must be performed: Right-click on the desktop to open the following context menu.



Select "Graphics Properties". Under "Display Settings" and the "Monitor" tab, select a sampling frequency of 72 Hz in the "Display Expansion" field.

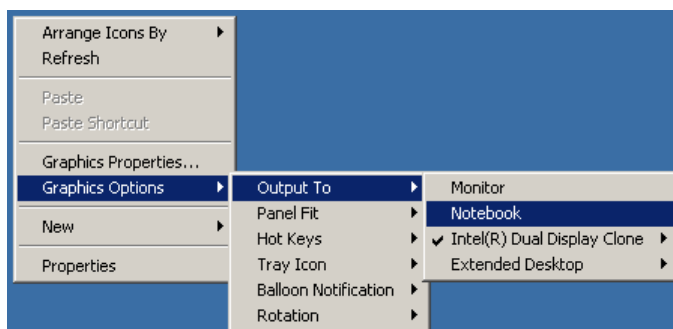


Click on "Apply", then click on "OK" twice to apply the change. The content will then be expanded to the entire screen area.

Switching Off the External Monitor

The external monitor, mouse and keyboard are connected to the R&S UPV, the R&S UPV is switched on.


1. Right-click on the desktop to open the following context menu again:

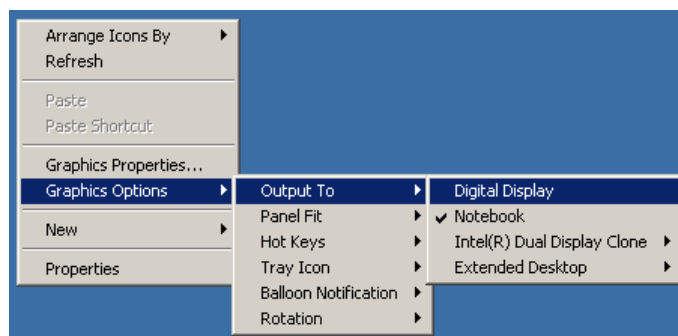


2. Select "Notebook".

The external monitor is switched off.

Setting the External Monitor Resolution (Digital DVI Monitor) to Higher Than 800 x 600 Pixels

1. Switch off R&S UPV.
2. Connect the external monitor, keyboard and mouse.
3. Switch on R&S UPV.
4. After starting the R&S UPV, exit or minimize the UPV program by clicking on the  buttons on the right in the title bar.
5. Right-click on the desktop to open the following context menu.

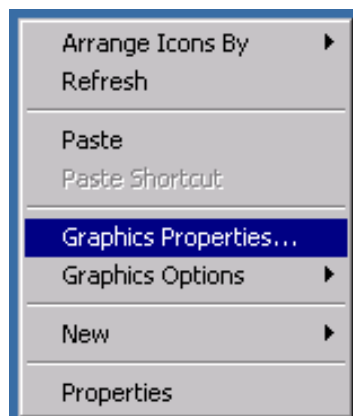


6. Select "Digital Display".

Switch off the internal LC screen and switch on the external monitor if it was previously switched off.

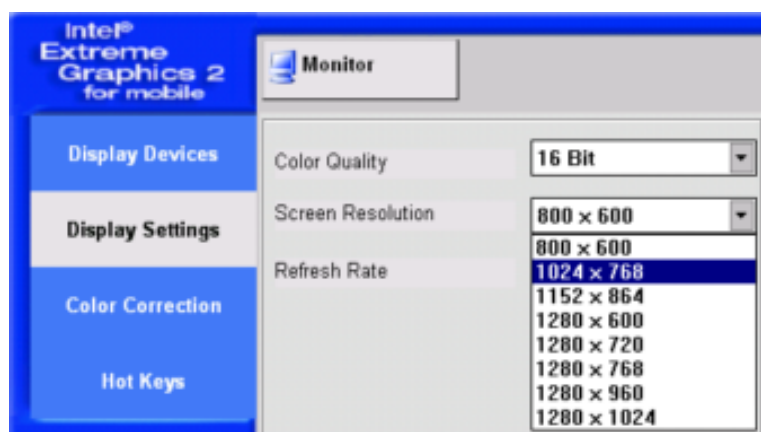
You can now set the external monitor to a resolution higher than 800 x 600 pixels.

7. Right-click on the desktop to open the following context menu.



8. Select "Graphics properties...".

9. Select "Display Settings", then select the desired resolution, e.g. "1024 by 768".




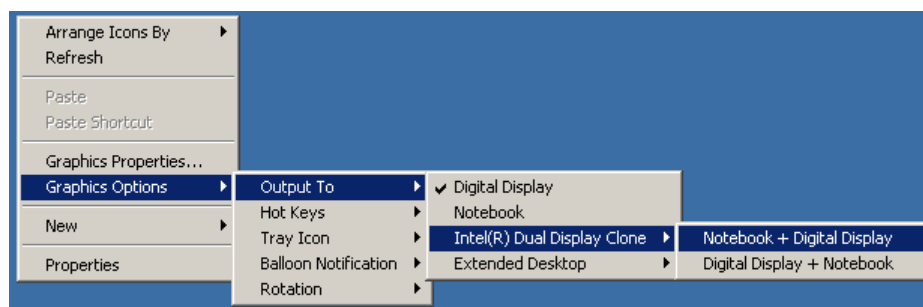
10. Click on "Apply".

11. Click on "OK" to confirm the change, then on "OK" to close the window.

Resetting the External Monitor to a Resolution of 800 x 600 Pixels

The external monitor, mouse and keyboard are connected to the R&S UPV, the R&S UPV is switched on.

1. Exit or minimize the UPV program by clicking on the  buttons on the right in the title bar.
2. Right-click on the desktop to open the following context menu again:



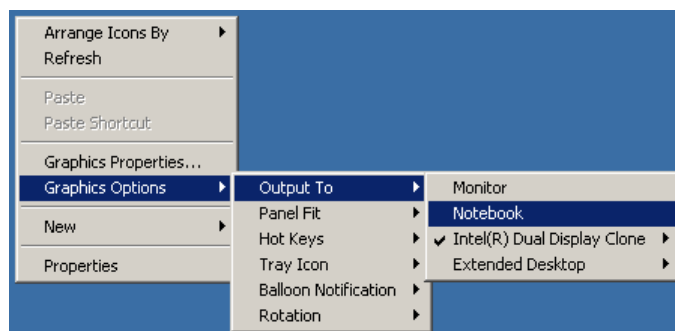
3. Select "Notebook + Digital Display".

The resolution is reset to 800 x 600 pixels. This is the same as for the internal LC display, which is switched on again.

Switching Off the External Monitor

The external monitor, mouse and keyboard are connected to the R&S UPV, the R&S UPV is switched on.

1. Right-click on the desktop to open the following context menu again:



2. Select "Notebook".

The external monitor is switched off.

NOTICE**Internal Display Not Activated**

The graphics driver of the FMR7 and FMR9 computer modules in the R&S UPV saves the screen configuration that was last selected and detects whether an external monitor is connected.

If the R&S UPV was previously operated only with an external monitor and was switched off in that state, the internal display will remain deactivated the next time the R&S UPV is switched on if no external monitor is connected.

Since no external monitor is detected in this case when the instrument is switched on, the monitor output will remain deactivated even if a monitor is connected at a later time.

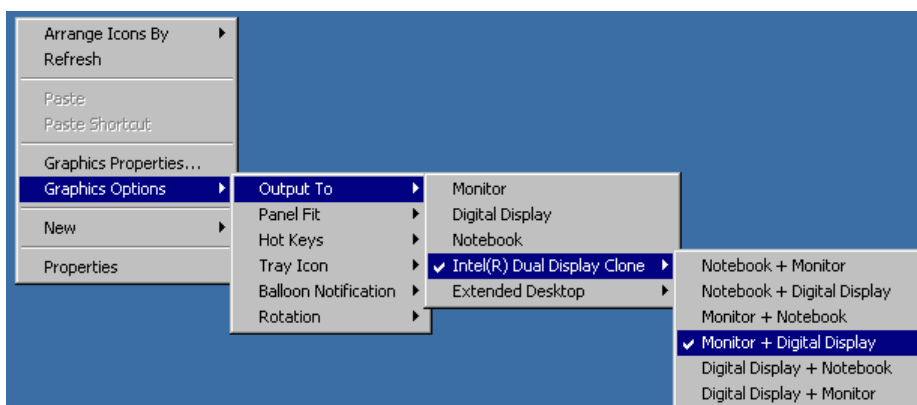
An external keyboard is required to **reactivate** the screen display:

You can switch to the external monitor by using the key combination CTRL + ALT + F1 on an external keyboard.

Before March 2008: You can switch on the internal display by using the key combination CTRL + ALT + F4 on an external keyboard.

Since March 2008, the R&S UPV has been shipped with a new LCD that can be switched on using the shortcut CTRL + ALT + F3.

A special feature of the R&S UPV66 is that it has no internal display. It is therefore possible to control an analog VGA **and** a digital DVI monitor simultaneously. The following settings must be performed to enable this:



Using the shortcut CTRL + ALT + F1 on an external keyboard switches on the external VGA monitor; the shortcut CTRL + ALT + F4 switches on the external DVI monitor if it is to be activated subsequently.

2.8.2 Changing Screen Resolution of External Monitor under Windows 7

The R&S UPV audio analyzer has a built-in computer. Up to February 2007, the instruments were supplied with a computer bearing the internal Rohde & Schwarz designation FMR6, from March 2007 with FMR7, from March 2012 with FMR9 and from Febru-

ary 2015 with FMR11. Instruments with FMR6 do not support Windows 7; see the previous chapter. The procedure for setting the screen resolution when using an external monitor is the same for the different computer models and is described below.

The default factory setting supports clone mode of the internal and, if connected, external VGA screen and means that both screens show the same picture. In this mode, the screen resolution cannot be changed and remains fixed at the resolution of the internal screen, i.e. 800 x 600 pixels. **Instruments with FMR9** support an external monitor with analog interface at the MONITOR port or with digital interface at the DVI-D port on the rear of the instrument. Switchover takes place automatically after the instrument is switched off/on. **Instruments with FMR11** also support these two monitor interfaces; however, a setting in the BIOS must be made for connection of a digital monitor to the DVI interface. The VGA output is then deactivated. The setting in the BIOS is made as follows:


Switching over instruments with FMR11 to external digital monitor

1. Switch off R&S UPV.
2. Connect the external monitor, keyboard and mouse.
3. Switch on R&S UPV.
4. Immediately after switching on, press the Del key repeatedly at short intervals until the BIOS screen appears.
5. In the horizontal menu bar, select "Chipset", then select "System Agent (SA) Configuration", "Graphic Configuration", "LCD Control" and "Secondary IGFX Boot Display" and there set "DVI".
6. Save the settings and exit BIOS.

The digital monitor is now detected.

If it is necessary to switch back to the analog monitor output, this is done in the same way but by setting "CTR".

Setting external monitor resolution to higher than 800 x 600 pixels

1. Switch off R&S UPV.
2. Connect the external monitor, keyboard and mouse.
3. Switch on R&S UPV.
4. After starting the R&S UPV, exit or minimize the UPV program by clicking on the  buttons on the right in the title bar.
5. Right-click the desktop to open the context menu and then select "Graphics Options" and "Output To".
6. If the external monitor is connected to the VGA output: Select "Monitor". If the external monitor is connected to the DVI-D output: Select "Digital Display".

Switch off the internal LC screen and switch on the external monitor if it was previously switched off.

You can now set the external monitor to a resolution higher than 800 x 600 pixels.

7. Right-click the desktop to open the context menu and then select "Screen resolution". A Windows dialog box opens in which the screen resolution can be changed in the "Resolution" field.
8. Click "Apply" and then "OK" to apply the new screen resolution.

Switching on internal screen

Proceed as described in the section "Setting external screen resolution to higher than 800 x 600", point 1 to point 5, then:

1. If only the internal display is required, select "Built-In Display". The external monitor is switched off.
2. If clone mode is required, select "Clone Display" and then select "Built-in Display + Monitor" for an external monitor at the VGA port or "Built-in Display + Digital Display" for the DVI-D port. The internal screen and the external screen are switched on.

2.9 Installing Options

The R&S UPV can be equipped with a few options. These options can be divided into two basic categories:

Software options	These can be installed by the user alone; installation instructions and a unique activation code supplied with the option are required.
Hardware options	These are installed in the R&S UPV audio analyzer, can be retrofitted only by a Rohde & Schwarz service facility. "Exception: The plug-in cards for the R&S UPV-B41, -B42 and -B48 options can also be installed by the user by following the information listed in the installation instruction since they do not require that the base unit be opened."

2.10 Connect R&S UPV to a Network (LAN)

The R&S UPV has a network connector and can be connected to a LAN (Local Area Network).

Network administrators with the appropriate rights can transfer files across the network and use network resources such as the network directories or printers. The instrument can also be remote-controlled and manually operated in the network.

The manual remote allows operating the R&S UPV from any remote external computer. For example, the user can operate one or several R&S UPVs from his workplace that are integrated in a test setup in another part of the building.

The R&S UPV is shipped with activated Windows firewall. File transfer via LAN or manual remote operation using the remote desktop requires only a partial exception in

the firewall. It is advisable to coordinate the configuration of the firewall with the network administrator.

The remote control of the instrument via the LAN interface is described in [chapter 6, "Remote Control - Fundamentals"](#), on page 802.

2.10.1 Connection to the Network

NOTICE

Possible malfunction of the network operation

It is recommended that the connection of the instrument to the network be coordinated with the network administrator. Connection errors may affect the entire network.

Do not connect or disconnect the network cable until the instrument is switched off (standby). Only then can the network connection be reliably detected and impairments to instrument operation can be avoided.

The instrument is connected to the network using a commercially available RJ-45 cable connected to the LAN interface at the rear of the instrument. In order to suppress electromagnetic interference, it is recommended to use suitable shielded CAT6 or CAT7 cables of high quality.



2.10.2 Configuration of R&S UPV for Network Operation

The network interface operates with 100-MHz Ethernet IEEE 802.3u. The TCP/IP network protocol and the associated network services are preconfigured.

In order to exchange data in a local network (LAN), each connected computer or instrument must have a unique IP address or a unique computer name. In addition, network access of the different users is organized by the assignment of access rights.

The access rights determine which of the available network resources, e.g. file storage systems, are available for the R&S UPV.

Networks with DHCP

The R&S UPV is preconfigured for networks using DHCP (dynamic host configuration protocol). In these networks, the R&S UPV is automatically assigned an unused IP address.

In this case, a unique computer name is used for identification in the network. Every R&S UPV is assigned an individual computer name at the factory. This name can be queried in the Windows menu "Start - My Computer" and changed (see [chapter 2.10.2.3, "Querying the computer name"](#), on page 72).

Networks with fixed IP addresses

In networks using fixed IP addresses, the addresses are mostly assigned by the network administrator. The fixed IP address must be entered in the Windows menu "Start - Control Panel" (see [chapter 2.10.2.2, "Entering the IP Address"](#), on page 69).

Point-to-point connections

To set up a simple network – a LAN connection between an R&S UPV and a computer without integration in a larger network – an IP address must be assigned for the R&S UPV and the computer. The IP addresses 192.168.xxx.yyy are available, whereby both xxx and yyy can have the values 1 to 254; the value for the subnet mask is 255.255.255.0.

In this case, a commercially available crossover RJ-45 cable must be used for the connection. In order to suppress electromagnetic interference, it is recommended to use suitable shielded cables of high quality.

User ID

For the R&S UPV, the user **instrument** has been defined. The user is used for the auto login when the instrument is started and for manual remote operation. The password is also **instrument**. By assigning the respective rights, the network administrator decides which directories and resources in the network can be accessed by the R&S UPV.

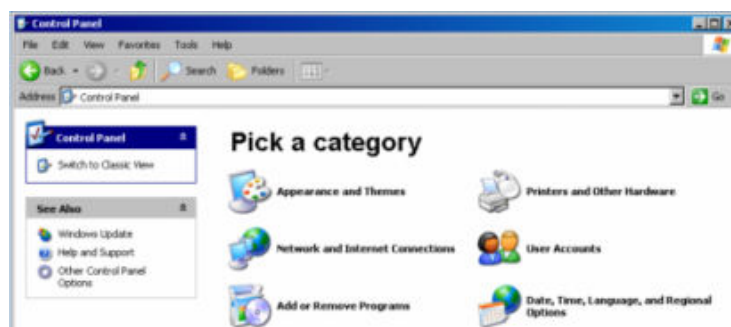
2.10.2.1 Preparations

The instrument is configured for network operation in the menus of the Windows operating system. The operating system can only be accessed if an external keyboard is connected; connection of a mouse is recommended for easy operation. The instrument should be switched off before the keyboard and mouse are connected. This will ensure that the keyboard and mouse are correctly detected by the operating system.

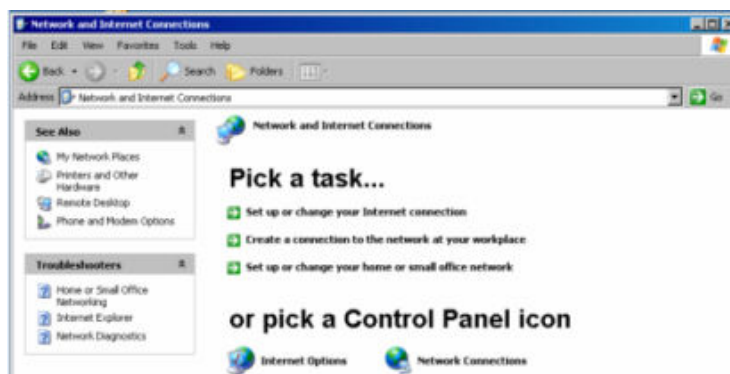
2.10.2.2 Entering the IP Address

By default, "Obtain an IP address automatically" (DHCP (Dynamic Host Configuration Protocol) is preset.

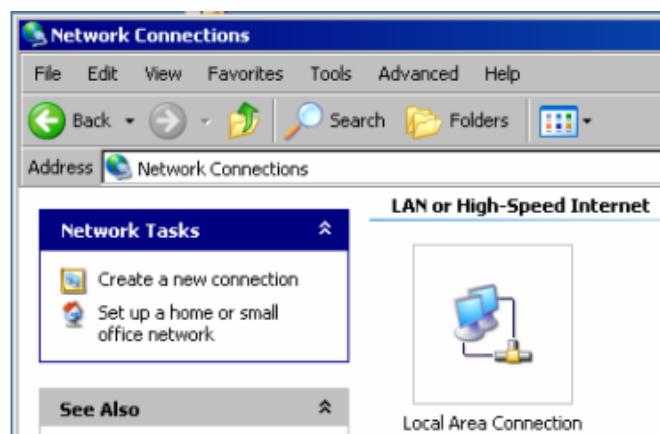
1. "Click on Start – Settings – Control Panel".



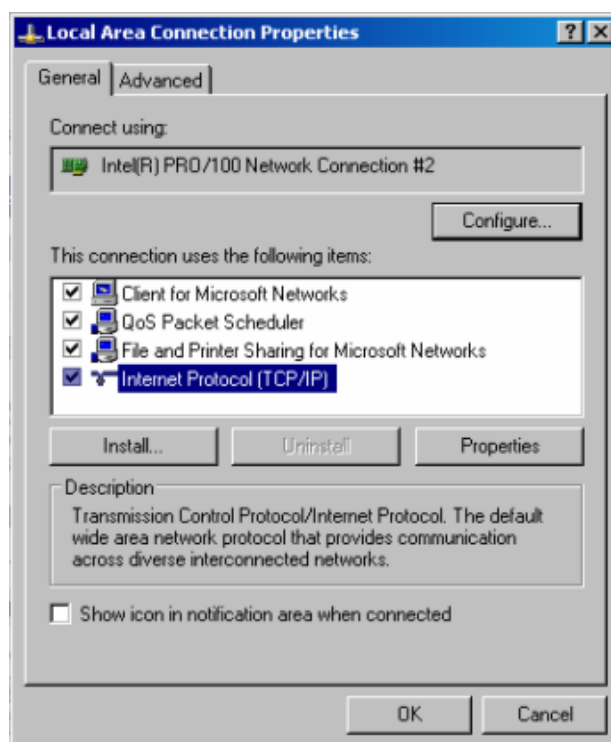
2. "Click on Network and Internet Connections" and then click on "Network Connections" at the bottom right in this menu.



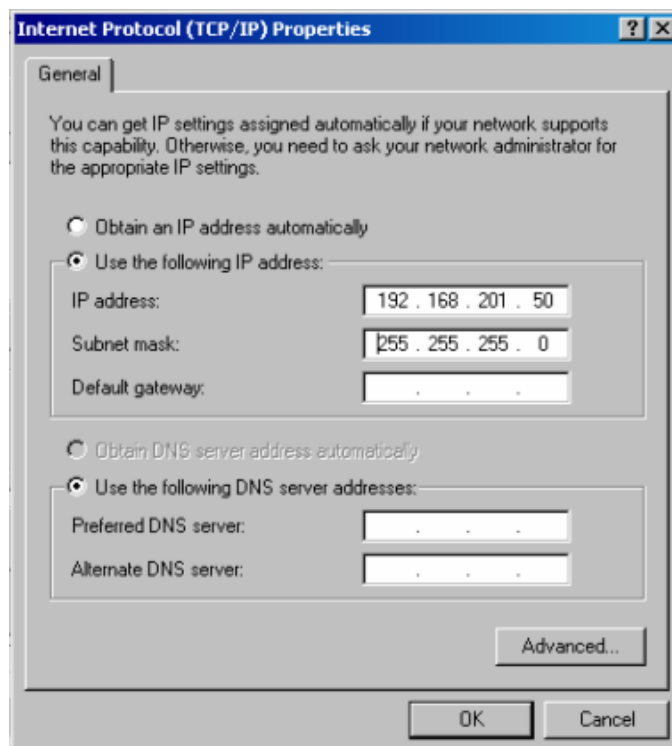
3. Right-click in the menu "Network Connections Local Area Connection" and then click on "Properties".



4. On the "General" tab in the field "This connection uses the following items:", mark the "Internet Protocol (TCP/IP)" selection and then click on "Properties".



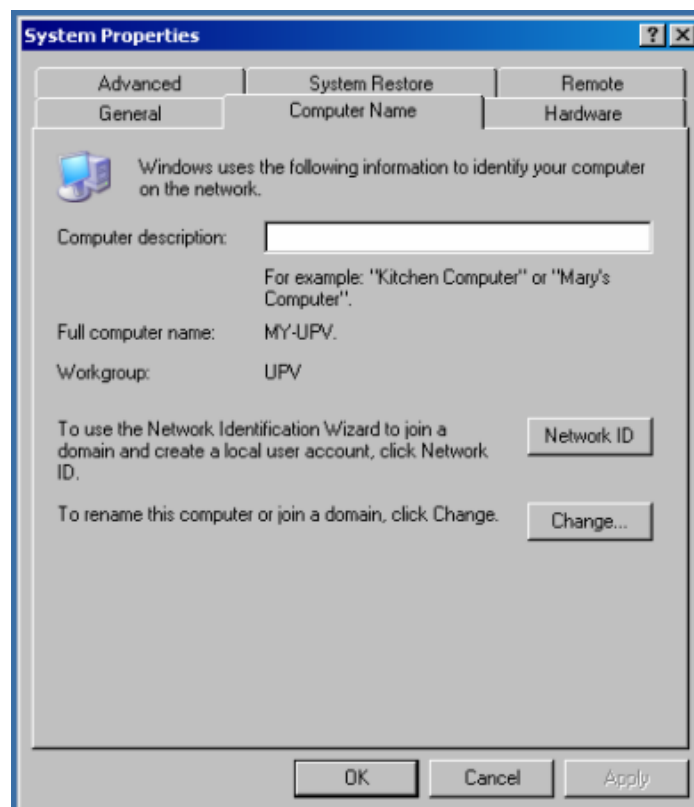
5. In the "Internet Protocol (TCP/IP) Properties" menu, enter the IP address in the "Use the following IP address" field (the complete data are available from the network administrator). Complete the entry with "OK" in all menus.



2.10.2.3 Querying the computer name

1. "Click on Start – Control Panel: Performance and Maintenance"
2. "Click on System" and select "Computer Name" in the tab menu.

The computer name is displayed under "Full Computer Name". It can be changed in the "Change" submenu.



2.10.2.4 Accessing directories in the network

Access to network drives depends on access rights and whether the drives in question have been enabled. The complete integration of R&S UPV in a larger network with the required rights assignment is very complex and is generally performed by a network administrator.

Access from R&S UPV to the hard disk of a computer that is also connected to the network can, however, be performed relatively easily. The directory which the R&S UPV is to access simply has to be enabled on the remote computer. Access from R&S UPV to this directory is done with the help of a Windows search function.

This procedure is also of importance for a point-to-point connection, for instance in order to start a firmware update for which the files have been stored on the hard disk of the remote computer.



Both the computer and the audio analyzer must have a computer name and an IP address (see [chapter 2.10.2, "Configuration of R&S UPV for Network Operation"](#), on page 68).

The menu name may deviate from the name specified in the following operating sequence, depending on the language and on the operating system used on the computer.

Enabling the desired directory on the remote computer

1. On the computer, select the directory to be enabled in Windows Explorer and right-click to call up the "Properties" menu.
2. In the "Sharing" panel, activate the "Share this folder" check box.
3. Record the computer name of the PC (see [chapter 2.10.2.3, "Querying the computer name"](#), on page 72).

At the R&S UPV, access the enabled directory

1. Use the Windows key to call up the "Start" menu.
2. In the menu, select "Search Computers or People", followed by "A Computer on the Network".
3. In the input window with the query "Which computer are you looking for?", enter the name of the computer and start the search with Enter.

The PC is listed with its computer name as the search result.

4. Click on the computer name. The enabled directory is displayed and the files stored in it can be used in the R&S UPV.

Note: If a user name and password are requested when you click the computer, the login name and password used on the computer must be entered.

2.10.3 Configuration via LXI



By default, LXI is only available to the R&S UPV66, but it can also be installed on the R&S UPV at a later time, if required.

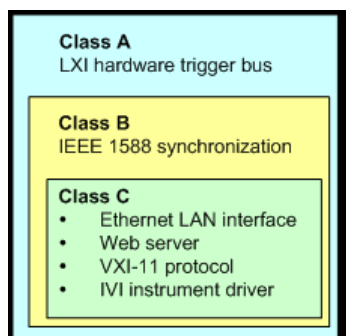
The LXI functionality for the R&S UPV66 requires at least the Windows XP operating system with Service Pack 2 which may not yet be installed on older computers. If this is the case, please contact your Rohde & Schwarz subsidiary. The version of the operating system can be checked under "Instrument Properties" in the "General" menu.

LAN eXtensions for Instrumentation (LXI) is an instrumentation platform for measuring instruments and test systems that is based on standard Ethernet technology. LXI is intended to be the LAN-based successor to GPIB, combining the advantages of Ethernet with the simplicity and familiarity of GPIB. This standard provides a new way for configuring virtual front panel instruments by using a network and a Web interface. The

main tool for this configuration method is a browser, such as Microsoft Internet Explorer, but it is also possible to use other browsers such as Firefox or Netscape.

2.10.3.1 LXI classes and LXI functionality

LXI-compliant instruments are divided into three classes, A, B and C, with the functionality of the classes hierarchically based one upon the other:



- Class C instruments are characterized by a common LAN implementation, including an ICMP ping responder for diagnostics. The instruments can be configured via a web browser; a LAN Configuration Initialize (LCI) mechanism resets the LAN configuration. LXI instruments of class C must also support automatic detection in a LAN via the VXI-11 discovery protocol and programming by means of IVI drivers.
- Class B adds IEEE 1588 Precision Time Protocol (PTP) and peer-to-peer communication to the base class C. IEEE 1588 allows all instruments on the same network to automatically synchronize to the most accurate clock available and then provide time stamps or time-based synchronization signals to all instruments with exceptional accuracy.
- Class A-instruments are additionally equipped with the eight-channel hardware trigger bus (LVDS interface) defined in the LXI standard.

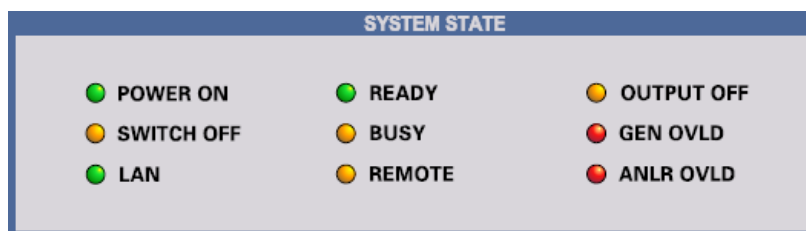
Instruments of classes A and B can generate and receive software triggers via LAN messages and communicate with each other without involving the controller.

The R&S UPV66 meets the general requirements of LXI Class C. In addition to the properties described above, the instrument offers the following LXI-related functions:

- Integrated display of the current instrument settings
- Possibility of remote controlling the instrument within the WEB browser.

2.10.3.2 LXI LAN Indicator

The green LAN LED on the front panel of the R&S UPV66 shows the LAN status of the instrument. The LAN LED indicator has three states.



- LAN LED off
 - The instrument does not have valid IP address. This may be due to one of the following reasons:
 - 1) the instrument is configured with DHCP, but no DHCP router is connected,
 - 2) the instrument is manually configured and an IP address conflict is present,
 - 3) the instrument lost its IP address that was configured with DHCP and switched to Auto IP.
 This state is called "error state" and normally can be resolved by the LCI mechanism (LAN reset). This mechanism is required by the LXI standard and can be invoked with the "LAN RESET" button (key press > 10 s) on the rear side of the instrument (see [chapter 2.2.11, "LAN RESET Pushbutton"](#), on page 40).
- LAN LED is on
 - The instrument has a valid IP address and is reachable via TCP/IP.
- LAN LED flashes
 - The instrument is in the "Device Indicator" state initiated by the WEB interface. This state is required by the standard and is used for finding instruments in racks (see [chapter 2.10.3.4, "LXI Browser Interface"](#), on page 76).

2.10.3.3 LXI Default State of Network Settings

After a LCI (LAN reset), the instrument automatically reboots and starts up with following LAN settings:

Parameter	Setting
Hostname	RSUPV66vvv-xxxxxx
Description	Audio Analyzer
TCP/IP Mode	DHCP + Auto IP Address
Dynamic DNS	Enabled
ICMP Ping	Enabled
Negotiation	Auto Detect
VXI-11 Discovery	Enabled
Password for LAN Configuration	LxiWebIfc



More information about the LXI standard is located on the LXI website under <http://www.lxistandard.org> or in the article about LXI in "News from Rohde & Schwarz, 2006/II - 190".

2.10.3.4 LXI Browser Interface

The only information necessary for performing configuration via the LXI/Web interface is the name of the instrument (which means its Windows name) in networks that operate with DHCP enabled, or its IP address in networks that operate with manual network configuration. In rare cases where neither one of these names is known, it is also possible to derive the IP address from the MAC address, which is printed on the rear panel of the instrument.

The instrument's LXI browser interface works correctly with all W3C compliant browsers.

To start the instrument home page (welcome page), open a browser on the PC and enter the instrument name or the IP address of R&S UPV66 in the address field, e.g. <http://rsUPV66100002> or <http://10.113.10.203>.

The instrument name for the R&S UPV66 is always RSUPV66vvv-xxxxxx, whereby vvv represents the variant and xxxxxx the six-digit serial number of the instrument. If the instrument does not have a variant number, the "vvv-" is omitted.

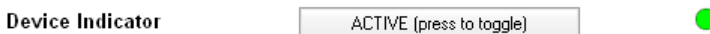


The instrument home page shows all important information in a compact form. The MAC address and the (often dynamically assigned) IP address as well as the complete resource string for the remote control via VISA are also located here (see also [chapter 6, "Remote Control - Fundamentals"](#), on page 802).

The LAN indicator on the instrument will blink if Device Indicator is set to ACTIVE. Clicking on "INACTIVE (press to toggle)" switches the status on and off. It can be used to quickly identify an instrument that is mounted together with several other instruments of the same type, such as in a 19" rack.



Clicking on "ACTIVE (press to toggle)" switches the flashing state off again.

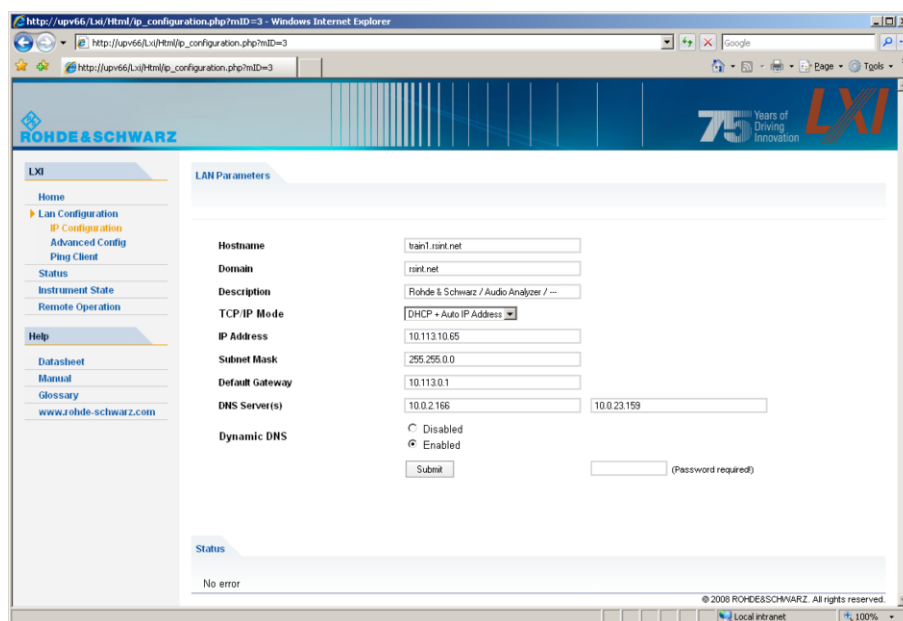


The left side shows a navigation bar containing the important "LAN Configuration" menu. This page of the LXI Web configuration website enables extensive configuration of all important LAN parameters, which is necessary because the configuration steps mentioned in the next sections cannot be performed as described with a virtual front panel instrument.



Changing the LAN configuration is password-protected. The password reads LxiWebIfc (notice upper and lower case characters). This password cannot be changed in the current firmware version.

2.10.3.5 IP Configuration



- TCP/IP Mode
 - decides whether DHCP is switched on or not. The IP Address, Subnet Mask, Default Gateway and DNS Server configuration fields are only enabled if DHCP is disabled. Consult the network administrator if it is necessary to modify these settings or any other settings.

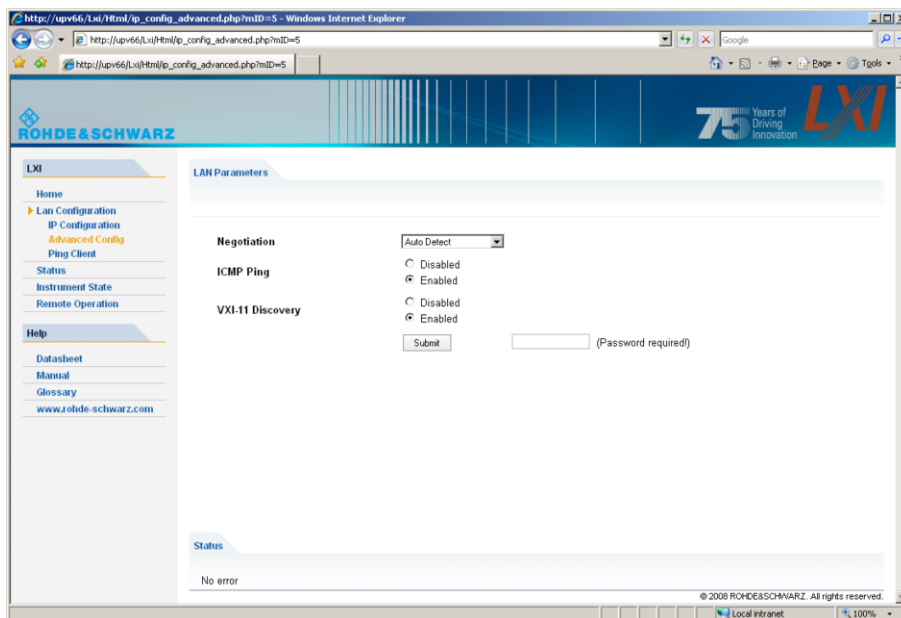


Switching from DHCP enabled mode to manual configuration mode may trigger an instrument restart when the new setting is confirmed (depends on the configuration). If incorrect network configuration settings have been entered, LAN RESET on the rear panel of the instrument must be used to restore access to the Web interface.

- IP address
 - Allows the IP address of the instrument to be modified if DHCP is disabled.
- Subnet mask, default gateway
 - are settings that may have to be changed at times compared to the displayed presets if DHCP is switched off. Consult the network administrator for the proper values if it is necessary to modify these settings.
- DNS server
 - This is the IP address of the domain name server of the network segment. Consult the network administrator if it is necessary to modify this setting when operating with DHCP disabled.
- Dynamic DNS
 - Allows different DNS servers to be addressed in succession. Consult the network administrator if it is necessary to modify this setting when operating with DHCP disabled.

2.10.3.6 Advanced LAN Configuration

"Advanced LAN Configuration" provides LAN settings that are not declared mandatory by the LXI standard. These advanced parameters should only be modified by experienced users.

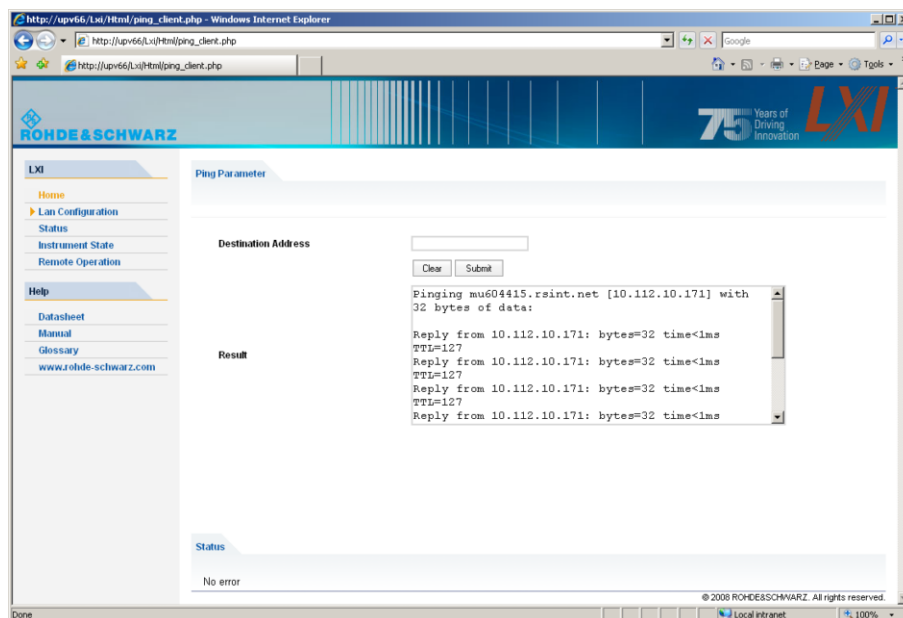


- Negotiation
 - The Negotiation configuration field provides different Ethernet speed and duplex mode settings. In general, the Auto Detect mode is sufficient.

- ICMP Ping
 - ICMP Ping must be enabled to use the ping utility.
- VXI-11 Discovery
 - Enables or prevents discovering the instrument via the VXI-11 Discovery protocol, which is a protocol jointly developed by National Instruments and VISA for searching for devices on a LAN.
VXI-11 is the protocol that is used for discovery of the instrument in the LAN. According to the standard, LXI instruments must use VXI-11 to provide a discovery mechanism; other additional search methods are permitted.

2.10.3.7 Ping Client

Ping is a utility that verifies the connection between the LXI-compliant instrument and another instrument. The ping command uses the ICMP echo request and echo reply packets to determine whether the LAN connection is functional. Ping is useful for diagnosing IP network or router failures.



The ping utility is not password-protected.

To initiate a ping between the LXI-compliant instrument and a second connected instrument:

1. "Activate ICMP Ping" on the "Advanced LAN Configuration" page (activated after LCI).
2. Enter the IP address of the second device without the ping command and without any further parameters into the Destination Address field (e.g. 10.113.10.203).
3. Click on "Submit".

2.10.4 Configuration for manual remote operation

The R&S UPV can be operated manually from an external computer via a network connection. The Windows program Remote Desktop Connection is used for operation, see [chapter 4.16, "Manual Remote Operation"](#), on page 221.

Manual remote control of the audio analyzer is possible under the following conditions:

- the Windows 95 operating system or higher and the Remote Desktop Connection program are installed on the external computer and a LAN interface is configured for the network
- the audio analyzer and the computer are connected via LAN (see [chapter 2.10.2, "Configuration of R&S UPV for Network Operation"](#), on page 68),
- the Remote Desktop Connection program is activated on the audio analyzer (see [chapter 2.10.4.1, "Activating the Remote Desktop Connection program at the R&S UPV"](#), on page 80),
- on the external computer, the R&S UPV data have been entered in the Remote Desktop Connection program (IP address or computer name of R&S UPV in the network (see [chapter 2.10.2.3, "Querying the computer name"](#), on page 72),
- the login at the external computer for R&S UPV was performed with the correct user name (instrument) and the correct password (instrument) (see [chapter 2.10.4.2, "Starting manual remote operation at the external computer"](#), on page 81).

2.10.4.1 Activating the Remote Desktop Connection program at the R&S UPV

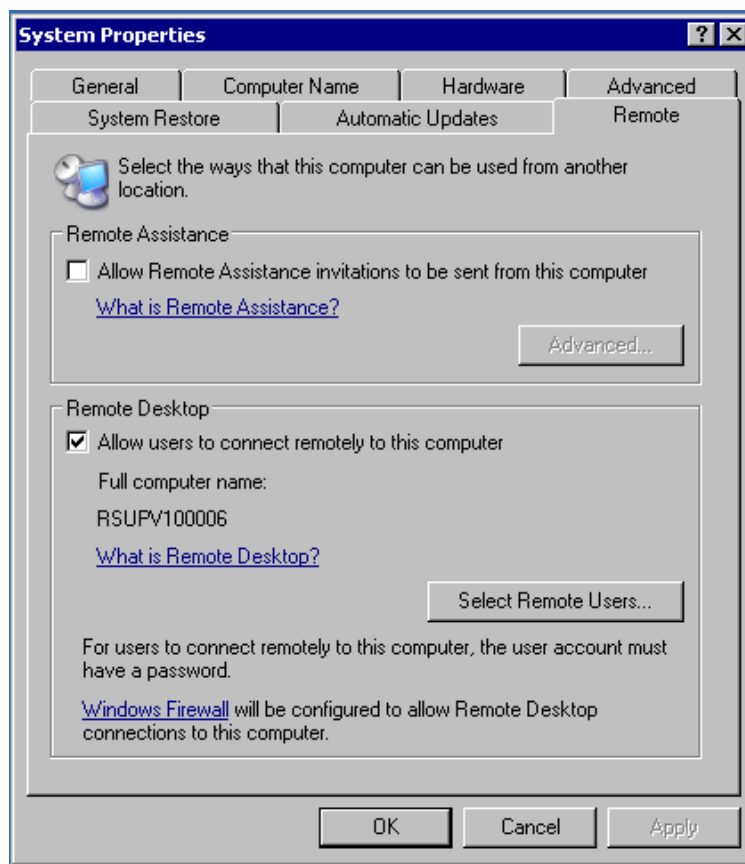
NOTICE

Unauthorized access possible to audio analyzer

After activating Remote Desktop, access to this R&S UPV is possible for any user in the network who knows the computer name and the login data of the audio analyzer.

Activating Remote Desktop

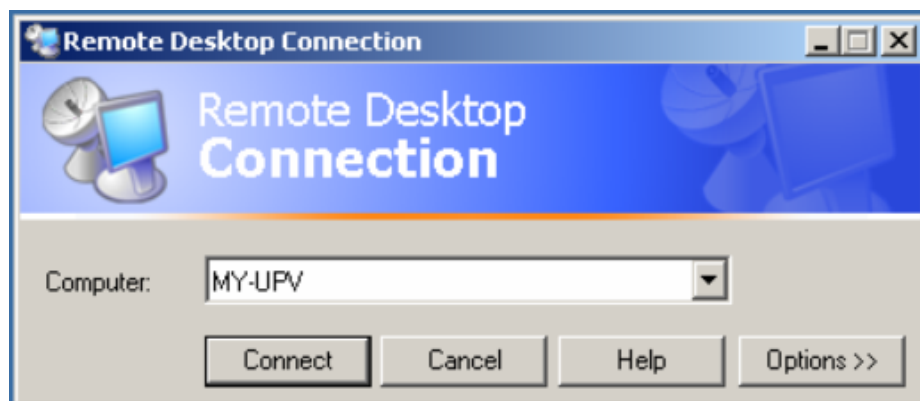
1. "Start – Settings – Control Panel": Click on "Performance and Maintenance".
2. "Click on System" and select "Remote" in the tab menu.
3. Activate the "Allow users to connect remotely to this computer" check box.



2.10.4.2 Starting manual remote operation at the external computer

The Remote Desktop Connection program is already installed in the Windows operating system (program name "mstsc.exe" in "C:\Windows\System32"). For all other Windows operating systems from Windows 95 and higher, the program can be downloaded free-of-charge from the Internet (<http://www.microsoft.com>). It can be loaded onto any external computer by following the instructions, which are also provided on the Internet.

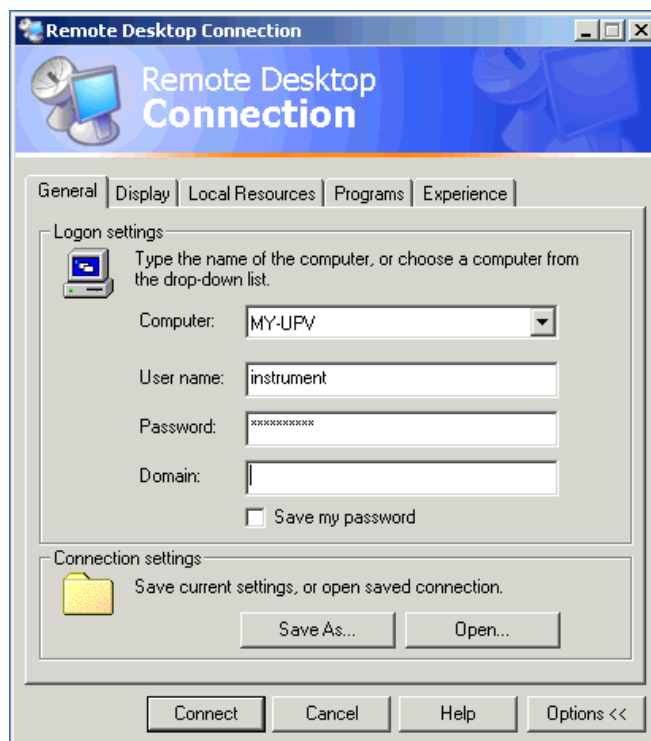
1. If necessary, install the **Remote Desktop Connection** program on the external computer
2. Start the program in the Windows menu "Start - All Programs - Accessories - Communications".



Before the program can be used for the first time, the instrument and user ID of the R&S UPV must be entered on the external computer. The instrument ID - the computer name of R&S UPV - identify the R&S UPV in the network. Every R&S UPV is supplied together with a computer name which can be used for manual remote operation. For notes about querying the computer name, see [chapter 2.10.2.3, "Querying the computer name"](#), on page 72.

The user ID is necessary as it authorizes access to the R&S UPV. They are preset on the R&S UPV and are "instrument" for both the user name and the password. No entry is needed in the Domain field.

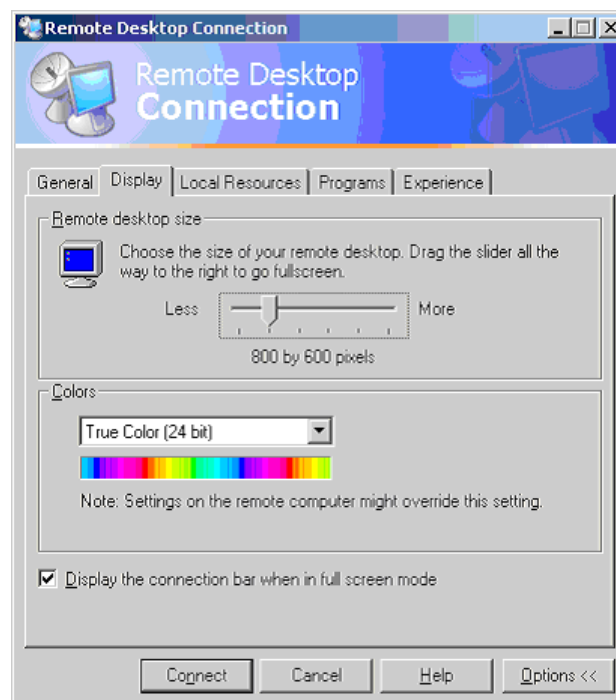
3. Enter the instrument and user ID on the "General" tab of the extended "Remote Desktop Connection" menu (called up by pressing the "Options>>" button).



4. The login data can be saved with the "Save as" button.

When saving as `default.rdp` file, the connection to R&S UPV is offered as default at the start of the program. When saving under a different name, the setting for the connection with R&S UPV is provided in the selection list which is called up by clicking on the ▾ button in the "Computer:" entry line.

5. 5. The resolution for the display of the R&S UPV monitor is set to 800 x 600 on the Display tab.



6. Establish the connection by clicking on the "Connect" button. After the connection has been established, the audio analyzer screen appears on the external computer. Operation is possible with the mouse and/or the keyboard. Buttons on the front panel that do not have a direct correspondence to the keyboard can be replaced by shortcuts (see [chapter 4.3.4, "Operation Using an External Computer Keyboard"](#), on page 146). If several R&S UPVs should be manually remote-controlled by one computer, a separate Remote Desktop Control window must be opened for every R&S UPV. This is possible by repeatedly starting the program on the external computer.

2.11 Firmware Update

The firmware of R&S UPV is supplied in a file with the name `Setup-xxxxRelease.exe`. The sequence of digits for `xxxx` consists of the main version number followed by the subversion number, revision number and build number.

It is required to connect an external keyboard and a mouse.

The initial installation and firmware updates are carried out by starting this EXE file. By doing this you start an Installer program which automatically checks which type of installation is necessary:

Main installation	The Installer displays what it has found out about the environment into which the firmware will be installed and how much disk space is needed. It then takes you through the "Setup Wizard". Normally, the "Next" button is always used to continue.
Major update	The Installer detects that the installed firmware is too old for a minor update to be carried out. It therefore displays a message asking you to uninstall the old software completely.
Minor update	The Installer simply displays a short prompt asking whether you wish to update the firmware. The rest is performed automatically.

2.11.1 Troubleshooting during a Firmware Update

The two most common problems that can occur when installing the software (or during a major update) are these:

- At the beginning, just before the progress bar starts, the progress window displays the text "InstallShield is preparing InstallScript". Occasionally you then see an error message and installation is canceled.
This problem can usually be solved by restarting Windows and carrying out the firmware installation again.
- After the installer has installed the firmware, i.e., the progress bar is completely filled, the progress window displays the text "Removing Backup Files", "Registering Components" or "Publishing Product Information". Here, too, it occasionally happens that an error message is followed by a second message, and the firmware is subsequently not installed.
This problem can sometimes be solved by restarting Windows and carrying out the setup again. If the error occurs again, this can be for two reasons:
 - Installation of the front panel driver went wrong. In this case, it must be installed using the Windows wizard; the required INI file is named `C:\UPV\fpnl_wdm.inf`. You should now reinstall the firmware.
 - The installation of additional Windows settings went wrong. In this case, execute the files `C:\UPV\ScanFirmwareVersions.exe` and `C:\UPV\SetReg.exe` in succession. You should now reinstall the firmware.

If neither of these steps is successful, the instrument needs to go in for service (or the Windows image program must be reloaded).

2.12 Windows XP Recovery and Backup

The R&S UPV provides an invisible backup and recovery partition. A backup of the factory system partition (`C:\`) is saved by default and can be restored in case of a system crash.

In addition, backups of up to 5 firmware versions can be stored on this partition. It is e.g. possible to backup the current system partition prior to a firmware update or to provide different system configurations for different environments.

For the R&S UPV, the use of an external keyboard is recommended.

The operation is described with respect to an external keyboard. It is recommended to connect a mouse that allows an intuitive operation!

During restore, the system partition (C:\) is deleted, formatted and rewritten. The data partition (D:\) is not affected by this.

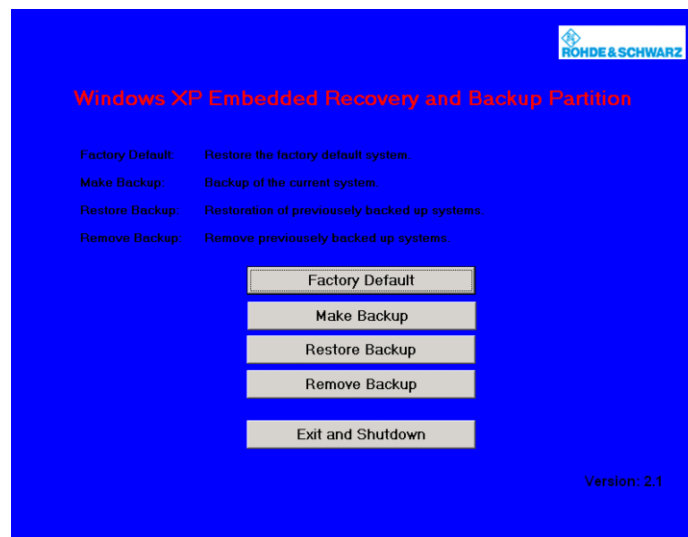
2.12.1 Calling the Windows XP Recovery and Backup Partition Menu



If several backups are already stored on the disk, the remaining space might not be sufficient for an additional backup. In this case a warning is indicated in the Windows XP Recovery and Backup Partition menu and the user is requested to remove an old backup before making a new one.

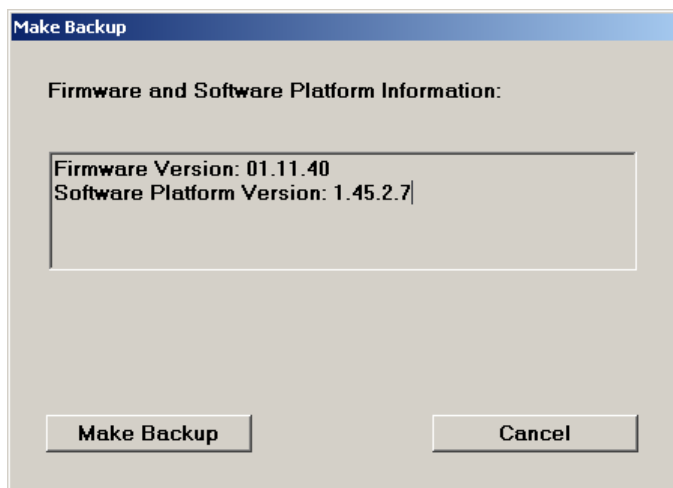
1. Switch the instrument off and on again **Press the cursor keys multiple times during the boot phase to ensure that the Boot menu does not independently close after a short period of time.**
2. In the Boot menu, use the cursor keys to select the "Backup/Recovery" line.
3. Open the "Windows XP Recovery and Backup Partition" menu with ENTER.

The menu shows the available selections for the recovery and backup partition:



2.12.2 Backup Current System Partition

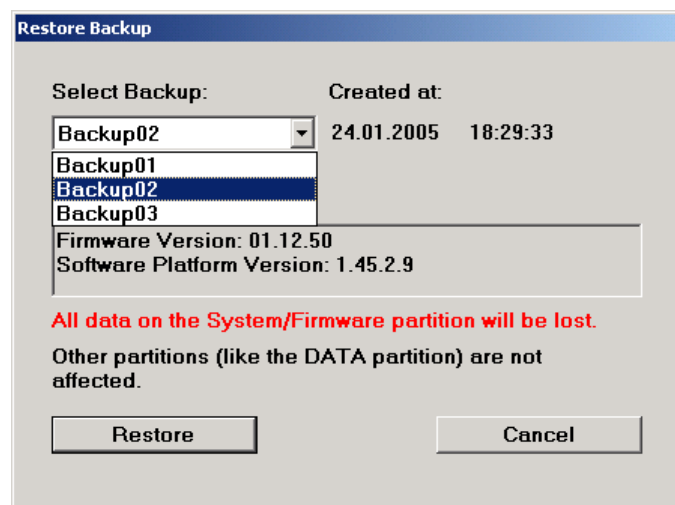
1. In the Windows XP Recovery and Backup Partition menu, use the cursor keys to select the "Make Backup" button.
2. Open the "Make Backup" menu with the ENTER key.
The menu shows the current versions of the firmware and the software platform.



3. Select the "Make Backup" button with the TAB keys.
4. Start the backup by pressing the ENTER key.
After the backup, the "Windows XP Recovery and Backup Partition" menu appears again.
5. Select "Exit and Shutdown" with the cursor keys.
6. Exit the program and shut down the R&S UPV with the ENTER key.

2.12.3 Restoring a Selected Version of the System Partition

1. Use the cursor keys to select "Restore Backup" in the "Windows XP Recovery and Backup Partition" menu to select the desired version of the system partition.
2. Open the "Restore Backup" menu with the ENTER key.
The menu shows the versions of the firmware and the software platform of the backup which is displayed in the "Select Backup" window.



3. Select the "Select Backup" window with the TAB keys.
4. Select the backup to be restored with the up/down cursor keys and the ENTER key.
5. Select the "Restore" button with the TAB keys.
6. Start the restore process with the ENTER key.
The script that is performed during recovery is displayed.
7. After the restore, shut down and switch off the R&S UPV.
The new setting is now active.

2.12.4 Recover Factory Default

1. Select the "Factory Default" button in the Windows XP Recovery and Backup Partition menu with the cursor keys to recover the factory default version of the system partition.
2. Open the "Factory Default" menu with the ENTER key.
The menu shows the versions of the firmware and the software platform on delivery.

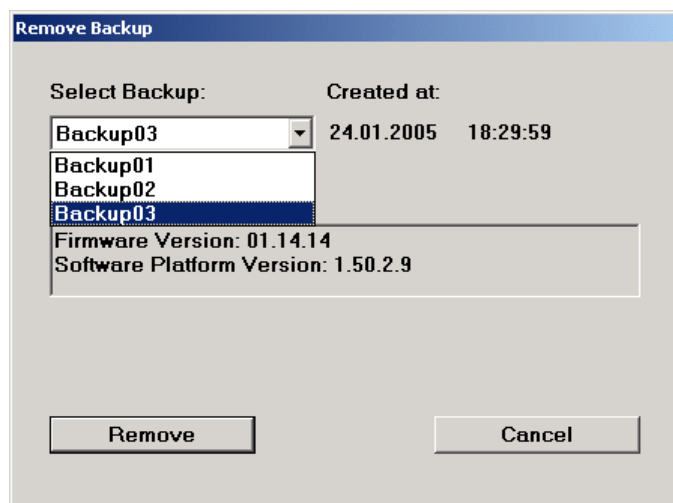


3. Select the "Restore now" button with the TAB keys.
4. Start the restore process with the ENTER key.
The script that is performed during recovery is displayed.
5. After the restore, shut down and switch off the R&S UPV.
The new setting is now active.

2.12.5 Deleting Backups

Up to five backups in addition to the factory default can be stored on the recovery partition. To provide space for new backups, it might be necessary to remove older backups. The factory default cannot be deleted.

1. Use the cursor keys to select the "Remove Backup" button in the Windows XP Recovery and Backup Partition menu to delete a selected backup.
2. Open the "Remove Backup" menu with the ENTER key.
The menu shows the versions of the firmware and the software platform of the backup displayed in the Select Backup window.



3. Select the "Select Backup" button with the TAB keys.
4. Use the cursor keys and the ENTER key to select the backup to be removed.
5. Select the "Remove" button with the TAB keys.
6. Start the removal process with the ENTER key.

After the deletion, the instrument returns to the Remove Backup menu as long as backups are still available. If the last backup is deleted, the Windows XP Recovery and Backup Partition menu opens again.
7. Select the "Cancel" button with the TAB keys.
8. Close the "Remove Backup" menu with the ENTER key.

The Windows XP Recovery and Backup Partition menu opens.
9. Select "Exit and Shutdown" with the cursor keys.
10. Exit the menu and shut down the R&S UPV by clicking on the ENTER key.

2.13 Windows 7 Recovery and Backup

The R&S UPV provides an invisible backup and recovery partition. A backup of the factory system partition (C:\) is saved by default and can be restored in the event of a system crash.

In addition, backups of multiple firmware versions can be saved on this partition. For example, it is possible to backup the current system partition prior to a firmware update or to provide different system configurations for different environments.

For the R&S UPV, the use of an external keyboard is recommended.

Operation is described with respect to an external keyboard. It is recommended to connect a mouse as this enables intuitive operation.

During restore, the system partition (C:\) is deleted, formatted and rewritten. This does not apply to the data partition (D:\).

2.13.1 Calling Windows 7 Recovery and Backup Partition Menu

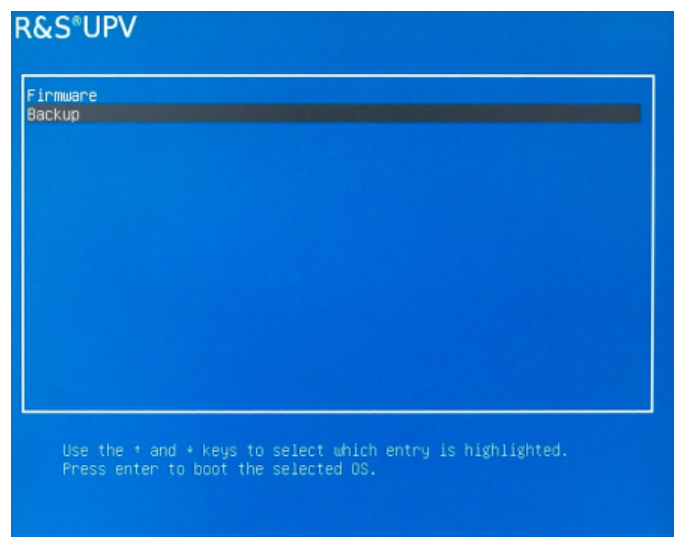


If several backups are already stored on the hard disk, the remaining memory capacity might not be sufficient for an additional backup. In this case a warning is indicated in the Windows 7 Recovery and Backup Partition menu and the user is requested to remove an old backup before making a new one.

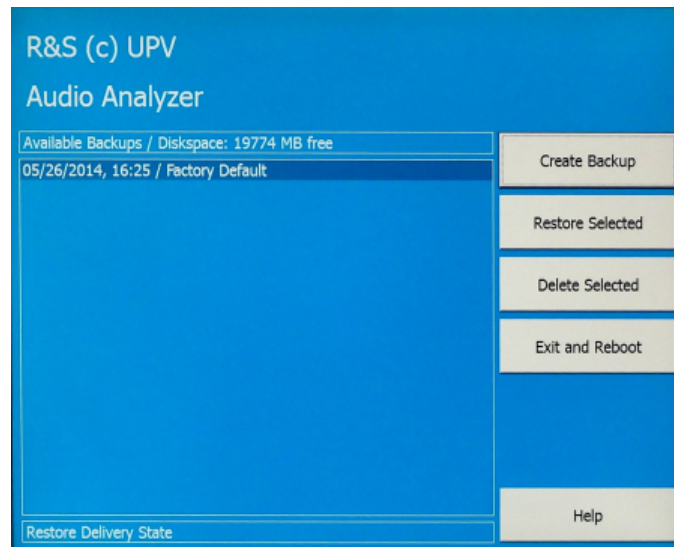
Although the backup/recovery system under Windows 7 looks slightly different to that under Windows XP, it can still be operated in the usual way using an external keyboard.

The figures below show the backup/recovery system for the R&S UPV. They are equally valid for the R&S UPP.

The following window is displayed after every boot procedure. The user can choose between "Firmware" and "Backup", as was the case under Windows XP. If no selection is made, "Firmware" is selected automatically after approx. 2 seconds.



1. Switch the instrument off and on again. **Press the cursor keys multiple times during the boot phase to ensure that the Boot menu does not close after a short period of time.**
2. In the Boot menu, use the cursor keys to select "Backup".
3. Open the "Windows 7 Recovery and Backup Partition" menu by pressing ENTER.
The menu shows the available selections for the recovery and backup partition:



2.13.2 Restoring Factory Default

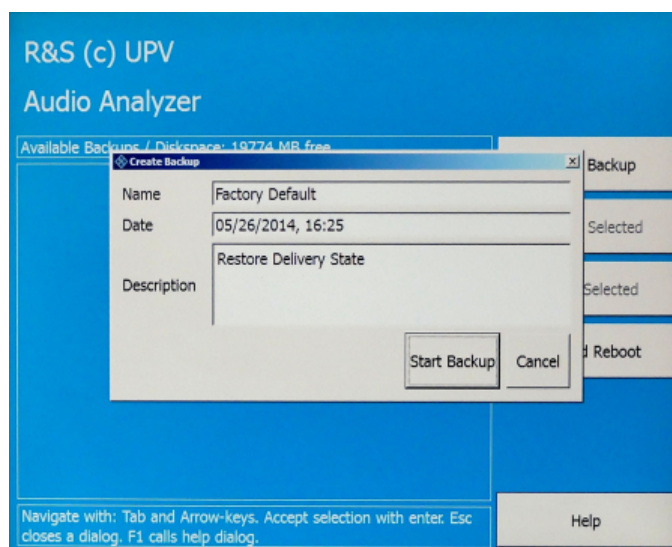
To restore the "Factory Default" state, select "Factory Default". Using the TAB keys, select "Restore Selected" and confirm with ENTER.

2.13.3 Restoring a "User Backup"

To restore a different backup, choose the selection list using the Shift+TAB key combination and select the desired backup using the "up/down" cursor keys. Select the "Restore Selected" field using the TAB key and confirm with ENTER.

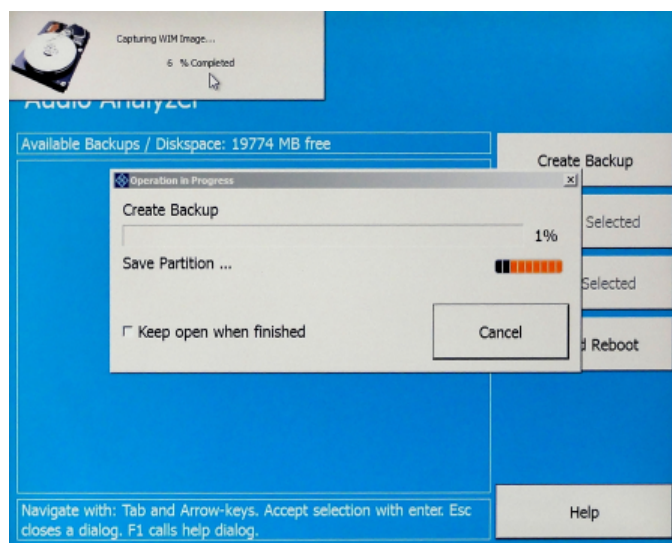
2.13.4 Creating a "User Backup"

1. Using the cursor keys, select the "Create Backup" button in the Windows 7 Recovery and Backup Partition menu.
2. Open the "Create Backup" menu using the ENTER key.



3. Entries must be made in the "Name" and "Description" fields; the entries shown here are intended as examples only (the date and time are entered automatically). Select the "Start Backup" button using the TAB keys.
4. Confirm using the ENTER key.

The progress indicator updated in the "Capturing WIM Image..." field shows the status of the backup creation process:



2.13.5 Deleting Backups

NOTICE**Deleting factory default setting**

The factory default is treated in exactly the same way as a normal backup. Take care not to inadvertently delete the factory default!

Using the TAB keys, select the backup to be deleted. Then select "Delete Selected" and confirm with ENTER. To exit the Backup and Recovery system, select "Exit and Reboot" and confirm with ENTER. The instrument is rebooted.

3 Getting Started

3.1 Introduction - Getting Started

This chapter describes the manual operation of the R&S UPV audio analyzer. The information in this chapter also largely applies analogously to the R&S UPV66 (which was primarily designed for system use) provided that an external monitor, keyboard, and mouse are connected to the instrument. For more detailed information on the operation via external keyboard and mouse, see [chapter 4, "Manual Operation"](#), on page 136.

The R&S UPV audio analyzer is able to perform virtually all measurements occurring in the audio world, from frequency response measurements through distortion factor and spectral displays to the analysis of digital data streams. Several measurement functions can be carried out and displayed at the same time, whereby the measurements are performed perfectly simultaneously at all switched-on channels.

The R&S UPV performs all measurements using digital signal processing. Here, analog signals to be measured are first subjected to complex preprocessing on analog measurement modules before they are digitalized and fed to the digital measurement routines.

This concept offers numerous advantages, for example:

- The measurement methods at the analog and digital interfaces are identical.
- The measurement functions are available at both the analog and the digital interfaces.
- Operation at the analog and digital interfaces is the same.

The many available options mean that the R&S UPV can be adapted to perform a wide variety of different tasks. The basic version of the instrument has analog audio interfaces. A number of special measurement functions are also available, but only after the appropriate options have been installed (see the data sheet for details).

This chapter, "Getting Started", only describes the functions available in the basic version of the R&S UPV audio analyzer.

3.2 Important Information for Measurements

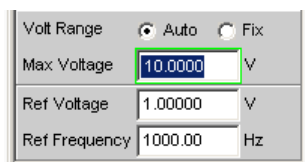
3.2.1 Maximum Output Voltage of the R&S UPV Generator

NOTICE**Possible Damage or Destruction of Input Circuits**

The generator of the audio analyzer can generate analog output voltages with an RMS of up to 20 V. These levels can damage or even destroy sensitive input circuits.

There is an option in the "Generator Config" panel for limiting the analog output voltage. For measurements on sensitive circuits, it is advisable to set an appropriately low value in the "Max Voltage" field; this value then applies to all analog output signals, irrespective of the signal shape.

The maximum voltage is not exceeded even in the case of changes made using the rotary knob. For the setting of such value entries or the changes via the rotary knob, see [chapter 3.3.7, "Function Selection and Value Entry"](#), on page 106 or [chapter 4, "Manual Operation"](#), on page 136.



The pulse level of the digital audio signals can be up to 8.5 V. Although the risk of destruction is generally much smaller than for analog circuits, care must still be taken when making settings for activating digital circuits.

3.2.2 Rapid Deactivation of Outputs

The OUTPUT OFF key can be used in the event of faults to deactivate all outputs of the R&S UPV. The key affects all audio outputs, i.e. for both analog and digital audio signals.

The deactivated lines can only be reactivated by pressing the OUTPUT OFF key again.



The status of the key is indicated by an LED. Illumination of the LED means OUTPUT OFF.

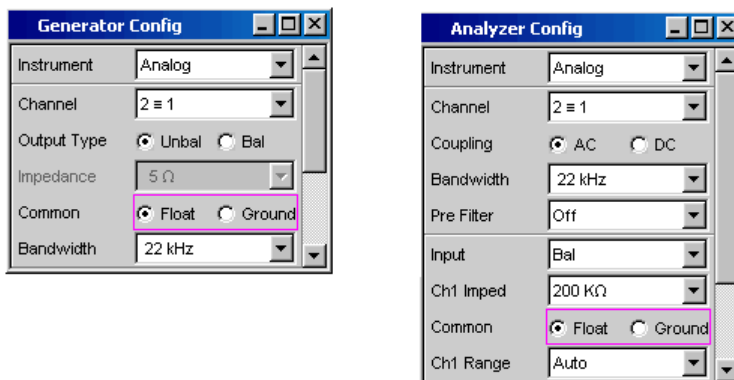
For more information about this key, see [chapter 4.13, "Rapid Deactivation of Outputs"](#), on page 213.

3.2.3 Avoiding Hum Loops

It is generally known in audio engineering that analog circuits must always be set up in such a way that hum signal pick-up is avoided. For this reason, it is important that a ground connection (grounding contact) be provided at only one point in the entire circuit.

Both the generator and the analyzer are configured as floating devices in order to prevent an additional, inadvertent ground connection via the audio analyzer. The two

"Common" fields of the "Generator Config" and "Analyzer Config" panels are factory-set to "Float".



There are, however, some applications where the audio circuit to be tested is set up without any ground connection at all. It may be necessary to create a defined ground connection especially if hum pick-up is suspected. This can be done at the audio analyzer by switching the "Common" line to "Ground" for either the generator or the analyzer (depending on the application).

For more detailed explanations about performing such settings, see [chapter 3.3.7, "Function Selection and Value Entry"](#), on page 106 or [chapter 4, "Manual Operation"](#), on page 136.

3.2.4 Help System



The audio analyzer has a context-sensitive help system.

If you have a question while operating the instrument, pressing the HELP key opens a help page containing information on the currently highlighted parameter field.

From here it is possible to move to other help pages using the contents list, the index, scroll arrows and page-internal links. For more detailed information about help, see [chapter 4.14, "Help System"](#), on page 214.

3.3 Brief Introduction to Operation

3.3.1 Windows User Interface and Controls

To provide the user with a familiar environment, operation of the R&S UPV is largely based on the Windows user interfaces. All panels, entry windows, etc. are made up of known elements.

Operation follows the same basic rules which apply to other Windows programs in use today. It is assumed that the user is familiar with these basic rules. This information is therefore not given in detail in this manual.

The R&S **UPV** can **for the most part** be operated via the front panel. The instrument is operated using function keys with permanently assigned functions, softkeys with functions which vary depending on the application, and the rotary knob with integrated entry function. Additional peripheral devices such as a mouse and keyboard should be connected in order to use the toolbar and quickstart panel. Operation using an external keyboard and mouse is explained in the chapter [chapter 4, "Manual Operation"](#), on page 136. The R&S **UPV66** can only be operated manually if the peripheral devices, i.e. external monitor, external keyboard and mouse, are connected.

After being switched on, the instrument is in the same state as it was before it was switched off. This applies to all setting parameters of the R&S UPV, including those not currently displayed on the screen.


A selection frame and dark markings around the entry fields indicate the current entry focus. Entries can be made in the element with entry focus.

3.3.2 The Display

The display is the central element for manually operating the R&S UPV. Both the instrument settings in the various panels and the measurement results are displayed here.

To make the various functions of the R&S UPV audio analyzer easier to operate, they are organized in a series of panels. The measurement results can be displayed as digital numeric values, data lists, in analog bar graphs or in result graphics. The user can freely choose the number of panels and the number of graphical windows to be shown in the display. The size of the windows can be changed within broad limits, whereby the font size, scaling and so on are adapted automatically (depending on the selected window).

Panels and display windows can be activated by pressing the WINBAR key in combination with the softkey bar.

Five display windows (or "screens") are provided so that the wealth of information can be better organized. The direction keys  are used to toggle between the individual screens.

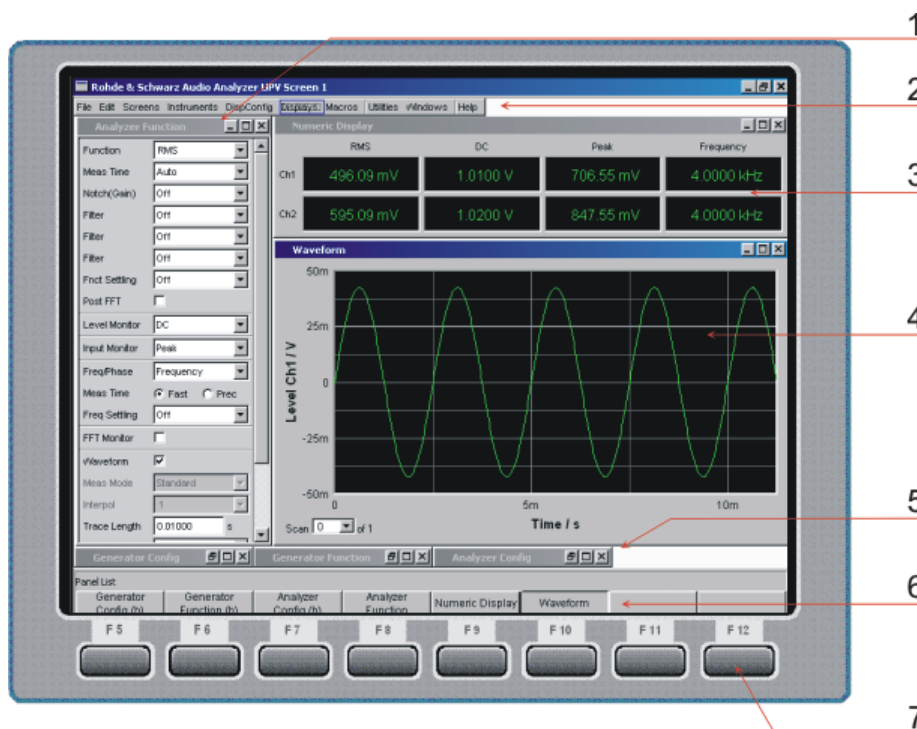


Fig. 3-1: Screen with the essential elements

- 1 = Panel
- 2 = Menu bar
- 3 = Numeric display
- 4 = Graphical window
- 5 = Hidden panels
- 6 = WINBAR
- 7 = Softkeys

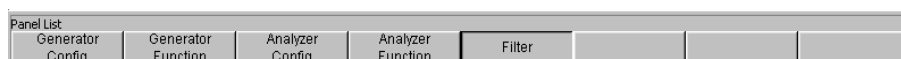
One of the two bars (either the softkey bar or the WINBAR) is always displayed at the bottom of the screen.

In normal operating mode, the softkey bar is visible; it contains eight buttons which are assigned the functions available in the selection windows of the panels.

If there are more than 8 elements to choose from, the hidden elements in the selection list can be displayed by pressing the last softkey containing the >> symbol or the first softkey containing the << symbol.



When the WINBAR key is pressed, the WINBAR appears in place of the softkey bar; this is indicated by "Panel List" text in the left-hand corner:



The labeled buttons show the names of all panels and graphical windows open in the current screen. Pressing the associated softkey puts the focus on the corresponding panel / graphical window, i.e. it becomes active. At the same time, the system returns to normal operating mode (i.e. the softkey bar).

Hidden panels (see [chapter 3.3.3, "Panels and Display Windows"](#), on page 99) are also listed in the WINBAR. If a hidden panel is selected, it is redisplayed on the screen with its previously set size and position; it simultaneously receives the focus.

3.3.3 Panels and Display Windows

The R&S UPV audio analyzer distinguishes between the following panels and display windows:

- **Quickstart panel** for quick launching of the most commonly used audio measurement tasks.
- **Panels** used to perform function settings.
- **Configuration panels** used for configuring how the measurement values are to be displayed.
- **Numeric display fields** for displaying the measurement values of the various measurement functions.
- **Combo displays** in which numeric measurement values can be supplemented by bar graphs and limit monitoring.
- **Graphical windows** in which measurement values are displayed in the form of diagrams.
- **Data lists** in which the measurement values are listed in tabular form.

Panels are opened on the currently displayed screen by activating the menu bar using the MENU key, highlighting the "Instruments" or "DispConfig" button with the cursor keys and/or rotary knob, opening the pulldown menu with the ENTER key or with a rotary-knob click, and then highlighting the desired panel and selecting it with a rotary-knob click.

Display windows are selected in the same way, except that they are listed under the "Displays" menu item.

The quickstart panel has a special role and can only be opened by clicking the rocket icon in the toolbar.

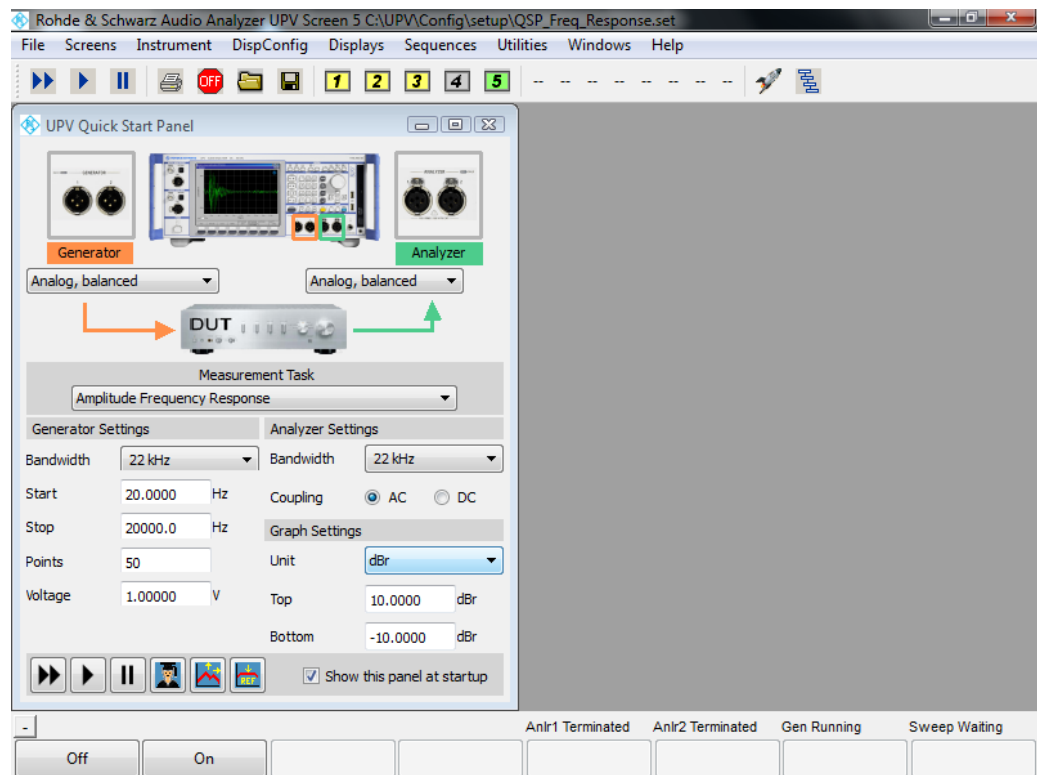
Each panel and display window is a separate window which can be either closed, opened or hidden. Panels/display windows are open if they are visible on the currently displayed screen; if the window is minimized and moved to the bottom edge of the screen, it is referred to as hidden.

In both cases, the panel/window is assigned an entry in the WINBAR at the bottom of the display. Only one window on the screen can be activated at any one time using the softkeys on the WINBAR (active windows are identified by their blue title bar).

As soon as a panel/display window can be operated, it can be moved on the screen and adjusted in size: Grab the panel at the title bar with the mouse and move it. The size of the panels can be changed by grabbing the edges or corners of the panels with the mouse and moving them.

The same panel / display window can be displayed in several screens at the same time. The display characteristics can be different for each of the screens; the content is, however, always the same.

3.3.4 Quickstart Panel



3.3.4.1 Introduction

Owing to the large number of measurement functions and setting options, beginners can often find the R&S UPV audio analyzer difficult to operate.


The **quickstart panel** provides assistance – it allows the inexperienced user to specify the outputs and inputs to which he wants to connect his "device under test" and, in particular, which audio measurement task he wants to carry out. A range of the most important audio measurement tasks are offered depending on the selected outputs and inputs. With just a few mouse clicks, the audio analyzer is automatically configured such that the desired measurement result appears on the screen numerically, as a trace or as a bar graph. Some entry fields allow the user to slightly modify the selected measurement function and adapt it to his own particular needs.

3.3.4.2 Opening and Closing Quickstart Panel

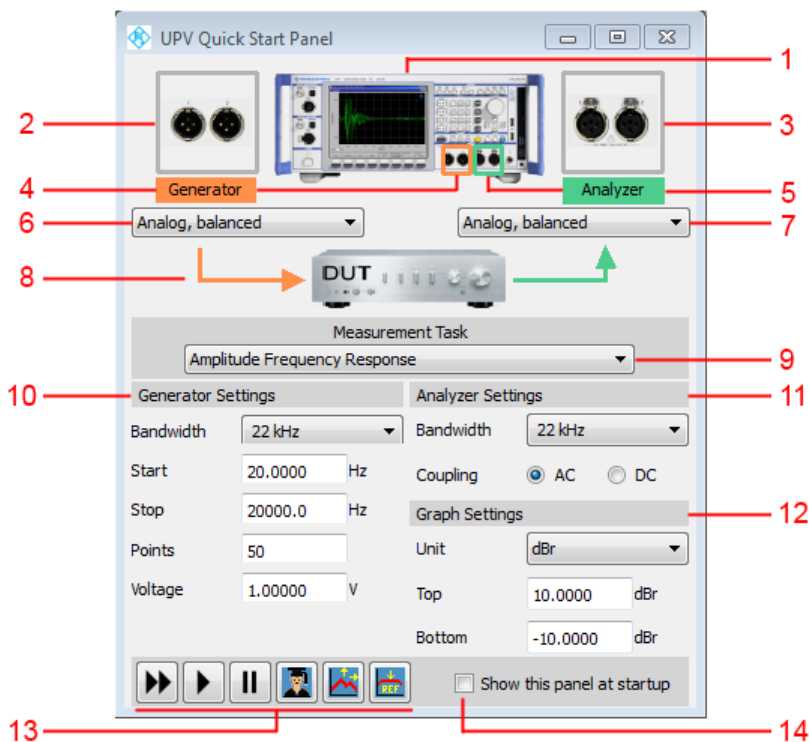
The quickstart panel is opened using the rocket icon on the toolbar:



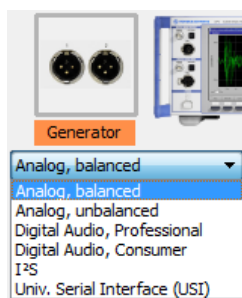
The display immediately changes to screen 5 containing the quickstart panel.

As users become more familiar with the R&S UPV audio analyzer, they can use the expert icon  to change over from the quickstart panel to the normal user interface of the audio analyzer in order to access the full range of functions.

3.3.4.3 Description of Quickstart Panel Controls

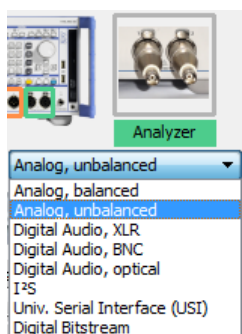


1. Image showing the current audio analyzers and its options.
2. Magnified view of the generator outputs that were selected using the combo box (6). If the outputs are on the rear of the instrument, "Rear" appears in red in the image.
3. Magnified view of the analyzer inputs that were selected using the combo box (7). If the inputs are on the rear of the instrument, "Rear" appears in red in the image.
4. Selected generator outputs on the instrument are highlighted in orange if they are accessible from the front.
5. Selected generator inputs on the instrument are highlighted in green if they are accessible from the front.
6. Combo box for selecting the desired generator outputs.



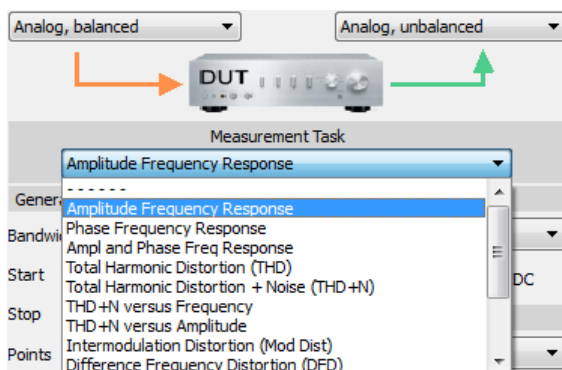
The available selection depends on the R&S UPV audio analyzer and its options. The entries are self-explanatory. Each time the generator output is changed, the combo box for selecting the desired measurement task (9) is reset (- - - - -) and a new measurement task must be selected.

7. Combo box for selecting the desired analyzer inputs.



The available selection depends on the R&S UPV audio analyzer and its options. The entries are self-explanatory. Each time the analyzer input is changed, the combo box for selecting the desired measurement task (9) is reset (- - - - -) and a new measurement task must be selected.

8. Symbolic representation of a device under test (DUT) and its connection to the generator and R&S UPV audio analyzer without operating options.
9. Combo box for selecting the desired measurement task.




When the quickstart panel is called for the first time, no measurement task is selected; this is indicated by the dashed line.

The available selection depends on the settings made in the combo boxes (6) and (7). The entries are self-explanatory.

Example: If the "Analog, balanced" output has been selected in the combo box (6) for signal feed to the DUT, the measurement task "D/A Linearity" is **not** available as this is intended only for a digital output.

Selection of a measurement task sets up the R&S UPV audio analyzer accordingly without further action being required. With some measurement tasks, the measurement must be started by clicking the "Start continuous measurement" or "Start single measurement" button (13).

If a "Measurement Task" is selected in the quickstart panel, screens 1 to 4 display the settings as well as the numeric and/or graphical displays for the selected measurement tasks.

10. Entry fields for customizing the generator settings.
Example: Adjustment of the start and stop frequency for a frequency response measurement.
11. Entry fields for customizing the analyzer settings.
Example: Switching over the input coupling from AC to DC.
12. Entry fields for customizing the graphical display.
Example: Changing the unit on the Y axis.
13. 

Meaning of the buttons from left to right:

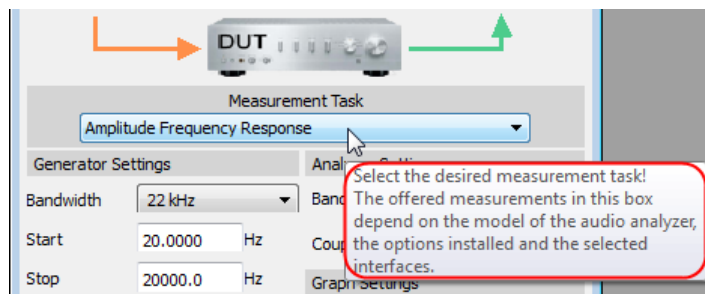
- **Start continuous measurement**
- **Start single measurement**
- **Pause / continue measurement**
- **Switch to expert mode:** Access to the full range of functions of the audio analyzer.
- **Autoscale graph:** One-off automatic scaling of the graphical display based on the current minimum and maximum values of the curves or bars.
- **Set to reference:** The Y value of the curve is used as a reference value once at the value 1000 Hz or 997 Hz (1000 Hz with analog measurements, 997 Hz with digital measurements), provided that the Y axis of the graphical display is shown in dBr. The curve is adjusted to 0 dBr at this point.

14. Show this panel at startup

When the audio analyzer is switched on, the quickstart panel is available in screen 5 without it having to be called specifically.

3.3.4.4 Tool tips

All the controls in the quickstart panel have so-called tool tips. If you hold the mouse pointer over a control for approx. 1 second, a brief description of the function appears.



3.3.4.5 Messages During Operation

When the "Set to reference" button is clicked, messages that indicate problems can appear. For example, "Set to reference" is only effective if the Y axis of the graphical display is set to the unit dBr. If this is not the case, an info box indicating this appears.

3.3.4.6 Settings Outside Quickstart Panel

Settings made at a later time outside the quickstart panel, i.e. in the standard user interface of the R&S UPV audio analyzer, will result in inconsistencies between the settings in the quickstart panel and the actual setup of the R&S UPV audio analyzer; making subsequent settings outside the quickstart panel may, however, be necessary. The message "Operations outside Quickstart Panel detected! QSP display might be different!" in the user info line (line above the softkey bar) alerts the user to this as a precaution. Reselecting a "Measurement Task" will cancel out any inconsistencies in the settings.

3.3.5 Structure of the Panels and Display Windows

The R&S UPV audio analyzer features the following panels with their main settings (for a detailed list of all panels with the most important setting parameters, see [chapter 4, "Manual Operation"](#), on page 136).

Panels which can be selected via the "Instruments" menu bar button:

Generator Config	<ul style="list-style-type: none"> • Selection of instrument (analog or digital interfaces) • Configuration of channels and bandwidths • Reference values
Generator Function	<ul style="list-style-type: none"> • Selection of test signals • Sweep function • Frequency and level settings • Filter and equalizer • DC Offset
Analyzer Config	<ul style="list-style-type: none"> • Selection of instrument (analog or digital interfaces) • Configuration of channels, measuring bandwidth and pre-filter • Range configuration • Reference values • Start and trigger conditions

Analyzer Function	<ul style="list-style-type: none"> • Selection of measurement functions • Measurement speed and accuracy • Activation of filter and equalizer • Activation of Post FFT • Selection and settings for level monitor • Selection and settings for input monitor • Selection and settings for frequency, phase, group delay measurement • Selection and settings for waveform monitor
Filter	<ul style="list-style-type: none"> • Definition of filter properties
Auxiliaries	<ul style="list-style-type: none"> • Settings for integrated loudspeaker and connected headphones • Settings for R&S UPV U2 BNC audio monitoring outputs • Settings for auxiliary analog output • Settings for trigger input and trigger output
Switcher Panel	<ul style="list-style-type: none"> • Operation of one or more R&S UPZ audio switchers
Protocol Generator	<ul style="list-style-type: none"> • Settings for the R&S UPV K21 digital audio protocol

Panels which can be selected via the "DispConfig" menu bar button:

Function Config Level Monitor Config Input Config Freq Phase Config	<p>These four panels contain settings for displaying measured values</p> <ul style="list-style-type: none"> • in the numeric display fields • in the associated combo displays • and settings for limits, minimum values and maximum values
Sweep Graph Config Impulse Response FFT Graph Config Waveform Config PESQ/POLQA Bar Graph Config	<p>Up to four of each of these panels are available; they contain settings for displaying measurement values in the graphical windows, e.g.</p> <ul style="list-style-type: none"> • One or two-channel display • Units, scaling, grid lines, etc. • Evaluation of minimum and maximum values • Entry of limit curves • Settings for cursors and markers

The measurement results of the audio analyzer are shown in the following display windows (for a detailed list of all panels with the most important setting parameters, see [chapter 4, "Manual Operation"](#), on page 136).

Except for the Dig Analyzer Protocol window, the panels can be selected via the "Displays" button in the menu bar:

Numeric Display	<ul style="list-style-type: none"> • Display of measurement results for measurement function selected in Analyzer Function panel • Display of measurement results for level monitor and/or input monitor selected in Analyzer Function panel • Frequency measurement results, or frequency measurement result and phase / group delay measurement result
Funct Ch1 to 2 Lev Mon Ch1 to Ch2 Input Ch1 to Ch2 Freq Ch1 Freq / Phase	These combo displays are extensions to the numeric measurement displays; they show the respective numeric value plus the following: <ul style="list-style-type: none"> • Analog bar graphs • Limits • Minimum and maximum values
Sweep Graph 1 to 4 Impulse Response FFT Graph 1 to 2 Waveform PESQ/POLQA Bar Graph 1 to 2	<ul style="list-style-type: none"> • Up to four of each of these display windows can be opened (depending on the window type) in order to display the scans of the different measurements • Graphical display shows one or two channels • The measurement results are displayed in the way defined in the associated configuration panel
Dig Analyzer Protocol	<ul style="list-style-type: none"> • The analyzed data of the digital audio protocol is displayed here (R&S UPV K21 option (digital audio protocol))

3.3.6 Basic Rules of Operation

The following basic rules are intended to simplify operation of the audio analyzer:

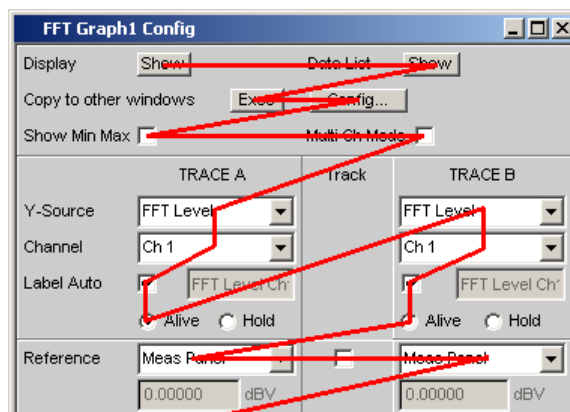
- **Operating sequence in the panels from top to bottom**
Changes to parameters of individual menu items may affect the selection or value range of menu items which are usually located further down (they affect the selection or value range in fields located higher up in only a few exceptional cases).
- **Sequence Generator – Analyzer – Measured value display**
Many setting parameters can be copied to other panels. For example, the sweep frequency settings can automatically be adopted as the scaling for the graph.

3.3.7 Function Selection and Value Entry


All functions and parameters are set in the panels.

The rotary wheel is used for navigating inside the panels. Turning the rotary knob clockwise moves the cursor down or to the right. Here the cursor first moves to the right inside a field, then down through the current group, then jumps over to the right-hand column, down again to the end of the group from where the cursor then moves to the left-hand column of the following group, and so on.

As an alternative, the up/down cursor keys can also be used for navigating.



Panels can only be operated if they have the focus (indicated by the blue title bar).

The simplest way of changing from one panel to another in the case of operation via the front panel is using the direction keys . The > key switches from panel to panel in the order the panels were opened. Changing to a different open (or to a hidden) panel is also possible using the WINBAR (see [chapter 3.3.2, "The Display"](#), on page 97).

Before settings can be made in a panel, the relevant parameter field must be highlighted, i.e. it must have the focus. This is indicated by a selection frame around the entry field.

The settings are made in the following ways:

Highlighting Controls

A control element is activated by shifting the focus to this element using the rotary knob. The entry focus is indicated by a blue, green or magenta border.

Activating/deactivating functions



A checkbox is used to activate or deactivate functions. If the checkbox is active, the assigned setting is selected or enabled.


Toggling Functions

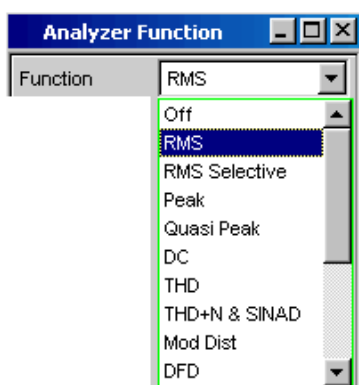


Radio buttons are used for functions which can be toggled between two settings. A black dot in the appropriate button indicates the selected status.


Only one of the two options can be active at any one time.

Select parameter

The  button next to the current selection displays a selection field. As soon as this parameter field has the focus, a list for selecting the available parameters can be opened with a rotary-knob click. The drop-down parameter list is displayed below the selection field.



Parameters are selected by highlighting the desired item and confirming with the ENTER key or a rotary-knob click.

Items in the parameter list are highlighted using the rotary knob, the up/down cursor keys or the  keys.

The parameter list can be exited without adopting the highlighted parameter by pressing the ESC key.

If the list is longer than the displayed window, a scrollbar is available.

Alternatively, parameters can also be selected using the softkeys.



The contents of the parameter lists are not fixed but vary depending on other settings selected.

Entering a Numeric Value

Numeric values can be entered or edited in these fields.



The following always applies: Entries outside the possible value range are not accepted; an audible warning is issued and the entry is changed to its permissible minimum or maximum value. The possible value range is displayed above the softkey bar.

Edit mode:

When the focus is moved to a numeric entry field, the system enters Edit mode, which is indicated by a green selection frame. The new value is entered via the keypad on the front panel.

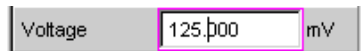
The numeric entry field is closed with:

- ENTER – The newly entered value is adopted
- ESC – The old value is retained
- Softkeys – The selected unit is set and adopted together with the newly entered value.

The entered value is set in the hardware as soon as the numeric entry field is closed.

Direct mode:

It is also possible to enter the value in Direct mode. Changing to Direct mode is performed by pressing the ENTER key or with a rotary-knob click; the color of the selection frame then changes to magenta.

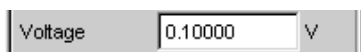


A digit can now be entered using the keypad on the front panel; the digit at the cursor position is replaced.

In Direct mode, every setting change is immediately passed on to the hardware and executed. Direct mode can be exited using the ENTER function or the ESC key.

Entering/Changing the Unit of a Value

The unit of a numeric value is displayed next to the entry field.



When the value is entered, all units available for the respective function are offered on the softkey bar (on more than one level where necessary). The entry can be completed by selecting the unit using a softkey.

This is done differently depending on the selected mode:

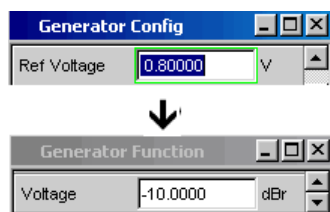
- In Edit mode, the newly entered numeric value is adopted and set together with the selected unit.
- In Direct mode, the physical value (number with the previously selected unit) is converted to the newly selected unit and adopted as the new numeric value.

Information on Using Reference Values

The audio analyzer allows reference values to be set in various places. These reference values are used as a basis for settings for other parameters.

The example below explains these interdependencies:

A reference voltage ("Ref Voltage") can be set in the "Generator Config" panel. The actual output voltage is set in the "Generator Function" panel where the unit is dBr, i.e. it is possible to enter the output voltage in dB relative to this reference value.



Entering Alphanumeric Values

When the focus is moved to a text entry field, the system enters Edit mode, which is indicated by a green selection frame.



If the complete text (e.g. for graph labels) is to be newly entered, simply begin entering characters using the keypad on the front panel; the old text is deleted automatically when the first key is pressed. The keypad on the front panel of the R&S UPV is automatically switched to the mode for entering alphanumeric characters. Text is entered in the same way as on cell phones:

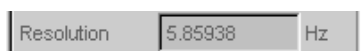
The character to the left of the cursor can be deleted at any time during entry using the UNDO key.

The text entry field is closed with:

- ENTER – The newly entered text is adopted
- ESC – The old text is retained.

Display Fields

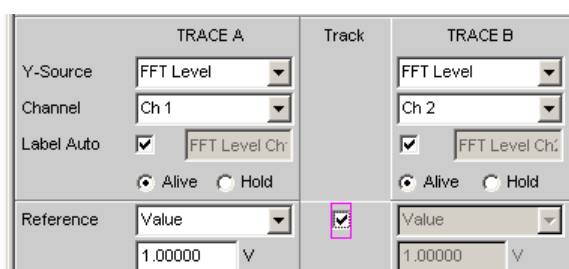
Sometimes it is very useful for operators to receive additional information about their settings.



Display fields inside the panels are used in such cases. These fields are shown in gray and cannot be accessed. They always contain valid values and therefore always show settings active in the background; the fields are updated as soon as a setting in the associated parameter field is changed.

Adopting Parameters

In many cases, settings are to apply e.g. to both measurement channels or to both traces. Here the R&S UPV provides multi-column panels which allow settings to be transferred from the left-hand to the right-hand column without the parameter having to be entered a second time.



If the track box is activated, all of the settings within the function group apply to both columns. All fields with transferred settings in the right-hand column are shown as display fields. They appear gray and cannot be accessed while the track function is active. If a setting is changed in the associated parameter field in the left-hand column, this change is also shown in the display field in the right-hand column.

3.3.8 Input Help

Information on the possible entries is given at the bottom of the screen above the softkey bar. The units offered in the softkey bar and the limits specified in the "Valid

Range" field always refer to the highlighted parameter field. The valid value range is given in the unit currently selected.

Entries outside the specified value range are not accepted; an audible warning is issued and the entry is changed to its permissible minimum or maximum value.



The specified ranges for value entries always take the current status of the instrument into consideration. They are therefore not constant and depend on the presets already configured for other parameters.

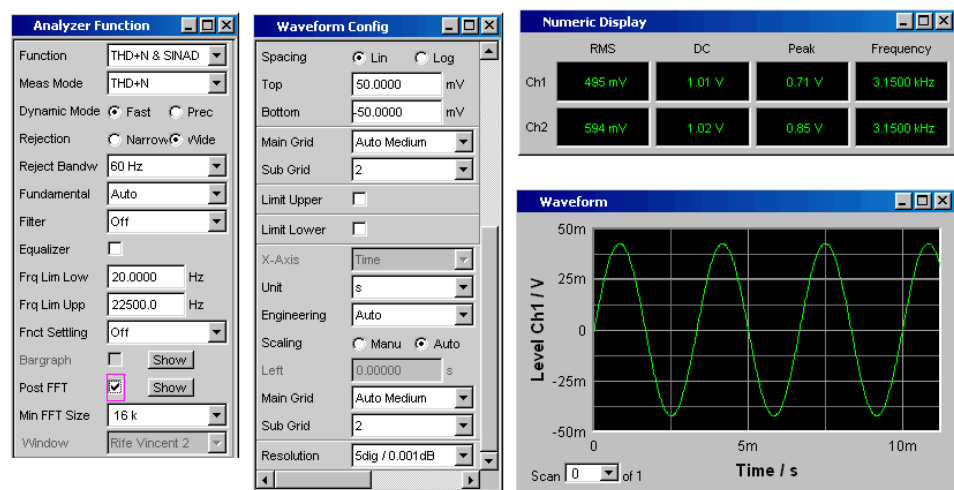
Below is an example for entering the generator output voltage; additional units can be displayed using the >> button:



3.3.9 Measurement Functions and Displaying Measurement Results

The audio analyzer offers various types of measurement windows for displaying the results of the numerous measurement functions. The measurement results can be displayed as digital numeric values, in analog bar graphs, in result graphics or in data lists. The user can open any number of measurement windows on the screen.

- **What** (which measurement function) is measured and **how** (which measurement method) measurement is performed, is preset in the "Analyzer Function" panel.
- The **configuration panels for measured value display** are used to determine how the measurement results are presented (i.e. which unit, how many digits, etc.). A series of panels for the different measurement windows are provided for this purpose.
- The results are finally displayed in the various **measurement windows**.



3.3.9.1 Numeric Display Field

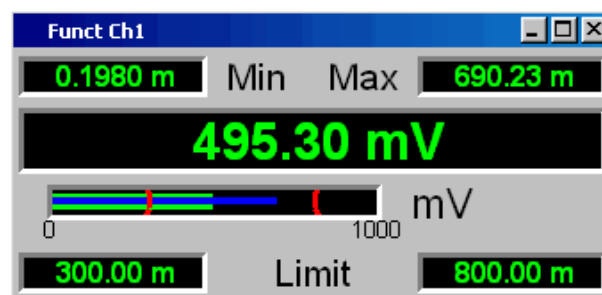
The numeric display field provides a clear overview of the numeric values from various analyzer functions and displays a maximum of 8 numeric value results from the "Analyzer Function" panel. The individual columns are permanently assigned, from left to right:

- Column 1: Measurement results of the function which is set in the "Function" field of the "Analyzer Function" panel.
- Column 2: Measurement results for the set "Level Monitor" function.
- Column 3: Measurement results for the "Input Peak" function.
- Column 4: Display of either the frequency measurement result or, if "Freq & Phase" or "Freq & GrpDel" is set, display of the frequency measurement result in the first row and display of the phase or group delay measurement in the second row.

	THD+N	Level RMS	Input Peak	Frequency
Ch1	-60.025 dB	100.72 mV	142.01 mV	9.6745 kHz
Ch2	-57.746 dB	130.93 mV	184.62 mV	9.6745 kHz

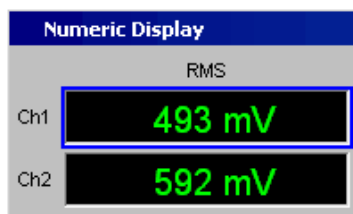
Combo Display

The combo display is used if the numeric value of a measurement result is to be supplemented by analog bar graphs, limit monitoring or the storage of maximum and minimum values.



The free selection and free scalability mean that especially important or critical results can be monitored and tracked even when viewing the screen from a relatively long distance.

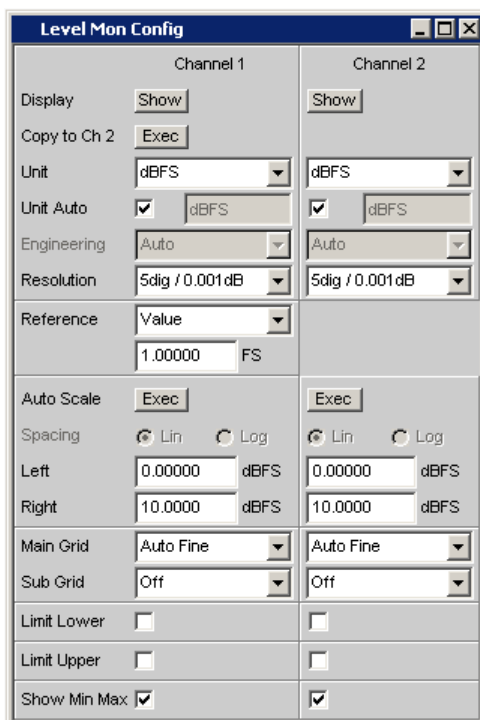
The easiest way to open combo displays is to highlight the respective measurement display in the numeric display field (blue selection frame) and to select the display with the ENTER key or a rotary-knob click.



Configuring the Numeric Display Field and Combo Display

The settings for the individual columns of the numeric display field or for the combo displays are made in the following four configuration panels which can be opened using the "DispConfig" button in the menu bar:

- "Funct Config"
- "Lev Mon Config"
- "Input Config"
- "Freq / Phase Config"



Graphical Window

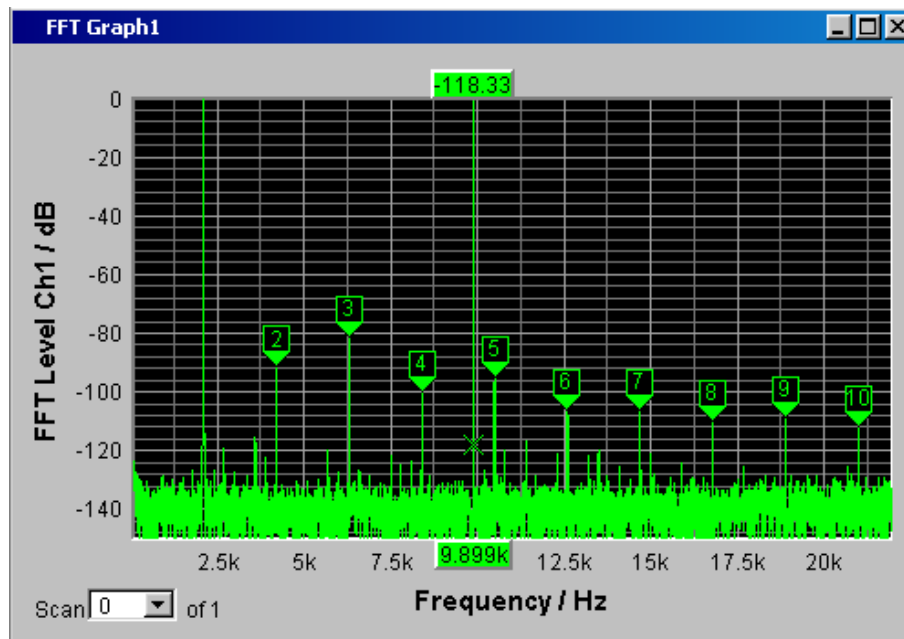
The most informative way of displaying measurement results is to use a two-dimensional graph. The audio analyzer makes a distinction between the following graphical windows:

- Sweep Graph
- Impulse Response
- FFT Graph

- Waveform
- PESQ/POLQA
- Bar Graph

These windows can be set using the associated configuration panels.

All graphical displays can be evaluated using horizontal and vertical cursors; markers are used to identify important measurement points. A broad range of softkey control functions can be used to scale graphs, to display sections of graphs, and to perform many other tasks.



3.4 Introduction to Instrument Operation Using Examples

3.4.1 Measuring the Frequency Response of an Amplifier, Equalizer, etc.

This example is based on the factory settings of the audio analyzer. It explains the changes made in the individual panels to set up the measurement and describes how to graphically display the measurement results. Finally, the example shows how to save the defined measurement setup so that it can be used again for other applications.

1. Step: Loading the factory settings

The easiest way to load the factory settings of the instrument is to press the PRESET key on the front of the R&S UPV.

Alternatively, the factory settings can be loaded by opening the menu bar with the MENU key, highlighting the "File" button with the rotary knob and activating it with a

rotary-knob click, and then highlighting and activating "Preset (Load Default)" in the displayed list in the same way.

2. Step: Setting the required generator signal

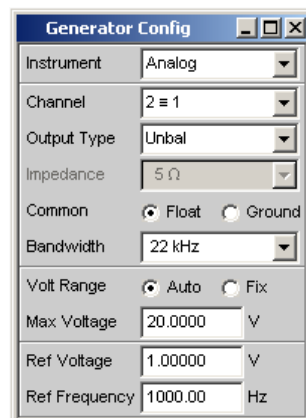
- a) The basic settings for configuring the generator are made in the "Generator Config" panel.

The panel must have the focus before it can be operated. This is already the case with the default setup, otherwise press the WINDOW </> keys until the color of the title bar in the desired panel changes to blue.

The frequency response is usually measured on both channels; this is already configured in the "Channel" field.

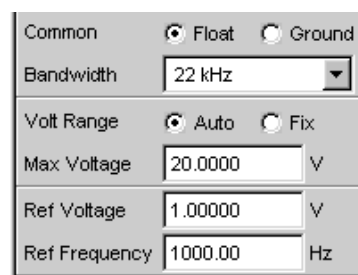
Depending on the DUT, "Output Type" can be switched to balanced circuitry; various output impedances can then be selected in the field below.

If necessary, the required parameter field can be highlighted with the rotary knob; this is then indicated by a selection frame (see image below). A rotary-knob click toggles between the two radio buttons.



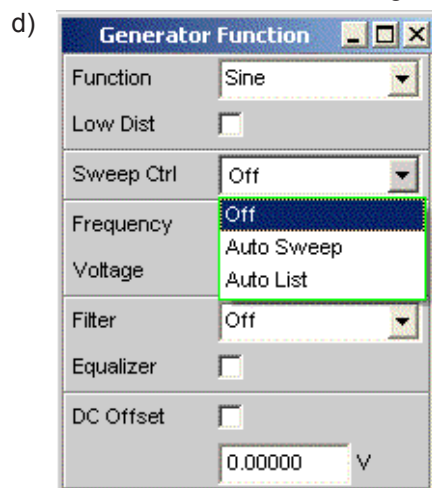
- b) Floating output circuitry for the generator (see [chapter 3.2.3, "Avoiding Hum Loops"](#), on page 95) and a maximum signal frequency of 22 kHz are generally the correct settings to be used.

The following settings are also suitable for the majority of applications and do not have to be adjusted unless necessary.



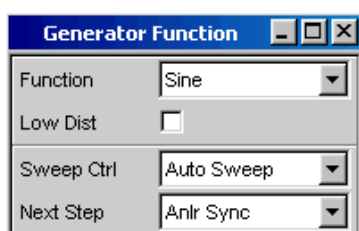
This completes the settings in the "Generator Config" panel.

- c) Next, the "Generator Function" panel must be activated again; press the WINDOW </> keys until the title bar of the panel is marked in blue. Sine-wave signals are required; this setting is already selected. To be able to measure the frequency response, the sine-wave signal must be swept in the frequency. A fixed frequency of "1 kHz" is preset in the default instrument setup. To activate the sweep, select the "Sweep Ctrl" field, open the parameter list and select the desired setting.



The parameter list closes and a number of additional fields appear in which further sweep parameters can be set.

- e) The "Next Step" field remains set to "Anlr Sync". This setting causes the next sweep step to be triggered as soon as a valid measurement result is available in the analyzer part. This synchronization optimizes the sweep speed.



- f) The sweep variable must now be specified in the "X Axis" field. Frequency is already preset here (as required in this example). No other sweep variable is required; therefore, the "Z Axis" field also remains unchanged and set to "Off".
- The "Spacing" selection field is used to select the algorithm for advancing through the sweep points. This can be done using a linear or logarithmic step size; the number of individual sweep points ("Points") or the step size from point to point ("Steps") can be set.
- This selection field is factory-set to "Log Points"; this is the usual setting for frequency response measurements.

X Axis	Frequency
Z Axis	Off
Frequency	
Spacing	Log Points

- g) The values for the start and stop frequency of the sweep must be entered in the two fields "Start" and "Stop".
- Highlighting the desired field gives it the green selection frame. The desired frequency value can now be entered directly (here: 20 Hz). Pressing the ENTER key adopts the value and adjusts the hardware accordingly.

Start	20.0000	Hz
Stop	20.0000	kHz

The possible value range is given above the softkey bar. Entries outside the specified value range are not accepted; an audible warning is issued and the entry is changed to its permissible minimum or maximum value.

Valid Range is 100mHz to 21.75kHz	
Hz	kHz

As soon as the value entry field is highlighted, all available units are displayed on the softkey bar; additional hidden units can be shown using the >> button. Value entry can also be completed by pressing the softkey labeled with the desired unit; this is a particularly useful feature if a value is to be changed to a different unit.

The value for the stop frequency is entered in the same way (here 20 kHz).

- h) The number of desired sweep points must be entered in the "Points" field, 30 points are preset here. Up to 1024 points can be selected (50 points are entered in this example). This generally provides an adequate number of measured values without making the overall test sequence too long.

Start	20.0000	Hz
Stop	20.0000	kHz
Points	50	

- i) The desired output voltage for the measurement is entered in the "Voltage" field; once again, the field must be highlighted before the value can be entered. The value range is again displayed above the softkeys and the available units are shown in the softkeys. The remaining fields are not relevant for this example. Configuration of the generator is therefore complete.

Voltage	<input type="text" value="0.10000"/>	V
Filter	<input type="text" value="Off"/>	▼
Equalizer	<input type="checkbox"/>	
DC Offset	<input type="checkbox"/>	
	<input type="text" value="0.00000"/>	V

3. Step: Selection of required measurement

- a) The basic settings for configuring the analyzer are made in the "Analyzer Config" panel. In order to operate the panel, it must be selected and have the focus. The frequency response is usually measured on both channels; this is already configured in the Channel field. The setting $2 \equiv 1$ means that both channels have the same settings; the following parameter fields appear once only in the panel but affect both channels.

Analyzer Config		[-]	[□]	[X]
Instrument	<input type="text" value="Analog"/>			▼
Channel	<input type="text" value="2 ≡ 1"/>			▼

- b) If necessary, it is possible to toggle between AC and DC coupling using the two radio buttons.

The fields for the measurement bandwidth are already preset with the appropriate setting; no prefilter is required here.

In this example, the signal to be measured is supplied via the balanced input sockets (Bal setting). The analyzer can also be connected to the generator internally.

Floating input circuitry for the analyzer (see [chapter 3.2.3, "Avoiding Hum Loops"](#), on page 95) and the auto-range function are generally the correct settings to be used.

The default settings in the following fields are also correct.

This completes the settings in the "Analyzer Config" panel.

Coupling	<input checked="" type="radio"/> AC <input type="radio"/> DC
Bandwidth	22 kHz
Pre Filter	Off
Input	Bal
Ch1 Imped	200 K Ω
Common	<input checked="" type="radio"/> Float <input type="radio"/> Ground
Ch1 Range	Auto
Ref Imped	600.000 Ω
Start Cond	Auto
Delay	0.00000 s

c) The following are set in the Analyzer Function panel:

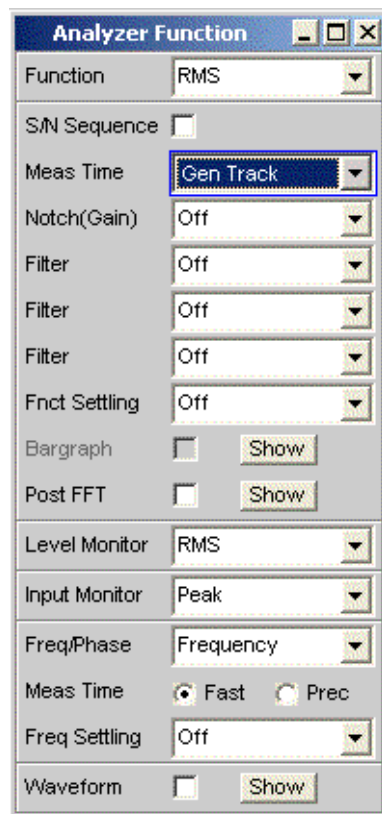
- **what** is measured (which measurement function) and
- **how** measurement is performed (which measurement method)

The RMS value of the voltage must be measured for the frequency response measurement described here; the required setting ("RMS") is already preselected.

The measurement time for each individual measurement point is selected in the "Meas Time" field. The default instrument setting here is Auto which means that the measurement time is automatically adapted to the input frequency, i.e. the test sequence speeds up as the frequency increases. This setting can (with just a few exceptions) be used for the majority of applications.

If the integrated generator is used for measuring the frequency response (as in this example), the setting "Gen Track" should be used. The measurement time is then automatically adapted to the frequency generated in the generator. The frequency information from the generator is passed on directly to the analyzer. The analyzer then adjusts its measurement time to precisely one period (or to an integer multiple of one period). The advantage of this method is maximum measurement speed with maximum accuracy.

All other parameter fields are not relevant for this example. This completes the settings in the "Analyzer Function" panel.



4. Step: Displaying the measurement results – Numeric measurement display

In the default instrument setup, the numeric measurement display is also already open. If the DUT is correctly connected to the audio analyzer, measured values will already be displayed.

	RMS	Input Peak	Frequency
CH1	348.38 mV	496.18 mV	80.000 Hz
CH2	447.38 mV	637.18 mV	80.000 Hz

The panels for configuring the measured value display are used to determine how the measurement results are presented (i.e. which unit, how many digits, etc.). A series of panels for the different measurement windows are provided for this purpose.

The "Function Config" panel is shown here as an example; the first column of the numeric measurement display is configured in this panel, i.e. the display fields which show the measured level values for the frequency response measurement described here.

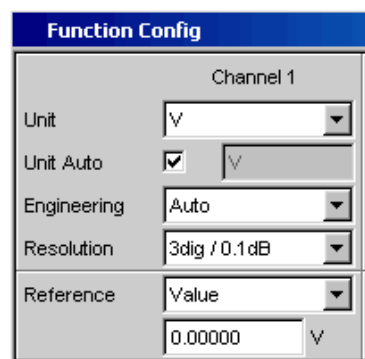
The panel has two columns; to simplify matters, only Channel 1 is shown here.

The unit for the numeric measurement displays is set in the Unit field.

The Engineering parameter is used to determine whether the display automatically toggles between μV , mV and V, for example, or whether other unit formats are desired.

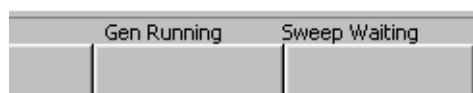
If the measurement results are to be displayed as relative values, they are referred to the reference value set in the Reference field.

Other parameter fields in this panel are used to set limits and to display extreme values. These functions are described in detail in [chapter 4, "Manual Operation"](#), on page 136 and in [chapter 5, "Instrument Functions"](#), on page 237.

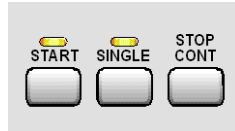


5. Step: Starting the sweep

Although the analyzer is already supplying measurement results, the status message "Sweep Waiting" above the softkeys indicates that the sweep has not yet been started although it has been configured in the "Generator Function" panel.



- a) The sweep is started by pressing the START key in the top right part of the front panel. The status message "Sweep Run Cont" informs the user that when this key is pressed the sweep will start and be repeated continuously.

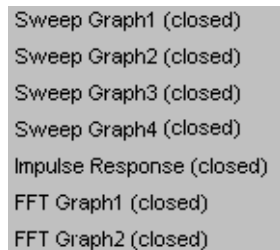


- b) The sweep can be stopped at any time by pressing the STOP CONT key (the status message "Sweep Stopped" is displayed); the sweep continues if the key is pressed again.
- c) If the SINGLE key is pressed, the sweep is started **once** only; "Sweep Terminated" appears in the status field when the sweep cycle has been terminated.
6. Step: Displaying the measurement results – Graphical windows

The results of a frequency response measurement are usually displayed graphically with the measured output voltage values of the DUT being plotted on the frequency axis.

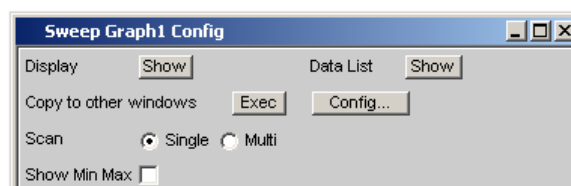
The following settings are required for this:

- a) To avoid overloading screen 1 with too many panels, change to screen 5 to display the graphical representation.
- b) Open the menu bar and, from the selection list under the "DispConfig" button, select the "Sweep Graph 1 Config" panel. As explained above, the way in which the measurement results are presented is determined in the configuration panels. Each graphical window has its own configuration panel. The "Sweep Graph 1 Config" panel required here has two columns, but only Trace A is shown to provide a better overview.



- c) The associated graphical window can be opened using the "Show" button in the "Display" field. The window appears in the same screen so that the effect of the following settings can be observed directly.

In each graphical window, one or two traces (Trace A and Trace B) can be plotted on one x-axis. Each trace can consist of a large number of scans. In this example, only one single scan is to be displayed; the "Scan" field can therefore remain set to "Single".



- d) The traces can display the results of the different measurements available in the R&S UPV.

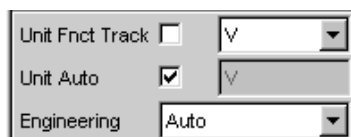
For the frequency response measurement, the measurement results for the measurement function selected in the Function field in the Analyzer Function panel (here the RMS measurement) must be displayed graphically. For Trace A, the Y source field is set to the function result of measurement channel 1 (this is already preset in the default setup).

The "Alive" setting means that the results are displayed continuously; the "Hold" setting "freezes" the traces.



- e) The units to be used for the measured values on the y-axis are set in the next section.

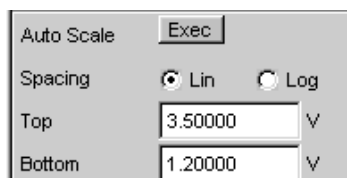
If the unit used in the numeric display window is also to be used in the graphical window, the "Unit Fct Track" checkbox must be activated. If this is not the case, a unit can be selected from the parameter list next to the checkbox. The "Engineering" parameter is used to determine whether the display automatically toggles between μV , mV and V, for example, or whether other unit formats are desired.



- f) All the other default instrument settings are correct and allow a result to be displayed immediately in the form of a graph. If the sweep is started with the START or SINGLE key, the trace appears in the graphical window.



- g) The scaling will probably need to be adjusted. Actuating the "Exec" button in the line "Autoscale" rescales the graph on the basis of the measured minimum and maximum values so that the entire trace fits in the graphical window. The end values for the y-axis can, however, also be entered in the two fields "Top" and "Bottom".



- h) The default settings for the x-axis are also mostly correct for this example:
 By selecting a frequency sweep in the Generator Function panel, the x-axis is automatically defined as the frequency axis with the unit Hz.
 If "Auto" is set in the "Scaling" field, the start and stop frequency of the sweep defined in the "Generator Function" panel is automatically used as the start and end value for the x-axis.
 The "Lin" setting in the "Spacing" field is unsuitable for this example. Since a sweep with logarithmic step size has been selected for this measurement, the x-axis should also be subdivided logarithmically.

X-Source	Sweep		
X-Axis	Frequency	Label Auto	<input checked="" type="checkbox"/> Frequency
Unit	Hz	Unit Auto	<input checked="" type="checkbox"/> Hz
Engineering	Auto	Ref Value	1000.00 Hz
Scaling	<input type="radio"/> Manual <input checked="" type="radio"/> Auto	Spacing	<input type="radio"/> Lin <input checked="" type="radio"/> Log
Left	20.0000 Hz	Right	20.0000 kHz

7. Step: Using a relative unit in the graphical window
 The settings so far made allow the frequency response of the DUT to be displayed graphically but not in a way that conforms to standards.
 In the case of frequency response measurement, the relevant standards stipulate that the deviations of the output voltage must be plotted over frequency, whereby the output voltage of the DUT at the reference frequency 1 kHz (for analog measurements) is used as the reference level.
 The following settings in the "Sweep Graph 1 Config" panels are used to adapt the graph for this measurement example:

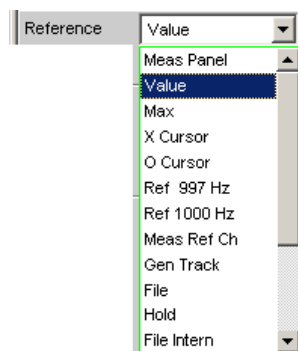
- a) A default reference value of 1 V is set in the Reference field.



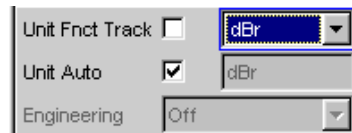
This value must be replaced by the output voltage value of the DUT measured with the reference frequency of 1 kHz.

The R&S UPV offers a very simple way of doing this:

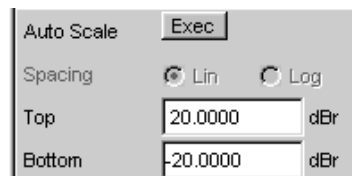
If the parameter list is opened in the "Reference" field, it is possible to select the setting "Ref 1000 Hz". With this setting, the value measured at this frequency is determined (if necessary by means of interpolation between the measured values at the two adjacent frequencies) and used as the reference value.



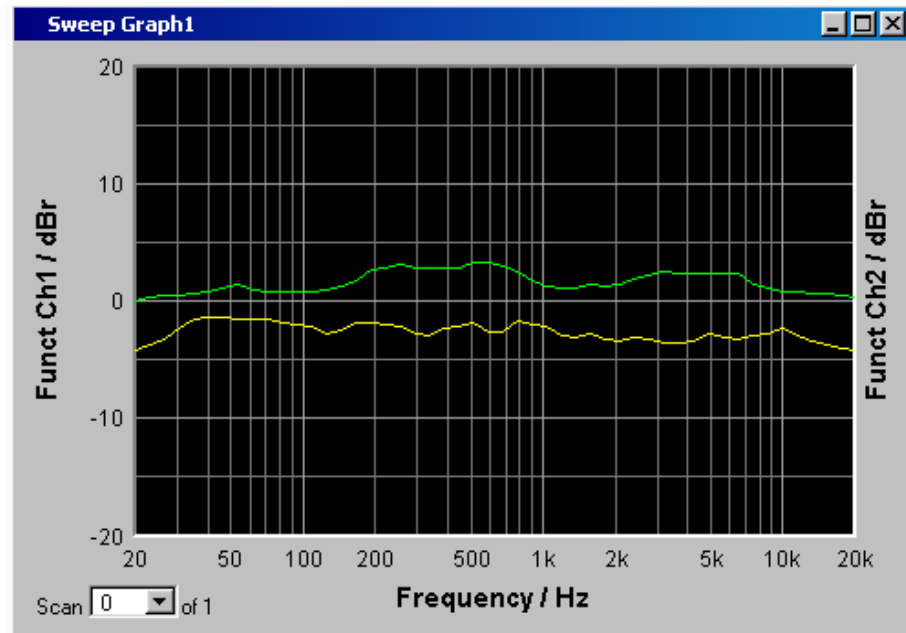
- b) All that remains is to select the unit dBr in the "Unit Fnc Track" field. All measured values are then displayed in dB relative to the reference value selected above. This satisfies the standards defining frequency response measurement.



- c) The y-axis must now be scaled according to requirement, e.g. from +20 dBr to -20 dBr.



- d) If the measurement result of the second channel has been selected for Trace B, the graphical display for the measured frequency response of the DUT may look like the example shown below.



8. Step: Saving this instrument setup

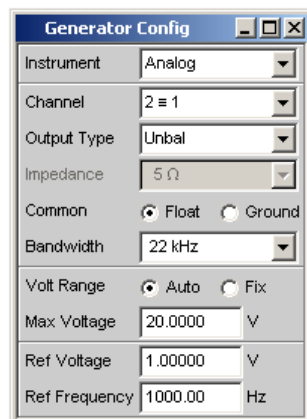
- a) Pressing the SAVE key opens the window for saving files.
- b) The desired file name can now be entered using the keypad on the front panel. The keypad on the front panel of the R&S UPV is automatically switched to the mode for entering alphanumeric characters. Text is entered in the same way as on cellphones: The characters assigned to a key are called up in sequence by repeatedly pressing the corresponding key. A different key can be pressed immediately to enter the next character; a brief pause must, however, be made when entering characters assigned to the same key. The file extension is assigned automatically once the file name has been entered (here .SET); it is advisable to use this automatic assignment function as it prevents entry errors.
- c) If this instrument setup is to be used again at a later date, simply press the LOAD key to reload the setup in the file window.

3.4.2 Measuring Total Harmonic Distortion (THD+N) of a DUT

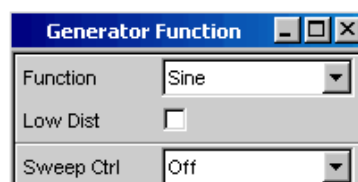
This example is also based on the factory settings of the audio analyzer. However, only the settings in the individual panels which differ from the settings in the previous example are explained.

1. Step: Loading the factory settings

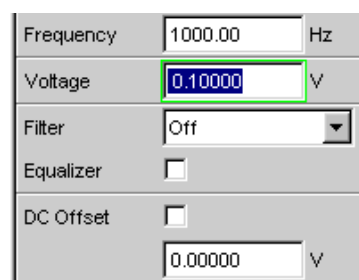
- a) The easiest way to load the factory settings of the instrument is to press the PRESET key on the front panel. Alternatively, the default setup can also be loaded via the menu bar.
2. Step: Setting the required generator signal
- a) In the "Generator Config" panel, the basic settings for configuring the generator in this example are the same as those set for the frequency response measurement described in the previous section. Depending on the DUT, "Output Type" may have to be switched to balanced circuitry.



- b) Next, the "Generator Function" panel is activated. Sine-wave signals are required. This setting is one of the presets. The total harmonic distortion is often only specified for the reference frequency 1 kHz (for analog applications). Fixed frequencies are therefore used for measurement; as a result, "Sweep Ctrl" must remain set to Off.

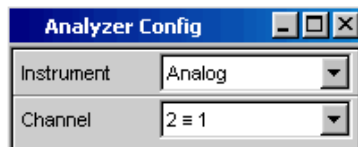


- c) The frequency 1 kHz is already preset in the default instrument setup. Only the output level required for the measurement may have to be adjusted (in the Voltage field). The remaining fields are not relevant for this example. Configuration of the generator is therefore complete.

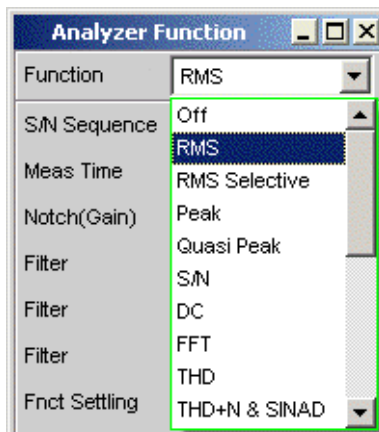


3. Step: Selection of required measurement

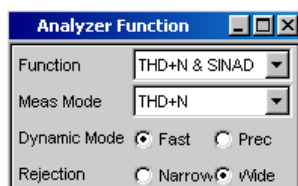
- a) The basic settings for configuring the analyzer are again made in the "Analyzer Config" panel. These settings are made in the same way as shown in the previous example.



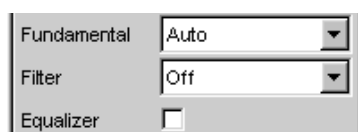
- b) Next, the "Analyzer Function" panel is activated. The measurement function and measurement method are set in this panel. First, the measurement function is selected by opening the parameter list and selecting the item THD+N & SINAD.



- c) In the next field "Meas Mode", various modes for distortion factor measurement can be selected; the presetting "THD+N" is correct for this example. The "Dynamic Mode" determines the maximum dynamic range for this measurement: Fast measurement with restricted dynamic range or maximum dynamic range with a slightly longer measurement time are the two possible options.



- d) With the THD+N measurement, the fundamental of the signal to be measured is suppressed using a notch filter. The audio analyzer can automatically determine the fundamental from the spectrum and adjust the notch filter to it ("Fundamental Auto"). Filter and Equalizer are only required in exceptional cases.



- e) The calculation for harmonics and noise components can, if necessary, be restricted to within band limits which can be entered in the two fields "Freq Lim Low" and "Freq Lim Upp".

Frq Lim Low	20.0000	Hz
Frq Lim Upp	22500.0	Hz

All other parameter fields are not relevant for this example. This completes the settings in the "Analyzer Config panel".

4. Step: Displaying the measurement results – Numeric measurement display

- a) In the default instrument setup, the numeric measurement display is already open.

If the DUT is correctly connected to the audio analyzer, the measured values for the total harmonic distortion can be read off in the first column.

In the default setup, THD+N values are given in dB; if a display in % is desired, this unit can be changed in the "Function Config" panel.

Numeric Display			
	THD+N	Input Peak	Frequency
Ch1	-123.794 dB	-80.722 dBFS	1.9459 kHz
Ch2	-121.515 dB	-78.443 dBFS	1.9459 kHz

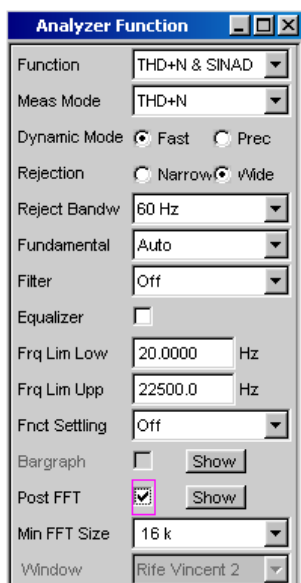
5. Step: Displaying the spectrum in the graphical window

Display of the numeric value alone is sufficient for the majority of harmonic distortion measurements. Here, however, the spectral composition of the output signal at the DUT is also to be analyzed.

With the audio analyzer, it is possible to follow up all distortion measurements with an FFT analysis.

The necessary settings for this are explained in the following section:

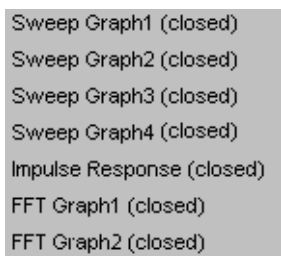
- a) In the "Analyzer Function" panel already used for configuring the THD+N measurement, an FFT analysis to be performed following the measurement can be set after the actual measurement function has been selected. To do this, activate the "Post FFT" checkbox. The size of the FFT can be adjusted if necessary.



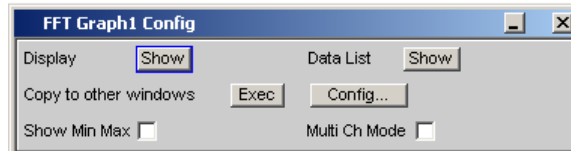
- b) To graphically display the results of the FFT analysis, first change to screen 5, which is empty in the default setting.



- c) Open the menu bar and from the selection list under the "DispConfig" button, select the "FFT Graph 1 Config" panel. As explained in the previous example, the way in which the measurement results are presented is determined in the **configuration panels**. Each graphical window has its own configuration panel. The "FFT Graph 1 Config" panel required here has two columns; to simplify matters, only Trace A is shown in the example.



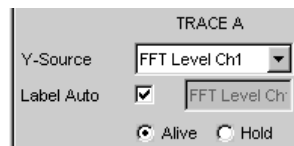
- d) The associated graphical window can be opened using the "Show" button in the "Display" field. The window appears in the same screen so that the effect of the following settings can be observed directly.



- e) In each FFT window, one or two traces (Trace A and Trace B) can be plotted on the frequency axis.

In this example, the level measurement results of the FFT analysis are to be displayed on a graph. For Trace A, the "Source" field is therefore set to "FFT Level Ch1" (this is already preset in the default setup).

The "Alive" setting means that the results are displayed continuously; the "Hold" setting "freezes" the traces.



- f) The settings for the unit, y-axis scaling and grid are already preset in the default setup; a result should therefore be visible. If necessary, these settings must be adjusted.

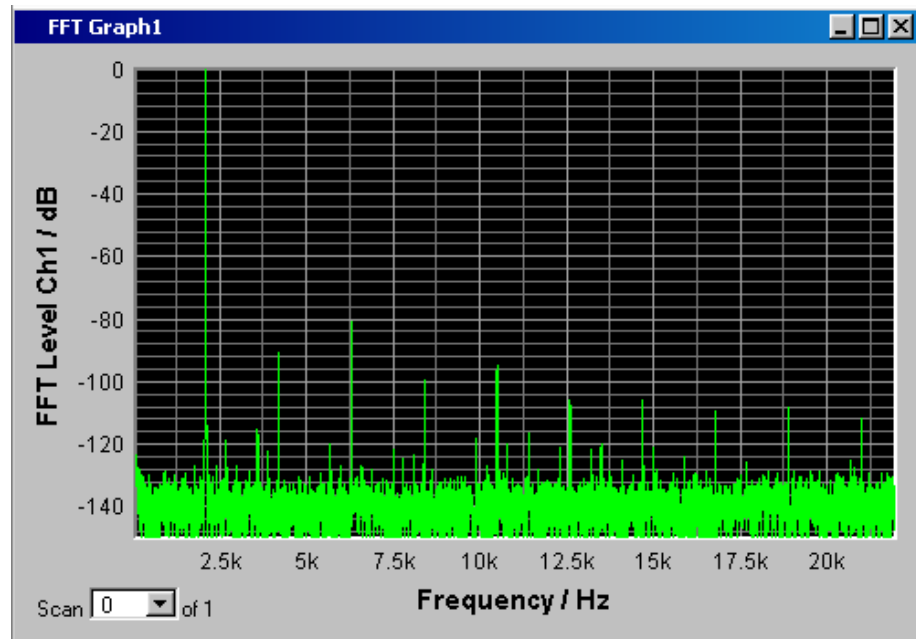


The settings for the x-axis are also mostly correct for this example; they were explained in the previous example.

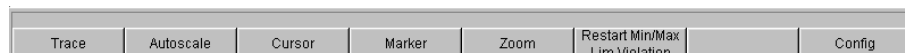
- g) In the "Analyzer Function" panel, you can also use the "Show" button to open the graphical window for Post FFT. However, this displays the window in the same screen, without opening the associated configuration panel.



- h) The spectral display of the output signal with its harmonics may now look like the example shown below.



6. Step: Evaluating the graphic with cursors and markers
- All graphical displays can be evaluated using horizontal and vertical cursors; the X and Y-values shown in the display fields associated with the cursors are always current values. Markers are used to identify important measurement points. The cursors and markers can only be operated using the softkey bar; the required softkeys are displayed at the bottom of the screen as soon as the graphical window has the focus.
- The softkeys are arranged in several levels; the lower levels are accessed by actuating the respective button. Actuating the "Back" button redisplay the higher level.

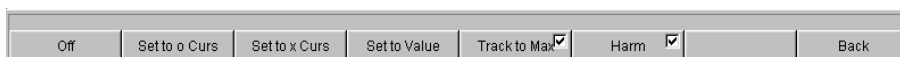


a) Setting markers:

Pressing the "Marker" button calls up the Marker softkeys which are used in this example to first select Trace A so that markers can be set.



The next softkey level appears simultaneously:



The "Track to Max" button is used to set a marker at the maximum value of the curve, i.e. the fundamental in this example of THD+N measurement.

The "Harmonics" button is used to mark the harmonics of the fundamental indicated by the marker.

Pressing the "Back" button twice calls up the first softkey level again.



b) Using cursors:

Activating the "Cursor" button displays the cursor softkeys:



The audio analyzer uses two cursors which are identified by the symbols ○ and X. These symbols are used to mark the measured points in the graph (see the example graph below).

Only one cursor is active and can be moved in the graph at any one time. The active cursor is displayed with a solid line; the inactive cursor is displayed with a broken line.

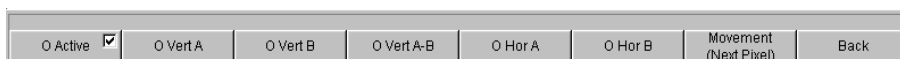
The ○ <--> X button is used to activate the ○ and X cursor alternately.

If, for example, the cursor was activated with the ○ cursor button, the following softkeys appear:

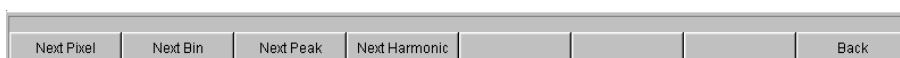


The Vert A button activates a vertical cursor on Trace A; this cursor can then be moved with the rotary knob.

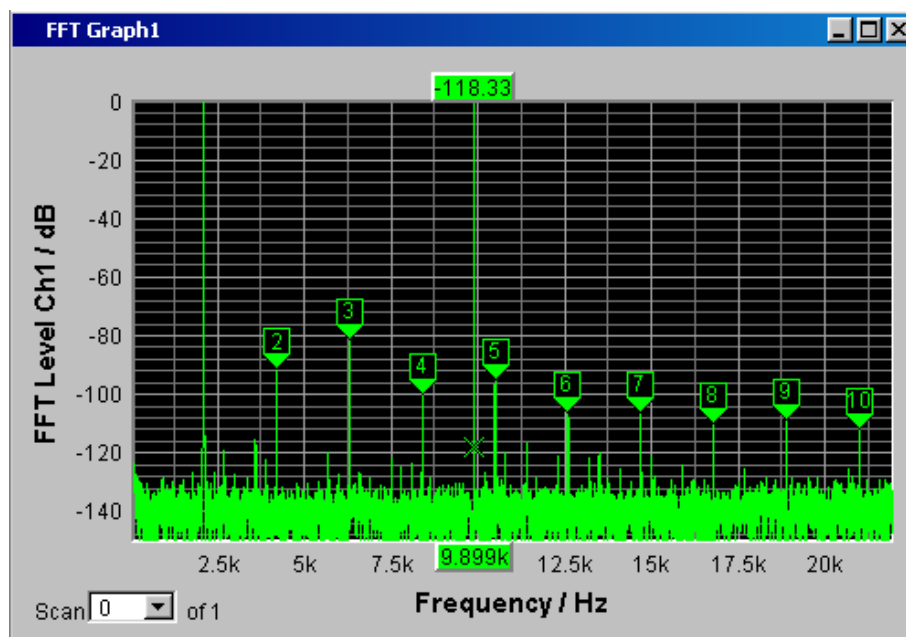
The step size with which the cursor is being moved can be set via additional softkeys of the next level which are called with the "Movement" softkey.



The **Movement** button opens the next softkey level where various step sizes for moving the cursor are offered. The currently selected step size is indicated in brackets in the second label field of the "Movement" button.



- c) With activated markers and a cursor, the graphical display of the output signal with its harmonics may look like the example shown below.



7. Step: Saving this instrument setup
This example can also be saved as an instrument setup. Saving is performed as described in the previous example.

3.5 Loading Predefined Instrument Setups

To make initial measurements easier for new users, example setups for the basic measurements required in audio engineering are supplied with every audio analyzer. These setups allow the instrument to be used almost immediately.

The setup files are available for the different domains (analog or digital) of the generator and analyzer. They are stored in the AA, AD, DA, DD subdirectories of the D:\UPV\Setup Examples directory; the generator domain is listed first followed by the analyzer domain. The file name indicates the respective application.

Many of these example measurements (essentially those at the analog interfaces) can be performed using the basic version of the audio analyzer. The R&S UPV-B2 (digital audio interfaces) or R&S UPV-B20 option is required for all measurements at the digital interfaces.

The predefined instrument settings can be loaded in the following way:

- ▶ The quickest way to load settings is to open the menu bar with the MENU key, highlight the "File" button with the rotary knob and actuate it with a rotary-knob click. The item "Load Example Setup" in the fold-down list that then appears must then be highlighted and actuated in the same way. The file window is opened displaying the directory in which the example measurements can be selected.

Alternatively, the file window used to select the example measurements can also be opened using the LOAD key on the front; in this case, however, the appropriate directories must be selected manually.

All of the setups listed here use the same basic settings.

Basic settings for analog inputs/outputs:

- All channels of the generator and analyzer are active; the unbalanced generator output signal with minimum output impedance and maximum analyzer input impedance are used.
- All inputs/outputs are floating; the auto-range function is activated.
- Frequency sweeps are usually performed logarithmically from 20 Hz to 20 kHz; the appropriate graphical windows are open on the screen; the x-axis is scaled automatically in the associated configuration panels; the y-axis is permanently set to standard values.
- Voltages are mostly given in volts; the generator output voltage is set to 0.1 V; distortion and intermodulation values are given in dB.

Basic settings for digital inputs/outputs:

- Both channels are active; the generator generates 24-bit words; the analyzer analyzes 24 audio bits. The sampling frequency is set to 48 kHz, the Professional format acc. to AES 3 is used. The digital pulse amplitude of the generator is 1 V at the BNC outputs, which corresponds to 4 V at the symmetric outputs.
- Levels are mostly given in dBFS; audio signals are usually generated at a level of –20 dBFS.

Users can, of course, adapt the used basic settings to their own specific measurement tasks at any time. To do this, the respective setup must be loaded and the appropriate changes are then made in the panels. The setup can then be saved again.

The application setups are also updated when new audio analyzer firmware is installed. Modified setups should therefore be saved under a different file name.

Users are also free to create new directories for their customized setups.

4 Manual Operation

4.1 Introduction - Manual Operation

The R&S UPV audio analyzer is available in two models. The R&S UPV standard model and the R&S UPV66 which is specially designed for use in systems and has no display, no front panel controls and no CD/DVD drive. Apart from the omission of front-panel operation, the R&S UPV66 model has largely the same functions as the standard model. This manual therefore describes both instruments in parallel without referencing the R&S UPV66 model in particular, and any differences are indicated at the appropriate points in the text.

The R&S UPV audio analyzer uses the Windows® XP operating system. The instrument is therefore operated in largely the same way as other Windows® applications. All panels and display windows have the standard Windows® format and are operated in the same way. The rotary knob, keys and softkeys, or alternatively an external keyboard and/or mouse, allow direct and convenient access to entries and settings. The clearly organized display shows the current state of the audio analyzer.

The R&S UPV model can be fully operated using the control elements on the front panel; additional peripherals such as a mouse and keyboard are not essential requirements. They can, however, be connected so that the user is free to decide how to operate the R&S UPV. Mixed operation is also possible.

If the R&S UPV66 model is to be operated manually, you need to connect an external monitor, a mouse and a computer keyboard. The section "Overview of Keys" at the end of this chapter provides the keys and shortcuts on a computer keyboard that correspond to the front-panel keys available with the R&S UPV model. For further information on operation by means of mouse and keyboard, refer to the sections "Operation Using the Mouse" and "Operation Using an External Computer Keyboard" in this chapter.

The use of the toolbar simplifies the operation of both models when using the mouse. See [chapter 4.9, "Settings in the Menu Bar"](#), on page 203.

Numerous online help functions assist the user in making settings.

After being switched on, the instrument is in the same state as it was before it was switched off. This applies to all setting parameters of the R&S UPV, including those not currently displayed on the screen.

The following chapter describes the manual operation of the R&S UPV audio analyzer. This includes a description of the screen displays, how to operate the panels and how to set parameters. Each of the setting descriptions is accompanied by a table explaining how the different functions are performed via the front panel and using an external computer keyboard or mouse.

An overview of the keys, panels and display windows can be found at the end of this chapter.

The functions of the R&S UPV audio analyzer are described in detail in [chapter 5, "Instrument Functions"](#), on page 237. An explanation of the general operating concept and a brief introduction that contains step-by-step configurations for initial measurements is described in [chapter 3, "Getting Started"](#), on page 94. The remote control of the instrument is described in [chapter 6, "Remote Control - Fundamentals"](#), on page 802 and [chapter 7, "Remote Control - Command Description"](#), on page 847.

4.2 Functional Division of the Audio Analyzer

4.2.1 Instrument Concept

The audio analyzer combines the following components in a single housing:

- Generators with analog and – with the R&S UPV-B2 (digital audio interfaces) option (or R&S UPV-B20) – also digital audio interfaces for generating various test signals,
- Analyzers with analog and – with the R&S UPV-B2 option (or R&S UPV-B20) – also digital audio interfaces for extensive measurement options and
- a computer (PC) with the Windows XP® operating system for controlling and operating the entire instrument and with connections for peripherals and LAN.

4.2.2 Generators

4.2.2.1 Universal Generator

The universal generator consists of signal processors and generates various test signals, from sine-wave tones to intermodulation test signals (two-tone signals) to noise signals and multi-tones. Following appropriate conversion, these signal are made available at the analog outputs.

With the R&S UPV-B2 (digital audio interfaces) option (or R&S UPV-B20), they can also be output as digital data streams in various formats at AES/EBU and SPDIF interfaces and at optical interfaces.

The R&S UPV-B4x options, which can be installed in the expansion slots at the rear of the instrument, provide further interfaces for outputting test signals.

The R&S UPV-B2 (digital audio interfaces) and K21 (digital audio protocol) options can also be used to generate digital ancillary data, such as channel status data, validity and parity bits.

The R&S UPV-B2 (digital audio interfaces) and K22 options allow the universal generator to be used to generate impairment signals for applying jitter or common-mode interference to the DUT connected to AES/EBU and SPDIF interfaces.

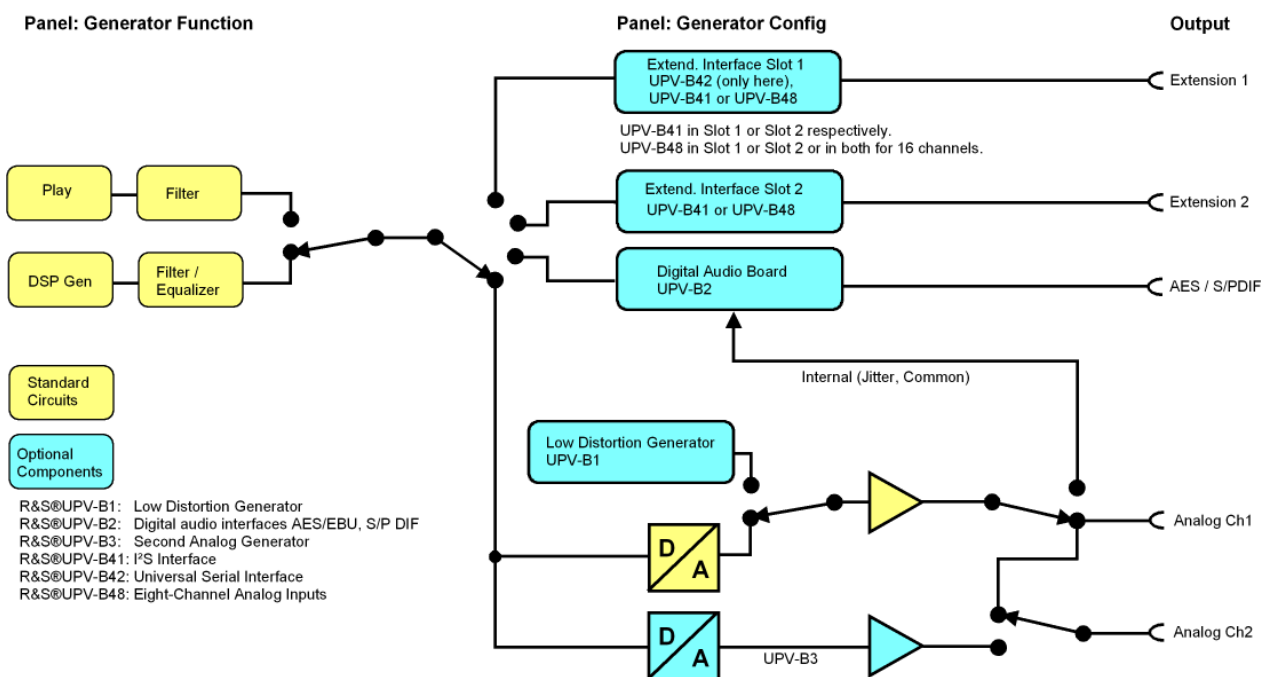
All test signals can be output on one or two channels. The R&S UPV-B3 hardware option expands the R&S UPV with a second **analog** output amplifier. This allows different signals to be output on the two analog output channels. With all the digital generator options (R&S UPV-B2, -B20, -B41 (I²S interface) or -B42 (universal serial interface), two different signals are also available at the digital outputs.

4.2.2.2 Low-distortion Generator

The low-distortion generator is required for all applications where extremely pure analog signals are necessary, or when an extended frequency range up to 185 kHz is needed (R&S UPV-B1 option). Its intrinsic distortion is considerably less than the already excellent values for the universal generator.

4.2.2.3 Function Blocks and Their Assignment to Control Panels

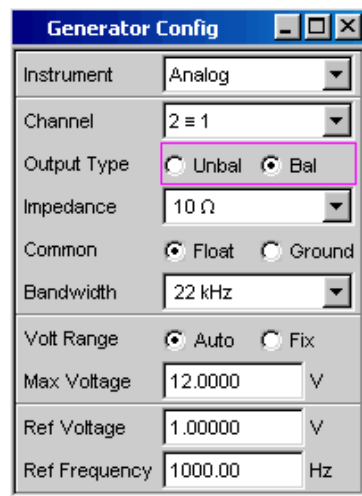
The diagram below shows the function blocks of the generators in the audio analyzer:



The generators of the R&S UPV are operated in two stages:

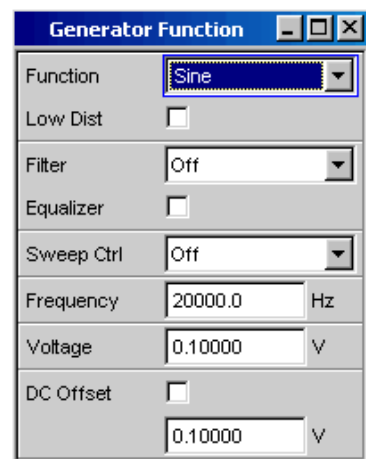
1. In the first step, the following settings are made in the "Generator Config" panel:
 - the audio interfaces at which the test signals are to be output
 - the channels which are to be active
 - maximum level and reference values
 - etc.

Output as impairment test signals is also set here.



2. In the second step, the following settings are made in the Generator Function panel:

- type of test signal
- output level
- frequencies
- etc.



4.2.3 Analyzers

The R&S UPV performs all measurements using digital signal processing. Here, analog signals to be measured are first subjected to complex 2-channel analog **preprocessing** on analog measurement modules before they are digitized and fed to the digital measurement routines.

This concept has the following advantages:

- All audio measurement functions are available at both the analog and the digital interfaces.
- The measurement methods at the analog and digital interfaces are identical.

- Operation at the analog and digital interfaces is always the same.
- The analog preprocessing makes it possible to achieve a higher dynamic range than that provided by the internally used 24-bit converter.
- The R&S UPV can also perform the complex measurement functions simultaneously on both channels; this alone halves the time required for stereo measurements.
- Several measurement functions, e.g. level measurement, FFT analysis, waveform analysis, etc., are calculated simultaneously on separate signal processors and can therefore be displayed at the same time without a delay.
- The digital measurement routines can continuously adapt their speed to the current input frequency and thus achieve high measurement speeds.
- Since the filters are also digital, an almost infinite number of filters is available and can also be used for measurements at analog interfaces.

With the R&S UPV-B2 (digital audio interfaces) option (or R&S UPV-B20), digital audio data streams can also be measured at AES/EBU or SPDIF interfaces.

The R&S UPV-B4x options, which can be installed in the expansion slots at the rear of the instrument, provide further interfaces for analyzing signals in other formats.

4.2.3.1 Function Blocks and Measurement Levels

The analyzer component of R&S UPV contains a series of measurement options that are organized in various measurement levels. The measurement results of these levels can also be displayed simultaneously.

The unfiltered input signal is analyzed at the **input monitor level**. The peak level at the input connectors is analyzed here.

The pre-filter, which can be looped into the signal path before all other analyses, is located in front of the **level monitor**. Here you can analyze the RMS value, the peak value or the DC voltage component of the signal to be tested.

Following any additional filtering using up to 3 filters, detailed analysis is initiated in the **function level**. All the usual analysis tools for measuring linear and non-linear distortion, interference, etc., can be found here. The analysis in the time domain (waveform) as well as the FFT analysis with extreme dynamic response and frequency resolution take place here. Moreover, it is possible to record input signals to the hard disk in order to analyze them at some point later.

In the **Freq/phase level**, the measured values for **frequency** and **phase** or **group delay** can be displayed in a different measurement window parallel to the structure described above.

The **audio monitoring output** (integrated loudspeaker or headphones connection) can be activated on each of the three levels and thus permits audio monitoring of analog or digital input signals both directly at the input and at the different analysis levels. The generator signal can also be switched to the loudspeaker / headphones.

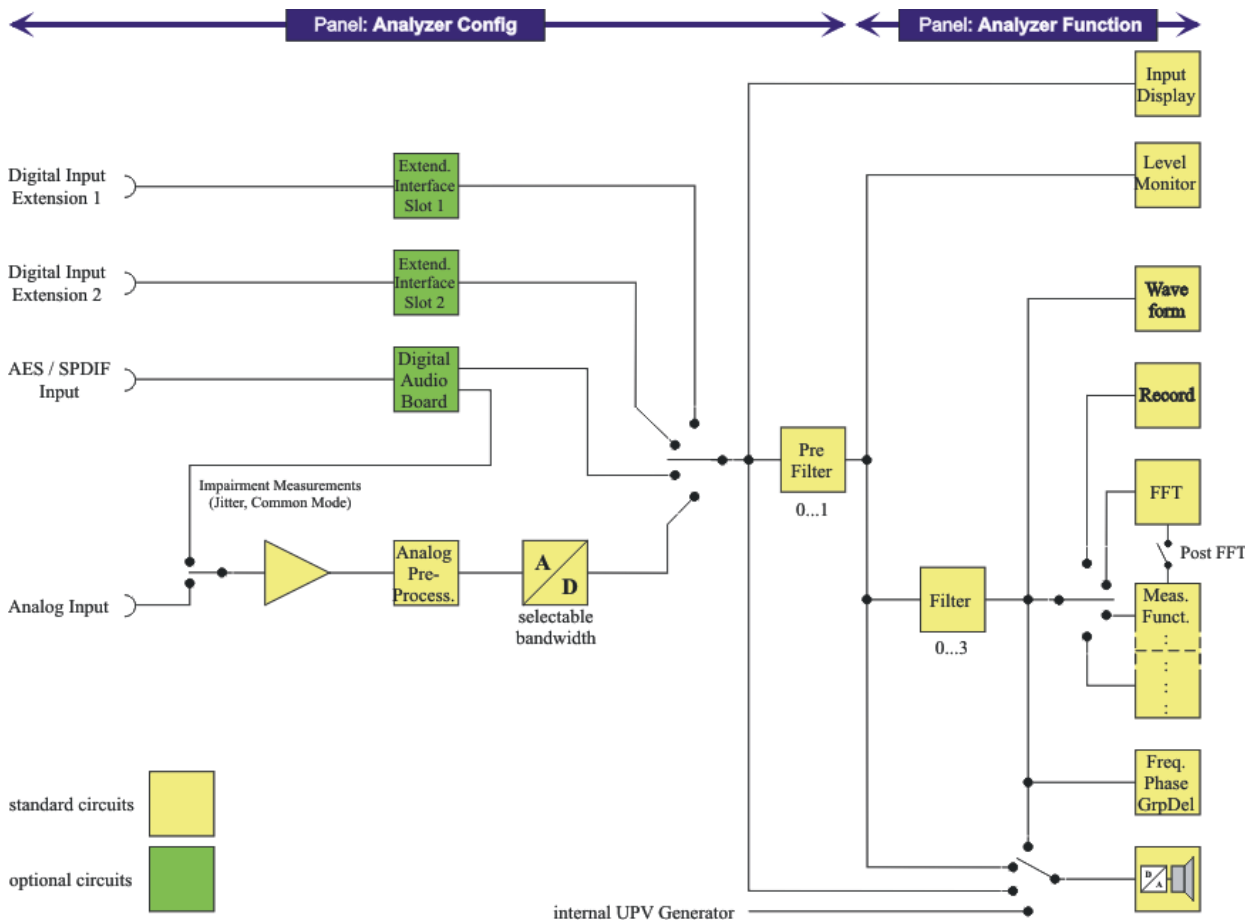
With the R&S UPV-U2 option, the signals of the audio monitoring output can also be output at the BNC sockets at the rear of the instrument.

With the R&S UPV-B2 (digital audio interface) and -K22 options, the **digital interface parameters** of DUTs at the AES/EBU or SPDIF interfaces, such as jitter, pulse amplitude, scan frequency, etc., can also be analyzed.

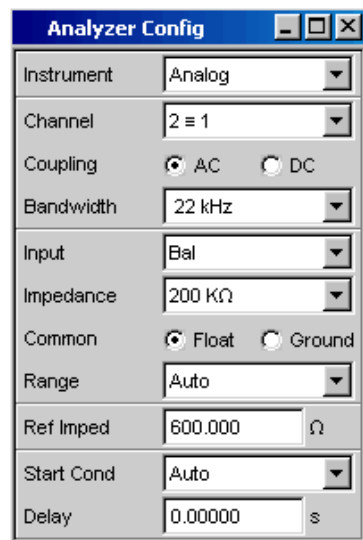
The results of these different measurement functions can be displayed in various ways in the **measurement windows**. The type of display, the units used, scaling, etc., can be set differently for each measurement function in the associated panels.

The diagram below shows the function blocks and the analysis levels of the R&S UPV:

Similar to the generator component, the analyzer component is operated in two stages:



1. Operation begins in the "Analyzer Config" panel with the selection of:
 - analog or digital input connectors
 - number of channels
 - AC or DC coupling
 - IF bandwidth
 - and a number of other parameters

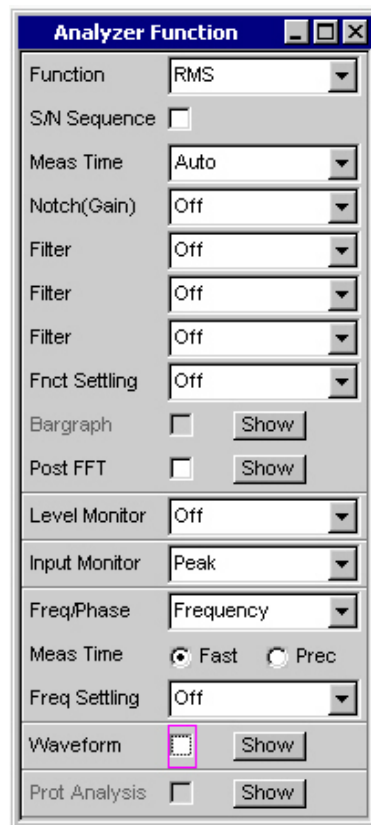


2. In the second step, the measurements are set at the various analysis levels in the "Analyzer Function" panel.

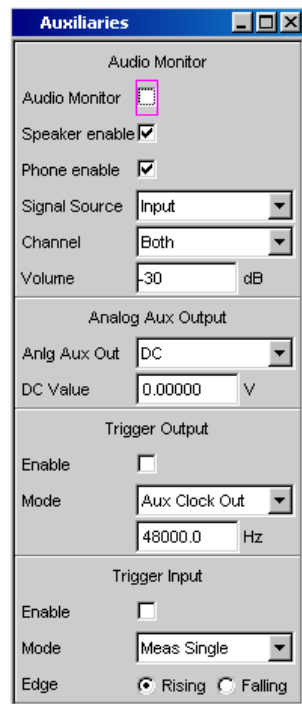
The measurements are set in the order of their importance:

- Measurements at the function level, e.g. distortion measurements (possibly with Post FFT enabled)
- Settings at the monitor level, e.g. DC measurement
- Display of the peak value at the input monitor level
- Display of frequency, phase/group delay in the freq/phase level

In addition, the Waveform and, if necessary, Protocol Analysis functions can be switched on and off in this panel.



3. If audio monitoring using the integrated loudspeaker or with headphones is required, this is set in the "Auxiliaries" panel.



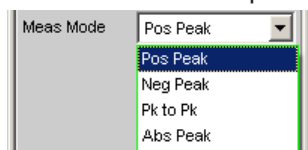
4. The following settings can be made in other panels:
 - the way in which the measurement results are to be displayed (numerically or graphically)
 - scaling
 - limit monitoring
 - minimum and/or maximum values
 - and many other parameters

4.3 General Information on Operation

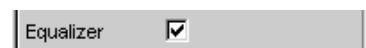
4.3.1 Windows User Interface

To provide the user with a familiar environment, operation is largely based on the Windows® user interfaces. All panels, entry windows, etc., are made up of known elements, for example:

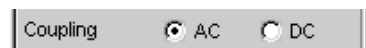
- Selection fields with parameter lists



- Checkboxes



- Radio buttons



- Entry fields



A blue, green or magenta selection frame or the highlighting of an entry field (dark background) indicates the current entry focus. Entries can be made in the element with entry focus.

Operation follows the same basic rules which apply to other Windows programs in use today. It is assumed that the user is familiar with these basic rules. This information is therefore not given in detail in this manual.

4.3.2 Using the Rotary Knob

Operation is possible using the front-panel keys, an external keyboard and/or a mouse. However, most of the settings can be made with the rotary knob:

- Turning the rotary knob shifts the entry focus to the desired element.

- Pressing the rotary knob (rotary-knob click) opens the parameter list in the selection fields; a parameter can be selected from the list by again turning and then clicking with the rotary knob.
- Checkboxes are activated/deactivated by clicking with the rotary knob.
- The individual radio buttons are selected by turning the rotary knob; they are toggled by clicking with the rotary knob.
- In the entry fields, the numeric values can be changed directly (with immediate effect on the setting) or first edited and then adopted by clicking again with the rotary knob.

4.3.3 Operation Using the Mouse

Similar to other Windows® programs, the R&S UPV can also be operated with a mouse. To permit this, a commercially available mouse (not supplied with the instrument) is connected to one of the four USB interfaces at the front or rear of the instrument (see [chapter 2.7.2, "Connecting an External Mouse"](#), on page 51).

The mouse makes it easier to move and resize the panels and graphical windows on the screen and provides alternative control options. It allows easy operation of Windows®.

Specifically for mouse operation, the R&S UPV also features a menu bar that either can be displayed permanently at the top of the screen or appear at the top of the screen as soon as the mouse pointer is moved to the left side of the screen, and a toolbar that either can be displayed permanently at the top edge of the screen or appear at the right side of the screen as soon as the mouse pointer is moved there. In both cases, the permanent display is set in the config panel under the heading "Always visible". This toolbar contains a number of icons for calling up frequently used functions.

The functions of the mouse correspond to the following front-panel functions:

Mouse	Front panel	Function
Left-click	ENTER key, Rotary knob click	<ul style="list-style-type: none"> • Activates selection fields • Selects parameters • Activates/deactivates checkboxes • Toggles radio buttons • Quits the Edit mode
Moving the mouse pointer to left-hand edge of screen	MENU key	<ul style="list-style-type: none"> • Shows the menu bar
Moving the mouse pointer to right-hand edge of screen	---	<ul style="list-style-type: none"> • Shows the toolbar
Turning the mouse wheel	Turning the rotary knob	<ul style="list-style-type: none"> • Navigation in panels, parameter lists, etc. • Changes numeric values
Pressing the mouse wheel	Rotary knob click	<ul style="list-style-type: none"> • Selects parameters • Quits the Edit mode

4.3.4 Operation Using an External Computer Keyboard

A commercially available, external computer keyboard (not part of the scope of deliveries and services) can be connected to one of the four USB interfaces at the front or rear of the instrument (see [chapter 2.7.1, "Connecting an External Keyboard."](#), on page 51).

It simplifies the input of list entries, comment texts, file names, etc. A keyboard is required for operating Windows®.

The keys on the front panel of the audio analyzer correspond to the following keys and shortcuts on the external PC keyboard:

Front panel	Computer key-board		Front panel	Computer keyboard
Softkeys F5 to F12	F5 to F12		0 to 9; a to z	0 to 9; a to z
START	CTRL + F5			SPACE
SINGLE	CTRL + F6		• ; * ... #	• ; * ... #
STOP CONT	CTRL + F7		+ / -	+ / -
Loudspeaker ON	CTRL + F8		A <-> a	SHIFT + A to Z
Volume	CTRL + F9		MENU	CTRL + M
H COPY	CTRL + P		UNDO	BACKSPACE
SHUTDOWN	CTRL + F10		ESC	ESC
LOCAL	CTRL + F11		Enter, rotary-knob click	ENTER
OUTPUT OFF	CTRL + F12		Cursor keys	Cursor keys
SCREEN <	CTRL + PAGE UP		WINBAR	ALT + W
SCREEN >	CTRL + PAGE DOWN		MODIFY	ALT + M
WINDOW <	CTRL + SHIFT + TAB		HIDE	ALT + H
WINDOW >	CTRL + TAB		CLOSE	ALT + C
SCAN <	ALT + PAGE UP		HELP	F1
SCAN >	ALT + PAGE DOWN		SAVE	ALT + S
PAGE ▾	PAGE DOWN		LOAD	ALT + L
PAGE △	PAGE UP		PRESET	ALT + P
Rotary knob right	TAB			
Rotary knob left	SHIFT+TAB			

4.4 The Display

The display is the central element for operating the audio analyzer. Both the instrument settings in the various panels and the measurement results are displayed here.

To make the various functions of the audio analyzer easier to operate, they were organized in a series of panels.

The measurement results can be displayed as digital numeric values, in data lists, in analog bar graphs, or in result graphics. The user can freely choose the number of panels and the number of graphical windows to be shown in the display. The size of the panels can be changed within wide limits, whereby the font size, scaling and so on are adapted automatically according to the type of display window.

4.4.1 The Screens

Five display windows (or "screens") are provided so that the wealth of information can be better organized.

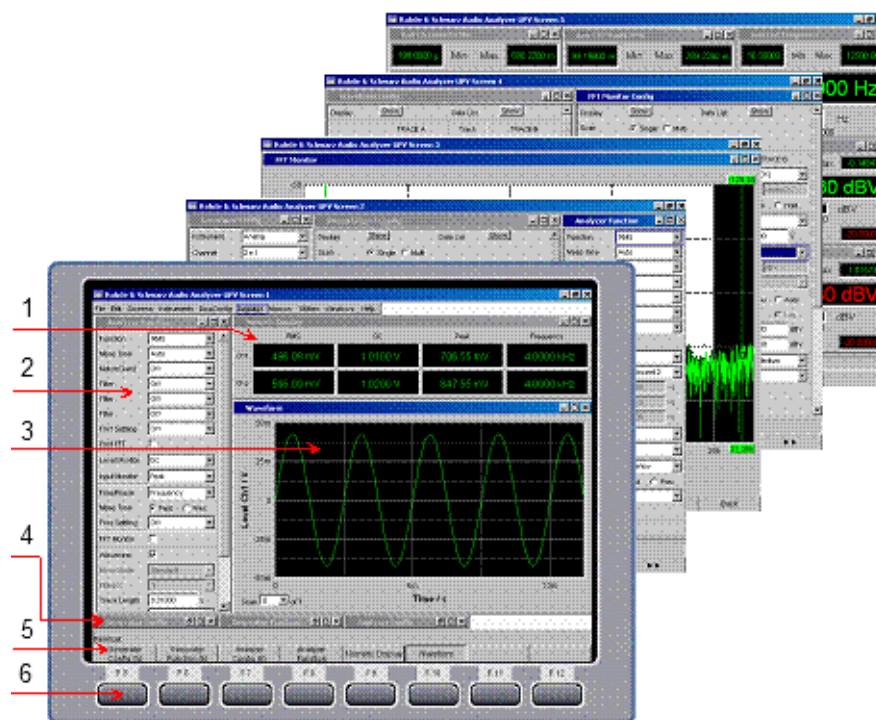


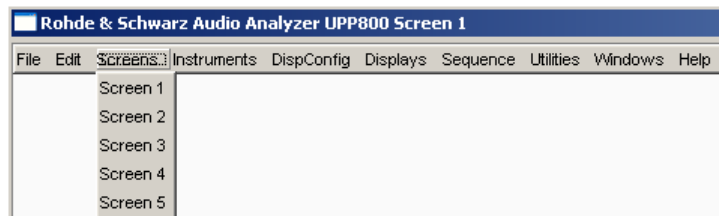
Fig. 4-1: R&S UPV display with its 5 screens

- 1 = Numeric display
- 2 = Panel
- 3 = Graphical window
- 4 = Hidden panels
- 5 = Softkey bar
- 6 = Softkeys

The user can toggle between the individual screens in the following way:

- **On the front panel** using the direction keys

- **Using the PC keyboard** using the shortcuts CTRL + PAGE UP or CTRL + PAGE DOWN
- First open the menu bar at the top of the display **with the mouse**, then click on the Screen button and finally select the desired screen.



- Alternatively, you can also select the desired screen directly by **clicking the appropriate number in the toolbar**.



4.4.2 WINBAR and Softkeys

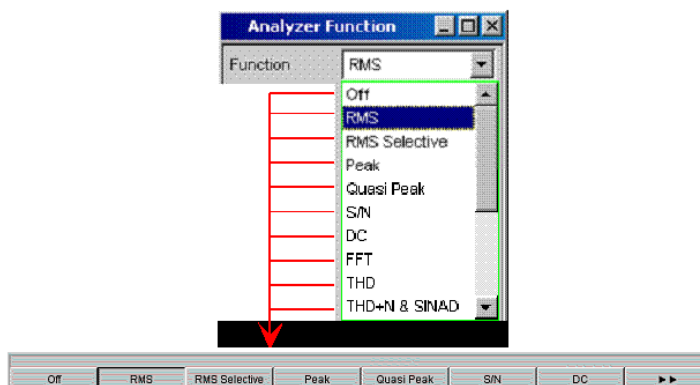
One of the two bars (either the softkey bar or the WINBAR) is always displayed at the bottom of the screen.

The softkey bar which has a varying range of functions is visible in normal operating mode.

In most cases, the functions available in the selection windows of the panels are displayed in the eight buttons; these functions are displayed even if the parameter lists have not (yet) been opened. The labeling of these buttons indicates the functions of the softkeys underneath them.

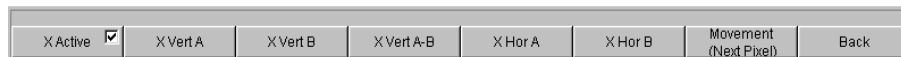
The function that has just been selected is indicated by a "pressed" button, as shown in the example below for the "RMS" function.

If there are more than eight elements to choose from, the hidden elements in the selection list can be displayed by pressing the last softkey containing the >> symbol or the first softkey containing the << symbol.



Pressing the respective softkey permits rapid selection.

Softkeys with an additional checkbox are also used for a number of applications. In the example below, the left-hand softkey F5 can be used to activate and deactivate the X cursor in a curve diagram. The other softkeys are used to make other settings affecting this cursor. The advantage of this combination is that the user can activate/deactivate a function (here the cursor) using one button and at the same time use the other softkeys for additional settings.



Another variant is the combination of several softkeys with checkbox and softkeys without checkbox. The example below shows the softkeys for the MODIFY function, described in detail in the section [chapter 4.4.3, "Moving and Resizing Panels and Graphical Windows"](#), on page 150. When a softkey with a checkbox is selected, the softkey bar remains open so that further settings (e.g. moving a panel) can be carried out. Activating the other softkeys immediately triggers an action (here, for example, fixing the size of the panel), whereupon the softkey bar is hidden.



If an external computer keyboard is used, the softkeys can be operated using the F5 to F12 keys; if a mouse is used, the buttons in the softkey bar can be clicked directly.

When the WINBAR key is pressed, the WINBAR appears in place of the softkey bar; this is indicated by "Panel List" in the left-hand corner:



The labeled buttons show the names of all panels and graphical windows open in the current screen. Pressing the associated softkey puts the focus on the corresponding panel / graphical window, i.e. it becomes active. At the same time, the system returns to normal operating mode (i.e. the softkey bar).

Hidden panels (see [chapter 4.5.1, "Opening, Operating, Hiding and Closing Panels"](#), on page 154) are also listed in the WINBAR. If a hidden panel is selected, it is redisplayed on the screen with its previously set size and position; it simultaneously receives the focus.

The panels and graphical windows displayed in the WINBAR can also be selected by pressing the F5 to F12 keys on the computer keyboard or by clicking with the mouse.

The panel with the focus can be recognized by the highlighted title bar (as shown here in the example on the right-hand side):



It is possible to toggle between the softkey bar and WINBAR at any time by pressing the WINBAR key.

Function	Front panel	PC keyboard	Mouse
Select softkey function	Press softkey.	Press keys F5 to F12.	Click button of associated softkey.

4.4.3 Moving and Resizing Panels and Graphical Windows

As soon as a panel or display window has the focus, it becomes active and can be moved around the screen or resized. This can be done in the following ways:

- The mouse can be used to move or resize the selected panel directly in the same way as other Windows® applications.
- In the case of operation without a mouse, the MODIFY key (shortcut ALT + M on an external PC keyboard) must be pressed, whereupon the following labels appear on the softkey bar:

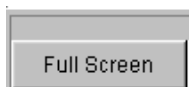


The associated panel can now be resized or moved; this is indicated by the label in the title bar:



Pressing the MODIFY key again restores the original operating mode.

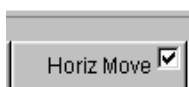
Apart from resizing and moving, the MODIFY mode also offers a number of other functions described in the following list:



This button is particularly useful for graphical windows. When the "Full Screen" button is activated, the selected panel is enlarged so that it covers the entire screen.

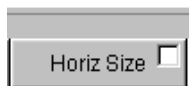
If this command is used for panels, they are enlarged to their full length and width. Panels whose length exceeds the screen height are reduced to full screen height.

Activating this softkey exits the MODIFY mode and the selected panel becomes active again.



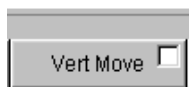
When the "Horiz Move" button is selected, the rotary knob can be used to move the panel/window horizontally without changing the size.

When all modifications to the panel have been made, pressing the MODIFY key restores the original operating mode.



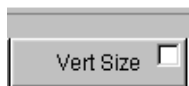
When the "Horiz Size" button is selected, the rotary knob can be used to resize the panel/window (the right-hand edge of the selected panel is moved).

When all modifications to the panel have been made, pressing the MODIFY key restores the original operating mode.



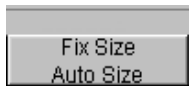
When the "Vert Move" button is selected, the rotary knob can be used to move the panel/window vertically without changing the size.

When all modifications to the panel have been made, pressing the MODIFY key restores the original operating mode.



When the "Vert Size" button is selected, the rotary knob can be used to resize the panel/window (the bottom edge of the selected panel is moved).

When all modifications to the panel have been made, pressing the MODIFY key restores the original operating mode.



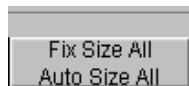
Activating the "Fix Size Auto Size" button switches to "Auto Size" mode and adjusts the size of the selected panel/window to display all parameter fields or to use the full height of the screen. This state is indicated by an asterisk in the title bar.

***Generator Function**

The default setting is "Fix Size". With this setting, the panel is not enlarged if, for example, additional fields appear in the panel when certain functions are selected; only the scroll bar indicates the presence of additional fields.

Activating the button again toggles between the two modes.

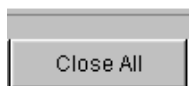
Activating this softkey exits the MODIFY mode and the selected panel becomes active again.



Activating the "Fix Size All Auto Size All" button switches all panels/windows to "Auto Size" mode and adjusts the size of the panels/windows to display all parameter fields or to use the full height of the screen. This state is indicated by an asterisk in the title bars.


Activating the button again toggles between the two modes.

Activating this softkey exits the MODIFY mode and the selected panel becomes active again.



When the "Close All" button is selected, all of the panels and measurement windows displayed on the screen are closed. The function corresponds to the CLOSE key, except that it affects all panels and measurement windows displayed on the screen.

Activating this softkey exits the MODIFY mode and the selected panel becomes active again.

Function	Front panel	PC keyboard	Mouse
Enlarge graphical window to full screen size	Press the MODIFY key and activate the F5 softkey.	Press the shortcut ALT + M and then the F5 key.	Click on the  button in the title bar of the corresponding graphical window.
Panel/graphical window moving	Press the MODIFY key, select the direction of movement using the softkey and move the panel using the rotary knob.	Press shortcut ALT + M, select direction of movement using keys F6 or F8 and move panel using keys TAB and SHIFT + TAB.	Click title bar of panel and drag to resize.
Panel/graphical window in its horizontal or vertical size	Press MODIFY key, select the resizing direction using the softkey and resize the panel using the rotary knob.	Press shortcut ALT + M, select the resizing direction using keys F7 or F9 and resize the panel using the keys TAB and SHIFT + TAB.	Drag top/bottom or side edge of panel.

Function	Front panel	PC keyboard	Mouse
Panel/graphical window proportionally in its size (horizontal and vertical)	Press MODIFY key, change to the second level using the >> button, activate F6 softkey and resize the panel using the rotary knob.	Press the shortcut ALT + M, press the F12 key and then F6 key, and resize the panel using the keys TAB and SHIFT + TAB.	Drag one corner of panel.
Panel/graphical window to the required size	Press the MODIFY key and activate the Fix Size Auto Size or Fix Size All Auto Size All button.	Press the shortcut ALT + M, then press the F10 or F11 key.	---
Close all panels/panel on screen	Press the MODIFY key, change to the second level using the >> button and activate the F10 softkey.	Press the shortcut ALT + M, the F12 key and then F10 key.	---

4.4.4 Status Displays and Messages

In some cases, the user is presented with additional information on the screen. This information includes status messages, messages concerning the value ranges, information on settings, warnings and error messages.

4.4.4.1 Status Displays

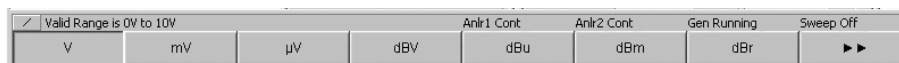
The status of the R&S UPV is continuously displayed for the generator, analyzer, sweep system and other instrument states at the bottom of the screen above the four right-hand softkeys. Status displays always appear at the same position; they are assigned to the fields above the softkeys as shown below.



A list of all possible status messages is available, see [chapter 4.20, "Overview of Status Messages"](#), on page 235.

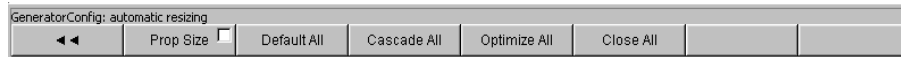
4.4.4.2 Valid Value Range

Information on the possible entries is given at the bottom of the screen above the softkey bar. The ranges for value entries specified here always take the current status of the instrument into consideration and therefore depend on the presets already configured. Below is an example for entry of the generator output voltage:



4.4.4.3 Notes

Information concerning the panel settings and so on is also given at the bottom of the screen above the softkey bar (only the space above the four left-hand softkeys is used).



4.4.4.4 Warnings

If the user attempts to make measurement settings which conflict with the usual test specifications, warnings appear on the screen; these remain there until they are acknowledged with ENTER or a mouse click on OK.

Warnings are issued if no measurement results are produced during measuring mode. This is normally the result of unsuitable input signals or settings. For example, input signals may be too low to produce a stable measurement result. In this case, a warning is displayed in the middle of the screen instead of the measurement result. The warning indicates why no measurement result can be displayed and may also list several reasons for this.

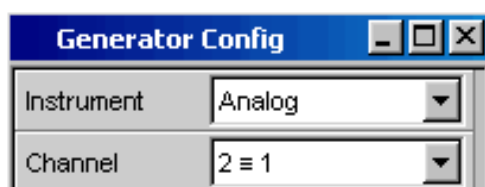
4.4.4.5 Error Messages

If faults in the instrument occur during operation, an error message appears in the middle of the screen. This message remains on screen until it is acknowledged with ENTER.

4.5 Panels

In the case of the audio analyzer, associated settings and functions are always combined in "panels". Each of these panels has a name (headline in the title bar) by which it is called up.

Only one panel can have the focus, i.e. only one panel can be active at any one time. The panel with the focus can be identified by its blue title bar.



The audio analyzer distinguishes between the following panels and display windows:

- **Control panels** used to make function settings
- **Configuration panels** used for configuring how the measured values are to be displayed

- **Numeric display fields** for displaying the measured values of the various measurement functions
- **Combo displays** in which the numeric display of measured values can be supplemented by bar graphs, min/max values and limit monitoring
- **Graphical windows** in which measured values are displayed in the form of diagrams
- **Measured value lists**, in which the measured values are listed in tabular form; this also includes the "Dig Analyzer Protocol", in which the values of the protocol data of a digital audio data stream are displayed (R&S UPV-K21 option (digital audio protocol)).

A detailed list of all panels together with the most important setting parameters can be found at the end of this chapter (see [chapter 4.19, "Overview of Panels and Measurement Displays \(Graphical Windows\)"](#), on page 232).

4.5.1 Opening, Operating, Hiding and Closing Panels

Each panel and display window is a separate panel which can be either closed, opened or hidden. All displayed panels/display windows on the currently visible screen are designated as open. If the panel size is minimized and moved to the bottom edge of the screen, it is referred to as hidden. In both cases, the panel/window is assigned an entry in the WINBAR at the bottom of the display.

The same panel or display window can be displayed (i.e. opened) in several screens. The display characteristics (position, size) can be different for each of the screens; the content is, however, always the same.

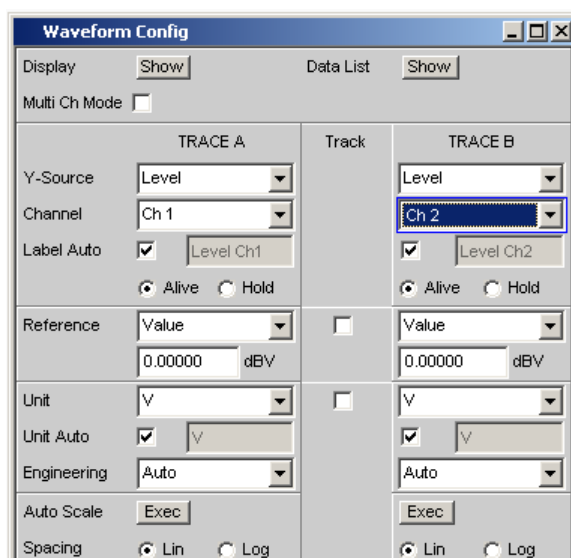
- **Open panel**
Panels/display windows are open if they are visible on the currently displayed screen.
A panel is opened on the currently displayed screen by activating the menu bar using the MENU key, highlighting the "Instruments" button, the "Disp Config" button or the "Displays" button with the rotary knob or cursor key, opening the pulldown menu with the ENTER key or a rotary knob click and highlighting and selecting a panel.
- **Activate panel**
Only one panel can be active on the screen at any one time.
Every open or hidden panel can be activated using the softkeys on the WINBAR or using the Windows key (active panels are identified by their blue title bar).
- **Hide panel**
Open panels/display windows can be minimized and placed at the bottom of the screen. They are then referred to as hidden in the menu bar.
A panel must be activated before it can be hidden. It is then hidden by pressing the HIDE key.
- **Close panel**
Opened panels/display windows can be closed. They are then referred to as closed in the menu bar.
A panel must be activated before it can be closed. It is then closed by pressing the CLOSE key and no longer appears on the WINBAR.

The table below shows the alternative operating modes for mouse and external keyboard:

Function	Front panel	PC keyboard	Mouse
Open panel	Press the MENU key and highlight the "Instruments", "Disp Config" or "Displays" button using rotary knob or cursor keys, open the pulldown menu using the ENTER key or rotary-knob click, and highlight and select a panel.	Press the shortcut CTRL + M, then highlight Instruments, Disp Config or Displays button using TAB or SHIFT + TAB keys, open the pulldown menu using the Enter key, highlight a panel using the cursor keys and select using the Enter key.	Open the menu bar by moving to left edge of screen, press the "Instruments", "Disp Config" or "Displays" button and click the desired panel.
Activate panel	Press the WINBAR key and activate the softkey of the desired panel.	Press the shortcut ALT +W, then activate the softkey of the desired panel using the appropriate key F5 to F12.	Click anywhere in the desired panel.
Hide panel	Pressing HIDE key hides the currently active panel.	Pressing the shortcut ALT + H hides the currently active panel.	Click on the button in title bar of the respective panel.
Close panel	Pressing the CLOSE key closes the currently active panel.	Pressing the shortcut ALT+C closes the currently active panel.	Click the button in title bar of respective graphical window.

4.5.2 Panel Structure

This section describes the panel structure. To operate the panels on the screen, see [chapter 4.5.1, "Opening, Operating, Hiding and Closing Panels"](#), on page 154, to set the parameters, see [chapter 4.7.8, "Selecting a Parameter – Selection Fields"](#), on page 164. The panels have the look and feel of the Windows® interface. They differ in detail depending on their function but they consist of the same main elements.





Panels consist of up to three columns, depending on the function block on which the panel is based. For example, two-channel functions are operated in panels with two columns. When defining graphical windows, settings from Trace 1 can be applied to Trace 2 in a third column between the two original columns so that trace 2 does not have to be configured separately.

Each panel contains a selection of different parameter fields which are combined in groups. Various types of parameter fields, which are operated in different ways, are used. The parameter fields have labels indicating their function.

Panels consist of the following elements:

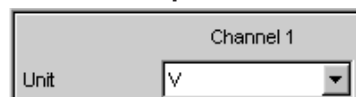
- **Title bar**



The top field contains the name of the panel (here: "Analyzer Function") and the title bar buttons for hiding  and closing  the menu. The buttons can be operated with the mouse. For operation using the front panel, the HIDE and CLOSE keys can be used.

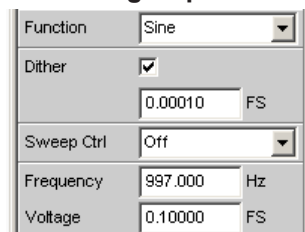
The  button maximizes graphical windows so that they cover the entire screen (see [chapter 4.4.2, "WINBAR and Softkeys"](#), on page 148).

- **Headlines in panels**



With multi-column panels, each column has a headline.

- **Function groups**



In panels, parameter fields which belong together with respect to their function are frequently combined in function groups. Gray lines indicate these groups.

- **Numeric entry field**



A numeric value (e.g. the frequency) can be entered in this field.

- **Units**

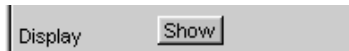
The unit of a numeric value is displayed next to the entry field (see above). When the value is entered, all possible units are offered on the softkey bar (on more than one level where necessary). The entry can be completed by selecting the unit using a softkey. The unit can be changed after the entry has been made. In this case, the physical value remains unchanged; however, the value displayed in the entry field is adapted automatically to the changed unit.

- **Text entry field**



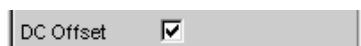
An alphanumeric value (e.g. label text) can be entered in this field.

- **Button**



Buttons are used to trigger actions; here, for example, to display a measurement graph.

- **Checkbox**



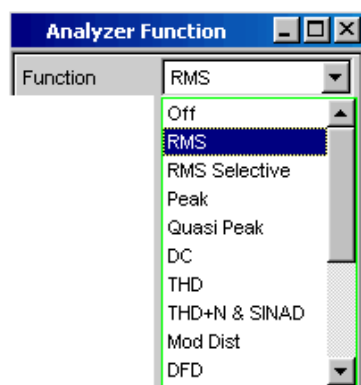
If a checkbox is activated, the assigned setting is selected or enabled.


- **Radio button**



Radio buttons are used to toggle between two settings with just a single click. Only one of the two options can be active at any one time.

- **Selection field**



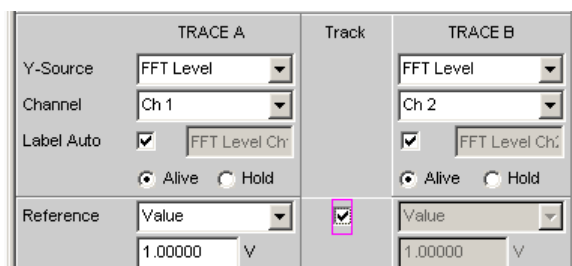
The  button indicates that a parameter list is available. The pulldown parameter list is displayed below the selection field. Depending on the number of items, the full list or only part of it is shown. Only one item at a time can be selected from the parameter list.

- **Display Fields**



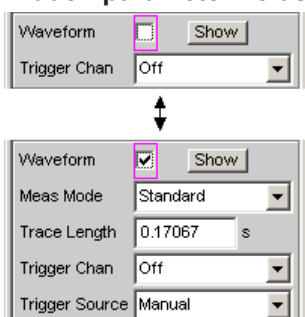
Some settings can only be made in a specific configuration. If the setting is not permitted with the specific configuration selected, the respective item is disabled and displayed in gray and the field cannot be accessed. In this case, the field acts as a display field, i.e. the value displayed there corresponds to the value actually set.

- **Track box**



With multi-column panels, settings can be transferred from the left-hand to the right-hand column without the parameter having to be entered a second time. If the track box is activated, all of the settings within the function group apply to both columns. All fields with transferred settings are shown as display fields and cannot be accessed while the track function is active.

• **Hidden parameter fields**





In general, an effort has been made to keep the panels as short as possible. For this reason, unneeded fields are hidden. The above example shows this: The fields "Meas Mode", "Trace Length" and "Trigger Source" appear only if the Waveform function is activated.

4.5.3 Navigating in the Panels

If a panel has more fields than can be displayed on the screen or if the size of the panel has been fixed such that its full length cannot be displayed, a scrollbar appears along the right-hand side of the panel. The length of the scrollbar symbolizes the overall length of the panel; the dark part of the scrollbar indicates which section of the panel is currently visible.

There are various ways of navigating inside panels, i.e. moving the entry focus:

- With operation via the front panel, the easiest navigation method is using the rotary knob. Turning the rotary knob clockwise moves the focus down or to the right. Here the cursor first moves to the right inside a field, then down through the current group, then jumps over to the right-hand column, down again to the end of the group from where the cursor then moves to the left-hand column of the following group, and so on.
- Alternatively, the cursor keys  and  can also be used for navigation; the movement sequence is the same as that described for operation using the rotary knob.
- The cursor keys on an external computer keyboard can be used to move around within a panel. Once again, the movement sequence is the same as that described

for navigation using the rotary knob. The TAB and SHIFT + TAB keys on the external keyboard can also be used as an alternative to the cursor keys.

- The mouse can also be used to move inside the panels in the same way as other Windows® applications, i.e. by directly clicking the desired parameter fields or by moving the scrollbar.

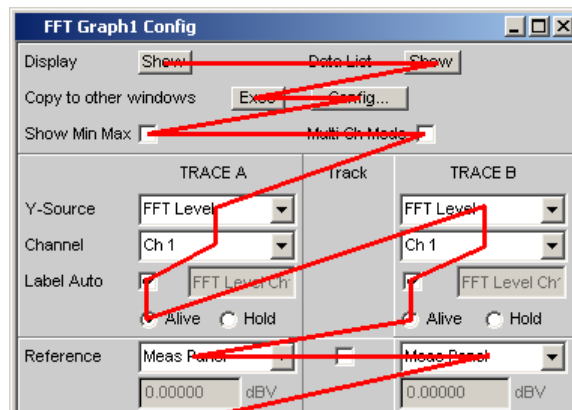


Fig. 4-2: Navigation in the panel with the rotary knob

4.6 Settings on the Audio Analyzer

The R&S UPV offers several and sometimes alternative options for setting parameters. Operation is possible from the front panel, with the aid of a mouse and/or from a PC keyboard (see [chapter 4.3, "General Information on Operation"](#), on page 144). The tables below list the operating options with the available entry media.

Some keys on the front panel of the R&S UPV directly initiate a setting, e.g. the OUTPUT OFF key switches the outputs off or on again. An overview showing the function of all keys can be found at the end of this chapter (see [chapter 4.18, "Overview of Keys"](#), on page 229).

Most of the parameters are set in the panels. The panels are operated on the screen as described in the section Opening, Operating, Hiding and Closing Panels. How to enter and select setting parameters in the panels is described in the following sections; a detailed description of all setting parameters is described in detail in [chapter 5, "Instrument Functions"](#), on page 237.

Entries for file management tasks, such as saving and loading instrument settings, saving files, and so on, are made in special panels, see [chapter 4.15, "File Management"](#), on page 217.

A number of settings are made via the menu bar. This includes all settings that configure the R&S UPV as a complete instrument, e.g. the setting of the IEC bus address, function of the HCopy key, etc. For more detailed information, see [chapter 4.9, "Settings in the Menu Bar"](#), on page 203 and [chapter 5, "Instrument Functions"](#), on page 237.

The R&S UPV is equipped with the Windows XP operating system. Settings at system level are only rarely required, e.g. installation of a new printer driver. Connecting a keyboard and mouse makes Windows easier to use.


4.7 Settings in the Panels

In the panels of the R&S UPV audio analyzer, associated settings and functions are combined. Each function block has its own panel.

The panels can be set independently of each other; however, there are also a number of interdependencies. For example, the digital measurement function of the protocol analysis only appears in the "Analyzer Function" panel if a digital analyzer has been selected in the "Analyzer Config" panel. If an analog analyzer is selected, the protocol analysis is automatically deactivated in the "Analyzer Function" panel and a message is displayed on the screen.

4.7.1 Focus

Panels can only be operated if they have the focus (indicated by the blue title bar).

The simplest way of changing from one panel to another in the case of operation via the front panel is using the direction keys . The > key switches from panel to panel in the sequence in which the panels were opened. Hidden panels are not highlighted. Changing to a different open (or to a hidden) panel is also possible using the WINBAR as explained in the WINBAR and Softkeys section.

Before settings can be made in a panel, the relevant parameter field must be highlighted, i.e. it must have the focus. This is indicated by a selection frame which is blue, green or magenta depending on the entry mode.

The colors of the selection frame have the following meaning:

- A blue selection frame indicates a highlighted field.



- A green selection frame highlights fields in which parameters can be selected or in which an entry can be made without the selection / entry having an immediate effect on the hardware of the R&S UPV.



- A magenta selection frame indicates that selecting a button, activating a checkbox or changing a numeric value will be immediately passed on to the hardware and executed.



When the instrument is switched on, the most recently saved instrument settings are loaded automatically so that the instrument is in the same state as it was before power-off. The focus is placed on the first position of the active panel.

Panels are opened using the menu bar (see [chapter 4.5.1, "Opening, Operating, Hiding and Closing Panels"](#), on page 154). How to move the focus has already been described earlier, see [chapter 4.5.3, "Navigating in the Panels"](#), on page 158.

4.7.2 Changing the Instrument

Depending on the installed options, the audio analyzer can be used at analog and digital interfaces. Optional plug-ins can be installed to allow additional interfaces to be operated. Each of these interfaces determines the basic characteristics of the instrument, whereby these characteristics are separate for generator and analyzer. These interface characteristics define quasi-independent instruments within the R&S UPV. The settings for these instruments are made in the selection field in the first field of the "Generator Config" and "Analyzer Config" panel.



Each of these instruments has its own data set. If a different instrument is selected, this data set is saved. As a result, the previous settings are available when the original instrument is selected again.

The data set is structured differently for each instrument. The data sets differ with regard to the following points:

- **Selection of parameter fields / parameters:**
Example: In the case of analog instruments, all settings for configuring the analog interfaces are available (e.g. coupling); all settings for the other instruments, e.g. the digital sampling rate and so on, do not appear in the panel but remain in the background.
- **Valid value range of parameters**
The frequency ranges in the different instruments may be different.
- **Units used**
Levels are output in different units in analog and digital applications.
- **Selection of functions**
A number of measurement functions are only available for digital audio applications; they are therefore not offered in analog instruments; examples: Digital protocol analysis, jitter, etc.

The examples given above show that the choice of instrument not only affects the "Generator Config" and "Analyzer Config" panel, but also has an effect on the other panels.

4.7.3 Changing Functions

The principles that apply to changing an instrument also apply to changing functions (e.g. from an RMS measurement to a THD measurement or from generating a sine-wave to multi-tone signal):

Each measurement function and generator function has its own data set. If a different function is selected, this data set is saved. As a result, the previous settings are available again when a different function is selected.

The data set is structured differently for each function. The data sets differ with regard to the following points:

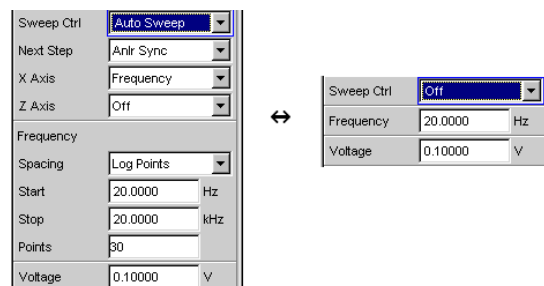
- **Selection of parameter fields / parameters:**
Example: With the RMS measurement, various measurement times are offered; which is not the case for the FFT analysis.
- **Valid value range of parameters**
Example: Other frequencies can be set for intermodulation test signals than for sine-wave signals.
- **Units used**
Example: THD measurements and level measurements are specified in different units.

The following generally applies: All the settings for the other functions, e.g. filter settings and so on, remain in the background with the function settings and are displayed in the panel and set in the instrument again the next time this function is called up.

4.7.4 Hiding Parameter Fields

The R&S UPV always attempts to keep the panels as short as possible. For this reason, unneeded fields are hidden.

The following example demonstrates this more clearly: As soon as "Auto Sweep" is selected in the "Sweep Ctrl" menu item in the "Generator Function" panel, all of the fields required for configuring the sweep are displayed in the panel (together with the parameters set for the sweep last performed). If the sweep is deactivated, all of the sweep parameter fields are hidden. The user is presented with a shorter panel and is not burdened with parameter fields which are currently not needed.



The sequence of the individual parameter fields in the panel is such that changes to parameters usually only cause changes in the fields below. Therefore, we recommend beginning at the top of the panel and working down.

4.7.5 Highlighting Controls

A control element is always selected in the same way, regardless of whether it is a checkbox, radio button, entry field and so on.

A control element is activated by shifting the focus to this element. The entry focus is indicated by a blue, green or magenta border.

The entry focus can be moved with rotary knob, cursor keys or mouse.



4.7.6 Activating/Deactivating Functions – Checkboxes

A checkbox is always used for functions which can be activated and deactivated only. If the checkbox is activated, the assigned setting is selected or enabled.

Before a function can be activated or deactivated, the associated element must be highlighted first (see the section Highlighting controls). The highlighted element is then activated or deactivated (toggle function) using the ENTER functions of the various entry media (ENTER key, rotary-knob click and so on).



Function	Front panel	Computer keyboard	Mouse
Activate/deactivate	Highlight the desired element with the rotary knob or cursor keys, Switch the function with the rotary knob click or ENTER key.	Highlight the desired element with the cursor keys, Switch the function with the Enter key.	Click checkbox.

4.7.7 Toggling Functions – Radio Buttons

Radio buttons are used for functions which can be toggled between two settings. A black dot in the appropriate button indicates the selected status.




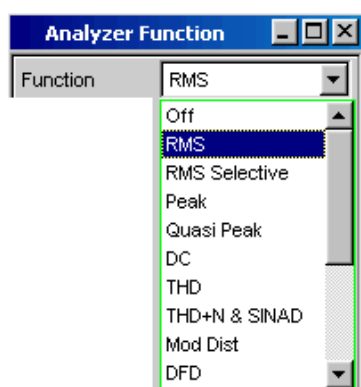
Only one of the two options can be active at any one time.

To toggle a function, the corresponding element must be highlighted first. The ENTER functions of the various entry media can then be used to switch between the two settings (toggle function).

Function	Front panel	Computer keyboard	Mouse
Toggle	Highlight the desired element with the rotary knob or cursor keys, Switch the function with the rotary knob click or ENTER key.	Highlight the desired element with the cursor keys, Toggle the function with the Enter key.	Click the desired radio button.

4.7.8 Selecting a Parameter – Selection Fields

Activating the adjacent  button displays a selection field. As soon as a parameter field has the focus, a list for selecting the available parameters can be opened with a rotary-knob click, the ENTER key or by clicking with the mouse. The drop-down parameter list is displayed below the selection field.



Items in the parameter list are highlighted using the rotary knob, the cursor keys or the TAB and Shift+TAB keys. ENTER accepts the selection. When using a mouse, items can be selected and activated by clicking on them. Only one entry can be selected at any given time.

The parameter list can be exited without adopting the highlighted parameter by pressing the ESC key.

If the list is longer than the displayed window, a scrollbar is available.



Note 1:

The contents of the parameter lists are not fixed but vary depending on other settings selected.

Note 2:

Alternatively, parameters can also be selected using the softkeys.

Function	Front panel	Computer keyboard	Mouse
Open parameter list	Rotary-knob click or press the ENTER key.	Press the Enter key.	Click button.
Scroll	Move the displayed section of the list using the rotary knob or up/down cursor keys.	Move the displayed section of the list using the up/down cursor keys.	Activate the UP or DOWN button in the scrollbar until the desired entry is displayed.
Select parameter	Highlight the selection using the rotary knob or up/down cursor keys and confirm with a rotary-knob click or the ENTER key.	Highlight the selection using the up/down cursor keys and press the Enter key.	Click parameter.
Exit the parameter list without adopting a setting	Press ESC key.	Press the ESC key.	Click anywhere outside parameter list.

4.7.9 Numeric Entries – Numeric Entry Fields

Numeric values (e.g. the output voltage) can be entered or edited in these fields.

This can be done in various ways. However, the following applies irrespective of the chosen method:

Entries outside the possible value range are not accepted; an audible warning is issued and the entry is changed to its permissible minimum or maximum value. The possible value range is displayed above the softkey bar.

4.7.9.1 Value Inputs in Edit mode – Green Selection Frame

When the focus is moved to a numeric entry field, the system enters Edit mode, which is indicated by a green selection frame. In addition, the current numeric value is highlighted with a blue background.



If a completely new value is to be entered, simply begin entering digits using the numeric keypad on the front panel or external computer keyboard; the old value is deleted automatically when the first key is pressed. The digit to the left of the cursor can be deleted at any time during entry using the UNDO key.

If only certain digits are to be changed, position the cursor accordingly using the cursor keys or digit cursor and enter the new digits (if the position of the digit cursor is changed before the first digit is entered, the old value will not be deleted). The default setting is insert mode. It is only possible to change between insert and overwrite mode if an external computer keyboard is used.

The numeric entry field is closed with:

- **ENTER**
The newly entered value is adopted.

- **ESC**
The old value is retained.
- **Softkeys**
The selected unit is set and adopted together with the newly entered value.
- **"m" or "k" on the external keyboard**
The number entry can also be completed with the entry of the unit. Simply entering values such as "m" to the set voltage value to mV or "k" to set a frequency value to kHz is sufficient here.

The entry is set in the hardware as soon as the numeric entry field is closed.



Only the number keys and cursor keys are accepted; letters and special characters have no effect when numeric values are being entered.

4.7.9.2 Value Inputs in Direct mode – Magenta Selection Frame

When the focus is moved to a numeric entry field, the system enters Edit mode, which is indicated by a green selection frame.

Using ENTER functions - pressing the ENTER key or using a rotary-knob click - switches to Direct mode and the selection frame changes to magenta.

Voltage	125.000	mV
---------	---------	----

The digit cursor then moves to the first digit to the right of the decimal point or, if there is no decimal point, to the digit at the extreme right.

A digit can now be entered using the keyboard; the digit at the cursor position is replaced. The cursor does not change its position.

The digit cursor can be placed at a different position at any time using the cursor keys or rotary knob. Digits are then entered at the new position.

Entries in Direct mode always use the overwrite mode.

In Direct mode, every setting change is immediately passed on to the hardware and executed. For this reason, this method is particularly suited for adjustment work.

Direct mode can be exited using the ENTER function, the ESC key, a rotary knob click or by clicking in a different field with the mouse.



Only rotary-knob entries, number keys and cursor keys are accepted; letters and special characters have no effect.

Changes made to values are not accepted if the entries are outside the possible value range; an audible warning is issued and the entry is changed to its permissible minimum or maximum value. The possible value range is displayed above the softkey bar.

4.7.9.3 Entering/Changing the Unit of a Value

The unit of a numeric value is displayed next to the entry field. When the value is entered, all units available for the respective function are offered on the softkey bar (on more than one level where necessary). The entry can be completed by selecting the unit using a softkey.

This is done differently depending on the selected mode:

- **In Edit mode**, the newly entered numeric value is adopted and set together with the selected unit.
- **In Direct mode**, the physical value (number with the previously selected unit) is converted to the newly selected unit and adopted as the new numeric value.

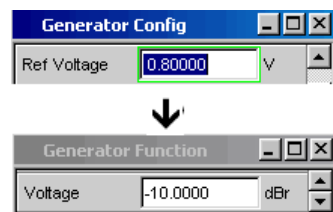
After finishing entering a value or even if no value has been changed, the softkeys can be used to change the unit in any highlighted numeric field. In this case, the physical value remains unchanged (as in the Direct mode); however, the value displayed in the entry field is adapted automatically to the changed unit. This function allows numeric values to be "converted" to other units very easily.

4.7.9.4 Information on Using Reference Values when Entering Values

The audio analyzer allows reference values in various places. These reference values are used as a basis for settings for other parameters.

The example below explains these interdependencies:

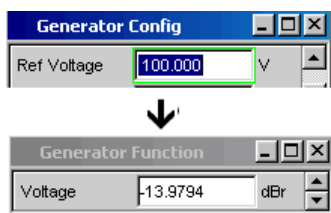
A reference voltage ("Ref Voltage") can be set in the "Generator Config" panel. The actual output voltage is set in the "Generator Function" panel where the unit is dBr, i.e. it is possible to enter the output voltage in dB relative to this reference value.



This method is particularly useful if, e.g. with an A/D converter, the clipping level has been determined and other measurements (frequency response, THD+N, etc.) have to be performed using test signals which are a certain dB value (defined in the test specifications) below this full-scale level.

It should be noted, however, that the maximum values of the R&S UPV cannot be exceeded, both for system reasons and due to the "Max Voltage" setting.

If the maximum output voltage is exceeded by increasing the reference value, the reference-based value in the "Voltage" field of the "Generator Function" panel is automatically reduced. In the following example, the maximum output voltage of 20 V forms the limit. The setting of the reference value to 100 V leads to a reduction of the value in the lower window.



Function	Front panel	Computer keyboard	Mouse
Entering a new value: (Edit mode)	Highlight the numeric entry field and enter the new value directly using the numeric keypad.	Highlight the numeric entry field and enter the new value directly using the number keys.	---
Change individual numbers (Edit mode)	Highlight the numeric entry field, position the digit cursor with the > or < cursor key and enter the new digit directly using the numeric keypad.	Highlight the numeric entry field, position the digit cursor with the > or < cursor key and enter the new digit directly using the numeric keys.	---
Finishing value entry	Complete entry with the ENTER key.	Complete entry with the ENTER key.	---
Finishing value entry with unit selection	Press the softkey with the desired unit.	Use the F5 to F12 keys to select the desired unit or Complete the entry with the m, k, etc. keys to enter the value, e.g. as mV or kHz.	Click the softkey button with the desired unit.
Exit value entry without adopting the value	Press the ESC key.	Press the ESC key.	Click in a different entry field.
Changing a value (Direct mode)	Highlight the numeric entry field, switch to Direct mode with the ENTER key, position the digit cursor with the > or < cursor keys and enter the new digit directly using the numeric keypad. All changes are set directly in the hardware.	Highlight the numeric entry field, switch to Direct mode with the Enter key, position the digit cursor with the > or < cursor keys and enter the new digit directly using the numeric keys. All changes are set directly in the hardware.	---



Varying a value (Direct mode)	Highlight the numeric entry field, switch to Direct mode with a rotary-knob click; position the digit cursor with the > or < cursor keys. Vary the numeric value using the rotary knob. All changes are set directly in the hardware.	Highlight the numeric entry field, switch to Direct mode with the Enter key; position the digit cursor with the > or < cursor keys. Change the numeric value with the UP/DOWN cursor keys. All changes are set directly in the hardware.	---
Changing units	Highlight the numeric entry field, select the unit using the appropriate softkey. The physical value is converted to new numeric value with the newly selected unit.	Highlight the numeric entry field, select the unit using the F5 to F12 keys. The physical value is converted to the new numeric value with the newly selected unit.	Highlight the numeric entry field, click the appropriate softkey button to select the unit. The physical value is converted to the new numeric value with the newly selected unit.

4.7.10 Alphanumeric Entries – Text Entry Fields

When the focus is moved to a text entry field, the system enters Edit mode, which is indicated by a green selection frame.



If the complete text (e.g. for graph labels) is to be newly entered, simply begin entering characters using the keypad on the front panel; the old text is deleted automatically when the first key is pressed. The keypad on the front panel of the R&S UPV is automatically switched to the mode for entering alphanumeric characters. Text is entered in the same way as on cellphones: Repeatedly pressing a key calls up the characters assigned to the corresponding key in sequence. A different key can be pressed immediately to enter the next character. A brief pause must, however, be made when entering characters assigned to the same key.

The space character is assigned to the  key, special characters are entered using the decimal-point key and the  key is used to toggle between upper and lower-case characters.

The character to the left of the cursor can be deleted at any time during entry using the UNDO key.

If an external computer keyboard is used, characters can be entered in the usual way.

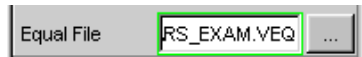
If certain characters only are to be changed, position the cursor accordingly using the cursor keys and enter the new characters (if the position of the cursor is changed before the first character is entered, the old text will not be deleted). The default setting is insert mode. It is only possible to change between insert and overwrite mode if an external computer keyboard is used.

The text entry field is closed with:

- ENTER – The newly entered text is adopted

- ESC – The old text is retained.

Whenever files stored on the R&S UPV are to be called up, e.g. to load saved scans in a diagram, or special functions are to be adopted from files, etc., a text entry field also appears. Here, the file name can be typed or the ... button can be activated to call up the file directory where the desired file can then be selected. For details, see [chapter 4.15, "File Management"](#), on page 217.



Function	Front panel	Computer keyboard	Mouse
Entering new text	Highlight the text entry field and enter the new text directly using the front panel keypad.	Highlight the text entry field and enter the new text directly using the keyboard.	---
Changing individual characters	Highlight the text entry field, position the cursor with the cursor keys and enter the new character directly using the front panel keyboard.	Highlight the text entry field, position the cursor with the cursor keys and enter the new character directly using the keyboard.	---
Finishing character entry	Complete entry with the ENTER key.	Complete entry with the ENTER key.	---
Exiting text entry without adopting the entered characters	Press the ESC key.	Press the ESC key.	Click in a different entry field.

4.7.11 Display Fields

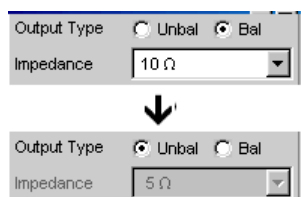
Sometimes it is very useful for operators to receive additional information about their settings. For example, the selected FFT parameter directly affects the frequency resolution in the displayed spectrum. Display fields inside the panels are used in such cases. These fields are shown in gray and cannot be accessed. They always contain valid values and therefore always show settings active in the background; the fields are updated as soon as a setting in the associated parameter field is changed.



Depending on the settings selected beforehand, it may in some cases no longer be possible to operate certain elements – the entry field then becomes a display field and is shown in gray as described above.

Example: If measurement results are displayed in V, linear or logarithmic divisions can optionally be selected for the bar graph. For measurement results in logarithmic units, only a linear subdivided bar graph is meaningful; for this reason, the input field cannot be changed and, by default, is displayed with the "Lin" setting.

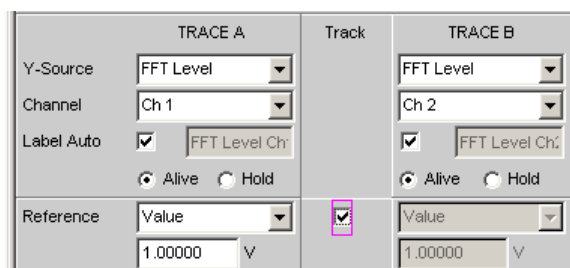
Display fields are also used when adopting parameters using track boxes.



4.7.12 Adopting Parameters – Track Box

In many cases, settings are to apply e.g. to both measurement channels or to both traces. Here the R&S UPV provides multi-column panels which allow settings to be transferred from the left-hand to the right-hand column without the parameter having to be entered a second time.

The track boxes, which are displayed in a separate column, are used for this purpose. Track boxes always apply to an entire function group.



If the track box is activated, all of the settings within the function group apply to both columns. All fields with transferred settings in the right-hand column are shown as display fields. They appear gray and cannot be accessed while the track function is active. If a setting is changed in the associated parameter field in the left-hand column, this change is also shown in the display field in the right-hand column.

4.7.13 Input Help

Information on the possible entries is given at the bottom of the screen above the softkey bar. The units offered in the softkey bar and the limits specified in the "Valid Range" field always refer to the highlighted parameter field. The valid value range is given in the unit currently selected.

Entries outside the specified value range are not accepted; an audible warning is issued and the entry is changed to its permissible minimum or maximum value.



The specified ranges for value entries always take the current status of the instrument into consideration. They are therefore not constant and depend on the presets already configured for other parameters.

Below is an example for entering the generator output voltage: Additional units can be selected with the >> button:



4.7.14 Completing Settings

For the entry of numeric values, the R&S UPV distinguishes between Edit mode (identified by a green selection frame) and Direct mode (identified by a magenta selection frame). See also the section [chapter 4.7.9, "Numeric Entries – Numeric Entry Fields"](#), on page 165.

- Numeric entries in **Edit mode** are not adopted and set in the hardware until the ENTER function is activated (ENTER key or rotary-knob click) or a unit is selected using the softkey bar.
- In **Direct mode**, numeric values entered or changed using the rotary knob are immediately passed on to the hardware and executed.

With checkboxes, functions are activated and deactivated by the hardware as soon as the status of the checkbox is toggled with the ENTER function. For operation using a mouse, functions are activated/deactivated as soon as the checkbox is clicked.

With radio buttons, settings are executed by the hardware as soon as the radio button is toggled with the ENTER function. For operation using a mouse, functions are toggled as soon as the corresponding radio button is clicked.

A parameter from a selection field is also executed by activating the ENTER function. In this case, a simple mouse click will select and activate the desired parameter.

Most settings are made without any noticeable adjustment or calculation times. If a brief calculation time is necessary (e.g. to calculate a multi-tone signal adapted to the FFT analysis), the calculation is performed in the background while ongoing measurements continue.

Function	Front panel	Computer keyboard	Mouse
Finishing numeric value entry (Edit mode)	Complete entry with the ENTER key or press the softkey with the desired unit.	Complete entry with the ENTER key or Use the F5 to F12 keys to select the desired unit or Complete the entry with the keys m, k, etc. to enter the value, e.g. as mV or kHz.	Click the softkey button with the desired unit.
Immediately setting numeric value changes in the hardware (Direct mode)	Highlight the numeric entry field, switch to Direct mode with the ENTER key, position the digit cursor with the > or < cursor keys and enter the new digit directly using the numeric keypad.	Highlight the numeric entry field, switch to Direct mode with the Enter key, position the digit cursor with the > or < cursor keys and enter the new digit directly using the numeric keys.	---

Function	Front panel	Computer keyboard	Mouse
Varying numeric values with immediate adoption by hardware (Direct mode)	Highlight the numeric entry field, switch to Direct mode with a rotary-knob click; position the digit cursor with the > or < cursor keys. Vary the numeric value using the rotary knob.	Highlight the numeric entry field, switch to Direct mode with the Enter key; position the digit cursor with the > or < cursor keys. Change the numeric value with the UP/DOWN cursor keys.	---
Activating/deactivating a function	Highlight the desired element with the rotary knob or cursor keys, Switch the function with the rotary knob click or ENTER key.	Highlight the desired element with the cursor keys, Switch the function with the Enter key.	Click the checkbox.
Toggling a function	Highlight the desired element with the rotary knob or cursor keys, Toggle the function with a rotary knob click or the ENTER key.	Highlight the desired element with the cursor keys, Toggle the function with the Enter key.	Click the desired radio button.
Selecting a parameter from a list	Highlight the selection using the rotary knob or up/down cursor keys and confirm with a rotary-knob click or the ENTER key.	Highlight the selection using the up/down cursor keys and press the Enter key.	Click on the parameter.

4.7.15 Entries during Measurement or Data Output

All entries can be made at any time.

- Single measurements, spectral displays:**
 If the entry affects parameters of the ongoing measurement, the ongoing measurement or output is terminated as soon as the entry is confirmed (the newly selected parameters are set and the measurement or output is restarted).
- Sweep activated:**
 Since changes to parameters during a sweep can influence the measurement and thus have a negative effect on the reliability of the results displayed in the screen graphics, the current sweep is stopped and then restarted for entries of this kind.
- Entries which do not affect the measurement process:**
 Entries which do not affect the ongoing measurement process (e.g. changing a unit) are adopted immediately without the ongoing measurement being interrupted.

4.8 Measurement Displays

The audio analyzer offers various types of measurement windows for displaying the results of the numerous measurement functions. The measurement results can be dis-

played as digital numeric values, in analog bar graphs, in result graphics or in data lists. The user can open any number of measurement windows on the screen. The size of the panels can be changed within broad limits, whereby the font size, scaling and so on are adapted automatically; see also [chapter 4.4.3, "Moving and Resizing Panels and Graphical Windows"](#), on page 150.

4.8.1 Measurement Functions and Displaying Measurement Results

- **What** (which measurement function) is measured and **how** (which measurement method) measurement is performed, is preset in the "Analyzer Function" panel.
- The **configuration panels for measured value display** are used to determine how the measurement results are presented (i.e. which unit, how many digits, etc.). A series of panels for the different measurement windows are provided for this purpose.
- The results are finally displayed in the various **measurement windows**.

The basic settings in these configuration panels and measurement windows are described in the following sections. For a detailed description of the individual parameter fields, see [chapter 4.8.2, "Numeric Display Field"](#), on page 174 and [chapter 5.50, "Curve, Spectrum and Bar Graph Display"](#), on page 664.

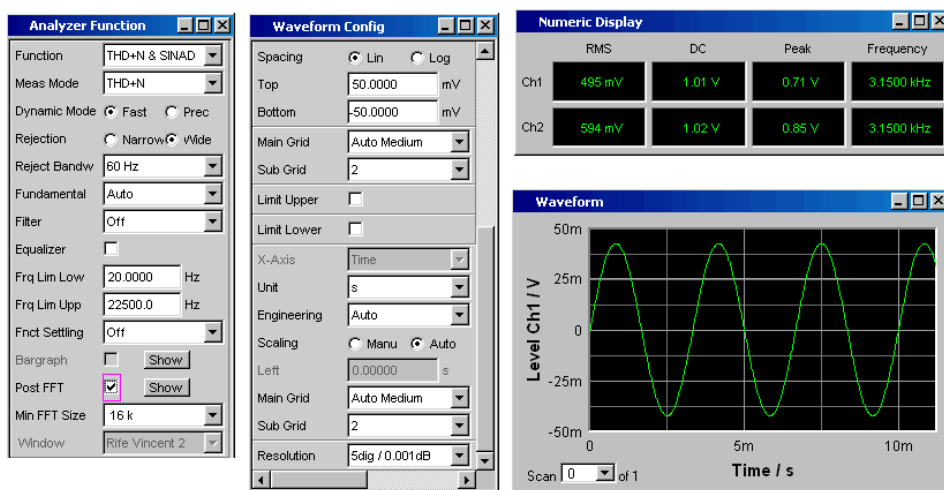


Fig. 4-3: Measurements and display of results for audio analyzer

What is measured and how the measurement is performed: = Analyzer Function
 Type of displays of measurement results = Waveform Config
 Display of measurement results = Numeric display or measurement graph (here: waveform)

4.8.2 Numeric Display Field

The numeric display field provides a clear overview of the numeric values from various analyzer functions and displays a maximum of 64 numeric value results from the "Ana-

alyzer Function" panel. The individual columns are permanently assigned, from left to right:

- **Column 1:**
Measurement results of the function which is set in the "Analyzer Function" panel in the "Function" field.
- **Column 2:**
Measurement results for the set "Level Monitor" function.
- **Column 3:** Measurement results for the "Input Peak" function.
- **Column 4:**
Display of either the frequency measurement result or, if "Freq & Phase" or "Freq & GrpDel" is set, display of the frequency measurement result in the first row and display of the phase or group delay measurement in the second row.

Numeric Display				
	RMS	Lev RMS	Input Peak	Frequency
Ch1	495.59 mV	500.60 mV	705.85 mV	1000.0 Hz
Ch2	594.59 mV	600.60 mV	846.85 mV	1000.0 Hz

Each column is labeled with the name of the displayed measurement function, whereby additional, more specific function-related information may also be shown in some cases. Example: For difference frequency distortion measurement, the type of measurement and the associated measurement standard, e.g. DFD d2 (IEC 268), is also displayed.

The results from the two measurement channels are shown in the measurement fields (exception: frequency/phase or frequency/group delay measurement).

If not all of the columns are required because one or more of the associated measurement functions is deactivated, the column in question is hidden.

The numeric display field is opened via the menu bar and called up using the Displays button.

Function	Front panel	Computer keyboard	Mouse
Opening a numeric display field	Press the MENU key and highlight the Displays button using the rotary knob or cursor keys, open the pulldown menu with the ENTER key or rotary-knob click, and highlight and select the numeric display field.	Press the shortcut CTRL +M, then highlight the Displays button using the TAB or SHIFT+TAB keys, open the pulldown menu using the Enter key, highlight the numeric display field using cursor keys and select it using the Enter key.	Open the menu bar by moving to left edge of screen, activate the Displays button and click on the numeric display field.

4.8.2.1 Measurement Result Display in a Numeric Display Field

The display of measurement results in a numeric display field is configured in the following panels:

- Function Config

- Level Mon Config
- Input Config
- Freq / Phase Config

The following examples of measured value displays demonstrate the various display options. A number of basic settings made in these configuration panels are described in the following section. A detailed description of the display options can be found in the [chapter 5.52.1, "Graphical Display, Explanation of the Elements"](#), on page 742.



If the measured value is within the preset limits or no limits were specified, the measured value is displayed in green on a black background.

A measured value for a linear unit is displayed with 3 to 7 digits; a measured value for logarithmic units can be displayed with a resolution of 0.1 dB up to 0.00001 dB.



If the measured value underruns or overruns the preset limits, it appears red on black.

As soon as the measured value is back within the limits, it changes to green again.



If a measurement channel is switched off, the text OFF appears in the corresponding measured value display.



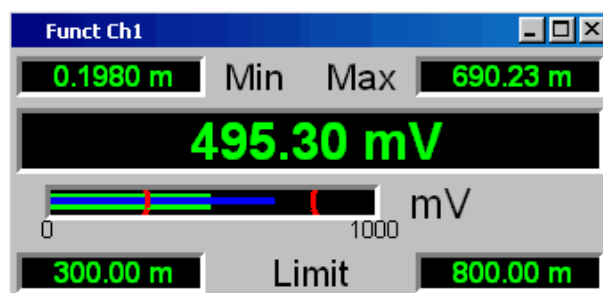
If no measurement result is available (e.g. frequency result for DC measurement), "---" appears.

4.8.3 Combo Display

It is often the case that the numeric value of a measurement result does not contain adequate information. Additional features such as analog bar graphs, limit monitoring or the storage of maximum and minimum values are frequently required.

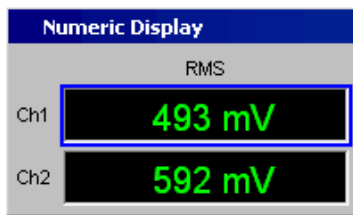
The combo display is used for this purpose. Additional information can be displayed for every measurement shown in the numeric display.

The free selection and free scalability mean that especially important or critical results can be monitored and tracked even when viewing the R&S UPV screen from a relatively long distance.

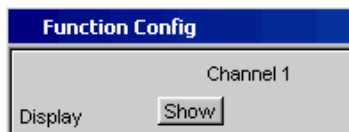


4.8.3.1 Opening Combo Displays

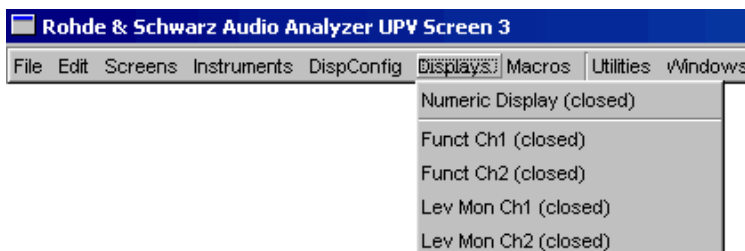
The easiest way to open combo displays is to highlight the respective measurement display in the numeric display field (blue selection frame) and to select the display with the ENTER key or rotary-knob click.



Alternatively, combo displays can also be opened via the corresponding configuration panels. The associated combo display is activated using the "Show" button in the "Display" field.



The combo displays can also be opened via the menu bar: They are located under the "Displays" button underneath the "Numeric Display" option. Depending on the channel number of the selected analyzer instrument, fonts and menu structure for "Display" Function, Lev Mon, Input, Frequency and Phase measurement results change.



Function	Front panel	PC keyboard	Mouse
Activating a Combo Display via a Numeric Display Field	Highlight the desired measurement display in the numeric display field and open the combo display with the ENTER key or a rotary-knob click.	Select the numeric measurement display with CTRL+TAB or CTRL+SHIFT+TAB. Highlight desired measurement display in numeric display field with TAB or SHIFT+TAB and open combo display with ENTER.	Double-click desired measurement display in numeric display field.
Activate combo display via menu bar and Config panel	Highlight the "DISPLAY" button in the associated Config panel and open the combo display with the ENTER key or a rotary-knob click.	Select the menu bar with CTRL+M. Select the "DispConfig" button with TAB or SHIFT+TAB. Open the pulldown menu with ENTER. Select the desired Config panel with CURSOR DOWN or CURSOR UP and open it with ENTER. In the Config panel, select the "Display Show" button with TAB or SHIFT+TAB and open the combo display with ENTER.	Click DISPLAY button in associated Config panel.
Activate the combo display directly via the menu bar	Press the "MENU" key and select the "DISPLAY" button using the rotary knob. Open the pulldown menu with the ENTER key or a rotary-knob click. Select the desired combo display with the CURSOR UP / DOWN keys and open it with ENTER.	Select the menu bar with CTRL+M. Select the "Display" button with TAB or SHIFT+TAB. Open the pulldown menu with ENTER. Select the desired combo display with CURSOR DOWN or CURSOR UP and open it with ENTER.	Click on the "Display" button in the menu bar, then on the desired combo display.

4.8.3.2 Settings for measurement result display in combined fields

Since a combo display is available for each measurement display of the numeric display field, up to 64 of these displays can be opened. The settings for the combo displays (and for the numeric display field itself) are made in four configuration panels, whereby up to 16 measurement channels are displayed in one panel. This results in the following four panels for configuring the measurement results in the combo displays:

- Funct Config
- Lev Mon Config
- Input Config
- Freq / Phase Config

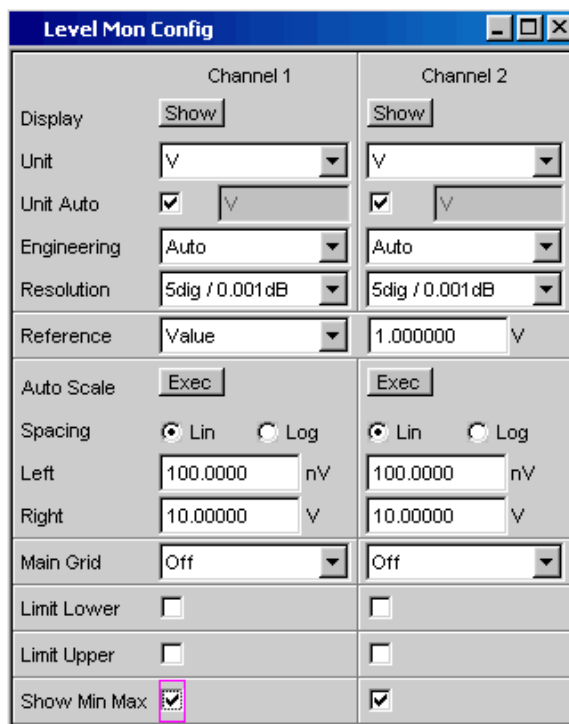
The associated panels for configuring the combo displays are opened via the menu bar; they are called up using the "Disp Config" button.

Function	Front panel	PC keyboard	Mouse
Open panel for configuring combined field or numeric display field	Press the MENU key and highlight the Disp Config button with the rotary knob or cursor keys, open the pulldown menu with the ENTER key or a rotary-knob click and highlight and select the corresponding panel.	Press shortcut CTRL + M, then highlight Disp Config button using TAB or SHIFT + TAB keys, open the pulldown menu using the Enter key, highlight the desired panel using the cursor keys and select using the Enter key.	Move the mouse pointer to the left edge of the screen, activate the Disp Config button in the menu bar and click on the desired panel.

For the two-channel analyzer instruments, the Config panels are offered in two columns since each channel can be configured by itself. For analyzer instruments with more than 2 channels, the Config panels are offered as a single column since the settings apply uniformly to all channels.

Some of the basic settings in these panels are described here using the "Lev Mon Config" panel as an example. Since the combo display is an extension of the numeric display field, the settings also influence the numeric display field.

For a detailed description of the display options, see [chapter 5.52.1, "Graphical Display, Explanation of the Elements"](#), on page 742.



Some of the settings described below are only visible if the combined display is of adequate size on the screen. For example, scaling and grid lines are hidden automatically and stepwise if the display is reduced in size.

- **Unit of measurement result**

This parameter field is used to set the unit for the measurement result display. The units available in the parameter list depend in the type of measurement.



An overview with all the units that occur for the audio analyzer and their conversion formulas is located in [chapter 4.17, "Units"](#), on page 223.

Details concerning the numeric value display can be specified here for all linear units.

For example, it is possible to select whether voltage is to be given in V, mV, μ V, and so on. If "Auto" is set, these unit prefixes are automatically adapted to the measured value.



- **Reference values**

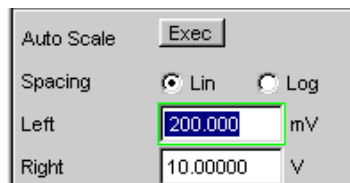
The reference value for relative measured values can be set here.

This can be a fixed preset value; however, values measured at a different location or values based on the generator settings and so on can also be adopted automatically as reference values.



- **Bar graph scaling**

If the "Autoscale" button is activated, the extreme values that have so far occurred are used for scaling the left-hand and right-hand scale end value. The scaling can, however, also be set manually.



The axis can be displayed with linear or logarithmic subdivisions.

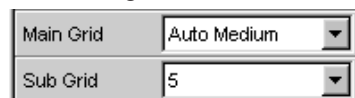
If manual scaling was selected, the start and end value of the bar graph must be entered in the two fields.

If the selected scaling does not encompass all measured values, a red arrow indicates the end of the scale at which the measured value is beyond the range of the bar graph.



- **Gridlines**

The settings Main Grid and Sub Grid are used to subdivide the bar graph.



Main gridlines which are labeled with the associated numeric values can be added with different intervals.

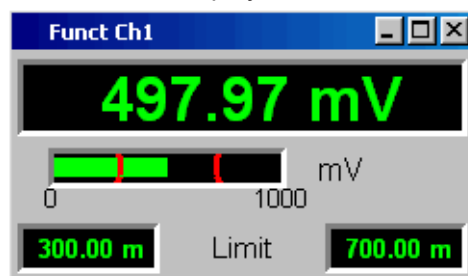
Subgridlines are used for further subdivisions; these lines are not labeled.



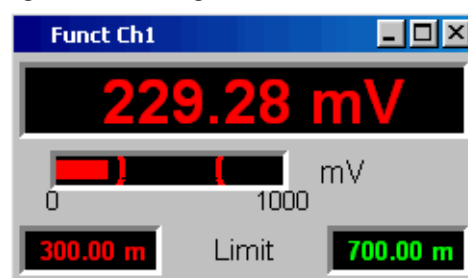
- Limits**
 A lower and/or upper limit can be defined for each measurement result. If the limit is activated, each measured value is compared with the limit.

Limit Lower	<input checked="" type="checkbox"/>	<input type="text" value="2.34000"/>	V
Limit Upper	<input type="checkbox"/>		

The set limits are shown in the bottom part of the combined display and appear as a red limit marking on the bar graph. As soon as one of the limits is exceeded, the measurement display and measurement bar changes from green to red. If the measured value is within the limits, the measurement display and measurement bar are displayed in green.



In order to monitor limit violations over a long period of time without having to watch the measurement displays continuously, the lower and/or upper limit is displayed permanently in red as soon as it is exceeded. Pressing the START key again or entering a new limit resets the limit to green.



The measurement display in the numeric display field always behaves in the same way as the measurement display in the combined field; current limit violations can therefore also be monitored in the numeric display field.

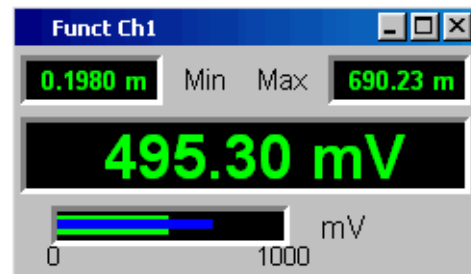
- Extreme values**
 If this checkbox is activated, the lowest and highest measured value is displayed. Display of the Min/Max values can be set separately for each measurement display and for the two measurement channels.

Show Min Max	<input checked="" type="checkbox"/>
--------------	-------------------------------------

The minimum and maximum values which have been measured are shown in the top part of the combined display; an additional blue bar which records the span between the extreme values is also displayed.

The Min/Max values can thus also be recorded over a long period of time without the measurement displays having to be monitored continuously.

Pressing the START key again resets the Min/Max values.



- Number of displayed digits
The "Resolution" field is used to set the number of digits used when displaying the measured values, Min/Max values and limits.



Values in linear units can be displayed with 3 to 7 digits; values in logarithmic units can be displayed with a resolution of 0.1 dB to 0.00001 dB.

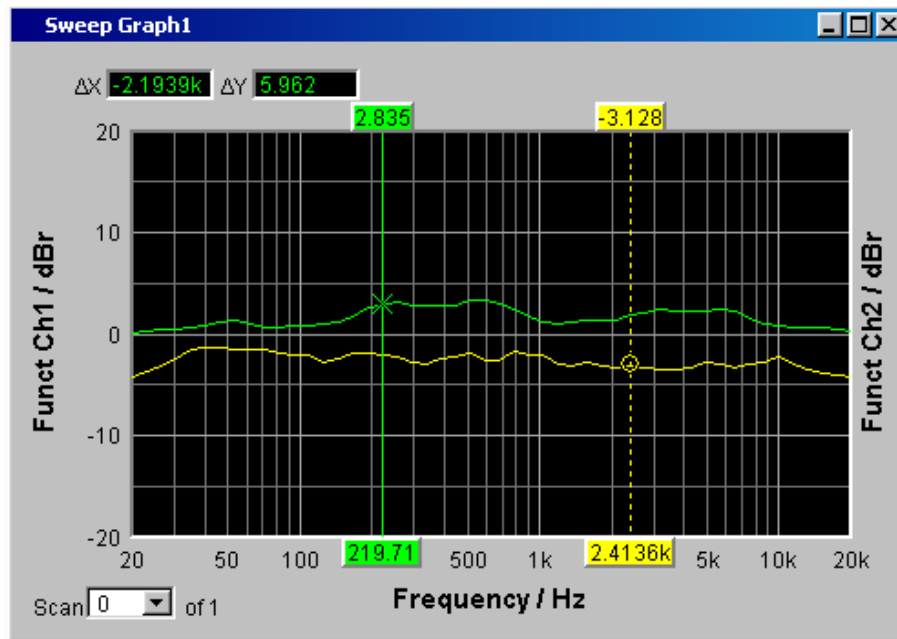


4.8.4 Graphical window

The most informative method of displaying measurement results is usually a two-dimensional graphic. Measured values as a function of frequency, measurements over a time axis and so on are just a few examples of the many possible applications. The audio analyzer makes a distinction between the graphical windows (shown in the following sections) which can be set and modified using the associated configuration panels.

All graphical displays can be evaluated using horizontal and vertical cursors; markers are used to identify important measurement points. A broad range of softkey control functions can be used to scale graphs, to display sections of graphs, and to perform many other tasks.

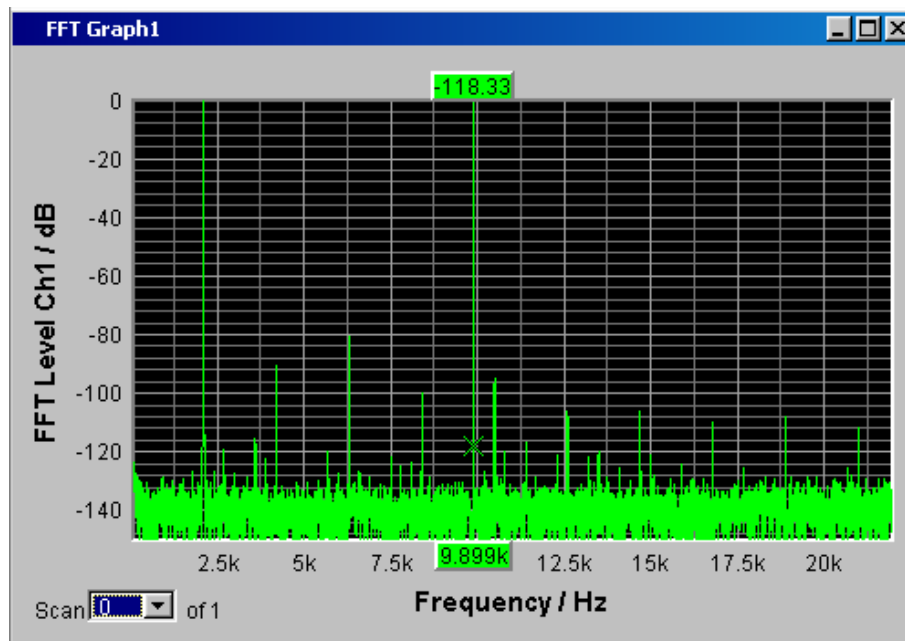
4.8.4.1 Sweep graph



Here, the measured values of a measurement sequence (sweep) can be displayed as a line diagram in a coordinate system. One or two traces (TRACE A and TRACE B) can be recorded along an x-axis. Each trace can consist of a large number of scans. The traces can be saved and saved traces, reference curves and/or limit curves can be imported into the graph.

Up to four "sweep graphs" can be displayed at the same time and can all be configured differently. As a result, it is possible to display different measurement functions or display the same measurement function in a different way.

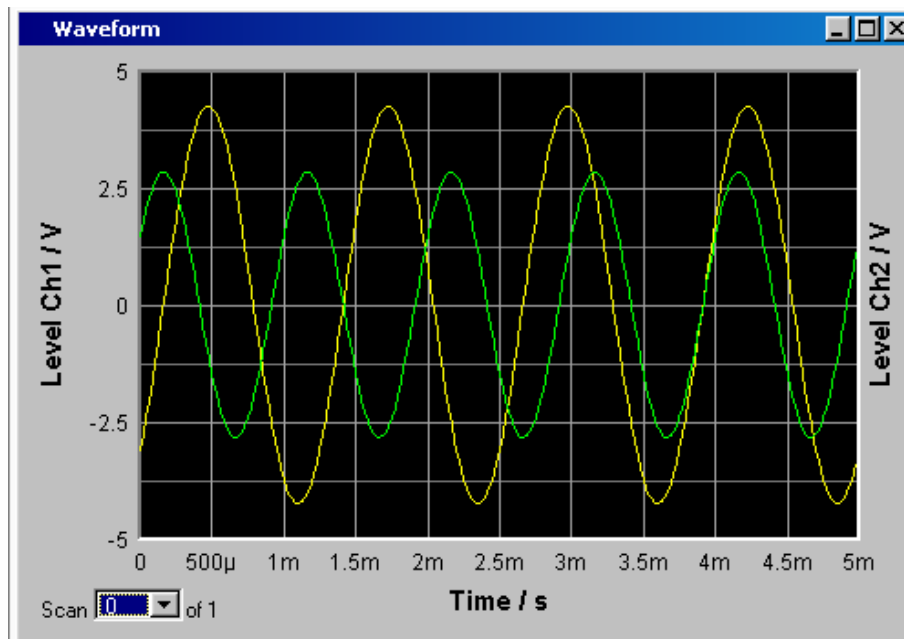
4.8.4.2 FFT Graph



In these panels, the frequency spectrum of the **FFT** measurement function or the **Post FFT** downstream of another measurement function. One or two traces (TRACE A and TRACE B) can be recorded along a frequency axis. Each trace can consist of a large number of scans. The traces can be saved and saved traces, reference curves and/or limit curves can be imported into the graph.

Up to two FFT graphs can be displayed at the same time and can both be configured differently.

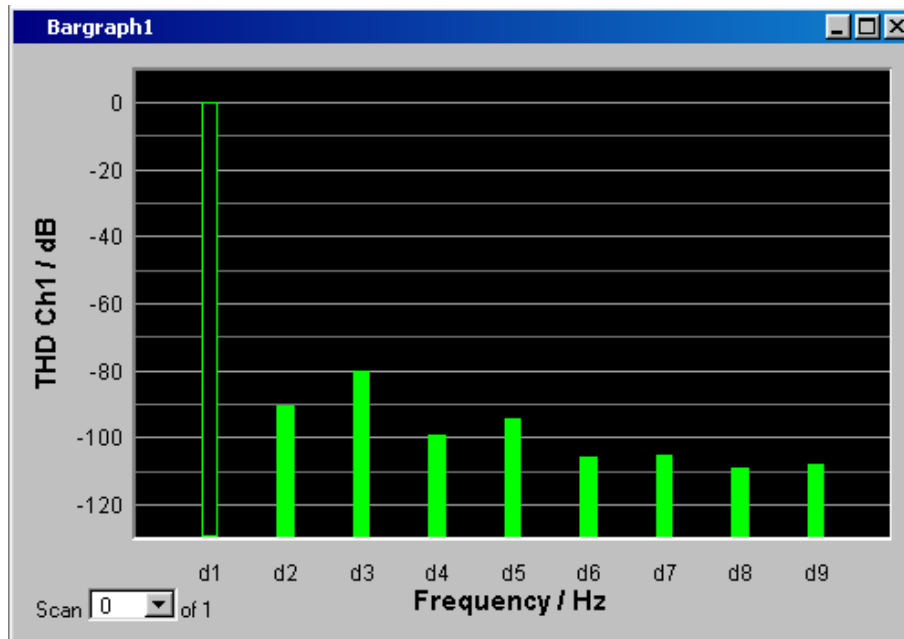
4.8.4.3 Waveform



The waveform display is a type of oscillogram in which the signal characteristic of the analyzed audio signal over time is displayed. One or two traces (TRACE A and TRACE B) can be recorded along a time axis. The traces can be saved and saved traces, reference curves and/or limit curves can be imported into the graph.

This graph can be displayed once only; it is linked to the "Waveform" function in the "Analyzer Function" panel.

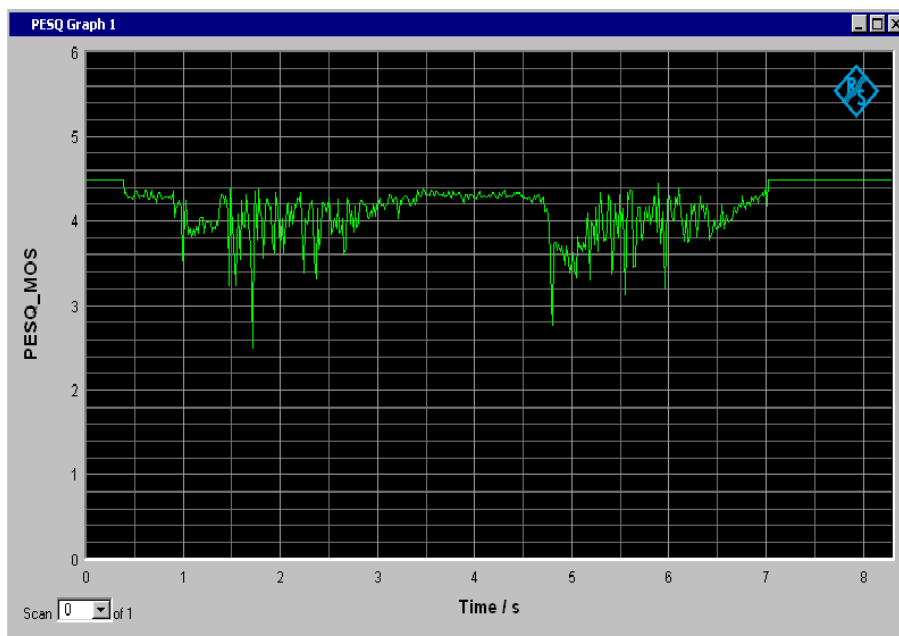
4.8.4.4 Bar Graph



If one of the functions "THD", "Mod Dist", "DFD" or "DIM" is selected in the "Analyzer Function" panel, the function measurement result can be displayed broken down into its frequency components on a bar graph. The individual distortion products are recorded along a frequency axis. The structure of the distortion products (2nd, 3rd, 4th, nth harmonic, DFD of 2nd or 3rd order, etc.) can be recognized at a glance. The bar graph can display one or two channels; once again, the results can be saved and saved results can be imported into the graph.

Two bar graphs are available so that, for example, THD values at two different measurement points can be displayed or the measured values of both input channels can be shown on two separate graphs.

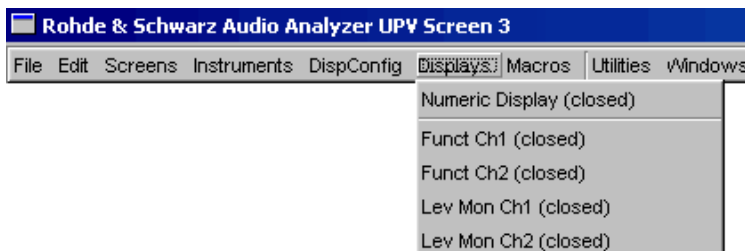
4.8.4.5 PESQ/POLQA Graph



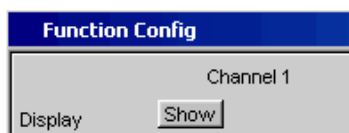
In these graphics windows, you can display the PESQ and MOS value of the PESQ/POLQA measurement as well as the time delay between the reference and measurement signal over a time axis. It is possible to display up to two PESQ/POLQA graphs simultaneously, where they can be configured differently.

4.8.4.6 Opening graphical windows

The graphical windows can be opened via the menu bar; they are called up using the "Displays" button.



Alternatively, the graphical windows can also be opened using the associated configuration panels (see the following section). The associated graphical window is activated using the "Show" button.



In the "Analyzer Function" panel, it is also possible to use the "Show" button to open some graphical or data windows. They will then be displayed in the same screen, without opening the associated configuration panels.



Function	Front panel	PC keyboard	Mouse
Open graphical window via menu bar	Press the MENU key and highlight the Displays button using the rotary knob or cursor keys, open the pulldown menu with the ENTER key or rotary-knob click, and highlight and select the desired graphical window.	Press the shortcut CTRL +M, then highlight the Displays button using the TAB or SHIFT+TAB keys, open the pulldown menu using the ENTER key, highlight the desired graphical window using the cursor keys and select it using the ENTER key.	Open the menu bar by moving to left edge of screen, activate the Displays button and click the desired graphical window.
Open graphical window via Config panel	Highlight the "Data List" button in the associated Config panel and open the graphical window with the ENTER key or rotary-knob click.	Highlight the DISPLAY button in the associated Config panel and open the graphical window with the Enter key.	Click DISPLAY button in associated Config panel.
Open graphical window via Analyzer Function panel	Highlight "SHOW" button in "Analyzer Function" panel and open graphical window with ENTER key or rotary-knob click.	Highlight SHOW button in Analyzer Function panel and open graphical window with ENTER key.	Click SHOW button in Analyzer Function panel.

4.8.4.7 Settings for measurement result display in the graphical windows

The associated panels for configuring the graphical windows are opened either using the "Disp Config" button in the menu bar or using the "Settings" softkey in the graphical window.

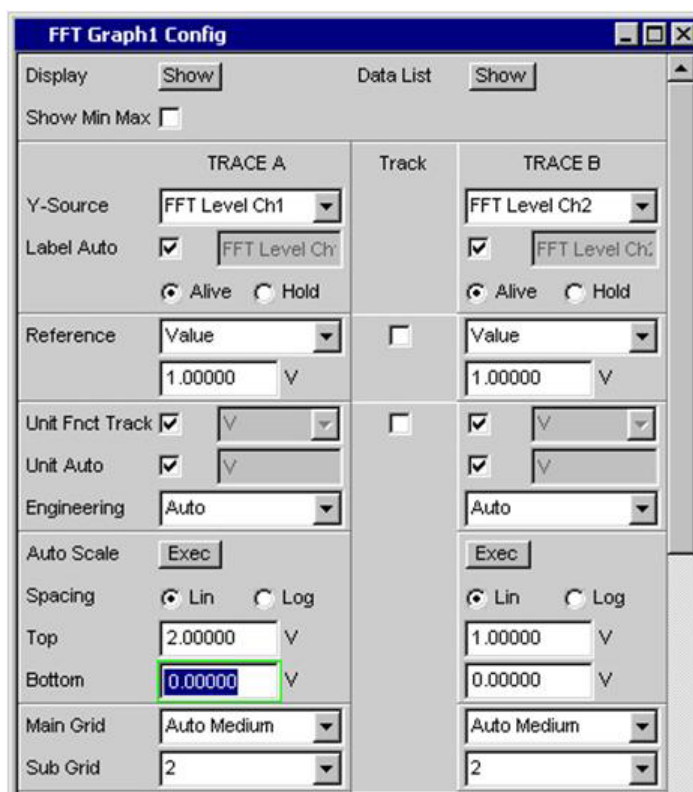
The settings for configuring the graphical displays are made in the following panels:

- Sweep Graph 1 to 4 Config
- FFT Graph 1 to 2 Config
- Waveform Config
- Bar Graph 1 to 2 Config

Function	Front panel	PC keyboard	Mouse
Open panel for configuring a graphical window	Press the MENU key and highlight the "Disp Config" button with the rotary knob or cursor keys, open the pulldown menu with the ENTER key or a rotary knob click and highlight the selected corresponding panel.	Press shortcut CTRL + M, then highlight the Disp Config button using the TAB or SHIFT + TAB keys, open the pulldown menu using the Enter key, highlight the desired panel using the cursor keys and select using the Enter key.	Open the menu bar by moving to the left edge of the screen, activate the Disp Config button and click the desired panel.
Open panel for configuring a graphical window via softkeys in graphical window	Press "Settings" softkey of respective graphical window.	Press F12 key for Settings softkey in respective graphical window.	Click Settings softkey in respective graphical window.

Some of the basic settings in these panels are described here using the "FFT Graph1 Config" panel as an example.

For a detailed description of the display options, see [chapter 5.50, "Curve, Spectrum and Bar Graph Display"](#), on page 664.



Some of the settings described below are only visible if the graphical window is of adequate size on the screen. For example, scaling and grid lines are hidden automatically and stepwise if the display is reduced in size.

Settings for the y-axis

All the panels used for configuring graphical windows have three columns.

	TRACE A	Track	TRACE B
Y-Source	FFT Level		FFT Level
Channel	Ch 1		Ch 1
Label Auto	<input checked="" type="checkbox"/> FFT Level Ch		<input checked="" type="checkbox"/> FFT Level Ch
	<input checked="" type="radio"/> Alive <input type="radio"/> Hold		<input checked="" type="radio"/> Alive <input type="radio"/> Hold
Reference	Value	<input checked="" type="checkbox"/>	Value
	0.00000 dBV		0.00000 dBV

In all graphical windows, two traces (TRACE A and TRACE B) can be recorded on y-axes along an x-axis. The "Y-Source" parameter field is used to determine which measurement functions are mapped to the y-axes. For multi-channel analyzer instruments, the input channel to be mapped can be selected using the "Channel" parameter field. In the sweep graphics, every trace can also consist of several individual traces (scans).

In many cases, settings are to apply to both traces. The track boxes provide multi-column panels which allow settings to be transferred from the left-hand to the right-hand column without the parameters having to be entered a second time.

If the track box is activated, all of the settings within the function group are applicable to both columns. All fields with applied settings are shown in the right-hand column as grayed out display fields. These fields cannot be accessed while the track function is active. If a setting is changed in the associated parameter field in the left-hand column, this change is also shown in the display field in the right-hand column.

Displayed values

The data which is to be graphically displayed can be determined for each trace. Usually this data comes from the selected measurement functions; however, saved data (reference data) can also be displayed.

With Label Auto, the y-axis of the graph can be labeled with the data name selected under Source (see example below), or users can define their own label.

The "Hold" radio button is used to "freeze" the graphical display.

TRACE A	
Y-Source	Level Ch1
Label Auto	<input checked="" type="checkbox"/> Level Ch1
	<input checked="" type="radio"/> Alive <input type="radio"/> Hold

Additional scans can be added to a graph ("Append"), or existing scans in a graph can be replaced by new ones ("Replace").

Reference values

The reference value for relative measured values can be set here. This can be a fixed preset value; however, values measured at a different location or entire scans from files, from the other measurement channel and so on can also be used automatically as reference values / reference curves.

Reference	Value	▼
	1.23400	V

Units of Measured Values

This parameter field is used to set the unit for the trace. The units available in the parameter list depend in the type of measurement.

Alternatively, if the checkbox is selected, the unit used in the analyzer will be used.

An overview with all the units that occur for the audio analyzer and their conversion formulas is located in [chapter 4.17, "Units"](#), on page 223.

Unit Anlr Track	<input type="checkbox"/>	V	▼
-----------------	--------------------------	---	---

Details concerning the numeric value display can be specified here for all linear units.

For example, it is possible to select whether voltage is to be given in V, mV, μ V, etc. If "Auto" is set, these unit prefixes are automatically adapted to the measured value.

Engineering	Auto	▼
-------------	------	---

The used unit will appear on the y-axis of the graph (see example below). Sometimes it is better to use a label defined by the user; this label can be entered in the parameter field.

Unit Auto	<input checked="" type="checkbox"/>	V
-----------	-------------------------------------	---

Y-axis scaling

If the button for automatic scaling is selected, the audio analyzer uses the minimum and maximum values of the available measurement cycle to automatically determine a suitable value range for the graph to be displayed. This scaling is determined once and retained until the autoscale function is triggered again.

If manual scaling is required, the upper and lower end value of the y-axis must be entered in the two fields.

If a linear unit has been selected for the y-axis, this axis can be displayed with linear or logarithmic subdivisions.

Auto Scale	Exec
Spacing	<input checked="" type="radio"/> Lin <input type="radio"/> Log
Top	10.00000 dBV
Bottom	-170.000 dBV

Gridlines

The settings Main Grid and Sub Grid are used to subdivide the bar graph.

Main Grid	Auto Medium
Sub Grid	5

Main gridlines which are labeled with the associated numeric values can be added with different intervals.

Subgridlines are used for further subdivisions; these lines are not labeled.

Limits

A lower and/or upper limit can be defined for each measurement result.

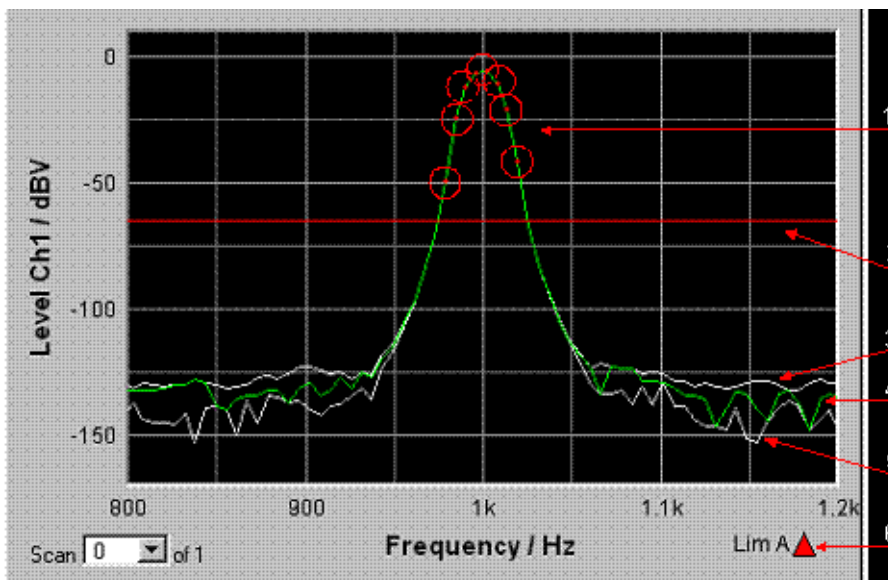
If the limit is activated, each measured value is compared with the limit.

Lim upper	<input checked="" type="checkbox"/>
Source	Value
	-65.0000 dBV
Lim lower	<input type="checkbox"/>

Limit curves appear as a red line on the graph.

Each measured value which violates a limit is highlighted by a red dot on the curve. In addition, a red arrow pointing up/down in the bottom right-hand corner of the graph provides a permanent indication of limit overranging/underranging.

Every restart of a continuous measurement with START resets the limit monitoring again. Resetting the limit monitoring can also be done with the "Restart Min/Max, Lim Violation" softkey.



- 1 = Limit overshooting (here also marked with circles)
- 2 = Limit line
- 3 = Max value trace
- 4 = Trace
- 5 = Min value trace
- 6 = Limit display

Extreme values

If this checkbox is activated, a Min and Max characteristic is displayed that indicates the lowest and highest measurement results of a measuring sequence.



Two additional gray lines which represent the measured extreme values (see the example above) then appear in the graph.

The Min/Max values can thus also be recorded over a long period of time without the measurement displays having to be monitored continuously.

Every restart of a continuous measurement with START resets the limit monitoring again. Resetting the limit monitoring can also be done with the "Restart Min/Max, Lim Violation" softkey.

Settings for the x-axis

The same rules that apply to the y-axis also apply to the settings of the x-axis.

Display of X and Y Values

The "Resolution" field is used to set how many digits are used when displaying values on the x-axis and y-axis and at the cursor.

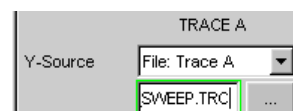


Values in linear units can be displayed with 3 to 7 digits; values in logarithmic units can be displayed with a resolution of 0.1 dB to 0.00001 dB.

Loading and saving traces / scans



The current trace together with all scans can be saved in these parameter fields by calling up the file directory using the ... button; for details, see [chapter 4.15, "File Management"](#), on page 217.



Here, saved traces together with all of their scans can be loaded and displayed in the current graph by calling up the file directory using the ... button.

4.8.4.8 Evaluating Graphical Displays with Cursors and Markers

All graphical displays can be evaluated using horizontal and vertical cursors; the X and Y-values shown in the display fields associated with the cursors are always current values.

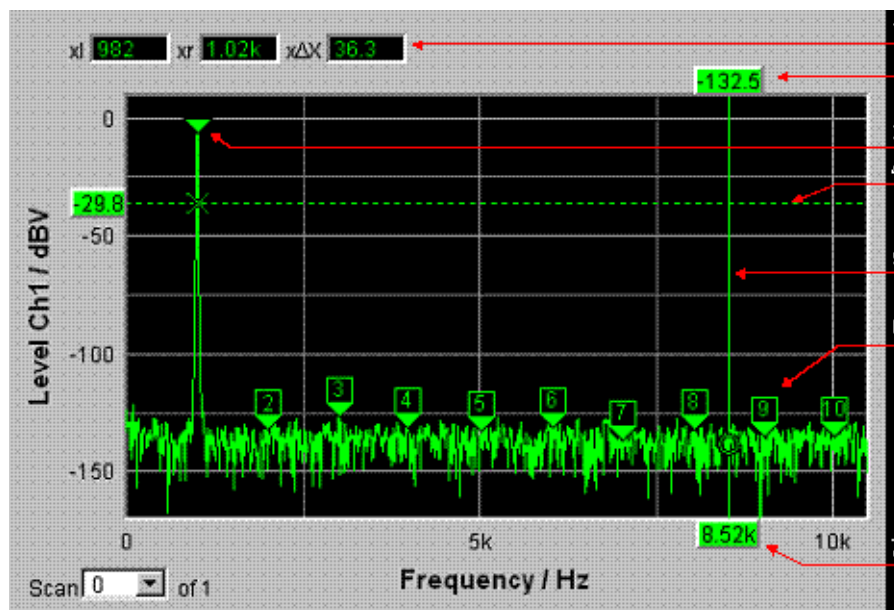
Markers are used to identify important measurement points.

The cursors and markers can only be operated using the softkey bar; the softkeys can be operated from the front panel, using the keys F5 to F12 on the external PC keyboard or by clicking with the mouse.

The graphics can be scaled or displayed zoomed in sections via softkeys or by using the mouse.

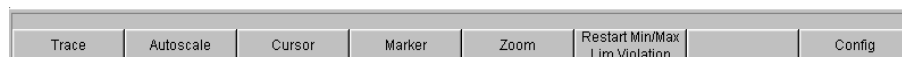
The basic settings in these functions are described here using examples.

For a detailed description of the display options, see [chapter 5.50, "Curve, Spectrum and Bar Graph Display"](#), on page 664.



- 1 = Additional cursor values
- 2 = Cursor Y value
- 3 = Marker
- 4 = Horizontal cursor
- 5 = Vertical cursor
- 6 = Harmonic marker
- 7 = Cursor X-value

As soon as the graphical window has the focus, the softkey bar for operating the graphical elements is shown at the bottom of the screen.



The softkeys are arranged in several levels; the lower levels are accessed by activating the respective button. Activating the "Back" button redisplay the higher level. At the lowest respective level, the buttons directly trigger the desired function.

Showing and hiding traces – Trace function



Activating the "Trace" button opens another softkey level.



Scaling graph – Autoscale function

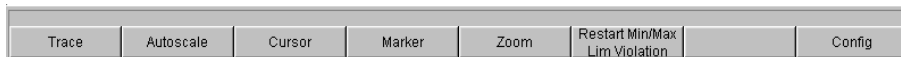


Activating the "Autoscale" button opens another softkey level.

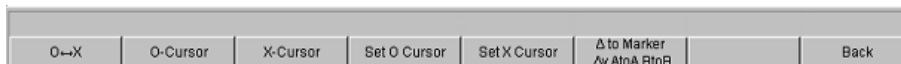


The softkeys available here are used to rescale the selected axes (if required, it is also possible to rescale the axes for certain traces only). The action triggered with these buttons corresponds to that of the "Auto Scale" or "Scaling Auto" button for the y or x-axis in the associated configuration panels. The "All" button scales x and y-axis simultaneously.

Operating the cursors



Activating the "Cursor" button displays the cursor softkeys:



The audio analyzer uses two cursors which are identified by the symbols O and X. These symbols indicate the measured point in the graph (see the example graph above).

Only one cursor is active and can be moved in the graph at any one time. The active cursor is displayed with a solid line; the inactive cursor is displayed with a broken line. The "O->X" button alternately switches the O and X cursor. Alternatively, the Enter key or a rotary-knob click can also be used to toggle between the two cursors.

The two buttons "O-Cursor" or "X-Cursor" activate the respective cursor and display the next softkey level.

The two buttons "Set O-Cursor" and "Set X-Cursor" open the next softkey level where the respective cursor can be set to certain values, e.g. maximum, minimum, etc.

If, for example, the cursor was activated with the "O-Cursor" button, the following softkeys appear:



For the "O Active" button, a softkey with an additional checkbox is used. The softkey indicates that the O-cursor is active and that further settings for this cursor are available under the adjacent softkeys. Activating/deactivating the checkbox shows/hides the cursor in the graph.

The two buttons "O Vert A" or "O Vert B" activate vertical cursors and place them on TRACE A or TRACE B. Both the cursor and its label fields are displayed in the color of the associated trace.

Activating the "O Vert A-B" button displays a gray cursor which represents the difference between the values for TRACE A and TRACE B.

The two buttons "O Hor A" or "O Hor B" activate horizontal cursors and place them on TRACE A or TRACE B. Both the cursor and its label fields are displayed in the color of the associated trace.

The "Movement" button leads to the next softkey level where you define how the cursor can be moved. The second line of the label shows the currently set step size in parentheses.

Moving the Cursor

Only one cursor is active and can be moved in the graph at any one time. The active cursor is displayed with a solid line; the inactive cursor is displayed with a broken line.

The "O<->X" button alternately switches the O and X cursor. Alternatively, the Enter key or a rotary-knob click can also be used to toggle between the two cursors.

In the case of operation using the mouse, the desired cursor or one of its display fields can be activated and moved by simply clicking with the mouse.

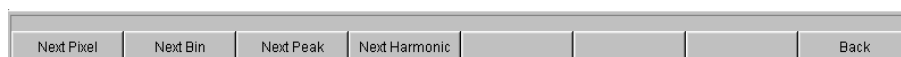
A cursor can be moved in a number of different ways:

- The active cursor is linked to the rotary knob and can be moved directly using the rotary knob.
- On the external PC keyboard, the keys TAB / CTRL + TAB move the cursor to the right / left.
- In the case of operation using the mouse, the cursor can be clicked and moved by holding down the mouse key.

The step size with which a cursor is moved can be set using softkeys. To do so, the softkey of the desired O or X-cursor must first be selected:



The "Movement" button opens the next softkey level where various step sizes for moving the cursor are offered irrespective of the graph currently being used. This is described in greater detail below. The currently selected step size is indicated in brackets in the second label line of the "Movement" button.



Sweep graph

• "Next Pixel "

Selecting the "Next Pixel" button moves the cursor by one pixel in the graphic with every increment. If there is not a measured value at every pixel in the graphical display (because only a few measurement points were recorded relative to the size of the displayed graph), the cursor value is interpolated linearly at the pixels between

the measured values. If the number of recorded measurement points in the graph is greater than the number of pixels available for display, the largest measured value in each case is displayed at the corresponding pixel with X and Y value.

- **"Next Step "**
Selecting the "Next Step" button moves the cursor to the next measured value with every increment. The cursor is therefore moved in smaller or larger steps depending on the number of measurement points. If the graph is displayed relatively small or the number of recorded measured values displayed is greater than the number of pixels available in the graphical field, the cursor sometimes does not appear to move (it remains on the same pixel). However, the associated display fields always show the currently selected measurement point with X and Y-value.
- **"Next Peak "**
Selecting the "Next Peak" button moves the cursor to the next measured peak with every increment.

FFT Graph

- **"Next Pixel "**
Selecting the "Next Pixel" button moves the cursor by one pixel in the graphic with every increment.
With FFT analyses, the number of recorded measurement points (bins) is usually much greater than the number of pixels available for display in the graph; the cursor then indicates the bin with the largest measured value at the pixel in question and displays this bin with its X and Y-values.
- **"Next Bin "**
Selecting the "Next Bin" button moves the cursor to the next measured bin with every increment.
Since with FFT analyses the number of recorded measurement points (bins) is usually much greater than the number of pixels available for display, the cursor sometimes does not appear to move (it remains on the same pixel). However, the associated display fields always show the currently selected measurement point with X and Y-value.
- **"Next Peak "**
Selecting the "Next Peak" button moves the cursor to the next measured peak with every increment.
- **"Next Harmonic "**
Selecting the "Next Harmonic" button moves the cursor to the next marked harmonic with every increment.
This button is also available if the harmonic marker is not active (see the next section, Operating the markers). In this case, the button activates the harmonic marker.

Waveform

- **"Next Pixel "**
Selecting the "Next Pixel" button moves the cursor by one pixel in the graphic with every increment.
If there is not a measured value at every pixel in the graphical display (because only a few measurement points were recorded relative to the size of the displayed

graph), the cursor value is interpolated linearly at the pixels between the measured values.

If the number of recorded measurement points in the graph is greater than the number of pixels available for display, the largest measured value in each case is displayed at the corresponding pixel with X and Y value.

- **"Next Sample "**

Selecting the "Next Sample" button moves the cursor to the next measured value with every increment.

If the graph is displayed relatively small or the number of recorded measured values (samples) displayed is greater than the number of pixels available in the graphical field, the cursor sometimes does not appear to move (it remains on the same pixel). However, the associated display fields always show the currently selected measurement point with X and Y-value.

Bar Graph

- **"Next Value "**

Only the "Next Value" setting is available here; the cursor moves to the next measured distortion point (harmonic or intermodulation product) with each increment. The softkey movement indicates the step size.

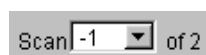
All of the step-size settings for cursor movement described here only affect the currently selected cursor and are only applicable in the selected graphical window. This means that when a different cursor is activated or a different graphical window is selected, the cursor is moved using the settings applicable there.

The selected step size applies equally to vertical and horizontal cursors.


Function	Front panel	PC keyboard	Mouse
Moving the Cursor	Activate desired cursor via softkeys and move using rotary knob.	Activate desired cursor via softkeys and move using keys TAB and CTRL + TAB.	Click desired cursor or associated display field and move cursor with mouse key held down.
Select active cursor via softkey	Activate the O<->X softkey which toggles between O and X cursor.	Press the F5 function key of the O<->X softkey; this softkey toggles between O and X cursor.	Click desired cursor or one of its display fields.
Select active cursor via Enter function	If desired graph has focus, ENTER key or rotary-knob click toggles between both cursors.	If desired graph has focus, Enter key toggles between both cursors.	Click desired cursor or one of its display fields.

Cursor in traces with several scans

If a trace consists of several scans, the cursors only move along one scan and indicate the x and y-values of this scan. The scan number displayed in the bottom left-hand corner of the graph in the respective display field indicates which scan is being analyzed.



In order to analyze individual scans with cursors, the cursor is switched to the desired scan in the following way:

- Front panel: with the  keys
- External PC keyboard: with the keys ALT + PAGE UP and ALT + PAGE DOWN
- Mouse: by clicking the "Scan" field shown above

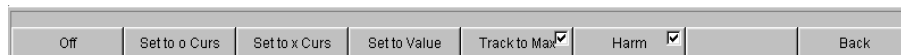
Operating the markers



Activating the "Marker" button displays the marker softkeys:



The user must first select the trace on which a marker is to be set. The next softkey level appears simultaneously:



The two buttons "**Set to O-Curs**" and "**Set to X-Curs**" set the marker to the value of the currently selected cursor.

- "**Set to Value**"

Sets marker to a value that can be entered later in an input field that appears in the area of the softkeys

- "**Track to Max**"

sets a marker at the maximum value of the curve. If the maximum value changes, the marker is set at the new maximum value.

- "**Harm**"

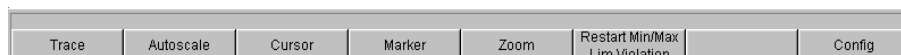
marks harmonics of the frequency indicated by the marker.

If no marker has been set, activating the "Harmonics" button sets the marker to the maximum value of the trace and calculates and marks the harmonics from this frequency.

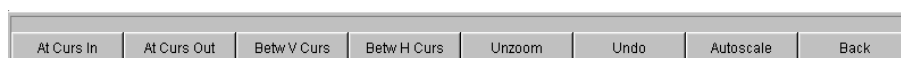
- "**Off**"

button deactivates the marker and the indication of the harmonics.

Zooming the graph



Activating the "Zoom" button displays the zoom functions.



- "**Act Curs In**"

The "Act Curs In" button zooms in on the section of graph on either side of the active X-cursor.

- **"Act Curs Out "**

The "Act Curs Out" button zooms out from the section of graph on either side of the active X-cursor.

- **"Betw V Curs" or "Betw H Curs"**

The "Betw V Curs" or "Betw H Curs" button zooms in on the area between the two X or Y-cursors. The zoomed display is fitted to the size of the set graph.

- **"Unzoom "**

The "Unzoom" button restores the original axis, i.e. undoes all of the zoom operations performed.

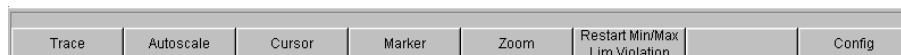
- **"Undo "**

The "Undo" button undoes the zoom operation last performed.

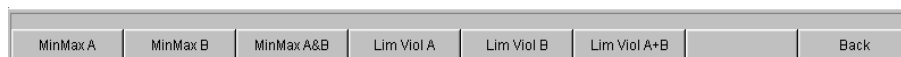
- **"Autoscale "**

The "Autoscale" button displays the next softkey level. The softkeys available here are used to rescale the selected axes (if required, it is also possible to rescale the axes for certain traces only). The initiated action corresponds to that of the "Autoscale "button in the corresponding configuration panel.

Restart Min/Max, Lim Viol function



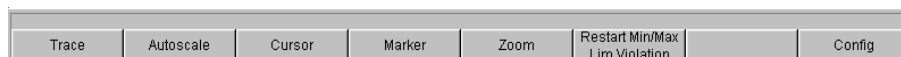
Activating the "Restart Min/Max, Lim Violation" button displays another softkey level.



If the Show Min/Max function was selected in the associated configuration panel, activating the appropriate button in the softkey bar reactivates indication of the lowest and highest measured value.

If the Lim upper or Lim lower function was selected in the associated configuration panel, activating the appropriate button in the softkey bar reactivates limit monitoring.

Config function



The "Config" button allows the user to open or close the configuration panel while operating the associated graphical window.

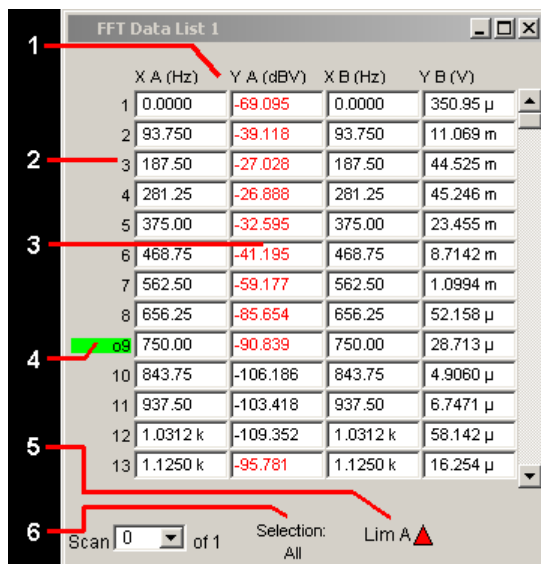
4.8.4.9 Measured value Display in Lists

The measured values can also be displayed in lists instead of or in combination with the graphical windows.

Measured values which have violated the preset limits are displayed in red.

In addition, a red arrow pointing up/down in the bottom right-hand corner of the graph provides a permanent indication of limit overranging/underranging.

Restarting a continuous measurement with START and activating the "Restart Min/Max, Lim Violation" button resets the limit monitoring.



- 1 = Columns with measured values
- 2 = Numbering of measured values
- 3 = Measured value with limit violation
- 4 = Cursor
- 5 = Display for limit violation
- 6 = Display filter

Open data list

Data lists can be opened via the corresponding configuration panels. The associated graphical window is activated with the "Data List Show" button.

Function	Front panel	PC keyboard	Mouse
Open data list	Highlight "Data List" button in associated Config panel and open graphical window with ENTER key or rotary-knob click.	Highlight Data List button in associated Config panel and open graphical window with Enter key.	Click Data List button in associated Config panel.

Data list settings

Function	Front panel	PC keyboard	Mouse
Open panel for configuring a data list	Press the MENU key and highlight the "Disp Config" button with the rotary knob or cursor keys, open the pulldown menu with the ENTER key or a rotary knob click and highlight the selected corresponding panel.	Press shortcut CTRL + M, then highlight the Disp Config button using the TAB or SHIFT + TAB keys, open the pulldown menu using the Enter key, highlight the desired panel using the cursor keys and select using the Enter key.	Open the menu bar by moving to the left edge of the screen, activate the Disp Config button and click the desired panel.

For an in-depth description with the detailed options for the settings in these panels, see [chapter 5.51, "Result List"](#), on page 735.

A number of basic settings for the data lists are described here using examples.

The measured values displayed in the lists are always linked to the values in the result graphics. This means that all settings in the configuration panels, e.g. unit, engineering, set limits and so on, are also applied to the measured values in the lists.

The position of the cursor is also shown in the lists; the highlighted measurement number indicates the location of the cursor. Similarly, the step size of cursor movement set via the softkey bar (see the previous section) also affects the movement of the cursor in the data list.

There are three ways of navigating in the lists:

- As soon as a value has been highlighted in the list (blue selection frame), it is possible to use the rotary knob to move from value to value within the column. The cursor keys can also be used to move around in the lists. The up/down cursor keys navigate in columns, the left/right keys in rows.
- If an external PC keyboard is used, the keys TAB / CTRL + TAB can also be used to move down/up within the column. Once again, the cursor keys UP and DOWN are used to navigate through the columns and the cursor keys LEFT and RIGHT to navigate through the rows.
- If a mouse is used, you can either click the desired value or navigate using the scrollbar.

As soon as the data list has the focus, softkeys appear at the bottom of the screen.



The "Close" button closes the data list.

If the "Find Cursor" button is activated, the displayed section of the data list changes so that the value highlighted with the cursor is in the middle of the list. If both cursors are activated, this button is used to toggle between the two cursor values.

Using the "Selection" button, it is possible to filter the list of displayed measured values, i.e. to list only selected rows. If this button is activated, a further softkey level appears containing softkeys for selecting the displayed values:



Depending on the selected softkey, the following are listed in the data list:

- All
- only the values which exceed the upper, lower or both limits
- only harmonics or
- only peaks

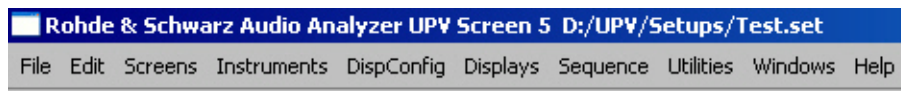
Cursor in lists with several individual scans

If a trace consists of several scans, only the values of one scan can be displayed in the list at any one time. The scan number displayed in the bottom left-hand corner of the data list in the respective display field indicates which scan is entered in the list.

In order to list individual scans, the desired scan is selected in the following way:

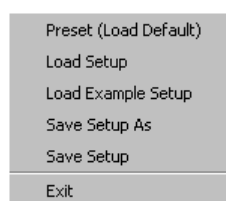
- Front panel: with the SCAN keys
- External PC keyboard: with the keys ALT + PAGE UP and ALT + PAGE DOWN
- Mouse: by clicking the "Scan" field shown above

4.9 Settings in the Menu Bar



The menu bar of the audio analyzer is used in a similar way to other Windows® applications. The following settings are made in the menu bar:

File



- **Preset (Load Default)**
To load instrument default settings (corresponds to the PRESET key on the front panel, see [chapter 4.15.4, "Loading and Saving Instrument Settings"](#), on page 220).
A dialog box appears with the confirmation query: "Do you want to preset the device?"
 - **Yes**
Preset is performed
 - **No**
Cancel

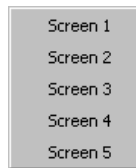
- **LAN Reset**
Another confirmation query appears: "Do you really want to reset the LAN Settings? The settings will be set to DHCP + AutoIP / VXI-11 discovery on". Answering with "Yes" **resets the LXI LAN default settings**, loads the factory-preset **instrument default settings** and **restarts the instrument**.
- **Load Setup**
To load instrument settings (corresponds to the LOAD key on the front panel; see the section Loading and Saving Instrument Settings).
- **Load Example Setup**
To load instrument settings already prepared by Rohde & Schwarz for a broad range of typical measurements and available on the instrument as example applications; these setups are divided into various application areas (AA, AD, DD, DA) depending on whether the generator or analyzer is operated with analog or digital interfaces.
- **Save Setup As**
To save instrument settings under a new name or to overwrite a setup that already exists (corresponds to SAVE key on front panel, see [chapter 4.15.4, "Loading and Saving Instrument Settings"](#), on page 220).
- **Load Display Plug-in**
A plug-in can be selected here that expands the display options of UPV by additional panels, e.g. a spectrogram representation.
- **Print Preview**
A preview window of the current graphic is displayed here which is shown with the color profile configured for the respective output device. From here, the actual output can be initiated or the action can be canceled.
- **Exit**
To exit the R&S UPV measurement program.

Edit



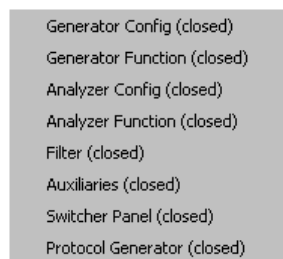
- **Cut**
To cut characters, character strings, data, etc., and transfer them to the clipboard.
- **Copy**
To copy characters, character strings, data, etc., to the clipboard.
- **Paste**
To paste characters, character strings, data, etc., from the clipboard.
- **Select All**
To select characters, character strings, data, etc., and transfer them to the clipboard.

Screens



- To select one of the five display options (screens), see [chapter 4.4, "The Display"](#), on page 147.

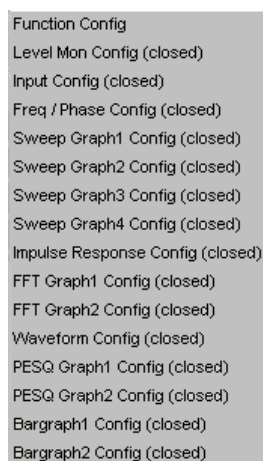
Instruments



To select the panels for configuring the generators, analyzers, filters and supplementary functions.

- The desired panel must first be highlighted and is then displayed on the currently selected screen (see [chapter 4.5.1, "Opening, Operating, Hiding and Closing Panels"](#), on page 154)
- In the list, open panels are displayed without a suffix, closed panels are identified by the suffix "closed", and open minimized panels by the suffix "hidden".

DispConfig



- To select the panel used to configure the measurement display windows.
- The desired panel must first be highlighted and is then displayed on the currently selected screen (see [chapter 4.5.1, "Opening, Operating, Hiding and Closing Panels"](#), on page 154)

- In the list, open panels are displayed without a suffix, closed panels are identified by the suffix "closed", and open minimized panels by the suffix "hidden".

Displays

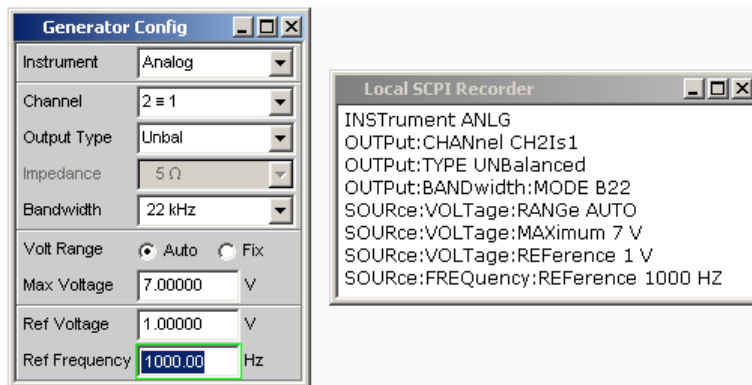
Numeric Display
Funct Ch1 RMS (closed)
Funct Ch2 RMS (closed)
Level Mon Ch1 RMS (closed)
Level Mon Ch2 RMS (closed)
Input Ch1 Peak (closed)
Input Ch2 Peak (closed)
Frequency Ch1 (closed)
Frequency Ch2 (closed)
Sweep Graph1 (closed)
Sweep Graph2 (closed)
Sweep Graph3 (closed)
Sweep Graph4 (closed)
Impulse Response (closed)
FFT Graph1 (closed)
FFT Graph2 (closed)
Waveform (closed)
PESQ Graph 1 (closed)
PESQ Graph 2 (closed)
Bargraph1 (closed)
Bargraph2 (closed)
Dig Analyzer Protocol (closed)

- To select the measurement display windows.
- The desired measurement window must first be highlighted and is then displayed on the currently selected screen (see [chapter 4.5.1, "Opening, Operating, Hiding and Closing Panels"](#), on page 154)
- In the list, open panels are displayed without a suffix, closed panels are identified by the suffix "closed", and open minimized panels by the suffix "hidden".

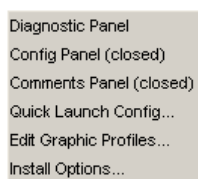
Sequence

Execute Macro
SCPI Recording

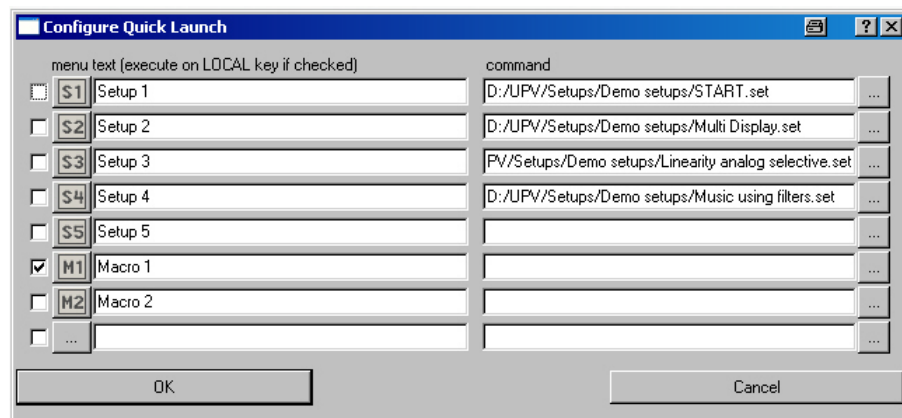
- **Execute Macro**
To select sequences (macros) used to automate previously programmed measurement procedures to start.
- **SCPI Recording**
Recording of remote control commands to simplify the creation of measurement programs (see [chapter 6, "Remote Control - Fundamentals"](#), on page 802)



Utilities




- **Diagnostic Panel**
Opens a panel for entering service settings
- **Config panel**
Opens a panel for entering instrument-wide settings, e.g. IEC bus address, the appearance of the file select box or whether the menu bar or toolbar is permanently displayed on the monitor.
- **Comments panel**
Allows entering a comment for the current setup. This comment is stored in the setup and displayed again after reloading. A few style options are available for the entry and can be selected via the right mouse button.
Remote-control command:
`SYSTem:SIInfo` on page 1037
- **Quick Launch Config ...**
In the toolbar, you can define up to 8 icons that either load setups or execute macros when clicked with the mouse; see [chapter 4.10, "Settings on the Toolbar"](#), on page 209.
You can determine these functions in the "Quick Launch Config..." window.



If a checkbox on the left side is activated, the corresponding setup or macro can be executed by means of the LOCAL key on the front panel. If several checkboxes were enabled, the entries are processed from top to bottom.

Icons can be randomly defined by the user for the adjacent button column. You can do this using the icons (S1 to S8 or M1 to M8), which are included as standard on the instrument and can be found in the C:\UPV\Config\res directory.

However, you can also use any other icon. The only requirements are that the icon has a size of 20 x 20 pixels and that it is available as a BMP file on the hard disk of the audio analyzer.

Clicking the  button with the mouse opens the File Selector, where you can select the icon file you want.

In the text fields, you can enter comments to describe the individual setup/macro; these comments are then displayed when the mouse is moved over the button. If there is an asterisk to the left of the comment, this means that the checkbox on the left side is active and that the setup/macro is executed using the above-mentioned keys.

In the command column, you can select the setup/macro that is to be activated with the symbol. The easiest way to do this is to click on the button with the mouse, whereupon the File Selector is opened, making it possible to select the required file.

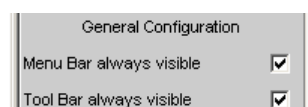
- **Edit Graphic Profiles ...**

Opens a window in which the current graphic is displayed with additional controls for editing the selected color profile. The line colors and types as well as the background colors can be set individually.

- **Install Options ...**

Displays installed options and allows installing software options

Utilities Config panel, General Configuration settings



The R&S UPV allows you to have the menu bar and/or the toolbar displayed at the top edge or at the right-hand edge of the screen all the time. This feature is primarily for operation with the mouse.

- **Menu bar always visible**

See "[Menu bar always visible](#)" on page 662

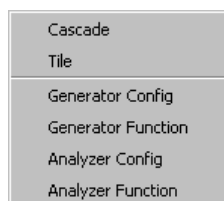
File Edit Screens Instruments DispConfig Displays Sequence Utilities Windows Help

- **Toolbar always visible**

See "[Toolbar always visible](#)" on page 662



Windows



- **Cascade**

To cascade all open panels / measurement windows.

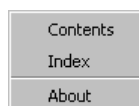
- **Tile**

To tile all open panels / windows.

- **Panel names**

To display and select all panels and measurement windows which are open and displayed on the current screen. Selecting a panel moves it to the foreground.

Help



- **Contents**

Calls up the help system of the audio analyzer, see [chapter 4.14, "Help System"](#), on page 214.

- **Index**

Call up of the help system of the audio analyzer with an alphabetically sorted listing of all terms used in the help system.

- **About**

To call up information about the firmware version installed on the instrument.

4.10 Settings on the Toolbar



As with other Windows® applications, the toolbar on the audio analyzer uses symbols that perform functions when clicked on with the mouse. These are mainly functions that are also available as keys on the front panel of the R&S UPV model. The symbols sim-

plify operation with the mouse and can thus also be used with the R&S UPV66 model. The following functions are offered:



Corresponds to the START key on the front panel.

Starts continuous measurements and sweeps.

Resets the Min/Max values for bar graph displays, averaging for measurement results, and limit overranging



Corresponds to the SINGLE key on the front panel.

Starts a single measurement or a single sweep



Corresponds to the STOP CONT key on the front panel.

Measurement / sweep is stopped or continued (toggle function).



Corresponds to the HCOPY key on the front panel.

Depending on the settings under "Utilities" in the menu bar, "Config Panel" printout of the screen contents on the connected printer is started or the screen contents are stored in a file.



Corresponds to the OUTPUT OFF key on the front panel.

Switches all outputs of the measuring instrument off or on again (toggle function).



Corresponds to the LOAD key on the front panel.

Opens a panel for loading predefined instrument settings



Corresponds to the SAVE key on the front panel.

Opens a panel for storing instrument settings



Selects the appropriate display window (screen), where the colors used have the following meaning:

- The currently selected visible display window is indicated in green.
- All screens in which windows are activated are indicated in yellow.
- Blank display windows are indicated in gray.



Symbols for conveniently loading predefined instrument settings or starting macros using the mouse. For the settings for this purpose, see [chapter 4.9, "Settings in the Menu Bar"](#), on page 203.



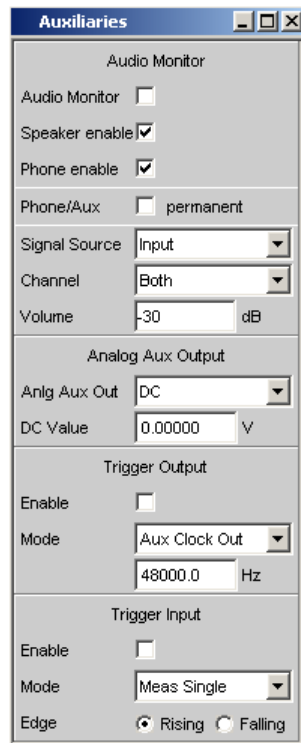
Starts the "R&S UPX Sequencing" software. This is a program that the allows the user to run test sequences.

4.11 Settings in the Operating System

The R&S UPV is equipped with the Windows XP operating system. Settings at system level are only rarely required, e.g. installation of a new printer driver.

Connecting a keyboard and mouse makes Windows easier to use.

4.12 Auxiliaries Panel



A number of supplementary functions can be selected in the "Auxiliaries" panel.

It is divided into the following sections:

- **Audio Monitor**, for configuring the audio-monitoring functions
- **Analog Aux Output**, the auxiliary analog output at the rear of the R&S UPV can be configured here
- **Trigger Input / Output**, for configuring the trigger inputs and outputs at the rear of the instrument

4.12.1 Audio Monitor Function

The audio monitoring output (integrated loudspeaker or headphone connection) permits audio monitoring of analog or digital input signals both directly at the input of the audio analyzer and at the various analysis levels downstream of any filters that may be active. Audio monitoring of the generator signal is also possible.

With installed R&S UPV-U2 retrofit (option), two BNC sockets are available at the rear of the instrument at which the signal of the headphones output is also present.

The required settings are made in the Auxiliaries panel; the settings described here are intended as examples.

An in-depth description of the detailed options can be found in [chapter 5, "Instrument Functions"](#), on page 237.

The checkboxes are used to operate the audio monitoring function.

- "Audio Monitor" switches the loudspeaker or the headphones on/off. This function corresponds to the loudspeaker ON key on the front panel of the instrument.
- "Speaker enable" and "Phone enable" are used to preselect which of the two components the on/off function described above applies to.
- Any installed R&S UPV-U2 retrofit is switched parallel to the headphones output; hence, these BNC sockets are switched on and off just like jacks.
- If the Phone/Aux box is activated, the headphone output and, if installed, the BNC connectors (R&S UPV-U2 option) remain permanently activated. The ON key only affects the loudspeaker. This "permanent" setting is very useful, for example, if you connect an oscilloscope on which the signal is to be continuously monitored and the loudspeaker is to remain selectable at the same time.

The "Signal Source" field is used to select which signal is to be monitored. This can be the measurement signal switched to the analysis path either in the **Input** or **Function** level, i.e. without or with corresponding filtering. Alternatively, the **generator** signal can also be monitored. The individual levels of the analyzer are explained in greater detail in [chapter 4.2.3.1, "Function Blocks and Measurement Levels"](#), on page 140.

In the "Channel" field, you select whether the signal of an individual channel (mono) or the stereo signal is applied to the audio monitoring output. If "Both" is set, both channels are separately available at the two headphone outputs; the loudspeaker outputs the signal from both channels. The same applies with installed R&S UPV-U2 retrofit for the two BNC sockets that are present.

In the "Volume" field, the playback volume of the loudspeaker or connected headphones is set by entering or changing the numeric value in the range from 0 dB to -120 dB.

Alternatively, the loudspeaker key at the front of the instrument can be used. A window with a symbolized volume control opens which can be operated directly with the rotary knob, the cursor keys or the mouse. The ENTER function or pressing the volume key again confirms the setting and closes the window.

⚠ CAUTION**Possible hearing damage from high sound pressure**

The output voltage of the built-in headphones amplifier is influenced by the incoming signal, by instrument settings such as the selected measurement range and test function, and by the set volume.

If the volume is set to maximum, the headphones amplifier may generate high output voltages with an RMS value of up to 8 V.

Depending on the headphones' sensitivity, this may produce very high sound pressure levels that may cause hearing damage.

To monitor varying input signals, therefore, it is advisable to reduce the volume and take off the headphones until the signal has settled.

4.12.2 Auxiliary analog output

An auxiliary analog output, ANLG AUX OUT, for the following special applications is provided at the rear:

- Output of a DC signal, e.g. for supplying power to hearing aids
- Auxiliary output for the analog generator signal via an integrated amplifier for the direct activation of small loudspeakers
- Output for single-channel audio monitoring

For details, see [chapter 5, "Instrument Functions"](#), on page 237.

4.12.3 Trigger Input, Trigger Output

A trigger input and trigger output for the following applications are provided at the rear:

- Input for triggering measurements
- Output for a measurement-event-dependent signal that can be used to trigger external instruments / circuits
- Alternatively, clock signals can also be output at the TRIG OUT socket

For additional explanations, see [chapter 5.47, "Signal Monitoring"](#), on page 644.

4.13 Rapid Deactivation of Outputs



The OUTPUT OFF key can be used in the event of faults to deactivate the outputs of the generator. This means:

- The levels of all digital outputs are set to 0 V.
- The levels of all analog outputs are set to 0 V, whereby the outputs remain terminated (i.e. the impedance is retained).

The deactivated lines can only be reactivated by pressing the OUTPUT OFF key again.

Special feature for **Anlg Aux Output**:

If DC is selected as signal source in the "Anlg Aux Out" line in the Auxiliaries panel, the DC voltage indicated in the line below will be retained even if you press the OUTPUT OFF key.

This ensures the supply voltage or the operation point is retained when a device under test (DUT) is connected.

The status of the key is indicated by an LED. Illumination of the LED means OUTPUT OFF.

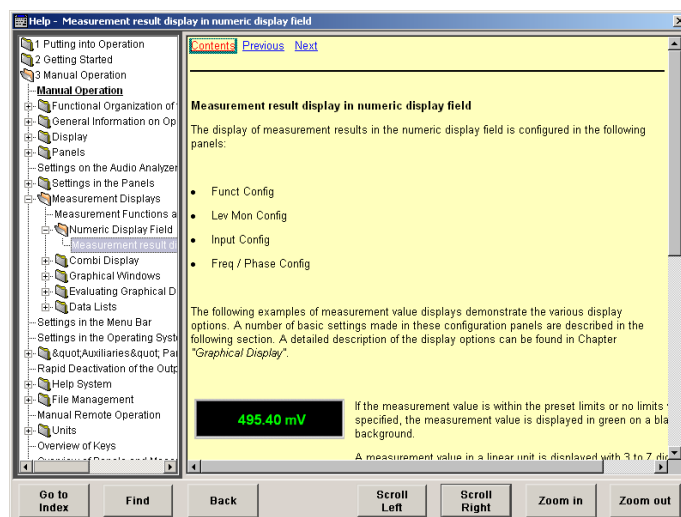
In case of an overload of the analyzer inputs (input voltage at 300 Ω or 600 Ω greater than 25 V), the generator output is automatically switched off and the OUTPUT-OFF LED lights up as if the OUTPUT-OFF key has been pressed to protect the analyzer input. After the analyzer inputs have been overloaded in this way, measurements can be resumed provided that the overvoltage has been rectified or the input impedance has been switched to 200 k Ω .

Remote-control command:

[OUTPut](#) on page 890

4.14 Help System

The R&S UPV has a context-sensitive help system. The help system provides a help page for every parameter and can be called up at any time while the instrument is being operated. The help system has a navigation bar, i.e. starting from the context-sensitive page it is possible to move to other help pages using the contents list, the index, scroll arrows and page-internal links.



In addition to the context-sensitive help, a compiled online help for all functions of the R&S UPV is provided on the supplied CD. This help can be called up on any computer using the Internet Explorer (version 4.0 and higher).

4.14.1 Operating Help

The Help window is divided into three areas. On the left-hand side is a column that displays either the entire help contents list or the index. To the right of that is a large area showing the current help page and, if necessary, a vertical scrollbar. This area can also be moved up or down with the rotary knob.



If the left-hand area containing the contents list or the index is activated, you can use the letter keys to go directly to the desired first letters in the area.

You can use the rotary knob to move the blue highlighting. Clicking the rotary knob activates the highlighted segment, and its color changes to gray. Pressing the ESC key deactivates the segment, and you can use the rotary knob again to move the highlighting.

The bottom of the window contains several buttons for operating the help system. These buttons can be operated using the mouse or the buttons:

- **"Go to Index"**
This button changes the display on the left-hand side to the index. You also use this button to return to the contents list; the button is then called "Go to Content".
- **"Find/Back"**
If you navigate in the online help by activating links, activating this button returns you to the previous page.
- **"Scroll Left/Scroll Right"**
Sometimes the help pages are too wide to fit completely in the display. In this case, a horizontal scrollbar is displayed. You can then use these buttons to scroll horizontally without losing the input focus.
- **"Zoom In / Zoom Out"**
These keys enlarge / reduce the presentation of the help content.

The advantage of using these buttons is that the appropriate help area is always activated, allowing you to work smoothly.

4.14.2 Help Text Language

Both the context-sensitive help and the online help are available in English and German. The language in which the help texts are displayed can be set via the menu bar under the "Utilities", "Config Panel" button in the "Help Language" parameter field.

See ["Help Language"](#) on page 663.

Function	Front panel	PC keyboard	Mouse
Open help for a highlighted parameter field. Help page for selected parameter is displayed.	Press HELP key.	Press F1 key.	---
Close help	Press HELP key again.	Press F1 key again.	---
Activate link Help opens linked page.	Highlight link with rotary knob or arrow keys and activate using a rotary knob click or the ENTER key.	Highlight link using cursor keys and activate with Enter key.	Click link.
Scroll through help	Highlight Previous or Next in the help window using cursor keys and activate with rotary-knob click or ENTER key.	Highlight Previous or Next in help window using cursor keys and activate with Enter key.	Click Previous or Next.
Change size of text	Use the Zoom In and Zoom Out softkeys to set the desired size.	Use the F11 (Zoom In) and F12 (Zoom Out) keys to set the desired size.	Use the Zoom In and Zoom Out buttons to set the desired size.
Switch to index	Go to Index softkey switches to index or back to contents list.	F5 (Go to Index) key switches to index or back to contents list.	Go to Index button switches to index or back to contents list.
Scroll horizontally	Use the Scroll Left and Scroll Right softkeys.	Use the F9 (Scroll Left) and F10 (Scroll Right) keys.	Use the Scroll Left and Scroll Right buttons.
Select item from contents list Help page for selected item is displayed.	Press Focus button below contents list. Highlight desired item using rotary knob or cursor keys and then press rotary knob or Press the ENTER key.	Highlight Focus button below contents list using cursor keys and activate with Enter key. Highlight desired item using cursor keys and then press Enter key.	Click item.

Function	Front panel	PC keyboard	Mouse
Select index item Help page for selected item is displayed.	Press Focus button below index. Enter the desired parameter in the entry field and then press rotary knob click or ENTER key or Highlight item using rotary knob or cursor keys and then press rotary knob or press the ENTER key.	Highlight Focus button below index using cursor keys and activate with Enter key. Enter desired item in the entry field and press Enter key or Highlight entry with cursor keys and press the Enter key.	Click item.
Select help text language	Press MENU key and highlight Utilities button using rotary knob or cursor keys, open pulldown menu with ENTER key or rotary-knob click, highlight and select Config Panel button, and highlight and select desired language in Help Language item in next level.	Press shortcut CTRL+M, then highlight Utilities button using keys TAB or SHIFT+TAB, open pull-down menu with Enter key, highlight Config Panel button using cursor keys, select with Enter key and highlight desired language in Help Language item in next level using cursor keys and select with Enter key.	Click top of screen to open menu bar, activate Utilities button, click Config Panel button and click desired language in Help Language item in next level.

4.15 File Management

The R&S UPV uses files to store all instrument data, i.e. system and user data. User data includes stored instrument settings, data for equalizer files, lists for sweeps, and so on.

The files are stored on the instrument's hard disk. The D:\ drive is available for storing user-defined data and can have any number of directory structures. A number of default directories are preconfigured; they can, however, be changed at any time.

Files can be transferred either using a USB stick or via a connected network.

The USB stick is inserted into one of the USB ports; a newly formatted stick receives the next available drive letter E:\.

In the case of a connected network, all network drives that can be accessed are available (see [chapter 2.10.2.4, "Accessing directories in the network"](#), on page 72).

The files are distinguished by their extension; each file type has a certain content. Normally, the extension is of no importance to the user since the files are accessed in the associated panels where only the relevant file type is available. For example, the files with equalizer settings can only be loaded in the "Generator Function" and "Analyzer Function" panels if the appropriate function settings have been made.

To load loaded settings or to store results, the "File Manager" must be called up using the **•••** button in the respective panel and a File Select window appears.

4.15.1 Selecting the File Select Window

In the R&S UPV, you can select between two fundamentally different types of "File Select" windows. The desired style can be defined in the menu bar under the button "Utilities", "Config Panel", section "General Configuration", parameter field "File Selector Win Style".

File Selector Win Style

Selects the style in which the "File Select" window is to be displayed.

See ["File Selector Win Style"](#) on page 663

4.15.2 Integrated File Select Window

The File Select window has several sections.

The files last used are listed in the top section "Recent Data Sets", a maximum of ten files are displayed.

The available drives and directories are shown underneath on the left-hand side, and the files in the selected directory are shown on the right-hand side. The currently selected path is displayed above the window. Only the relevant files (without file extensions) are shown. If several files are opened, the path selected last is displayed.

Any file name can be used when saving and creating files; the file extension is, however, assigned automatically and cannot be entered. The file is saved on the selected path.

This panel is operated in the same way as other panels, whereby each section of the "File Select" window is treated as a separate panel: The rotary knob or cursors are used to highlight the desired section and the entry focus is moved to this section by pressing the rotary knob or the Enter key. The rotary knob and up/down cursors then only navigate within this section. The left/right cursor can be used to toggle between the directory tree and the file list. After a brief delay, the subdirectories of the selected directory are displayed to permit fast navigation in the directory tree. Pressing the ESC key moves the entry focus up again by one level. The button used to save or load the file can be highlighted and activated. After the desired operation has been completed, e.g. selection of the file, the menu is closed automatically.

- Loading file:
Highlight the file and load by pressing the rotary knob or activating the Select button/softkey.
- Saving file:
Enter the file name in the "File Name:" field. Highlight the directory in which the file is to be saved and then activate the "Save" button/softkey.
- Creating file:

Enter the file name in the "File Name:" field. Highlight the directory in which the file is to be saved and then activate the "Create" button/softkey. The created file is empty; it has to be filled with the desired values using the associated editor.

4.15.3 File Manager

The File Manager is used to perform general file management tasks, such as copying, moving, renaming and deleting files and creating new directories. This also allows saving externally created files in the R&S UPV by copying them to the internal hard disk from a USB stick, a CD or a network.

The "File Manager" can be called up in all panels in which files can be loaded. It is called up using the "File Manager..." button in the "File Select" window.

Additionally, it is also possible to call up the File Manager via the menu bar.

The file types to be displayed can be selected in the "File Type" section at the top of the File Manager. All files ("All Files (*.*)") or specific file types (e.g. "Waveforms (*.wav)") can be selected. A list of file types is given in the panel at the end of this section.

The available drives and directories are shown underneath on the left-hand side, and the files in the selected directory are shown on the right-hand side. The currently selected path is displayed above the window. If several files are opened, the path selected last is displayed. Unlike the "File Select" window, the File Manager displays the complete file name including the extension.

The buttons/softkeys trigger the assigned action, e.g. copying, moving or deleting the highlighted file. In addition, it is possible to create a new directory in the level below the highlighted directory.

This panel is operated in the same way as other panels, whereby each section of the "File Select" window is treated as a separate panel: The rotary knob or cursors are used to highlight the desired section and the entry focus is moved to this section by pressing the rotary knob or the Enter key. The rotary knob and up/down cursors then only navigate within this section. The left/right cursor can be used to toggle between the directory tree and the file list. After a brief delay, the subdirectories of the selected directory are displayed to permit fast navigation in the directory tree. Pressing the ESC key moves the entry focus up again by one level. The buttons/softkeys can be selected and activated.

- Moving file:
Highlight the file and then activate the "Cut" button/softkey. Highlight the directory to which the file is to be moved and then activate the Paste button/softkey. If a file with the same name already exists in the target directory, a confirmation query appears which the user must acknowledge before the file is overwritten.
- Copying file:
Highlight the file and then activate the "Copy" button/softkey. Highlight the directory to which the file is to be copied and then activate the Paste button/softkey. If a file with the same name already exists in the target directory, a confirmation query appears which the user must acknowledge before the file is overwritten.
- Renaming file:

Highlight the file and then activate the "Rename" button/softkey. A window opens in which the new file name can be entered. Enter the name and press the Enter key. If a file with the same name already exists, a confirmation query appears which the user must acknowledge before the file is overwritten.

- **Deleting file:**
Highlight the file and then activate the "Delete" button/softkey. A confirmation query then appears which the user must acknowledge before the file is deleted.
- **Creating a new directory:**
Highlight the drive or directory level under which the new directory is to be created, and then activate the "Create New Directory" button/softkey. A window opens in which the new directory name can be entered. Enter the name and press the Enter key.

4.15.4 Loading and Saving Instrument Settings

With the menu bar and the button "File", "Load Setup", "Load Example Setup", "Save Setup as", "Save Setup" or "Load Display Plug-in", the "File Select" window is called up.

Instrument settings can also be loaded/saved directly using the LOAD / SAVE keys on the front of the instrument. Pressing these keys opens the "File Select" window.

Every R&S UPV audio analyzer has a range of instrument settings which have been prepared by Rohde & Schwarz for a broad selection of typical measurements and which are available on the instrument as sample setups. These setups are divided into different application areas (AA, AD, DD, DA), depending on whether generator or analyzer is operated with analog or digital interfaces, and are selected via the menu bar, "File" and "Load Example Setup".

This allows users to make settings for their own specific measurement tasks very simply by modifying these example setups.

All of these sample settings are located in the directory D:\UPV\Setup Examples.

Every R&S UPV also features the factory-based default instrument setting. These can be called up directly using the File button on the menu bar or by pressing the PRESET key on the front of the instrument.

4.15.5 List of File Extensions Used

File type	File extension	Meaning
Instrument settings	.SET	Setup file for saving and loading the instrument parameters set by the user ("complete" setup)
	.SAC	Setup file for saving and loading the instrument parameters set by the user ("current" setup)
Equalizer setting	.FTF	Amplitude/frequency table for noise generation in the frequency range

File type	File extension	Meaning
	.VEQ	Equalizer file; loaded in the "Equal File" parameter field of the Generator Function and Analyzer Function panels
Equalizer setting	.SWL	Sweep list for the following: Dwell times for automatic generator sweeps, loaded in the "Dwell File" field of the Generator Function panel Frequency of the generator or of the selective RMS measurement; loaded in the Generator Function panel ("Freq File", "Mean Freq File", "Upper Freq File" fields) or in the Analyzer Function panel ("File Name" field) Burst interval; loaded in the "Interval File" field of the Generator Function panel Burst duration; loaded in the Generator Function panel. On Time File menu item Generator voltage; loaded in the "Volt File" or "Tot Volt File" field (depending on the function) of the Generator Function panel
Files for data or limit lists	.LIM	Limit curve, loaded in the configuration panels for measurement windows under "Limit Upper" and "Limit Lower"
	.TRC	Trace lists for measured values, loaded in the configuration panels for measurement windows
Graphic files	.BMP	Pixel graphic
Other instrument files	.ARB	Time table for generating arbitrary signals
	.AWD	Timetable for generating arbitrary signals in the format of the output file of the Arbitrary Waveform Designer, which was used in the R&S UPL.
	.WAV	Standard format for audio signals to allow processing with PC sound cards
Filter files	.COE	Coefficient file for file-defined filters, loaded in the Filter panel in the "File Name" field
	.NPZ .XPZ .ZPZ	Pole/zero file for file-defined filters, loaded in the Filter panel in the "File Name" field
Audio files	.AC3	Audio file format for the Dolby Digital® (DD) multichannel sound system.
	.EC3	Audio file format for the Dolby Digital Plus® (DD+) multichannel sound system.

4.16 Manual Remote Operation

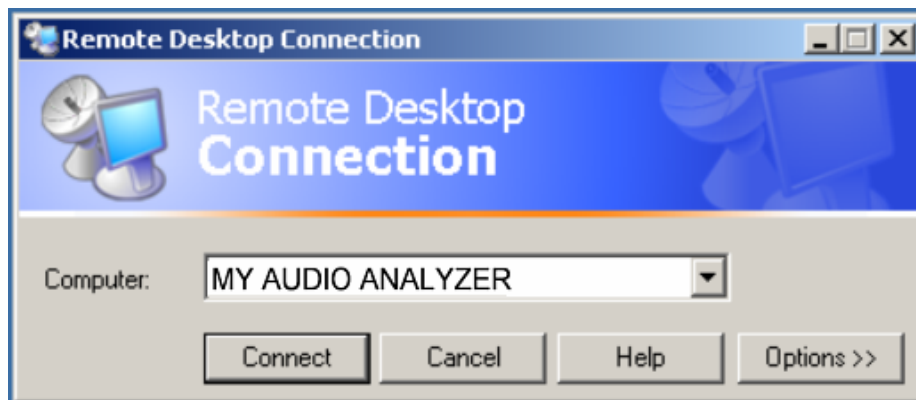
The R&S UPV permits manual remote operation using an external computer. As a result, the audio analyzer can be operated conveniently from the user's desk even if, for example, the audio analyzer is installed in a rack in a different room.

Unlike **remote operation** where remote-control commands are used, the **manual remote operation** requires separate Windows software which is installed on the external computer. When launched, the Windows software **Remote Desktop Connection** simulates the user interface of the R&S UPV. This allows the instrument to be manually operated at the external computer in the same way as at the instrument itself.

Manual remote operation is only possible if the audio analyzer and computer are connected via LAN and the Windows software is installed on the computer.

Establishing the connection and installation of the remote-control software on the external PC is described in [chapter 2.10.4, "Configuration for manual remote operation"](#), on page 80.

Manual remote operation is started on the external computer by calling up the Remote Desktop Connection program and clicking on the Connect button. The R&S UPV must be selected as the remote operation device, i.e. its computer name must be displayed in the Computer: If the computer has been configured for remote operation of more than one instrument, the desired instrument can be selected from the list which is displayed by clicking the button. The user ID and password (**instrument** in both cases) can be stored when the software is first installed. The entry is possible in the expanded "Options>>" menu.



After logon, the instrument firmware of R&S UPV boots on the external computer. After the completion of the boot process, the screen of the audio analyzer appears and the R&S UPV can be manually remote-controlled from the external computer. The starting configuration is that which was active before the connection was set up. The individual functions are operated using the mouse and panel. Front panel keys which are not directly available on the panel may be replaced by shortcuts (see [chapter 4.18, "Overview of Keys"](#), on page 229).

When establishing the connection, the instrument firmware at the R&S UPV is exited. During the manual remote control, it is not possible to perform any operations at the R&S UPV itself. Access by an external computer and the identity of the remote user is indicated on the login display of Windows.

To return to direct operation at the R&S UPV, it is necessary to log off the external user and log on the local user.

The external user can be logged off at the external computer in the "Start" menu of the R&S UPV window by clicking on "Disconnect" in the bottom right menu area.

Logging off is also possible directly at the R&S UPV in the remote control window.

The local user can be logged on at the R&S UPV in the remote control screen only after pressing the shortcut Ctrl + Alt + Del. By default, the R&S UPV uses **instrument** for this user name, and the password is also **instrument**.

After login, the instrument software starts with the settings used for manual remote operation.

4.17 Units

The R&S UPV features two types of units:

- **Units for measurement result display:**
In the configuration panels for the measurement displays, a display unit must be selected for each measurement function. This unit is then used for the measurement result displayed in the measurement display windows. The unit is selected in the Unit fields of the respective panel.
- **Units for value entries** (e.g. reference values, frequencies, levels, etc.):
When data is entered, the available units are displayed on the softkeys. This allows value entries to be adopted by selecting the unit without a further entry window having to be opened.

4.17.1 Units in Measurement Result Displays

To simplify matters: In the following conversion formulas, the entry values are designated by the unit only. Example: "dBu" means: value in "dBu".

4.17.1.1 Units for analog level measurement results

Basic unit: V

Value in	IEC/IEEE-bus notation	Conversion formula
V	V	
dBV	DBV	$20 \times \lg(V)$
dBu	DBU	$20 \times \lg(V/0.7745967)$
dBm	DBM	$10 \times \lg(V^2 \times 1000/R_{REF})$
W	W	V^2/R_{REF}
$\Delta\%V$	DPCTV	$(V/U_{REF}-1) \times 100$
ΔV	DV	$V-U_{REF}$
V/Vr	VVR	V/U_{REF}
$\%V/Vr$	PCTVVR	$100 \times V/U_{REF}$
$\Delta\%W$	DPCTW	$((V^2/R_{REF})/P_{REF}) \times 100/P_{REF}$
ΔW	DW	$(V^2/R_{REF}) - P_{REF}$
P/Pr	PPR	$(V^2/R_{REF})/P_{REF}$
$\%P/Pr$	PCTPPR	$(V^2/R_{REF})/P_{REF} \times 100$
dBr	DBR	$20 \times \lg(V/U_{REF})$

R_{REF} = Reference impedance (Ref Imped) from *Analyzer Config* panel

U_{REF} = Reference level (Reference) from *Config* panel for measurement function

P_{REF} = $(U_{REF})^2/R_{REF}$

4.17.1.2 Units for digital level measurement results

Basic unit: FS (Full Scale)

Value in	IEC/IEEE-bus notation	Conversion formula
FS	FS	
$\%FS$	PCTFS	$FS \times 100$
dBFS	DBFS	$20 \times \lg(FS)$
Hex *)	HEX	$FS \times (2^{\text{Audiobits}-1})$ for FS > 0 $FS \times (2^{\text{Audiobits}-1}) + (2^{\text{Audiobits}-1})$ for FS < 0
$\Delta\%$	DPCT	$(FS/U_{REF}-1) \times 100$
dBr	DBR	$20 \times \lg(FS/U_{REF})$
LSBs	LSBS	$FS \times 2^{\text{Audiobits}-1}$
bits	BITS	$1 + \lg(FS \times 2^{\text{Audiobits}-1})$

U_{REF} = Reference level (Reference) from *Config* panel for measurement function

*) Level measurement result in hex notation

All digital analyzer measurement functions usually deliver values ranging from 0 to 1 FS.

FS values >1 may occur in the following cases:

- In the case of the "Peak" measurement function with "Meas Mode" "Peak to Peak"
- In the case of a filter with gain (e.g. CCIR wtd) is used.

4.17.1.3 Units for distortion measurement results

Basic unit: %

Value in	IEC/IEEE-bus notation	Conversion formula
%	PCT	
dB	DB	$20 \times \lg (\% / 100)$

In the case of SINAD: $-20 \times \lg (\% / 100)$

4.17.1.4 Unit for S/N measurement results

Value in	IEC/IEEE-bus notation	Formula
dB	DB	$20 \times \lg(S/N)$

S: Measurement level with activated generator
N: Measurement level with deactivated generator

4.17.1.5 Units for frequency measurement results

Basic unit: Hz

Value in	IEC/IEEE-bus notation	Conversion formula
Hz	HZ	
Δ Hz	DHZ	$\text{Hz} - F_{\text{REF}}$
$\Delta\%$ Hz	DPCTHZ	$100 \times (\text{Hz} - F_{\text{REF}}) / F_{\text{REF}}$
Toct *	TOCT	$\lg (\text{Hz} / F_{\text{REF}}) \times 9.96578$
Oct	OCT	$\lg (\text{Hz} / F_{\text{REF}}) \times 3.32193$
Dec	DEC	$\lg (\text{Hz} / F_{\text{REF}}^2)$
f/fr	FFR	$\text{Hz} / F_{\text{REF}}$

*) Toct = Third octave

F_{REF} = Reference frequency (Ref Freq) from *Freq Phase Config* panel for frequency measurement

4.17.1.6 Units for phase measurement results

Basic unit: ° (degrees)

Value in	IEC/IEEE-bus notation	Conversion formula
°	DEG	
RAD	RAD	$^{\circ} \times \pi / 180$
Δ°	DDEG	$^{\circ} - P_{\text{REF}}$
Δ RAD	DRAD	$(^{\circ} - P_{\text{REF}}) \times \pi / 180$

P_{REF} = Reference phase (Ref Phase) from *Freq Phase Config* panel for phase measurement

4.17.1.7 Units for group delay measurement results

Basic unit: s

Value in	IEC/IEEE-bus notation	Conversion formula
s	S	
Δs	DS	$s - T_{REF}$

T_{REF} = Reference time (Ref Grp Del) from *Freq Phase Config* panel for group delay measurement

4.17.1.8 Units for digital jitter measurement results

Basic unit: UI (unit interval)

Value in	IEC/IEEE-bus notation	Conversion formula
UI	UI	
%UI	PCTUI	$100 \times UI$
dBUI	DBUI	$20 \times \log (UI)$
ppm	PPMUI	$10^5 \times UI$
ns	NS	$10^9 \times UI / (128 \times \text{sampling frequency})$
dB _r	DBR	$20 \times \log (UI/U_{REF})$
UI _r	UIR	UI/U_{REF}

U_{REF} = Reference level (Reference) from *Config* panel for measurement function

4.17.1.9 Unit for digital phase measurement results (Phase to Ref)

Basic unit: UI (unit interval)

Value in	IEC/IEEE-bus notation	Conversion formula
UI	UI	
%FRM	PCTFRM	$100 \times UI / 128$
*FRM	DEGFRM	$360 \times UI / 128$
ns	NS	$10^9 \times UI / (128 \times \text{sampling frequency})$

4.17.2 Units for Value Entries

To simplify matters: In the following conversion formulas, the entry values are designated by the unit only. Example: "dBu" means: value in "dBu".

Absolute analog level units (without reference)

Conversion formulae	IEC/IEEE-bus notation
V, mV, μV	V, MV, UV
V _{pp} , mV _{pp} , μV _{pp} (peak-to-peak voltage of signal)	V _{PP} , MV _{PP} , UV _{PP}
dBu = $20 \times \lg (V/0.7746)$	DBU
dBV = $20 \times \lg (V)$	DBV
dBm = $10 \times \lg (V^2 \times 1000/R_{REF})$ *	DBM
W = V^2/R_{REF}	W, MW, UW

R_{REF} = Reference impedance (Ref Imped) from the *Analyzer Config* panel

*) In the case of the generator, the reference impedance R_{REF} is always 600 Ohm. The IEC/IEEE-bus notation is DBMG. To calculate the open-circuit voltage V_o , the source impedance R_s (Impedance) from the *Generator Config* panel is also taken into account, which means that $V = V_o \times R_{REF} / (R_s + R_{REF})$ is to be used in the above formula.

Relative analog level units (with reference)

Conversion fomulae		IEC/IEEE-bus notation
$\Delta V = V - U_{REF}$	$V = \Delta V + U_{REF}$	DV, DMV, DUV
$\Delta \%V = (V/U_{REF} - 1) \times 100$	$V = U_{REF} \times (1 + \Delta \%V/100)$	DPCTV
$VNr = V/U_{REF}$	$V = VNr \times U_{REF}$	VWR
$dBr = 20 \times \lg (V/U_{REF})$	$V = 10^{(dBr/20)} \times U_{REF}$	DBR
$V/on = V/Burst\ amp[V]$	$V = V/on \cdot Burst\ amp[V]$	VON
$\%on = 100 \cdot V/Burst\ amp[V]$	$V = \%on \cdot Burst\ amp[V]/100$	PCTON
$dBon = 20 \cdot \lg (V/Burst\ amp[V])$	$V = 10^{(dBon/20)} \cdot Burst\ amp[V]$	DBON

U_{REF} = Reference level (Ref Voltage) in V from the *Generator Config* panel

Absolute digital level units (without reference)

Conversion fomulae		IEC/IEEE-bus notation
FS		FS
$bits = 1 + \lg (FS \times 2^{Audio\ bits-1})$	$FS = 2^{bits-1} / 2^{Audio\ bits-1}$	BITS
$\%FS = 100 \times FS$	$FS = \%FS/100$	PCTFS
$dBFS = 20 \times \lg (FS)$	$FS = 10^{(dBFS/20)}$	DBFS
$LSBS = FS \times 2^{Audio\ bits-1}$	$FS = LSBS / 2^{Audio\ bits-1}$	LSBS

Relative digital level units (with reference)

Conversion fomulae		IEC/IEEE-bus notation
$dBr = 20 \times \lg (FS/U_{REF})$	$FS = 10^{(dBr/20)} \times U_{REF}$	DBR
$\Delta \% = 100 \times (FS/U_{REF} - 1)$	$FS = (\Delta \% / 100 + 1) \times U_{REF}$	DPCT
$\%on = 100 \times FS/Burst\ amp[FS]$	$FS = \%on \times Burst\ amp[FS]/100$	PCTON
$dBon = 20 \times \lg (FS/Burst\ amp[FS])$	$FS = 10^{(dBon/20)} \times Burst\ amp[FS]$	DBON

U_{REF} = Reference level (Ref Voltage) in FS from the *Generator Config* panel

Absolute time units

Conversion fomulae		IEC/IEEE-bus notation
s		S, MS, US
min = 60 s	s = min / 60	MIN
cyc = s * signal frequency	s = cyc / signal frequency	CYC, KCYC, MCYC

Absolute frequency units

Conversion fomulae		IEC/IEEE-bus notation
Hz, kHz		HZ, KHZ

Relative frequency units (with reference)

Conversion formulae		IEC/IEEE-bus notation
$\Delta\text{Hz} = \text{Hz} - F_{\text{REF}}$	$\text{Hz} = \Delta\text{Hz} + F_{\text{REF}}$	DHZ, DKHZ
$f/\text{fr} = \text{Hz}/F_{\text{REF}}$	$\text{Hz} = f/\text{fr} \times F_{\text{REF}}$	FFR
$\Delta\%\text{Hz} = 100 \times (\text{Hz} - F_{\text{REF}})/F_{\text{REF}}$	$\text{Hz} = (\Delta\%\text{Hz}/100 + 1) \times F_{\text{REF}}$	DPCTHZ
$\text{Toct} = \lg(\text{Hz}/F_{\text{REF}}) \times 9.96578$	$\text{Hz} = 2^{\text{Toct}/3} \times F_{\text{REF}}$	TOCT
$\text{Oct} = \lg(\text{Hz}/F_{\text{REF}}) \times 3.32193$	$\text{Hz} = 2^{\text{Oct}} \times F_{\text{REF}}$	OCT
$\text{Dec} = \lg(\text{Hz}/F_{\text{REF}})$ (Toct = Third octave)	$\text{Hz} = 10^{\text{Dec}} \times F_{\text{REF}}$	DEC

F_{REF} = Reference frequency (Ref Frequency) from the *Generator Config* panel

Absolute phase units

Conversion formulae		IEC/IEEE-bus notation
°		DEG
$\text{rad} = \text{°} \times (\pi/180)$	$\text{°} = \text{rad} \times (180/\pi)$	RAD

Deviations (tolerance) relative to previous measured values in settling function

Conversion formulae		IEC/IEEE-bus notation
$\% = (10^{\text{dB}/20} - 1) \times 100$	$\text{dB} = 20 \times \lg(\%/100 + 1)$	DB, PCT

Step size of a logarithmic level sweep

Conversion formulae		IEC/IEEE-bus notation
$\text{MLT} = 10^{\text{dB}/20}$	$\text{dB} = 20 \times \lg(\text{MLT})$	[MLT], DB

Absolute resistance unit

Conversion formulae		IEC/IEEE-bus notation
Ω		OHM, KOHM

Unit for jitter

Conversion formulae		IEC/IEEE-bus notation
UI		UI
$\%\text{UI} = 100 \times \text{UI}$	$\text{UI} = \%\text{UI} / 100$	PCTUI
$\text{dBUI} = 20 \times \log(\text{UI})$	$\text{UI} = 10^{\text{dBUI}/20}$	DBUI
$\text{ppm} = 10^6 \times \text{UI}$	$\text{UI} = 10^{-6} \times \text{ppm}$	PPMUI
$\text{ns} = 10^9 \times \text{UI} / (128 \times \text{sampling frequency})$	$\text{UI} = 128 \times \text{sampling frequency} \times 10^{-9} \times \text{ns}$	NS

Unit for Phase to Ref

Conversion fomulae		IEC/IEEE-bus notation
UI		UI
$\%FRM = 100 \times UI / 128$	$UI = 128 \times \%FRM / 100$	PCTFRM
${}^{\circ}FRM = 360 \times UI / 128$	$UI = 128 \times {}^{\circ}FRM / 360$	DEGFRM
$ns = 10^9 \times UI / (128 \times \text{sampling frequency})$	$UI = 128 \times \text{sampling frequency} \times 10^{-9} \times ns$	NS

4.18 Overview of Keys

The following table gives an overview of the key functions on the front panel. The table also gives the PC keyboard shortcuts which can be used to trigger the functions of the keys on the front of the instrument. Details regarding mouse operation are also included in this column.

The table is sorted according to the function blocks on the front panel.

Table 4-1: Softkeys

Key on front panel	Key of the PC keyboard Operation with mouse	Function
"Softkeys F5 to F12"	F5 to F12	Triggers the function assigned to the softkey.

Table 4-2: CONTROL panel

Key on front panel	Key of the PC keyboard Operation with mouse	Function
START	CTRL + F5	Starts continuous measurements and sweeps Resets the Min/Max values for bar graph displays, averaging for measurement results, and limit overranging
SINGLE	CTRL + F6	Starts a single measurement or a single sweep
STOP/CONT	CTRL + F7	Measurement / sweep is stopped or continued (toggle function)
ON	CTRL + F8	Switches the loudspeaker or connected headphones on and off (toggle function)
Volume	CTRL + F9	Opens / closes the window for adjusting the audio monitoring volume
HCOPY	CTRL + P	Depending on the settings under Utilities, printout of the screen contents on the connected printer is started or the screen contents are stored in a file

Key on front panel	Key of the PC keyboard Operation with mouse	Function
SHUT DOWN	CTRL + F10	Stores the current settings on the hard disk and then shuts down the Windows® operating system
LOCAL	CTRL + F11	Switches the instrument from remote operation to manual operation
OUTPUT	CTRL + F12	Switches the outputs of the measuring instrument off or on again (toggle function)

Table 4-3: Navigation keys

Key on front panel	Key of the PC keyboard Operation with mouse	Function
SCREEN cursor	CTRL+PAGE UP / CTRL + PAGE DOWN	Switches to the previous / next display setting (screen)
WINDOW cursor	CTRL+SHIFT+TAB (left) / CTRL+TAB (right)	Switches the focus to the previous / next panel open in the visible screen (the panel with the focus is active)
SCAN cursor	ALT+PAGE UP / ALT * PAGE DOWN	Changes to the previous / next scan in graphical displays so that, for example, measured values can be read off using the cursor
PAGE cursor	PAGE DOWN / PAGE UP	Scrolls to the next/previous page in tables

Table 4-4: Data entry keys

Key on front panel	Key of the PC keyboard Operation with mouse	Function
1 to 9 A to Z	1...9 a to z	Number entry: 1...9 Letter entry: a to z
0 SPACE	0 SPACE	Number entry: 0 Entry of a space
. * ... #	. * ... #	Entry of a period / decimal point; Entry of special characters
+/- A -> a	- (SHIFT +) A to Z	Entry of sign; Switchover between uppercase and lowercase letters

Table 4-5: VARIATION panel

Key on front panel	Key of the PC keyboard Operation with mouse	Function
MENU	CTRL + M	Displays the menu bar on the screen
UNDO	BACKSPACE	Deletes the character to the left of the cursor Undoes the action last performed
ESC	ESC	Closes the open panel; the old value or parameter is retained
ENTER	ENTER Left-click Pressing mouse wheel	Completes the data entry (the new value is adopted); confirms and closes open entry windows
ROTARY KNOB	TAB (to the right) SHIFT+TAB (to the left) Turn mouse wheel	Moves the focus in the panels, selection windows and tables Varies the entry value at the cursor position Moves the active cursor in the graphical windows Switches the measuring steps forwards and backwards for manual sweeps
Rotary knob click	ENTER	Pressing the rotary knob has the same effect as pressing the ENTER key
CURSOR UP/DOWN	UP/DOWN cursor keys	Move the focus in the panels, selection windows and tables Change the entry value at the cursor position
CURSOR LEFT/RIGHT	LEFT/RIGHT cursor keys	Move the active cursor inside the graphical windows Move the cursor position in entered values Switch the measuring steps forwards and backwards for manual sweeps

Table 4-6: WINDOW and SETUP panels

Key on front panel	Key of the PC keyboard Operation with mouse	Function
WINBAR	ALT + W	Toggles between the softkey bar and the WINBAR
MODIFY	ALT + M	Opens a selection of functions on the softkey bar; these functions can be used in conjunction with the rotary knob to move or resize the active panel or graphical window

Overview of Panels and Measurement Displays (Graphical Windows)

Key on front panel	Key of the PC keyboard Operation with mouse	Function
HIDE	ALT + H	Minimizes ("hides") the active panel or graphical window
CLOSE	ALT + C	Closes the active panel or graphical window
HELP	F1	Opens and closes the context-sensitive help function
SAVE	ALT + S	Opens a panel for storing instrument settings
LOAD	ALT + L	Opens a panel for loading predefined instrument settings
PRESET	ALT + P	Loads the factory settings of the instrument

4.19 Overview of Panels and Measurement Displays (Graphical Windows)

Panels which can be selected via the Instruments menu bar button:

Generator Config	<ul style="list-style-type: none"> • Selection of instrument (analog or digital interfaces) • Configuration of channels • Bandwidth and sampling rate • Reference values • Synchronization settings and word length (for digital interfaces)
Generator Function	<ul style="list-style-type: none"> • Selection of test signals • Sweep function • Frequency and level settings • Filter and equalizer
Analyzer Config	<ul style="list-style-type: none"> • Selection of instrument (analog or digital interfaces) • Configuration of channels • Measurement bandwidth and sampling rate • Reference impedance • Start and trigger conditions
Analyzer Function	<ul style="list-style-type: none"> • Selection of measurement functions • Measurement speed and accuracy • Activation of filter and equalizer • Activation of Post FFT • Selection and settings for level monitor • Selection and settings for input monitor • Selection and settings for frequency, phase, group delay measurement • Selection and settings for waveform monitor
Filter	<ul style="list-style-type: none"> • Definition of filter properties

Overview of Panels and Measurement Displays (Graphical Windows)

Auxiliaries	<p>Audio monitoring function</p> <ul style="list-style-type: none"> • Settings for integrated loudspeaker and connected headphones • Signal source and channels • Volume • ON/OFF and volume control also possible using keys in CONTROL panel <p>Auxiliary Analog Output</p> <ul style="list-style-type: none"> • Function selection and settings <p>Trigger Input, Trigger Output</p> <ul style="list-style-type: none"> • Function selection and settings
Switcher Panel	<ul style="list-style-type: none"> • Function settings and operation of one or more connected Audio Switchers R&S UPZ.
Protocol Generator	<ul style="list-style-type: none"> • Settings for the generator functions for generating the digital audio protocol of the R&S UPV-K21 option (digital audio protocol).

Panels which can be selected via the Disp Config menu bar button

Function Config	<ul style="list-style-type: none"> • Settings for measured values of active measurement function in numeric display field • Settings for associated combo displays • Settings for limits, minimum values and maximum values
Level Monitor Config	<ul style="list-style-type: none"> • Settings for numeric measured values of level monitor in numeric display field • Settings for associated combo displays • Settings for limits, minimum values and maximum values
Input Config	<ul style="list-style-type: none"> • Settings for measured values of input monitor in numeric display field • Settings for associated combo displays • Settings for limits, minimum values and maximum values
Freq Phase Config	<ul style="list-style-type: none"> • Settings for measured values of frequency, phase and group delay measurement in numeric display field • Settings for associated combo displays • Settings for limits, minimum values and maximum values
Sweep Graph 1 to 4 Config	<ul style="list-style-type: none"> • Four of these panels are available so that up to 4 sweep graphical windows can be displayed simultaneously • Setting of all details for one-channel or two-channel graphical display of sweep functions, e.g. units, scaling, gridlines, etc. • Evaluation of minimum and maximum values • Entry of limit curves • Settings for cursors and markers
Impulse Response	<ul style="list-style-type: none"> • Setting of all details for graphical display of impulse response, e.g. number of curves, units, scaling, gridlines, etc. • Entry of limit curves • Settings for cursors and markers
FFT Graph 1 to 2 Config	<ul style="list-style-type: none"> • Two of these panels are available so that up to 2 FFT graphical windows can be displayed simultaneously • Setting of all details for one-channel or two-channel display of FFT graph, e.g. units, scaling, gridlines, etc. • Evaluation of minimum and maximum values • Entry of limit curves • Settings for cursors and markers
Waveform Config	<ul style="list-style-type: none"> • Setting of all details for graphical display of waveform analyzer, e.g. number of curves, units, scaling, gridlines, etc. • Entry of limit curves • Settings for cursors and markers

Overview of Panels and Measurement Displays (Graphical Windows)

PESQ/POLQA Graph 1...2 Config	<ul style="list-style-type: none"> • Two of these panels are available, allowing you to display up to two PESQ/POLQA windows simultaneously • Setting of all details for the display of the PESQ or MOS value and the DELAY, e.g. units, scaling, gridlines, etc. • Evaluation of minimum and maximum values • Entry of limits • Settings for cursors and markers
Bar Graph 1 to 2 Config	<ul style="list-style-type: none"> • Two of these panels are available so that up to 2 bar graph windows can be displayed simultaneously • Setting of all details for one-channel or two-channel display of bar graphs, e.g. units, scaling, gridlines, etc. • Evaluation of minimum and maximum values • Entry of limits • Settings for cursors and markers

Measurement windows which can be selected via the Displays menu bar button:

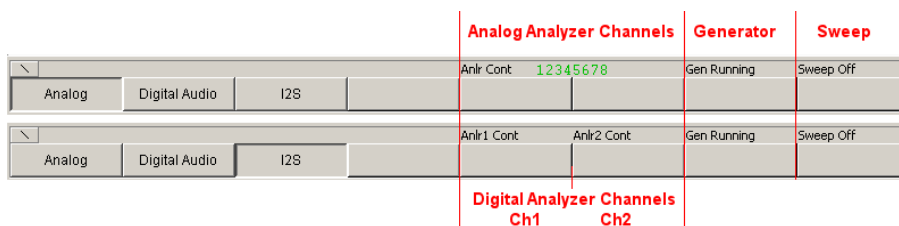
Numeric Display	<ul style="list-style-type: none"> • Display of measurement results for measurement function selected in the "Analyzer Function" panel • Display of measurement results for level monitor selected in the "Analyzer Function" panel • Display of measurement results for input monitor selected in the "Analyzer Function" panel • Display of frequency measurement results or frequency measurement result and phase or group delay measurement results • The measurement results are displayed in the way defined in the configuration panel
Funct Ch1 to 2 Funct ...	<ul style="list-style-type: none"> • These combo displays are extensions to the numeric measurement displays of the measurement function selected in the "Analyzer Function" panel; they show the respective numeric value plus the following additional features: <ul style="list-style-type: none"> • Analog bar graphs • Monitoring and display of limits • Storage of minimum and maximum values • The measurement results are displayed in the way defined in the configuration panel
Lev Mon Ch1 to 2 Lev Mon ...	<ul style="list-style-type: none"> • These combo displays are extensions to the numeric measurement display of the level monitor selected in the "Analyzer Function" panel; they show the respective numeric value plus the following additional features: <ul style="list-style-type: none"> • Analog bar graphs • Monitoring and display of limits • Storage of minimum and maximum values • The measurement results are displayed in the way defined in the configuration panel
Input Ch1 to Ch2 Input ...	<ul style="list-style-type: none"> • These combo displays are extensions to the numeric measurement display of the input monitor selected in the "Analyzer Function" panel; they show the respective numeric value plus the following additional features: <ul style="list-style-type: none"> • Analog bar graphs • Monitoring and display of limits • Storage of minimum and maximum values • The measurement results are displayed in the way defined in the configuration panel

Freq Ch1 Phase Ch2/Ch1 Freq/Phase ...	<ul style="list-style-type: none"> • These combo displays are extensions to the numeric measurement display of the frequency/phase measurement selected in the "Analyzer Function" panel; they show the respective numeric value plus the following additional features • Analog bar graphs • Monitoring and display of limits • Storage of minimum and maximum values • The measurement results are displayed in the way defined in the configuration panel
Sweep Graph 1 to 4	<ul style="list-style-type: none"> • Up to four of these display windows can be open simultaneously to display scans from sweep measurements • One-channel or two-channel graphical display • The measurement results are displayed in the way defined in the respective "Sweep Graph 1 to 4 Config" configuration panel
Impulse Response	<ul style="list-style-type: none"> • This display window shows the characteristic of an impulse response • One-channel or two-channel graphical display • The measurement results are displayed in the way defined in the "Impulse Response Config" configuration panel
FFT Graph 1 to 2	<ul style="list-style-type: none"> • Up to two of these display windows can be open simultaneously to display the FFT analyses of the selected measurement function or of the Post FFT • One-channel or two-channel graphical display • The measurement results are displayed in the way defined in the respective "FFT Graph 1 to 2 Config" configuration panel
Waveform	<ul style="list-style-type: none"> • This display window shows the characteristic of the measurement signal over time • One-channel or two-channel graphical display • The measurement results are displayed in the way defined in the "Waveform Config" configuration panel
PESQ/ POLQA Graph 1...2	<ul style="list-style-type: none"> • Up to two of these windows can be opened simultaneously to display PESQ/POLQA measured values • The measurement results are displayed in the manner defined in the respective "PESQ/POLQA Graph 1...2 Config" configuration panel.
Bar Graph 1 to 2	<ul style="list-style-type: none"> • Up to two of these display windows can be opened to display bar graphs of the selected measurement function • One-channel or two-channel graphical display • The measurement results are displayed in the manner defined in the respective "Bar Graph 1 to 2 Config" configuration panel
Dig Analyzer Protocol	<ul style="list-style-type: none"> • Display window for the data regarding the digital audio protocol of the R&S UPV-K21 option (digital audio protocol)

4.20 Overview of Status Messages

The status of the R&S UPV is continuously displayed for the generator, analyzer, sweep system and other instrument states at the bottom of the screen in four fields above the four right-hand softkeys.

Status displays always appear at the same position; they are assigned to the fields above the softkeys as shown below.



The following overview shows the possible status messages and their meaning:

Analyzer status - Status information which applies to the two channels Anlr1 and Anlr2

Off	Measurement channel is deactivated
Overload	Analyzer has been deactivated due to overload
Over	Measuring range has been overranged; this can occur if: <ul style="list-style-type: none"> • Range Fix setting is being used • A signal with a level at range limit is applied with a crest factor > 2 • Common-mode voltage is applied in BAL input configuration
Under	Measuring range has been underranged; this can occur if Range Fix or Lowest setting is being used
Single	Single measurement is being performed
Cont	Continuous measurement is being performed
Terminated	Single measurement has been terminated
Stopped	Measurement has been stopped
Wait for Trigger	Analyzer is waiting for set trigger condition

Generator status

Gen Off	Generator is deactivated
Gen Running	Generator signals are being output
Output Off	All output lines are deactivated
Gen Overload	Generator has been deactivated owing to overload

Sweep status

Sweep Off	No sweep is being performed
Sweep Waiting	Sweep has been defined but not yet started
Sweep Terminated	Single sweep has been terminated
Sweep Stopped	Sweep has been stopped but can be continued
Sweep Run Cont	Continuous sweep is being performed
Sweep Run Single	Single sweep is being performed
Sweep Run Manual	Manual sweep is being performed

5 Instrument Functions

5.1 Selecting the Generator

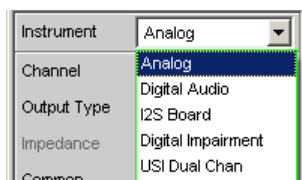
5.1.1 Generator Configuration Panel

The Configuration panel allows settings for the analog and digital generators.

To adapt the R&S UPV generator to the measurement task at hand, first define the settings in the Generator Config panel. These settings will determine which capabilities are available in the Generator Function panel.

Instrument

Used to select the generator.



- "Analog" Select analog 2-channel generator
In the Generator Function panel, the user can choose between the universal generator for almost any signal forms (up to max. 80 kHz) and a low-distortion sinus generator (option R&S UPV-B1 Low Distortion Generator up to max. 185 kHz). This can be activated for the generator function Sine.
The digital audio generator continues to run.
- "Digital Audio" Select digital audio generator.
Generating audio data in AES/EBU or SPDIF format.
If no impairments were applied (jitter or a common-mode signal), the analog generator continues to run.
- "I²S Board" Select I²S generator
The I²S generator can generate audio data in I²S format.
The analog generator is switched off.
- "Digital Impairment" (only with R&S UPV-B2 (digital audio interfaces))
In this panel, the impairments (jitter or a common-mode signal) are configured for the digital audio generator (see [chapter 5.3.2, "Digital Impairments Configuration Panel"](#), on page 258), which can then be switched on or off in the control panel of the digital generator (see [chapter 5.3.1, "Digital Generator Configuration Panel"](#), on page 250).
As soon as this panel is opened, the analog generator is switched off, as it is used internally for generating the impairments.

"USI Dual Chan" Audio data can be produced in serial format with the USI dual channel generator.
The analog generator is switched off.

Remote command:

`INSTRument<n1>` on page 855

5.2 Configuring Analog Generator

5.2.1 Analog Generator Config Panel

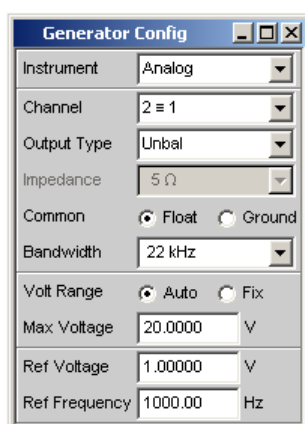
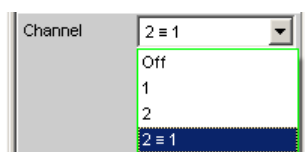


Fig. 5-1: Analog generator configuration panel

The configuration options for the analog generator are described below.

Channel

Selection of the signal-carrying XLR **plugs** on the front panel of the R&S UPV.



"OFF" Both XLR plugs are deactivated.
 "1" XLR plug 1 supplies the generator signal; XLR plug 2 is deactivated.
 "2" XLR plug 2 supplies the generator signal; XLR plug 1 is deactivated.
 "2 = 1" Both XLR plugs supply an output signal.

Note: If the generator function Stereo Sine is selected (in the Generator Function panel; the R&S UPV-B3 option is required for this purpose), the output signal may differ with regard to level and frequency.

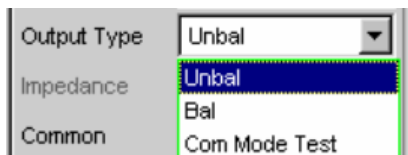
Remote command:

`OUTPut:CHANnel` on page 857

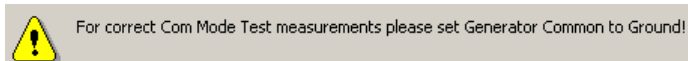
Output Type

The generator output can be configured as unbalanced (Unbal) or balanced (Bal). The setting always applies to both outputs.

The generator can also supply a common-mode signal with the "Com Mode Test" setting.



- "Unbal" The RMS value of the generator signal can be max. 10 V. The output impedance is 5Ω. To be able to work with commercially available BNC cables, we recommend using an R&S UP-Z1F XLR/BNC adapter.
- "Bal" The RMS value of the generator signal can be max. 20 V. You can select between three different values for the output impedance.
- "Com Mode Test" Identical output signals are present at pins 2 and 3 of the XLR connectors. The reference is the generator ground. The output impedance is made up of two identical resistances in the two signal lines. This generator output configuration is suitable for measuring the common-mode rejection of balanced DUTs. To correctly address the DUT, it is necessary to set the generator earth (Common) to "Ground" because otherwise the input signal has no ground reference and is not detected by the DUT. If "Common" is set to "Float", the following warning appears:



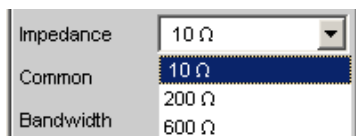
This function is available only for firmware version 1.4.0.206 or higher. If this operator field does not appear even though the firmware version is this one or a newer one, the R&S UPV is equipped with an older analog audio board (AAB) that does not yet support this function.

Remote command:

[OUTPut:TYPE](#) on page 858

Impedance

This field is only available if "Output Type Bal" has been selected above it. If Unbal is selected, only a field showing the fixed impedance (5 Ω in this case) is displayed.



- "10 Ω" The output impedance is 10Ω.

"200 Ω" The output impedance is 200Ω. If the R&S UPV-U1 option is installed, the output impedance is 150 Ω instead. So that after installation the R&S UPV-U1 option shows the label 150 Ω in the selection box, the R&S UPV must be notified of this via the diagnostic panel. The installation instructions supplied with the option explain which entries are required for this.

"600 Ω" The output impedance is 600Ω.

Remote command:

[OUTPut:IMPedance](#) on page 857

[OUTPut:IMPedance:UNBalanced?](#) on page 859

Common

The generator ground can be floating or connected to the instrument ground.

XLR Pin 1 always remains unconnected, regardless of the selected configuration.



"Float" The generator ground does not have a galvanic connection to the instrument ground. For the output configuration Unbal, a capacitance of approx. 25 nF is connected between the two grounds. For Bal, the capacitance is approx. 2 nF and is determined primarily by the design and coupling capacitance within the ring core transformer, which provides the supply voltages for the generator.

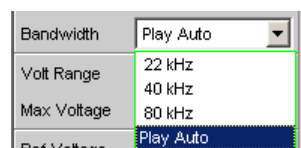
"Ground" The generator ground has a galvanic connection of approx. 50 Ω to instrument ground.

Remote command:

[OUTPut:LOW](#) on page 857

Bandwidth

When you choose the universal generator you can set three different fixed frequency ranges and one signal-dependent sampling frequency.



"22 kHz" The maximum output frequency is 21.75 kHz. The generator DAC is clocked at 48 kHz.

"40 kHz" The maximum output frequency is 40 kHz. The generator DAC is clocked at 96 kHz.

"80 kHz" The maximum output frequency is 80 kHz. The generator DAC is clocked at 192 kHz.

"Play Auto" For the Play generator function only. The bandwidth is automatically determined as a function of the sample rate entered in the WAV file. This sample rate is likewise used for clocking the generator DAC.

Remote command:

[OUTPut:BANDwidth:MODE](#) on page 857

Volt Range

Two different modes are available for generator level control.



- "Auto" The internal signal paths are optimally driven; the output voltage is adjusted using the analog hardware.
Advantage:
 Optimum noise and distortion values.
- "Fix" The analog hardware is permanently set to the specified maximum voltage. The actual output voltage is obtained by controlling the level of the D/A converter; the analog hardware settings remain unchanged.
Advantage:
 Faster level changes and better settling characteristics. Voltage dips when switching over the attenuator are avoided as no relays are connected.
- Note:** This setting is ignored if the Low Distortion Generator option (R&S UPV-B1) is used. In this case, the level is always determined according to the "Auto" algorithm.
 If the Volt Range = Fix setting is chosen for the signal to noise measurement, the generator level does indeed oscillate more rapidly, but in certain cases the lowest possible noise level may not be obtained. This restricts the dynamic range of the signal to noise measurement.

Remote command:

[SOURce:VOLTage:RANGe](#) on page 858

Max Voltage

Maximum value for the output voltage; prevents excessively high voltage values from being entered inadvertently in the Generator Function panel.

It is not possible to configure a higher voltage in the Generator Function panel than the one specified here.



The RMS value for sinusoidal signals is entered, i.e. the maximum peak value is higher by a factor of $\sqrt{2}$.

Remote command:

[SOURce:VOLTage:MAXimum](#) on page 858

Ref Voltage

Reference value for the relative voltage units.

If the reference level is changed, all voltage settings linked to the reference value also change.

The relative voltage of the generator signal remains unchanged.

By varying the reference voltage, a level sweep defined with relative start and stop levels, for example, can be shifted by a constant "gain factor".

Ref Voltage	1.00000	V
-------------	---------	---

Remote command:

[SOURce:VOLTage:REFerence](#) on page 856

Ref Frequency

Reference value for the relative frequency units.

If the reference frequency is changed, all frequency settings linked to the reference value also change.

The relative frequency of the generator signal remains unchanged. By varying the reference frequency, the fundamental of a distortion spectrum set using a multi-sinewave, for example, can thus be shifted without the harmonics having to be calculated and set again by the user.

Ref Frequency	1000.00	Hz
---------------	---------	----

Remote command:

[SOURce:FREQuency:REFerence](#) on page 856

5.2.2 Outputs of the universal generator

The outputs of the analog R&S UPV generator can be configured in various ways (see the panel description under Channel, Output Type, Impedance and Common). The circuit diagrams for the generator output are shown below.

Unbalanced Output (Output Type "Unbal")

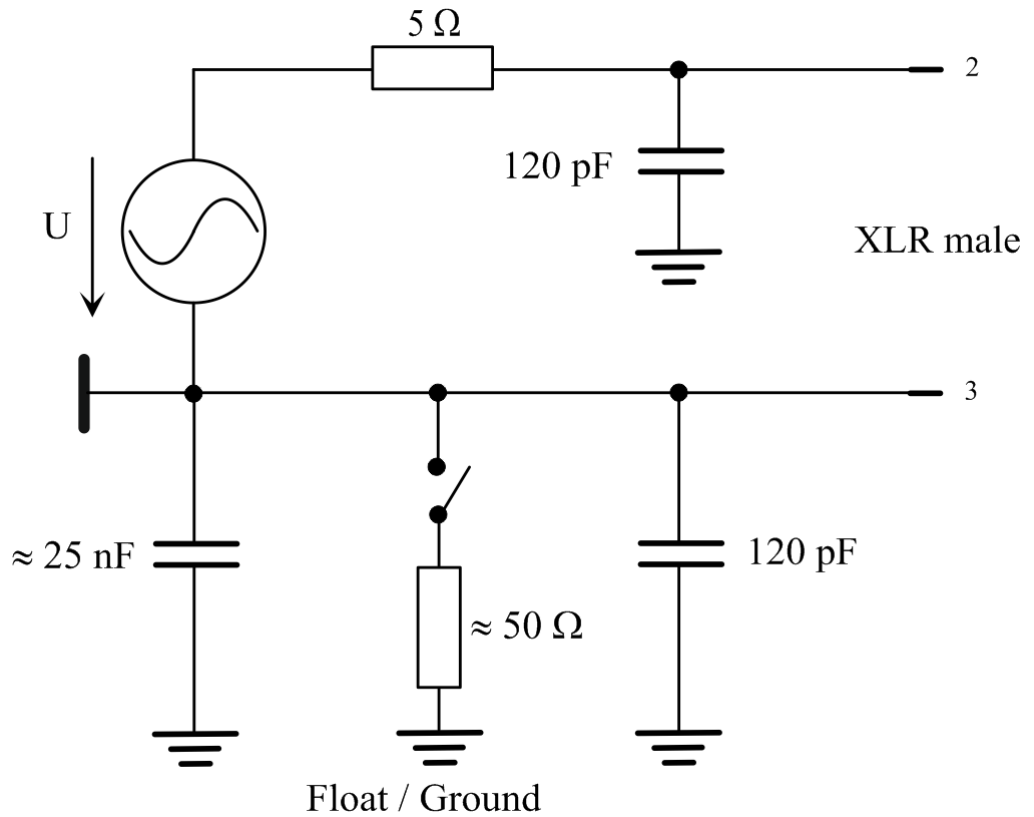


Fig. 5-2: Unbalanced Output

The following output circuit configurations are available depending on the selected channel setting (capacitors are not shown; the ground symbol denotes the floating generator ground connection):

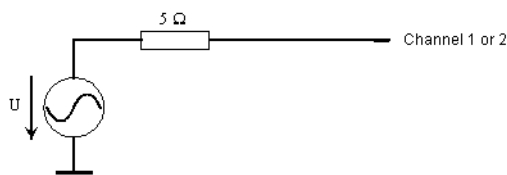


Fig. 5-3: Channel = 1 or 2

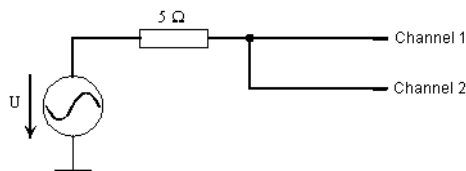


Fig. 5-4: Channel = 2 = 1

The selected output impedance is retained even if the output is deactivated; XLR Pin 3 is connected to the generator ground.

Balanced Output (Output Type "Bal")

The balanced output signal is applied between Pin 2 and Pin 3 of the XLR plug. Pin 1 is not connected. The source impedance consists of two identical resistors in both signal lines.

In the schematic circuit diagrams, the ground symbol with the single line represents the floating generator ground connection and the earth ground symbol represents the R&S UPV housing ground.

The following output circuit configurations are available depending on the channel and impedance (capacitors are not shown):

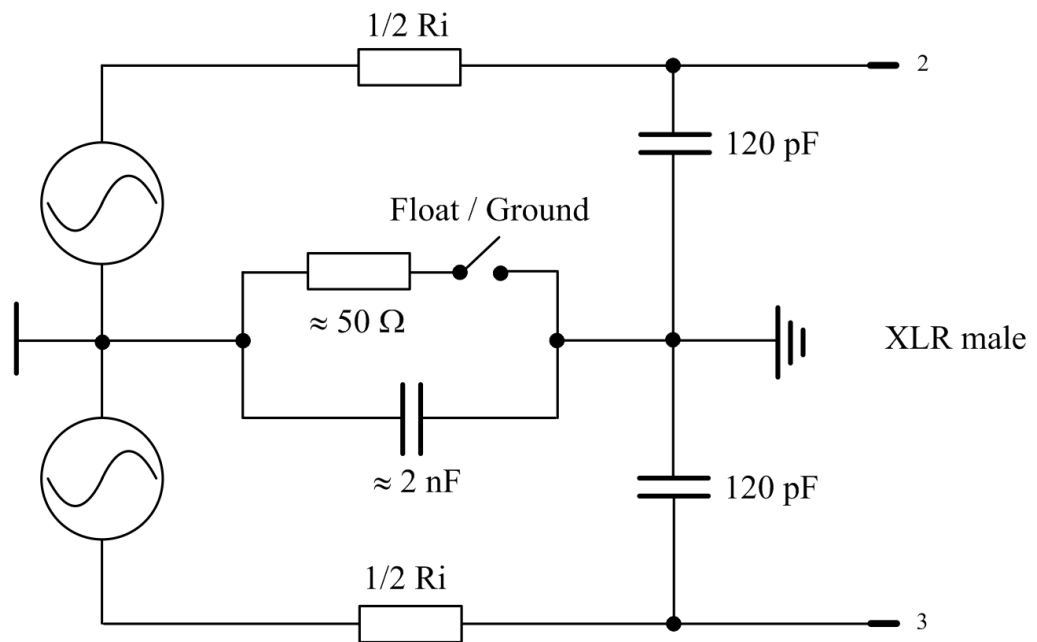


Fig. 5-5: Balanced Output

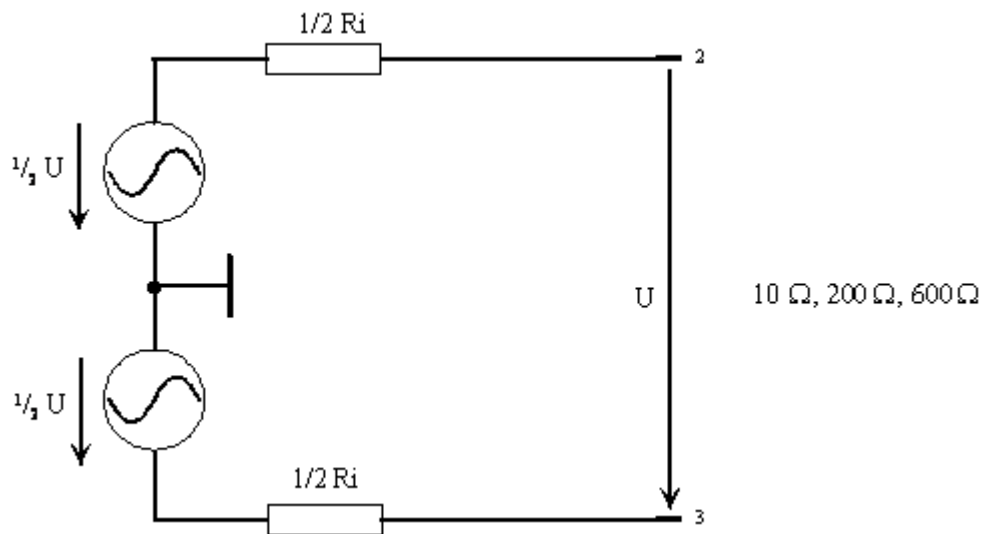


Fig. 5-6: Channel = 1 or 2

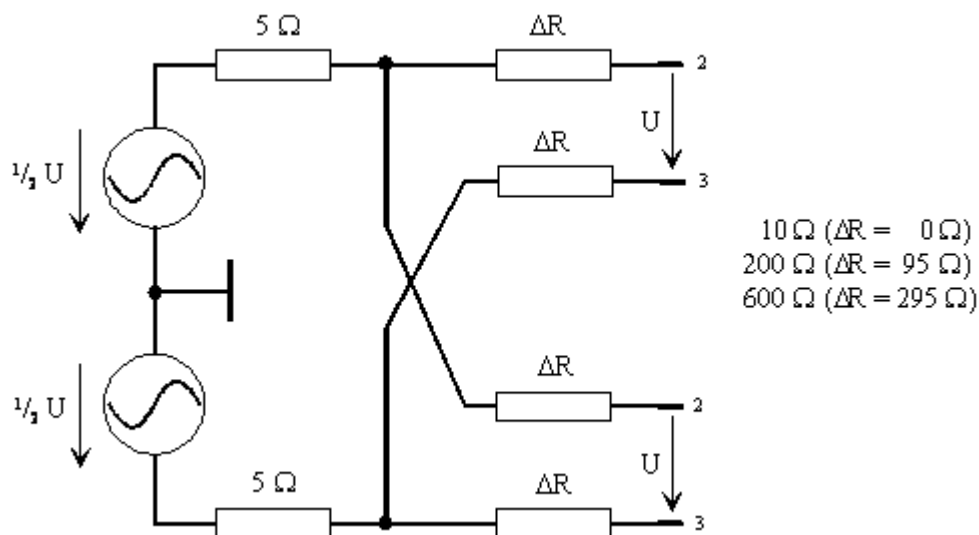


Fig. 5-7: Channel = 2 = 1

The selected output impedance is retained even if the output is deactivated. The deactivated generator output is not connected to generator ground.

The diagrams above apply to all generator functions, except "Stereo Sine" and "DIM". The R&S UPV-B3 option (second generator) is required in order to generate a stereo or DIM signal. In this case, the XLR plugs Ch1 and Ch2 are supplied slightly differently.

If the R&S UPV-B3 option (second generator) is installed and the generator function "Stereo Sine" is configured, the XLR plugs of the outputs are interconnected as follows:

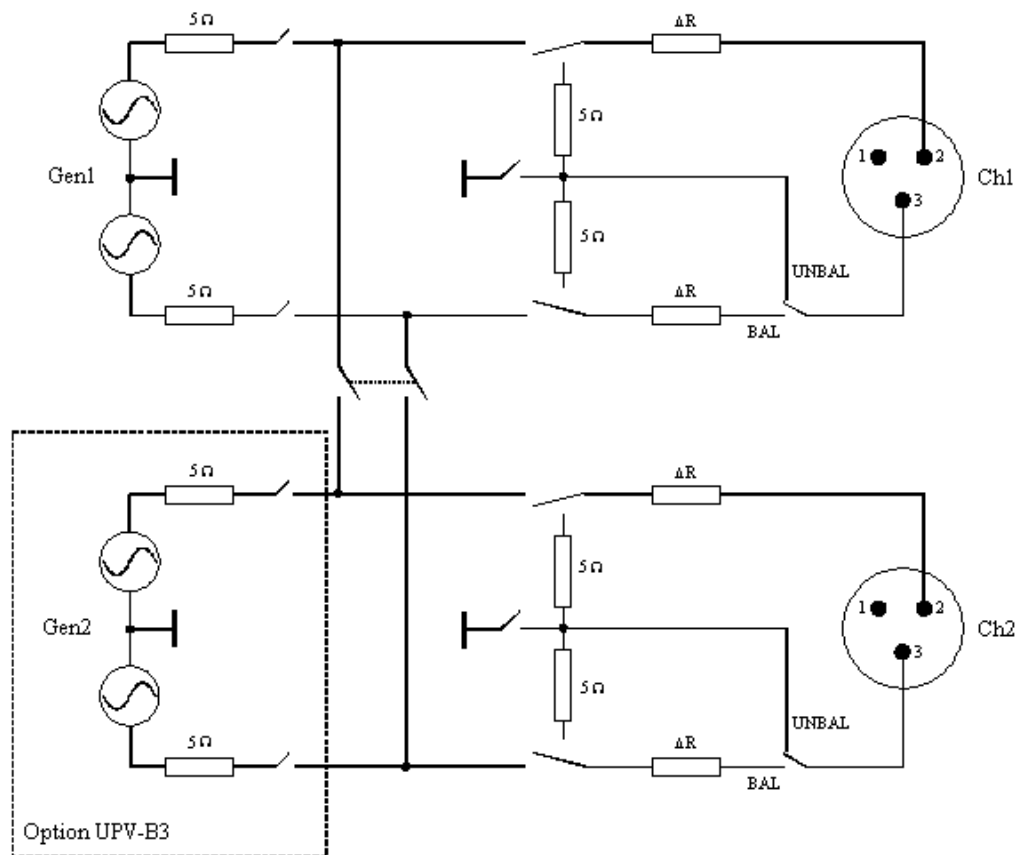


Fig. 5-8: Connection of outputs with "Stereo Sine"

As can be seen in the circuit diagram, the two generator outputs are supplied by two independent sources.

If the R&S UPV-B3 option (second generator) is installed and the generator function "DIM" is configured, the XLR plugs of the outputs are interconnected as follows:

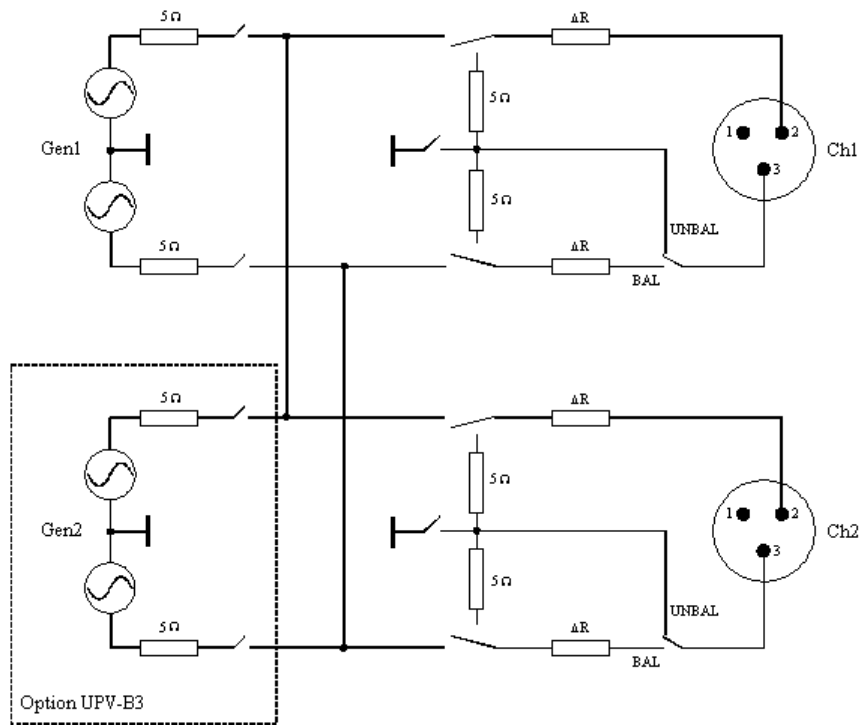


Fig. 5-9: Connection of outputs with "DIM"

Both generator outputs are fed by the R&S UPV-B3 option (second generator).

Balanced Output with Common-Mode Signal (Output Type "Com Mode Test")

The generator output signal is present with equal phase at pins 2 and 3 of the XLR connectors. The signal lines are referenced to the generator ground. The output impedance is made up of two identical resistances in the two signal lines. The signal source is connected via a common 5 Ω resistor to the node where the signal line branches into two.

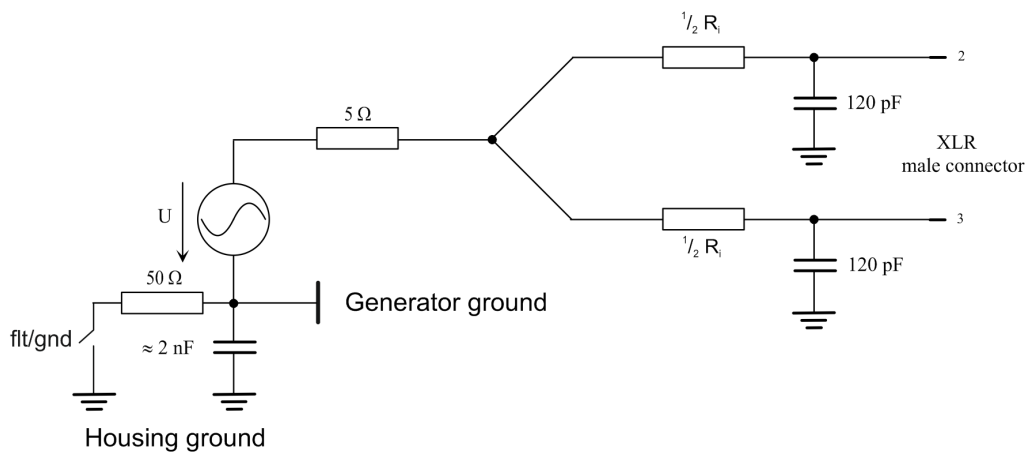


Fig. 5-10: Balanced Output with common mode signal

Depending on the selected channel/channels, the impedance and the waveform, various output configurations are possible as shown below (capacitors not shown).

The common source resistance is always $5\ \Omega$. The resistors with the designation $\frac{1}{2} R_i$ always represent half the value of the configured output impedance.

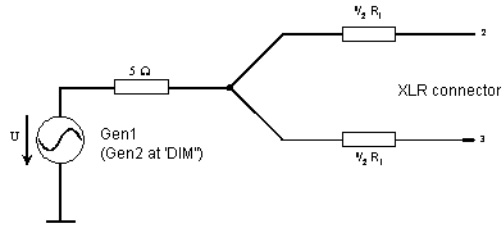


Fig. 5-11: Channel 1 or 2

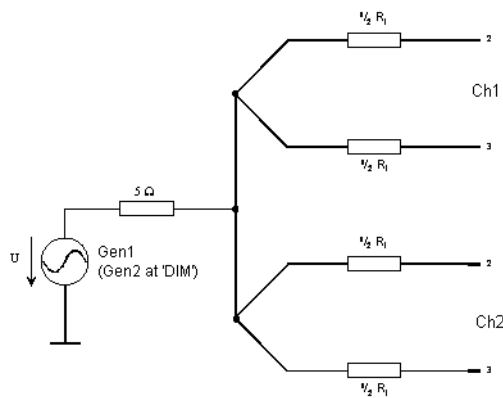
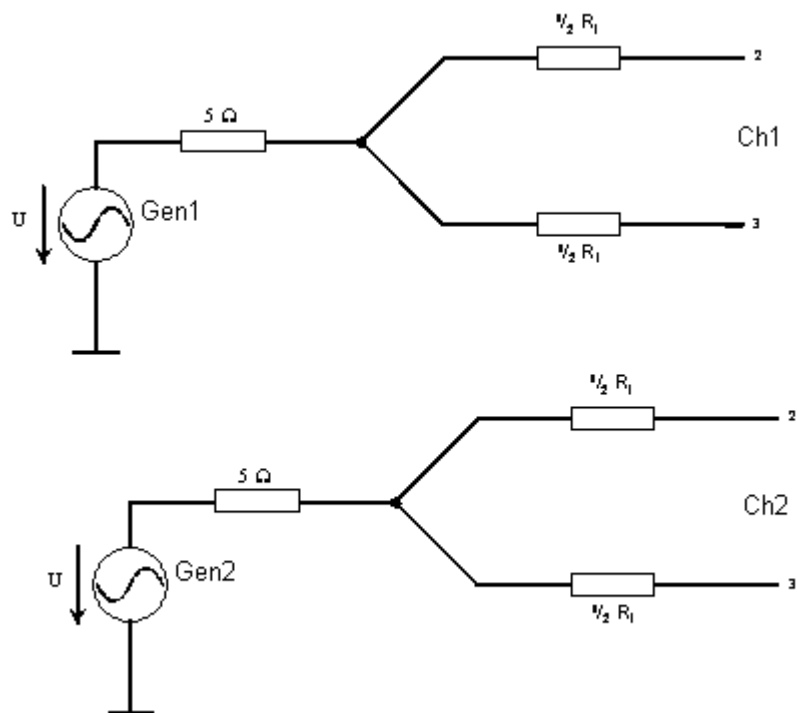


Fig. 5-12: Channel 2 ≡ 1

If "Stereo Sine" is set in the Generator Function panel, the two generator outputs are fed by two separate sources:

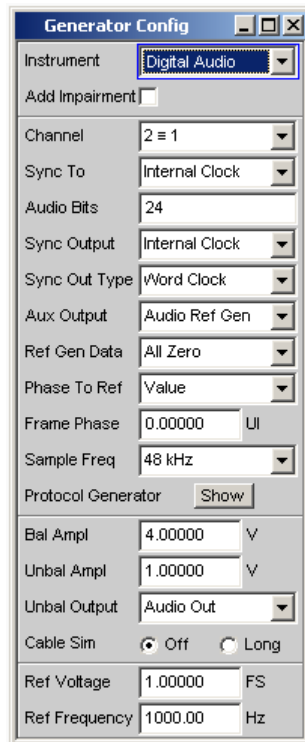


5.2.3 Output power of the universal generator

The output amplifier, attenuator and all internal resistors are short-circuit-proof. The peak value of the current is limited to approx. 200 mA. For a maximum RMS value of 20 V (balanced mode) and 10 V (unbalanced mode), the maximum power dissipation in the load resistor (with a short circuit in the internal resistor) is 2.8 W or 1.4 W.

5.3 Configuring the Digital Generator

5.3.1 Digital Generator Configuration Panel



The "Digital Audio" generator instrument requires the options R&S UPV-B2 (digital audio interfaces).

With digital audio interfaces, there are basically two signal types which occur: the analog interface signal and the encoded audio signal itself. The digital interface signal has analog parameters on which, for example, noise or other disturbance signals (impairments) can be superimposed, which are also noticeable in a shift of the edges. When this effect (known as "jitter") exceeds a certain magnitude, it becomes impossible to decode or regenerate the audio signal correctly.

The R&S UPV can generate these faults of the digital signals simultaneously with the encoded audio signal: Shifting of the signal edges (jitter) or superimposition of a common-mode voltage on the digital lines (common mode). The internal analog generator is used for generating such interference signals.

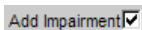
Generating the impairments requires the R&S UPV-B2 (digital audio interfaces) and R&S UPV-K22 (jitter and interface test) options.

The configuration options of the digital audio generator are described below.

Add Impairment

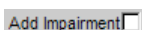
(only with R&S UPV-B2 (digital audio interfaces)). Here, you configure whether or not to add impairments (jitter or a common-mode signal) to the output signal of the digital audio generator, see also [chapter 5.3.2, "Digital Impairments Configuration Panel"](#), on page 258.

"ON"



The impairment signal (jitter or common-mode) is activated.
The analog generator is deactivated, since it is used for generating the impairment signal.

"OFF"



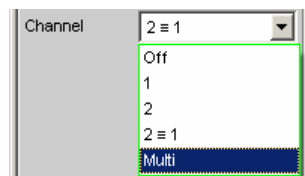
The impairment signal is deactivated.

Remote command:

[SOURce:IMPAirment](#) on page 860

Channel

Selection of the left and right digital audio channels.



"OFF"

Both channels are deactivated.
The frequency and level setting of the channels have no effect.
A "blank frame" is generated that does not contain any audio data.

"1"

The left channel supplies the generator signal, the right channel is deactivated.

"2"

The right channel supplies the generator signal, the left channel is deactivated.

"2 = 1"

Both channels, left and right, return the same output signal.
If the generator function "Stereo Sine" is selected, both channels may differ with regard to frequency, phase and amplitude.

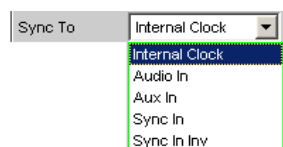
Remote command:

[OUTPut:CHANnel](#) on page 857

Sync To

Used to select the source to which the digital audio generator is synchronized.

Only available with R&S UPV-B2 (digital audio interfaces).



"Internal CLK"

The generator is synchronized to the internal clock generator.
The generator sample rate is determined by the set sample frequency.

"Audio In"	Synchronizes to a digital audio signal at the "Digital In" BNC jack. The generator runs at the same sampling rate as the supplied signal.
"Aux In"	Synchronizes to the digital audio signal at the AUX input XLR socket at the rear of the instrument.
"Sync In"	Synchronizes to the word clock signal at the SYNC-INPUT BNC jack on the rear side of the instrument. The generator sync PLL is used.
"Sync In inv"	Synchronizes to the inverted word-clock signal at the SYNC input BNC jack at the rear of the instrument.

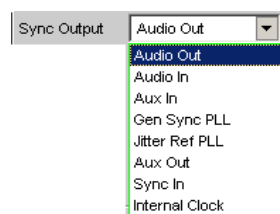
Remote command:

`SOURce:SYNC:TO` on page 861

Sync Output

(only with R&S UPV-B2 (digital audio interfaces)). Selection of source for the digital audio sync output on the rear of the instrument.

"Sync Out Type" can be set to either Word Clock or Biphase Clock (the frequency of the biphase clock is 128 times that of the word clock).



"Audio Out"	Clock signal of the digital audio generator. Always the same as the clock rate of the digital audio output on the front panel. If "Jitter" is set, jitter is applied to this output.
"Audio In"	Clock signal of the selected digital audio input on the front panel.
"Aux In"	Clock signal of the digital audio auxiliary input at the rear of the instrument.
"Gen Sync PLL"	Clock signal at the output of the generator sync PLL. Allows the frequency of a word clock applied at the sync input to be increased by a factor of 128. If "Jitter" is set, the set jitter is not applied to this output. Refer to setting the generator sampling rate.
"Jitt Ref PLL"	Clock signal at the output of the jitter reference PLL. Allows a low-jitter clock to be recovered from the digital audio input signal. Refer to setting the Digital Audio Analyzer sampling rate.
"Aux Out"	Clock signal of the digital audio auxiliary generator. This generator is used e.g. for the frame phase setting and the reclock function.
"Sync In"	Gives you the ability to loop through the audio sync input, e.g. to cascade multiple instruments that synchronize to the word clock.

"Internal Clock" Output signal of the internal clock source.
If the digital audio generator is not synchronized to the internal clock, the internal clock is available as an independent clock source and is set using the selection parameter "Int Clk Freq".

Remote command:

`OUTPut:SYNC:OUTPut` on page 860

Int Clk Freq

(only with R&S UPV-B2 (digital audio interfaces)). Used to set the (word-clock) frequency of the internal clock generator if the internal clock generator is used as an independent clock source at the digital audio sync output.

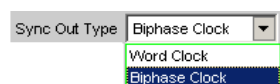


Remote command:

`OUTPut:INTClockfreq` on page 859

Sync Out Type

(only with R&S UPV-B2 (digital audio interfaces)). "Sync Out Type" can be set to either Word Clock or Biphase Clock (the frequency of the biphase clock is 128 times that of the word clock).



"Word CLK" The signal of the digital audio sync output corresponds to the sampling frequency of the selected source.

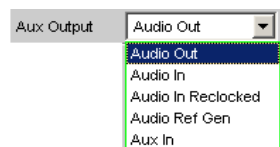
"Biphase CLK" The signal of the digital audio sync output corresponds to the biphase clock, i.e. 128 times the sampling frequency of the selected source. The biphase clock is often used for direct clocking of the digital audio modules.

Remote command:

`OUTPut:SYNC:TYPE` on page 860

Aux Output

(only with R&S UPV-B2 (digital audio interfaces)). Used to select the source for the digital audio auxiliary output at the rear.



"Audio Out" The digital audio generator signal at the auxiliary output is identical to the signal at the front output.

The signal output level is constant and does not depend on the selected BAL / UNBAL output level. The long cable simulator and common-mode superimposition have no effect on this output. If a jitter is set, it will also affect this output.

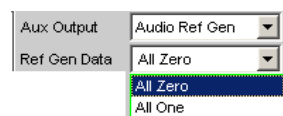
"Audio In"	<p>Loop-through option of the digital audio signal from the selected input to the digital audio auxiliary output.</p> <p>The signal output level is constant and does not depend on the selected input or the pulse amplitude at the digital input.</p>
"Audio In Reclocked"	<p>The jitter-reduced input signal is output.</p> <p>The audio data content is extracted from the input signal and output again via the digital audio auxiliary generator. This generator is controlled using the low-jitter clock from the jitter reference PLL.</p>
"Audio Ref Gen"	<p>Here, the digital audio auxiliary generator is used as the reference generator for the frame phase setting of the digital audio generator. If this setting is selected, it is then possible to set a frame phase and select the reference generator data.</p> <p>This setting cannot be selected if the digital generator is synchronized to the sync input.</p>
"Aux In"	<p>Gives you the ability to loop through the digital audio auxiliary input, e.g. to cascade multiple instruments.</p>

Remote command:

[OUTPut:AUXiliary:OUTPut](#) on page 859

Ref Gen Data

(only with R&S UPV-B2 (digital audio interfaces)). If "Audio Ref Gen" is selected as the "Aux Output" source, it is then possible to configure the audio data for this reference generator.



"All Zero"	<p>All audio data bits are set to zero.</p> <p>Output a "blank frame", which corresponds to the normal case.</p>
"All One"	<p>To allow digital audio receivers to be tested, the audio data bits can all be set to one.</p>

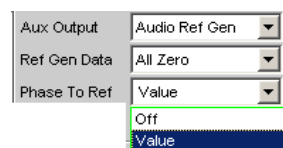
Remote command:

[SOURce:REference](#) on page 861

Phase To Ref

(only with R&S UPV-B2 (digital audio interfaces)). If "Audio Ref Gen" is selected as the "Aux Output" source, the variation of the frame phase storage of the digital audio signal is available between the front output and the digital audio auxiliary output on the rear side of the instrument.

The phase is shifted internally using the generator sync PLL.



- "Off" "Phase To Ref" variation is deactivated.
This also bypasses the Generator Sync-PLL, which also results in an improvement of the clock signal for the digital audio generator.
- "Value " A frame phase shift is activated and an appropriate setting value can be entered.

Remote command:

[SOURce:PTORef](#) on page 861

Frame Phase

(only with R&S UPV-B2 (digital audio interfaces)). Used to enter the value for the desired frame phase shift. The value can be entered in various units.

The maximum variation range for the shift always corresponds to a phase shift of +/- 180° based on the frame phase of the reference generator.

The generator sync PLL is used for generating the phase shift.

Aux Output	Audio Ref Gen
Ref Gen Data	All Zero
Phase To Ref	Value
Frame Phase	0.00000 ns

Remote command:

[SOURce:FRAMephase](#) on page 860

Sample Frequency

Used to set the clock rate of the digital audio signal for the generator.

The sample frequency setting is used as a reference whenever audio data signals are generated.

For Common only and Jitter only generation (only R&S UPV-B2 (digital audio interfaces)), this determines the clock rate of the generated blank frame.

The selected clock rate determines the maximum signal frequency which can be input. For sine-wave signals, it is 49.9 % of the sampling rate.

R&S UPV-B2 (digital audio interfaces):

Sample Freq	48 kHz
	32 kHz
	44.1 kHz
	48 kHz
	88.2 kHz
	96 kHz
	176.4 kHz
	192 kHz
	Value

R&S UPV-B20 (digital audio interfaces, 48 kHz):

Sample Freq	48 kHz
	32 kHz
	44.1 kHz
	48 kHz
	Value

If the sample frequency entered does not match the actual clock rate (e.g. with external synchronization), all audio data signals shift accordingly in frequency.

This setting is also used to select the correct range for the Sync PLL.

Value range for numeric input:

30 kHz ... 200 kHz

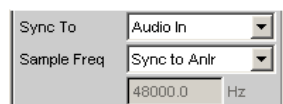
(30 to 55 kHz for the R&S UPV-B20 (digital audio interfaces, 48 kHz))

Standard sampling frequencies can be set directly in the selection field.

Only R&S UPV-B2 (digital audio interfaces):

Synchronization ranges for the generator sync PLL:

Base Rate band	30 kHz ... 64 kHz
Base Rate range	65 kHz ... 128 kHz
Base Rate band	129 kHz ... 200 kHz



If "Audio In" is selected as the synchronization in the "Sync To" line, the generator can be set to the same sample frequency as the digital analyzer by selecting "Sync to Anlr" from the "Sample Freq" line.

"32 ...192 kHz" Standard sampling rate 32 kHz ... 192 kHz

"Sync To Anlr" The sampling rate of the digital audio analyzer is used for synchronization. This selection item is offered only if Sync To = Audio In is selected.

"Value " Variable input of sampling rate

Remote command:

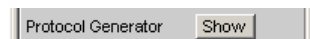
[OUTPut: SAMPlE:MODE](#) on page 859

[OUTPut: SAMPlE:FREQuency](#) on page 863

Protocol Generator

The option R&S UPV-K21 (digital audio protocol) enables you to generate and analyze the channel status data in the data stream of the digital audio interface (option R&S UPV-B2 (digital audio interfaces)) according to the IEC 60958-3 standard for Consumer Mode and IEC 60958-4 or AES3 for Professional Mode.

Open the control panel for the digital audio protocol generator by means of the Show button.



Alternatively, this panel can also be opened via the "Menu bar - Instruments - Protocol Generator".

Audio Bits

If the word width is decreased, the values of the audio samples are rounded to the specified word width. Unused data bits are encoded as zeroes in the digital audio signal.

Value range: 8 ... 24

Audio Bits	20
------------	----

Remote command:

[OUTPut:AUDiobits](#) on page 859

Bal Ampl

Used to set the pulse amplitude of the digital audio signal at the BAL output. The configured voltage corresponds to the peak-peak value of the pulse amplitude when the output is terminated at the rated impedance (110 ohms).

The standard voltage is 4 V

Setting range: 0 V to 8,5 V

This voltage is linked to the setting for the UNBAL amplitude and is always 4 times higher than this amplitude.

Bal Ampl	4.00000	V
Unbal Ampl	1.000000	V

Remote command:

[OUTPut:SIGNal:BALanced:LEVel](#) on page 860

Unbal Ampl

Used to set the pulse amplitude of the digital audio signal at the UNBAL (BNC) output. The configured voltage corresponds to the peak-peak value of the pulse amplitude when the output is terminated at the rated impedance (75 ohms).

The standard voltage is 1 V

Setting range: 0 V to 2,125 V

This voltage is linked to the setting for the BAL amplitude and is always a quarter of this amplitude.

Bal Ampl	4.00000	V
Unbal Ampl	1.000000	V

Remote command:

[OUTPut:SIGNal:LEVel](#) on page 860

Unbal Output

The unbalanced output can be switched so that the digital audio signal of the selected BAL or UNBAL input is output. If the BAL input is selected, the balanced signal is converted into an unbalanced signal. This allows, for example, the signal at the BAL input to be viewed conveniently on a connected oscilloscope.

Unbal Output	Audio Out
	Audio Out
	Audio In

"Audio Out" The digital audio generator signal is output.

"Audio In" The digital audio signal from the selected BAL or UNBAL input is output. It is not possible to output the signal of the optical input in this case. The pulse amplitude setting and the cable simulator do not have any effect on this output.

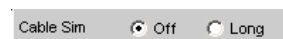
Remote command:

[OUTPut:UNBalanced:OUTPut](#) on page 860

Cable Sim

Cable simulation used to check the effect of attenuated input signals along long cables when tests are performed on digital audio receivers.

A cable length of approx. 100 m is simulated.



"Off" Cable simulation is deactivated.

"Long" Cable simulation for the BAL and UNBAL outputs is activated.

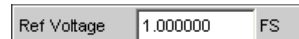
Remote command:

[OUTPut:CSIMulator](#) on page 859

Ref Voltage

Reference value for the relative amplitude units.

If this reference value is changed, all amplitude settings linked to the reference value also change.



Remote command:

[SOURce:VOLTagE:REFerence](#) on page 856

Ref Frequency

Reference value for the relative frequency units.

If the reference frequency is changed, all frequency settings linked to the reference value also change.

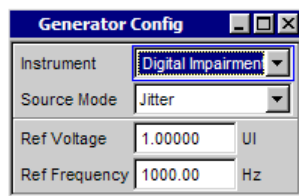


Remote command:

[SOURce:FREQuency:REFerence](#) on page 856

5.3.2 Digital Impairments Configuration Panel

The Digital Impairments Configuration Panel can be selected only if the R&S UPV is equipped with an option R&S UPV-B2 (digital audio interfaces).



This panel is used to select the digital impairment signal - jitter or common-mode - which can be added to the output signal of the digital audio generator. The parameters of the signals are set in the generator function panel.

The impairments are activated or deactivated in the Digital Audio Generator Config panel.

Source Mode

Used to set whether jitter or a common-mode signal is generated.

- "Jitter" A digital audio signal with jitter for tests on digital audio receivers can be generated.
The size of the jitter and delay impairments are usually specified in UI (Unit Intervals). One UI is defined as the smallest pulse width of the digital audio signal (eye width) and does not depend on the selected sampling rate. One UI corresponds to the clock period with which the digital signal is clocked ("biphase clock"). For digital audio signals, one UI corresponds to the 128th part of the sampling period; for 48 kHz, one UI is approx. 163 ns.
- "Common" A digital audio signal with superimposition of a common-mode signal at the BAL output can be generated.
Balanced cables are also used for the digital audio signal links. Here, coupled impairments (e.g. from ground loops) occur as common-mode voltage at the interfaces.

Remote command:

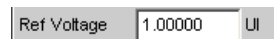
[SOURce:SRCMode](#) on page 861

Ref Voltage

Reference value for the relative amplitude units.

The unit of the reference value corresponds to the selected Source Mode (e. g. UI in Jitter Source Mode).

If this reference value is changed, all amplitude settings linked to the reference value also change.



Remote command:

[SOURce:VOLTagE:REFerence](#) on page 856

Ref Frequency

Reference value for the relative frequency units.

If the reference frequency is changed, all frequency settings linked to the reference value also change.



Remote command:

[SOURCE:FREQUENCY:REFERENCE](#) on page 856

5.3.3 Interface Assignment

Use of the R&S UPV-B2 (digital audio interfaces) option for 2-channel generation and analysis.

Front of the instrument:



DIGITAL AUDIO OUTPUT BAL

Symmetrical outputs on Pin 2 and 3. Pin 1: Galvanic connection for the device ground,

DIGITAL AUDIO OUTPUT UNBAL

BNC output for SPDIF or AES/EBU format in accordance with EIAJ CP-340. External conductor has **no galvanic connection** to the device ground.

DIGITAL AUDIO OUTPUT OPTICAL

Optical output in accordance with TOSLINK system

DIGITAL AUDIO INPUT BAL

Symmetrical inputs on Pin 2 and 3. Pin 1: Galvanic connection for the device ground,

DIGITAL AUDIO INPUT UNBAL

BNC input for SPDIF or AES/EBU format in accordance with EIAJ CP-340. External conductor with galvanic connection for the device ground.

DIGITAL AUDIO INPUT OPTICAL

Optical input in accordance with TOSLINK system

Rear side of the device:



DIGITAL AUDIO SYNC OUT

BNC output for synchronizing digital peripherals to the word clock or bitphase clock of the R&S UPV. External conductor with galvanic connection for the device ground.

DIGITAL AUDIO SYNC IN

BNC synchronization input for word clock signals. External conductor with galvanic connection for the device ground.

DIGITAL AUDIO AUX OUT

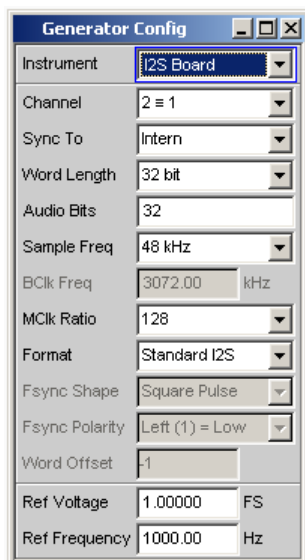
Symmetrical outputs for a digital audio reference signal (DARS) generated by the R&S UPV on Pin 2 and 3. Pin 1: Galvanic connection for the device ground,

DIGITAL AUDIO AUX IN

Symmetrical inputs for a digital audio reference signal (DARS) on Pin 2 and 3. Pin 1: Galvanic connection for the device ground,

5.4 Configuring the I²S Generator

5.4.1 I²S Generator Configuration Panel

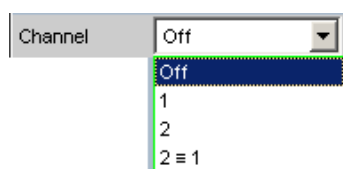


The "I²S" generator instrument requires the R&S UPV-B41 option (I²S interface).

The configuration options of the "I²S" generator are described below.

Channel

Selection of the left (Ch1) and right (Ch2) digital audio channels.



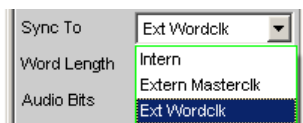
- | | |
|---------|---|
| "OFF" | Both channels are deactivated.
The frequency and level setting of the channels have no effect.
A "blank frame" that does not contain any audio data (all bits = null) is generated. |
| "1" | Only the left channel supplies the generator signal; the right channel is deactivated (all bits = null). |
| "2" | Only the right channel supplies the generator signal; the left channel is deactivated (all bits = null). |
| "2 = 1" | Both channels, left and right, return the same output signal.
If the generator function "Stereo Sine" is selected, the two may differ with regard to frequency, phase and amplitude. |

Remote command:

[OUTPut:CHANnel](#) on page 857

Sync To

Used to select the source to which the I²S generator is synchronized.



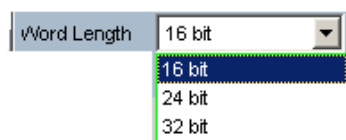
- "Intern" The generator uses the instrument's internal clock signal.
The sampling rate of the generator is based on the configured value.
- "Ext Mclk" Synchronization to the external master clock fed in at the TX MCLK IN BNC jack on the back of the R&S UPV-B41 (I²S interface) option.
- "Ext Wordclk" Synchronizes to the external word clock supplied at the TX MCLK IN BNC jack.

Remote command:

[SOURce:SYNC:TO](#) on page 861

Word Length

Word width of one data frame per channel in bits.



Remote command:

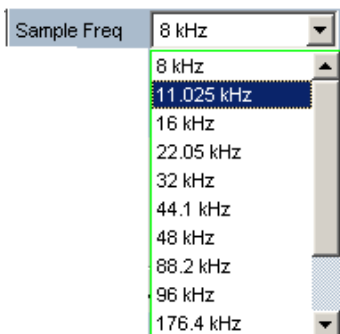
[OUTPut:WLENgth](#) on page 863

Sample Freq

Setting the sampling frequency.

The sampling frequency corresponds to the frequency of the FSYNC signal. All frequency information of generated audio data relates to this setting. If the I²S generator is operated with external wordclock synchronization and the frequency of the external clock signal does not correspond to the set sampling frequency, the I²S generator generates audio data with an incorrect frequency. Even with external masterclock synchronization, the external clock signal must correspond to the set sampling frequency multiplied by the selected MCLK ratio. Otherwise, the I²S generator also generates audio data with an incorrect frequency.

The selected clock rate determines the maximum signal frequency which can be input. For sine-wave signals, this is 49.9 % of the sampling rate.



The standard sampling frequencies can be set directly in the selection field.

The selection item "Value" permits the variable input of the sampling rate in the following line.

Value range for numeric input:

6.75 kHz to 410 kHz

Remote command:

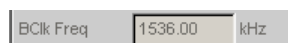
[OUTPut:SAMPle:MODE](#) on page 859

[OUTPut:SAMPle:FREQuency](#) on page 863

BCK Freq

Display of the bit block frequency based on the relationship: "Word Length" * "Sample Freq".

Value range: 216 kHz to 26.24 MHz



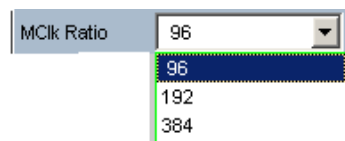
Remote command:

[OUTPut:BCLK:FREQuency?](#) on page 862

MCK Ratio

Ratio between MCLK and FSYNC.

Value range: 64, 96, 128, 192, 256, 384, 512



The value range of the MCK ratio (and thus the selection available in the combo box) varies based on "Word Length" and "Sample Freq".

Remote command:

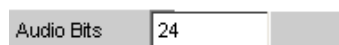
[OUTPut:MCLKratio](#) on page 862

Audio Bits

Word width of the audio data within a frame.

Audio samples are rounded to the specified word length. Unused data bits are coded as zeros.

Value range: 8 to Word Length

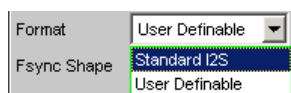


Remote command:

[OUTPut:AUDIobits](#) on page 859

Format

Selection of the I²S generator function.



"Standard I²S" The I²S generator transmits in the standard I²S format. The following parameters that have an effect on the format have **fixed default settings**:
 Fsync Shape = Square Pulse
 Fsync Polarity = Left(1) = Low
 Word Offset = -1

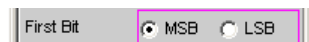
"User Def." The I²S generator transmits in a format similar to I²S. The following parameters are additionally available:
 Fsync Shape
 Fsync Polarity
 Word Offset

Remote command:

[OUTPut:FORMat](#) on page 862

First Bit

Defines the sequence in which the data bits are transmitted



"MSB" The most significant bit is transmitted first.

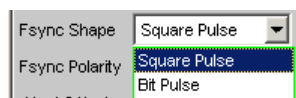
"LSB" The least significant bit is transmitted first.

Remote command:

[OUTPut:FBIT](#) on page 862

Fsync Shape

Selection of the FSYNC signal form.



"Square Pulse" The FSYNC signal is transmitted as a symmetrical rectangle.

"Bit Pulse" The FSYNC signal is transmitted as a bit pulse.

Remote command:

[OUTPut:FSHape](#) on page 862

Fsync Polarity

Polarity of the FSYNC signal

The selection varies, and is available depending on the setting of Fsync Shape = Square Pulse or Bit Pulse.

"Left (1) = Low" Fsync Shape = Square Pulse
 While the left channel (channel 1) is being sent, a low level is applied at the FSYNC signal at a word offset of 0.

- "Left (1) = High" Fsync Shape = Square Pulse
While the left channel (channel 1) is being sent, a high level is applied at the FSYNC signal at a word offset of 0.
- "Positive" Fsync Shape = Bit Pulse
At a Word Offset of 0, a positive pulse marks the beginning of the left data word.
- "Negative" Fsync Shape = Bit Pulse
At a Word Offset of 0, a negative pulse marks the beginning of the left data word.

Remote command:

[OUTPut:POLarity](#) on page 862

Word Offset

By using Word Offset, you can set the number of SCK clock cycles by which the Fsync signal transmission is delayed relative to the audio data.

Value range: -Word Length to 0 to +Word Length-1



Remote command:

[OUTPut:WOFFset](#) on page 863

Ref Voltage

Reference value for the relative amplitude units.

If this reference value is changed, all amplitude settings linked to the reference value also change.

Remote command:

[SOURce:VOLTage:REFerence](#) on page 856

Ref Frequency

Reference value for the relative frequency units.

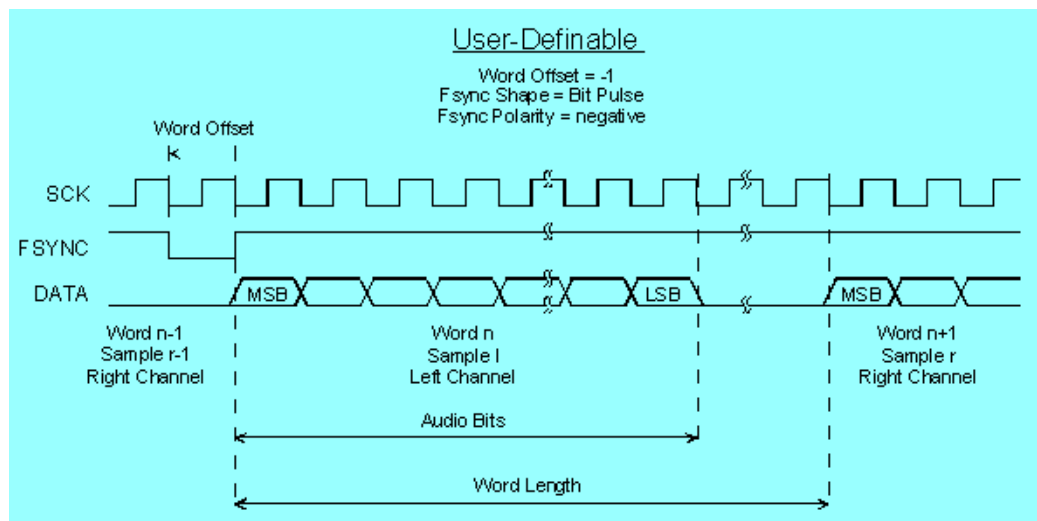
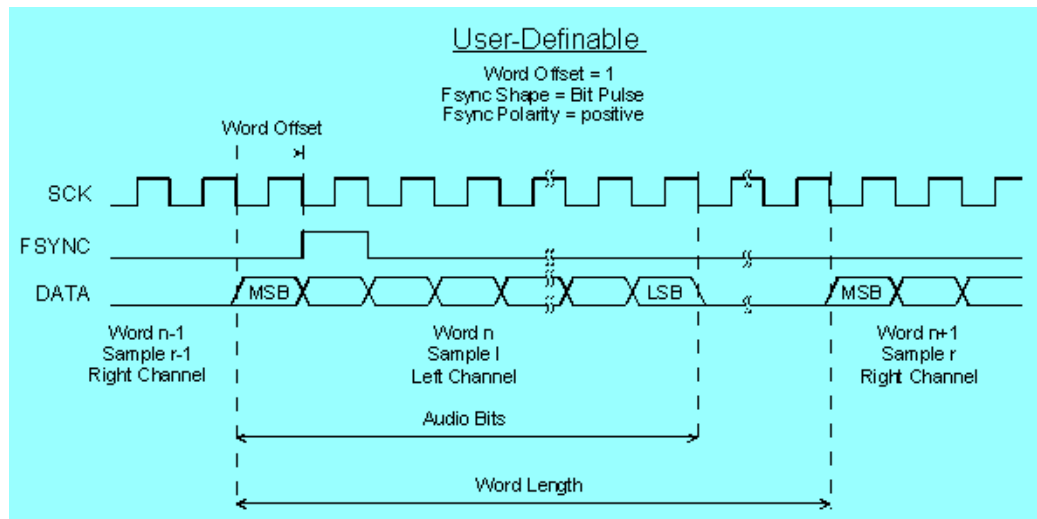
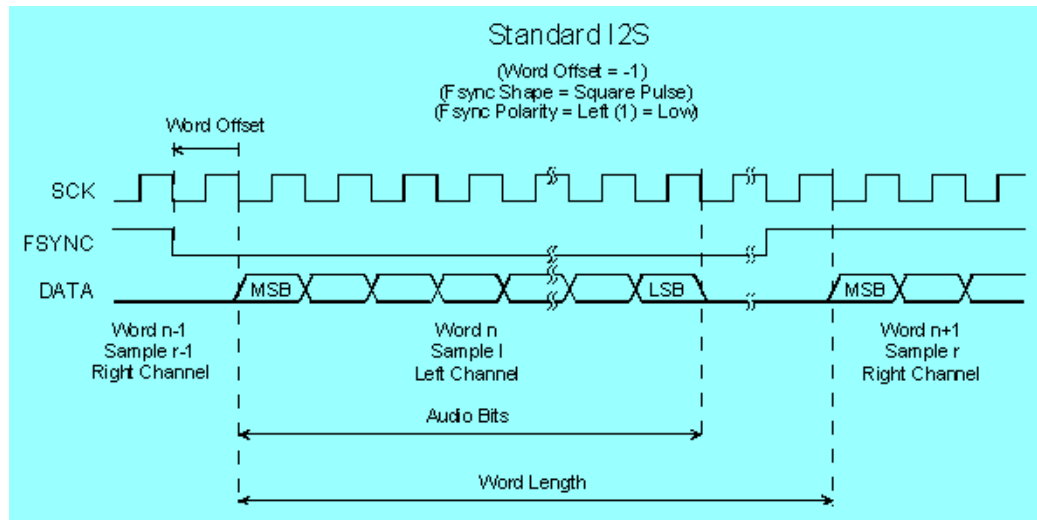
If case of a change, all frequency settings linked to the reference frequency also change.

Remote command:

[SOURce:FREQuency:REFerence](#) on page 856

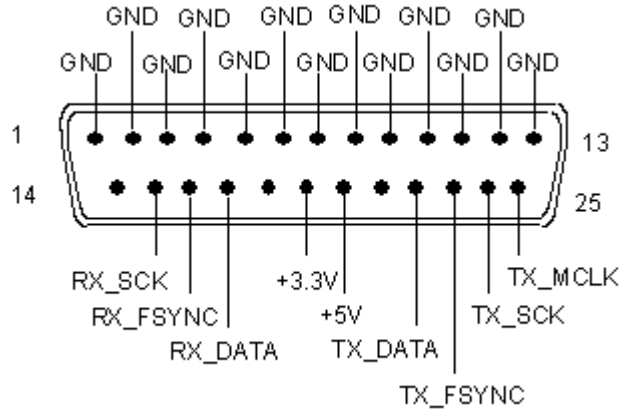
5.4.2 Timing Diagrams

The timing diagrams below show a number of configuration examples that illustrate the effect of the parameters.



5.4.3 Interface Assignment

I²S plug (25-pin D-Sub connector) of R&S UPV-B41 (I²S interface) option.



Connection	Signal	Input (I) Output (O)	Description
1	GND		Ground terminal
2	GND		Ground terminal
3	GND		Ground terminal
4	GND		Ground terminal
5	GND		Ground terminal
6	GND		Ground terminal
7	GND		Ground terminal
8	GND		Ground terminal
9	GND		Ground terminal
10	GND		Ground terminal
11	GND		Ground terminal
12	GND		Ground terminal
13	GND		Ground terminal
14	not connected		
15	RX_SCK	E	Serial Clock Analyzer
16	RX_FSYNC	E	Frame Sync Analyzer
17	RX_DATA	E	Serial Data Analyzer
18	not connected		
19	+3.3 V (500 mA)	A	Power Supply
20	+5 V (500 mA)	A	Power Supply

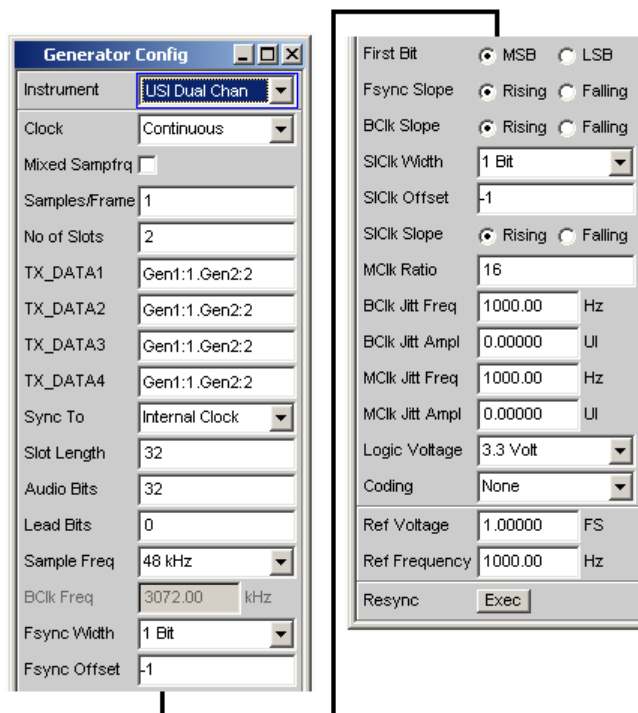
Connection	Signal	Input (I) Output (O)	Description
21	not connected		
22	TX_DATA	A	Serial Data Generator
23	TX_FSYNC	A	Frame Sync Generator
24	TX_SCK	A	Serial Clock Generator
25	TX_MCLK	A	Master Clock Output Generator

TX MCLK IN (BNC jack)

Connection	Signal	Input (I) Output (O)	Data direction
Outer conductor	GND		Ground terminal
Inner conductor	TX_CLK	E	Master Clock Input Generator

5.5 Configuring the USI Dual Channel Generator

5.5.1 USI Dual Channel Generator Configuration Panel



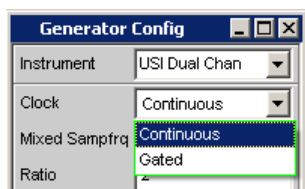
The "USI Dual Chan" generator instrument requires the R&S UPV-B42 (universal serial interface) option and consists of a plug-in card, a cable and a probe for contacting a device under test. For the pin assignment of the probe, see [chapter 5.5.4, "Interface Assignment"](#), on page 285.

The configuration options for the USI dual channel generator are described below.

During the boot process of the R&S UPV with the "USI Dual Chan" instrument, a check is performed whether the probe is connected and ready for operation, otherwise a warning is issued. If the probe is connected **after** the R&S UPV is switched on, only the "USI Dual Chan" instrument must be confirmed to initialize the probe. A green LED on the probe shows the operational readiness. This mechanism permits the probe to be detached and reattached and put back into operation during operation. Detaching and reattaching during operation does not damage the probe!

Clock

Used to select the continuous clock or gated clock operating modes.



"Continuous" The continuous clock operating mode requires a continuous clock for the generator. The clock source may be internal or external. Several types of synchronization are available if the timing device is external.

"Gated" The gated clock operating mode must be selected if the externally supplied bit clock (BClk) and the FrameSync (Fsync) are discontinuous or have such a large jitter that the internal PLL can no longer follow this clock.

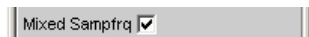
The synchronization type is limited to the "external FrameSync and bit clock" (Ext Fsync&BClk) mode. Audio monitoring of the audio signal generated is not possible.

Remote command:

[OUTPut:CLock](#) on page 864

Mixed Sampfrq

Used to produce data streams of varying sampling rates in both generator channels. When activated, the generator filter is not available.



Remote command:

[OUTPut:MSAMplefrequency](#) on page 866

Ratio

Down-sampling factor for 2nd generator channel with regard to the sampling rate. Value range: 2 ... 6

Ratio	<input type="text" value="2"/>
-------	--------------------------------

Remote command:

[OUTPut:RATio](#) on page 866

Samples/Frame

Defines the number of samples of a generator channel per frame.

The parameter simultaneously determines the minimum settable sampling rate according to the relationship: $fs_min = Hz * samples/frame$

Value range: 1 to 32

Samples/Frame	<input type="text" value="1"/>
---------------	--------------------------------

Remote command:

[OUTPut:SPFRame](#) on page 867

No of Slots

Defines the number slots per frame.

Value range: 1 to 256

$No_of_Slots * Slot_Length \leq 2048$

$Slot_Length * No_of_Slots * Sample_Freq \leq 55.926 \text{ MHz}$

No of Slots	<input type="text" value="2"/>
-------------	--------------------------------

Remote command:

[OUTPut:NOSLots](#) on page 866

TX_DATA1

Defines which signal is output on the individual slots of the TX_DATA1 data line.

TX_DATA1	Gen1:1.Gen2:2
----------	---------------

Remote command:

[OUTPut:TXData<n2>](#) on page 867

<n> = 1

TX_DATA3

Defines which signal is output on the individual slots of the TX_DATA3 data line.

TX_DATA3	Gen1:1.Gen2:2
----------	---------------

Remote command:

[OUTPut:TXData<n2>](#) on page 867

<n> = 3

TX_DATA4

Defines which signal is output on the individual slots of the TX_DATA4 data line.



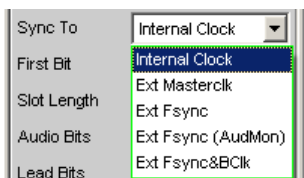
Remote command:

OUTPut:TXData<n2> on page 867

<n> = 4

Sync To

Used to select the source to which the USI generator is synchronized.



Overview of the various synchronization modes:

	Internal clock	External master clock	External frame sync	External frame sync with audio monitor	External frame sync, bit clock	External frame sync, bit clock (gated)
Master clock output	o	tri	o	tri	o	tri
Master clock input	--	x	--	--	--	--
Bit clock output	o	o	o	o	tri	tri
Bit clock input	--	--	--	--	x	x
Frame sync output	o	o	o	o	tri	tri
Frame sync input	--	--	x	x	x	x
Slot clock output	o	o	o	o	o	o

x → Input signal must be present

o → Output signal is present

tri → Output is in tristate mode (high-impedance)

-- → Unused input

"Internal Clock" The generator uses the instrument's internal clock signal.

"Ext Masterclk" Synchronizes to an external master clock (TX_MCLK_IN).

"Ext Fsync" Synchronization to the external FrameSync signal (TX_FSYNC_IN). The generator signal cannot be audio-monitored. A master clock signal is additionally generated and output.

"Ext Fsync (AudMon)" Synchronization to the external FrameSync (TX_FSYNC_IN) signal. The generator signal cannot be audio-monitored. No master clock signal is output.

"Ext Fsync&BCLK" Synchronization to the external FrameSync (TX_FSYNC_IN) and bit clock (TX_BCLK_IN) signals.

Remote command:

[SOURCE:SYNC:TO](#) on page 861

First Bit

Defines the sequence in which the data bits are transmitted



"MSB" The most significant bit is transmitted first.

"LSB" The least significant bit is transmitted first.

Remote command:

[OUTPut:FBIT](#) on page 862

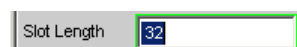
Slot Length

Word width of a slot including gaps (0 bits).

Value range: 8 to 256

$No_of_Slots * Slot_Length \leq 2048$

$Slot_Length * No_of_Slots * Sample_Freq \leq 55.926 \text{ MHz}$



Remote command:

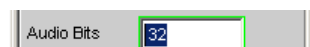
[OUTPut:SLTLength](#) on page 867

Audio Bits

Word width of the audio data within a slot.

Unused data bits are coded as zeros in the digital audio signal.

Value range: 8 to slot length (max 32)



Remote command:

[OUTPut:AUDIobits](#) on page 859

Lead Bits

Defines the offset for the audio bits within a slot relative to the start of the slot.

If LSB is selected as the first bit, the setting for lead bits is automatically corrected if the setting for audio bits is changed so that the MSB is received at the same location. This has the advantage that the resolution of the signal transmitted is changed but not the amplitude if the audio bits are changed.

Example:

Slot length: 32

Audio bits: 24 --> 23 (setting changed by user)

Lead bits: 8 --> 9 (automatic correction)

Value range: 0 to slot length audio bits



Remote command:

`OUTPut: LBITs` on page 865

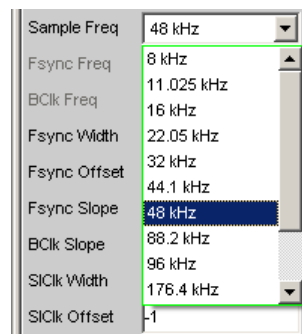
Sample Freq

Setting the sampling frequency.

All frequency specifications of the audio data transmitted refer to this setting. If the USI generator is operated with external synchronization and the frequency of the external clock signal does not correspond to the set frequency of the Fsync signal, the generator generates signals with the wrong frequency.

The selected clock rate determines the maximum signal frequency which can be input. For sine-wave signals, this is 49.9 % of the sampling rate.

For data formats with one sample per frame, the sampling frequency corresponds to the frequency of the Fsync signal. In case of several audio data samples from one source within one frame, the frequency of the Fsync signal is the product of the sampling frequency divided by the factor of samples/frame.



Value range for numeric input:

0.84375 kHz to 400 kHz

$No_of_Slots * Slot_Length \leq 2048$

$Slot_Length * No_of_Slots * Sample_Freq \leq 55.926 \text{ MHz}$

Standard sampling frequencies can be set directly in the selection field.

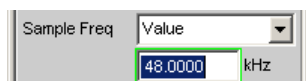
"Auto" Automatic setting of the sampling rate. The sampling rate is measured, set and displayed in the following line. If the applied sampling rate is changed the set value is automatically updated. This setting is only available with external synchronization.

Note: The digital generator has to be re-initialized for each new sampling frequency. If an external clock with a large jitter is fed in a fixed frequency should be selected instead of the Auto setting.

"8 kHz" Standard sampling rate 8 kHz

"11.025 kHz" Standard sampling rate 11.025 kHz

"16 kHz"	Standard sampling rate 16 kHz
"22.05 kHz"	Standard sampling rate 22.05 kHz
"32 kHz"	Standard sampling rate 32 kHz
"44.1 kHz"	Standard sampling rate 44.1 kHz
"48 kHz"	Standard sampling rate 48 kHz
"88.2 kHz"	Standard sampling rate 88.2 kHz
"96 kHz"	Standard sampling rate 96 kHz
"176.4 kHz"	Standard sampling rate 176.4 kHz
"192 kHz"	Standard sampling rate 192 kHz
"384 kHz"	Standard sampling rate 384 kHz
"Value"	Numeric input of the sampling frequency



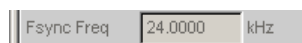
Remote command:

[OUTPut: SAMPlE: MODE](#) on page 859

[OUTPut: SAMPlE: FREQuency](#) on page 863

Fsync Freq

Is only displayed for multi-sample formats. The Frame Sync frequency corresponds to the sampling frequency divided by the samples/frame factor.



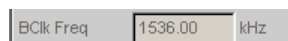
Remote command:

[OUTPut: FSYNc: FREQuency?](#) on page 865

BCLK Freq

Display of the bit clock frequency. Is the product of slot length * no of slots * sample freq / samples/frame.

Value range: 6.75 kHz to 55.296 MHz



Remote command:

[OUTPut: BCLK: FREQuency?](#) on page 862

Fsync Width

Width of the FSYNC pulse



"1 bit" The FSYNC pulse is one data bit in length (BCLK period)

"1 Slot" The FSYNC pulse is the length of an audio channel (= slot length)

- "Square" The FSYNC pulse has the shape of a symmetrical rectangle. If the number of the slot's bit clock (BCLK) cycles is odd the high phase is one cycle longer than the low phase (if Fsync slope = rising)
- "Value " The length of the FSYNC pulse corresponds to the numeric value in data bits (BCLK period).
Value range: 1 to (Slot Length*No of Slots) -1

Remote command:

[OUTPut:FWIDth](#) on page 865

[OUTPut:FWIDth:VALue](#) on page 865

Fsync Offset

Determines the offset of the Fsync pulse relative to the reference point (start of the first slot).

Value range: -Slot Length*(No of Slots) to +Slot Length*(No of Slots)-1



Remote command:

[OUTPut:FOFFset](#) on page 865

Fsync Slope

Polarity of the Fsync pulse



"Rising" The FSYNC pulse begins with a positive edge.

"Falling" The FSYNC pulse begins with a negative edge.

Remote command:

[OUTPut:FSLope](#) on page 865

BCLK Slope

Bit clock polarity (BCLK)



- "Rising" The TX_FSYNC_OUT, TX_SLCLK_OUT, TX_DATA1, TX_DATA2, TX_DATA3 and TX_DATA4 signals are sampled with a rising bit clock edge (relative to TX_BCLK_IN in slave mode or TX_BCLK_OUT in master operation and with internal synchronization).
In case of external synchronization, the TX_FSYNC_IN signal is always sampled with the reverse bit clock edge (TX_BCLK_IN). In this case, with the **falling** edge of the external bit clock signal.

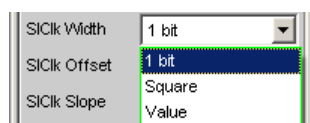
"Falling" The TX_FSYNC_OUT, TX_SLCLK_OUT, TX_DATA1, TX_DATA2, TX_DATA3 and TX_DATA4 signals are sampled with a falling bit clock edge (relative to TX_BCLK_IN in slave mode or TX_BCLK_OUT in master operation and with internal synchronization).
In case of external synchronization the TX_FSYNC_IN signal is always sampled with the reverse bit clock edge (TX_BCLK_IN). In this case with the **rising** edge of the external bit clock signal.

Remote command:

[OUTPut:BSLope](#) on page 864

SIClk Width

Slot clock pulse (SIClk) width



"1 bit" The SIClk pulse is one data bit in length (BCLK period).

"Square" The SIClk pulse has the shape of a symmetrical rectangle. If the number of the slot's bit clock (BCLK) cycles is odd the high phase is one cycle longer than the low phase (with SIClk slope = rising).

"Value " The length of the SIClk pulse corresponds to the numeric value in data bits (BCLK periods).
Value range: 1 to slot length-1

Remote command:

[OUTPut:SLCWidth](#) on page 867

SIClk Offset

Determines the slot clock (SIClk) offset relative to the start of the slot.

Value range: -slot length to + slot length-1



Remote command:

[OUTPut:SLCOffset](#) on page 867

SIClk Slope

Slot clock (SIClk) pulse polarity.



"Rising" The SIClk pulse begins with a positive edge.

"Falling" The SIClk pulse begins with a negative edge.

Remote command:

[OUTPut:SLCSlope](#) on page 867

MClk Ratio

Relationship between the master clock (MCLK) and FrameSync (FSYNC).

Value range: 16 ... 768

$MClk_Ratio * Sample_Freq \leq 110,592 \text{ MHz}$

MClk Ratio	<input type="text" value="16"/>
------------	---------------------------------

Remote command:

[OUTPut:MRATio](#) on page 866

BClk Jitt Freq

The generator output signals (TX_BCLK_OUT, TX_FSYNC_OUT, TX_SLCLK_OUT, TX_DATA1 to 4) can be jittered sinusoidally. The jitter oscillator frequency is set with this parameter.

Value range: 100 mHz to 110 MHz max (depending on the amplitude set).

BClk Jitt Freq	<input type="text" value="1000.00"/>	Hz
----------------	--------------------------------------	----

Remote command:

[OUTPut:BCLock:JITFrequency](#) on page 864

BClk Jitt Ampl

The generator output signals (TX_BCLK_OUT, TX_FSYNC_OUT, TX_SLCLK_OUT, TX_DATA1 to 4) can be jittered sinusoidally. This parameter determines the jitter oscillator peak amplitude.

Value range: 0 to 2.5 UI max (depending on the set frequency).

One UI corresponds to the bit clock (BClk) cycle period.

BClk Jitt Ampl	<input type="text" value="0.00000"/>	UI
----------------	--------------------------------------	----

Remote command:

[OUTPut:BCLock:JITAmplitude](#) on page 864

MClk Jitt Freq

The TX_MCLK_OUT generator signal can be jittered sinusoidally. The jitter oscillator frequency is set with this parameter.

Value range: 100 mHz to 110 MHz max (depending on the amplitude set).

MClk Jitt Freq	<input type="text" value="1000.00"/>	Hz
----------------	--------------------------------------	----

Remote command:

[OUTPut:MCLock:JITFrequency](#) on page 866

MClk Jitt Ampl

The TX_MCLK_OUT generator signal can be jittered sinusoidally. This parameter determines the jitter oscillator peak amplitude.

Value range: 0 to 2.5 UI max (depending on the set frequency).

One UI corresponds to the master clock (MCLK) cycle period.

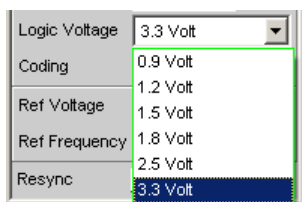
MClk Jitt Ampl	<input type="text" value="0.00000"/>	UI
----------------	--------------------------------------	----

Remote command:

[OUTPut:MCLock:JITAmplitude](#) on page 866

Logic Voltage

Used to set the generator logic voltage. Changing the voltage level causes the probe to be reloaded.



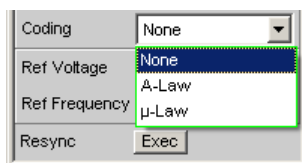
"0.9 volt"	0.9 volts CMOS logic voltage
"1.2 volt"	1.2 volts CMOS logic voltage
"1.8 volt"	1.8 volts CMOS logic voltage
"2.5 volt"	2.5 volts CMOS logic voltage
"3.3 Volt"	3.3 volts LVTTTL logic voltage

Remote command:

[OUTPut:LOGVoltage](#) on page 865

Coding

Generator data coding regulation. A-law and μ -law quantification characteristics are available for telephony applications.



"None"	Generator data is analyzed linearly PCM coded.
"A-Law"	Generator data is quantified in accordance with A Law.
" μ -Law"	Generator data is quantified in accordance with μ Law.

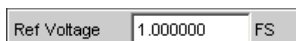
Remote command:

[OUTPut:CODing](#) on page 864

Ref Voltage

Reference value for the relative amplitude units.

If this reference value is changed, all amplitude settings linked to the reference value also change.



Remote command:

[SOURce:VOLTage:REFerence](#) on page 856

Ref Frequency

Reference value for the relative frequency units.

If the reference frequency is changed, all frequency settings linked to the reference value also change.

Ref Frequency	1000.00	Hz
---------------	---------	----

Remote command:

[SOURce:FREQuency:REFeRence](#) on page 856

Resync

Using this function triggers renewed synchronization of the generator. If this is synchronized externally, this function must be called once after applying the external clock signal

Resync	Exec
--------	------

Remote command:

[OUTPut:RESync](#) on page 866

5.5.2 Meaning of the TX_DATA 1 to TX_DATA 4 setting line strings

Setting strings for standard formats with one sample per frame:

If the generator is configured with the following setting lines, each slot within a frame contains the same sample of the selected signal source. The exemplary format visualized below corresponds to current converter formats.

Gen1 z.B. 96	Gen2 z.B. 45	Gen1 z.B. 96	Gen2 z.B. 45	Gen1 z.B. 100	Gen2 z.B. 57	Gen1 z.B. 100	Gen2 z.B. 57
Slot 1	Slot 2	Slot 3	Slot 4	Slot 1	Slot 2	Slot 3	Slot 4
Frame1				Frame2			

In the TX_DATA1 to 4 setting lines the "Generator1", "Generator2", "Null" and "Tris-tate" signal sources can be separately assigned to the maximum 256 slots of any single data line.

Syntax:

<Source>:<Target>.<Target>.<Source>:<Target>.<Target>.<Target>.<Target> etc.

Signal sources:

- **Gen1** = keyword for Generator1
- **Gen2** = keyword for Generator2
- **Zero** = zeros are output
- **Tri** = output is switched to high impedance

The following targets are available:

- **n** = slot n (with n=1 to 256)

- **x-y** = slot x to slot y
- **all** = all slots
- **even/odd** = all even/odd slots

The individual target slots are separated from one another by dots (.). They can be addressed separately (e.g. 1. 2. 3.), specified as a range (e.g. 4-15) or addressed with the predefined "all", "even" or "odd" group designations. All undefined target slots are set to signal source zero by default.

Spaces are ignored by the software, even if they occur within keywords. The assignment commands can be written in any combination of capital and small letters. The setting string for any given data line is analyzed from left to right so that commands situated further to the right overwrite previous settings.

The combination of the **"Tri:ext"** keywords can occur at any position in the string and transfers the tristate control to the externally supplied TX_OE signal which has a higher priority than the OE control which can be set internally with the **"Tri:<target>"** command line.

The following applies for external OE control activated by **"Tri:ext"**:

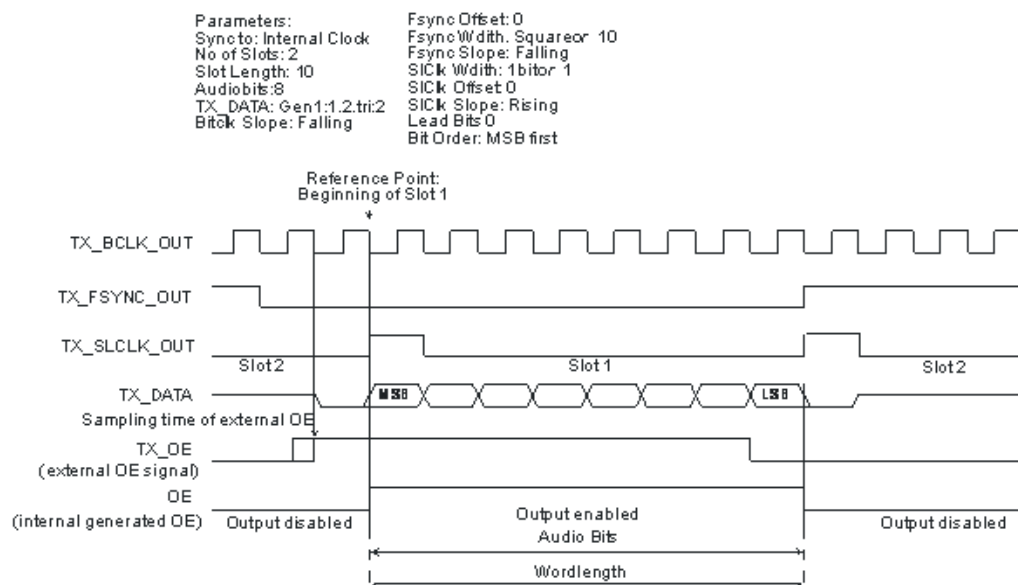
TX_OE = "1"

The generator behaves as defined in the string

TX_OE = "0"

The generator switches the data line to tristate for the duration of the low level, regardless of the content of the command string.

The external TX_OE does not function combinatorially but must be applied one cycle before the start of the slot or the desired action time. The signal is transferred with the same BClk edge with which the data is output. The following diagram shows how the external Output Enable signal works.



Examples for common setting strings:**gen1:even.1.3.5.Tri:ext**

All even slot numbers and also slots 1, 3 and 5 contain the audio signal generated in generator 1. The external tristate control is also switched on.

tri:all.gen1:1.3.6.gen2:3.4-6

Slot 1 transmits the audio signal generated in generator 1 whilst slots 3, 4, 5 and 6 contain the second generator's signal. All other slots are switched to tristate.

Setting strings for multi-sample formats with several samples per frame:

If the generator is configured with the following setting strings any sample from the selected signal source can be assigned to any slot within a frame; these can even be placed in any arbitrary order. This freedom of selection is intended for specific proprietary formats and permits all imaginable combinations. The following shows a format with two samples per frame which can be placed in any slot.

Gen1 S1 z.B. 96	Gen2 S2 z.B. 51	Gen1 S2 z.B. 98	Gen2 S1 z.B. 45	Gen1 S1 z.B. 100	Gen2 S2 z.B. 63	Gen1 S2 z.B. 102	Gen2 S1 z.B. 57
Slot 1	Slot 2	Slot 3	Slot 4	Slot 1	Slot 2	Slot 3	Slot 4
Frame1				Frame2			

In the TX_DATA1 to 4 setting lines the "Generator1", "Generator2", "Null" and "Tristate" signal sources can be separately assigned to the maximum 256 slots of any single data line. The transmission sequence of the individual samples is not important. Care must just be taken that the product of the number of signal sources (e.g. Gen1 and Gen2 = 2 signal sources) and the number of samples per frame remains smaller or equal to the number of slots. With three samples per frame and the use of both generator slots there must be at least six slots.

Syntax:

<source>-<sample number>:<target>.<target>.<source>-<sample number>:<target>.<target>.<target>. etc.

Signal sources:

- **Gen1** = keyword for generator 1
- **Gen2** = keyword for Generator2
- **Zero** = zeros are output
- **Tri** = output is switched to high impedance

The following targets are available:

- **n** = Slot n (with n=1...256)
- **x-y** = Slot x to Slot y
- **all** = all slots

- **even/odd** = all even/odd slots

The individual target slots are separated from one another by dots (.). They can be addressed separately (e.g. **1. 2. 3.**), specified as a range (e.g. **4-15**) or addressed under the specified group designations **"all"**, **"even"** or **"odd"**. Every undefined target slot is assigned **"Zero"** signal source by default.

Spaces are ignored by the software, even if they occur within keywords. The assignment commands can be written in any combination of capital and small letters.

The setting string for any given data line is analyzed from left to right so that commands situated further to the right overwrite previous settings.

The combination of the **"Tri:ext"** keywords can occur at any position in the string and transfers the tristate control to the externally supplied TX_OE signal which has a higher priority than the OE control which can be set internally with the **"Tri:<target>"** command line.

The following always applies for external OE control activated by **"Tri:ext"**:

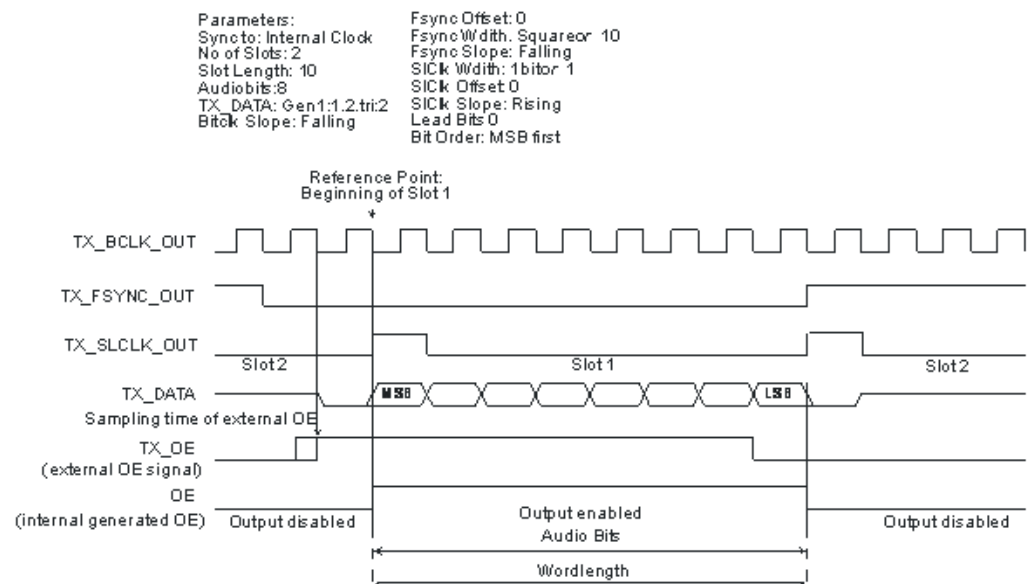
TX_OE = "1"

The generator behaves as defined in the string

TX_OE = "0"

The generator switches the data line to tristate for the duration of the low level, regardless of the content of the command string.

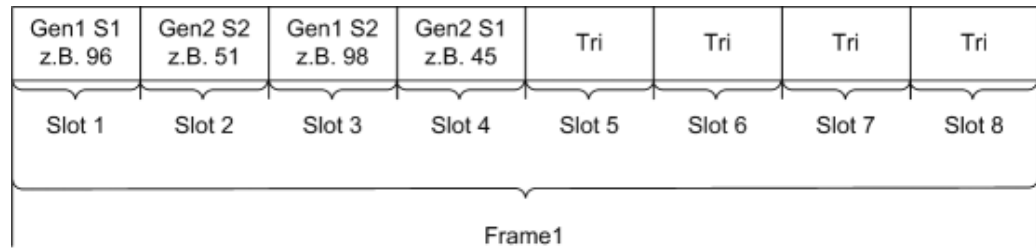
The external TX_OE does not function combinatorially, but must be applied one cycle before the start of the slot or the desired action time. The signal is transferred with the same BClk edge with which the date is output. The following diagram shows how the external Output Enable signal works.



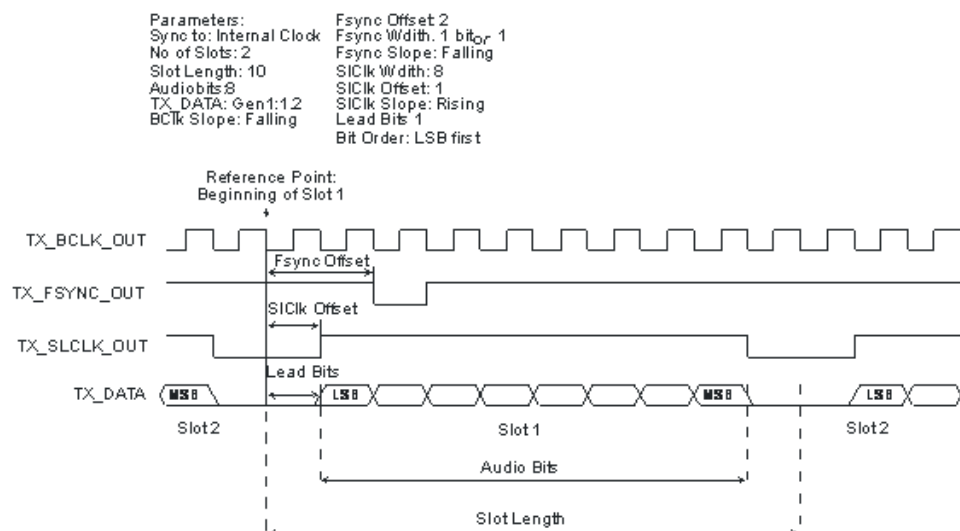
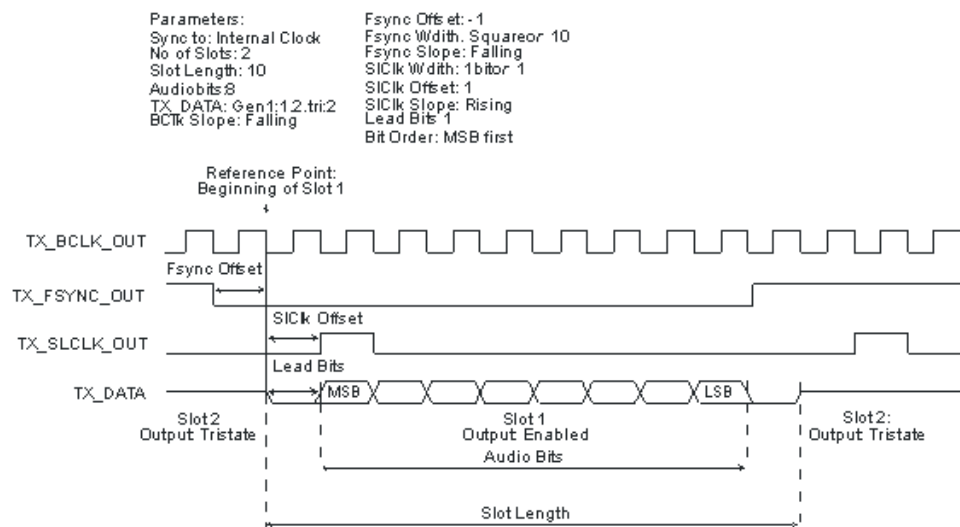
Examples of settings strings:

Tri:all.gen1-1:1.gen1-2:3.gen2-1:4.gen2-2:2

The samples from generator 1 are transmitted consecutively in slots 1 and 3, whilst the samples from generator 2 are located in reverse order in slots 2 and 4.

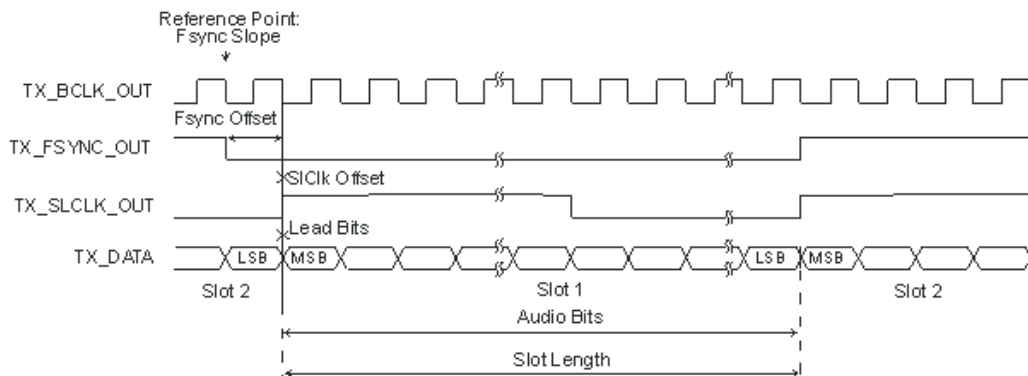


5.5.3 Timing Diagrams



Configuring the USI Dual Channel Generator

Parameters: SClk Width: Square or 16
 No of Slots: 2 SClk Offset: 1
 Slot Length: 32 SClk Slope: Rising
 Audiobits: 32 Lead Bits: 0
 TX_DATA: Gen1:1.Gen2:2 Bit Order: MSB first
 Fsync Offset: -1
 Fsync Width: Square or 32
 Fsync Slope: Falling



5.5.4 Interface Assignment

Pin	Signal	(I)input (O)utput	Signal description	Pin	Signal	(I)input (O)utput	Signal description
1	TX_MCLK_OUT	A	Master clock output generator	14	GND		Ground terminal
2	GND		Ground terminal	15	TX_DATA1	A	Serial Data 1 generator
3	TX_MCLK_IN	E	Master clock input generator	16	GND		Ground terminal
4	GND		Ground terminal	17	TX_DATA2	A	Serial Data 2 generator
5	TX_BCLK_OUT	A	Serial clock output generator	18	GND		Ground terminal
6	GND		Ground terminal	19	TX_DATA3	A	Serial Data 3 generator
7	TX_BCLK_IN	E	Serial clock generator	20	GND		Ground terminal
8	GND		Ground terminal	21	TX_DATA4	A	Serial Data 4 generator

Configuring the USI Dual Channel Generator

Pin	Signal	(I)input (O)utput	Signal description	Pin	Signal	(I)input (O)utput	Signal description
9	TX_FSYN C_OUT	A	Frame Sync out- put gener- ator	22	GND		Ground ter- minal
10	GND		Ground terminal	23	TX_OE	E	Output enable generator
11	TX_FSYN C_IN	E	Frame Sync input generator	24	TX_RESE RVED1		Reserved for future expansion
12	GND		Ground terminal	25	TX_RESE RVED2		Reserved for future expansion
13	TX_SLCLK _OUT	A	Channel clock out- put gener- ator	26	TX_RESE RVED3		Reserved for future expansion

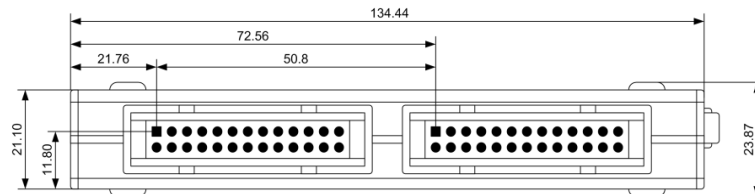
"CLK IN (BNC connector) "

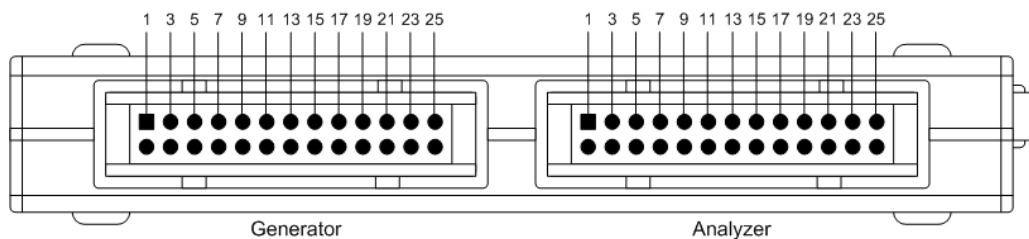
Connection	Signal	Input (I) Output (O)	Signal description
	CLK_IN	E	Reserved for future expansion

"CLK OUT (BNC connector) "

Connection	Signal	Input (I) Output (O)	Signal description
	CLK_OUT	A	Reserved for future expansion

"Probe Generator/Analyzer Layout: "



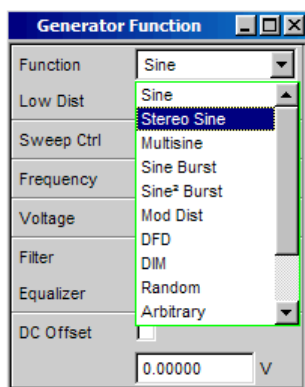


"Recommended PCB plug connector:"

TYCO AMP LATCH 2-827745-6

5.6 Generator Signals

The section "Generator Signals" describes the setting parameters for all signals which can be generated at the analog or digital outputs. The signals are selected using the "Function" selection field in the "Generator Function" panel. The selected function determines which parameter fields are available in the panel.



The panels for the analog and digital generator are almost identical; the settings are therefore described together. Any differences are indicated.

5.6.1 Sine

The generator generates a sine-wave signal. Frequency and level are the same for both channels.

SCPI command:

[SOURce:FUNCTION](#) on page 869

Low Dist

In the analog generator, the extremely low-noise and low-distortion generator (R&S UPV-B1 option) instead of the universal generator can be used to generate a sine-wave signal. The maximum frequency is 185 kHz, irrespective of the bandwidth configured in the Generator Config panel.

This parameter field does not appear in the digital generator.

"ON"

Low Dist

The low-distortion generator is activated.
A DC offset is not possible; the parameter field is grayed out.

DC Offset

No filters can be used; the parameter field is hidden.

Note: When the low-distortion generator is switched on, the Gen Track measuring modes and times should be avoided in the analyzer, as less accurate measurement results must be expected because the frequency setting is not quartz-accurate.

"OFF "

Low Dist

The low-distortion generator is switched off; the frequency setting is quartz-accurate and, depending on the bandwidth, is limited to 80 kHz.

Remote command:

[SOURCE:LOWDistortion](#) on page 869

Dither

Dither	<input checked="" type="checkbox"/>
	0.00010 FS
PDF	Triangle
Sweep Ctrl	Gauss
	Triangle
Frequency	Rectangle

In the digital generator, a noise component with adjustable amplitude can be superimposed on the signal. The checkbox enables or disables this function. The distribution function for amplitude can be selected in the "PDF" parameter field.

The parameter fields for Dither and PDF do not appear in the analog generator.

Remote command:

[SOURCE:SINusoid:DITHer:STATe](#) on page 870

[SOURCE:SINusoid:DITHer](#) on page 869

[SOURCE:RANDom:PDF](#) on page 869

Sweep Ctrl

Used to activate the sweep system. The frequency or level of the signal can be varied within a selectable range from the start value to the stop value. If frequency or level is selected as the x-axis, the measured values can be displayed as a curve in the Sweep Graph graphical window.

Sweep points: Linear or logarithmic between Start and Stop or read out of the file.

Forwarding: Automatic in a defined time frame or synchronized to the measurement time of the analyzer. All setting parameters of the sweep system are described in detail in [chapter 5.10, "Sweeps"](#), on page 346.

Frequency

Used to set the frequency of the sine wave. The value range depends on the analog bandwidth set in the Generator Config panel or the digital clock rate. Sine-wave signals from digital generators can be generated up to 49.9 % of the sampling rate.

Note: If Gen Track is selected as the measurement time in the analyzer, the measurement time and generator frequency are synchronized such that the signal periods recorded during the measurement time contain an entire number of samples. If necessary the generator frequency is modified slightly to allow this to happen.

Remote command:

`SOURce:FREQuency<n2>` on page 868

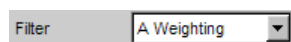
Voltage

Used to set the level of the sine wave. The maximum value depends on the configured DC offset. In the analog generator, the maximum total voltage also depends on the settings for Output Type and Max Voltage in the Generator Config panel.

Remote command:

`SOURce:VOLTAge<n2>` on page 870

Filter



The generator signal is filtered in the time domain. One of the user-definable filters in the Filter panel or a weighting filter can be selected. All level settings apply to the unfiltered signal.

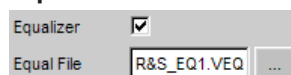
It is not possible to use a filter if the low-distortion oscillator is activated.

Remote command:

`SOURce:FILTer` on page 960

For a description of the filters and their setting parameters, see [chapter 5.43.4, "Filter Table"](#), on page 628.

Equalizer



The generator signal is equalized in the frequency domain using the file selected in the "Equal File" parameter field, see [chapter 5.8, "Equalization"](#), on page 339.

DC Offset



A DC offset is superimposed on the generator signal. This decreases the maximum possible AC voltage. The checkbox enables or disables this function. The value configured for the offset voltage is always displayed.

If the low-distortion generator is activated, no DC offset is possible; the parameter field is grayed out.

DC Offset

Remote command:

[SOURce:VOLTage:OFFSet<n3>:STATe](#) on page 871

[SOURce:VOLTage:OFFSet<n3>](#) on page 871

5.6.2 Stereo Sine

The generator generates a sine-wave signal on both channels. The frequency, level and phase can be set freely and separately for Channel 1 and 2.

In the analog generator, this function requires the R&S UPV-B3 option (second analog generator).

SCPI command:

[SOURce:FUNCTion](#) on page 869

Dither

Dither

0.00010 FS

PDF Triangle

Sweep Ctrl Gauss

Frequency Rectangle

In the digital generator, a noise component with adjustable amplitude can be superimposed on the signal. The checkbox enables or disables this function. The distribution function for amplitude can be selected in the "PDF" parameter field. The Dither setting is the same for both channels.

The parameter fields for Dither and PDF do not appear in the analog generator.

Remote command:

[SOURce:SINusoid:DITHer:STATe](#) on page 870

[SOURce:SINusoid:DITHer](#) on page 869

[SOURce:RANDom:PDF](#) on page 869

Freq Mode

This determines the frequency and phase setting for channel 1 and 2. The value range for frequency depends on the analog bandwidth set in the Generator Config panel or on the digital clock rate.

"f&Ph" Channel 1 and 2 have the same frequency but the phase between the two channels can be selected.
With the frequency sweep, the phase between the two channels remains constant.

"Ch1&2" The frequency can be entered separately for Channel 1 and 2. There is no fixed phase relationship between the channels. With the frequency sweep, the frequency of Channel 1 is swept but Channel 2 remains unchanged.

Note: If Gen Track is selected as the measurement time in the analyzer, measurement channel 1 follows the frequency of generator channel 1 and measurement channel 2 follows the frequency of generator channel 2.

Remote command:

[SOURce:FREQuency:SElect](#) on page 873

Volt Mode

This determines the setting of the level for channels 1 and 2. The maximum value depends on the configured DC offset. In the analog generator, the maximum total voltage also depends on the settings for Output Type and Max Voltage in the Generator Config panel.

"Ch2/1" The levels of Channel 1 and 2 have a fixed ratio relative to each other. With the level sweep, this ratio remains constant.

"Ch1&2" The level can be set separately for Channel 1 and 2. With the level sweep, the level of Channel 1 is swept but Channel 2 remains unchanged.

Remote command:

[SOURce:VOLTage:SElect](#) on page 874

Sweep Ctrl

Used to activate the sweep system. The frequency, phase or level of the signal can be varied within a selectable range from the start to the stop value. The Freq Mode and Volt Mode settings determine how frequencies and levels are changed during the sweep.

If frequency, phase or level is selected as the x-axis, the measured values can be displayed as a curve in the Sweep Graph graphical window.

Sweep points: Linear or logarithmic between Start and Stop or read out of the file.

Forwarding: Automatic in a defined time frame or synchronized to the measurement time of the analyzer. All setting parameters of the sweep system are described in detail in [chapter 5.10, "Sweeps"](#), on page 346.

Frequency

The frequency is identical for both channels (Freq Mode F&Ph).

Note: If Gen Track is selected as the measurement time in the analyzer, the measurement time and generator frequency are synchronized such that the signal periods recorded during the measurement time contain an entire number of samples. If necessary the generator frequency is modified slightly to allow this to happen.

Remote command:

[SOURce:FREQuency<n2>](#) on page 868

Freq Ch1

Frequency of Channel 1 (Freq Mode Ch1&2).

Note: If Gen Track is selected as the measurement time in the analyzer, measurement channel 1 follows the frequency of generator channel 1. The generator frequency may be modified slightly so that the signal periods measured during the measurement time contain a sufficient number of samples.

Remote command:

[SOURce:FREQuency<n2>](#) on page 868

Volt Ch1

Level of Channel 1.

Remote command:

[SOURce:VOLTage<n2>](#) on page 870

Phase Ch2/1

Phase of Channel 2 relative to Channel 1 (Freq Mode F&Ph).

Remote command:

[SOURce:PHASe<n2>](#) on page 873

Freq Ch2

Frequency of Channel 2 (Freq Mode Ch1&2).

Note: If Gen Track is selected as the measurement time in the analyzer, measurement channel 2 follows the frequency of generator channel 2. The generator frequency may be modified slightly so that the signal periods measured during the measurement time contain a sufficient number of samples.

Remote command:

[SOURce:FREQuency:CH2Stereo](#) on page 873

Volt Ch2

Level of Channel 2 (Volt Mode Ch1&2).

Remote command:

[SOURce:VOLTage:CH2Stereo](#) on page 873

Volt Ch2/1

Ratio of the level of both channels relative to Channel 1 (Volt Mode Ch2/1).

Remote command:

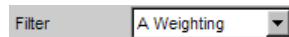
[SOURce:VOLTage:RATio](#) on page 874

Filter

The filter can be selected for both channels together (Track) or separately from each other (Split).

Remote command:

[SOURce:FILTer:CHANnels](#) on page 872

Filter / Filter Ch1

Common filter for channel 1 and channel 2, if "Track" filter was selected. Filter for channel 1, if "Split" filter was selected.

The generator signal is filtered in the time domain. One of the user-definable filters in the Filter panel or a weighting filter can be selected. All level settings apply to the unfiltered signal

Remote command:

[SOURce:FILTer](#) on page 960

For a description of the filters and their setting parameters, see [chapter 5.43.4, "Filter Table"](#), on page 628.

Filter Ch2

Filter for channel 2, if "Split" filter was selected.

The generator signal is filtered in the time domain. One of the user-definable filters in the Filter panel or a weighting filter can be selected. All level settings apply to the unfiltered signal

Remote command:

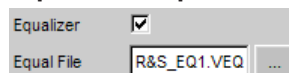
[SOURce:STEReo<n2>:FILTer](#) on page 961

Equalizer

The equalizer can be selected for both channels together (Track) or separately from each other (Split).


Remote command:

[SOURce:VOLTage:EQualize:CHANnels](#) on page 873

Equalizer / Equalizer Ch1

Common equalizer for channel 1 and channel 2, if "Track" equalizer was selected. Equalizer for channel 1, if "Split" equalizer was selected.

The generator signal is equalized in the frequency domain using the file selected in the "Equal File/Equal File Ch1" parameter field. The checkbox enables or disables this function. The equalization is the same for both channels.

The  button opens a browser in which you can select the equalizer file, refer also to [chapter 5.8, "Equalization"](#), on page 339.

Remote command:


[SOURce:VOLTage:EQualize](#) on page 870

[MMEMory:LOAD:OEQualize](#) on page 868

Equalizer Ch2

Equalizer for channel 2, if "Split" equalizer was selected.

The generator signal is equalized in the frequency domain using the file selected in the ""Equal File CH2"" parameter field. The checkbox enables or disables this function. The equalization is the same for both channels.

The  button opens a browser in which you can select the equalizer file, refer also to [chapter 5.8, "Equalization"](#), on page 339.

Remote command:

[MMEMory:LOAD:STEReo<n3>:OEQualize](#) on page 872

[SOURce:VOLTage:STEReo<n3>:EQualize](#) on page 874

DC Offset



A DC offset is superimposed on the generator signal. This decreases the maximum possible AC voltage. The checkbox enables or disables this function. The value configured for the offset voltage is always displayed.

Remote command:

[SOURce:VOLTage:OFFSet<n3>:STATe](#) on page 871

DC Offset



The DC Offset can be selected for both channels together (Track) or separately (Split).

Remote command:

[SOURce:VOLTage:OFFSet<n3>:CHANnels](#) on page 874

Offset Ch1

Common DC Offset for channel 1 and channel 2, if "Track" DC Offset was selected. DC Offset for channel 1, if "Split" DC Offset was selected.

Remote command:

[SOURce:VOLTage:OFFSet<n3>](#) on page 871

Offset Ch2

DC Offset for channel 2, if "Split" DC Offset was selected.

Remote command:

[SOURce:VOLTage:OFFSet<n3>:STATe](#) on page 871

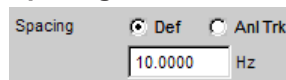
5.6.3 Multisine

The generator generates a multitone signal with up to 32 sine-wave tones. The frequency, level and phase can be freely selected for each tone. However, it is also possible to optimize the phase so that the ratio of peak value to RMS value is minimal, as is often required in the case of noise-like signals. Owing to the absence of associated windowing, linking the frequency grid of the multi-sinewave to the resolution of the FFT allows extremely fast frequency response measurement.

SCPI command:

[SOURce:FUNctIon](#) on page 869

Spacing



Used to set the frequency grid. The frequency of each sine-wave line is an integer multiple of this frequency grid.

- "Def" The frequency grid can be freely defined.
Minimum value: Sampling rate/262144
- "Anl Trk" The frequency grid is adopted from the FFT set in the analyzer. This value depends on the sampling rate and the size of the FFT. This setting is only possible if an FFT or Post FFT is selected in the analyzer. The parameter field for entering values is then hidden.

Remote command:

[SOURce:RANDom:SPACing:MODE](#) on page 875

[SOURce:RANDom:SPACing:FREQuency](#) on page 875

Voltage Mode

Used to select the entry mode for the voltages of the individual sine-wave tones.

- "Equal" All sine-wave lines have the same amplitude. It is entered in the "Volt No1" parameter field.
- "Define" A separate amplitude can be defined for each sine-wave line.

Remote command:

[SOURce:FUNctIon:MODE](#) on page 875

Crest Factor

The "peak value to RMS value" ratio (crest factor) of the signal can be influenced by the phase of the individual sine-wave lines.

- "Optimized" The ratio of peak value to RMS value of the signal is minimized.
- "Define Phase" The start phase of each sine-wave line can be defined.

Remote command:

[SOURce:VOLTagE:CREStfactor:MODE](#) on page 875

No of Sine

Used to set the number of sine-wave tones of the multisine-wave signal.

Remote command:

[SOURce:MULTisine:COUNT](#) on page 875

Freq No i

Sets the frequency of the sine wave number *i* of the multisine-wave signal.

Based on the internal programming, several sine waves of the same frequency cannot have different phase references. The phase of the first sine wave is set, the phase information of the other ones is ignored and represented as non-changeable.

Remote command:

[SOURce:FREQuency<n2>](#) on page 868

Phase No i

Used to set the start phase of sine wave number i of the multisine-wave signal. This parameter field only appears if Define Phase is selected for Crest Factor.

Based on the internal programming, several sine waves of the same frequency cannot have different phase references. The phase of the first sine wave is set, the phase information of the other ones is ignored and represented as non-changeable.

Remote command:

`SOURce:PHASe<n2>` on page 873

Volt No i

Used to set the voltage of sine wave number i of the multisine-wave signal. The maximum value depends on the configured DC offset. In the analog generator, the maximum total voltage also depends on the settings "Output Type " on page 239 and "Max Voltage" on page 241 in the Generator Config panel.

Remote command:

`SOURce:VOLTagE<n2>` on page 870

Total Gain

Used to set a gain factor which can be used to vary the total level of the multisine-wave signal. The maximum value depends on the configured DC offset. In the analog generator, the maximum total voltage also depends on the settings "Output Type " on page 239 and "Max Voltage" on page 241 in the Generator Config panel.

Remote command:

`SOURce:VOLTagE:TOTal:GAIN` on page 876

Total Peak

Indicates the peak value of the multi-sine-wave signal.

Remote command:

`SOURce:VOLTagE:TOTal` on page 876

Total RMS

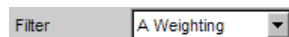
Indicates the RMS value of the multisine-wave signal (only in the analog generator).

Remote command:

`SOURce:VOLTagE:RMS` on page 876

Amplitude variation

The amplitude of the signal can be varied in sinusoidal or pulse (burst) form with a selectable frequency (see [chapter 5.7, "Amplitude Variation"](#), on page 338).

Filter

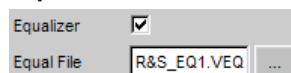
The generator signal is filtered in the time domain. One of the user-definable filters in the Filter panel or a weighting filter can be selected. All level settings apply to the unfiltered signal

Remote command:

[SOURce:FILTer](#) on page 960

For a description of the filters and their setting parameters, see [chapter 5.43.4, "Filter Table"](#), on page 628.

Equalizer



The generator signal is equalized in the frequency domain using the file selected in the "Equal File" parameter field, see [chapter 5.8, "Equalization"](#), on page 339.

DC Offset



A DC offset is superimposed on the generator signal. This decreases the maximum possible AC voltage. The checkbox enables or disables this function. The value configured for the offset voltage is always displayed.

Remote command:

[SOURce:VOLTage:OFFSet<n3>:STATe](#) on page 871

[SOURce:VOLTage:OFFSet<n3>](#) on page 871

5.6.4 Sine Burst

The generator generates a sine-wave signal, the amplitude of which changes periodically between high level (Voltage) during the burst duration (On Time) and low level (Low Level) during the burst pause. The "Interval" parameter field is used to set the repetition rate of the burst. The following always applies: Burst pause = Burst period (Interval) – Burst duration (On Time). Low Level can be set as a fixed value or as a ratio relative to the burst level.

Generator Function	
Function	Sine Burst
Sweep Ctrl	Off
Frequency	1000.000 Hz
Voltage	0.10000 V
Low Level	0.00000 V
On Time	0.01000 s
Interval	1.00000 s
Burst on Delay	0.00000 s
Filter	Off
Equalizer	<input type="checkbox"/>
DC Offset	<input type="checkbox"/>
	0.00000 V

When generator settings have been changed or a measurement has been started, the burst starts with the positive sinusoidal half-wave of the burst duration (On Time). The "Burst On Delay" parameter is used to set a defined delay time.

SCPI command:

[SOURce:FUNCTION](#) on page 869

Sweep Ctrl

Used to activate the sweep system. The frequency, level, ON-time and interval of the burst signal can be varied within a selectable range from the start to the stop value. If one of these parameters is selected as the x-axis, the measured values can be displayed as a curve in the Sweep Graph graphical window.

The individual sweep points are calculated linear or logarithmic between start and stop values or read out of a file.

The individual sweep points are automatically forwarded in a defined time grid or synchronized to the measurement time of the analyzer. All setting parameters of the sweep system are described in detail in [chapter 5.10, "Sweeps"](#), on page 346.

Frequency

Used to set the frequency of the sine wave. The value range depends on the analog bandwidth set in the Generator Config panel or the digital clock rate.

Remote command:

[SOURce:FREQuency<n2>](#) on page 868

Voltage

Used to set the level of the sine wave during the burst duration. The maximum value depends on the configured DC offset. In the analog generator, the maximum total voltage also depends on the settings for Output Type and Max Voltage in the Generator Config panel.

Remote command:

[SOURce:VOLTage<n2>](#) on page 870

Low Level

Used to set the level of the sine wave during the burst pause. Low Level cannot be higher than the Voltage; if Voltage is reduced (also during a sweep), Low Level may also be reduced. Low Level can also be set as a fixed ratio relative to Voltage; the units %on, dBon and (in the analog generator only) V/on are available for this purpose.

Remote command:

[SOURce:VOLTage:LOWLevel](#) on page 877

On Time

Used to set the burst duration. Entered as a fixed time or as a number of periods (cycles) of the sine-wave frequency.

On Time is always less than Interval; if increased, Interval may also be increased.

Minimum value: 1 Sample

Maximum value: 60 s – 1 Sample

Remote command:

[SOURce:ONTime](#) on page 877

Interval

Used to set the repetition rate of the burst signal. Entered as a fixed time or as a number of periods (cycles) of the sine-wave frequency. Interval is always greater than or equal to On Time.

Minimum value: On Time

Maximum value: 60 min

Remote command:

[SOURce:INTerval](#) on page 877

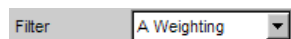
Burst on Delay

Used to set the delay time which must expire (after generator settings have been changed or a measurement has been started) before the generator can start the burst with the high level (Voltage). During this time, the signal is output with the low level (Low Level).

Value range 0 to 60 s.

Remote command:

[SOURce:ONTime:DELay](#) on page 877

Filter

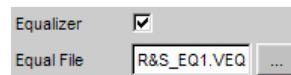
The generator signal is filtered in the time domain. One of the user-definable filters in the Filter panel or a weighting filter can be selected. All level settings apply to the unfiltered signal

Remote command:

[SOURce:FILTer](#) on page 960

For a description of the filters and their setting parameters, see [chapter 5.43.4, "Filter Table"](#), on page 628.

Equalizer



The generator signal is equalized in the frequency domain using the file selected in the "Equal File" parameter field. The checkbox enables or disables this function.

The button opens a browser in which you can select the equalizer file, refer also to [chapter 5.8, "Equalization"](#), on page 339.

Remote command:

[SOURce:VOLTage:EQUalize](#) on page 870

[MMEMory:LOAD:OEQualize](#) on page 868

DC Offset



A DC offset is superimposed on the generator signal. This decreases the maximum possible AC voltage. The checkbox enables or disables this function. The value configured for the offset voltage is always displayed.

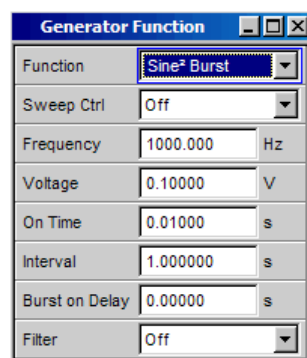
Remote command:

[SOURce:VOLTage:OFFSet<n3>:STATe](#) on page 871

[SOURce:VOLTage:OFFSet<n3>](#) on page 871

5.6.5 Sine² Burst

The generator generates a sine² signal, the amplitude of which is periodically activated (during the burst duration, i.e. On Time) and deactivated. The pulse can be inverted by entering a negative voltage.



The "Interval" parameter field is used to set the repetition rate of the burst. The following always applies: Burst pause = Burst period (Interval) – Burst duration (On Time).

The burst starts after generator settings have been changed or a measurement has been started. The "Burst On Delay" parameter is used to set a defined delay time.

SCPI command:

[SOURce:FUNCTion](#) on page 869

Sweep Ctrl

Used to activate the sweep system. The frequency, level, ON-time and interval of the burst signal can be varied within a selectable range from the start to the stop value. If one of these parameters is selected as the x-axis, the measured values can be displayed as a curve in the Sweep Graph graphical window.

Sweep points: Linear or logarithmic between Start and Stop or read out of the file.

Forwarding: Automatic in a defined time frame or synchronized to the measurement time of the analyzer. All setting parameters of the sweep system are described in detail in [chapter 5.10, "Sweeps"](#), on page 346.

Remote command:

[SOURce:SWEEp:CONTRol](#) on page 888

Frequency

Used to set the frequency of the sine wave. The value range depends on the analog bandwidth set in the Generator Config panel or the digital clock rate.

Remote command:

[SOURce:FREQuency<n2>](#) on page 868

Voltage

Used to set the level of the sine wave during the burst duration. The pulse is inverted by entering a negative voltage; conversion into logarithmic units is then not possible. In the analog generator, the maximum total voltage depends on the settings "[Output Type](#)" on page 239 and "[Max Voltage](#)" on page 241 in the Generator Config panel.

Remote command:

[SOURce:VOLTagE<n2>](#) on page 870

On Time

Used to set the burst duration. Entered as a fixed time or as a number of periods (cycles) of the sine-wave frequency. On Time is always less than Interval; if increased, Interval may also be increased.

Minimum value: 1 Sample

Maximum value: 60 s – 1 Sample

Remote command:

[SOURce:ONTime](#) on page 877

Interval

Used to set the repetition rate of the burst signal. Entered as a fixed time or as a number of periods (cycles) of the sine-wave frequency. Interval is always greater than or equal to On Time.

Minimum value: On Time

Maximum value: 60 min

Remote command:

[SOURce:INTerval](#) on page 877

Burst on Delay

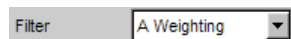
Used to set the delay time which must expire (after generator settings have been changed or a measurement has been started) before the generator can start the burst. During this time, the signal voltage is 0 V (or 0 FS in the digital domain).

Value range 0 to 60 s.

Remote command:

[SOURce:ONTime:DELay](#) on page 877

Filter



The generator signal is filtered in the time domain. One of the user-definable filters in the Filter panel or a weighting filter can be selected. All level settings apply to the unfiltered signal

Remote command:

[SOURce:FILTer](#) on page 960

For a description of the filters and their setting parameters, see [chapter 5.43.4, "Filter Table"](#), on page 628.

5.6.6 Mod Dist

The generator generates a test signal for the intermodulation measurement in accordance with SMPTE and for the modulation factor analysis in accordance with IEC 268-3.

The signal consists of two sine waves: a low-frequency unwanted signal and a high-frequency wanted signal. The level of the unwanted signal is 1 to 10 times as high as that of the wanted signal.

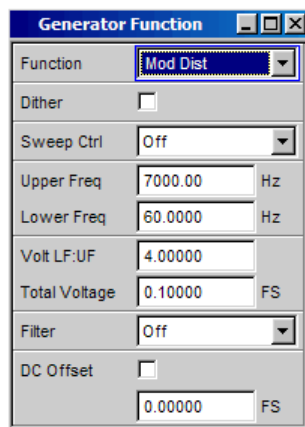
According to IEC 268-3, the frequency of the unwanted signal is between 0.5 and 1.5 octaves above the lower cutoff frequency of the DUT (60 Hz according to SMPTE).

According to IEC 268-3, the frequency of the wanted signal is between 0.5 and 1.5 octaves below the upper cutoff frequency of the DUT (7 kHz according to SMPTE).

The frequency ratio of wanted signal to unwanted signal should be greater than 8.

According to SMPTE, the level ratio of unwanted signal to wanted signal must be 4:1; according to IEC 268-3, a ratio of 10:1 is also possible.

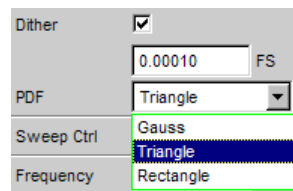
Panel of digital generator with Mod Dist function selected



SCPI command:

[SOURce:FUNCTION](#) on page 869

Dither



In the digital generator, a noise component with adjustable amplitude can be superimposed on the signal. The checkbox enables or disables this function. The distribution function for amplitude can be selected in the "PDF" parameter field.

The parameter fields for Dither and PDF do not appear in the analog generator.

Remote command:

[SOURce:SINusoid:DITHer:STATe](#) on page 870

[SOURce:SINusoid:DITHer](#) on page 869

[SOURce:RANDom:PDF](#) on page 869

Sweep Ctrl

Used to activate the sweep system. The frequency of the wanted signal (Upper Freq) or the total level (Total Voltage) of the signal can be varied within a selectable range from the start to the stop value. If frequency or level is selected as the x-axis, the measured values can be displayed as a curve in the Sweep Graph graphical window.

Sweep points: Linear or logarithmic between Start and Stop or read out of the file.

Forwarding: Automatic in a defined time frame or synchronized to the measurement time of the analyzer. All setting parameters of the sweep system are described in detail in [chapter 5.10, "Sweeps"](#), on page 346.

Remote command:

[SOURce:SWEep:CONTrol](#) on page 888

Upper Freq

Used to set the frequency of the high-frequency wanted signal.

Remote command:

`SOURce:FREQuency<n2>` on page 868

Lower Freq

Used to set the frequency of the low-frequency unwanted signal.

Remote command:

`SOURce:FREQuency<n2>` on page 868

Volt LF:UF

Used to set the level ratio of unwanted signal to wanted signal as a dimension-less number.

Remote command:

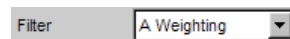
`SOURce:VOLTage:RATio` on page 874

Total Voltage

Used to set the level of the overall signal. The maximum RMS value depends on the level ratio. The maximum value depends on the configured DC offset. In the analog generator, the maximum total voltage also depends on the settings for Output Type and Max Voltage in the Generator Config panel.

Remote command:

`SOURce:VOLTage:TOTal` on page 876

Filter

The generator signal is filtered in the time domain. One of the user-definable filters in the Filter panel or a weighting filter can be selected. All level settings apply to the unfiltered signal

Remote command:

`SOURce:FILTer` on page 960

For a description of the filters and their setting parameters, see [chapter 5.43.4, "Filter Table"](#), on page 628.

DC Offset

A DC offset is superimposed on the generator signal. This decreases the maximum possible AC voltage. The checkbox enables or disables this function. The value configured for the offset voltage is always displayed.

Remote command:

`SOURce:VOLTage:OFFSet<n3>:STATe` on page 871

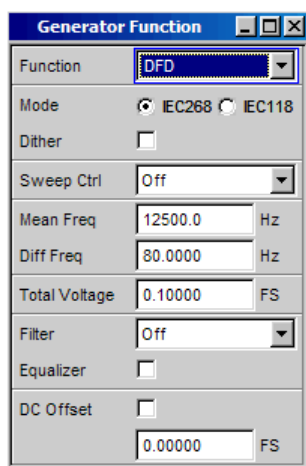
`SOURce:VOLTage:OFFSet<n3>` on page 871

5.6.7 DFD

The generator generates a test signal for the intermodulation measurement using the differential-tone method in accordance with IEC 118 or 268.

The signal consists of two very close sinewaves of the same amplitude.

Panel of digital generator with DFD function selected



SCPI command:

[SOURCE:FUNCTION](#) on page 869

Mode

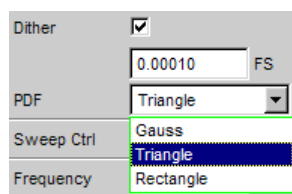
Used to select the entry mode for the frequencies of both signals.

- "IEC 268" Entry of center frequency (Mean Freq) and difference frequency (Diff Freq). If a frequency sweep (for the x or z-axis) is selected, the center frequency is swept.
- "IEC 118" Entry of upper frequency (Upper Freq) and difference frequency (Diff Freq). If a frequency sweep (for the x or z-axis) is selected, the upper frequency is swept.

Remote command:

[SOURCE:FUNCTION:MODE](#) on page 875

Dither



In the digital generator, a noise component with adjustable amplitude can be superimposed on the signal. The checkbox enables or disables this function. The distribution function for amplitude can be selected in the "PDF" parameter field.

The parameter fields for Dither and PDF do not appear in the analog generator.

Remote command:

[SOURCE:SINusoid:DITHer:STATe](#) on page 870

[SOURCE:SINusoid:DITHer](#) on page 869

[SOURCE:RANDom:PDF](#) on page 869

Sweep Ctrl

Used to activate the sweep system. The center frequency (in the IEC 118 mode) or the upper frequency (in the IEC 268 mode) or the total level (Total Voltage) of the signal can be varied within a selectable range from the start to the stop value. If frequency or level is selected as the x-axis, the measured values can be displayed as a curve in the Sweep Graph graphical window.

Sweep points: Linear or logarithmic between Start and Stop or read out of the file.

Forwarding: Automatic in a defined time frame or synchronized to the measurement time of the analyzer. All setting parameters of the sweep system are described in detail in [chapter 5.10, "Sweeps"](#), on page 346.

Remote command:

[SOURCE:SWEep:CONTRol](#) on page 888

Mean Freq

Used to set the center frequency (in the IEC 268 mode).

Remote command:

[SOURCE:FREQuency:MEAN](#) on page 878

Upper Freq

Used to set the upper frequency (in the IEC 118 mode).

Remote command:

[SOURCE:FREQuency<n2>](#) on page 868

Diff Freq

Used to set the frequency difference of the two sinewaves.

Remote command:

[SOURCE:FREQuency:DIFFeRence](#) on page 878

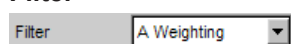
Total Voltage

Used to set the level of the overall signal. The maximum value depends on the configured DC offset. In the analog generator, the maximum total voltage also depends on the settings "[Output Type](#)" on page 239 and "[Max Voltage](#)" on page 241 in the Generator Config panel.

Remote command:

[SOURCE:VOLTage:TOTal](#) on page 876

Filter



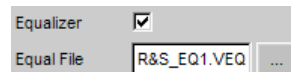
The generator signal is filtered in the time domain. One of the user-definable filters in the Filter panel or a weighting filter can be selected. All level settings apply to the unfiltered signal

Remote command:


[SOURce:FILTer](#) on page 960

For a description of the filters and their setting parameters, see [chapter 5.43.4, "Filter Table"](#), on page 628.

Equalizer



The generator signal is equalized in the frequency domain using the file selected in the "Equal File" parameter field. The checkbox enables or disables this function.

The  button opens a browser in which you can select the equalizer file, refer also to [chapter 5.8, "Equalization"](#), on page 339.

Remote command:

[SOURce:VOLTage:EQualize](#) on page 870

[MMEMory:LOAD:OEQualize](#) on page 868

DC Offset



A DC offset is superimposed on the generator signal. This decreases the maximum possible AC voltage. The checkbox enables or disables this function. The value configured for the offset voltage is always displayed.

Remote command:

[SOURce:VOLTage:OFFSet<n3>:STATe](#) on page 871

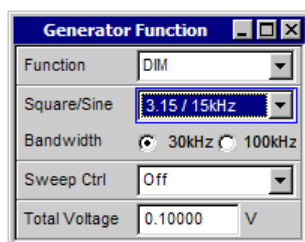
[SOURce:VOLTage:OFFSet<n3>](#) on page 871

5.6.8 DIM

The generator generates a test signal for measuring the dynamic intermodulation distortions in accordance with IEC 268-3. The R&S UPV-B3 option is required in order to generate this signal in the analog domain.

A high-frequency sine-wave signal is superimposed on a low-frequency square-wave signal. The square-wave signal is limited with respect to bandwidth using a first-order filter. The amplitude of the square-wave signal is 4 times higher than that of the sine-wave signal.

Panel of the generator for Function DIM:



SCPI command:

`SOURce:FUNction DIM`

Square Sine

Used to select the ratio between the frequencies of the square-wave signal and sine-wave signal.

"2.96/14" Square-wave signal 2.96 kHz, sine-wave signal 14.0 kHz

"3.15/15" Square-wave signal 3.15 kHz, sine-wave signal 15.0 kHz

"2.96/8" Square-wave signal 2.96 kHz, sine-wave signal 8.0 kHz

Remote command:

`SOURce:DIM` on page 879

Bandwidth

Selects the bandwidth (3 dB) of the first-order filter for band limitation of the square-wave signal

"30 kHz" Band limitation to 30 kHz

"100 kHz" Band limitation to 100 kHz

Remote command:

`SOURce:BANDwidth` on page 879

Sweep Ctrl

Used to activate the sweep system. The total level (Total Voltage) of the signal can be varied within a selectable range from the start to the stop value. If the level is selected as the x-axis, the measured values can be displayed as a curve in the Sweep Graph graphical window.

Sweep points: Linear or logarithmic between Start and Stop or read out of the file.

Forwarding: Automatic in a defined time frame or synchronized to the measurement time of the analyzer. All setting parameters of the sweep system are described in detail in [chapter 5.10, "Sweeps"](#), on page 346.

Remote command:

`SOURce:SWEep:CONTRol` on page 888

Total Voltage

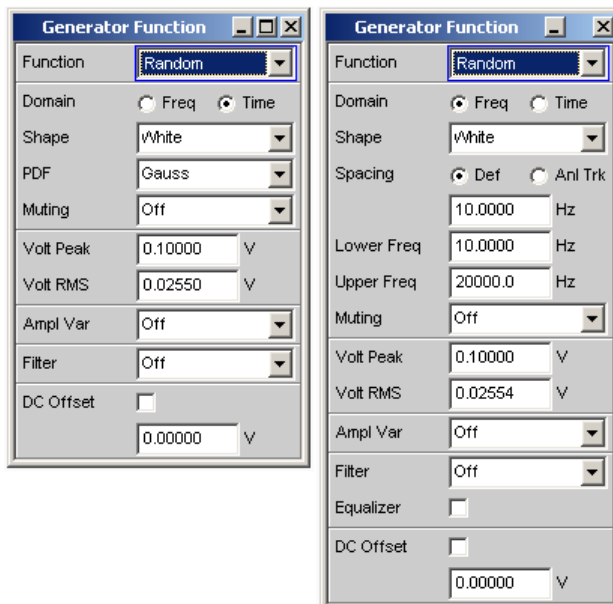
Used to set the level of the overall signal. The maximum value depends on the settings ["Output Type"](#) on page 239 and ["Max Voltage"](#) on page 241 in the Generator Config panel.

Remote command:

`SOURce:VOLTage:TOTal` on page 876

5.6.9 Random

The generator creates a noise signal whose properties can be defined either in the time or frequency domain.



Several thousand equidistant sine-wave lines in a selectable frequency domain

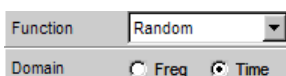
Special application:

If the frequency grid of the sine-wave lines generated here is identical to the analysis grid of the FFT, analysis can be performed without leakage in the FFT. It is therefore possible to obtain a selectivity of one line with the square-wave window. This type of generator/analyzer configuration allows frequency responses of DUTs to be determined in one go with high precision and selectivity.

SCPI command:

[SOURCE:FUNCTION](#) on page 869

Domain

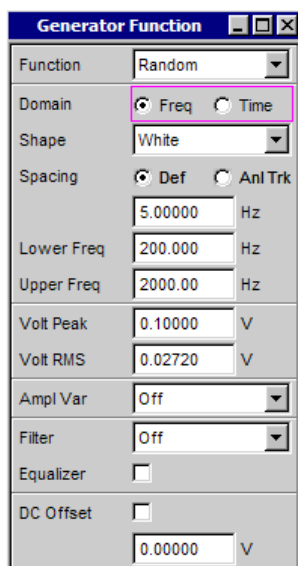


Used to select whether the characteristics of the noise signal are defined in the frequency or time domain.

"Freq"

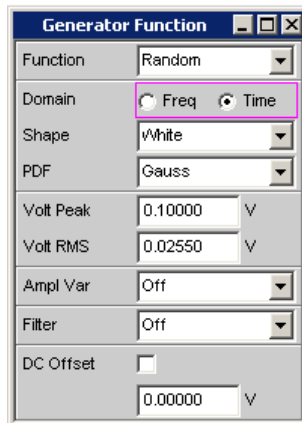
To generate the output signal, sine-wave lines with adjustable amplitude are generated and superimposed on each other with a defined frequency grid. Depending on the selectivity of the analyzer, the output signal is displayed not as a sequence of individual lines but as a noise signal with a continuous level versus frequency. The frequency-defined noise can be used to generate several thousand single tones of any given amplitude (multi-tone).

Panel used to define the noise signal in the frequency domain.



Note: The noise signals generated in the frequency domain have an audible periodicity, but this does not impair the measuring technology. A reduction of the periodicity can be achieved with refined frequency resolution and a correspondingly longer cycle duration. ARB files labeled "pseudoRandomxxxxk.arb" are available for this in the "User" folder, "xxx" being the FFT size expressed in k, which requires the same frequency grid when the sampling frequency of the generator and analyzer are identical.

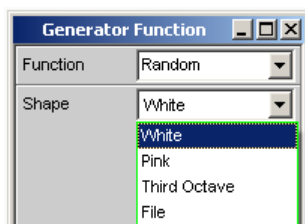
"Time" In this mode, noise signals are generated with interleaved random functions which have been optimized for uniformly distributed noise. Panel used to define the noise signal in the time domain.



Remote command:

[SOURce:RANDOM:DOMain](#) on page 880

Shape



Defines the amplitude distribution of the signal spectrum within a selectable frequency domain.

"White" Time domain:
Uncorrelated white noise without periodicity is produced.
Frequency range:
Uncorrelated white noise without periodicity is produced.

"Pink" Time domain:
WAV files for generating broadband pink noise that is free of periodicity, for the fixed frequencies between 11.025 kHz and 192 kHz (and thus for all configurable generator bandwidths) are available in the "User" directory. They can be played back using the "Play" generator function and are called `Pink_Noise_XXXXXX.WAV`, where `XXXXXX` designates the sampling rate in Hz.
Frequency range:
Pink noise. The amplitude of the sine-wave lines between the lower and upper cutoff frequency is proportional to the function $\sqrt{1/f}$, and thus is attenuated by 3 dB per octave. Measurements performed using a third-octave analyzer return a uniform frequency spectrum.

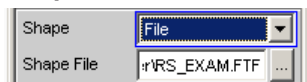
"Third Octave" Frequency domain only:
Pink noise with a bandwidth of one third octave. The center frequency is adjustable.

"File" Frequency domain only:
The amplitude distribution is read from the file which is displayed in the next parameter field "Shape File".

Remote command:


`SOURce:RANDom:SHAPE` on page 880

Shape File



Frequency domain, only with the selection "Shape File"

File containing the amplitude distribution.

The  button opens a browser that you can use to select the file.

"File format: "

ASCII file containing max. 8192 amplitude values which have to be entered as a sequence of numbers (value range FLOAT). The file must contain one line with the keyword "FREQUENCY_FILE" before the number sequence. Comment lines must begin with '#' and can be used anywhere in the file. No distinction is made between upper-case and lower-case characters. The recommended and preset file extension is '.FTF'. However, due to the keyword "FREQUENCY_FILE" which must always be entered, it is also possible to use any other file extension.

Beginning at 0 Hz, the amplitudes of the individual frequency lines must be entered as dimensionless numerical values. The numbers only indicate the amplitude ratio of the lines with respect to each other and not the output amplitude. It is set after the phase optimization according to the value defined in the "Volt Peak" parameter field. Since the ratio of peak value to RMS value is calculated internally, it is also possible to enter the RMS value.

The frequency grid is derived from the "Spacing" setting defined in the panel. Alternatively it can also be defined in the file. To do so, the keyword "frequency_spacing" (not case-sensitive) must be specified, followed by the value in Hz. If this value is less than the minimum value: (sampling rate/16384), the minimum value is set.

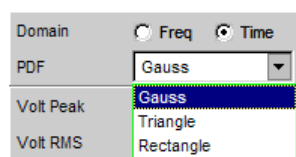
Example: rs_exam.ftf in the directory D:\UPV\User

In addition to this file format, an equalization file (example: rs_exam.veq in the directory D:\UPV\User) can be loaded as a shape file. The amplitudes of individual frequency lines are set with respect to the equalization frequency response. The noise signal band is limited to the frequency range defined in the equalization file.

Remote command:

`MMEMoRY:LOAD:...`

PDF



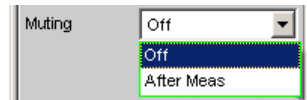
only time domain

The distribution function for amplitude can be selected in the "PDF" parameter field.

Remote command:

[SOURce:RANDom:PDF](#) on page 869

Muting



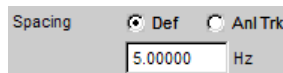
This gives the option of switching off the generator when the measurement is completed and the generator signal is no longer needed.

- "Off" The generator signal always remains switched on, independently of the measurement. This setting is necessary if the generator is operation without the analyzer, or if the DUT requires a long settling time.
- "After Meas" The generator signal is switched off as soon as the (single) measurement is completed. When a continuous measurement is in progress, the generator signal also remains on continuously. This setting is necessary if the measurement function or the DUT requires a low level before beginning the measurement. When the measurement is started, the generator signal is automatically switched on. Since no signal is present before the measurement is started, a potential delay of the DUT must be taken into account as "Start Cond Delay".

Remote command:

[SOURce:PLAY:MUTing](#) on page 882

Spacing



Used to set the frequency grid. The frequency of each sine-wave line is an integer multiple of this frequency grid.

- "Def" The frequency grid can be freely defined.
Minimum value: Sampling rate/16384
If frequency grid has been defined in the file, the parameter field where a value would be entered for this setting is grayed out and the value is displayed instead.

"Anl Trk" The frequency grid is adopted from the FFT set in the analyzer. This value depends on the sampling rate and the size of the FFT. This setting is only possible if an FFT or Post FFT is selected in the analyzer. The parameter field where a value would be entered for this setting is grayed out and the value is displayed.

Note: The finest frequency grid corresponds to an FFT size of 16 k. ARB files labeled "pseudoRandomxxxk.arb" are available for measuring longer FFTs – and, therefore, smaller frequency grid – in the "User" folder, whereby "xxx" is the FFT size expressed in k, to which the frequency grid of the generator is dimensioned. The prerequisite is that the generator and analyzer are operated at the same sampling rate/same analog bandwidth.

Remote command:

[SOURce:RANDOM:SPACing:MODE](#) on page 875

[SOURce:RANDOM:SPACing:FREQuency](#) on page 875

Lower Freq

Used to define the lower frequency limit of the noise signal if Shape is set to White or Pink.

Remote command:

[SOURce:RANDOM:FREQuency:LOWer](#) on page 880

Upper Freq

Used to define the upper frequency limit of the noise signal if Shape is set to White or Pink.

Remote command:

[SOURce:RANDOM:FREQuency:UPPer](#) on page 880

Mean Freq

Used to set the center frequency in the case of third-octave noise.

Remote command:

[SOURce:FREQuency:MEAN](#) on page 878

Volt Peak

Used to enter the peak value of the noise signal. The maximum value depends on the configured DC offset. In the analog generator, the maximum total voltage also depends on the settings for Output Type and Max Voltage in the Generator Config panel.

The peak value to RMS value ratio of the signal (crest factor) is minimized. If the noise is defined in the time domain, the selected distribution function for amplitude determines the crest factor.

Remote command:

[SOURce:VOLTage:TOTal](#) on page 876

Volt RMS

Used to enter the RMS value of the noise signal (only in the analog generator). The peak value to RMS value ratio of the signal (crest factor) is minimized. If the noise is defined in the time domain, the selected distribution function for amplitude determines the crest factor.

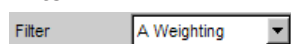
Remote command:

`SOURce:VOLTage:RMS` on page 876

Amplitude variation

The amplitude of the signal can be varied in sinusoidal or pulse (burst) form with a selectable frequency, see [chapter 5.7, "Amplitude Variation"](#), on page 338.

Filter



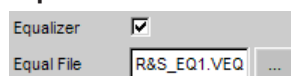
The generator signal is filtered in the time domain. One of the user-definable filters in the Filter panel or a weighting filter can be selected. All level settings apply to the unfiltered signal

Remote command:

`SOURce:FILTer` on page 960

For a description of the filters and their setting parameters, see [chapter 5.43.4, "Filter Table"](#), on page 628.

Equalizer



The generator signal is equalized in the frequency domain using the file selected in the "Equal File" parameter field. The checkbox enables or disables this function.

These parameter fields are hidden if time-domain noise (Domain Time) is selected.

The button opens a browser in which you can select the equalizer file, refer also to [chapter 5.8, "Equalization"](#), on page 339.

Remote command:

`SOURce:VOLTage:EQualize` on page 870

`MMEMory:LOAD:OEQualize` on page 868

DC Offset



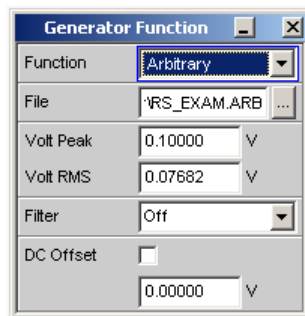
A DC offset is superimposed on the generator signal. This decreases the maximum possible AC voltage. The checkbox enables or disables this function. The value configured for the offset voltage is always displayed.

Remote command:

`SOURce:VOLTage:OFFSet<n3>:STATe` on page 871

`SOURce:VOLTage:OFFSet<n3>` on page 871

5.6.10 Arbitrary



The generator generates a freely definable curve shape which is read out from a file as a sequence of samples. The maximum length is 262144 (256 k) samples. When output, the curve is repeated continuously in an unbroken sequence. If a measurement is restarted (Start button), the curve starts again from the beginning of the file. The individual samples are output at the sampling rate selected in the generator.


SCPI command:

[SOURce:FUNCtion](#) on page 869

File



File from which the curve shape is read.

The  button opens a browser that you can use to select the file.

File format:

ASCII file with max. 524288 (512 k) samples. The individual samples are entered as a sequence of numbers (value range -1.0 to +1.0). The file must contain one line with the keyword "TIMETAB_FILE" before the number sequence. Comment lines must begin with '#' and can be used anywhere in the file. No distinction is made between upper-case and lower-case characters. The recommended and preset file extension is '.ARB'. However, due to the keyword "TIMETAB_FILE" which must always be entered, it is also possible to use any other file extension.

The numerically highest value (Maximum) is output with the peak voltage set in the "Volt Peak" entry field; the other samples are level-controlled according to their ratio to the maximum. Since the ratio of peak value to RMS value is calculated internally from the samples, it is also possible to enter the RMS value.

Example: rs_exam.arb in the D:\UPV\User directory

Remote command:

[MMEMory:LOAD:ARBitrary](#) on page 880

Volt Peak

Used to enter the peak value of the arbitrary signal. The maximum value depends on the configured DC offset. In the analog generator, the maximum total voltage also depends on the settings "Output Type" on page 239 and "Max Voltage" on page 241 in the Generator Config panel. The peak value and RMS value are interlinked by means of the crest factor.

Remote command:

`SOURce:VOLTage:TOTal` on page 876

Volt RMS

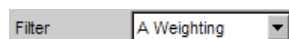
Used to enter the RMS value of the arbitrary signal (only in the analog generator). The peak value and RMS value are interlinked by means of the crest factor.

Remote command:

`SOURce:VOLTage:RMS` on page 876

Amplitude variation

The amplitude of the signal can be varied in sinusoidal or pulse (burst) form with a selectable frequency, see [chapter 5.7, "Amplitude Variation"](#), on page 338.

Filter

The generator signal is filtered in the time domain. One of the user-definable filters in the Filter panel or a weighting filter can be selected. All level settings apply to the unfiltered signal

Remote command:

`SOURce:FILTer` on page 960

For a description of the filters and their setting parameters, see [chapter 5.43.4, "Filter Table"](#), on page 628.

DC Offset

A DC offset is superimposed on the generator signal. This decreases the maximum possible AC voltage. The checkbox enables or disables this function. The value configured for the offset voltage is always displayed.

Remote command:

`SOURce:VOLTage:OFFSet<n3>:STATe` on page 871

`SOURce:VOLTage:OFFSet<n3>` on page 871

5.6.11 Play

This function enables any WAV file to be replayed. These can – but do not have to – be generated using the Record measuring function (refer also to [chapter 5.36.6, "Create WAV files for external sweeps"](#), on page 597). Coded audio signals are not decoded, but instead are played back to the DUT unchanged.

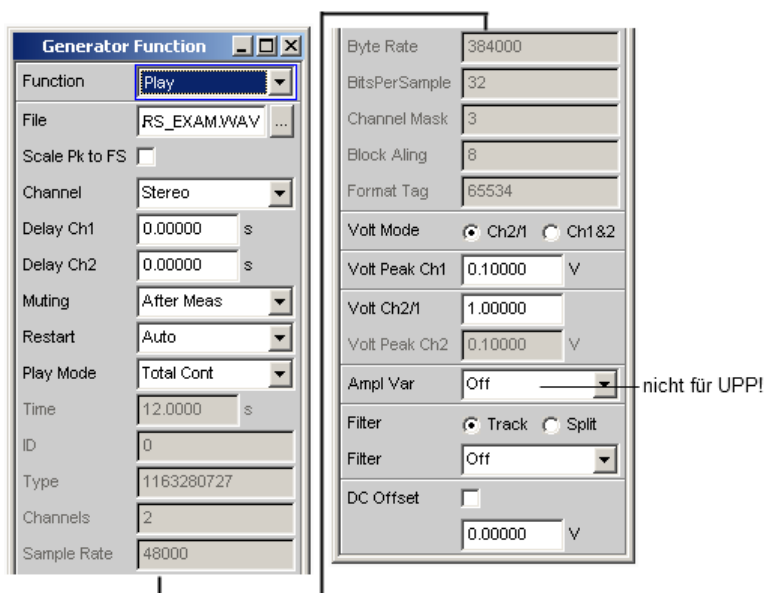
This generator function covers the following cases:

- Offline analysis of data streams that have been recorded using the "Record" analyzer function or some other suitable recording instrument.
- Playing back specific speech and music signals for special measurements in mobile radio or for gearing aids,
- Playing back specific test sequences, such as for external sweeps.
- Data source for coded audio signals that are intended to be decoded by a connected DUT.

For offline analysis, the generator is operated not with the DUT, but directly (internally, if possible) using the R&S UPV analyzer, which then carries out all desired measurements. All available interfaces (preferably digital) can be used for this. Thus a previously analog sample signal can be examined losslessly, for example during offline analysis, via one of the optional R&S UPV digital interfaces.

Playback starts immediately after the WAV file has been successfully loaded. Every time a generator setting is changed or START is pressed, playback restarts.

Panel of the analog generator for the Play function.



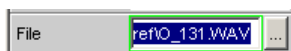
This panel also displays information about the WAV header. The meanings attached to this information are dependent on the format (standard or extended) and may be inferred from the WAV specification.


SCPI command:

[SOURce:FUNCTION](#) on page 869

File

For entering the drive, path and file name of the WAV file from which the waveform will be read.



The  button opens a browser that you can use to select the WAV file.

Since the file is read online during playback, only data media having a high transfer rate are suitable. These include the data partition of the hard drive or a network drive with at least 100 Mbit/s. USB sticks and drives should be used only for files of less than 0.5 Msamples.

When the file name has been entered, the WAV file header information is displayed in the panel and playback starts. This process also checks whether the configured sampling rate (or bandwidth in the analog generator) matches the sampling rate stored in the WAV file. If necessary, a warning is displayed; however, the sampling rate used is always that configured in the Config panel of the generator.

Note: In the analog generator, the sampling rate is calculated from the configured bandwidth (see "[Bandwidth](#)" on page 380). The special Play Auto setting causes the sampling rate stored in the WAV file to be used, thus also making it possible to play back WAV files with uneven sampling rates (e.g. 44.1 kHz) in the analog generator.

Remote command:

[MMEMory:LOAD:ARBitrary](#) on page 880

Scale Pk to FS



Enables optional scaling up of samples in order to obtain full control.

"Deactivated:" The samples from the WAV file are output without change. This mode enables the WAV file to be loaded faster, since it does not need to be fully scanned.

WAV files that are already fully controlled should be used in this mode.

"Activated:" The WAV file is searched for the highest sample and is scaled during playback in such a way that the highest occurring sample reaches exactly to full scale and is therefore output with the specified peak voltage.

In the case of poorly controlled WAV files, this mode improves the dynamic range of the analog generator.

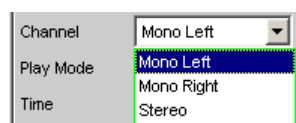
Note: Because in order to determine the scaling factor, the entire WAV file must be searched when loading, the loading process – particularly for long files – takes somewhat longer in this mode.

Remote command:

[SOURce:PLAY:SCALEpktofs](#) on page 882

Channel

Only for stereo WAV files; enables a single WAV channel to be played back as a mono signal on both generator channels.



This selection is not available for mono WAV files; they are always output on both generator channels.

Note: Whether a signal is actually output at both generator channels depends, as for all generator signals, on the menu item of the same name in the Generator Config panel.

"Mono Left" The left WAV channel is output on all active generator channels.

"Mono Right" The right WAV channel is output on all active generator channels.

"Stereo" The left WAV channel is output on generator channel 1, the right on channel 2.

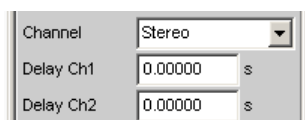
In the analog generator, stereo mode can be enabled only if the R&S UPV-B3 option is installed. Therefore, this menu item appears there only if the R&S UPV-B3 option is installed.

Remote command:

[SOURce:PLAY:CHANnel](#) on page 881

Delay Ch1, Delay Ch2

Delayed start of one or both WAV channels.



Only selectable if a stereo WAV file was loaded and played back in stereo mode.

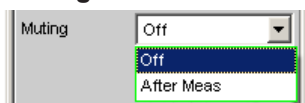
Enables the delayed start of one or both WAV channels. An interchannel delay can be defined by entering different values for left and right; in "Single" play mode, the output of the channel started first (the channel with the shorter delay) stops earlier by the delay difference. The maximum delay is 1 s with a sampling rate of 48 kHz or 22 kHz bandwidth. Less accordingly for higher sampling rates/bandwidths.

Note: As soon as at least one of the two delays > 0 s, both "Cont" modes (even for short file or play length) are played back online: Result: Higher performance utilization.

Remote command:

[SOURce:PLAY:DELAy<n3>](#) on page 881

Muting



This gives the option of switching off the generator when the measurement is completed and the generator signal is no longer needed.

"Off" The generator signal always remains switched on, independently of the measurement. This setting is necessary if the generator is operation without the analyzer, or if the DUT requires a long settling time.

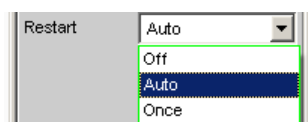
"After Meas" The generator signal is switched off as soon as the (single) measurement is completed. When a continuous measurement is in progress, the generator signal also remains on continuously. This setting is necessary if the measurement function or the DUT requires a low level before beginning the measurement. When the measurement is started, the generator signal is automatically switched on. Since no signal is present before the measurement is started, a potential delay of the DUT must be taken into account as "Start Cond Delay".

Remote command:

[SOURce:PLAY:MUTing](#) on page 882

Restart

Determines the behavior of the play file with generator settings.



"Off" The signal is muted immediately. If the level changes, the playback of the play file is not interrupted. Level changes include the settings "Volt Peak Ch1", "Volt Peak Ch2", "Volt Ch2/1", "Ampl Var", "Filter" and "DC Offset". For all other generator settings that change the physical properties of the signal, the signal is muted. Only the activation of the item "Once" or START causes the playback of the play file to restart.

"Auto" The playback of the play file is restarted with **any** setting in the generator panel.

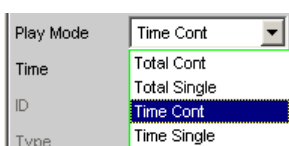
"Once" Forces the restart of the playback of the play file only once.

Remote command:

[SOURce:PLAY:REStart](#) on page 882

Play Mode

Determines the playback mode of the loaded WAV file.



"Total Cont" The complete WAV file is played back in a loop; when the end of the file is reached, playback jumps back to the beginning of the file without interruption.

Note: During the jump back, the signal normally becomes discontinuous, which for pure sine-wave signals, is visible as noise in the spectrum close to the carrier.

"Total Single" The complete WAV file is played back once, after which the generator is muted.

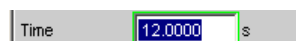
- "Time Cont" The beginning of the WAV file is played back in a loop; after the playback time selected in the next menu field expires, playback jumps back to the beginning of the file without interruption.
- "Time Single" The beginning of the WAV file is played back once; after the playback time selected in the next menu field expires, playback stops and the generator is muted.

Remote command:

[SOURce:PLAY:MODE](#) on page 881

Time

Used to display or enter the playback duration.



The maximum playback duration is determined by the number of samples in the WAV file and the configured sampling rate and can be up to 24 hours.

Depending on the selected Play Mode, the playback duration can be

- displayed ("Play Mode Total ...") if the intention is to play back the WAV file in full;
- entered ("Play Mode Time ...") in order to reset or prematurely interrupt playback.

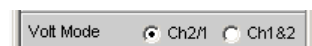
Note: If the sampling rate is increased subsequently, the playback duration may be reduced.

Remote command:

[SOURce:PLAY:TIME](#) on page 882

Volt Mode

This determines the setting of the level for channels 1 and 2.



A different leveling of channel 1 and 2 in the analog generator can be set only if the R&S UPV-B3 option is installed, otherwise this parameter field cannot be edited.

The maximum value depends on the configured DC offset. In the analog generator, the maximum total voltage also depends on the settings for Output Type and Max Voltage in the Generator Config panel.

"Ch2/1" The level of channel 2 is at a fixed ratio to the level of channel 1 and can be set as a factor with the command "Volt Ch2/1".

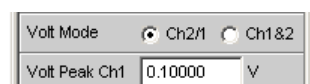
"Ch1&2" The level can be set separately for Channel 1 and 2.

Remote command:

[SOURce:VOLTage:SElect](#) on page 874

Volt Peak Ch1

Level of Channel 1.



Remote command:

[SOURce:VOLTage<n2>](#) on page 870

Volt Peak Ch2

A different leveling of channel 1 and 2 in the analog generator can be set only if the R&S UPV-B3 option is installed, otherwise this parameter field cannot be edited.

Level of channel 2 in "Volt Mode Ch1&2"

Remote command:

[SOURce:VOLTage:CH2Stereo](#) on page 873

Volt Ch2/1

Ratio of the level of both channels relative to channel 1 in "Volt Mode Ch2/1".

Volt Mode	<input checked="" type="radio"/> Ch2/1	<input type="radio"/> Ch1&2
Volt Peak Ch1	0.10000	V
Volt Ch2/1	1.00000	
Volt Peak Ch2	0.10000	V

A different leveling of channel 1 and 2 in the analog generator can be set only if the R&S UPV-B3 option (second analog generator) is installed, otherwise this parameter field cannot be edited.

Remote command:

[SOURce:VOLTage:RATio](#) on page 874

Amplitude variation

The amplitude of the signal can be varied in sinusoidal or pulse (burst) form with a selectable frequency (see [chapter 5.7, "Amplitude Variation"](#), on page 338).

Filter

Filter	<input checked="" type="radio"/> Track	<input type="radio"/> Split
--------	--	-----------------------------

The filter can be selected for both channels together (Track) or separately from each other (Split).

Remote command:

[SOURce:FILTer:CHANnels](#) on page 872

Filter / Filter Ch1

Filter	A Weighting
--------	-------------

Common filter for channel 1 and channel 2, if "Track" filter was selected. Filter for channel 1, if "Split" filter was selected.

The generator signal is filtered in the time domain. One of the user-definable filters in the Filter panel or a weighting filter can be selected. All level settings apply to the unfiltered signal

Remote command:

[SOURce:FILTer](#) on page 960

For a description of the filters and their setting parameters, see [chapter 5.43.4, "Filter Table"](#), on page 628.

Filter Ch2

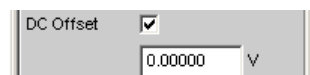
Filter for channel 2, if "Split" filter was selected.

The generator signal is filtered in the time domain. One of the user-definable filters in the Filter panel or a weighting filter can be selected. All level settings apply to the unfiltered signal

Remote command:

[SOURCE:STEReo<n2>:FILTer](#) on page 961

DC Offset



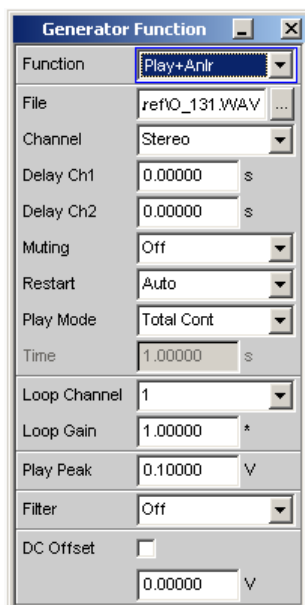
A DC offset is superimposed on the generator signal. This decreases the maximum possible AC voltage. The checkbox enables or disables this function. The value configured for the offset voltage is always displayed.

Remote command:

[SOURCE:VOLTage:OFFSet<n3>:STATe](#) on page 871

[SOURCE:VOLTage:OFFSet<n3>](#) on page 871

5.6.12 Play+Anlr



Using this function, you can play back any WAV file, and optionally superimpose on it a signal looped back from the analyzer. This function is needed to perform the stability margin measurement included in the GSM acoustic test cases 30.6.2. It can be selected only if the R&S UPV-K6 option is installed.

A file containing narrowband noise in line with ITU-T Recommendation O.131 should be used as a WAV file. A suitable file with the name O_131.WAV is supplied as standard and loaded as a default file.



The playback of coded audio signals is not meaningful since the superimposition of the analyzer feedback invalidates the coding of the generator signal.

The analyzer signal can be a mono signal taken from one measurement channel or a stereo signal taken from both measurement channels. It can be amplified or attenuated by a selectable factor.

To generate this special signal, a few conditions must be met:

- The active analog generator must be operated with a fixed analog gain. To this effect, "Volt Range" must be set to FIX and be assigned, as a minimum value, the value of the voltage maximally to be set.
- The active digital generator is to be synchronized to the analyzer. To this effect, "Sync To" must be set to "Audio In".
- The analyzer used must not be a multichannel instrument.

The "Play+Anlr" signal will not be available until the above conditions are met.

The following recommendations should be observed in addition:

- The analog analyzer channels should be operated with fixed level ranges in order to ensure a constant loop gain.
- An identical sampling rate should be used for the generator and the analyzer. As the WAV file provided was recorded at a sampling rate of 48 kHz, the digital sampling rate should likewise be 48 kHz; in the analog domain, you should work with a bandwidth of 22 kHz.
- The "analog" analyzer channels should be operated with fixed level ranges in order to ensure a constant loop gain.
- An identical sampling rate should be used for the generator and the analyzer. As the WAV file provided was recorded at a sampling rate of 48 kHz, the digital sampling rate should likewise be 48 kHz; in the analog domain, you should work with a bandwidth of 22 kHz.



To prevent operator errors, after enabling Play+Anlr in the analog generator, the bandwidth of the analog analyzer can no longer be selected manually; rather, it is set automatically to the generator bandwidth.

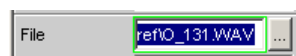
Playback starts immediately after the WAV file has been successfully loaded. Every time a generator setting is changed or the START key is pressed, playback restarts.


SCPI command:

[SOURce:FUNction](#) on page 869

File

Used to select the drive, directory and name of the WAV file from which the waveform is to be read.



The  button opens a browser that you can use to select the WAV file.

The file "O_131.WAV" is loaded as a default file. This file is supplied as standard and stored in the "C:\upv\config\ref" directory. It contains narrowband noise (white noise band-limited to 350 to 550 Hz) according to ITU-T Recommendation O.131, is modulated to FS and has a playing time of exactly 1 s at a sampling rate of 48 kHz.

After the file name has been entered, playback is started. This process also checks whether the configured sampling rate (or bandwidth in the analog generator) matches the sampling rate stored in the WAV file. If necessary, a warning is displayed; however, the sampling rate used is always that configured in the Config panel of the generator.

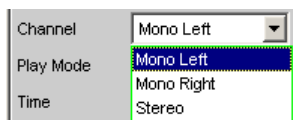
Note: In the analog generator, the sampling rate is calculated from the configured bandwidth (see "[Bandwidth](#)" on page 380). The special Play Auto setting cannot be used for the Play+Anlr function.

Remote command:

[MMEMory:LOAD:ARBitrary](#) on page 880

Channel

Only for stereo WAV files; enables a single WAV channel to be played back as a mono signal on both generator channels.



This selection is not available for mono WAV files; they are always output on both generator channels.

Note: Whether a signal is actually output at both generator channels depends, as for all generator signals, on the menu item of the same name in the Generator Config panel.

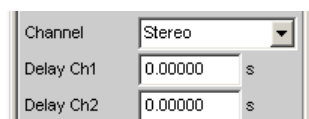
- "Mono Left" The left WAV channel is output on all active generator channels.
- "Mono Right" The right WAV channel is output on all active generator channels.
- "Stereo" The left WAV channel is output on generator channel 1, the right on channel 2.
In the analog generator, stereo mode can be enabled only if the R&S UPV-B3 option is installed. Therefore, this menu item appears there only if the R&S UPV-B3 option is installed.

Remote command:

[SOURce:PLAY:CHANnel](#) on page 881

Delay Ch1, Delay Ch2

Delayed start of one or both WAV channels.



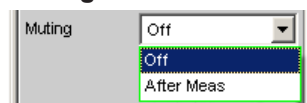
Enables the delayed start of one or both WAV channels. An interchannel delay can be defined by entering different values for left and right; in "Single" play mode, the output of the channel started first (the channel with the shorter delay) stops earlier by the delay difference. Only selectable if a stereo WAV file was loaded and played back in stereo mode. The maximum delay is 1 s with a sampling rate of 48 kHz or 22 kHz bandwidth. Less accordingly for higher sampling rates/bandwidths.

Note: As soon as at least one of the two delays > 0 s, both "Cont" modes (even for short file or play length) are played back online: Result: Higher performance utilization.

Remote command:

[SOURce:PLAY:DELAy<n3>](#) on page 881

Muting



This gives the option of switching off the generator when the measurement is completed and the generator signal is no longer needed.

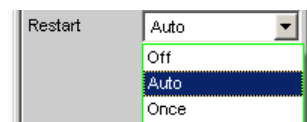
- "Off" The generator signal always remains switched on, independently of the measurement. This setting is necessary if the generator is operation without the analyzer, or if the DUT requires a long settling time.
- "After Meas" The generator signal is switched off as soon as the (single) measurement is completed. When a continuous measurement is in progress, the generator signal also remains on continuously. This setting is necessary if the measurement function or the DUT requires a low level before beginning the measurement. When the measurement is started, the generator signal is automatically switched on. Since no signal is present before the measurement is started, a potential delay of the DUT must be taken into account as "Start Cond Delay".

Remote command:

[SOURce:PLAY:MUTing](#) on page 882

Restart

Determines the behavior of the play file with generator settings.



- "Off" The signal is muted immediately. If the level changes, the playback of the play file is not interrupted. Level changes include the settings "Volt Peak Ch1", "Volt Peak Ch2", "Volt Ch2/1", "Ampl Var", "Filter" and "DC Offset". For all other generator settings that change the physical properties of the signal, the signal is muted. Only the activation of the item "Once" or START causes the playback of the play file to restart.
- "Auto" The playback of the play file is restarted with **any** setting in the generator panel.

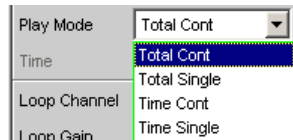
"Once" Forces the restart of the playback of the play file only once.

Remote command:

[SOURCE:PLAY:REStart](#) on page 882

Play Mode

Determines the playback mode of the loaded WAV file.



"Total Cont" The complete WAV file is played back in a loop; when the end of the file is reached, playback jumps back to the beginning of the file without interruption.

Note: During the jump back, the signal normally becomes discontinuous, which for pure sine-wave signals, is visible as noise in the spectrum close to the carrier.

"Total Single" The complete WAV file is played back once, after which the generator is muted.

When the O_131.WAV default file is used, this setting delivers noise for the duration of a second, which is followed by silence.

"Time Cont" The beginning of the WAV file is played back in a loop; after the playback time selected in the next menu field expires, playback jumps back to the beginning of the file without interruption.

"Time Single" The beginning of the WAV file is played back once; after the playback time selected in the next menu field expires, playback stops and the generator is muted.

Remote command:

[SOURCE:PLAY:MODE](#) on page 881

Time

Used to display or enter the playback duration.



The maximum playback duration is determined by the number of samples in the WAV file and the configured sampling rate and can be up to 24 hours.

Depending on the selected Play Mode, the playback duration can be

- It can be displayed if the entire WAV file is to be played ("Play Mode Total ...") or
- A value not exceeding the playback time of the loaded WAV file can be entered in order to stop or restart playback before the end of the file is reached ("Play Mode Time ...").

When using the file loaded by default, O_131.WAV, and a corrected sampling rate or bandwidth, 1 s is displayed here.

Note: If the sampling rate is increased subsequently, the playback duration may be reduced.

Remote command:

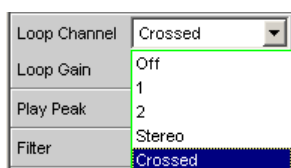
[SOURce:PLAY:TIME](#) on page 882

Loop Channel

Used to select the analyzer channel whose signal is to be looped back to the generator and to be superimposed on the noise signal.

The analyzer signal can be looped back in mono or stereo mode.

- In the mono mode, one of the two analyzer channels is looped back to both generator channels.
- In the stereo mode, both analyzer channels are looped back separately and superimposed on the generator channels.



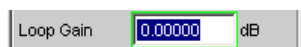
- "Off" Loopback is switched off. Only the WAV signal is played.
The loop gain can be set by means of the following menu item, but it is not active with loopback off.
- "1" Analyzer channel 1 is superimposed on both generator channels.
- "2" Analyzer channel 2 is superimposed on both generator channels.
- "Stereo" Analyzer channel 1 is superimposed on generator channel 1.
Analyzer channel 2 is superimposed on generator channel 2.
- "Crossed" Analyzer channel 1 is superimposed on generator channel 2.
Analyzer channel 2 is superimposed on generator channel 1.

Remote command:

[SOURce:LOOP:CHANnel](#) on page 883

Loop Gain

Used to set the gain for loopback of the analyzer signal.



The analyzer input signal of the selected channel is tapped ahead of the filters and superimposed on the generator signal without undergoing further division. The gain should be set such that the level of the input signal, after amplification, does not exceed the headroom allowed for the WAV playback signal.

Note: For signal addition, the sample of the level-controlled WAV signal is added to the corresponding sample of the amplified feedback signal and provided as an output sample of the generator. If the total exceeds the value of 1.0 FS, this output sample is limited to FS.

A value less than 1 (or less than 0 dB) results in attenuation of the analyzer signal.

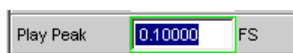
The feedback signal can be switched off by entering 0 (or -240 dB).

Remote command:

[SOURce:LOOP:GAIN](#) on page 883

Play Peak

Used to set the peak output level of the noise signal. This entry does not affect the loopback signal.



In the analog generator, the maximum total voltage depends on the settings for Output Type and Max Voltage in the Generator Config panel.

This voltage value is attained by those samples in the loaded WAV file that are driven to maximum level (+/- FS).

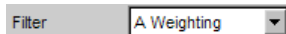
When entering the peak output level, it must be taken into account that the analyzer signal will be added to the entered value. An appropriate headroom must therefore be allowed for the analyzer signal. A peak level of 1.0 FS therefore only makes sense if the feedback is switched off or the WAV file used already has headroom, i.e. is not scaled to FS.

Note: No provision is made for automatic upscaling of the WAV signal as for the pure play function. The O.131 signal supplied as standard is already scaled to FS.

Remote command:

[SOURce:VOLTagE:TOTal](#) on page 876

Filter



The WAV playback signal is filtered in the time domain. This filtering has no effect on the loopback signal.

One of the user-definable filters in the Filter panel or a weighting filter can be selected. All level settings apply to the unfiltered signal

Remote command:

[SOURce:FILTer](#) on page 960

For a description of the filters and their setting parameters, see [chapter 5.43.4, "Filter Table"](#), on page 628.

DC Offset



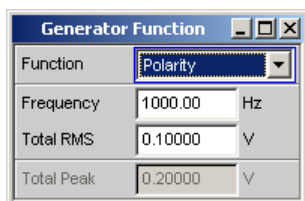
A DC offset is superimposed on the generator signal. This decreases the maximum possible AC voltage. The checkbox enables or disables this function. The value configured for the offset voltage is always displayed.

Remote command:

[SOURce:VOLTagE:OFFSet<n3>:STATe](#) on page 871

[SOURce:VOLTagE:OFFSet<n3>](#) on page 871

5.6.13 Polarity



The generator generates a test signal for polarity measurement. This measurement is used to check the polarity of the input signal transmitted by the DUT.

SCPI command:

[SOURce:FUNCTION](#) on page 869

The test signal consists of two sine waves, one of which is a fundamental and the other a harmonic, having the same amplitude in each case. The phase of the harmonic is selected so that the positive peak value is greater than the negative.

Frequency

Used to set the frequency of the fundamental.

Remote command:

[SOURce:FREQuency<n2>](#) on page 868

Total RMS

Used to set the level of the signal. In the analog generator, the maximum total voltage depends on the settings "[Output Type](#)" on page 239 and "[Max Voltage](#)" on page 241 in the Generator Config panel.

Remote command:

[SOURce:VOLTagE<n2>](#) on page 870

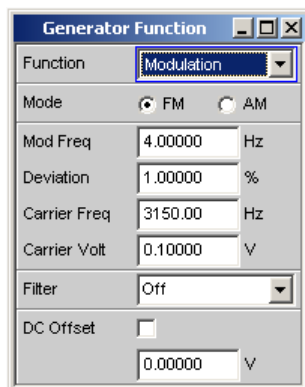
Total Peak

Used to display the peak value of the signal.

Remote command:

[SOURce:VOLTagE:TOTal](#) on page 876

5.6.14 Modulation



The generator generates a sine-wave signal which can be modulated with respect to frequency or amplitude according to a sinusoidal function.

SCPI command:

[SOURce:FUNction](#) on page 869

Mode

Selects the modulation format: Amplitude or frequency modulation

"FM" Frequency modulation

"AM" Amplitude modulation

Remote command:

[SOURce:FUNction:MODE](#) on page 875

Mod Freq

Used to set the modulation frequency.

Remote command:

[SOURce:FREquency<n2>](#) on page 868

Deviation / Mod Depth

With FM, **Deviation** is used to set the modulation deviation in % relative to the carrier frequency.

Mod Depth With AM, this parameter field is used to set the modulation depth in % relative to the carrier amplitude.

Remote command:

[SOURce:VOLTagE<n2>](#) on page 870

Carrier Freq

Used to set the carrier frequency.

Remote command:

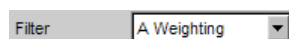
[SOURce:FREquency<n2>](#) on page 868

Carrier Volt

Used to set the level of the unmodulated sine-wave signal. With AM, only up to half the maximum value, so that 100 % AM can always be set. The maximum value depends on the configured DC offset. In the analog generator, the maximum total voltage also depends on the settings "Output Type" on page 239 and "Max Voltage" on page 241 in the Generator Config panel.

Remote command:

`SOURce:VOLTagE<n2>` on page 870

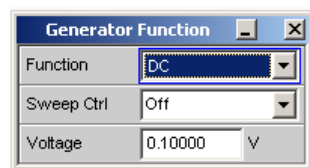
Filter

The generator signal is filtered in the time domain. One of the user-definable filters in the Filter panel or a weighting filter can be selected. All level settings apply to the unfiltered signal

Remote command:

`SOURce:FILTer` on page 960

For a description of the filters and their setting parameters, see [chapter 5.43.4, "Filter Table"](#), on page 628.

5.6.15 DC (Direct-Current Voltage)

The generator generates a DC voltage signal. Unlike the DC offset, it is possible to sweep this DC voltage.

SCPI command:

`SOURce:FUNction` on page 869

Sweep Ctrl

Used to activate the sweep system. The DC voltage can be varied within a selectable range from the start to the stop value. If the level is selected as the x-axis, the measured values can be displayed as a curve in the Sweep Graph graphical window.

Sweep points: Linear or logarithmic between Start and Stop or read out of the file.

Forwarding: Automatic in a defined time frame or synchronized to the measurement time of the analyzer. All setting parameters of the sweep system are described, see [chapter 5.10, "Sweeps"](#), on page 346.

Remote command:

`SOURce:SWEep:CONTRol` on page 888

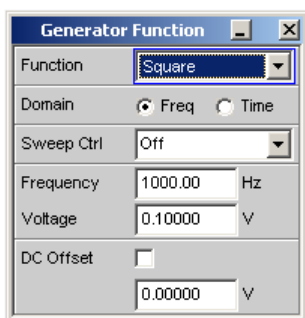
Voltage

DC voltage level. In the analog generator, the maximum value depends on the settings "Output Type" on page 239 and "Max Voltage" on page 241 in the Generator Config panel.

Remote command:

[SOURce:VOLTage:TOTal](#) on page 876

5.6.16 Square

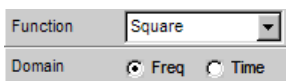


The generator produces a square-wave signal. Frequency and level are the same for both channels.

SCPI command:

[SOURce:FUNction](#) on page 869

Domain



Here it is possible to define whether the square-wave signal should be defined in the frequency or the time domain.

"Freq"

The square-wave signal is formed from a series of sine-wave oscillations whose amplitudes and phases are calculated correspondingly to the Fourier expansion of a rectangle. The maximum frequency of the fundamental wave is selected so that the spectrum reaches at least to the fifth fundamental wave. The frequency resolution is good. In the time domain, however, the signal shows overshooting that is necessitated by the theory of the system.

"Time" In the **analog domain**, possible only with the R&S UPV-B3 option (second generator channel, which also contains the square-wave generator). The frequency resolution is good. The edge slope corresponds to a first-order lowpass with a cutoff frequency of 100 kHz. A DC offset is not possible.

In the **digital domain**, the signal consists of a series of samples that switch between the positive and negative maximum value. Only subharmonics of the sampling frequency with an even number of sampling values can be produced so that the rectangle remains symmetrical. The frequency resolution becomes worse the more the frequencies increase. The time behavior is ideal.

Remote command:

[SOURce:RANDom:DOMain](#) on page 880

Sweep Ctrl

Used to activate the sweep system. The frequency or level of the signal can be varied within a selectable range from the start value to the stop value. If frequency or level is selected as the x-axis, the measured values can be displayed as a curve in the Sweep Graph graphical window.

Sweep points: Linear or logarithmic between Start and Stop or read out of the file.

Forwarding: Automatic in a defined time frame or synchronized to the measurement time of the analyzer. All setting parameters of the sweep system are described in detail in [chapter 5.10, "Sweeps"](#), on page 346.

Remote command:

[SOURce:SWEep:CONTRol](#) on page 888

Frequency

Sets the square-wave signal frequency. The value range depends on the analog bandwidth set in the Generator Config panel or the digital clock rate.

Remote command:

[SOURce:FREQuency<n2>](#) on page 868

Voltage

Sets the level RMS value of the square-wave signal. The maximum value depends on the configured DC offset. In the analog generator, the maximum total voltage also depends on the settings for Output Type and Max Voltage in the Generator Config panel.

Remote command:

[SOURce:VOLTage<n2>](#) on page 870

DC Offset



A DC offset is superimposed on the generator signal. This decreases the maximum possible AC voltage. The checkbox enables or disables this function. The value configured for the offset voltage is always displayed.

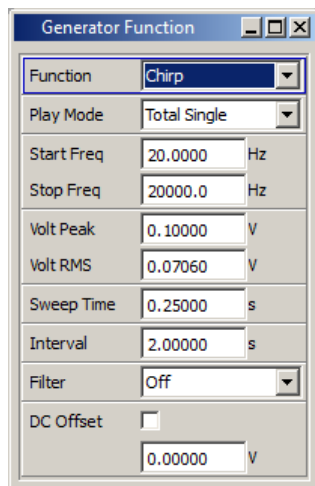
A DC offset in the time domain is not possible in the analog generator when the square-wave signal is generated; the parameter field is not visible.

Remote command:

`SOURce:VOLTage:OFFSet<n3>:STATe` on page 871

`SOURce:VOLTage:OFFSet<n3>` on page 871

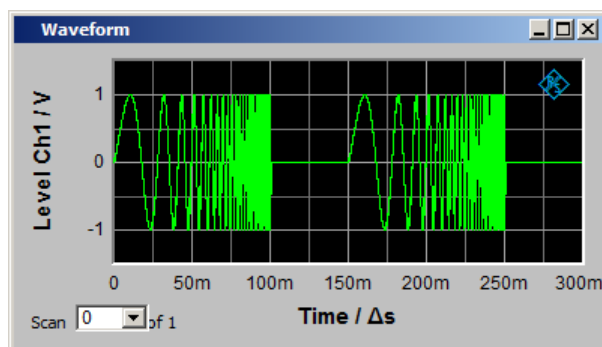
5.6.17 Chirp



The generator generates a logarithmic sine-wave sweep, i.e. a signal whose the frequency changes with respect to time with each sample. The use of this signal is a requirement for the chirp-based measurement ([chapter 5.34, "Chirp-Based Measurement"](#), on page 569).



A positive chirp must be used as the excitation signal for the chirp-based measurement, i.e. the frequency must increase with respect to time; as a result, the "Start Freq" must always be less than the "Stop Freq".

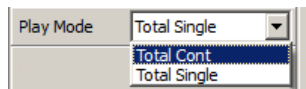


SCPI command:

`SOURce:FUNCtion CHIRp`

Play Mode

Determines the playback mode of the chirp.



"Total Cont" The chirp is played back in a loop; after the "Interval" time expires, playback jumps back to the beginning of the signal without interruption.

"Total Single" The chirp is played back once, after which the generator is muted.

Remote command:

[SOURce:PLAY:MODE](#) on page 881

Start Freq

Start frequency of the logarithmic sine-wave sweep. If used as the excitation signal for the chirp-based measurement, this value must be less than the "Stop Freq".

Remote command:

[SOURce:SWEep:FREQuency:START](#) on page 889

Stop Freq

Stop frequency of the logarithmic sine-wave sweep.

Remote command:

[SOURce:SWEep:FREQuency:STOP](#) on page 890

Volt Peak

Peak value of the chirp. Changing this value results in a change to the RMS value in the next operator field.

Remote command:

[SOURce:VOLTage:TOTal](#) on page 876

Volt RMS

RMS value of the chirp over the sweep time to be set in the next operator field. Changing this value results in a change to the peak value in the operator field above.

Remote command:

[SOURce:VOLTage:RMS](#) on page 876

Sweep Time

Time from "Start Freq" to "Stop Freq". A change to the sweep time results in a change to the RMS value and affects the ratio between the peak value and the RMS value of the two operator fields above, as well as the content of the display fields "Resolution" and "Points" of the analyzer measurement function "Chirp based Measurement". In the figure above, "Sweep Time" is 100 ms.

Remote command:

[SOURce:ONTIME](#) on page 877

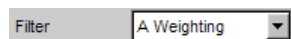
Interval

Time interval between the individual chirps. The "Interval" is 150 ms in the figure above. The pause between the chirps is therefore calculated as follows: "Interval" - "Sweep Time". "Interval" does not influence "Volt RMS".

Remote command:

[SOURce:INTerval](#) on page 877

Filter



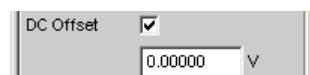
One of the user-definable filters in the Filter panel or a weighting filter can be selected. All level settings apply to the unfiltered signal

Remote command:

[SOURce:FILTer](#) on page 960

For a description of the filters and their setting parameters, see [chapter 5.43.4, "Filter Table"](#), on page 628.

DC Offset



A DC offset is superimposed on the generator signal. This decreases the maximum possible AC voltage. The checkbox enables or disables this function. The offset voltage can be entered regardless of whether or not the checkbox is activated; however, it only becomes effective when the checkbox is activated.

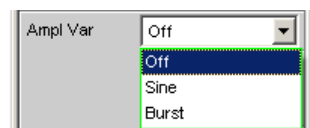
Remote command:

[SOURce:VOLTage:OFFSet<n3>:STATe](#) on page 871

[SOURce:VOLTage:OFFSet<n3>](#) on page 871

5.7 Amplitude Variation

With the Multi-sine, Arbitrary, Random and Play generator signals, the amplitude can be varied either as a sine wave between the maximum value set on the panel and a selectable minimum value, or as a pulse.



Amp Var

The amplitude of the signal can be varied in sinusoidal or pulse (burst) form with a selectable frequency.

"Off" Amplitude variation is deactivated.

"Sine" The amplitude of the generator signal is modulated with respect to sine wave.

"Burst" The generator signal is cyclically activated and deactivated. This setting is not possible in the Play generator function.

Remote command:

[SOURce:AM:MODE](#) on page 884

Modulation Frequency

Used to set the modulation frequency. The value range depends on the analog bandwidth set in the Generator Config panel or the digital clock rate.

Remote command:

[SOURce:FREQuency:AM](#) on page 884

Variation

Used to set the value in % by which the amplitude of the signal is reduced. Value range 0 to -100 %.

Example: At an amplitude of 1 V and a variation of -80 %, the generator level varies between 1 V and 200 mV.

Remote command:

[SOURce:VOLTagE:AM](#) on page 884

On Time

Used to set the time during which the signal is activated. On Time is always less than Interval; if increased, Interval may also be increased.

Remote command:

[SOURce:ONTime](#) on page 877

Interval

Used to set the repetition rate of the burst signal. Interval is always greater than or equal to On Time.

Remote command:

[SOURce:INTerval](#) on page 877

Burst on Delay

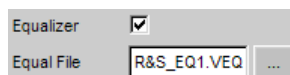
Used to set the delay time which must expire (after generator settings have been changed or a measurement has been started) before the generator can start the signal. During this time, the generator signal is deactivated.

Remote command:

[SOURce:ONTime:DELay](#) on page 877

5.8 Equalization

The generator can be given a predefined frequency response using a table containing frequency points and the associated gain factors. The set amplitude of the generator is automatically changed as a function of frequency in accordance with the table.



Equalizer

Activating/deactivating the precorrection.

Remote command:

[SOURce:VOLTage:EQualize](#) on page 870

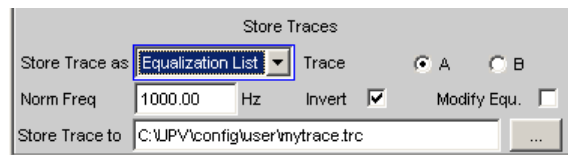
Equal File

Selection of the table.

The button opens a browser that you can use to select the precorrection file.

The table must be saved in a file in a particular format (see example `RS_EXAM.VEQ` in the `d:/upv/user` folder), which can be loaded in the "Equalization" parameter field in the Generator Function panel.

The file can also be created from a measured curve or a curve imported from a file by storing the trace as Equalization List in the Display Config panel.



A number of different settings are available which are explained under ["Store Trace as"](#) on page 721.

Remote command:

[MMEMory:LOAD:OEQualize](#) on page 868

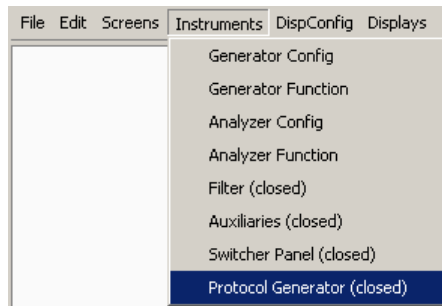
5.9 Protocol Generator

The option R&S UPV-K21 (digital audio protocol) enables you to generate and analyze the channel status data in the data stream of the digital audio interface (option R&S UPV-B2 (digital audio interfaces)) according to the IEC 60958-3 standard for Consumer Mode and IEC 60958-4 or AES3 for Professional Mode.

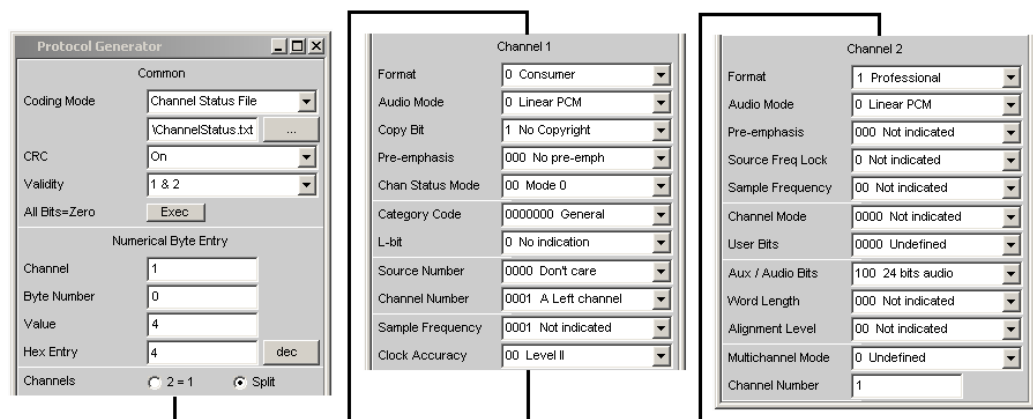
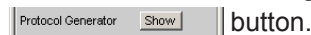
The various settings of the protocol generator are described below.

5.9.1 Higher-Level Settings

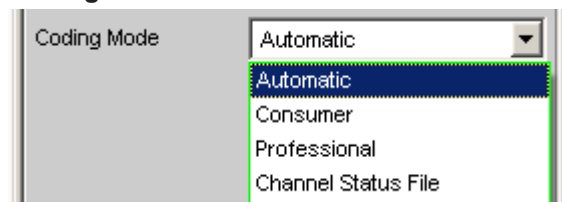
The control panel for the digital audio protocol generator is opened via the menu bar



or in the Generator Config panel of the "Digital Audio" generator instrument with the



Coding Mode



This is for setting the input dialog for channel status data to Consumer or Professional.

- "Automatic" The mask is set in accordance with bit 0 in byte 0, and can be different for each of the two channels.
 Bit 0 = 0 → Consumer
 Bit 0 = 1 → Professional
- "Consumer" Entry mask for the Consumer mode, for both channels in common.
- "Professional" Entry mask for the Professional mode, for both channels in common.
- "Channel Status File" The channel status bytes are read from a text file, set in the hardware and back-translated into the corresponding entry masks. User entries are not possible. To change settings, the loaded file must be edited.

Remote command:

[SOURce:PROTocol:MODE](#) on page 886

Channel Status File

File name for the channel status file from the channel status bytes to be set are read. Examples can be found in the BIN directory as `ChannelStatusCons.txt` and `ChannelStatusProf.txt`.

Remote command:

[SOURCE:PROTOCOL:FILE](#) on page 885

CRC

Cyclic Redundancy Check Character: A checksum is generated from the content of bytes 0 to 22 of the channel status data and transferred to byte 23. (Professional mode only).

The checkbox enables or disables the function.

Remote command:

[SOURCE:PROTOCOL:CRC](#) on page 885

Validity

Defines the state of the validity bit.

"1 & 2" The validity bit is set in both channels.

"None" The validity bit is not set in either channel.

Remote command:

[SOURCE:PROTOCOL:VALIDITY](#) on page 886

All Bits = Zero

This sets all bits to zero once only. Exception: Bit 0 in byte 0, which defines the coding mode as Consumer or Professional, is not changed.

Remote command:

[SOURCE:PROTOCOL:AZERO](#) on page 885

5.9.2 Setting Bytes as Numerical Values

A channel byte can be set to any value in this entry block. It is even possible to set bit combinations that are not yet defined in the standard.

Channel

Selects the channel, 1 or 2.

Remote command:

[SOURce:PROTocol:NUMerical:CH](#) on page 886

[SOURce:PROTocol:CH<n3>:BYTE<n4>](#) on page 885

Byte Number

Selects the byte, 0 to 3.

Remote command:

[SOURce:PROTocol:NUMerical:BYTE](#) on page 886

[SOURce:PROTocol:CH<n3>:BYTE<n4>](#) on page 885

Value

The decimal value for the byte selected in channel 1 or 2 is displayed here and can also be entered.

Remote command:

[SOURce:PROTocol:NUMerical:VALue](#) on page 886

[SOURce:PROTocol:CH<n3>:BYTE<n4>](#) on page 885

Hex Entry

The byte value can be displayed or entered in hexadecimal, binary or decimal.

If the entry brings about a bit combination that is not yet defined in the standard, the parameter has no meaning that can be displayed. In this event ********* is displayed.

Example:

The entry ...

Numerical Byte Entry	
Channel	1
Byte Number	0
Value	9

... gives the following display, since the meaning of the bit combination "010" for pre-emphasis is not defined in the standard.

Channel 1	
Format	1 Professional
Audio Mode	0 Linear PCM
Pre-emphasis	*****
Source Freq Lock	0 Not indicated
Sample Frequency	00 Not indicated

5.9.3 Setting Bytes in Remote-Control Mode

When entering or querying values in remote control mode, an easier method than the three individual commands described in the previous section for channel, byte and value

```
SOURce:PROTOcol:NUMerical:CH <x>
```

```
SOURce:PROTOcol:NUMerical:BYTE <y>
```

```
SOURce:PROTOcol:NUMerical:VALue <n>
```

is to use the following, combined remote-control command:

```
SOURce:PROTOcol:CH<x>:BYTE<y> <n> for the input
```

```
SOURce:PROTOcol:CH<x>:BYTE<y>?for a query
```



If a byte is configured in Channel 2 using this remote control command, the display of the parameters is switched to two-channel (Split).

After the switchover back into Local mode, the settings which are configured via this remote-control command in the protocol generator panel are displayed in plain text in the corresponding parameter fields.

"Parameters:"

<x> → 1 or 2

<y> → 0 to 4

<n> → 0 to 255 (decimal)

Example:

```
SOUR:PROT:CH1:BYTE0 7
```

makes the Protocol Generator panel look like this:

SOUR:PROT:CH1:BYTE0 7

Numerical Byte Entry	
Channel	1
Byte Number	0
Value	7
Hex Entry	7 <input type="button" value="dec"/>
Channels	<input type="radio"/> 2 = 1 <input checked="" type="radio"/> Split
Channel 1	
Format	1 Professional
Audio Mode	1 Not Linear PCM
Copy Bit	1 No Copyright
Pre-emphasis	000 Default State
Chan Status Mode	00 Mode 0

5.9.4 Displaying and Setting Parameters in Plain Text

Parameters can be entered here as defined in the standard. This is possible only for manual operation, not in remote-control mode.

The bit combination and meaning are displayed.

The effect of an entry via Numerical Byte Entry is also displayed here.

Channels	
<input checked="" type="radio"/> 2 = 1 <input type="radio"/> Split	
Channel 1 & 2	
Format	0 Consumer
Audio Mode	0 Linear PCM
Copy Bit	1 No Copyright
Pre-emphasis	000 No pre-emph
Chan Status Mode	00 Mode 0
Category Code	0000000 General
L-bit	0 No indication
Source Number	0000 Don't care
Channel Number	0001 A Left channel
Sample Frequency	0001 Not indicated
Clock Accuracy	00 Level II

Channels

Parameters can be set separately or for both channels in common.

"2 = 1" The same parameters for both channels. On switching over from Split, Channel 2 takes the settings of Channel 1.

"Split" Different parameters can be entered for each of the two channels. On switching over to 2 = 1, Channel 2 takes the settings of Channel 1.

Remote command:

[SOURce:PROTOcol:CHANnels](#) on page 885

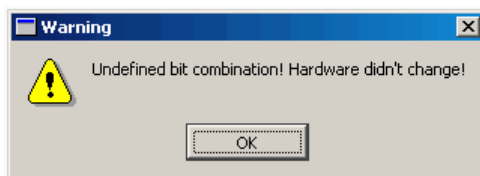
Setting parameters

A selection is offered for each parameter as defined in the standard. This example is for the Sample Frequency in Consumer mode.

Sample Frequency	0000 44.1 kHz
Clock Accuracy	0110 24 kHz
	0011 32 kHz
	0000 44.1 kHz
Format	0010 48 kHz
Audio Mode	1000 88.2 kHz
Copy Bit	1010 96 kHz
	1100 176.4 kHz
Pre-emphasis	1110 192 kHz
	1001 768 kHz
Chan Status Mode	*****

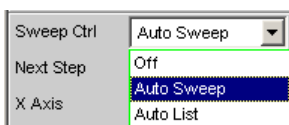
The line ***** indicates an undefined bit combination (which is possible when Numeric Byte Entry is used).

An attempt to set this line is refused with the following message:



. The hardware remains unchanged and the prior status is displayed.

5.10 Sweeps



With many generator functions, it is advisable to output the signal parameters (level, frequency and, with burst signals, ON-time and interval length) not only statically but also to vary them over time. Varying one or more of the signal parameters is referred to as a (generator) sweep. The measured values obtained can be, but do not have to be, recorded as series of measured values.

The R&S UPV has a highly flexible sweep system for this purpose, in which up to two generator parameters or one analyzer parameter (variation of the center frequency of the RMS selective filter) can be varied in a wide variety of ways. When the generator sweep is switched on, any active analyzer sweep is switched off and vice versa.

The sweep results (measured value series) can be displayed graphically (as a 2-D curve display in a sweep window) or numerically (as a sweep list, see [chapter 5.10.6, "List sweep"](#), on page 358). With the graphical display, the 1st sweep parameter is usually plotted on the x-axis, the recorded measured value on the y-axis and the optional 2nd sweep parameter on the z-axis (not visible in the 2-D graph). A Z sweep is therefore equivalent to a sweep with two parameters (2-dimensional sweep).

However, the x-axis can also be determined by the measured frequency ("X-Source" = Frequency) or the measured level ("X-Source" = LevMon...).

Up to 8 measured values can be recorded for each sweep point (in 4 sweep windows each with 2 traces). To plot a specific measurement parameter, the following setting has to be made in (at least) one of the four sweep display panels:

- the X-Source must be set to Sweep or the desired measurement function,
- (at least) one trace must be set to the desired Y-measurement function.

You can also set **multiple** traces to **one** measurement function, for example, to be able to measure them using different marker and/or cursor settings.

The generator sweeps can be configured in many different ways and can be distinguished according to the following characteristics:

- According to the number of varied signal parameters in **1 or 2-dimensional sweeps** (known as Z-Sweeps).

- According to the stepping condition into **synchronous and time-triggered sweeps**.
- According to the sweep axis division into **linear, logarithmic and list-controlled sweeps**.
- According to the sweep direction into **upward and downward sweeps**.
- According to the physical basic unit of the Sweep parameter into **Frequency, level, time and phase sweeps**.
- According to the behavior when the full-scale value is reached into **single and continuous sweeps**.

Which sweep parameters are available for the individual generator functions depends on the characteristics of the respective signal. The following generally applies:

- A frequency sweep is not possible for multi-tone signals or noise signals.
- A phase sweep, i.e. the variation in phase shift between Channel 1 and 2, is only possible for stereo sine waves and should only be performed if both frequencies are the same.
Time sweeps, i.e. the variation in ON-time and interval length, are only possible with burst signals.
- Z-Sweeps are possible if at least two 2 signal parameters of the configured generator function are sweep-capable.

Table 5-1: List of the sweepable function parameters depending on the selected function

Function	VOLTAGE	FREQUENCY	Phase	ON-TIME	INTERVAL
Sine	yes	yes	---	---	---
Stereo Sine	yes	yes	yes	---	---
Multi-sine	no	no	---	---	---
Sine Burst	yes	yes	---	yes	yes
Sine2 burst	yes	yes	---	yes	yes
Mod Dist	yes (total voltage)	yes (user frequency)	---	---	---
DFD	yes (total voltage)	Mode IEC268: Center frequency Mode IEC118: Upper frequency	---	---	---
DIM	yes (total voltage)	---	---	---	---
Random	no	---	---	---	---
Arbitrary	no	---	---	---	---
Polarity	no	---	---	---	---
Modulation	no	no	---	---	---
DC	yes	---	---	---	---
Square	yes	yes	---	---	---

Function	VOLTAGE	FREQUENCY	Phase	ON-TIME	INTERVAL
Play	---	---	---	---	---
Play+Anlr	---	---	---	---	---
Chirp	---	---	---	---	---

5.10.1 Activating / Deactivating the Sweep System

The sweep system is enabled and disabled using "Sweep Ctrl ". This simultaneously defines how the sweep is to be stepped and how the sweep axis is to be defined. For generator sweeps, this parameter field is located in the generator functions, the analyzer sweep is available only for the measurement function "RMS Selective" and explained in greater detail there (see [chapter 5.25.3, "RMS Measurement, Selective"](#), on page 470).

The sweep system can be activated and configured separately in each generator function. If the function (or instrument) is changed, the sweep system is reconfigured, activated or deactivated implicitly.

The generator sweep is also disabled when activating the analyzer sweep and when selecting Time Chart as the start condition (see [chapter 5.20, "Start Conditions"](#), on page 444).

The sweep cycle starts when you press the START - (for continuous sweeps) or SINGLE button (for single sweeps).

Each new sweep point that the sweep system sets automatically triggers a new measurement. When using one of the burst functions of the R&S UPV universal generator, the generator signal is reset at the same time, i.e. the generator begins with the burst phase or the Burst on Delay. If the measured values generated during measurement are to be recorded and displayed (graphically or numerically), the desired measured values (e.g. "Funct Ch1") must be selected as "Traces" in the sweep display panels. Furthermore, it must also be ensured that the x-axis is set to "Auto" in the sweep display panels used during recording of measured values.

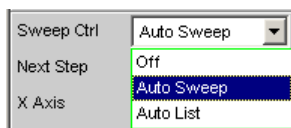
On completion of the sweep measurements, the used traces and the associated x-axes should be switched to "Hold" to prevent the sweep results from being deleted if instrument settings are changed inadvertently.

When the sweep system is enabled, START , SINGLE and STOP/CONT has the following effect:

- START starts a continuous sweep,
- SINGLE starts a single sweep or continues an already started continuous sweep as a single sweep.
- STOP/CONT stops an ongoing sweep or continues a stopped sweep.

Sweep Ctrl

Used to activate and configure or deactivate the generator sweep system.



- "Off" The generator sweep system is deactivated; no additional parameter fields are displayed.
- If the analyzer sweep system is likewise switched off, START , SINGLE and STOP/CONT has an effect on the measurement system:
- START starts a continuous measurement,
 - SINGLE starts a single measurement or continues an already started continuous measurement as a single measurement.
 - STOP/CONT interrupts an ongoing measurement or continues an interrupted or terminated measurement as a continuous measurement.
- "Auto Sweep" The generator sweep system is activated; the sweep stepping is performed automatically; the sweep axis is calculated from the start value, stop value and step size or point number.
- The stepping condition (fixed time grid or synchronized to the analyzer) is determined in the "Next Step" parameter field.
- "Auto List" The generator sweep system is activated; the sweep stepping is performed automatically; the sweep axis is determined from the predefined list of sweep points (usually loaded as a file).
- The stepping condition (fixed time grid or synchronized to the analyzer) is determined in the "Next Step" parameter field.

Remote command:

[SOURce:SWEep:CONTrol](#) on page 888

5.10.2 One-Dimensional Sweep

With one-dimensional sweeps, only 1 parameter is varied; the z-axis is deactivated.



Each sweep cycle can consist of a maximum of 1024 individual points, which means that the x-axis is divided into a maximum of 1023 steps.

As soon as all of the points on the x-axis have been processed, the analyzer returns to the 1st X-value and performs the next sweep cycle using the same settings.

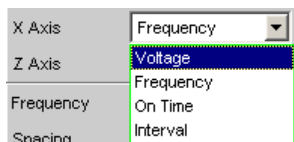


The last 20 sweep cycles (scans) are available as the data set. If more than 20 scans have been performed, only the last 20 can be saved as the trace data set. Similarly, only the last 20 scans are retained if the graph is rescaled.

A one-dimension continuous sweep started using START is repeated in an infinite loop.

X-axis

Used to select the sweep parameter (with one-dimensional sweeps) or the first sweep parameter (with two-dimensional sweeps). Only visible for activated generator sweep system.



The reason for designating the sweep axis as the "x-axis" is that this sweep parameter is normally entered as the x-axis in the 2-D graphic.

Note: It is also possible to plot a measured value on the x-axis (e.g. the measured RMS in the case of external measured value triggering). In such cases, the sweep axis (sweep x-axis) and the graphical x-axis are not necessarily identical.

- "Voltage" Used to activate a level sweep. Which signal parameter is actually swept (e.g. the level of a single sine-wave line or the total level of a multi-tone signal) depends on the respective generator function.
- "Frequency" Used to activate a frequency sweep. Not possible for noise signals and multi-tone signals. Which signal parameter is actually swept (e.g. the frequency of a single sinusoidal line or the center frequency of a two-tone signal) depends on the respective generator function.
- "Phase" Used to activate a phase sweep. Possible only for the generator function "Stereo Sine".
- "On Time" Used to activate a burst-duration sweep. Only with burst signals. The ON-time of the burst signal is swept, i.e. the time during which the high level of the burst is output.
- "Interval" Used to activate a burst-interval sweep. Only with burst signals. The interval length of the burst signal is swept.

Remote command:

[SOURce:SWEEP:XAXis](#) on page 890

5.10.3 Two-Dimensional Sweep

For two-dimensional sweeps, 2 (different) parameters are varied; the first parameter is selected as the x-axis, the second parameter is selected as the z-axis.



Both axes (sweep dimensions) can each consist of max. 1024 individual points, which means that each axis is divided into max. 1023 steps.

As soon as all of the points on the x-axis have been processed, the analyzer returns to the 1st X-value and simultaneously sets the next Z-value. When the sweep cycle for

the last Z-point has been completed, the X and Z-values are reset to their original start values.

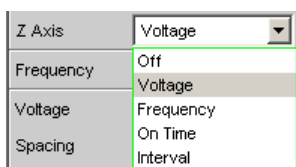


The last 20 sweep cycles (scans) are available as the data set. If the z-axis contains more than 20 points, only the last 20 scans can be stored as a trace data record. Similarly, only the last 20 scans are retained if the graph is rescaled.

A two-dimension continuous sweep started using START is terminated after the sweep cycle of the last Z-point.

Z-axis

Select the second sweep parameter for the two-dimensional sweep. Is simultaneously used to enable or disable the two-dimensional sweep. Only visible for activated generator sweep system.



Note: With some generator functions (e.g. DC, DIM), it is possible to sweep one parameter only. The "z-axis" parameter field (and therefore a two-dimensional sweep) is not available in this case.

Note: When switching on the Z-sweep, the Sweep Graph Config panel is switched over to Multi Scan, provided the "X-Source" of the respective window is set to Sweep. At the same time, the number of points on the z-axis (20 maximum) is copied to the Sweep Graph Config panel as "History" if it is larger than the value specified there.

- "Off" Used to deactivate the two-dimensional sweep (switch-over to a one-dimensional sweep).
- "Voltage" Used to activate the two-dimensional sweep and select the level variation as the second sweep parameter. Which signal parameter is actually swept (the level of a single sine-wave line or the total level of a multi-tone signal) depends on the respective generator function.
- "Frequency" Used to activate the two-dimensional sweep and select the frequency variation as the second sweep parameter. Not possible for noise signals and multi-tone signals. Which signal parameter is actually swept (the frequency of a single sine-wave line or the center frequency of a two-tone signal) depends on the respective generator function.
- "Phase" Used to activate a two-dimensional sweep and select phase variation as the second sweep parameter. Only possible for stereo signal.
- "On Time" Used to activate the two-dimensional sweep and select the burst-duration variation as the second sweep parameter. Only with burst signals.
The ON-time of the burst signal is swept, i.e. the time during which the high level of the burst is output.

"Interval" Used to activate the two-dimensional sweep and select the burst-interval variation as the second sweep parameter. Only with burst signals.
The interval length of the burst signal is swept.

Note: The smallest value of Interval must be greater than the largest occurring On Time value. With logarithmic and linear sweeps, this is ensured by limiting and, where necessary, correcting the start and stop values. With the list sweep, the user should make sure that this condition is observed in the used lists since automatic correction (if required) only begins with the currently active sweep, which can lead to unexpected results.

Note: It is theoretically possible – and also not prohibited in the user interface – to specify the same parameter (e.g. Voltage) for both axes. In this case, the Z-parameter has no effect but nevertheless still determines the number of sweep cycles.

Remote command:

`SOURce:SWEep:ZAXis` on page 890

5.10.4 Automatic Sweep

With automatic sweeps, the sweep stepping is performed automatically when a measurement has been completed (synchronous sweep) or when a definable dwell time has expired (time-triggered sweep, dwell sweep). After START, the sweep runs continuously without further user input (for one-dimensional continuous sweeps), for SINGLE sweeps until the last sweep point is reached.

Synchronous sweep ensures that sweep stepping is performed when the analyzer has carried out all the required measurements. At the same time it ensures the highest possible sweep speed, since the next sweep point is set as soon as measurements have finished.

Time-triggered sweep is only worthwhile in exceptional cases:

- When the analyzer is not in use.
- When the analyzer is actually being used, but the intention is for sweep stepping to be performed independently of measurement time. However, the chosen dwell time must be long enough for all measurements to have been completed before the dwell time expires.

To generate WAV files for external sweeps using the Record measurement function (refer also to [chapter 5.36.6, "Create WAV files for external sweeps"](#), on page 597).



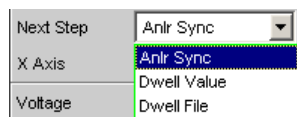
If you want to also generate valid measured values during a time-triggered sweep, we recommend selecting the settings in the analyzer to eliminate the possibility of unexpectedly prolonging the measuring period (e.g. by disabling Settling, disabling the auto-ranger in the analog analyzer, selecting a fixed measuring time).

The automatic sweeps are selected in the "Sweep Ctrl" parameter field, whereby the sweep axis

- is calculated from user entries ("Auto Sweep") or
- is loaded with a predefined list (e.g. from a file) ("Auto List")

Next Step

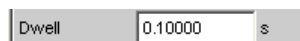
Used to select the sweep stepping. Only visible for automatic sweeps.



"Anlr Sync" The sweep stepping is synchronized to the analyzer, i.e. a new sweep point is set automatically when all measurements activated in the analyzer have been completed. This setting should be selected whenever the internal analyzer is used for sweeping. It ensures that a measured value is determined for every sweep point with minimum sweep time.

Note: If one or more measured values cannot be determined for a sweep point (e.g. because the level range of the analyzer was selected too low or the signal supplies too high of a level), the affected measured values are marked as invalid (NAN) and the next sweep point is configured.

"Dwell Value" The sweep stepping is time-controlled in constant intervals, i.e. a new sweep point is set automatically if the preset time has expired, irrespective of whether the measurements activated in the analyzer have been completed. A new measurement is started at the same time. The user can enter the dwell time in the next parameter field.

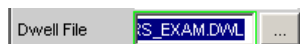


This setting ensures that sweep stepping is carried out in a fixed time grid. It should only be chosen if the internal analyzer is not in use, measured values are not needed or the dwell time is longer than the longest measurement time.

Note: Especially for frequency sweeps, the required measuring time of the individual sweep points is very different. If it is intended to generate measured values, the "slowest" sweep point must be taken as a basis when defining the necessary dwell time (for frequency sweeps this is normally the lowest frequency). A higher sweep speed can be achieved by using "dwell files". If the selected dwell time is too short thus preventing one or more measured values from being determined, the measured values concerned are marked as invalid ("NAN").

"Dwell File" The sweep stepping is time-controlled in individually set intervals, i.e. a new sweep point is set automatically if the associated time has expired, irrespective of whether the measurements activated in the analyzer have been completed. A new measurement is started at the same time.

The file containing the list of dwell times can be specified by the user in the parameter field below.



This setting makes it possible to specify not only a separate dwell time for each sweep point, but also an individual measurement time. It should only be chosen if the internal analyzer is not in use, measured values are not needed or the dwell time of a sweep point is longer than the associated measurement time.

The dwell list is processed in the direction of the sweep, i.e. starting with the last entry in the case of a downward sweep. The specified dwell time will thus be maintained for each sweep point even if the sweep direction is changed.

Note: If measured values are also required in this mode, the individual measuring time should be determined and entered to attain a high sweep speed. This applies particularly to frequency sweeps using automatic measurement time. If the dwell-time list is shorter than the sweep list or the length of the sweep axis, the last dwell time in the list is applicable for all remaining sweep points.

Remote command:

[SOURCE:SWEep:NEXTstep](#) on page 888

[SOURCE:SWEep:DWELL](#) on page 888

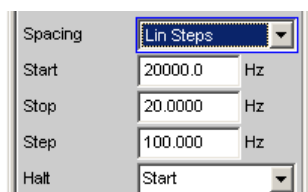
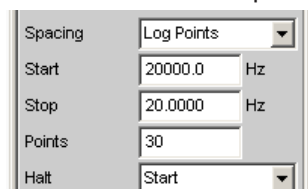
[MMEMory:LOAD:DWELL](#) on page 888

5.10.5 Linear and Logarithmic Sweep

Both linear and logarithmic sweeps are calculated automatically from user entries.

For this purpose, the user must specify:

- the spacing type (logarithmic or linear)
- either the number of points ("Points") or the step size ("Step")



- the start and stop value ("Start" and "Stop"), which implies the sweep direction
If no logarithmic spacing was selected, the DC and Sine²Burst generator functions for "Start", "Stop" and "Halt" can be assigned a **negative level**.

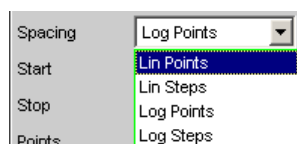


The start and stop value mark the region of interest of the x-axis and thus are used as the x-axis scaling in the sweep graphs if the "Scaling" of the x-axis is set to Auto.

A maximum of 1024 points are available for each sweep axis which means that each axis can be divided into max. 1023 (linear or logarithmic) equidistant steps.

Spacing

Used to select the sweep range spacing, i.e. the way in which the sweep points are distributed on the sweep axes. Only visible for activated generator sweep system. It is set separately for each sweep parameter.



Can be selected separately for each sweep parameter (i.e. x and z-axis).

- | | |
|--------------|--|
| "Lin Points" | The sweep range is divided linearly by specifying a number of points (linear sweep). This number is entered in the "Points" parameter field. Should be selected if equidistant, linear spacing of all points is required. |
| "Lin Steps" | The sweep range is divided into intervals of a specified linear step size starting at "Start" (linear sweep). This step size is entered in the "Step" parameter field. |
| "Log Points" | The sweep range is divided logarithmically by specifying a number of points (logarithmic sweep). This number is entered in the "Points" parameter field. Not possible for phase sweep. Should be selected if equidistant, logarithmic spacing of all points is required. |
| "Log Steps" | The sweep range is divided into intervals of a specified logarithmic step size starting at "Start" (logarithmic sweep). Each sweep point is calculated by multiplying the previous point by a constant factor. This factor is entered in the "Step" parameter field. Not possible for phase sweep. |

Remote command:

[SOURCE:SWEep:FREQuency:SPACing](#) on page 889

[SOURCE:SWEep:INTerval:SPACing](#) on page 889

[SOURCE:SWEep:ONTime:SPACing](#) on page 889

[SOURCE:SWEep:PHASe:SPACing](#) on page 889

[SOURCE:SWEep:VOLTage:SPACing](#) on page 889

Start

Used to enter the start value for the sweep parameter set in the parameter field above. Only visible for activated generator sweep system. It is set separately for each sweep parameter.

Start	20000.0	Hz
-------	---------	----

The start and stop value implicitly determine the sweep direction:

If the start value is less than the stop value, an upward sweep is performed, otherwise a downward sweep will be performed.

If a start value identical to the stop value is entered, the stop value is automatically loaded with the old start value. In this way, it is possible to change the sweep direction by entering just one value.

Remote command:

[SOURce:SWEEp:FREQuency:START](#) on page 889

[SOURce:SWEEp:INTerval:START](#) on page 889

[SOURce:SWEEp:ONTime:START](#) on page 889

[SOURce:SWEEp:PHASe:START](#) on page 889

[SOURce:SWEEp:VOLTage:START](#) on page 889

Stop

Used to enter the stop value for the sweep parameter set in the parameter field above. Only visible for activated generator sweep system. It is set separately for each sweep parameter.

Stop	20.0000	Hz
------	---------	----

The start and stop value implicitly determine the sweep direction:

If a stop value identical to the start value is entered, the start value is automatically loaded with the old stop value.

Remote command:

[SOURce:SWEEp:FREQuency:STOP](#) on page 890

[SOURce:SWEEp:INTerval:STOP](#) on page 890

[SOURce:SWEEp:ONTime:STOP](#) on page 890

[SOURce:SWEEp:PHASe:STOP](#) on page 890

[SOURce:SWEEp:VOLTage:STOP](#) on page 890

Points

Used to enter the number of sweep points for the sweep parameter set in the parameter field above. Only visible for activated generator sweep system if "Lin Points" or "Log Points" is set for "Spacing". It is set separately for each sweep parameter.

Points	30
--------	----

The sweep range is divided into "Points – 1" (linear or logarithmic) equidistant steps. At least 2 points (start and stop value) are required.

A maximum of 1024 points can be selected for each sweep parameter.

Note: If the z-axis contains more than 20 points, only the last 20 scans are available as the data set (for saving and rescaling the graph). If you want to store a two-dimen-

sional sweep as a complete trace data record, the number of points of the z-axis must not exceed 20.

Note: The number of points on the z-axis (20 maximum) is copied to the Sweep Graph Config panel as "History" if it is larger than the value specified there and the X-Source of the respective window is set to Sweep.

Remote command:

[SOURce:SWEEp:FREQuency:POINts](#) on page 889

[SOURce:SWEEp:INTerval:POINts](#) on page 889

[SOURce:SWEEp:ONTime:POINts](#) on page 889

[SOURce:SWEEp:PHASe:POINts](#) on page 889

[SOURce:SWEEp:VOLTage:POINts](#) on page 889

Step

Used to enter the (linear or logarithmic) step size for the sweep parameter set in the parameter field above. Only visible for activated generator sweep system if "Lin Steps" or "Log Steps" is set for "Spacing". It is set separately for each sweep parameter.

The entry range is limited automatically so that at least one and at most 1023 single steps exist (corresponding to 1024 sweep points).

With linear step, the size of the step must always be entered, i.e. the numeric value is positive even if the start value is greater than the stop value. The physical unit is the same as that used when specifying "Start" and "Stop".

(Example for lin. frequency sweep)

Step	50.0000	Hz
------	---------	----

With logarithmic step, the factor must be entered by which each sweep point is to be multiplied in order to move to the next sweep point. The logarithmic step size of level sweeps can also be specified in dB. Swapping the start and stop value (reversal of the sweep direction), therefore produces the reciprocal value and changes the sign of the dB value. The closer the numeric value is to 1.0 or 0 dB, the more sweep steps are carried out.

(Example for log. upward sweep)

Step	0.50000
------	---------

Note: Since the last step of the sweep is automatically adapted such that it corresponds exactly to the stop value, it may deviate by max. 50 % from the selected step size. If this is to be avoided, either the start/stop value must be corrected accordingly or the sweep spacing must be set using the "Points" parameter.

Note: The number of points on the z-axis (20 maximum) – determined by Start, Stop and Step – is copied to the Sweep Graph Config panel as "History" if it is larger than the value specified there and the X-Source of the respective window is set to Sweep.

Remote command:

[SOURce:SWEEp:FREQuency:STEP](#) on page 890

[SOURce:SWEEp:INTerval:STEP](#) on page 890

[SOURce:SWEEp:ONTime:STEP](#) on page 890

[SOURce:SWEEp:PHASe:STEP](#) on page 890

[SOURce:SWEEp:VOLTage:STEP](#) on page 890

5.10.6 List sweep

With list-controlled sweeps, any sweep axis can be defined. The sweep points may be any distance apart, but must be in ascending or descending order ("Random sweep"). The sweep points are processed by the sweep system in the order in which they are listed. To define the list sweep as an upward or downward sweep, the sweep points must be entered in the appropriate order. Whereas in a normal sweep each sweep point is measured once only within a scan, the list sweep also offers the ability to measure individual sweep points a multiple number of times. This is achieved by entering the relevant sweep point in the list an appropriate number of times.

The list is usually loaded as a file. It must contain at least two (different) points. For the format of the list, refer to [chapter 5.56.3, "Sweep Lists"](#), on page 770.

A maximum of 1024 points are available for each sweep axis; if the list contains more than 1024 values, only the first 1024 points are loaded. The first and last points in the list define the sweep direction. If the list contains a point which does not comply with this direction, the point and all subsequent points are ignored.



The first and last (valid) point of the sweep list mark the region of interest of the x-axis and thus are used as the x-axis scaling in the sweep graphs if the scaling of the x-axis is set to Auto.

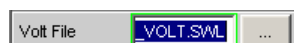
When the sweep list is being loaded, a check is made to see whether the actual basic measurement unit of the sweep file matches the sweep parameter. In addition to the R&S UPV list format (preferably with the extension *.SWL), files are also accepted that originate from the predecessor instruments, R&S UPL and R&S UPD.



If the z-axis of the two-dimensional sweep is defined as a list containing more than 20 points, only the last 20 scans are available as the data set (for saving and rescaling the graph). If you want to store a two-dimensional sweep as a complete trace data record, the number of points of the z-axis must not exceed 20.

Tot Volt File, Volt File

Used to enter the file name for the list of the level sweep parameter (level sweep list). Only visible with generator list sweep activated.



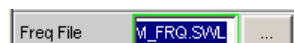
Which signal parameter is actually swept (the level of a single sine-wave line or the total level of a multi-tone signal) depends on the selected generator function.

Remote command:

[MMEMory:LOAD:VOLTag](#) on page 888

Freq File, Upp Freq File, Mean Freq File

Used to enter the file name for the list of the frequency sweep parameter (frequency sweep list). Only visible with generator list sweep activated.



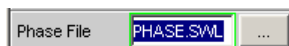
Which signal parameter is actually swept (the frequency of a single sine-wave line or the center frequency of a two-tone signal) depends on the selected generator function.

Remote command:

[MMEMory:LOAD:FREQuency](#) on page 888

Phase File

Entry of file name for the phase sweep list. Only visible with generator list sweep activated. Reference

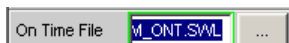


Remote command:

[MMEMory:LOAD:PHASe](#) on page 888

On Time File

Used to enter the file name for the list of the burst-duration sweep (burst-duration sweep list). Only visible for activated generator list sweep in the generator functions "Burst" and "Sine² Burst".

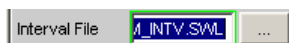


Remote command:

[MMEMory:LOAD:ONTime](#) on page 888

Interval File

Used to enter the file name for the list of the burst interval sweep (burst interval sweep list). Only visible with generator list sweep activated in the Burst and Sine² Burst generator functions.



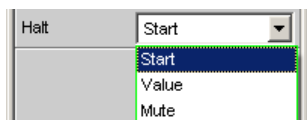
Remote command:

[MMEMory:LOAD:INTerval](#) on page 888

5.10.7 Behavior after Sweep End

The behavior after sweep end determines which signal the generator outputs after a completed sweep or if the generator is muted.

Halt



After a completed sweep, the generator outputs a signal to be determined by the user or is muted.

"Start"	<p>After a completed sweep, the generator is set as follows:</p> <ul style="list-style-type: none"> For "Sweep Ctrl" = "Auto Sweep": As specified in the "Start" parameter field above this. For "Sweep Ctrl" = "Auto List": As specified in the first entry of the sweep list.
"Value "	<p>After a completed sweep, the generator is set to the value specified in the following parameter field. This value can be outside of the values defined by "Start" and "Stop" or outside of the first and last entries of the sweep list.</p>
"Mute"	<p>After a completed sweep, the generator level is set to 0 V or 0 FS. The next sweep cycle eliminates the mute and begins again with the "Start "value or the first entry of the sweep list.</p> <p>With running sweep, the generator is immediately muted, the sweep is restarted, and the generator is implicitly switched on again.</p>

Remote command:

[SOURce:SWEEP:FREQUENCY:HALT](#) on page 888

[SOURce:SWEEP:INTERVAL:HALT](#) on page 888

[SOURce:SWEEP:ONTIME:HALT](#) on page 889

[SOURce:SWEEP:PHASE:HALT](#) on page 889

[SOURce:SWEEP:VOLTAGE:HALT](#) on page 889

Halt value



If the parameter field above it is set to "Halt " = "Value " after a completed sweep, the generator is set to the value specified here. This value can be **outside** of the values defined by "Start" and "Stop" or outside the first and last entries of the sweep list.

Remote command:

[SOURce:SWEEP:FREQUENCY:HALT:VALue](#) on page 889

[SOURce:SWEEP:INTERVAL:HALT:VALue](#) on page 889

[SOURce:SWEEP:ONTIME:HALT:VALue](#) on page 889

[SOURce:SWEEP:PHASE:HALT:VALue](#) on page 889

[SOURce:SWEEP:VOLTAGE:HALT:VALue](#) on page 889

5.10.8 Sweep Speed

The time required for a sweep cycle is only relevant for automatic sweeps and is determined by the following factors:

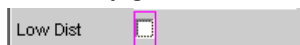
- Setting time of the generator
- Required dwell time; depends on the characteristics of the DUT (e.g. settling time)
- Only with synchronous sweeps (i.e. when using the internal analyzer): Measurement speed

The setting times of the generator and, if necessary, the measurement time should be minimized in order to ensure the shortest possible cycle time and thus a high sweep speed. A series of optimization options are provided for this purpose:

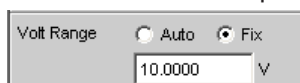
Minimizing the generator setting time

The setting time of the digital generator part is just a few microseconds and can therefore be disregarded. However, configuration of the analog software in the analog generator (which involves settling procedures) requires a number of milliseconds and should therefore be avoided for sweeps wherever possible.

- Use of the **universal generator** instead of the low-distortion generator for frequency sweeps. With low frequencies in particular, the low-distortion generator requires long settling times for frequency changes. The universal generator is superior to the low-distortion generator with respect to frequency setting time and accuracy and is therefore preferable as a sweep generator. The low-distortion generator should only be used if the DUT and the measurement function require its extremely good distortion properties or large frequency range.



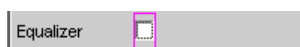
- Use of a **fixed level range** for level sweeps and active pre-correction; the level should be set to the highest value that occurs during the sweep. The automatic operating mode controls the level of the analog hardware to maximize the signal-to-noise value of the generator at every level. This mode should only be used if sweeping is to be performed over several decades and both the DUT and the measurement function require a high S/N value.



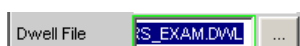
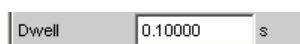
- **Turning the filter off.** Whenever the frequency or level is changed, if a filter is switched on, it requires a settling time – even if it is only a short one.



- **Turning off the frequency equalizer** for frequency sweeps. If the equalizer is activated, a new level must be set for each new frequency. An alternative method of frequency response correction is to use suitable reference curves when recording the measured values.



- **Reducing the dwell time** when using an external analyzer. The dwell time required by the DUT and the external analyzer must be determined by trial and error and can be specified as a fixed value or separately for each sweep point as a list.



- **Synchronization** of the generator to the analyzer when using an internal analyzer. If the generator and analyzer of the R&S UPV are operated together, a generator sweep should always be synchronized to the analyzer. This ensures that the generator is advanced precisely at the point when all measurement results are availa-

ble and have settled (where applicable also frequency, level monitor and input measurements on the active channels).

Next Step

- Reducing the measurement points for **low frequencies**. Low frequencies require longer measuring times than higher frequencies. The sweep axis should therefore be divided in such a way that only a few low tones are used. This can be achieved in the following ways:

Linear instead of logarithmic spacing

Spacing

Increasing the lower sweep limit

Start	<input type="text" value="100.000"/>	Hz
Stop	<input type="text" value="20000.0"/>	Hz

List sweep

Sweep Ctrl

- Reducing the measurement points. The duration of the sweep cycle increases more or less linearly with the number of sweep points. The list sweep enables you to set the distances between the individual sweep points and thus to carry out a burst at locations of particular interest without increasing the total number drastically.

List sweep

Sweep Ctrl

Avoiding an unnecessarily small step size

Step Hz

Avoiding an unnecessarily large number of sweep points

Points

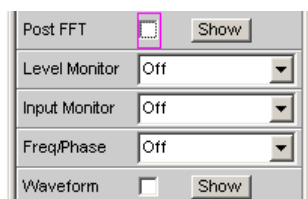
Minimizing the measurement time

When using the internal analyzer, the required measurement time depends on the selected measurement functions. Generally speaking, every measurement function used should wherever possible be configured for high measurement speed; this, of course, depends on the specific measurement function. For this reason, only a few generally applicable rules are given below:

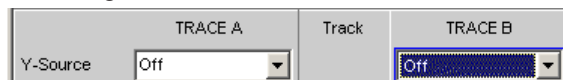
- Only activate those measurement channels which are to be measured. An unconnected measurement input can increase the measurement time considerably because measurement is only completed when a measured value exists for this channel. A number of measurement functions require considerably more time to measure a signal with a low level (noise). Even if there is a signal on the second channel, the measurement time will still be at least slightly longer than for single-channel mode since the second channel must be fully evaluated and displayed.

Channel

- Only activate those measurement functions which are required for the specific measurement task.

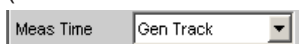


- Deactivate any traces that are not required. In 4 sweep windows, 2 traces can be activated in each window. Only those traces that are required for measured value recording should be active.



- If the internal generator is used, many measurement functions allow reference to its settings ("Gen Track"). These functions should be used since they not only shorten the measurement time (because, for example, the frequency does not have to be measured) but can also increase the measurement accuracy (e.g. sample-precise setup and measurement over entire periods without errors due to measurement termination in the case of RMS).

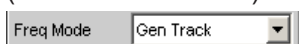
(With RMS and RMS Selective)



(With THD+N and THD)



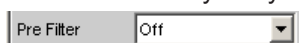
(With RMS Selective)



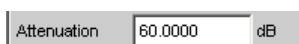
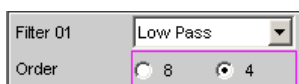
(With activated notch filter)



- Deactivating unnecessary filters. The filters must resettle whenever generator settings are changed. Measurement is not possible during this time. The start of measurement is delayed by the sum of settling times for all activated filters.



- Reducing the order and/or attenuation with user-defined highpass and lowpass filters. This reduces the settling time.

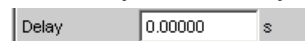


- Deactivating the settling functions. The settling function does not need to be activated for the majority of measurement signals. If a stable signal is present at the DUT, the R&S UPV delivers measured values in settled state even without Set-

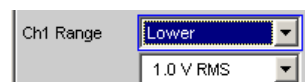
ting. The settling (or averaging) increases the measuring time by a factor of at least the number of configured samples.



- Deactivating the measurement start delay. The measurement start delay is intended to compensate delays of the DUT. Whenever generator or analyzer settings are changed, the start of the 1st measurement (and consequently every single sweep point) is delayed by the specified time. This time should be set to 0.0 if no start delay is necessary.



- Manual selection of the analyzer level range (only with analog measurement signals). If the level of the measurement signal is known and a limitation of the dynamic range is acceptable, the analyzer level range should be selected manually. It should be set to the highest anticipated level; an "UNDERRANGE" must be expected and tolerated in this case; a new measurement with corrected range setting is not performed. "Range LOWEST" can be selected to make sure that a higher level which would invalidate the measurement does not occur. This mode allows the measurement to correct the measuring range in case of OVERRANGE.



5.11 Selecting the Analyzer

5.11.1 Analyzer Configuration Panel

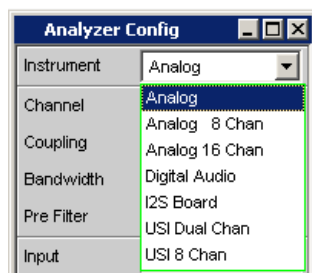
The Config panel is used to set up the analog and digital analyzer.

To adapt the R&S UPV analyzer to the measurement task at hand, first define the settings in the Analyzer Config panel. These settings will influence which capabilities are available in the Analyzer Function panel.

The first step is to select one of the two analyzers (analog or digital).

Instrument

Used to selection the analyzer.



"Analog"

The user can choose between analyzers of various bandwidths, see [chapter 5.12, "Configuring the Analog Analyzer"](#), on page 366.

"Analog 8 Chan"	Up to 8 channels can be synchronously measured, see chapter 5.13, "Configure Analog Multi Channel Analyzer" , on page 376.
"Analog 16 Chan"	Up to 16 channels can be measured.
"Digital Audio"	Either audio data, jitter and phase or a common signal with digital input amplitude can be measured (see chapter 5.14, "Configuring the Digital Analyzer" , on page 385).
"I ² S Board"	The I ² S Audio Analyzer can measure audio data (8 bit to 32 bit) in I ² S format, see chapter 5.15, "Configuring the I²S Analyzer" , on page 393.
"USI Dual Chan"	Audio data in a serial format can be measured with the USI Dual channel analyzer, see chapter 5.16, "Configuring the USI Dual Channel Analyzer" , on page 400.
"USI 8 Chan"	Audio data in a serial format can be measured with the USI 8 channel analyzer, see chapter 5.17, "Configuring the USI 8 Channel Analyzer" , on page 415.

Remote command:

[INSTrument<n1>](#) on page 891

5.12 Configuring the Analog Analyzer

5.12.1 Analog Analyzer Config Panel

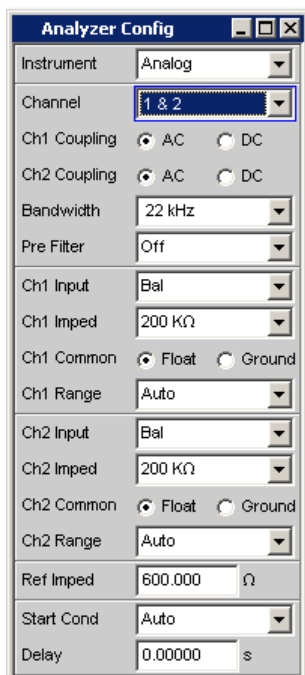
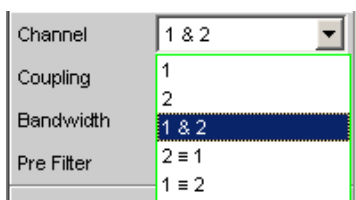


Fig. 5-13: Analyzer Config panel

The Config panel is used to set up the analog and digital analyzer. The configuration options for the analog analyzer are described below.

Channel

Used to select the active XLR sockets in the bottom right-hand part of the front panel.



If a single-channel measurement is selected (1 or 2), the channel not being measured is disabled. Disabled inputs are floating; they are terminated with the set input impedances (300 Ohm, 600 Ohm or 200 kOhm).

- "1" Only the signal applied at XLR socket 1 is measured.
- "2" Only the signal applied at XLR socket 2 is measured.
- "1 & 2" Both XLR sockets are available for analysis of the applied signals. Channel 1 and Channel 2 can have different settings.

"2 = 1" Both XLR sockets are available for analysis of the applied signals. The setting made for channel 1 is also used for channel 2.

"1 = 2" Both XLR sockets are available for analysis of the applied signals. The setting made for channel 2 is also used for channel 1.

Remote command:

`INPut<n1>:CHANnel` on page 895

Coupling

Used to select the input coupling.

AC or DC coupling can be selected. The coupling can be selected separately for both channels if "Channel 1&2" is set.

DC coupling should be selected if input voltages with very low-frequency signal components are to be measured.



"AC" The DC component of the sample signal is removed at the input using a highpass filter and therefore cannot affect the measurement result.

"DC" Sample signals up to 0 Hz are recorded and taken into consideration in the measurement results of RMS, RMS Selective, Peak, Quasi Peak, DC, FFT and Waveform.

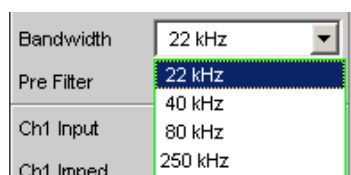
Note: If the input signal contains a large DC component, this results in a reduced dynamic range for the AC component, since the measurement range of the input amplifier is based on the overall signal.

Remote command:

`INPut<n1>:COUPling` on page 893

Bandwidth

4 different analyzer bandwidths are available; the selected bandwidth determines the upper frequency limit for the sample signal.



"22 kHz" The maximum signal frequency is 22 kHz. The signal is sampled at 48 kHz.

Note: At this bandwidth it is possible to observe the input signal continuously (in particular via FFT and waveform).

"40 kHz" The maximum signal frequency is 40 kHz. The signal is sampled at 96 kHz.

"80 kHz" The maximum signal frequency is 80 kHz. The signal is sampled at 192 kHz.

"250 kHz" The maximum signal frequency is 250 kHz. The signal is sampled at 768 kHz.

Remote command:

`INPut<n1>:BANDwidth:MODE` on page 893

Pre Filter

The selected prefilter affects all measurement functions. This permits desired prefiltering without selecting appropriate filters for the individual measurement functions.



The description or characteristic of the various filters is found in [chapter 5.43, "Filter"](#), on page 626.

Remote command:

`INPut<n1>:FILTer` on page 958

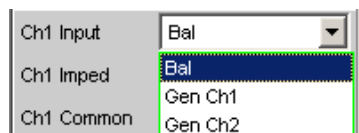
For a description of the filters and their setting parameters, see [chapter 5.43.4, "Filter Table"](#), on page 628.

Chx Input

Used to select the signal source for channel 1 or 2.

If both channels have the same settings (2 = 1 or 1 = 2), only the text "Input" appears to the left of the selection field.

If Channel 1 & 2 is selected, the fields "Ch2 Input" to "Ch2 Range" also appear, in which settings different to those for Channel 1 can be made for Channel 2.



The two analyzer inputs can be connected to the XLR sockets to allow external signals to be measured. However, they can also be connected as desired to the outputs of the internal R&S UPV generator (the simple ground symbol stands for the generator ground, which may be floating, and the ground symbol represents the ground for the analyzer or housing):

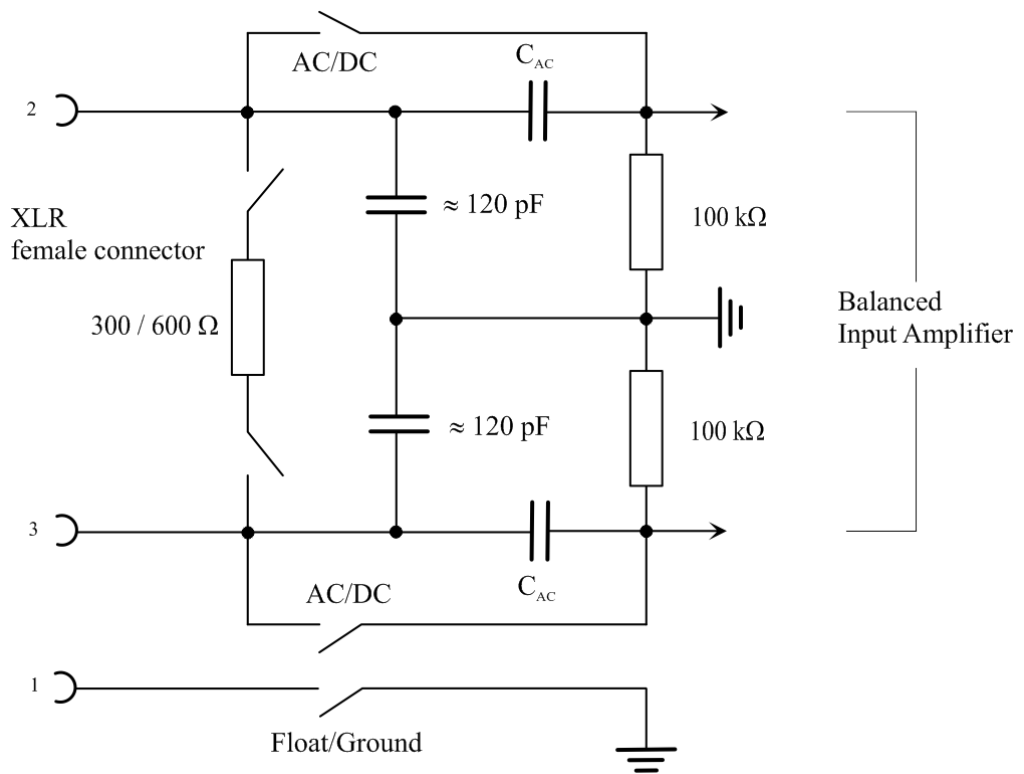


Fig. 5-14: Balanced analyzer input

The sources designated G1 and G2 represent generators 1 and 2 if the R&S UPV-B3 option (Second Generator) is installed. S1 and S2 represent the input selectors of the two analyzer inputs. As a result, either the analyzer can be supplied using an external signal or an internal connection to the R&S UPV generator can be set up. Rout represents the generator output resistors and Ri represents the analyzer input resistors. The circles labeled A1 and A2 symbolize the R&S UPV analyzers.

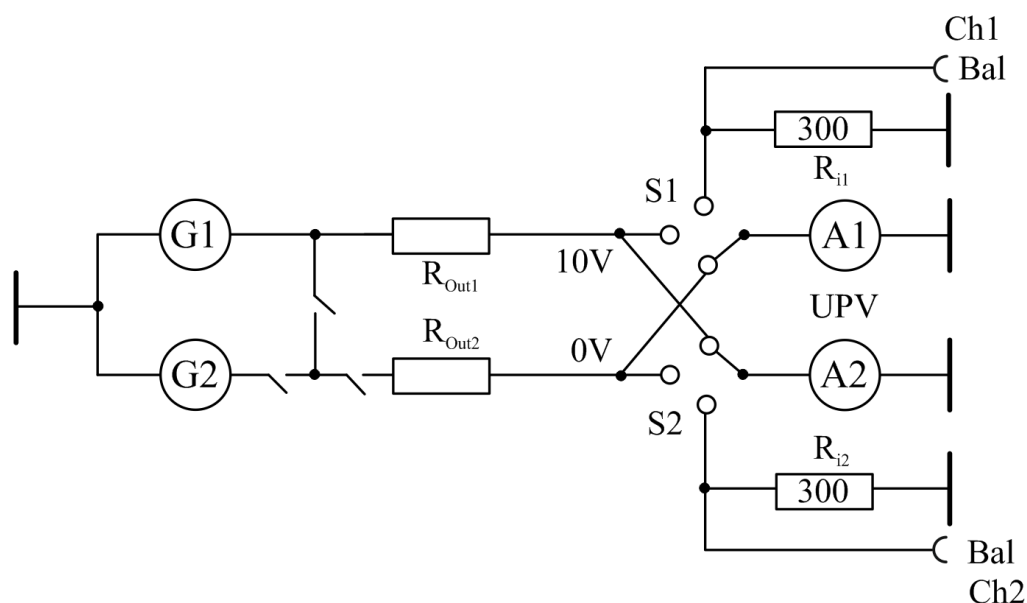


Fig. 5-15: Possible connections for analyzer inputs

- "Bal" "Bal"anced = Balanced-to-ground measurement inputs. Unbalanced DUTs can be connected using XLR/BNC adapters (R&S UPV-Z1 option).
- "Gen Ch1" Internal connection of generator output 1 with analyzer channel 1 or 2 (the illustration shows the internal connection to analyzer channel 2). The analyzer input impedance is 200 kOhm.
- "Gen Ch2" Internal connection of generator output 2 with analyzer channel 1 or 2 (the illustration shows the internal connection to analyzer channel 1). The analyzer input impedance is 200 kOhm.

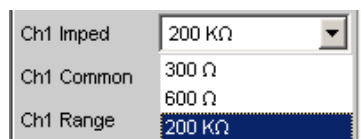
Remote command:

`INPut<n1>:TYPE` on page 896

Chx Imped

Used to select the input impedance; can only be selected if Input is set to "Bal".

If both channels have the same settings (2 = 1 or 1 = 2), only the text "Impedance" appears to the left of the selection field.



With impedances of 300 Ohm and 600 Ohm, only voltages up to 25 V can be applied (this applies to both DC and AC coupling because the low input impedances are located upstream of the coupling capacitors). For voltages > 25 V, the input is protected against overload: The input impedance is switched to 200 kOhm and the generator output is switched off (see [chapter 4.13, "Rapid Deactivation of Outputs"](#), on page 213). The status is indicated by lit LEDs labeled with OVLD on the R&S UPV front panel (immediately beside the generator outputs and the analyzer inputs).

- "300 Ohm" The input impedance is 300 Ohm.
 "600 Ohm" The input impedance is 600 Ohm.
 "200 kOhm" The input impedance is 200 kOhm.

Remote command:

`INPut<n1>:IMPedance` on page 892

Ch1 Common (Ch2 Common)

Potential reference of Pin 1 of the XLR inputs; can only be selected if Input is set to "Bal".

"Float" must always be set if the analyzer inputs are disabled or connected to the internal generator.

If both channels have the same settings (2 = 1 or 1 = 2), only the text "Common" appears to the left of the selection field.



CAUTION! Ground setting: Danger of electric shock. Measurement potential reference only; not a safety connection according to VDE 0411!

If voltages constituting a shock hazard, $U_{rms} > 30 \text{ V}$, are to be measured, the user must ensure that the outer conductor of the BNC/XLR adapter used is securely connected to protective earth.

- "Float" The connection between XLR Pin 1 and instrument ground is interrupted by means of a tripped contact.
 Permissible voltage according to EN 61010-1 is $\leq 30 \text{ V AC}$ or 70 V DC with respect to the instrument housing.

"Ground"

XLR Pin 1 is connected to the instrument ground (PE conductor). The ground reference is canceled if the analyzer is later switched to the internal generator or the set balanced channel is disabled.

Note: If an XLR/BNC adapter (R&S UP-Z1M) is used, XLR Pins 1 and 3 are connected by means of the adapter. The Float/Ground switch can thus be used to select the reference potential for the BNC outer conductor.

If the signal is to be supplied via unbalanced analyzer inputs, it is advisable to use the R&S UP-Z1M XLR/BNC adapter. The internal wiring of this adapter is shown in the figure below.

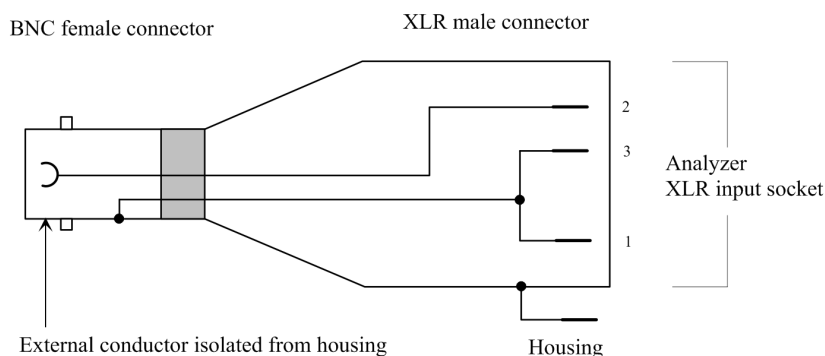


Fig. 5-16: R&S UP-Z1M XLR/BNC adapter

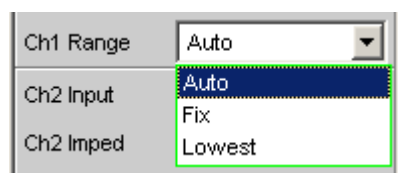
Remote command:

`INPut<n1>:COMMon` on page 892

Chx Range

The possibility of selecting the measurement range allows optimum adaptation to a voltage range required for a specific measurement task. When the selection window is opened, the user can toggle between 3 modes.

If Channel 1 & 2 is selected, the fields "Ch2 Input" to "Ch2 Range" appear after this parameter block. In these fields, settings different to those for Channel 1 can be made for Channel 2.



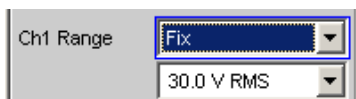
If both channels have the same settings ($2 = 1$ or $1 = 2$), only the text "Range" appears to the left of the selection field.

The ranges are graduated in steps of 5 dB from 18 mV to 100 V and allow an optimum dynamic range when measuring non-linear distortion. If "Auto" (automatic range selection) is set, overranging or underranging of the limits in a current measurement range causes the instrument to switch to the next step. This is also the case for the "Lowest" range setting; here, however, the instrument only goes down to the selected range limit.

The range values are RMS values for sine waves or other signal shapes up to a crest factor of $\sqrt{2}$.

"Auto" Automatic measurement range selection. The optimum range is set separately for each channel; this also applies to the channel settings 2 = 1 or 1 = 2.

"Fix" The set measurement range is fixed. If the Fix mode is selected, the set nominal range value appears in the next field, where a new range can be set by opening the selection window.



Note: If a voltage exceeding the selected level range is applied, the analyzer status display shows "Overrange" and the measured values are shown as invalid ("---"). On switching from Auto to Fix, the currently valid range in the channel is taken over. In the configuration channels 2 = 1 or 1 = 2, the less sensitive range of Channel 1 and 2 is adopted.

"Lowest" The set measurement range is fixed as the lowest range; in the event of overdrive, this range is automatically substituted by higher ranges. If the Lowest mode is selected, the set nominal range value appears in the next field, where a new range can be set by opening the selection window (see Fix).

Note: On switching from Auto to Lowest, the currently valid range in the channel is taken over. In the configuration channels 2 = 1 or 1 = 2, the less sensitive range of Channel 1 and 2 is adopted.

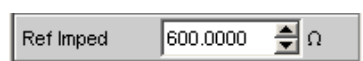
Remote command:

[SENSe<n1>:VOLTage:RANGe<n3>:MODE](#) on page 894

[SENSe:VOLTage:RANGe<n3>:VALue](#) on page 895

Ref Imped

Reference value for impedance.



Reference impedance for the indicated power in the units dBm, W, Δ%W, ΔW, P/Pr and %P/Pr.

The power is calculated using the following formula:

$$P = \frac{U^2}{R}$$

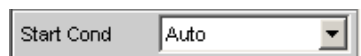
where U is the measured voltage and R is the set reference impedance. The indicated power is only correct if the reference impedance is identical to the resistance of the DUT.

Remote command:

[SENSe<n1>:POWER:REFerence:RESistance](#) on page 894

Start Cond

Specifies the event which triggers a measurement.



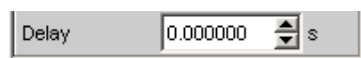
Depending on the "Start Cond" selected, the measurement starts either immediately (Auto) or only once the required trigger condition is met; for details, see [chapter 5.20, "Start Conditions"](#), on page 444.

Remote command:

[TRIGger : SOURce](#) on page 910

Delay

Delay for Start Cond.



You can enter a delay for the menu item "Start Cond Auto". For details, see [chapter 5.20, "Start Conditions"](#), on page 444.

Remote command:

[TRIGger : DELay](#) on page 909

Play bef. Meas

This function requires the R&S UPV-K9 options (base software package for mobile phone tests) and is only available for the "Analog" analyzer instrument.



Enables the output of a previously configured "Play" signal as an activation signal for mobile phones before the measurement – with the selected sample signal – starts; see [chapter 5.20, "Start Conditions"](#), on page 444

The system toggles to the "activation signal" previously configured in Play each time measurement is started. After the specified play time elapses (maximum of 512 K samples per channel), the system switches back to the selected generator signal. Only then does the actual measurement begin.

The prerequisite for this operating mode is the "Volt Range Fix" setting in the generator Config panel, and valid settings in the Play generator function (valid WAV file, maximum 512 K samples per channel for playing time including delay). The Square and DIM generator functions are not applicable.

In order to avoid clicking, the "activation signal" is muted before the selected generator signal is switched on. This results in a signal gap of approx. 2 ms.

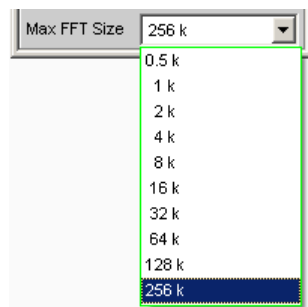
Instrument operation is not possible while the activation signal is being played.

Remote command:

[TRIGger : PLAYbefmeas](#) on page 892

Max FFT Size

Used to limit automatic zoom fitting for the FFT size for all FFT-supported measurement functions (e.g. THD, THD+N, DFD, each with Post FFT) to the selected value with the goal of increasing measurement speed.



The limit to the FFT size is particularly useful for external sweeps for adapting the measurement time to the time frame of an external time tick. A limit is usually associated with degradation in measuring accuracy since incidents such as carrier-level noise can no longer be completely recorded.

Remote command:

[SENSe<n1>:MAX:FFT:SIZE](#) on page 894

5.13 Configure Analog Multi Channel Analyzer

5.13.1 Multi Channel Analyzer Configuration Panel

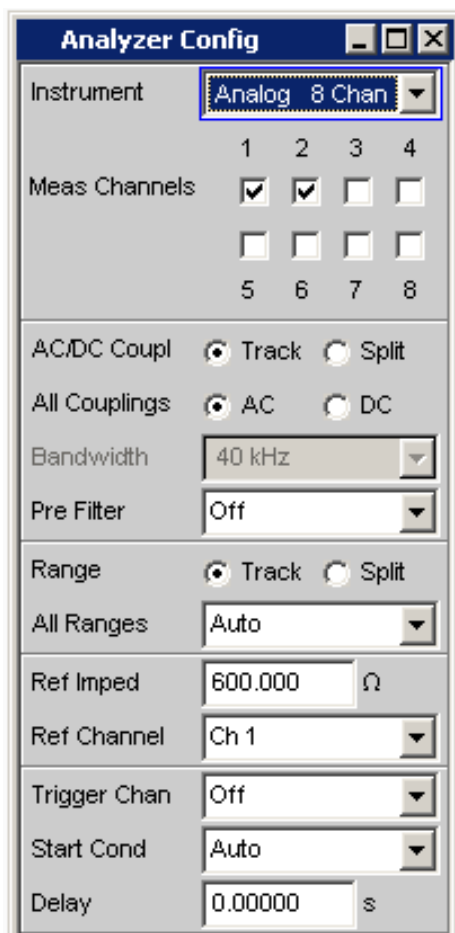
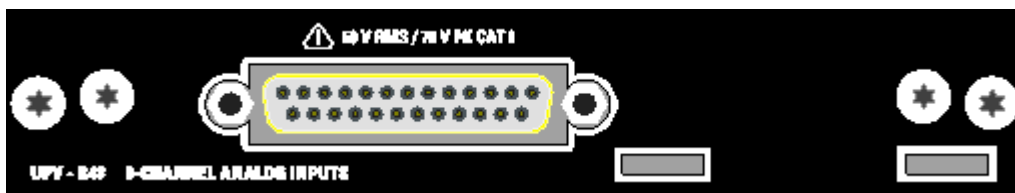


Fig. 5-17: Multichannel Analyzer Config panel

The Config panel allows you to make settings for the analog analyzers and the digital analyzer. The options for configuration of the analog Multi Channel Analyzer are described below. When Multi Channel Analyzer is called for the first time, all channels are activated and all ranges are set to Autorange to prevent overranging when any input signal is applied. For safety reasons, the inactive channels are set to the least sensitive measurement range (50 V).

Input socket for R&S UPV-B48 option:



CAUTION

Risk of electric shock

The instrument complies with measuring category I; make sure that the input voltage at the sockets of the analog analyzers does not exceed 50 V (RMS, sine wave) and 70 V (peak value).

Do not use the instrument in measuring categories II, III and IV.

Explanation:

Measuring circuits as defined in section 6.7.4 of EN61010-1:

Measuring category I is intended for measurements on circuits which are not connected to the high-voltage current system.

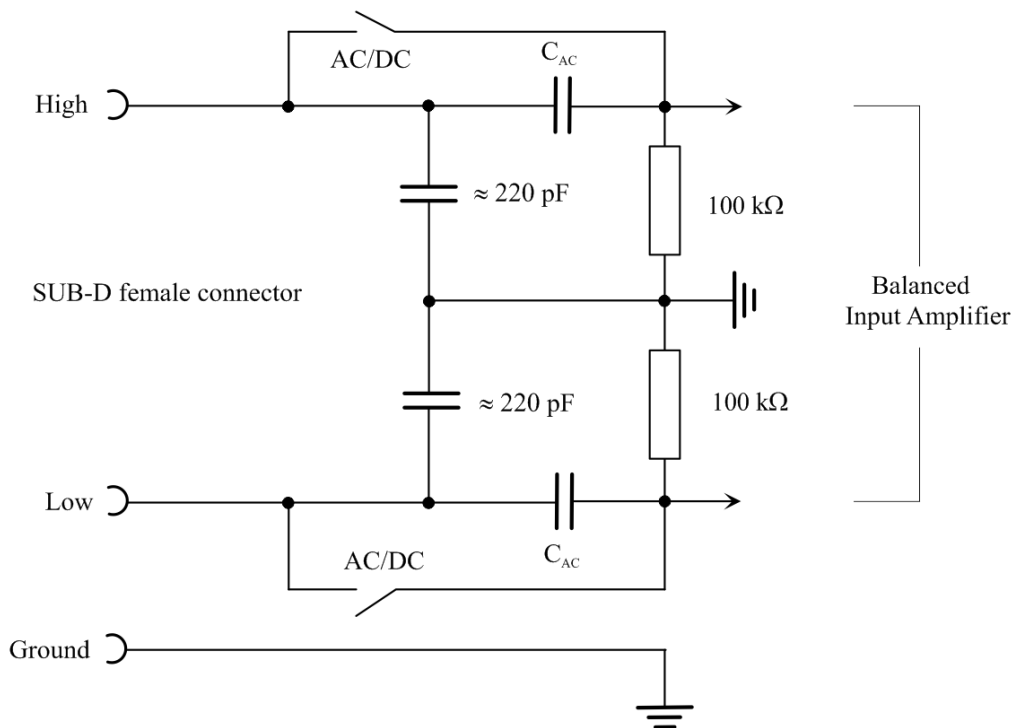


Fig. 5-18: Balanced analyzer input

The eight analyzer inputs are available on the pins of a 25-contact D-Sub socket. To adapt to the XLR connectors commonly used in the audio world, a breakout cable with a 25-pin D-Sub connector on one end and eight XLR input sockets on the other end

has to be connected (R&S UPV-Z48 option; for the order number, refer to the data sheet).

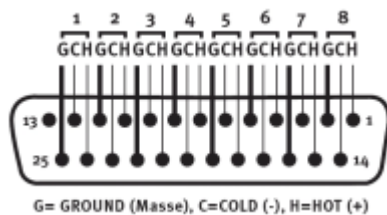


Fig. 5-19: Pin assignment of the 25-contact D-Sub male connector

The pin assignment corresponds to TASCAM's DB-25 Pinout Standard.

To enable unbalanced feed to the analyzer inputs, it is advisable to use the R&S UP-Z1MF XLR/BNC adapter in addition to the breakout cable described above. The internal wiring of this adapter is shown in the figure below.

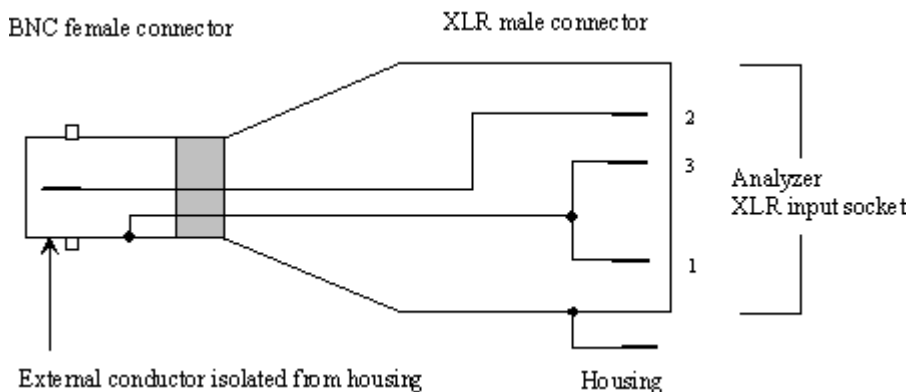


Fig. 5-20: R&S UP-Z1M XLR/BNC adapter

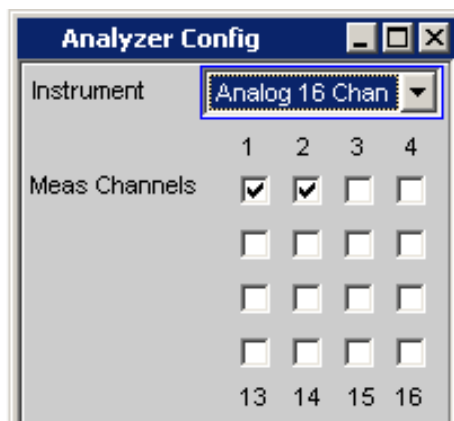
Meas Channels

Used to select the active inputs on the rear panel (25-pin D-Sub connector).



The active measurement channels are selected by enabling the desired channels. All inputs are floating; they are terminated with an input impedance of 200 kΩ.

If the R&S UPV is equipped with two R&S UPV-B48 options, 16 channels are available:



Remote command:

[INPut<n1>:MCHannels<n2>](#) on page 893

AC/DC Coupling

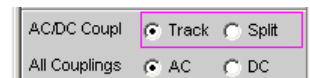
Used to select the input coupling.

AC or DC coupling can be selected. The coupling can be selected for all channels together (Track) or separately from each other (Split).



"Track mode"

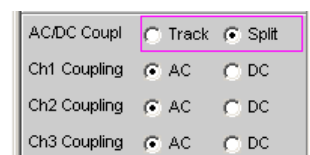
If Track is selected in the operator field above, the following field is visible:



The reference channel for the Track function is always the reference channel. The coupling of the inactive channels does not change.

"Split mode: "

If Split is set, coupling can be selected for each channel individually:



Remote command:

[INPut<n1>:COUpling:CHANnels](#) on page 893

Chx Coupling

Used to select the input coupling.

AC or DC coupling can be selected. The selection of the coupling can be performed with the "AC/DC Coupling" field above it jointly for all channels (Track) or separate of each other (Split).

DC coupling should be selected if input voltages with very low-frequency signal components are to be measured.

- "AC" The DC component of the sample signal is removed at the input using a highpass filter and therefore cannot affect the measurement result.
- "DC" Sample signals up to 0 Hz are recorded and taken into consideration in the measurement results of RMS, RMS Selective, Peak, Quasi Peak, DC, FFT and Waveform.
- Note:** If the input signal contains a large DC component, this results in a reduced dynamic range for the AC component, since the measurement range of the input amplifier is based on the overall signal.

Remote command:

`INPut<n1>:COUPling` on page 893

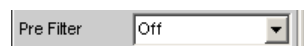
Bandwidth

The analyzer bandwidth is permanently set at 40 kHz. This field is a pure display window for informing the user of the maximum possible measurement bandwidth.



Pre Filter

The selected prefilter affects all measurement functions. This permits desired prefiltering without selecting appropriate filters for the individual measurement functions.



For the characteristics of the various filters, see [chapter 5.43, "Filter"](#), on page 626.

Remote command:

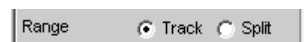
`INPut<n1>:FILTer` on page 958

For a description of the filters and their setting parameters, see [chapter 5.43.4, "Filter Table"](#), on page 628.

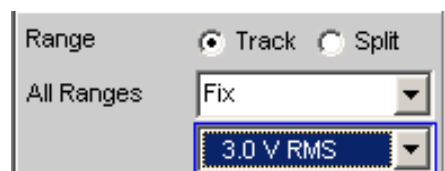
Range

The possibility of selecting the measurement range allows optimum adaptation to a voltage range required for a specific measurement task.

As with the switch-over between AC and DC coupling, it is also possible to select between two options for range setting: either a common setting function for all ranges of the active channels or independent setting of individual channels.



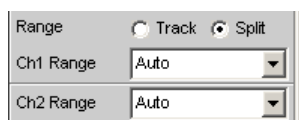
The reference channel for the Track function is always the active channel. Independent of this, the inactive channels always remain in the most insensitive range.



To prevent overranging of one or more active channels, the least sensitive range of all active channels is set by the following manual switch-overs:

- In Track mode when switching over from Auto to Lowest, or from Fix to Lowest
- When switching over from Split to Track if the reference channel is set to Fix or Lowest.

If Split was selected in the operator field above, the range settings can be selected separately for each activated channel above.



The number of newly displayed operator fields depends on the number of activated measurement channels.

Remote command:

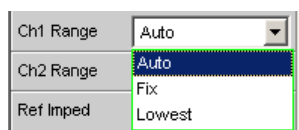
`INPut<n1>:RANGe:CHANnels` on page 893

Chx Range

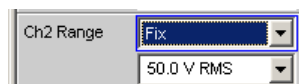
The possibility of selecting the measurement range allows optimum adaptation to a voltage range required for a specific measurement task.

As with the switch-over between AC and DC coupling, it is also possible to select between two options for range setting: either a common setting function for all ranges of the active channels or independent setting of individual channels, see "Range" on page 380.

It is possible to switch between 3 modes. If all channels have the same setting (Track), only the text "All Ranges" appears to the left of the selection box.



If the Fix and Lowest modes are selected, the set nominal range value appears in the next field, where a new range can be set by opening the selection window.



The ranges are graduated in steps of 12 dB from 200 mV to 50 V and allow very good dynamic range when measuring nonlinear distortion. If "Range Auto" (automatic range selection) is set, overranging or underranging of the limits in a current measurement range causes the instrument to switch to the next step. This is also the case for the "Range Lowest" range setting; here, however, the instrument only goes down to the selected range limit.

The range values are RMS values for sine waves or other signal shapes up to a crest factor of $\sqrt{2}$.

ch = Channel number 1 ... 16

nu = "range nominal value or "any voltage value""

nu = 200 mV (0.00 to 0.21999 V)

nu = 800 mV (0.22 to 0.87999 V)

nu = 3 V	(0.88 to 3.29999 V)
nu = 12 V	(3.3 to 13.19999 V)
nu = 50 V	(13.2 to 55.00 V)
"Auto"	Automatic measurement range selection. The optimum range is set separately for each channel.
"Fix"	The set measurement range is fixed. Note: If a voltage exceeding the selected level range is applied, the analyzer status is displayed with a red digit in the lower status line (the digit indicates the channel that is overranged) and the measured values are shown as invalid ("---"). On switching from Auto to Fix, the currently valid range in the channel is taken over.
"Lowest"	The set measurement range is fixed as the lowest range; in the event of overdrive, this range is automatically substituted by higher ranges. Note: On switching from Auto to Lowest, the currently valid range in the channel is taken over.

Remote command:

[SENSe<n1>:VOLTage:RANGe<n3>:MODE](#) on page 894

[SENSe:VOLTage:RANGe<n3>:VALue](#) on page 895

Ref Imped

Reference value for impedance.

Ref Imped	600.000	Ω
-----------	---------	---

Reference impedance for the indicated power in the units dBm, W, Δ%W, ΔW, P/Pr and %P/Pr.

The power is calculated using the following formula:

$$P = \frac{U^2}{R}$$

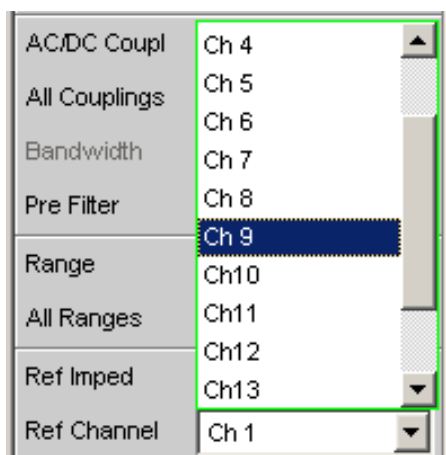
where U is the measured voltage and R is the set reference impedance. The indicated power is only correct if the reference impedance is identical to the resistance of the DUT.

Remote command:

[SENSe<n1>:POWer:REFEreNce:RESistance](#) on page 894

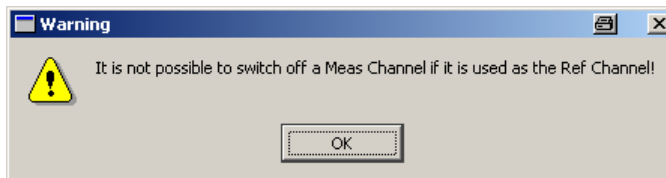
Ref Channel

Reference channel for phase measurements, channel-specific measurements such as common-channel rejection and the like.



Each measurement channel can be selected as a reference channel. If a channel which is selected as a reference channel is not yet active (switched off), the channel is automatically switched on.

Switching off a measurement channel that was selected as the reference channel is prevented, and the user is advised of this by the following warning:

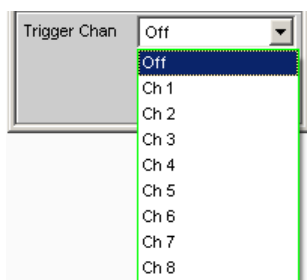


Remote command:

[SENSe<n1>:REFerence<n2>:CHANnel](#) on page 894

Trigger Chan

Used to select the channel whose event triggers a measurement.



If a measurement channel which was inactive is selected as a trigger channel it is automatically switched on. A warning appears if the channel selected as a trigger channel is switched off.

Switching off the measuring channel, which was selected as the trigger channel, therefore changes the trigger channel after this warning has been acknowledged.

Remote command:

[TRIGger:CHANnel](#) on page 909

Start Cond

Specifies the event which triggers a measurement.



Depending on the "Start Cond" selected, the measurement starts either immediately (Auto) or only once the required trigger condition is met; For details, see [chapter 5.20, "Start Conditions"](#), on page 444.

Remote command:

[TRIGger: SOURce](#) on page 910

Delay

Delay for Start Cond.



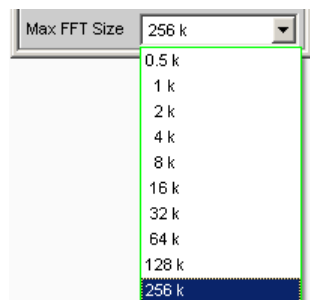
You can enter a delay for the menu item "Start Cond Auto". For details, see [chapter 5.20, "Start Conditions"](#), on page 444.

Remote command:

[TRIGger: DELay](#) on page 909

Max FFT Size

Used to limit automatic zoom fitting for the FFT size for all FFT-supported measurement functions (e.g. THD, THD+N, DFD, each with Post FFT) to the selected value with the goal of increasing measurement speed.



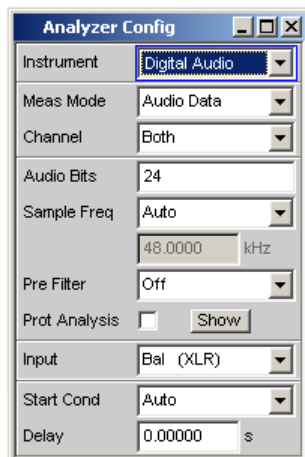
The limit to the FFT size is particularly useful for external sweeps for adapting the measurement time to the time frame of an external time tick. A limit is usually associated with degradation in measuring accuracy since incidents such as carrier-level noise can no longer be completely recorded.

Remote command:

[SENSe<n1>:MAX:FFT:SIZE](#) on page 894

5.14 Configuring the Digital Analyzer

5.14.1 Digital Analyzer Configuration Panel



The Config panel is used to set up the analog and digital analyzer. The configuration options for the digital audio analyzer are described below. The digital Audio Analyzer is only available with the R&S UPV-B2 (digital audio interfaces) or R&S UPV-B20 (digital audio interfaces, 48 kHz) option.

With digital audio interfaces, there are basically two signal types, i.e. the physical interface signal and the encoded audio signal itself.

The R&S UPV measures the physical interface signal and the encoded audio signal. The data content of the selected digital audio input is extracted from the digital audio signal and analyzed.

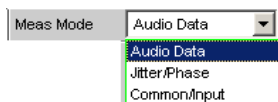
Meas Mode

Meas Mode specifies what is to be measured at the digital interfaces.

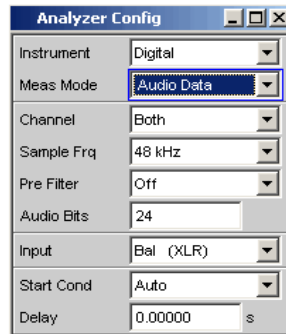
With digital audio interfaces, there are basically two signal types which have to be measured, i.e. the interface signal and the encoded audio signal itself.

Besides the encoded audio signal (audio data), the R&S UPV is also able to measure various interference signals (impairments) at the interface:

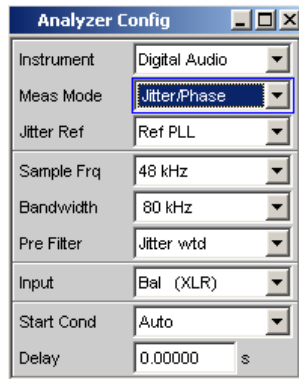
Shifting of the signal edges (jitter) or superimposition of a common-mode voltage on the balanced digital lines (common mode). The internal analog analyzer is used for measuring such signals.



"Audio Data" The data content of the selected digital audio input is extracted from the digital audio signal and analyzed.
The Analyzer Config panel contains the selection fields relevant for this Meas Mode.



"Jitter/Phase" (Only with UPV-B2 (digital audio interface)). Measurement of jitter signals at the digital audio inputs.
Measurement of a frame phase offset of the digital audio signal between the front input and AUX input.

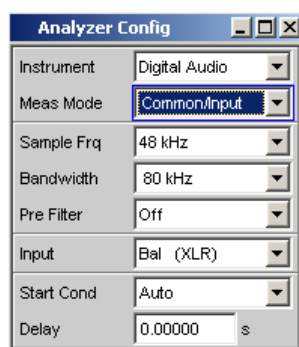


The digital interface signal has analog parameters on which, for example, noise or other interference signals can be superimposed – this interference is also noticeable as shifting of the signal edges. When this effect (known as "jitter") exceeds a certain magnitude, it becomes impossible to decode or regenerate the audio signal correctly. Here, the decoders used in practice often behave differently which means that it may be advisable to perform measurements across the entire range of jitter compatibility, for example.

The value of the jitter and delay fault is normally given in UI (Unit Interval). One UI is defined as the smallest pulse width of the digital audio signal (eye width) and does not depend on the selected sampling rate. One UI corresponds to the clock period with which the digital signal is clocked ("biphase clock"). For digital audio signals, one UI corresponds to the 128th part of the sampling period; for 48 kHz, one UI is approx. 163 ns.

If several digitally encoded signals are merged (common practice in, for example, studio engineering), the phase position of the frames in the digital audio signals (i.e. the components which contain the sample value of the left and right-hand channel) plays a significant role. With the R&S UPV, this shift can be measured as the phase between the digital input (on the front panel) and the reference channel (AUX input on the rear panel).

"Common/
Input"



(only with R&S UPV-B2 (digital audio interfaces)). Measurement of the common signal at the digital Bal input.

The DIGITAL INPUT amplitude can be measured at the Bal or Unbal input.

As is customary in analog technology, balanced cables are also used for digital audio signal links. Here, coupled impairments (e.g. from ground loops) occur as common-mode voltage at the interfaces.

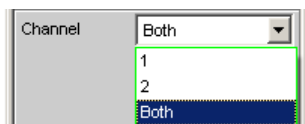
Remote command:

[SENSe<n1>:DMODE](#) on page 896

Channel

Used to set the active measurement channel in the Meas Mode "Audio Data".

Used to select the audio data for the left channel (Channel = 1), right channel (Channel = 2) or both channels (Channel = Both).



If a single-channel measurement is selected (Ch1 or Ch2), the data content of the other channel is not taken into consideration.

"1" Only the signal on the left channel is measured.

"2" Only the signal on the right channel is measured.

"Both" Both channels are measured (stereo).

Remote command:

[INPut<n1>:CHANnel](#) on page 895

Audio Bits

Word width used by the digital audio analyzer in the Meas Mode "Audio Data".

Value range: 8 ... 24

If the word width is reduced, the values of the audio samples are trimmed down to the specified word width. Reduced word width results in a corresponding reduction in dynamic range.



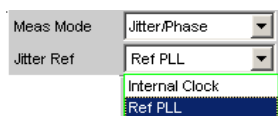
Remote command:
[INPut<n1>:AUDiobits](#) on page 895

Jitter Ref

(Only with R&S UPV-B2 (digital audio interfaces)). Used to select the jitter reference clock (only available for jitter measurement).

If jitter is to be measured, a reference clock must be available. The internal oscillator (generator clock) can be used for this purpose. Alternatively, a reference PLL (Phase Locked Loop) can also be used if the DUT is not synchronized to the generator of the R&S UPV.

The clock rate of the jitter reference must be the same as the clock rate of the digital audio signal at the input. The clock of the digital audio generator or the clock obtained from the jitter reference PLL of the analyzer is provided for this purpose.



"Internal Clock" The internal clock generator is used for the jitter reference. This setting is the best one to use if the digital audio signal to be measured is supplied by the Digital Audio Generator of the R&S UPV and the generator is running at the internal clock rate. In this case, a lower frequency does not need to be taken into account when measuring jitter.

"Ref PLL" The reference signal is the clock signal obtained from the digital audio input signal using the jitter reference PLL. The lower limit frequency of this PLL must be taken into consideration for the jitter measurement; if the frequency drops below this limit, the reference signal changes with the jitter signal and a low jitter value is measured. The limit frequency of the jitter reference PLL is approx. 500 Hz.

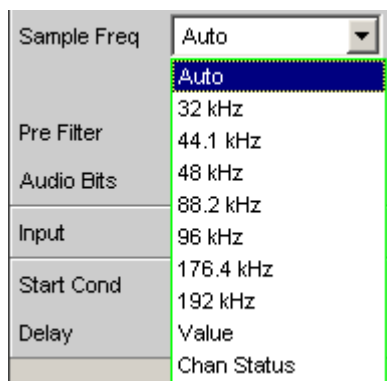
Remote command:
[SENSe<n1>:JITTer:REFerence](#) on page 896

Sample Freq

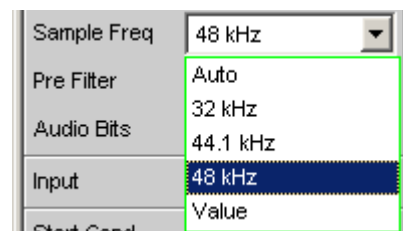
Used to set the clock rate of the digital audio signal for the analyzer.

The sample frequency setting is used as a reference for all audio data frequency measurements.

UPV-B2 (digital audio interfaces):



UPV-B20: (digital audio interfaces, 48 kHz):



If the entered frequency does not correspond to the applied frequency, all filters and frequency measurements are shifted accordingly with respect to frequency.

When jitter measurements are performed and the jitter-reduced digital audio signal is output at the AUX output (reclock function), this parameter is used to select the correct range for the reference PLL (only with R&S UPV-B2 (digital audio interfaces)).

Value range for numeric input:

30 kHz to 200 kHz (30 kHz to 55 kHz with R&S UPV-B20 (digital audio interface, 48 kHz))

Standard sampling frequencies can be set directly in the selection field.

Note: Sampling rates below 50 kHz allow the input signal to be monitored across the entire frequency range (particularly via FFT and waveform).

Synchronization ranges for the jitter reference PLL:

30 kHz to 64 kHz (base rate range)

65 kHz to 128 kHz (high rate range)

129 kHz to 200 kHz (extended rate range)

"Auto" The sampling rate is measured, set and displayed in the following line. If the applied sampling rate is changed the set value is automatically updated.

Note: The digital analyzer must re-initialized for each new sampling frequency. To avoid the need to repeat this time-consuming procedure too often, minor deviations and fluctuations (below 3 Hz) are ignored.

"32 kHz to 192 kHz" Standard sampling rate 32 kHz to 192 kHz

"Value " Variable input of sampling rate

"Chan Status" The sampling rate is determined by decoding the corresponding channel status bits in the AES/EBU protocol of the measured signal. Different bits (24 to 27 or 6 to 7 and 35 to 38) are decoded, depending on the format used (consumer or professional). The sampling rate is updated when a different sampling rate is decoded from the channel status bits.

If the channel status bits do not supply any information ("not indicated"), the sampling rate last determined remains active.

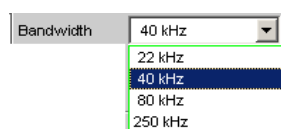
Remote command:

[INPut<n1>:SAMPle:FREQuency:MODE](#) on page 896

[INPut<n1>:SAMPle:FREQuency](#) on page 896

Bandwidth

(only with R&S UPV-B2 (digital audio interfaces)). With impairment analysis, jitter and common signals are measured up to this bandwidth setting.



"22 kHz" Analog analyzer bandwidth 22 kHz

"40 kHz" Analog analyzer bandwidth 40 kHz

"80 kHz" Analog analyzer bandwidth 80 kHz

"250 kHz" Analog analyzer bandwidth 250 kHz

Remote command:

[INPut<n1>:BANDwidth:MODE](#) on page 893

Pre Filter

The selected prefilter affects all measurement functions. This permits desired prefiltering without selecting appropriate filters for the individual measuring functions.



Remote command:

[INPut<n1>:FILTer](#) on page 958

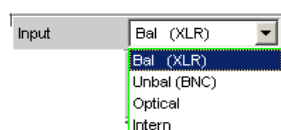
Input

Used to select the input interface for the digital audio analyzer:

In Meas Mode Common/Input (Option R&S UPV-K22), the common mode signal is always measured at the XLR socket (Bal) regardless of the digital input selected.

The "DIG INP AMP" measurement is performed at the selected input (Bal or Unbal).

The Common/Input measurement is not possible for the optical input or if "Intern" is selected.



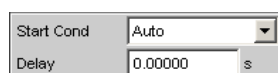
"Bal (XLR)"	Balanced digital audio input (XLR).
"Unbal (BNC)"	Unbalanced digital audio input (BNC).
"Optical"	Optical digital audio input (TOSLINK).
"Intern"	Internal at digital audio generator output. Loop measurement possible without connected cable.

Remote command:

`INPut<n1>:TYPE` on page 896

Start Cond

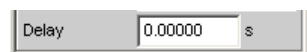
Specifies the event which triggers a measurement.



After the Start Cond has been selected, measurement either begins immediately (Auto) or only when the desired trigger condition is fulfilled; for details see [chapter 5.20, "Start Conditions"](#), on page 444.

Delay

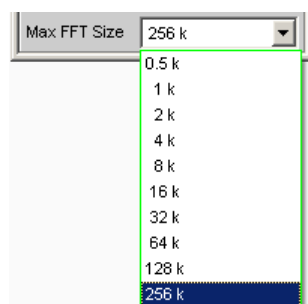
Delay for Start Cond.



A delay time can be entered for the Start Cond Auto menu item; for details see [chapter 5.20, "Start Conditions"](#), on page 444.

Max FFT Size

Used to limit automatic zoom fitting for the FFT size for all FFT-supported measurement functions (e.g. THD, THD+N, DFD, each with Post FFT) to the selected value with the goal of increasing measurement speed.



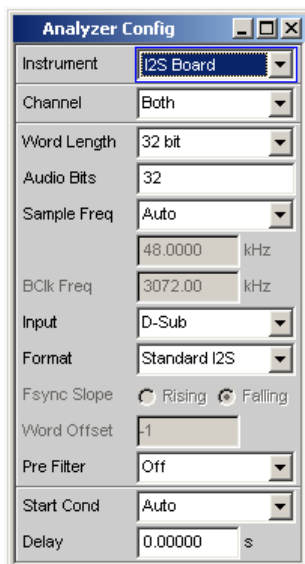
The limit to the FFT size is particularly useful for external sweeps for adapting the measuring time to the time frame of an external time tick. A limit is usually associated with degradation in measuring accuracy since incidents such as carrier-level noise can no longer be completely recorded.

Remote command:

`SENSe<n1>:MAX:FFT:SIZE` on page 894

5.15 Configuring the I²S Analyzer

5.15.1 I²S Analyzer Configuration Panel

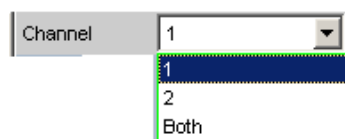


The Config panel is used to set up the analog and digital analyzer. The configuration options for the I²S analyzer are described below. The I²S analyzer is available only with the R&S UPV-B41 (I²S interface) option

Channel

Used to set the active measurement channel.

Used to select the audio data for the left channel (Ch1), right channel (Ch2) or both channels.



If a single-channel measurement is selected (Ch1 or Ch2), the data content of the other channel is not taken into consideration.

"1" Only the signal on the left channel is measured.

"2" Only the signal on the right channel is measured.

"Both" Both channels are measured (stereo).

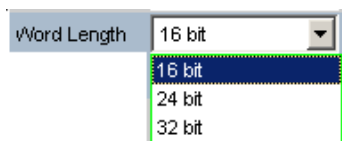
Remote command:

[INPut<n1>:CHANnel](#) on page 895

Word Length

Word length of a data frame for each channel.

Value range: 16, 24, 32



Remote command:

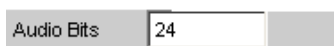
[INPut<n1>:WLENgth](#) on page 898

Audio Bits

Word width of audio data that is analyzed.

If the word width is reduced, the values of the audio samples are trimmed down to the specified word width. Reduced word width results in a corresponding reduction in dynamic range.

Value range: 8 to Word Length



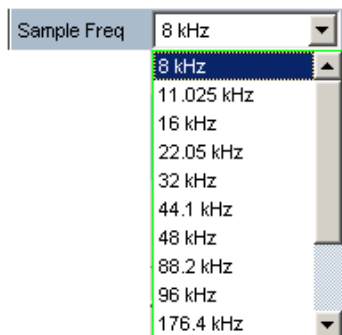
Remote command:

[INPut<n1>:AUDIobits](#) on page 895

Sample Freq

Setting the sampling frequency.

The sampling frequency corresponds to the frequency of the FSYNC signal. All frequency information of measured audio data relates to this setting.



If the selected frequency does not correspond to the applied frequency, all filters and frequency measurements are shifted accordingly with respect to frequency.

Standard sampling frequencies can be set directly in the selection field.

"Auto" The sampling rate is measured, set and displayed in the following line. If the applied sampling rate is changed the set value is automatically updated.

Note: The digital analyzer must re-initialized for each new sampling frequency. To avoid the need to repeat this time-consuming procedure too often, minor deviations and fluctuations (below 3 Hz) are ignored.

"8 kHz to 384 kHz" Standard sampling rates 8 kHz ... 384 kHz

"Value:" Variable input of sampling rate
Value range for numeric input: 6.75 kHz to 410 kHz

Remote command:
[INPut<n1>:SAMPle:FREQuency:MODE](#) on page 896
[INPut<n1>:SAMPle:FREQuency](#) on page 896

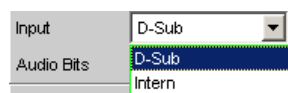
BCK Freq

Displays the bit clock frequency. This is calculated from Sample Freq" * "Word Length" * 2.

Remote command:
[INPut<n1>:BCLK:FREQuency?](#) on page 897

Input

Used to select the data source for the I²S audio analyzer:

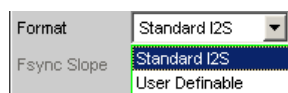


"D-Sub" The D-Sub connector is selected as the input.
"Intern" The internal generator is selected as the input. A loop measurement can be performed without a connected cable being required (loop-back test).

Remote command:
[INPut<n1>:INPut](#) on page 897

Format

Selection of the I²S analyzer format



"Standard I²S" The I²S analyzer receives in the standard I²S format. The following parameters that have an effect on the format have fixed default settings:
Fsync Slope Left(1) = Falling
Word Offset -1

"User-definable" The I²S analyzer receives in a format similar to I²S. The following format-influencing parameters are additionally available:
Fsync Slope
Word Offset

Remote command:
[INPut<n1>:FORMat](#) on page 897

Fsync Slope

Polarity of the Fsync signal.



- "Rising" With a word offset of 0 a rising signal edge indicates the word beginning of the left data word (channel 1).
- "Falling" With a word offset of 0 a falling signal edge indicates the word beginning of the left data word (channel 1).

Remote command:

`INPut<n1>:FSLoPe` on page 897

Word Offset

By using Word Offset, you can set the number of the SCK cycles by which the Fsync signal is analyzed with delay with respect to the audio data.

Value range: -Word Length to 0 to +Word Length-1



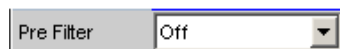
A screenshot of a control panel for 'Word Offset'. It consists of a label 'Word Offset' followed by a text input field containing the number '1'.

Remote command:

`INPut<n1>:WOffSet` on page 898

Pre Filter

The selected prefilter affects all measurement functions. This permits desired prefiltering without selecting appropriate filters for the individual measuring functions.



A screenshot of a control panel for 'Pre Filter'. It consists of a label 'Pre Filter' followed by a dropdown menu with 'Off' selected.

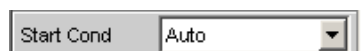
Remote command:

`INPut<n1>:FILTer` on page 958

For a description of the filters and their setting parameters, see [chapter 5.43.4, "Filter Table"](#), on page 628.

Start Cond

Specifies the event which triggers a measurement.

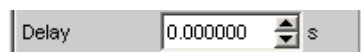


A screenshot of a control panel for 'Start Cond'. It consists of a label 'Start Cond' followed by a dropdown menu with 'Auto' selected.

After the Start Cond has been selected, the measurement either begins immediately (Auto) or only when the desired trigger condition is fulfilled; for details see [chapter 5.20, "Start Conditions"](#), on page 444.

Delay

Delay for Start Cond.

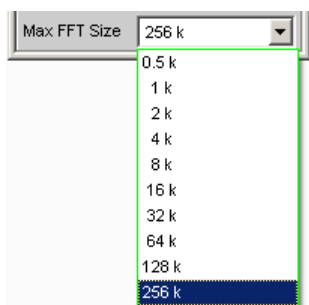


A screenshot of a control panel for 'Delay'. It consists of a label 'Delay' followed by a numeric input field containing '0.000000' and a unit selector dropdown set to 's'.

A delay time can be entered for the Start Cond Auto menu item; for details see [chapter 5.20, "Start Conditions"](#), on page 444.

Max FFT Size

Used to limit automatic zoom fitting for the FFT size for all FFT-supported measurement functions (e.g. THD, THD+N, DFD, each with Post FFT) to the selected value with the goal of increasing measurement speed.



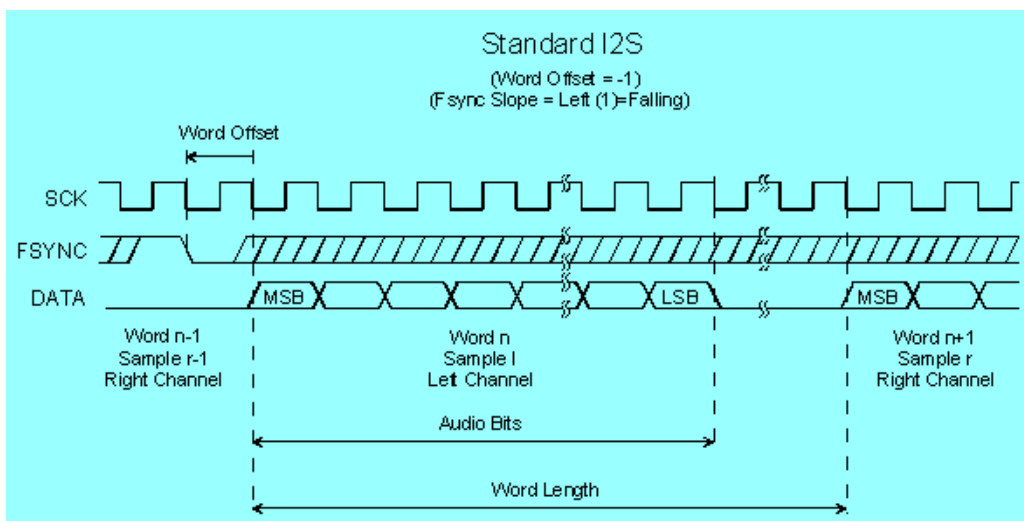
The limit to the FFT size is particularly useful for external sweeps for adapting the measuring time to the time frame of an external time tick. A limit is usually associated with degradation in measuring accuracy since incidents such as carrier-level noise can no longer be completely recorded.

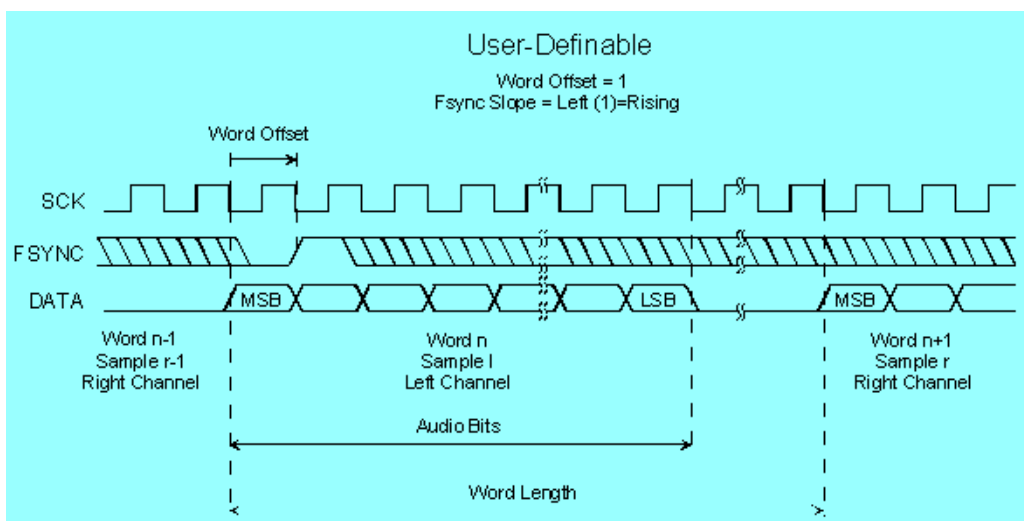
Remote command:

`SENSe<n1>:MAX:FFT:SIZE` on page 894

5.15.2 Timing Diagrams

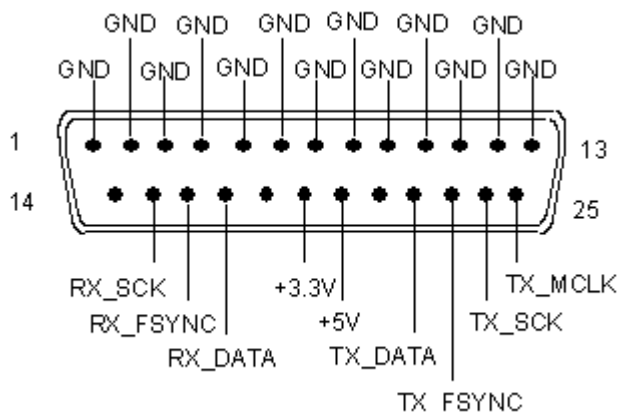
A number of configuration examples are shown in the timing diagrams below which illustrate the effect of some parameters.





5.15.3 Interface Assignment

I²S plug (25-pin D-Sub connector) when using the R&S UPV-B41 (I²S interface) option.



Connection	Signal	Input (I) Output (O)	Description
1	GND		Ground terminal
2	GND		Ground terminal
3	GND		Ground terminal
4	GND		Ground terminal
5	GND		Ground terminal
6	GND		Ground terminal
7	GND		Ground terminal
8	GND		Ground terminal

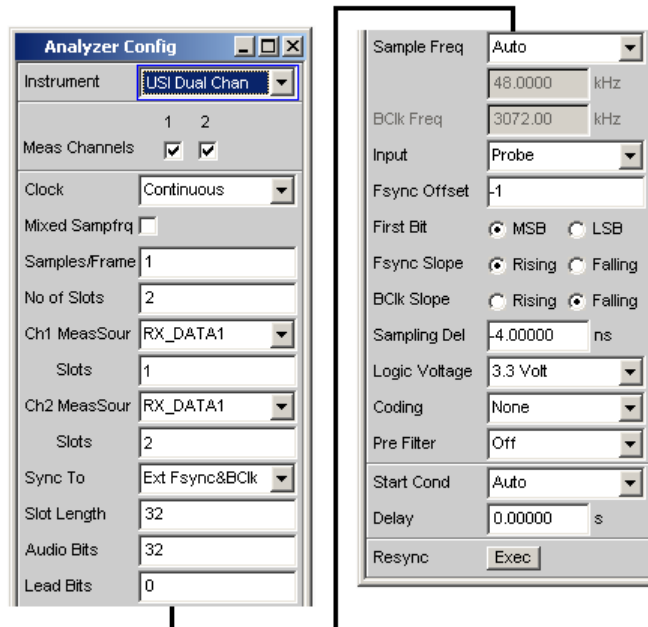
Connection	Signal	Input (I) Output (O)	Description
9	GND		Ground terminal
10	GND		Ground terminal
11	GND		Ground terminal
12	GND		Ground terminal
13	GND		Ground terminal
14	not connected		
15	RX_SCK	E	Serial Clock Analyzer
16	RX_FSYNC	E	Frame Sync Analyzer
17	RX_DATA	E	Serial Data Analyzer
18	not connected		
19	+3.3 V (500 mA)	A	Power Supply
20	+5 V (500 mA)	A	Power Supply
21	not connected		
22	TX_DATA	A	Serial Data Generator
23	TX_FSYNC	A	Frame Sync Generator
24	TX_SCK	A	Serial Clock Generator
25	TX_MCLK	A	Master Clock Output Generator

TX MCLK IN (BNC jack)

Connection	Signal	Input (I) Output (O)	Data direction
Outer conductor	GND		Ground terminal
Inner conductor	TX_CLK	E	Master Clock Input Generator

5.16 Configuring the USI Dual Channel Analyzer

5.16.1 USI Dual Channel Analyzer Configuration Panel



The USI Dual Channel Analyzer is only available with the R&S UPV-B42 (universal serial interface) option and consists of a plug-in card, a cable and a probe for contacting a device under test. For the pin assignment of the probe, see [chapter 5.16.3, "Interface Assignment"](#), on page 413.

The configuration options for the USI dual channel analyzer are described below.

During the boot process of the R&S UPV with the "USI Dual Chan" instrument, a check is performed whether the probe is connected and ready for operation, otherwise a warning is issued. If the probe is connected **after** the R&S UPV is switched on, only the "USI Dual Chan" instrument must be confirmed to initialize the sample. A green LED on the probe shows the operational readiness. This mechanism permits the probe to be detached and reattached and put back into operation during operation. Detaching and reattaching during operation does not damage the probe!

Meas Channels

Used to set the active measurement channel.



"1" Measurement channel 1 is switched on or off.

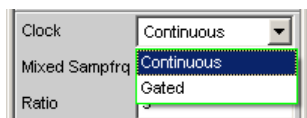
"2" Measurement channel 2 is switched on or off.

Remote command:

`INPut<n1>:MCHannels<n2>` on page 893

Clock

Used to select the continuous clock or gated clock operating modes.



"Continuous" The continuous clock operating mode requires a continuous clock for the generator. The clock source may be internal or external. If synchronization is external, several types of synchronization are available for selection.

"Gated" The gated clock operating mode must be selected if the externally supplied bit clock (BClk) and the FrameSync (Fsync) are discontinuous or have such a large jitter that the internal PLL can no longer follow this clock.

In this operating mode, synchronization is limited to the external FrameSync & bit clock (Ext Fsync&BClk) option. The audio signal generated cannot be monitored.

Remote command:

[INPut<n1>:CLOCK](#) on page 899

Mixed Sampfrq

Permits simultaneous analysis of data streams at varying sampling rates. The pre-filter is not available when this is activated.



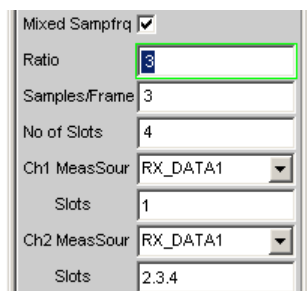
Remote command:

[INPut<n1>:MSAMplefrequency](#) on page 901

Ratio

Up-sampling factor for the slower data stream. The input data with the lower sampling rate is characterized by correspondingly fewer entries in the Slots input field.

Value range: 2 ... 6



Example:

The sampling rate of the input data differs by a factor of 3. This means that one frame always contains 3 samples of the channels with the higher sampling rate and just 1 sample of the channel with the lower sampling rate. The sample of the channel with the lower data rate is in slot 1 on line 1, while the samples of the channel with the higher data rate are in slots 2, 3 and 4 of the same data line.

Remote command:

[INPut<n1>:RATio](#) on page 901

Samples/Frame

Used to define the number of samples per frame.

The parameter simultaneously determines the minimum settable sampling rate according to the relationship: $fs_min = 843.75 \text{ Hz} * \text{samples/frame}$

Value range: 1 ... 32



Remote command:

[INPut<n1>:SPFRame](#) on page 902

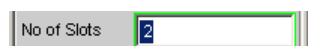
No of Slots

Used to define the number of slots in a frame.

Value range: 1 ... 256

$No_of_Slots * Slot_Length \leq 2048$

$Slot_Length * No_of_Slots * Sample_Freq \leq 55.926 \text{ MHz}$

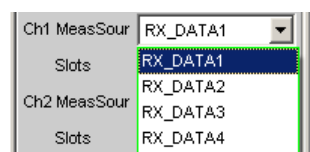


Remote command:

[INPut<n1>:NOSLots](#) on page 901

Ch1 MeasSour

Used to select the input data line for measuring channel 1.



"RX_DATA1" Measuring channel 1 analyzes the RX_DATA1 data line.

"RX_DATA2" Measuring channel 1 analyzes the RX_DATA2 data line.

"RX_DATA3" Measuring channel 1 analyzes the RX_DATA3 data line.

"RX_DATA4" Measuring channel 1 analyzes the RX_DATA4 data line.

Remote command:

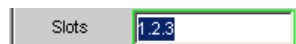
[INPut<n1>:MCHSource<n2>](#) on page 901

Slots

Used to select the audio frame slots to be analyzed for measuring channel 1.

(More than one channel can only be selected with multi-sample formats! In this case a frame contains several consecutive samples from the same signal source).

Value range: 1 to No of Slots

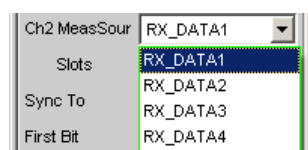


Remote command:

[INPut<n1>:SLOTs<n2>](#) on page 902

Ch2 MeasSour

Used to select the input data line for measuring channel 2.



"RX_DATA1" Measuring channel 2 analyzes the RX_DATA1 data line.

"RX_DATA2" Measuring channel 2 analyzes the RX_DATA2 data line.

"RX_DATA3" Measuring channel 2 analyzes the RX_DATA3 data line.

"RX_DATA4" Measuring channel 2 analyzes the RX_DATA4 data line.

Remote command:

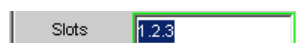
[INPut<n1>:MCHSource<n2>](#) on page 901

Slots

Used to select the audio frame slots to be analyzed for measuring channel 2.

(More than one channel can only be selected with multi-sample formats! In this case a frame contains several consecutive samples from the same signal source).

Value range: 1 to No of Slots



Remote command:

[INPut<n1>:SLOTs<n2>](#) on page 902

Sync To

Used to select the source on which the USI analyzer is synchronized.

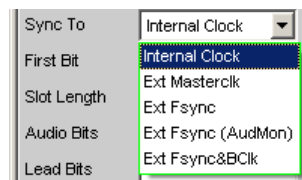


Table 5-2: Overview of the various synchronization modes:

	Internal clock	External master clock	External frame sync	External frame sync with audio monitor	External frame sync, bit clock	External frame sync, bit clock (gated)
Master clock Output	o	tri	o	tri	tri	tri
Master clock Input	--	x	--	--	--	--
Bit clock Output	o	o	o	o	tri	tri
Bit clock Input	--	--	--	--	x	x
Frame sync Output	o	o	o	o	tri	tri
Frame sync Input	--	--	x	x	x	x
x = Input Signal must be present o = Output Signal is available tri = Output in tristate mode (high impedance) -- = Unused Input						

"Internal Clock" The analyzer uses the instrument's internal clock.

"Ext Masterclk" Synchronizes to an external master clock (TX_MCLK_IN).

"Ext Fsync" Synchronizes to an external FrameSync signal (TX_FSYNC_IN). Audio monitoring of the analyzer signal is not possible. A master clock is additionally generated and output.

"Ext Fsync (AudMon)" Synchronizes to an external FrameSync signal (TX_FSYNC_IN). It is not possible to audio monitor the analyzer signal. No master clock signal is output.

"Ext Fsync&BClk" Synchronizes to the external FrameSync (TX_FSYNC_IN) and bit clock (TX_BCLK_IN) signals.

Remote command:

[INPut<n1>:SYNcto](#) on page 902

First Bit

Used to define the data bit receiving sequence



"MSB" The most significant data bit is received first.

"LSB" The least significant data bit is received first.

Remote command:

[INPut<n1>:FBIT](#) on page 899

Slot Length

Slot length of a slot including gaps (0 bits)

Value range: 1 ... 256

$\text{No_of_Slots} * \text{Slot_Length} \leq 2048$

$\text{Slot_Length} * \text{No_of_Slots} * \text{Sample_Freq} \leq 55.926 \text{ MHz}$

A control panel for the Slot Length parameter. It consists of a grey rectangular background with the text "Slot Length" on the left and a white input field on the right containing the number "32". The input field has a green border and a blue selection bar.

Remote command:

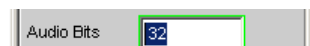
[INPut<n1>:SLTLength](#) on page 902

Audio Bits

Word width of the audio data within a slot.

Only the specified number of data bits are analyzed.

Value range: 8 to slot length (max 32)

A control panel for the Audio Bits parameter. It consists of a grey rectangular background with the text "Audio Bits" on the left and a white input field on the right containing the number "32". The input field has a green border and a blue selection bar.

Remote command:

[INPut<n1>:AUDIobits](#) on page 895

Lead Bits

Defines the offset for the audio bits within a slot relative to the start of the slot.

If LSB is selected as the first bit, the setting for lead bits is automatically corrected if the setting for audio bits is changed so that the MSB is received at the same location. This has the advantage that the resolution of the signal transmitted is changed but not the amplitude if the audio bits are changed.

Example:

Slot length: 32

Audio bits: 24 → 23 (setting changed by user)

Lead bits: 8 → 9 (automatic correction)

Value range: 0 to slot length audio bits

A control panel for the Lead Bits parameter. It consists of a grey rectangular background with the text "Lead Bits" on the left and a white input field on the right containing the number "0". The input field has a green border and a blue selection bar.

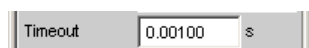
Remote command:

[INPut<n1>:LBITs](#) on page 900

Timeout

Only available in Gated Clock mode. This parameter defines the maximum time span for which external clocks are allowed to discontinue before the measurement is declared as invalid.

Value range: 1 ms to 500 ms



Remote command:

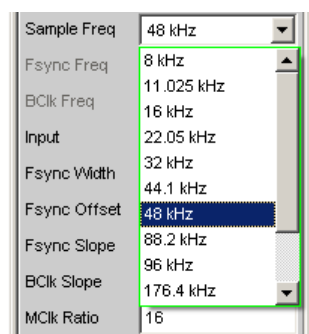
`INPut<n1>:TIMEout` on page 902

Sample Freq

Setting the sampling frequency.

All received audio data frequency specifications relate to this setting. The analyzer displays incorrect frequency values if the USI analyzer is operated with external synchronization and the frequency of the external clock signal does not correspond to the set sampling frequency.

For data formats with one sample per frame, the sampling frequency corresponds to the frequency of the Fsync signal. In case of several audio data samples from one source within one frame, the frequency of the Fsync signal is the product of the sampling frequency divided by the factor of samples/frame.



Value range for numeric input:

0.84375 kHz to 400 kHz

$No_of_Slots * Slot_Length \leq 2048$

$Slot_Length * No_of_Slots * Sample_Freq \leq 55.926 \text{ MHz}$

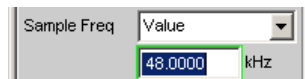
Standard sampling frequencies can be set directly in the selection field.

"Auto" The sampling rate is measured and displayed in the following line. If the applied sampling rate is changed the set value is automatically updated.

Note: The digital analyzer must re-initialized for each new sampling frequency. To avoid the need to repeat this time-consuming procedure too often, minor deviations and fluctuations (below 3 Hz) are ignored.

"8 kHz"	Standard sampling rate 8 kHz
"11.025 kHz"	Standard sampling rate 11.025 kHz
"16 kHz"	Standard sampling rate 16 kHz
"22.05 kHz"	Standard sampling rate 22,05 kHz
"32 kHz"	Standard sampling rate 32 kHz
"44.1 kHz"	Standard sampling rate 44.1 kHz
"48 kHz"	Standard sampling rate 48 kHz

"88.2 kHz"	Standard sampling rate 88,2 kHz
"96 kHz"	Standard sampling rate 96 kHz
"176.4 kHz"	Standard sampling rate 176.4 kHz
"192 kHz"	Standard sampling rate 192 kHz
"384 kHz"	Standard sampling rate 384 kHz
"Value "	Numeric input of the sampling frequency

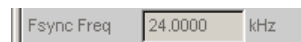


Remote command:

[INPut<n1>:SAMPlE:FREQuency:MODE](#) on page 896

Fsync Freq

Is only displayed for multi-sample formats. The Frame Sync frequency corresponds to the sampling rate divided by the samples/frame factor.



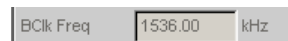
Remote command:

[INPut<n1>:FSYNc:FREQuency?](#) on page 900

BCLK Freq

Displays the bit clock frequency. Is the product of slot length * no of slots * sample freq / samples/frame.

Value range: 6.75 kHz to 55.296 MHz

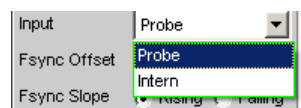


Remote command:

[INPut<n1>:BCLK:FREQuency?](#) on page 897

Input

Selection of the analyzer source. In internal mode, the probe is run in short circuit operation with the generator. For this the generator must be operated in internal clock synchronization mode and the analyzer in ExtFsync&BCLK mode. The signals produced by the generator can thus be analyzed without using an external plug connection. If the probe is selected as a source, the analyzer analyzes the signals at the connector.



Remote command:

[INPut<n1>:INPut](#) on page 897

Fsync Width

Fsync pulse width



- "1 bit" Fsync is one data bit in length (BClk period)
- "1 Slot" The FSYNC pulse is one slot in length (= slot length)
- "Square" The FSYNC pulse has the shape of a symmetrical rectangle. If the number of bit clock (BClk) cycles is odd, the high phase is one cycle longer than the low phase (with Fsync Slope = Rising)
- "Value " The length of the FSYNC pulse corresponds to the numeric value in data bits (1 BClk period)
Value range: 1 to (slot length*No of slots)-1

Remote command:

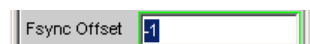
[INPut<n1>:FWIDth](#) on page 900

[INPut<n1>:FWIDth:VALue](#) on page 900

Fsync Offset

Determines the offset of the Fsync pulse relative to the reference point (start of the first slot).

Value range: -(slot length*No of slots) to (slot length*No of slots) - 1



Remote command:

[INPut<n1>:FOFFset](#) on page 900

Fsync Slope

FSYNC pulse polarity



"Rising" The FSYNC pulse begins with a positive edge.

"Falling" The FSYNC pulse begins with a negative edge.

Remote command:

[INPut<n1>:FSLope](#) on page 897

BClk Slope

Bit clock polarity (BClk)



"Rising" The RX_FSYNC_IN, RX_DATA1, RX_DATA2, RX_DATA3 and RX_DATA4 signals are synchronized with a rising bit clock edge (RX_BCLK_IN if the analyzer is synchronized externally, or RX_BCLK_OUT if it is internally synchronized). The FrameSync (RX_FSYNC_OUT) generated in master mode changes, however, with a falling bit clock edge (RX_BCLK_OUT).

"Falling" The RX_FSYNC_IN, RX_DATA1, RX_DATA2, RX_DATA3 and RX_DATA4 signals are synchronized with a falling bit clock edge (RX_BCLK_IN if the analyzer is synchronized externally, and RX_BCLK_OUT if it is internally synchronized). The FrameSync (RX_FSYNC_OUT) generated in master mode changes, however, with a rising bit clock edge (RX_BCLK_OUT).

Remote command:

`INPut<n1>:BSLope` on page 899

MClk Ratio

Relationship between the master clock (MCLK) and FrameSync (FSYNC).

Value range: 16 to 768 (max. 110.592 MHz)



Remote command:

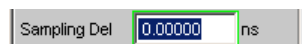
`INPut<n1>:MRATio` on page 901

Sampling Del

This parameter permits a delay of the RX_FSYNC_IN, RX_DATA1, RX_DATA2, RX_DATA3 and RX_DATA4 input signal sampling times in relation to the RX_BCLK_IN or RX_BCLK_OUT clocks. Positive values move the sampling towards a later time.

This feature is used above all if TCO delays, in other words response times of a device under test being operated in slave mode at high frequencies, reach the size of a bit clock period. In order to compensate for bit shifts when analyzing in the analyzer these delay times are compensated by a later sampling point.

Value range: -10 ns to +10 ns

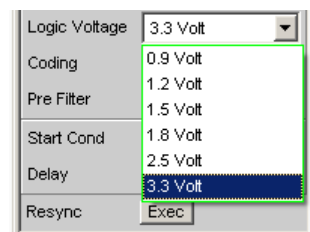


Remote command:

`INPut<n1>:SDELay` on page 902

Logic Voltage

Used for setting the analyzer logic voltage. Changing the voltage level causes the probe to be reloaded.



"0.9 volt" 0.9 volt CMOS logic voltage

"1.2 volt" 1.2 volt CMOS logic voltage

"1.8 volt" 1.8 volt CMOS logic voltage

"2.5 volt" 2.5 volt CMOS logic voltage

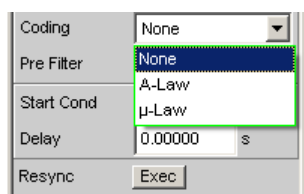
"3.3 volt" 3.3 volt LVTTTL I/O voltage

Remote command:

[INPut<n1>:LOGVoltage](#) on page 900

Coding

Input data decoding regulation. A-law and μ -law quantification characteristics are available for telephony applications.



"None" Input data is analyzed linearly PCM-coded.

"A-Law" Input data is analyzed according to A-law.

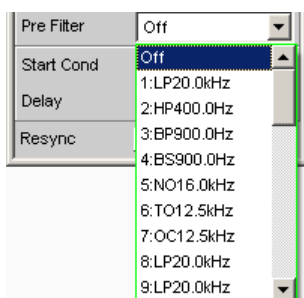
" μ -Law" Input data is analyzed according to μ -law.

Remote command:

[INPut<n1>:CODing](#) on page 899

Pre Filter

The selected prefilter affects all measurement functions. This permits desired prefiltering without selecting appropriate filters for the individual measuring functions.



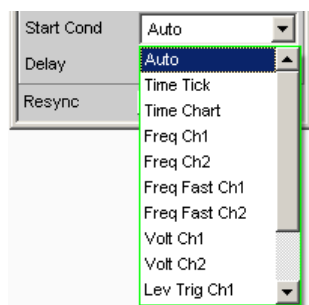
Remote command:

[INPut<n1>:FILTer](#) on page 958

For a description of the filters and their setting parameters, see [chapter 5.43.4, "Filter Table"](#), on page 628.

Start Cond

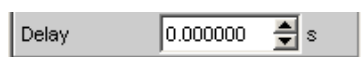
Specifies the event which triggers a measurement.



After the Start Cond has been selected the measurement either begins immediately (Auto) or only when the desired trigger condition is fulfilled; for details see [chapter 5.20, "Start Conditions"](#), on page 444.

Delay

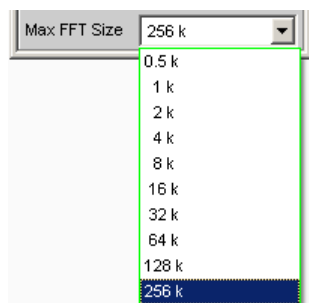
Delay for Start Cond.



A delay time can be entered under the Auto Start Cond menu item; for details see the section [chapter 5.20, "Start Conditions"](#), on page 444.

Max FFT Size

Used to limit automatic zoom fitting for the FFT size for all FFT-supported measurement functions (e.g. THD, THD+N, DFD, each with Post FFT) to the selected value with the goal of increasing measurement speed.

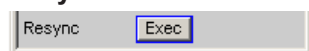


The limit to the FFT size is particularly useful for external sweeps for adapting the measuring time to the time frame of an external time tick. A limit is usually associated with degradation in measuring accuracy since incidents such as carrier-level noise can no longer be completely recorded.

Remote command:

[SENSe<n1>:MAX:FFT:SIZE](#) on page 894

Resync

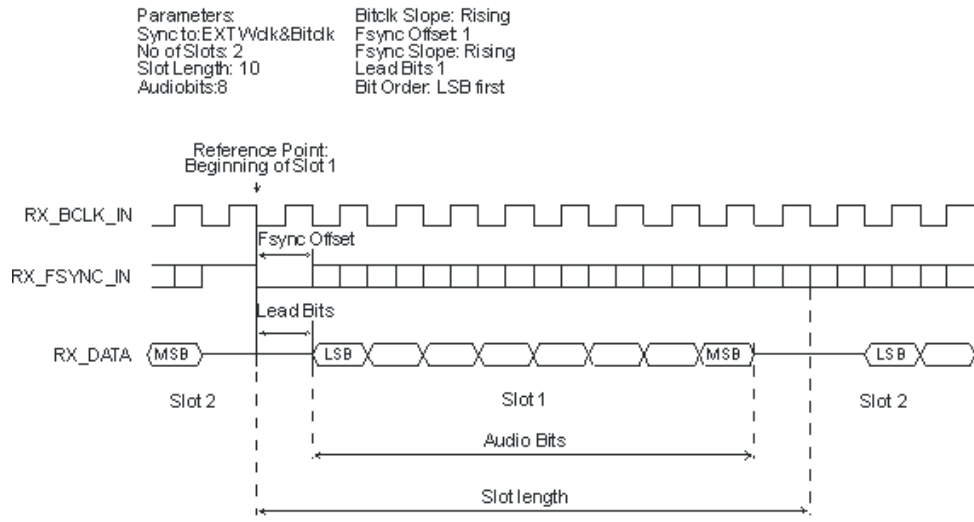


This button causes a complete re-synchronization of the analyzer. If the analyzer is synchronized by external signals while in slave mode, the resync mechanism should be performed once after the external clock has been applied and attuned.

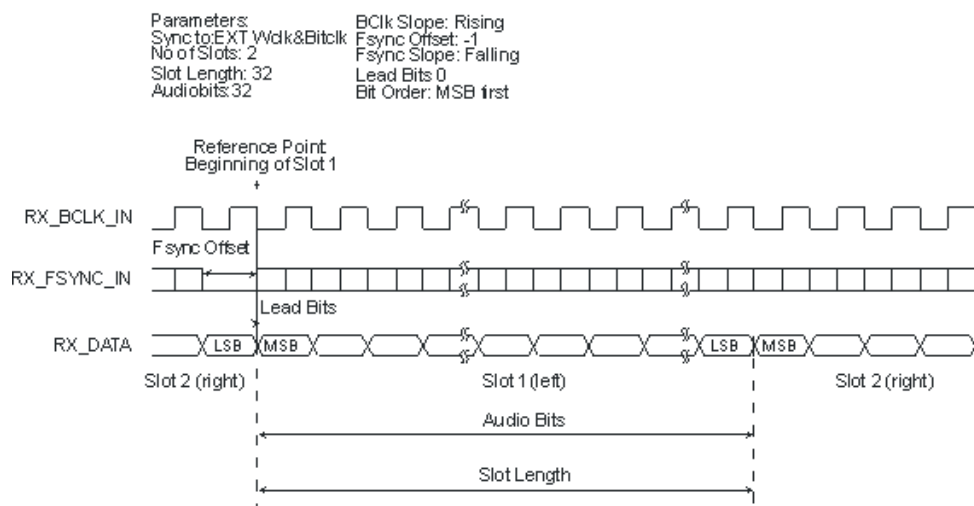
Remote command:

`INPut<n1>:RESync` on page 901

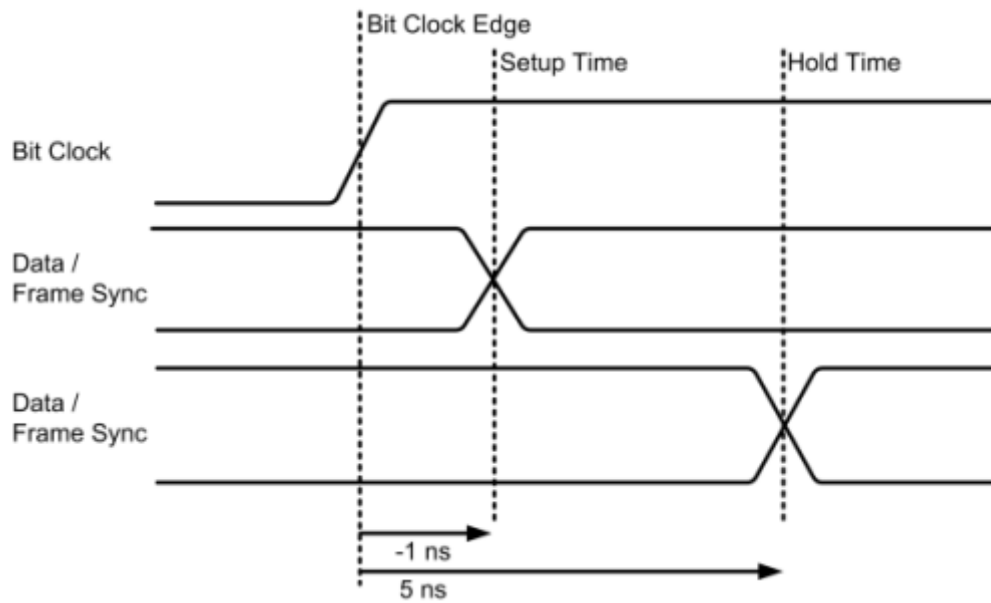
5.16.2 Timing Diagrams



I²S Format



Set-up and hold times



5.16.3 Interface Assignment

Pin	Signal	(I)input (O)utput	Signal description	Pin	Signal	(I)input (O)utput	Signal description
1	RX_MCLK_OUT	A	Master clock output analyzer	14	GND		Ground terminal
2	GND		Ground terminal	15	RX_DATA 2	E	Serial data 2 analyzer
3	RX_MCLK_IN	E	Master clock input analyzer	16	GND		Ground terminal
4	GND		Ground terminal	17	RX_DATA 3	E	Serial data 3 analyzer
5	RX_BCLK_OUT	A	Serial clock output analyzer	18	GND		Ground terminal
6	GND		Ground terminal	19	RX_DATA 4	E	Serial data 4 analyzer
7	RX_BCLK_IN	E	Serial clock input analyzer	20	GND		Ground terminal
8	GND		Ground terminal	21	RX_RESE RVED1		Reserved for future expansion

Pin	Signal	(I)input (O)utput	Signal descrip- tion	Pin	Signal	(I)input (O)utput	Signal descrip- tion
9	RX_FSYN C_OUT	A	Frame Sync out- put ana- lyzer	22	RX_RESE RVED2		Reserved for future expansion
10	GND		Ground terminal	23	RX_RESE RVED3		Reserved for future expansion
11	RX_FSYN C_IN	E	Frame Sync input analyzer	24	RX_RESE RVED4		Reserved for future expansion
12	GND		Ground terminal	25	RX_RESE RVED5		Reserved for future expansion
13	RX_DATA 1	E	Serial data 1 analyzer	26	RX_RESE RVED6		Reserved for future expansion

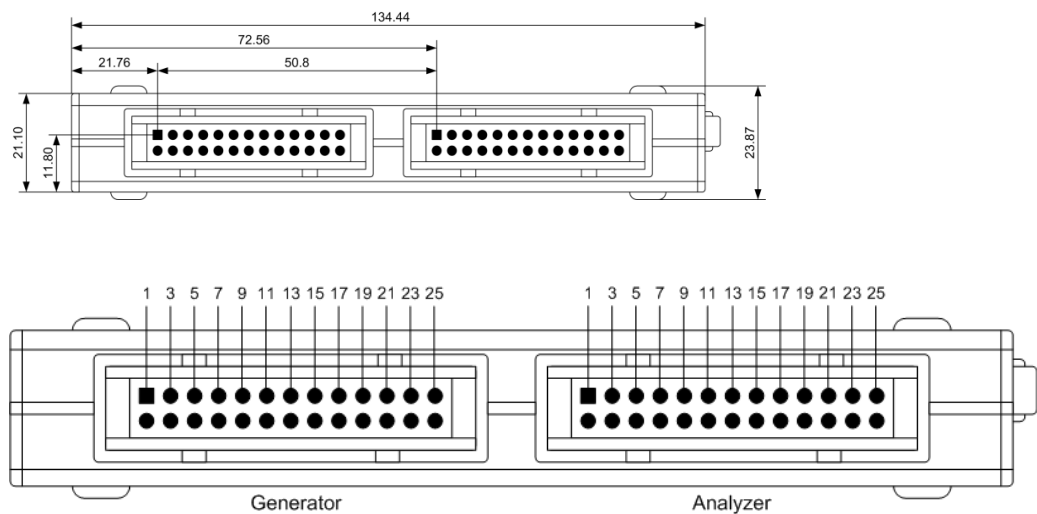
Table 5-3: CLK IN (BNC connector)

Connection	Signal	Input (I) Output (O)	Signal description
	CLK_IN	E	Reserved for future expansion

Table 5-4: CLK OUT (BNC connector)

Connection	Signal	Input (I) Output (O)	Signal description
	CLK_OUT	A	Reserved for future expansion

Probe Generator/Analyzer Layout:

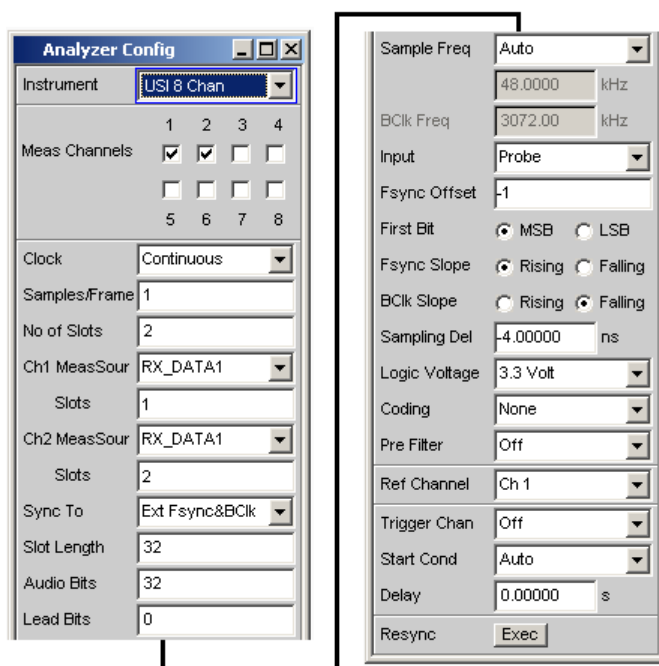


Recommended PCB plug connector:

TYCO AMP LATCH 2-827745-6

5.17 Configuring the USI 8 Channel Analyzer

5.17.1 USI 8 Channel Analyzer Configuration Panel



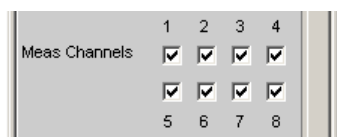
The USI 8 Channel Analyzer is only available with the R&S UPV-B42 (universal serial interface) option and consists of a plug-in card, a cable and a probe for contacting a device under test. For the pin assignment of the probe, see [chapter 5.16.3, "Interface Assignment"](#), on page 413.

The configuration options for the USI 8 channel analyzer are described below.

During the boot process of the R&S UPV with the "USI 8 Chan" instrument, a check is performed whether the probe is connected and ready for operation, otherwise a warning is issued. If the probe is connected **after** the R&S UPV is switched on, only the "USI 8 Chan" instrument must be confirmed to initialize the probe. A green LED on the probe shows the operational readiness. This mechanism permits the probe to be detached and reattached and put back into operation during operation. Detaching and reattaching during operation does not damage the probe!

Meas Channels

Used to set the active measurement channel.



"1,2,3,4,5,6,7,8 Measurement channel <n> is switched on or off.

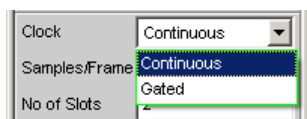
"

Remote command:

[INPut<n1>:MCHannels<n2>](#) on page 893

Clock

Used to select the continuous clock or gated clock operating modes.



"Continuous" The continuous clock operating mode requires a continuous clock for the generator. The clock source may be internal or external. If synchronization is external, several types of synchronization are available for selection.

"Gated" The gated clock operating mode must be selected if the externally supplied bit clock (BClk) and FrameSync (Fsync) are discontinuous or have such a large jitter that the internal PLL can no longer follow this clock.
In this operating mode, synchronization is limited to the external word clock and bit clock (Ext Fsync&BClk) option. Audio monitoring of the generated audio signal is not possible.

Remote command:

[INPut<n1>:CLOCK](#) on page 899

Samples/Frame

Used to define the number of samples per frame. The parameter simultaneously determines the minimum settable sampling rate according to the relationship: $fs_{min} = 843.75 \text{ Hz} * \text{samples/frame}$.

Value range: 1 ... 32



Remote command:

[INPut<n1>:SPFFrame](#) on page 902

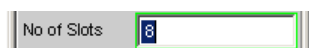
No of Slots

Used to define the number of slots in a frame.

Value range: 1 ... 256

$\text{No_of_Slots} * \text{Slot_Length} \leq 2048$

$\text{Slot_Length} * \text{No_of_Slots} * \text{Sample_Freq} \leq 55.926 \text{ MHz}$

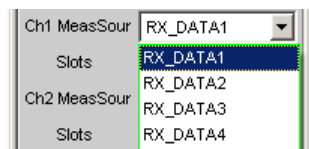


Remote command:

[INPut<n1>:NOSlots](#) on page 901

Ch<n> MeasSour

Used to select the input data line for the measuring channel <n>.



"RX_DATA1" The RX_DATA1 data line is selected for measurement channel <n>.

"RX_DATA2" The RX_DATA2 data line is selected for measurement channel <n>.

"RX_DATA3" The RX_DATA3 data line is selected for measurement channel <n>.

"RX_DATA4" The RX_DATA4 data line is selected for measurement channel <n>.

Remote command:

[INPut<n1>:MCHSource<n2>](#) on page 901

Slots

Used to select the audio frame channel for measurement channel <n>.

(More than one channel can only be selected with multi-sample formats! In this case a frame contains several consecutive samples from one signal source)

Value range: 1 to No of Slots



Remote command:

[INPut<n1>:SLOTs<n2>](#) on page 902

Sync To

Used to select the clock source with which the USI analyzer is synchronized.

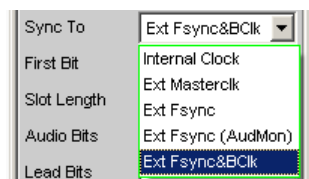


Table 5-5: Overview of the various synchronization modes:

	Internal clock	External master clock	External frame sync	External frame sync with audio monitor	External frame sync, bit clock	External frame sync, bit clock (gated)
Master clock Output	o	tri	o	tri	tri	tri
Master clock Input	--	x	--	--	--	--
Bit clock Output	o	o	o	o	tri	tri
Bit clock Input	--	--	--	--	x	x
Frame sync Output	o	o	o	o	tri	tri
Frame sync Input	--	--	x	x	x	x
x = Input Signal must be present o = Output Signal is available tri = Output in tristate mode (high impedance) -- = Unused Input						

"Internal Clock" The analyzer uses the instrument's internal clock.

"Ext Masterclk" Synchronizes to the externally supplied master clock signal (TX_MCLK_IN).

"Ext Fsync" Synchronizes to an external FrameSync signal (TX_FSYNC_IN). The analyzer signal cannot be audio monitored. A master clock is additionally supplied.

"Ext Fsync (AudMon)" Synchronizes to an external FrameSync signal (TX_FSYNC_IN). The analyzer signal can be audio monitored. No master clock signal is supplied.

"Ext Fsync&BClk" Synchronizes to the external FrameSync (TX_FSYNC_IN) and bit clock (TX_BCLK_IN) signals.

Remote command:

[INPut<n1>:SYNCto](#) on page 902

First Bit

Used to define the sequence in which the data bits are received.



"MSB" The most significant data bit is received first.

"LSB" The least significant data bit is received first.

Remote command:

[INPut<n1>:FBIT](#) on page 899

Slot Length

Word width of a slot including gaps (0 bits).

Value range: 1 ... 256

$\text{No_of_Slots} * \text{Slot_Length} \leq 2048$

$\text{Slot_Length} * \text{No_of_Slots} * \text{Sample_Freq} \leq 55.926 \text{ MHz}$

Remote command:

[INPut<n1>:SLTLength](#) on page 902

Audio Bits

Word width of the audio data within a slot.

Only the specified number of data bits are analyzed.

Value range: 8 to slot length (max 32)

Remote command:

[INPut<n1>:AUDIobits](#) on page 895

Lead Bits

Defines the offset for the audio bits within a slot relative to the start of the slot.

If LSB is selected as the first bit, the setting for lead bits is automatically corrected if the setting for audio bits is changed so that the MSB is received at the same location. This has the advantage that the resolution of the signal transmitted is changed but not the amplitude if the audio bits are changed.

Example:

Slot length: 32

Audio bits: 24 → 23 (setting changed by user)

Lead bits: 8 → 9 (automatic correction)

Value range: 0 to audio bits slot length

Remote command:

[OUTPut:LBITs](#) on page 865

Timeout

Only available in Gated Clock mode. This parameter defines the maximum time span for which external clocks are allowed to discontinue before the measurement is declared as invalid.

Value range: 1 ms to 500 ms

Remote command:

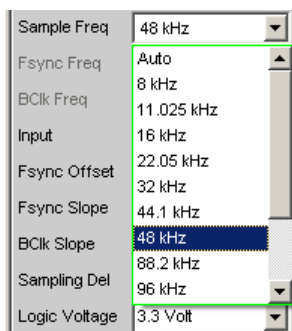
[INPut<n1>:TImeout](#) on page 902

Sample Freq

Setting the sampling frequency.

All received audio data frequency specifications relate to this setting. The analyzer displays incorrect frequency values if the USI analyzer is operated with external synchronization and the frequency of the external clock signal does not correspond to the set sampling frequency.

For data formats with one sample per frame, the sampling frequency corresponds to the frequency of the Fsync signal. In case of several audio data samples from one source within one frame, the frequency of the Fsync signal is the product of the sampling frequency divided by the factor of samples/frame.



Value range for numeric input: 0.84375 kHz to 400 kHz

$No_of_Slots * Slot_Length \leq 2048$

$Slot_Length * No_of_Slots * Sample_Freq \leq 55.926 \text{ MHz}$

Standard sampling frequencies can be set directly in the selection field.

"Auto" The sampling rate is measured, set and displayed in the following line. If the applied sampling rate is changed the set value is automatically updated.

Note: The digital analyzer must re-initialized for each new sampling frequency. To avoid the need to repeat this time-consuming procedure too often, minor deviations and fluctuations (below 3 Hz) are ignored.

"8 kHz"	Standard sampling rate 8 kHz
"11.025 kHz"	Standard sampling rate 11.025 kHz
"16 kHz"	Standard sampling rate 16 kHz
"22.05 kHz"	Standard sampling rate 22.05 kHz
"32 kHz"	Standard sampling rate 32 kHz
"44.1 kHz"	Standard sampling rate 44.1 kHz
"48 kHz"	Standard sampling rate 48 kHz
"88.2 kHz"	Standard sampling rate 88,2 kHz
"96 kHz"	Standard sampling rate 96 kHz
"176.4 kHz"	Standard sampling rate 176.4 kHz
"192 kHz"	Standard sampling rate 192 kHz
"384 kHz"	Standard sampling rate 384 kHz

"Value " Variable input of sampling rate

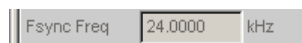


Remote command:

[INPut<n1>:SAMPlE:FREQuency:MODE](#) on page 896

Fsync Freq

Is only displayed for multi-sample formats. The Frame Sync frequency corresponds to the sampling rate divided by the samples/frame factor.



Remote command:

[INPut<n1>:FSYNc:FREQuency?](#) on page 900

BCK Freq

Displays the bit clock frequency. Is the product of slot length * no of slots * sample freq / samples/frame.

Value range: 6.75 kHz to 55.296 MHz

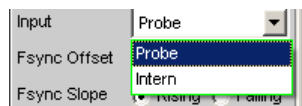


Remote command:

[INPut<n1>:BCLK:FREQuency?](#) on page 897

Input

Selection of the analyzer source. In internal mode, the probe is run in short circuit operation with the generator. For this the generator must be operated in internal clock synchronization mode and the analyzer in ExtFsync&BCK mode. The signals produced by the generator can thus be analyzed without using an external plug connection. If the probe is selected as a source, the analyzer analyzes the signals at the connector.



Remote command:

[INPut<n1>:INPut](#) on page 897

Fsync Width

Fsync pulse width



"1 bit" The FSYNC pulse has the length of a data bit (1 SCK period)

"1 Slot" FSYNC is one audio slot in length (= slot length)

"Square" FSYNC pulse has the shape of a symmetrical rectangle. If the number of the bit clock (BClk) cycles is odd the high phase is one cycle longer than the low phase (if Fsync slope = rising)

"Value " The FSYNC length corresponds to the numeric value in data bits (1 BClk period)
Value range: 1 to (Slot Length*No of Slots) -1

Remote command:

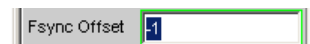
[INPut<n1>:FWIDth](#) on page 900

[INPut<n1>:FWIDth:VALue](#) on page 900

Fsync Offset

Used to define the offset of the Fsync pulse relative to the reference point (the start of the first slot)

Value range: -Slot Length to + Slot Length-1



Remote command:

[INPut<n1>:FOFFset](#) on page 900

Fsync Slope

FSYNC pulse polarity



"Rising" The FSYNC pulse begins with a positive edge.

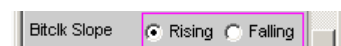
"Falling" The FSYNC pulse begins with a negative edge.

Remote command:

[INPut<n1>:FSLope](#) on page 897

BClk Slope

Bit clock polarity (BClk)



"Rising" RX_FSYNC_IN, RX_DATA1, RX_DATA2, RX_DATA3 and RX_DATA4 are sampled and the RX_FSYNC_OUT signal is output with a rising bit clock edge (the bit clock signal to which this setting refers is either RX_BClk_IN if the analyzer is operated as a slave, or RX_BClk_OUT if the analyzer is clocked internally).

"Falling" RX_FSYNC_IN, RX_DATA1, RX_DATA2, RX_DATA3 and RX_DATA4 are sampled and the RX_FSYNC_OUT is output with a falling bit clock edge (the bit clock signal to which this setting refers is either RX_BClk_IN if the analyzer is operated as a slave, or RX_BClk_OUT if the analyzer is clocked internally).

Remote command:

[INPut<n1>:BSLope](#) on page 899

MClk Ratio

Relationship between the master clock (MCLK) and FrameSync (FSYNC).

Value range: 16 ... 768 (max. 110,592 MHz)



Remote command:

[INPut<n1>:MRATio](#) on page 901

Sampling Del

This parameter permits the sampling time for RX_FSYNC_IN, RX_DATA1, RX_DATA2, RX_ATA3 and RX_DATA4 input signals to be delayed relative to the RX_BClk_IN or RX_BClk_OUT clock. Positive values move the sampling towards a later time.

This feature is used above all if TCO delays, in other words response times of a device under test being operated in slave mode at high frequencies, reach the size of a bit clock period. In order to compensate for bit shifts when analyzing in the analyzer these delay times are compensated by a later sampling point.

Value range: -10 ... +10 ns

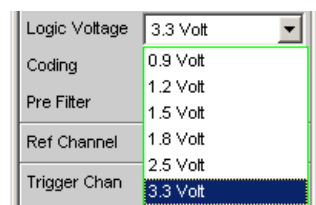


Remote command:

[INPut<n1>:SDELay](#) on page 902

Logic Voltage

Used for setting the analyzer logic voltage. Changing the voltage level causes the probe to be reloaded.



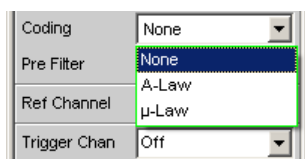
"0.9 Volt"	0.9 volt CMOS logic voltage
"1.2 Volt"	1.2 volt CMOS logic voltage
"1.5 Volt"	1.5 Volt CMOS logic voltage
"1.8 Volt"	1.8 volt CMOS logic voltage
"2.5 Volt"	2.5 volt CMOS logic voltage
"3.3 Volt"	3.3 volt LVTTTL I/O voltage

Remote command:

[INPut<n1>:LOGVoltage](#) on page 900

Coding

Input data decoding regulation. A-law and μ -law quantification characteristics are available for telephony applications.



"None" Input data is analyzed linearly PCM-coded.

"A-Law" Input data is analyzed according to A-law.

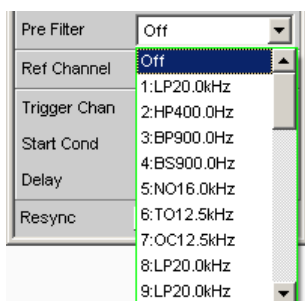
" μ -Law" Input data is analyzed according to μ Law.

Remote command:

[INPut<n1>:CODing](#) on page 899

Pre Filter

The selected prefilter affects all measurement functions. This permits desired prefiltering without selecting appropriate filters for the individual measuring functions.



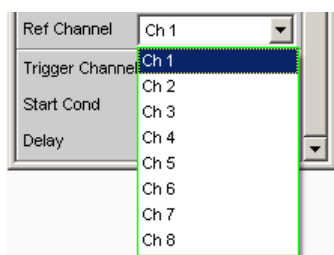
Remote command:

[INPut<n1>:FILTer](#) on page 958

For a description of the filters and their setting parameters, see [chapter 5.43.4, "Filter Table"](#), on page 628.

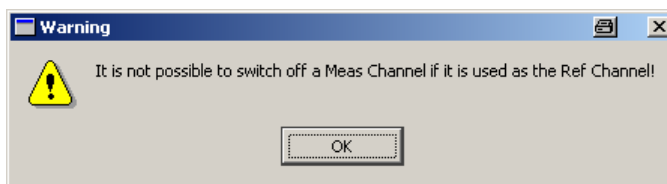
Ref Channel

Reference channel for phase measurements or other channel-related measurements.



Each measuring channel can be selected as a reference channel. If a channel which is selected as a reference channel is not yet active (switched off), the channel is automatically switched on.

Switching off a measuring channel that was selected as the reference channel is prevented, and the user is advised of this by the following warning:



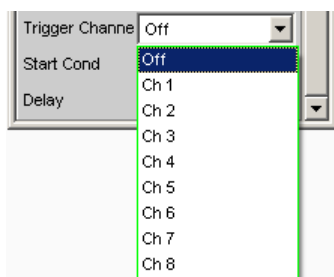
"Ch <n>" Channel <n> is selected as a reference channel

Remote command:

[SENSe<n1>:REFerence<n2>:CHANnel](#) on page 894

Trigger Chan

Used to select the channel whose event triggers a measurement.



If a measuring channel which was inactive is selected as a trigger channel it is automatically switched on.

A warning appears if the channel selected as a trigger channel is switched off.

The trigger channel can be switched off; however, this causes the reference channel to automatically become the trigger channel.

"Off" Triggering is not active.

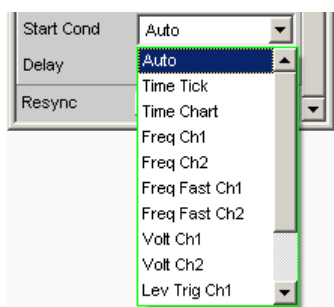
"Ch <n>" Triggering is active. Channel <n> is selected as trigger channel.

Remote command:

[TRIGger:CHANnel](#) on page 909

Start Cond

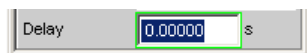
Specifies the event which triggers a measurement.



After the Start Cond has been selected the measurement either begins immediately (Auto) or only when the desired trigger condition is fulfilled; for details see [chapter 5.20, "Start Conditions"](#), on page 444.

Delay

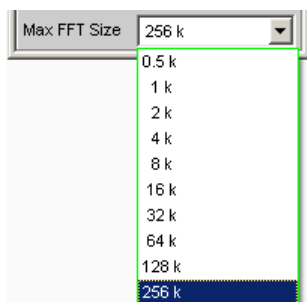
Delay for Start Cond.



A delay time can be entered under the Auto Start Cond menu item; for details see the section [chapter 5.20, "Start Conditions"](#), on page 444.

Max FFT Size

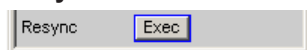
Used to limit automatic zoom fitting for the FFT size for all FFT-supported measurement functions (e.g. THD, THD+N, DFD, each with Post FFT) to the selected value with the goal of increasing measurement speed.



The limit to the FFT size is particularly useful for external sweeps for adapting the measuring time to the time frame of an external time tick. A limit is usually associated with degradation in measuring accuracy since incidents such as carrier-level noise can no longer be completely recorded.

Remote command:

[SENSe<n1>:MAX:FFT:SIZE](#) on page 894

Resync

This button causes a complete re-synchronization of the analyzer. If the analyzer is synchronized by external signals while in slave mode, the resync mechanism should be performed once after the external clock has been applied and attuned.

Remote command:

[INPut<n1>:RESync](#) on page 901

5.17.2 Timing Diagrams

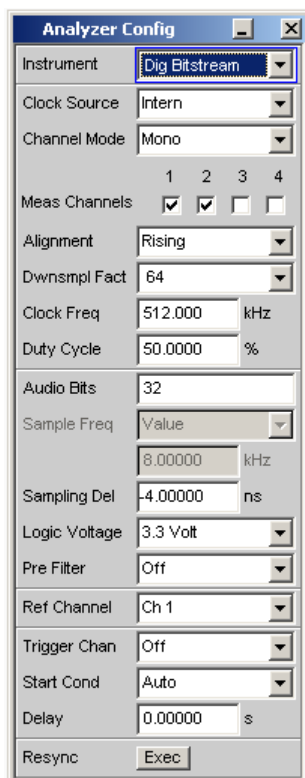
Identical to the Dual Channel Analyzer [chapter 5.16.2, "Timing Diagrams"](#), on page 412

5.17.3 Interface Assignment

Identical to the Dual Channel Analyzer [chapter 5.16.3, "Interface Assignment"](#), on page 413

5.18 Configuring the Dig Bitstream Analyzer

5.18.1 Dig Bitstream Analyzer Configuration Panel



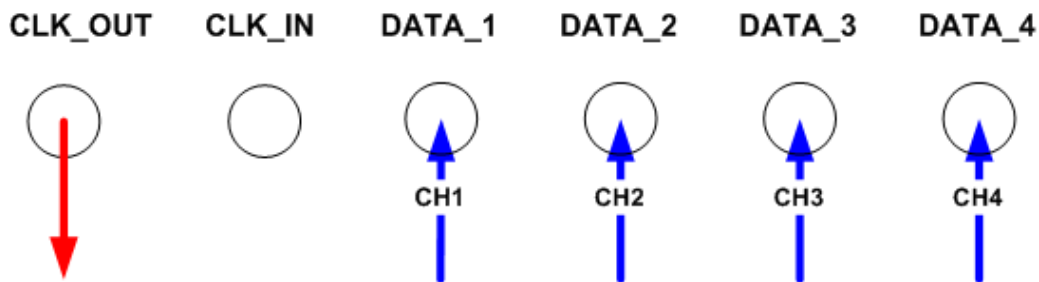
This instrument is available only with the hardware option R&S UPV-B42 (universal serial interface) and the additional software option R&S UPV-K421 (PDM Bitstream Analyzer).

The configuration options for the Digital Bitstream Analyzer are described below.

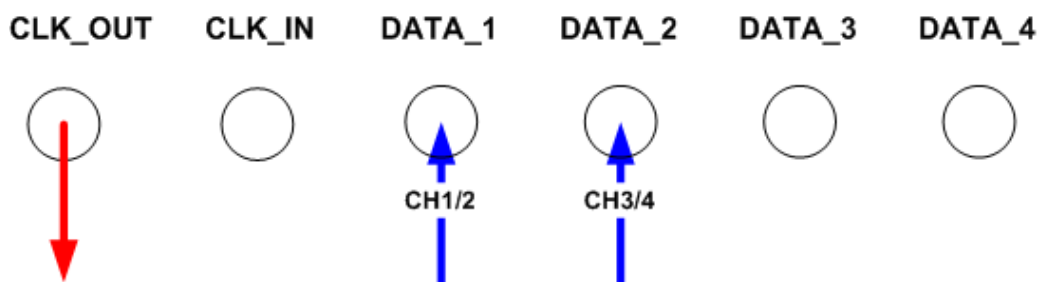
During the boot process of the R&S UPV with the "Dig Bitstream" instrument, a check is performed whether the probe is connected and ready for operation, otherwise a warning is issued. If the probe is connected **after** the R&S UPV is switched on, only the "Digital Bitstream" instrument must be confirmed to initialize the probe. A green LED on the probe shows the operational readiness. This mechanism permits the probe to be detached and reattached and put back into operation during operation. Detaching and reattaching during operation does not damage the probe!

The Digital Bitstream Analyzer is capable of analyzing 4 data lines with sigma/delta-modulated signals. If the analyzer is used as clock master, either one mono signal each can be measured on the data lines 1, 2, 3 and 4 or one stereo signal each on the lines 1 and 2.

Clock master: Mono

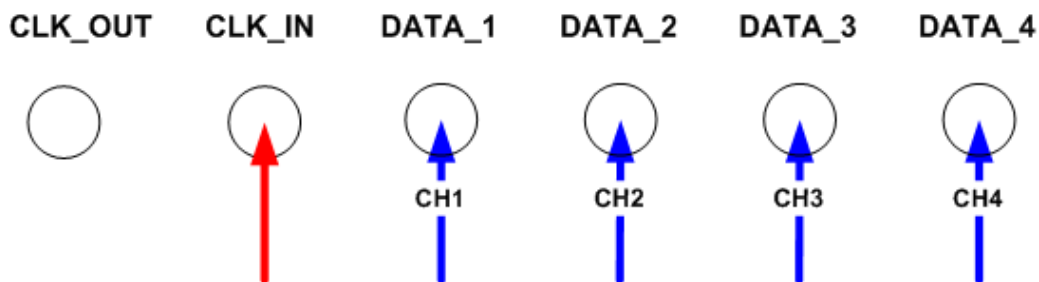


Clock master: Stereo



As clock slave, the selection is limited to one mono signal per data line.

Clock slave: Mono



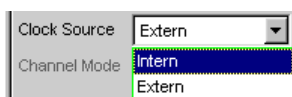
A detailed overview concerning the adjustable formats and modes is featured at the end of the chapter.

Clock Source

Used for selecting the clock source for the bit stream signal. The Digital Bitstream Analyzer can be configured as clock master (Clock Source = Intern) or as pure slave (Clock Source = Extern).

As clock master, the analyzer generates a clock that is configurable in frequency and duty cycle, which is used by a slave device for generating the sigma/delta bit stream.

If the DUT features its own clock supply, the bit stream analyzer can be configured as slave. In this case, the data and the clock are generated by the device under test.



"Intern" Configuration as clock master.

"Extern" Configuration as clock slave.

Remote command:

[INPut<n1>:CLKSource](#) on page 904

Channel Mode

Selects the input format of the data lines. If the Digital Bitstream Analyzer is operated as clock slave (Clock Source = Extern), the selection is limited to one mono signal.



"Mono" The data of a line are interpreted as mono signal. The sampling is done with rising or falling clock edge, adjustable in the "Alignment" parameter field underneath it.

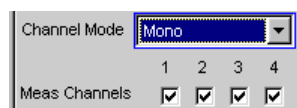
"Stereo" The data of a line are interpreted as stereo signal. The sampling is done with various combinations of rising and falling clock edge, adjustable in the "Alignment" parameter field underneath it.

Remote command:

[INPut<n1>:CHMode](#) on page 903

Meas Channels

Selection of the channels to be analyzed. The Bitstream Analyzer can analyze up to 4 channels simultaneously.



"1,2,3,4" The corresponding measurement channel is switched on or off.

Remote command:

[INPut<n1>:MChannels<n2>](#) on page 893

Alignment

This parameter describes the relationship of clock and data to each other. Depending on whether a mono or stereo format is to be analyzed, different modes can be selected. A graphical display is located at the end of the chapter.

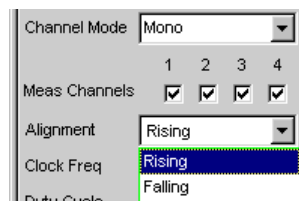


Fig. 5-21: Alignment options for Channel Mode = Mono

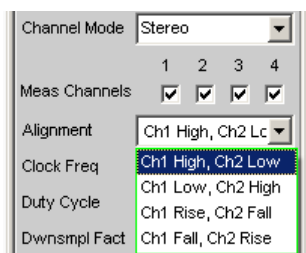


Fig. 5-22: Alignment options for Channel Mode = Stereo

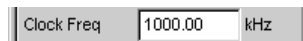
- "Rising" In Channel Mode = Mono, the sampling of the data is done with rising clock edge.
- "Falling" In Channel Mode = Mono, the sampling of the data is done with falling clock edge.
- "Ch1 High, Ch2 Low" In Channel Mode = Stereo, the sampling of the data is done with rising and falling clock edge offset by 90°. Channel 1 lies under the High portion of the clock period, whereas channel 2 lies under the Low portion.
- "Ch1 Low, Ch2 High" In Channel Mode = Stereo, the sampling of the data is done with rising and falling clock edge offset by 90°. Channel 2 lies under the High portion of the clock period, whereas channel 1 lies under the Low portion.
- "Ch1 Rise, Ch2 Fall" In Channel Mode = Stereo, the sampling of the data is done with rising and falling clock edge. Channel 1 is taken with rising edge, channel 2 with falling edge.
- "Ch1 Fall, Ch2 Rise" In Channel Mode = Stereo, the sampling of the data is done with rising and falling clock edge. Channel 2 is taken with rising edge, channel 1 with falling edge.

Remote command:
[INPut<n1>:ALIGnment](#) on page 903

Clock Freq

If the Bitstream Analyzer is configured as clock master (Clock Source = Intern), this parameter defines the frequency of the output clock.

Value range: 512 ... 12800 kHz



Remote command:
[INPut<n1>:CLKFrequency](#) on page 903

Duty Cycle

If the Bitstream Analyzer is configured as clock master (Clock Source = Intern), this parameter defines the duty cycle of the output clock.

Value range: 40 ... 60 %

Duty Cycle	50.0000	%
------------	---------	---

Remote command:

[INPut<n1>:DTYCycle](#) on page 904

Dwnsmpl Fact

Defines the down-sampling factor. A filter bank is configured with the different factors depending on the defined value. The sampling rate of the measurement signal after filtering and decimation is calculated as follows:

$$F_{s_down} = F_{Clk} / Dwnsmpl_Fact$$

For example, if a timing frequency of 3072 kHz is present, then the sigma/delta-modulated data are down-sampled by the factor 64 to a sampling rate of 48 kHz.

Dwnsmpl Fact	64
	16
	32
	64
	128
	256

"16/32/64/128/ 256" Decimation factor

Remote command:

[INPut<n1>:DWNFactor](#) on page 904

Audio Bits

Word length of audio data.

Only the specified number of data bits are analyzed.

Value range: 8 ... 32

Audio Bits	32
------------	----

Remote command:

[INPut<n1>:AUDIobits](#) on page 895

Sample Freq

Display of measured sampling rate. Calculated according to:

$$F_{s_down} = F_{Clk} / Dwnsmpl_Fact$$

Sample Freq	Auto
	12.0000 kHz

Remote command:

[INPut<n1>:SAMPlE:FREQuency](#) on page 896

Query only

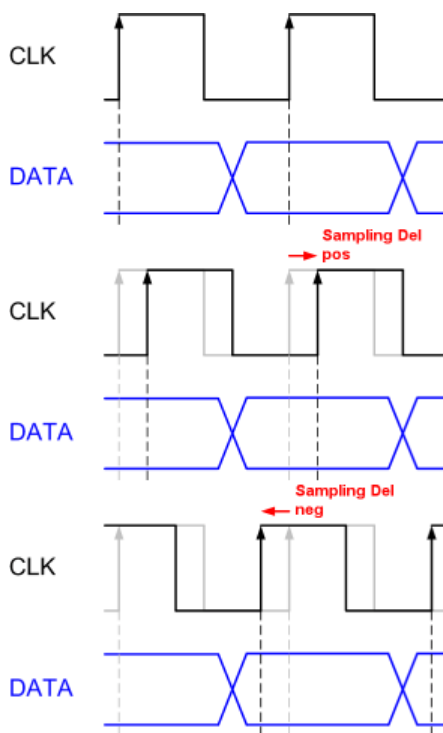
Sampling Del

To compensate for delays on part of the device under test with respect to the position of clock to data, the Bitstream Analyzer features adjustable delays.

A positive value leads to a delay of the sampling time compared to the selected alignment. The TCO (Time Clock to Output) of a device under test can be compensated in this way. The lagging data are sampled later.

A negative value leads to an advance of the sampling time compared to the selected alignment. A delay of the clock compared to the data can be compensated in this way. The leading data are sampled earlier.

Value range: -9.324 ... +9.324 ns



Remote command:

`INPut<n1>:SDELay` on page 902

Logic Voltage

Used for setting the analyzer logic voltage. Adjusting or changing the voltage level causes the probe to be reloaded.

Logic Voltage	3.3 Volt
Pre Filter	0.9 Volt
Ref Channel	1.2 Volt
Trigger Chan	1.5 Volt
Start Cond	1.8 Volt
	2.5 Volt
	3.3 Volt

- "0.9 Volt" 0.9 volt CMOS logic voltage
- "1.2 Volt" 1.2 volt CMOS logic voltage
- "1.5 Volt" 1.5 Volt CMOS logic voltage
- "1.8 Volt" 1.8 volt CMOS logic voltage
- "2.5 Volt" 2.5 volt CMOS logic voltage

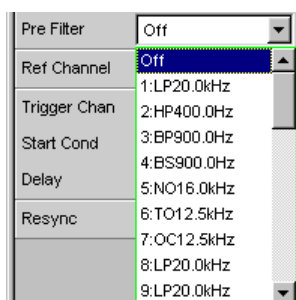
"3.3 Volt" 3.3 volt LVTTTL I/O voltage

Remote command:

[INPut<n1>:LOGVoltage](#) on page 900

Pre Filter

The selected prefilter affects all measurement functions. This permits a desired **pre**filtering without selecting appropriate filters for the individual measuring functions.



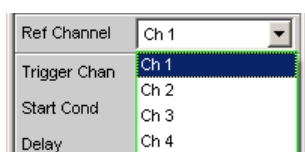
Remote command:

[INPut<n1>:FILTer](#) on page 958

For a description of the filters and their setting parameters, see [chapter 5.43.4, "Filter Table"](#), on page 628.

Ref Channel

Reference channel for phase measurements or other channel-related measurements.



Each measuring channel can be selected as a reference channel. If a channel which is selected as a reference channel is not yet active (switched off) the channel is automatically switched on.

Switching off a channel that was selected as the reference channel is prevented, and the user is advised of this by the warning "It is not possible to switch off a Meas Channel if it is in use as the Ref Channel"!

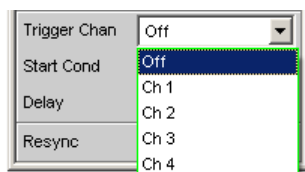
"Ch 1 ... 4" Reference channel

Remote command:

[SENSe<n1>:REFerence<n2>:CHANnel](#) on page 894

Trigger Chan

Used to select the channel whose event triggers a measurement.



If a measuring channel which was inactive is selected as a trigger channel it is automatically switched on.

A warning appears if the channel selected as a trigger channel is switched off.

The trigger channel can be switched off; however, this causes the reference channel to automatically become the trigger channel.

"Off" Triggering is not active.

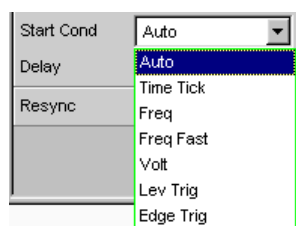
"Ch 1 ... 4" Triggering with the selected channel is active.

Remote command:

[TRIGger:CHANnel](#) on page 909

Start Cond

Specifies the event which triggers a measurement.



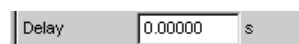
After the Start Cond has been selected the measurement either begins immediately (Auto) or only when the desired trigger condition is fulfilled; for details see [chapter 5.21, "Setting Start Condition"](#), on page 445.

Remote command:

[TRIGger:SOURce](#) on page 910

Delay

Delay for Start Cond.



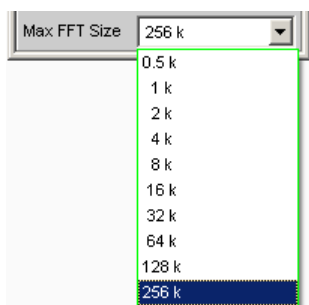
A delay time can be entered under the Auto Start Cond menu item; for details see the section [chapter 5.21, "Setting Start Condition"](#), on page 445.

Remote command:

[TRIGger:DELAy](#) on page 909

Max FFT Size

Used to limit automatic zoom fitting for the FFT size for all FFT-supported measurement functions (e.g. THD, THD+N, DFD, each with Post FFT) to the selected value with the goal of increasing measurement speed.

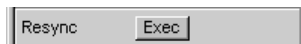


The limit to the FFT size is particularly useful for external sweeps for adapting the measuring time to the time frame of an external time tick. A limit is usually associated with degradation in measuring accuracy since incidents such as carrier-level noise can no longer be completely recorded.

Remote command:

[SENSe<n1>:MAX:FFT:SIZE](#) on page 894

Resync



This button causes a complete re-synchronization of the analyzer. If the analyzer is synchronized by external signals whilst in slave mode, the resync mechanism should be performed once after the external clock has been applied and attuned.

Remote command:

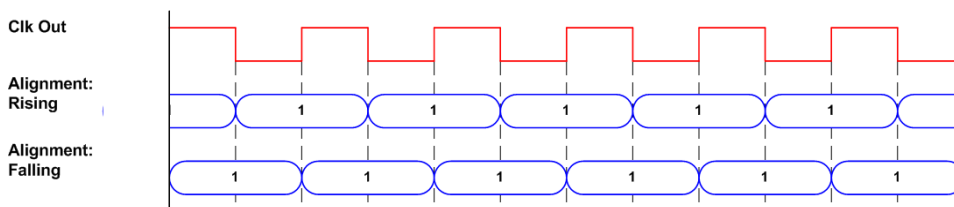
[INPut<n1>:RESync](#) on page 901

5.18.2 Timing Diagrams

Depending on whether the Bitstream Analyzer is configured as clock master (Clock Source = Intern) or slave (Clock Source = Extern) and depending on whether a mono or stereo signal should be analyzed on a line, the digital bit stream analysis supports the following input formats:

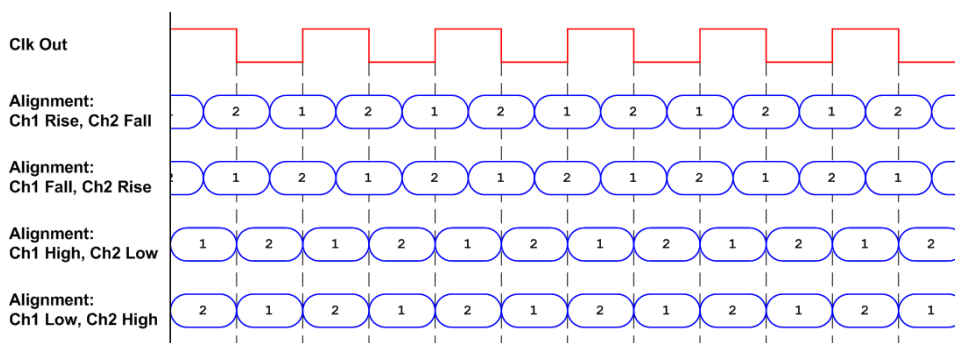
Clock Source: Internal

Channel Mode Mono



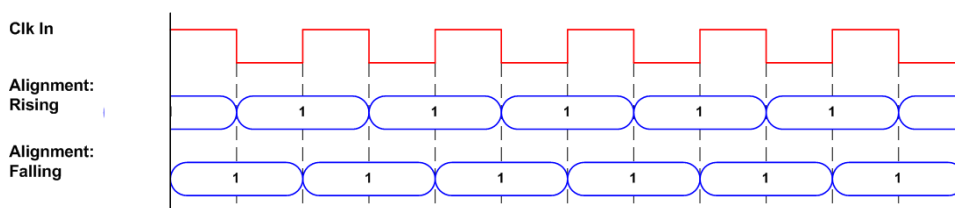
Clock Source: Internal

Channel Mode Stereo



Clock Source: Extern

Channel Mode Mono



5.18.3 Interface Assignment

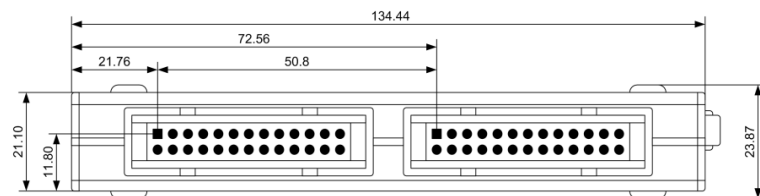
Pin	Signal	(I)input (O)output	Signal descrip- tion	Pin	Signal	(I)input (O)output	Signal descrip- tion
1	NOT_USED	A	Reserved for future expansion	14	GND		Ground terminal
2	GND		Ground terminal	15	RX_DATA 2	E	Data_2 (Mono) / Data_34 (Stereo)
3	NOT_USED	E	Reserved for future expansion	16	GND		Ground terminal
4	GND		Ground terminal	17	RX_DATA 3	E	Data_3 (Mono) / Not_used (Stereo)
5	CLK_OUT	A	Clock Out	18	GND		Ground terminal
6	GND		Ground terminal	19	RX_DATA 4	E	Data_4 (Mono) / Not_used (Stereo)
7	CLK_IN	E	Clock In	20	GND		Ground terminal

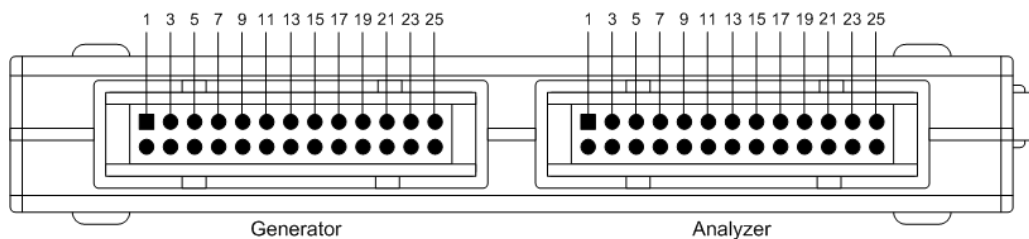
Pin	Signal	(I)input (O)utput	Signal descrip- tion	Pin	Signal	(I)input (O)utput	Signal descrip- tion
8	GND		Ground terminal	21	RX_RESE RVED1		Reserved for future expansion
9	NOT_USED	A	Reserved for future expansion	22	RX_RESE RVED2		Reserved for future expansion
10	GND		Ground terminal	23	RX_RESE RVED3		Reserved for future expansion
11	NOT_USED	E	Reserved for future expansion	24	RX_RESE RVED4		Reserved for future expansion
12	GND		Ground terminal	25	RX_RESE RVED5		Reserved for future expansion
13	RX_DATA1	E	Data_1 (Mono) / Data_12 (Stereo)	26	RX_RESE RVED6		Reserved for future expansion

Connection	Signal	Input (I) Output (O)	Signal description
CLK IN (BNC)	CLK_IN	E	Reserved for future expansion

Connection	Signal	Input (I) Output (O)	Signal description
CLK OUT (BNC)	CLK_OUT	A	Reserved for future expansion

Probe Generator/Analyzer Layout:





Recommended PCB plug connector:

TYCO AMP LATCH 2-827745-6

5.19 Starting Measurements

Measurements are started – and stopped – in manual operating mode using the following keys START, SINGLE and STOP/CONT in the CONTROL panel, via the keys CTRL+F5 (Start), CTRL+F6 (Single) or CTRL+F7 (Stop/Cont) of the external keyboard or via the buttons "Start", "Single" and "Stop/Cont" of the toolbar.

The effect of these keys or buttons depends on whether or not the sweep system is active:

- The measurement system can only be directly controlled using the keys if the sweep system is inactive.
- If, however, the sweep system is active, the measurement system is controlled by the sweep system and the keys or buttons are used to control the sweep system.

5.19.1 Overview of the Measurement System

The following information refers to a "deactivated sweep system", i.e. a sweep is not activated in either the generator or the analyzer.

A measurement, in a narrower sense, is the one-off or continuous "recording of measured values" for all activated measurement types. It can take the form of a single measured value or a data set (sample in the time domain, spectral lines in the frequency domain).

The one-off recording of measured values is referred to as a "single measurement" (see [chapter 5.19.3.2, "Single measurement"](#), on page 442), and continuous recording as "continuous measurement" (see [chapter 5.19.3.1, "Continuous measurement"](#), on page 440).

The measurement system is controlled

- explicitly via the keys and buttons described in the introduction
- implicitly by means of **termination events**. These are events (user entries) which invalidate the measurement currently being performed, i.e. changes in the generator, analyzer or filter bank. Following a termination event, the current measurement is restarted automatically. This ensures that the displayed measurement data is not corrupted by internal switching operations. Since it takes a few milliseconds to ter-

minate and restart a measurement in progress, settings should not be entered in remote-control mode unless measurement has stopped.

5.19.2 Activating and Deactivating Measurement Types

With the R&S UPV it is possible to record up to 64 different **measured values** simultaneously and display them numerically and/or graphically.

These measured values are

- selected measurement functions of all channels,
- level monitor (RMS or DC downstream of the prefilter) of all channels,
- input monitor (peak measurement upstream of the prefilter) of all channels,
- frequency on channel 1, frequency, phase or group delay on all channels.

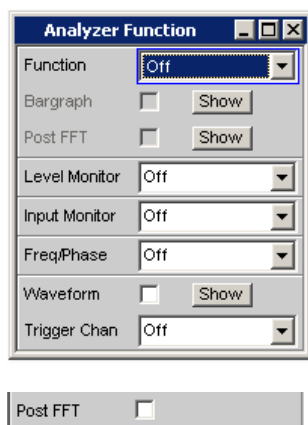
It is also possible to record a large number of **data sets** which can also be displayed numerically and/or graphically:

- Post FFT and/or bar graph for all channels with distortion measurements; frequency band analysis; FFT as measurement function,
- Waveform (display of the measurement signal in the time domain) of all channels.

Although the measurement types mentioned above are performed simultaneously and therefore affect each other only slightly with respect to time, it is only possible to display the results of these measurements in sequence.

It is therefore recommended to deactivate any measurement types that are not required in order to reduce the total measurement time:

- Unnecessary measurement times are avoided by deactivating unused channels.
- Deactivating individual measurement types (in the "Analyzer Function" panel) stops measurement results which are not required from being recorded and displayed.



All activated measurement types are measured in each (single) measurement. The measurement is not regarded as having been completed until all of the desired results (possibly also with settling) are available. Only then can the sweep be stepped or a triggered measurement result be retrieved by the remote control station. Consequently, the slowest measurement type determines the measurement speed of the entire instrument.

5.19.3 States of the Measurement System

The states of the measurement system are displayed above the softkeys, the channels appear above the 5th and 6th softkeys. The current state is also indicated by the two LEDs above the START and SINGLE key.

Two-channel analyzer



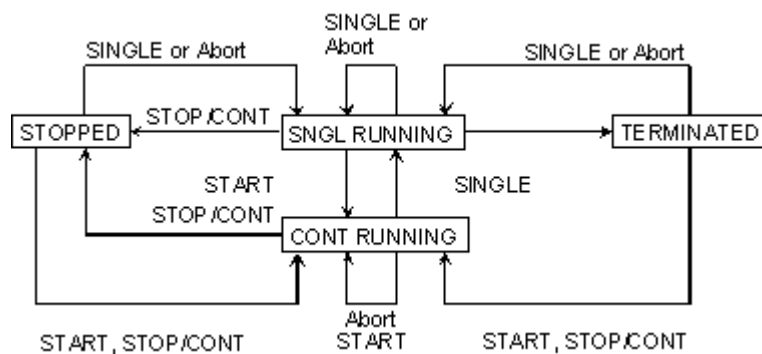
Multichannel analyzer



Table 5-6: The following states are possible:

Off	Channel is deactivated; measured values are not recorded on this channel.
Single	Single measurement in progress
Cont	Continuous measurement is being performed
Terminated	(Single) measurement terminated
Stopped	Measurement has been terminated; continuous measurement has been paused.

Further messages about the states of a current measurement, e.g. underrange or over-range information, can also be displayed. For more detailed information, see [chapter 4.20, "Overview of Status Messages"](#), on page 235.



5.19.3.1 Continuous measurement

This is the standard operating mode of the measurement system, and it is set each time the R&S UPV is switched on. With continuous measurement, only the **START LED** lights up. The R&S UPV measures all activated measurement types continuously until one of the following events occurs:

START

Pressing the START key stops the current measurement immediately, resets the MIN/MAX indicator, the MIN/MAX values, the limit violations of the measurement displays and the highlighting of the protocol analysis, and causes the continuous measurement to be restarted.

Furthermore, starting or restarting a measurement also causes certain generator functions to restart:

- Burst signals (sine burst and sine² burst) are reset, that is, they start at the burst phase or burst on delay.
- The Play function starts again at the first sample in the WAV file.
- The Arbitrary function also starts again at the beginning.

Remote command:

[INITiate:CONTinuous](#) on page 906

SINGLE

Pressing the SINGLE key switches the instrument to single measurement mode. Each measurement type first completes the measurement that has already been started; when all measurement types have been completed, the measurement system is in the "Term" (terminated) state. Continuous measurement can be reactivated by pressing the START or STOP/CONT key.

Remote command:

[INITiate:CONTinuous](#) on page 906

STOP/CONT

Pressing the STOP/CONT key stops the current measurement immediately and causes the measurement system to enter the "Stop" state. Continuous measurement can be reactivated using the START key or by pressing the STOP/CONT key again.

Remote command:

[INITiate:FORCe](#) on page 908

Termination event

.. stops the current measurement immediately and causes the continuous measurement to be restarted (see [chapter 5.19.1, "Overview of the Measurement System"](#), on page 438).

5.19.3.2 Single measurement

Each measurement type is performed once only; the measurement system then assumes the "Term" (terminated) state. The measurement does not necessarily have to produce a real result: if an error occurs during the measurement, the measurement result is classed as invalid. In such case, "----" rather than the measured value will be displayed in the associated result window. With remote control, a NAN ("not a number", 9.97e37) value will be returned.

Each single measurement must be triggered again by pressing the SINGLE key or by means of a termination event. The **START-LED** and **SINGLE-LED** light up in the case of a single measurement.

In continuous single measurements, the control keys or buttons have the following functions:

START

Pressing the START key stops the current single measurement immediately, resets the MIN/MAX indicator, the MIN/MAX values, the limit violations of the measurement displays and the highlighting of the protocol analysis, and causes continuous measurement to be started.

Furthermore, starting or restarting a measurement also causes certain generator functions to restart:

- Burst signals (sine burst and sine² burst) are reset, that is, they start at the burst phase or "Burst on Delay".
- The Play function starts again at the first sample in the WAV file.
- The Arbitrary function also starts again at the beginning.

Remote command:

[INITiate:CONTinuous](#) on page 906

SINGLE

SINGLE stops the current measurement immediately and causes the single measurement to be restarted.

Restarting a single measurement also causes a restart of the burst signals (sine burst and sine² burst), i.e. they start with the burst phase or the burst on delay.

Remote command:

[INITiate:CONTinuous](#) on page 906

STOP/CONT



STOP/CONT stops the current measurement immediately and causes the measurement system to enter the "Stop" state. Reactivating the single measurement with SINGLE .

Remote command:

[INITiate:FORCe](#) on page 908

Termination event

.. stops the current measurement immediately and causes the continuous measurement to be restarted (see [chapter 5.19.1, "Overview of the Measurement System"](#), on page 438).

5.19.3.3 Terminated measurement

The measurement system only assumes this state when a single measurement is terminated. No further measurements are performed; the measured values and data sets are frozen until the next measurement is started. Measured values should only be read out via the remote-control station when the system is in this state. **None of the LEDs** light up when a measurement has been terminated. The control keys have the following function:

START



Pressing the START key resets the MIN/MAX indicator, the MIN/MAX values, the limit violations of the measurement displays and the highlighting of the protocol analysis, and causes continuous measurement to be started.

Furthermore, starting or restarting a measurement also causes certain generator functions to restart:

- Burst signals (sine burst and sine² burst) are reset, that is, they start at the burst phase or "Burst on Delay".
- The Play function starts again at the first sample in the WAV file.
- The Arbitrary function also starts again at the beginning.

Remote command:

[INITiate:CONTinuous](#) on page 906

SINGLE

SINGLE causes the start of a single measurement.

Starting a single measurement also causes a restart of the burst signals (sine burst and sine² burst), i.e. they start with the burst phase or the burst on delay.

Remote command:

[INITiate:CONTinuous](#) on page 906

STOP/CONT

STOP/CONT causes the start of continuous measurement.

Remote command:

[INITiate:FORCe](#) on page 908

Termination event

... stops the current measurement immediately and causes the continuous measurement to be restarted (see [chapter 5.19.1, "Overview of the Measurement System"](#), on page 438). In remote-control mode, the automatic measurement start is disabled so that setting commands can be dealt with at maximum speed.

5.19.3.4 Stopped measurement

The measurement system only assumes this state when STOP/CONT is pressed while a measurement is being performed. No currently valid measured values or data sets are available. Measured values should not be read out via the remote-control station when the system is in this state. The Control keys or buttons have the same function as when a measurement is terminated (see [chapter 5.19.3.3, "Terminated measurement"](#), on page 443).

5.20 Start Conditions

The Analyzer Config panel is used to define which conditions trigger the start of a measurement.

The menu item "Start Cond" defines when, how often or under what conditions measured values are to be recorded.

In addition to continuous operation, the following operating modes for recording measured values can be selected from this panel:

- Time-controlled measured value recording
- Externally controlled measured value recording (i.e. controlled by altering the measurement signal), known for short as "external sweeps"
- Level-controlled measured value triggering

When the conditions for measured value recording are met, the measured value is triggered, displayed in the measurement results panel and if appropriate stored in a measured value buffer internal to the device. The measured value list can be displayed numerically or graphically in one or more "sweep graphs" out of the available total of four.



In order for the measured value list to be recorded, the measured values of interest must be selected as traces (Y source) in the "Sweep Graph Config" panels. "X-axis" ("x-Source") should be set to "Sweep". Four sweep graphs with two traces each are available for measured value recording, so that a maximum of eight measured values can be recorded simultaneously.

5.21 Setting Start Condition

Ref Channel

Indicates the reference channel; only appears on multichannel analyzers.



The "Ref Channel" is the reference channel for measurements between two channels. They include the following measurements:

- Phase and group-delay measurement (the frequency measurement result is shown on the reference channel)



- Crosstalk measurements (ratio of two level measured values)



- Frequency tracking of selective RMS measurement



The reference channel cannot be switched off. If a reference channel that is not yet active is selected, then this channel is automatically switched on. Conversely, the attempt to switch off a channel that has been selected as the reference channel is rejected with a corresponding error message.

Note: If the trigger channel is used in the 16-channel analyzer, the reference and trigger channel must be in the same channel range (both channels either on channels 1 to 8 or 9 to 16).

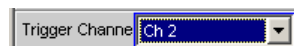
"Ch 1 / Ch 2 / Ch 3 ..."

Remote command:

[SENSe<n1>:REFerence<n2>:CHANnel](#) on page 894

Trigger Chan

Indicates the trigger channel; only appears on multichannel analyzers.



The "Trigger Chan" determines on which channel the trigger condition is tested.

The following are affected:

- The "Start Condition"
- The trigger source of the waveform monitors

If a channel that is not yet active is selected as the trigger channel, this channel is switched on automatically. If the measurement channel that is selected as the trigger channel is deactivated, then the trigger channel is automatically switched over to the reference channel.

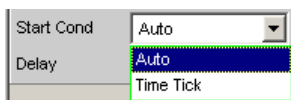
Note: The reference and trigger channel in the 16-channel analyzer must be in the same channel range (both channels either on channel 1-8 or 9-16).

Note: The parameter field for the trigger channel that is visible on the Waveform Monitor is identical to the field in the "Start Cond " area of the Analyzer Config panel.

"Off" No trigger channel is defined; the following restrictions apply:
The waveform monitor operates in untriggered mode; "Trigger Source" is unavailable.



Only "Auto" or "Time Tick" can be selected as "Start Cond".



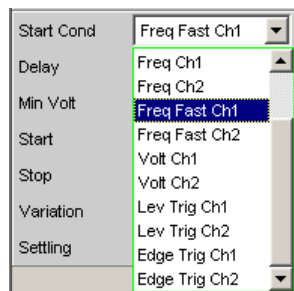
"Ch x" Selection of the trigger channel from the parameter list.

Remote command:

[TRIGger:CHANnel](#) on page 909

Start Cond

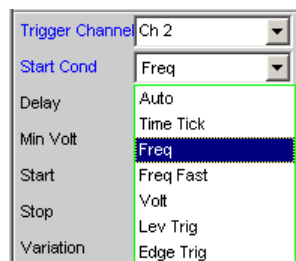
Specifies the event which triggers a measurement.



Depending on the "Start Cond" selected, the measurement starts either immediately (Auto) or only once the required trigger condition is met.

Note: With the two-channel analyzers, the trigger conditions appear together with the possible trigger channels in the parameter list; in this case, only the active channels are offered as trigger channels.

In the **multichannel analyzers**, first a trigger channel must be specified so that all start conditions are available. If the trigger channel is switched off, only "Auto" or "Time Tick" can be selected.



Note: With the multichannel analyzers, the trigger conditions appear in the parameter list without an explicit channel specification.

Note: If the reference points of a sweep are modified under the influence of the start condition during the sweep (e.g. due to over long measurement times during a time tick sweep), some sweep points may be outside of the visible x-axis of the sweep graphs. A further Autoscale call at the end of the sweep will enter the new X limits in the sweep graph.

"Auto"

Continuous measuring mode without trigger condition.

Values are recorded in the measured value buffer only if the frequency sweep for the selective RMS measurement or any type of generator sweep is active at the same time.

It is possible to switch between single and continuous measurements by pressing SINGLE or START if a sweep is not active.

- "Time Tick" Time-controlled measured value recording; measured value triggering at fixed intervals. In the gap between time ticks, measurements are started, the measurement results are entered in the measured value buffer and displayed in the measurement results panel.
- This start condition cannot be combined with a time-triggered generator sweep.
- If time tick is combined with the frequency sweep of the selective RMS measurement or with a synchronous generator sweep, sweep stepping is performed as usual, but measurement starts only after the time tick has expired.
- If neither the frequency sweep of the selective RMS measurement nor any generator sweep is active, the time tick defines the sweep x-axis:
- During the time tick sweep, the time stamps on the x-axis are updated and corrected if necessary (e.g. if a measurement lasts longer than the set time tick) and the individual measured values are entered according to their correct times.
 - When START is pressed a series of periodic measured value recordings begins, and when the number of sweep points specified under "Points" is reached the series starts again from the beginning.
 - When SINGLE is pressed, a single series of periodic measured value recordings begins. When the number of sweep points specified under "Points" is reached the sweep goes to "terminated" status.

- "Time Chart" Time-controlled measured value recording; measured value acquisition at fixed intervals; not available in the multichannel analyzers. Measured values (from the currently running continuous measurement) are entered in a time chart in the timescale that can be entered under "Time." In contrast to "Time Tick", where at each tick a new (single) measurement starts and the result is only entered when the measurement ends, with "Time Chart" intermediate results can also be displayed. This is particularly desirable in the case of quasi peak measurements.
- Note:** If the chosen time grid (update rate) is shorter than the measurement time required for the measurement function, intermediate results are displayed. Otherwise, end results are displayed.
- This start condition cannot be combined with a frequency sweep of the selective RMS measurement or a generator sweep. The time stamps of the measured value acquisition define the sweep x-axis:
- When START is pressed and immediately after the time chart sweep is switched on, a series of periodic measured value recordings begins. When the number of sweep points specified under "Points" is reached, the series starts again from the beginning.
 - When SINGLE is pressed, a single series of periodic measured value recordings begins. When the number of sweep points specified under "Points" is reached the sweep goes to "terminated" status.
- Note:** The sweep starts as soon as time chart is switched on, that is, intermediate or end results of the selected continuous measurement are displayed and recorded at fixed intervals.

"Freq ..."	<p>Externally controlled measured value recording; measured value triggering when a significant frequency change occurs on the trigger channel (external frequency sweep); available on multichannel analyzers only if the trigger channel is switched on.</p> <p>The measurement results are entered in the measured value buffer and displayed in the measurement results panel. The measured frequency is entered as an X value of the sweep.</p> <p>This start condition cannot be combined with the frequency sweep of the selective RMS measurement. The sweep x-axis is always predefined by the external frequency sweep, even if the internal generator is generating the sweep signal.</p> <ul style="list-style-type: none"> • Clean signals For particularly fast frequency sweeps with clean signal (e.g. from CD), the Fast variant "Freq Fast", "Freq Fast Ch1", "Freq Fast Ch2" can be selected. • Signals with high noise component If the signal has a high noise component, the slower but more precise measuring method "Freq", "Freq Ch1", "Freq Ch2" must be used. To achieve the shortest possible measuring times, the measurement of the trigger condition is done via an FFT with an FFT size that is automatically optimized to the expected signal frequency. If no frequency can be determined, then the FFT size is adjusted to the lowest expected frequency (start or stop value).
"Volt ..."	<p>Externally controlled measured value recording; measured value triggering when a significant level change occurs on the trigger channel (external level sweep); can be selected on multichannel analyzers only if the trigger channel is switched on.</p> <p>The measurement results are entered in the measured value buffer and displayed in the measurement results panel. The measured level is entered as an X value of the sweep.</p> <p>This start condition cannot be combined with the frequency sweep of the selective RMS measurement. The sweep x-axis is always predefined by the external level sweep, even if the internal generator is generating the sweep signal.</p>
"Lev Trig ..."	<p>Measured value triggering due to a level detected on the trigger channel at the analyzer input; can be selected on the multichannel analyzers only if the trigger channel is switched on.</p> <p>This start condition can be combined with any sweep and has no effect on the sweep x-axis.</p> <p>Sweep stepping or - if the sweep system is inactive - pressing START or SINGLE alerts level monitoring to wait until a level in the range between start and stop is measured (level triggering). When this occurs a single measurement is started, if necessary after a specified delay.</p> <p>In the case of continuous measurement, a further triggering in the specified range occurs only if the level has gone over or under the set range in the interim. This means that level monitoring is not put on alert again until a level outside of the specified range is detected.</p>

"Edge ..."

Measured value triggering due to a voltage edge detected at the analyzer input on the trigger channel; can only be selected in the multi-channel analyzers if the trigger channel is switched on.

This start condition can be combined with any sweep and has no effect on the sweep x-axis.

Level monitoring is started by sweep stepping or - if the sweep system is inactive - by pressing START or SINGLE . However, it is not put on alert until a level beyond the start level (outside of the start-stop interval) is measured. Triggering occurs at the moment when the level first enters the range between start and stop (edge triggering). When this occurs a single measurement is started, if necessary after a specified delay.

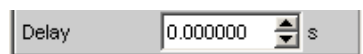
In the case of continuous measurement, a further triggering in the specified range occurs only if in the interim the level has left the set range and moved in the direction of the start level. This means that level monitoring is not put on alert again until a level beyond the start level is detected.

Remote command:

`TRIGger:SOURce` on page 910

Delay

Delay for Start Cond.



You can enter a delay for the "Start Cond Auto" menu item.

It applies under the following conditions:

- Signal change on the generator (value entry, value change via rotary knob)
Signal change on the generator by entering a value
- Performance of sweeps
- STOP/CONT or START (Continuous Measurement)
- SINGLE (Single Measurement)
- Change in the Analyzer panels
- Change in the Generator panels
- Change in the Filter panel

The "Delay" setting determines the time that must elapse between the above events and restarting of the measurement so that, for example, a DUT has sufficient time to settle. The total measuring time – i.e. the time that elapses until the measuring result is available – is thus increased by the specified delay.

Note: In the case of continuous measurement, a delay is only applied to the first measurement after the START. No delay is applied to subsequent measurements.

Note: If the overall delay (including internal delays) is greater than 2 s, the measurement will not be restarted automatically if changes are made at the generator, analyzer, or filter bank.

Note: The delay is applied to all measured channels. In the case of multichannel analyzers, the delay only extends the total measuring time of the first partial measurement

(first pair of channels); all further (measured offline) channel pairs can be measured without an additional time loss.

Remote command:

[TRIGger:DELaY](#) on page 909

5.22 Time-Controlled Measured value Recording

In time-controlled measured value recording, the estimated total recording time is derived from the product of the time interval per measurement and the number of measured value acquisitions. The actual duration of the measured value recording may be considerably longer in the case of the time tick start condition if the value entered for the time tick is shorter than the required measurement time.

The screenshot shows a control panel with three fields: 'Start Cond' is a dropdown menu set to 'Time Tick'; 'Time' is a text input field containing '1.00000' with a unit 's' to its right; 'Points' is a text input field containing '30'.

Time

Used for entering the time grid in which it is intended measurements should be started ("time tick") or measured values should be read ("time chart").

The screenshot shows a close-up of the 'Time' input field, which contains the value '1.00000' followed by a unit 's'.

When the start condition is "Time Tick" the measurement has priority over the start of a new measurement. If the time tick is longer than the measurement time, the system waits for the next time tick after each single measurement. During this waiting time no measurement is performed. If the time tick is shorter than the measurement time, any time ticks occurring during a running measurement will be ignored. This means that measurements will be started at time intervals corresponding to an integer multiple (≥ 1) of the selected time tick.

When the start condition is "Time Chart" (not available in the multichannel analyzers) the measured value is read in the specified time grid, regardless of whether a new measured value is present. If the chosen time grid (update rate) is longer than the measurement time for the measurement function, then only end results are displayed. If the time grid is shorter than the measurement time, intermediate results are displayed if available. If no intermediate results are yet available, the last valid results are entered in the time chart again.

Remote command:

[TRIGger:TIMer](#) on page 910

Points

For entering the number of measured value recordings.

The screenshot shows a close-up of the 'Points' input field, which contains the value '30'.

Time-controlled measured value recording ends as soon as the number of measured data items specified here are available.

Note: If the start condition "Time Tick" is combined with the frequency sweep of the selective RMS measurement or a synchronous generator sweep, the number of sweep points is taken from there and cannot be entered separately.

Remote command:

TRIGger:COUNT on page 909

5.23 External Sweeps and Level-Controlled Measured value Triggering

External sweeps are usually controlled by means of an external signal source. The internal sweep generator should not be active in this case. A warning message is output if the internal sweep generator is still active when an external sweep is activated.

Basically, the internal sweep generator can be used as a signal source also with **external sweeps**. This is meaningful, for example, if the delay of the DUT is not known or not constant and it is, therefore, not possible to couple the generator stepping permanently to the measurement start. Sweep stepping is performed as usual, but measurement does not start until a trigger event occurs.

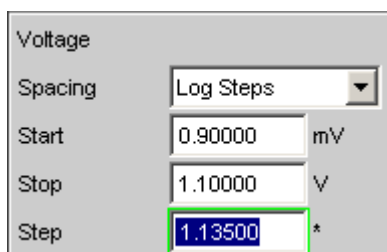
The generator should be stepped in a time-controlled manner (dwell sweep; setting in generator: "Next step" = "dwell value" or "dwell file"), in order to achieve independence from generator sweep stepping and measurement.



For analyzer-synchronous stepping (setting in generator: "Next Step" = "Anlr Sync"), it is important to ensure that each sweep step extends beyond the variation selected for the start condition. If this condition is not met, the external sweep comes to a stop.

The following rules must be followed for setting the generator sweep in the case of an external sweep:

- "Spacing" must be set to "Log Steps" (optional for dwell sweep).
- The sweep direction (specified by the sequence between "Start" and "Stop") must agree with the recording direction chosen in the analyzer.
- The sweep range must be within the recording range (optional for dwell sweep).
- The step width, or increment (specified in the generator as a factor under "Step") must be greater than "Variation" in the analyzer (optional for dwell sweep).
 for upward sweeps (Start < Stop): $Step > 1 + Variation / 100$
 for downward sweeps: (Start > Stop): $Step < 1 - Variation / 100$



The sweep x-axis is always predefined by the external sweep, even if it is the internal generator that generates the sweep signal.

The start and stop values determine the sweep direction for external sweeps: If the start value is less than the stop value, an upward sweep is performed, otherwise a downward sweep will be performed.

Signal changes counter to the sweep direction affect continuous mode and single mode differently:

- If an external continuous sweep was started using START any significant change of frequency in the stop to start direction causes the sweep to restart.
- If an external single sweep was started using SINGLE, changes in the stop to start direction are interpreted as interference and ignored. A measured value beyond the stop value terminates the sweep.

Though using the internal generator for **level-controlled measured value triggering** is not actually prohibited, in most cases it gives no advantage.

Start Cond	Lev Trig Ch1	
Delay	0.00000	s
Start	0.01000	V
Stop	1.00000	V

In the case of **edge-sensitive triggering**, the triggering edge is defined by the start and stop values: If the start value is less than the stop value, triggering occurs on a positive edge, that is, at the exact moment when a value below "Start" is followed by a value above "Start."

Min Volt

This is used to enter a minimum level for external frequency sweeps. If the signal is below this threshold, no triggering occurs.

Min Volt	1.00000	mV
----------	---------	----

It prevents triggering at pauses in the signal. An excessively low minimum level would cause even frequency values measured in the noise to be used for triggering.

Remote command:

[ARM:LEVel:MIN](#) on page 911

Start

This is used to enter the start value for the recording interval (in the case of external sweeps) or for the trigger range (in the case of level triggering).

Start	1000.00	Hz
-------	---------	----

The start value should be selected so that the first value to be recorded lies within the start/stop interval even for measurement uncertainties.

If the start value is less than the stop value, the external sweep runs as an upward sweep; in the case of edge triggering the system awaits a positive edge. Measured values that are lower than "Start" are ignored.

If the present stop value is entered as the start value, the sweep direction is automatically reversed and the stop value is given the old start value.

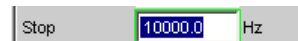
Remote command:

[ARM:FREQuency:START](#) on page 911

[ARM:VOLTage:START](#) on page 911

Stop

This is used to enter the stop value for the recording interval (in the case of external sweeps) or for the trigger range (in the case of level triggering).



The stop value should be set to the expected full-scale value of the external sweep.

If the stop value is less than the start value, the external sweep runs as a downward sweep; in the case of edge triggering the system awaits a negative edge.

If the present start value is entered as the stop value, the sweep direction is automatically reversed and the start value is given the old stop value.

Termination condition:

For a scan to terminate correctly, the last measured value must exceed the specified stop value or approach it by less than the specified "variation" from the end value.

Note: Multiscan mode:

It must be ensured that the termination condition is met to ensure that all scans are stored.

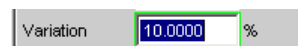
Remote command:

[ARM:FREQuency:STOP](#) on page 911

[ARM:VOLTage:STOP](#) on page 911

Variation

For entering the relative change of frequency or level in the form of a percentage with effect from which a new measurement is triggered in the case of external sweeps. For external level sweeps the value can also be entered in dB.



The variation chosen should be some 5% to 10% smaller than the expected changes, so that on the one hand triggering will occur reliably and on the other hand will not occur on intermediate values.

The entered value is used to calculate the internal variation factor

- For upward sweeps: $1 + \text{var}/100$
- For downward sweeps: $1 - \text{var}/100$

Note: Due to the different variation factors for upward and downward sweeps, the number of sweep points in an upward sweep - given identical values for "Start", "Stop" and "Variation" - is somewhat greater than in a downward sweep.

In the case of continuous sweeps, a change by at least this value in the stop to start direction (i.e. counter to the sweep direction) causes measured value recording to restart.

The lower entry value takes account of the current start and stop values and is automatically limited so that regardless of the sweep direction a maximum of 1024 measured values can be recorded. Values of less than 0.1% cannot generally be entered.

Remote command:

[TRIGger:FREQuency:VARIation](#) on page 910

[TRIGger:VOLTage:VARIation](#) on page 910

5.24 Sweep Options

Besides the measurement system, the R&S UPV is also equipped with a comprehensive sweep system. This sweep system is enabled as a generator sweep system by activating a generator sweep or as an analyzer sweep system by activating the RMS selection sweep, and then takes control of the measurement system.

When a sweep system is activated, sweeps are started and also stopped in manual operating mode using the START, SINGLE and STOP/CONT keys or buttons.

Starting or restarting a sweep (via START) also causes certain generator functions to restart:

- Burst signals (sine burst and sine² burst) are reset, that is, they start at the burst phase or "Burst on Delay".
- The Play function starts again at the first sample in the WAV file.
- The Arbitrary function also starts again at the beginning.

5.24.1 Overview of Sweep Options

The following information refers to **an activated sweep system**, i.e. a sweep is activated in either the generator or the analyzer.

Sweeps are measurement cycles in which the individual measurements are triggered by predefined generator and analyzer settings. The generator and analyzer sweeps can be defined either by entering the start value, stop value, spacing and points/step or by specifying a sweep list. Both methods ultimately define a **table of settings** (x-axis) which is processed when the sweep is started.

A one-off sweep is referred to as a **single sweep** and a continuously repeated sweep as a **continuous sweep**.

The **active sweep system is controlled**

- explicitly using START (Ctrl F5), SINGLE (Ctrl F6) and STOP/CONT (Ctrl F7)
- implicitly by means of "termination events". These are events (user entries) which invalidate the current measurement and, therefore, the current sweep, i.e. changes in the generator, analyzer or filter bank. Following a termination event, the current sweep is restarted automatically. This ensures that the recorded data sets are based on the same settings.

It is not possible to **control the measurement system** if the sweep system is activated. Exception: When a sweep has been terminated, STOP/CONT or a termination

event activates the continuous measurement (see [chapter 5.24.3.3, "Terminated sweep"](#), on page 461).

The R&S UPV offers many different sweep options, which are briefly summarized here:

- Generator sweep system: Time-synchronous sweeps (DWELL sweeps) and analyzer-synchronous sweeps (AUTO sweeps) and manual sweeps (MANU sweeps). They can also be 2-dimensional (provided that more than one sweepable parameter exists for the selected generator function), i.e. 2 generator parameters are varied. This is then referred to as a Z sweep because the z-axis is swept in addition to the x-axis.
- Analyzer sweep system: Analyzer-synchronous sweep of the RMS selection frequency.

All sweeps can be performed either as parameter sweeps with constant increment or as list sweeps.

5.24.2 Activating and Deactivating Sweeps



In the R&S UPV the desired sweep system is activated or deactivated directly on the associated function panel:

- A generator sweep under "Sweep Ctrl" in the Generator Function panel.
- Sweep of the tracking filter for the "RMS Selective" measurement function under "Sweep Ctrl" in the Analyzer Function panel.

Only one of the two sweep systems can be active at any one time. If the user activates a sweep while another sweep is already active, the sweep that is already active is deactivated and a warning is issued. If an instrument or function which contains a sweep is activated while another sweep is already active, the new sweep is deactivated and an appropriate warning is issued.

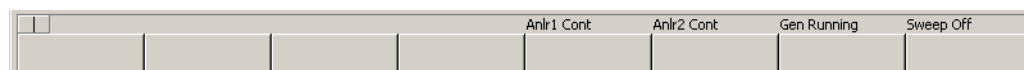
When a sweep is activated, the measurement system first continues to run in continuous or single-measurement mode; the sweep system does not assume control of the measurement system until the sweep is started.

When the active sweep is deactivated, the measurement system switches back to continuous measurement.

5.24.3 States of the Sweep System

The state of the sweep system is indicated above the 8th softkey. If the sweep system is activated, the current state is also indicated by the two LEDs above the START and SINGLE key.

Two-channel analyzer



Multichannel analyzer

				Anlr Cont	12345678	Gen Running	Sweep Off
--	--	--	--	-----------	----------	-------------	-----------

Table 5-7: The following states are possible:

Off	Sweep is deactivated; the measurement system is controlled directly by the user.
Single	Single sweep is being performed
Cont	Continuous sweep is being performed
Waiting	Sweep is waiting for a (re)start; has been reactivated or has been run at least once as a single sweep.
Stopped	Sweep has been stopped; can be continued or restarted.

5.24.3.1 Continuous sweep

Continuous sweeps are started with START . The sweep state is indicated by "Sweep Cont" and illuminated **START LED**. When the sweep reaches the stop value of the x-axis or the end of the X sweep list, it starts again at the start value. This is repeated until one of the following events occurs:

START



Pressing START

- interrupts the currently running sweep at once
- deletes the sweep curves (in multiscan mode all scans are deleted) including the min/max curves
- resets the min/max data and limit violations of the sweep curves as well as the highlighting of the protocol analysis
- causes the continuous sweep to restart

Remote command:

[INITiate:CONTinuous](#) on page 906 ON

[INITiate:FORCe](#) on page 908 START

SINGLE



Pressing SINGLE switches to single sweep. The remaining points are plotted on the trace and the sweep system then enters the "Sweep Waiting" state.

Reactivation of continuous sweep with START ;

Remote command:

[INITiate:CONTinuous](#) on page 906 OFF

[INITiate:FORCe](#) on page 908 SINGLE

STOP/CONT



Pressing STOP/CONT terminates the current measurement and pauses the sweep system (Sweep Stopped state).

Reactivation of continuous sweep either with START (starts from the beginning) or by pressing STOP/CONT again (resumes the sweep from the point where it was stopped).

Remote command:

[INITiate:FORCe](#) on page 908 STOP

Termination event

... stops the current sweep immediately and causes the continuous sweep to be restarted (see [chapter 5.24.1, "Overview of Sweep Options"](#), on page 456).

Z stop value reached

The continuous sweep is stopped; the sweep system changes to the "Sweep Waiting" state (only with 2-dimensional generator sweeps, see [chapter 5.10.3, "Two-Dimensional Sweep"](#), on page 350).

5.24.3.2 Single sweep

Single sweeps are started by pressing the SINGLE key and are performed once only. When the stop value (of the x-axis) has been reached, the sweep system switches to the "Sweep Waiting" state. With a 2-dimensional sweep, every new Z point (and the associated sweep over the x-axis) must therefore be retriggered.

The sweep state is indicated by "Sweep Single"; the **START LED** and **SINGLE LED** light up.

A current single sweep is interrupted or terminated by the following events:

START



Pressing START

- interrupts the currently running sweep at once

- deletes the sweep curves (in multiscan mode all scans are deleted) including the min/max curves
- resets the min/max data and limit violations of the sweep curves as well as the highlighting of the protocol analysis
- starts a continuous sweep

Remote command:

`INITiate:CONTInuous` on page 906 ON

`INITiate:FORCe` on page 908 START

SINGLE



Pressing SINGLE stops the current sweep immediately and causes the single sweep to be restarted.

Remote command:

`INITiate:CONTInuous` on page 906 OFF

`INITiate:FORCe` on page 908 SINGLE

STOP/CONT



Pressing STOP/CONT terminates the current measurement and pauses the sweep system (Sweep Stopped state).

The single sweep is reactivated either using SINGLE (sweep starts from the beginning) or by pressing STOP/CONT again (sweep continues from the point at which it was stopped).

Remote command:

`INITiate:FORCe` on page 908 STOP

Termination event

... stops the current sweep immediately and causes the single sweep to be restarted (see [chapter 5.24.1, "Overview of Sweep Options"](#), on page 456).

X stop value reached

The single sweep is stopped; the sweep system changes to the "Sweep Waiting" state.

Remote command:

-

5.24.3.3 Terminated sweep

The sweep system only enters this state if a single sweep or a 2-dimensional continuous sweep is terminated. No further measurements are performed; the measured values, data sets and sweep traces are frozen. Sweep traces should only be read out via the remote-control station when the system is in this state.

The sweep state is indicated by "Sweep Waiting"; **none of the LED** light up.

A terminated single sweep is affected by the following events:

START



Pressing START

- deletes the sweep curves (in multiscan mode all scans are deleted) including the min/max curves
- resets the min/max data and limit violations of the sweep curves as well as the highlighting of the protocol analysis
- starts a continuous sweep

Remote command:

[INITiate:CONTInuous](#) on page 906 ON

[INITiate:FORCe](#) on page 908 START

SINGLE



Pressing SINGLE causes the single sweep to be restarted.

Remote command:

[INITiate:CONTInuous](#) on page 906 ON

[INITiate:FORCe](#) on page 908 SINGLE

STOP/CONT



Pressing STOP/CONT starts continuous measurement. Reactivating the single sweep with SINGLE .

Remote command:

-

Termination event

... starts the continuous measurement (see [chapter 5.24.1, "Overview of Sweep Options"](#), on page 456).

5.24.3.4 Stopped sweep

The measurement system only assumes this state when the STOP/CONT key is pressed while a measurement is being performed. Valid measured values and data sets from the sweep point last set are available. However, only some of the measured values of the sweep trace are available. Sweep traces should not be read out via the remote-control station when the system is in this state.

The sweep state is indicated by "Sweep Stopped"; **none of the LEDs** light up.

A stopped sweep is affected by the following events:

START

Pressing START

- deletes the sweep curves (in multiscan mode all scans are deleted) including the min/max curves
- resets the min/max data and limit violations of the sweep curves as well as the highlighting of the protocol analysis
- starts a continuous sweep

Remote command:

[INITiate:CONTinuous](#) on page 906 ON

[INITiate:FORCe](#) on page 908 START

SINGLE

Pressing SINGLE causes the single sweep to be restarted.

Remote command:

[INITiate:CONTinuous](#) on page 906 OFF

[INITiate:FORCe](#) on page 908 SINGLE

STOP/CONT

Pressing STOP/CONT continues the sweep.

Remote command:

-

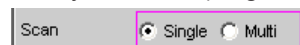
Termination event

... starts the continuous measurement (see [chapter 5.24.1, "Overview of Sweep Options"](#), on page 456).

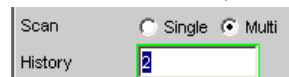
5.24.4 Several Sweep Traces in One Diagram

Up to 2 traces can be displayed in every sweep window. There are two options for displaying the sweep traces. These options can be selected in the individual sweep windows:

- Each new sweep cycle deletes the old trace; only one trace (or trace pair) is visible at any one time (single-scan mode).



- Each new sweep cycle plots a new trace without deleting the old trace; all recorded traces are visible (multi-scan mode).



Since only a finite number of traces (i.e. the last 20 traces) can be stored in multi-scan mode, all the traces only remain visible until rescaling is performed. When rescaling is performed, the graphical display is deleted and the most recent traces are replotted making the graph easier to read. The number of traces to be replotted can be set in the "History" entry field.

5.25 Level Measurements

The R&S UPV provides various level measurements which can be used to determine the AC or DC voltage component of a measurement signal using various methods.

- "RMS" determines the RMS of any given signal using a broadband analysis, optionally with suppression of a DC component contained in the signal.
- "RMS Selective" determines the RMS of a specific frequency inside or outside a selectable frequency band (by using a bandpass filter or a bandstop filter). Once again, it is possible to suppress a DC component contained in the signal.
- "Rub & Buzz" determines the RMS value above a selectable harmonic of the signal frequency (by using a tracking highpass filter).
- "DC" determines the DC component of any given signal.
- "Quasi Peak" determines the peak value of any given signal, the rise and fall of the measured value occur with defined time constants.
- "Peak" determines the peak value of any given signal, the measured value changes with the peak value without a delay.

The voltage of an analog signal is determined in volts and the amplitude of a digital signal is determined in FS. According to AES-17, a full-scale digital sine-wave signal has a peak value and an RMS of 1.0 FS, i.e. in contrast to the analog signal, the RMS determined for a digital signal is higher by a factor of $\sqrt{2}$.



Level measurement is also possible using the FFT analysis by means of integration via the frequency lines. If the FFT measurement function is selected, the RMS value calculated by this method is shown as a function measured value, and the measurement bandwidth can be restricted using the parameter fields "Freq Limit", followed by "Freq Lim Low" and "Freq Lim Upp".

The interval during which the level of the measurement signal is monitored can be specified by the user as the measurement time or the interval time.

With AC measurements, other digital filters or (in the two-channel analog analyzer) an analog notch filter can be looped into the measurement path in addition to the input filter.

5.25.1 Filter Settings

DC Suppress

Used to activate DC suppression (only with RMS measurements in the digital analyzer).



With the level measurements "RMS" and "RMS Selective", the user can decide whether DC levels are to be taken into consideration or suppressed in the RMS.

This parameter field is not available in the analog analyzer because the suppression function is already provided by the AC coupling, which can be set up using the hardware.

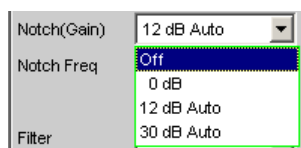
- | | |
|---------------|--|
| "deactivated" | DC suppression deactivated.
The DC component of the measurement signal is not suppressed ("DC coupling") and is included in the measurement result. |
| "activated" | DC suppression activated.
The DC component of the measurement signal is suppressed ("AC coupling"); the measurement result includes the AC component only.
For DC suppression in the digital analyzer, the DC level is measured and subtracted from the total RMS value. |

Remote command:

[SENSe<n1>:FUNction:DCSuppression](#) on page 935

Notch(Gain)

Used to activate/deactivate the analog notch filter and select the post-gain. Available only in the two-channel analog analyzer for the two types of RMS measurements and with "Quasi Peak".



The second-order analog notch filter can be activated for narrow band suppression of an unwanted frequency line. If the fundamental is suppressed with the notch filter, the residual signal can be amplified in order to increase the dynamic response. Three notch gain levels are available.

Note: If frequency components occur outside the analyzer frequency range (out-of-band signals), the notch gain could cause overloading of the analyzer. In this case, the notch gain is reduced automatically, which is indicated by Auto in list items 12 dB and 30 dB.

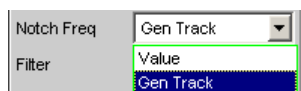
"Off"	The notch filter is deactivated; no additional parameter fields are displayed.
"0 dB"	The notch filter is activated; the notch gain is deactivated. The notch frequency can be selected in the next parameter field.
"12 dB Auto"	The notch filter is activated; the notch gain is 12 dB (is deactivated if out-of-band signals occur). The notch frequency can be selected in the next parameter field.
"30 dB Auto"	The notch filter is activated; the notch gain is 30 dB (is reduced gradually to 12 or 0 dB if out-of-band signals occur). The notch frequency can be selected in the next parameter field.

Remote command:

[SENSe<n1>:NOTCh](#) on page 942

Notch Freq

Used to select the center frequency of the notch filter (notch frequency); only with activated analog notch filter.



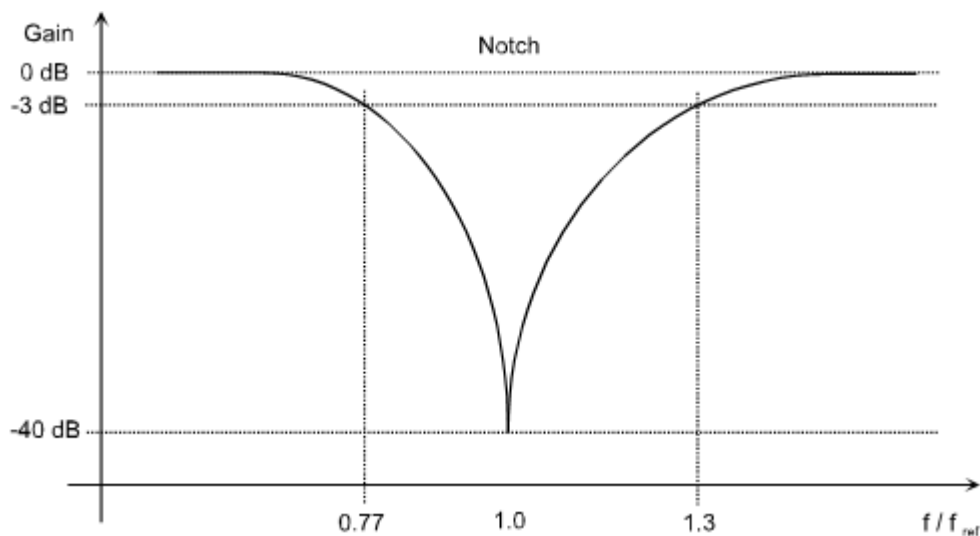


Fig. 5-23: Characteristic of analog notch filter

"Value " The user can enter the notch-filter center frequency in the next parameter field. If "Value" is selected, the center frequency last active is displayed.

Notch Freq Hz

"Gen Track" The notch-filter center frequency is adopted from the generator panel (if possible). If the generator frequency is changed, the notch frequency also changes. If an unsuitable generator signal (e.g. noise) is set, an error message is output and the center frequency last valid is retained.

Notch Freq

Note: If the Low Distortion Generator option is used, "Gen Track" should be avoided on account of the rigid coupling to the generator's nominal frequency, otherwise measuring inaccuracy resulting from slight frequency offset could occur.

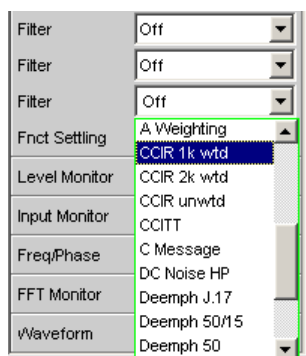
Remote command:

[SENSe<n1>:NOTCh:FREQuency:MODE](#) on page 943

Filter

Activating a digital filter in the test channel. Depending on the level measurement method selected, up to 3 user-defined filters or weighting filters can be looped into the measurement path:

- RMS, Peak, Quasi Peak, FFT: max. 3 filters
- RMS Selective: max. 1 filter in addition to selection filter
- "Rub & Buzz": max. 2 filters in addition to the tracking highpass filter
- DC: no filter



The user-definable filters are configured as filters 01 to 09 in the filter panel (see [chapter 5.44, "User-Definable Filters"](#), on page 628) and can then be used (repeatedly if necessary) in the analyzer.

For more information on the available weighting filters, see [chapter 5.45, "Weighting Filters"](#), on page 637.

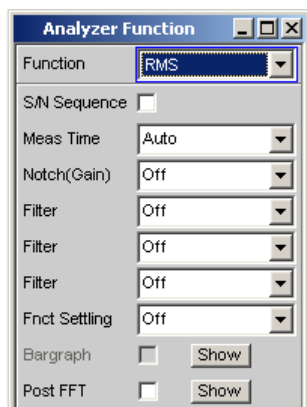
Note: Regardless of the digital filters selected here, a further input filter ("prefilter") can be looped into the test channel. Moreover, the analog bandwidth can be restricted with the aid of the "Bandwidth" parameter field, which corresponds to an additional lowpass filter.

Remote command:

`SENSe<n1>:FILTer<n2>` on page 958

For a description of the filters and their setting parameters, see [chapter 5.43.4, "Filter Table"](#), on page 628.

5.25.2 RMS Measurement, Broadband



Method used to measure the RMS of an AC voltage, either taking account of or disregarding a superimposed DC voltage. Any given signal shape can be measured.

Analog operation:

Depending on the selected coupling, a superimposed DC component is measured (DC coupling) or suppressed (AC coupling).

For more settings, see [chapter 5.25, "Level Measurements"](#), on page 463.

Digital operation:

The true RMS value of the signal content is displayed as a full-scale value from 0.0 to 1.0. Depending on whether "DC Suppress" is activated or deactivated, a superimposed DC component is measured (deactivated) or suppressed (activated).

SCPI command:

`SENSe<n1>:FUNCtion RMS`

Meas Time

This is used for choosing the measurement time for the purpose of adapting the measurement speed to the waveform or, in the case of single tone signals, to the signal frequency.

The priority can be set to a short measurement time or high accuracy depending on specific measurement requirements.

In automatic measurement modes the measurement time is adapted to the measured signal frequency, provided an AC signal that is sufficiently strong and not too low in frequency is present ($f \geq 10$ Hz).

Note: With severely noise-corrupted or distorted signals and multi-tone signals, the automatic measurement modes (especially "Auto Fast") may no longer be able to clearly detect the signal period. To prevent measurement errors, such signals should therefore be measured using "Gen Track" or (if an external generator is used) using the "Value" measurement mode.

"Auto Fast" Where possible, the RMS measurement is performed over entire AC periods; with high frequencies, the measurement time is increased so that the maximum algorithmic error does not exceed 1 %.
With very weak, low-frequency or pure DC signals, the maximum measurement time is limited to 100 ms (corresponding to 1 period at 10 Hz).



Recommended for single-tone measurements using the low-distortion generator or an unknown external signal source if maximum measurement speed is desired.

Note: For infrasound measurements (below 10 Hz), can only be measured using a fixed measurement time (Value or Gen Track).

"Auto"

Where possible, the RMS measurement is performed over entire AC periods; with medium or high frequencies, the measurement time is increased so that the maximum algorithmic error does not exceed **0.05 %**.

With very weak, low-frequency or pure DC signals, the maximum measurement time is limited to 200 ms (corresponding to 2 periods at 10 Hz).



Recommended for single-tone measurements using the low-distortion generator or an unknown external signal source if maximum measurement accuracy is desired.

Note: For infrasound measurements (below 10 Hz), can only be measured using a fixed measurement time (Value or Gen Track).

"Value "

The RMS measurement is performed over a preset time which must be entered in the parameter field below.



To prevent errors due to termination of measurements, the selected measurement time should be an integer multiple of the period. If the frequency of the signal to be measured is unknown or not constant, the selected measurement time should be as long as possible in order to minimize such errors.

Note: If a multichannel analyzer is used, max. 1.44 million samples can be monitored. In these analyzers, the maximum measurement time is therefore dependent on the sampling rate or the analog bandwidth; for example, for a 40 kHz analog bandwidth it is 15 s. If a longer measurement time is needed, the measurement must be carried out with one of the two-channel analyzers (up to 100 s).

Recommended for

- AC measurements of a known external signal source
- measurements of severely noise-corrupted or distorted signals of unknown frequency
- measurements of noise signals or multi-tone signals

"Gen Track" The RMS measurement is performed over (at least) 1 whole period of the generator signal; to allow this, the generator frequency is adapted to the sampling rate of the analyzer, if necessary. In the case of high frequencies, the measurement time is extended to several periods in order to increase the measurement accuracy.



Recommended for all AC measurements when using the R&S UPV Universal Generator; also particularly suitable for measuring severely noise-corrupted or distorted signals, and for fast sweeps.

Note: If the Low Distortion Generator option is used, "Gen Track" should be avoided on account of the rigid coupling to the generator's nominal frequency, otherwise measuring inaccuracy resulting from slight frequency offset could occur.

Note: If the "Mod Dist" signal is used as the generator signal, the measurement time is based on the (usually dominant) "Lower Frequency".

Note: If "Stereo Sine" is used as the generator signal, measurement channel 1 tracks generator channel 1 and measurement channel 2 tracks generator channel 2.

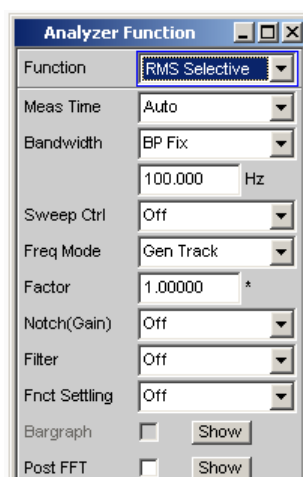
Note: If "Arbitrary" is used as the generator signal, the measurement time is synchronized to the number of samples in the loaded file. As a result, measurement is always performed over a complete period of the (repeatedly output) ARB signal.

Remote command:

[SENSe<n1>:FUNCTion:APERture:MODE](#) on page 930

[SENSe<n1>:VOLTage:APERture](#) on page 931

5.25.3 RMS Measurement, Selective



Selective RMS measurement with narrow band bandpass filter or narrow band band-stop filter, either taking account of or disregarding a superimposed DC voltage.

In analog operation, depending on the coupling selected, a superimposed DC component is measured (DC coupling), or it is suppressed (AC coupling). In digital operation, depending on whether "DC Suppress" is activated or deactivated, a superimposed DC component is measured (deactivated) or suppressed (activated).

If a bandpass filter is used, the desired frequency component is measured; if a band-stop filter is used, this component is suppressed. Any given signal shape can be measured.

For more settings, see [chapter 5.25, "Level Measurements"](#), on page 463.

SCPI command:

`SENSe[1]:FUNCtion RMSSelect`

Meas Time

This is used for choosing the measurement time for the purpose of adapting the measurement speed to the waveform or, in the case of single tone signals, to the signal frequency.

The priority can be set to a short measurement time or high accuracy depending on specific measurement requirements.

In automatic measurement modes the measurement time is adapted to the measured signal frequency, provided an AC signal that is sufficiently strong and not too low in frequency is present ($f \geq 10$ Hz).

Note: With severely noise-corrupted or distorted signals and multi-tone signals, the automatic measurement modes (especially "Auto Fast") may no longer be able to clearly detect the signal period. To prevent measurement errors, such signals should therefore be measured using "Gen Track" or (if an external generator is used) using the "Value" measurement mode.

"Auto Fast" Where possible, the RMS measurement is performed over entire AC periods; with high frequencies, the measurement time is increased so that the maximum algorithmic error does not exceed 1 %.
With very weak, low-frequency or pure DC signals, the maximum measurement time is limited to 100 ms (corresponding to 1 period at 10 Hz).



Recommended for single-tone measurements using the low-distortion generator or an unknown external signal source if maximum measurement speed is desired.

Note: For infrasound measurements (below 10 Hz), can only be measured using a fixed measurement time (Value or Gen Track).

"Auto"

Where possible, the RMS measurement is performed over entire AC periods; with medium or high frequencies, the measurement time is increased so that the maximum algorithmic error does not exceed **0.05 %**.

With very weak, low-frequency or pure DC signals, the maximum measurement time is limited to 200 ms (corresponding to 2 periods at 10 Hz).

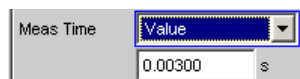


Recommended for single-tone measurements using the low-distortion generator or an unknown external signal source if maximum measurement accuracy is desired.

Note: For infrasound measurements (below 10 Hz), can only be measured using a fixed measurement time (Value or Gen Track).

"Value "

The RMS measurement is performed over a preset time which must be entered in the parameter field below.



To prevent errors due to termination of measurements, the selected measurement time should be an integer multiple of the period. If the frequency of the signal to be measured is unknown or not constant, the selected measurement time should be as long as possible in order to minimize such errors.

Note: If a multichannel analyzer is used, max. 1.44 million samples can be observed. In these analyzers, the maximum measurement time is therefore dependent on the sampling rate or the analog bandwidth; for example, for a 40 kHz analog bandwidth it is 15 s. If a longer measurement time is needed, the measurement must be carried out with one of the two-channel analyzers (up to 100 s).

Recommended for

- AC measurements of a known external signal source
- measurements of severely noise-corrupted or distorted signals of unknown frequency
- measurements of noise signals or multi-tone signals

"Gen Track" The RMS measurement is performed over (at least) 1 whole period of the generator signal; to allow this, the generator frequency is adapted to the sampling rate of the analyzer, if necessary. In the case of high frequencies, the measurement time is extended to several periods in order to increase the measurement accuracy.



Recommended for all AC measurements when using the R&S UPV Universal Generator; also particularly suitable for measuring severely noise-corrupted or distorted signals, and for fast sweeps.

Note: If the Low Distortion Generator option is used, "Gen Track" should be avoided on account of the rigid coupling to the generator's nominal frequency, otherwise measuring inaccuracy resulting from slight frequency offset could occur.

Note: If the "Mod Dist" signal is used as the generator signal, the measurement time is based on the (usually dominant) "Lower Frequency".

Note: If "Stereo Sine" is used as the generator signal, measurement channel 1 tracks generator channel 1 and measurement channel 2 tracks generator channel 2.

Note: If "Arbitrary" is used as the generator signal, the measurement time is synchronized to the number of samples in the loaded file. As a result, measurement is always performed over a complete period of the (repeatedly output) ARB signal.

Remote command:

[SENSe<n1>:FUNCTION:APERture:MODE](#) on page 930

[SENSe<n1>:VOLTage:APERture](#) on page 931

Bandwidth

Used to select the bandwidth and filter type (bandpass filter BP... or bandstop filter BS...).

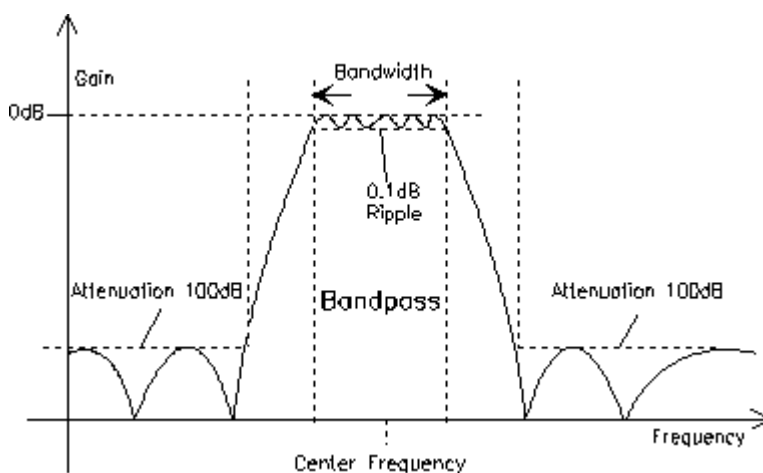


Fig. 5-24: Filter characteristic of an RMS Selective bandpass filter

"BP 1 % ""BS 1 %"

Bandpass filter / bandstop filter with relative width of 1 % (geometrically symmetrical about the center frequency).



(Bandpass filter)



(Bandstop filter)

"BP 3 % ""BS 3 % "

Bandpass filter / bandstop filter with relative width of 3 % (geometrically symmetrical about the center frequency).



(Bandpass filter)



(Bandstop filter)

"BP 1/12 Oct""BS 1/12 Oct"

Bandpass filter / bandstop filter with the relative width of one twelfth octave (geometrically symmetrical around the center frequency).



(Bandpass filter)



(Bandstop filter)

The relative bandwidth of one twelfth octave is ≈ 6 %.

It is calculated from

$$\sqrt[24]{2} - \left(1/\sqrt[24]{2}\right) = 0.0577 = 5.77\%$$

"BP 1/3 Oct""BS 1/3 Oct"

Bandpass filter / bandstop filter with the relative width of one third octave (geometrically symmetrical around the center frequency).



(Bandpass filter)



(Bandstop filter)

The relative bandwidth of one third octave is ≈ 23 %.

It is calculated from

$$\sqrt[6]{2} - \left(1/\sqrt[6]{2}\right) = 0.2315 = 23.15\%$$

Note: With the third-octave filter, the 0.1 dB bandwidth is reduced until an attenuation of approx. 3 dB is obtained for the cutoff frequencies. The effective bandwidth is therefore smaller than the precise bandwidth determined by calculation.

"BP 1/3 Oct Fast" "BS 1/3 Oct Fast"

Very fast settling third-octave filter (see above) with only 40 % attenuation.



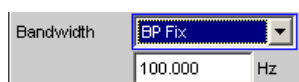
(Bandpass filter)



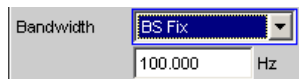
(Bandstop filter)

"BP Fix" "BS Fix"

Bandpass filter / bandstop filter with selectable, arithmetically symmetrical bandwidth which must be entered in the parameter field below.



(Bandpass filter)



(Bandstop filter)

Note: For infrasound measurements, the bandwidth can be reduced down to a sampling rate/48000 (but at least 1 Hz). As very long filter settling times occur in the range below 10 Hz, measurement results can only be viewed after several seconds.

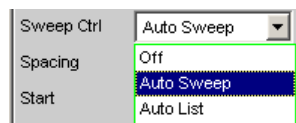
Remote command:

[SENSe<n1>:BANDwidth:MODE](#) on page 932

[SENSe<n1>:BANDwidth](#) on page 932

Sweep Ctrl

Used to activate and configure or deactivate the bandpass sweep / bandstop sweep in the analyzer sweep system.



In the two channel analog analyzer, the notch frequency of the analog notch filter (which can be enabled if required) is also swept.

Note: The sweeps are also deactivated implicitly when the generator sweep is activated and when certain start conditions are selected (e.g. external sweeps or "Time Chart").

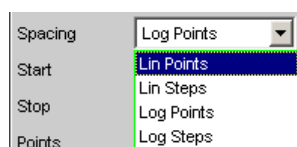
- "Off" The bandpass sweep / bandstop sweep is deactivated; the band center frequency can be specified in the "Freq Mode" parameter field. If the generator sweep system is also deactivated, START , SINGLE and STOP/CONT affect the measurement system:
- START starts a continuous measurement,
 - SINGLE starts a single measurement or continues an already started continuous measurement as a single measurement.
 - STOP/CONT interrupts an ongoing measurement or continues an interrupted or terminated measurement as a continuous measurement.
- "Auto Sweep" The bandpass sweep / bandstop sweep is activated; the sweep stepping is performed automatically; the sweep axis is calculated from the start value, stop value and step size or point number.
- "Auto List" The bandpass sweep / bandstop sweep is activated; the sweep stepping is performed automatically; the sweep axis is determined from the predefined list of sweep points (usually loaded as a file).

Remote command:

[SENSe<n1>:SWEep:CONTrol](#) on page 933

Spacing

Used to select the sweep range spacing, i.e. the way in which the sweep points are distributed on the sweep axis. Only visible for activated bandpass / bandstop sweep.



- "Lin Points" The sweep range is divided linearly by specifying a number of points (linear sweep). This number is entered in the "Points" parameter field. Should be selected if equidistant, linear spacing of all points is required.
- "Lin Steps" The sweep range is divided into intervals of a specified linear step size starting at "Start" (linear sweep). This step size is entered in the "Step" parameter field.
- "Log Points" The sweep range is divided logarithmically by specifying a number of points (logarithmic sweep). This number is entered in the "Points" parameter field. Should be selected if equidistant, logarithmic spacing of all points is required.
- "Log Steps" The sweep range is divided into intervals of a specified logarithmic step size starting at "Start" (logarithmic sweep). Each sweep point is calculated by multiplying the previous point by a constant factor. This factor is entered in the "Step" parameter field.

Remote command:

[SENSe<n1>:SWEep:SPACing](#) on page 933

Start

Used to enter the start value for the bandpass / bandstop center frequency. Only visible for activated bandpass / bandstop sweep.

Start	20000.0	Hz
-------	---------	----

The start and stop value implicitly determine the sweep direction:

If the start value is less than the stop value, an upward sweep is performed, otherwise a downward sweep will be performed.

If a start value identical to the stop value is entered, the stop value is automatically loaded with the old start value. In this way, it is possible to change the sweep direction by entering just one value.

Remote command:

[SENSe<n1>:SWEep:START](#) on page 934

Stop

Used to enter the stop value for the bandpass / bandstop center frequency. Only visible for activated bandpass / bandstop sweep.

Stop	20.0000	Hz
------	---------	----

The start and stop value implicitly determine the sweep direction:

If a stop value identical to the start value is entered, the start value is automatically loaded with the old stop value.

Remote command:

[SENSe<n1>:SWEep:STOP](#) on page 934

Points

Used to enter the number of sweep points for the bandpass / bandstop center frequency. Only visible for activated bandpass / bandstop sweep if "Lin Points" or "Log Points" is set for "Spacing".

Points	30
--------	----

The sweep range is divided into "Points – 1" (linear or logarithmic) equidistant steps. At least 2 points (start and stop value) are required.

A maximum of 1024 points can be selected.

Remote command:

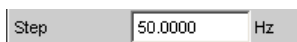
[SENSe<n1>:SWEep:POINTs](#) on page 933

Step

Used to enter the (linear or logarithmic) step size for the bandpass / bandstop center frequency. Only visible for activated bandpass / bandstop sweep if "Lin Steps" or "Log Steps" is set for "Spacing".

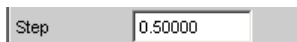
The entry range is limited automatically so that at least one and at most 1023 steps exist (corresponding to 1024 sweep points).

With linear step, the size of the step must always be entered, i.e. the numeric value is positive even if the start value is greater than the stop value. The physical unit is the same as that used when specifying "Start" and "Stop".



(Example for lin. frequency sweep)

With logarithmic step, the factor must be entered by which each sweep point is to be multiplied in order to move to the next sweep point. Swapping the start and stop value (reversal of the sweep direction) therefore produces the reciprocal value. The closer the numeric value is to 1.0, the more sweep steps will be performed.



(Example for log. upward sweep)

Note: Since the last step of the sweep is automatically adapted such that it corresponds exactly to the stop value, it may deviate by max. 50% from the selected step size. If this is to be avoided, either the start / stop value must be corrected accordingly or the sweep spacing must be set using the "Points" parameter.

Remote command:

[SENSe<n1>:SWEep:STEP](#) on page 934

File Name

Entry of the file name for the list of bandpass/bandstop center frequencies (frequency sweep list). Only visible if bandpass / bandstop list sweep is activated.



Remote command:

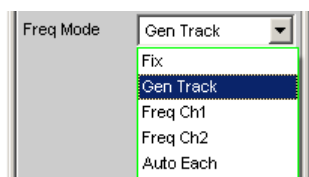
[MMEMory:LOAD:FREQuency:SLCFrequency](#) on page 932

Freq Mode

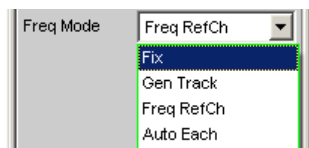
Used to determine the bandpass / bandstop center frequency.

In the two channel analog analyzer, this field is used to determine the notch frequency of the analog notch filter (which can be enabled if required).

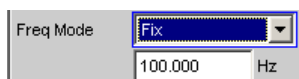
Two-channel analyzer:



Multichannel analyzer:



"Fix" Fixed bandpass / bandstop center frequency – in the two channel analog analyzer, also the notch frequency if notch is activated. The center frequency must be entered in the parameter field below.



Note: For infrasound measurements, the center frequency can be reduced down to a sampling rate/48000 (but at least 1 Hz). As very long filter settling times occur in the range below 10 Hz, measurement results can only be viewed after several seconds.

"Gen Track" The bandpass/bandstop center frequency – in the two-channel analog analyzer, also the notch frequency if notch is activated – changes with the generator (nominal) frequency. This can be changed by means of manual entry in the Generator Function panel or owing to a generator frequency sweep. If the internal stereo generator is used, on two-channel analyzers measurement channel 1 tracks generator channel 1 and measurement channel 2 tracks generator channel 2. On multichannel analyzers, all measurement channels track generator channel 1.

By entering a factor in the next parameter field, the user can select whether the center frequency is to be identical to the generator frequency (factor = 1) or a multiple of the generator frequency. Setting a whole number for this factor will allow individual harmonics to be measured.

Note: If the Low Distortion Generator option is used, "Gen Track" should be avoided on account of the rigid coupling to the generator's nominal frequency, otherwise measuring inaccuracy resulting from slight frequency offset could occur.

An error message is output if an unsuitable signal function is selected in the generator (e.g. a multi-tone signal or noise signal).

Recommended for use with the internal R&S UPV Universal Generator.

"Freq Ch1" The bandpass/bandstop center frequency – in the two-channel analog analyzer, also the notch frequency if notch is activated – changes with the frequency measured in Channel 1; not available in the multichannel analyzers.

Recommended when using the low-distortion generator or an external signal source.

"Freq Ch2" The bandpass/bandstop center frequency – in the two-channel analog analyzer, also the notch frequency if notch is activated – changes with the frequency measured in Channel 2; not available in the multichannel analyzers.

Recommended when using the low-distortion generator or an external signal source.

- "Auto Each" In each channel the bandpass/bandstop center frequency tracks the measured frequency in the channel concerned, as does the notch frequency when notch is active in the two-channel analog analyzer. If one of the channels does not provide unambiguous frequency information - e.g. in the case of multitone or noise signals, or if there is no input signal - the measurement for this channel is marked as invalid. This does not have any negative impact on the measured value for the other (valid) channel, but the measurement time is considerably longer. In these cases, it is therefore advisable to use the appropriate mode for each situation: "Freq Ch1" or "Freq Ch2" for the two-channel analyzers, and "Freq RefCh" mode for multichannel analyzers. This is to be recommended when using an external stereo signal source.
- "Freq Ref Ch" The bandpass/bandstop center frequency tracks the frequency measured in the reference channel; only available in the multichannel analyzers.
Recommended when using the low-distortion generator or an external signal source.

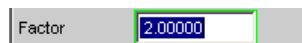
Remote command:

[SENSe<n1>:FREQuency:SElect](#) on page 933

[SENSe<n1>:FREQuency](#) on page 933

Factor

Used to enter the factor by which the center frequency of the bandpass filter or bandstop filter is to be higher than the generator frequency. Only visible in "Freq Mode Gen Track".



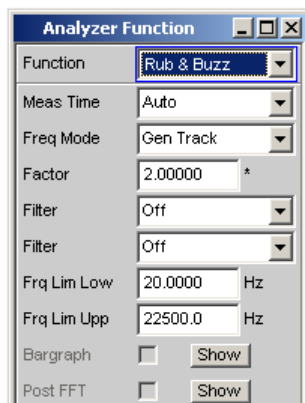
Setting an integer factor greater than 1 will therefore allow an individual harmonic to be measured. If the fundamental is to be selected, the factor must be set to 1.

Note: The factor does not affect the notch filter frequency. In "Freq Mode Gen Track", the notch filter is set to exactly the generator frequency without taking "Factor" into consideration, so that a higher dynamic response can be achieved by means of (analog) suppression of the fundamental irrespective of the measurement task.

Remote command:

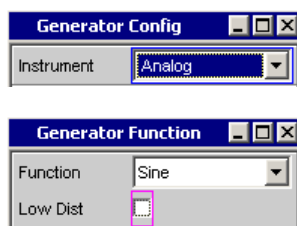
[SENSe<n1>:FREQuency:FACTor](#) on page 933

5.25.4 Rub & Buzz Measurement



This is an RMS measurement with a tracking highpass filter whose passband starts above a selectable harmonic of the signal frequency.

This measurement function can only be selected if the Option R&S UPV-K6 (Extended Analysis Functions) has been installed, and is only available in the two-channel analog analyzer. It is meaningful only if used in conjunction with the sine-wave signal of the internal universal generator. When you switch on the "Rub & Buzz" measurement function, the corresponding generator settings are made automatically:



The purpose of the "Rub & Buzz" measurement is to pinpoint manufacturing defects on (single) loudspeakers, which become apparent in the form of nonharmonic noise or harmonics with a high amplitude. THDN measurements are not suitable for this purpose, since loudspeakers free from defects also produce k_2 and k_3 harmonics. What is needed is a measurement function that suppresses not only the fundamental but also the first harmonics and measures the remaining signal.

Rub & Buzz measurement is made on one channel. The second channel then has to be connected to the device under test (microphone) as well if a polarity measurement is to be carried out; this uses the 2nd measurement channel's hardware. The Rub & Buzz measurement is usually swept. The sweep has to run from a low frequency to a high frequency (upward sweep). The generator is muted at the sweep end and during standing (single) measurement in order to protect the device under test and reduce the filter settling time for the first sweep point. For exceptional cases, the Rub & Buzz measurement can be made using a fixed frequency, such as if a critical frequency is known for a loudspeaker.

Rub & Buzz Optimization

"Frq Lim Low" should be set as high as possible to reduce the filter settling time. The concurrent highpass filter is varied only up to "Frq Lim Upp". The lower this frequency

is, the more sweep points can be processed using a fixed filter, thereby using less computing time. The waveform monitor should be activated for sweeps only if the polarity result is needed. A low start frequency improves the accuracy of the polarity measurement but increases the overall duration of the sweep. The bandwidth of the generator and analyzer should be 80 kHz if possible.

Polarity Measurement during Rub & Buzz

Reversed polarity in the loudspeaker can be determined using the polarity measurement. A generator sweep and the waveform monitor are switched on to activate it. Only standard mode and the "Trigger Source" "Gen Burst" are available for avoiding operating errors in the waveform. The "Trace Length" has to be selected so that it does not exceed $\frac{1}{4}$ of the signal period for the lowest sweep frequency. A value of 2 ms is suitable for start frequencies up to 125 Hz. The polarity result is displayed on channel 2 as a function measured value after the sweep start. The beginning of the sweep is shown in the waveform display as long as the traces are switched on. The actual measurement is done by counting the positive and negative samples of the recorded waveform trace. The result is distinctly positive or negative (1.0 polarity or -1.0 polarity) if only positive or only negative samples have been recorded. Otherwise it is $(nPos - nNeg) / nTot$, i.e. in the interval -1.0 to +1.0. Polarity detection is deemed sufficiently reliable if the value is > 0.5 , i.e. if there are three times more samples on one side than the other. Note: The filter settling time is limited to $\frac{1}{4}$ of its cycle duration for the first sweep point when polarity measurement is switched on.



An RMS measurement that takes into account the prefilter only can be performed with the level monitor function simultaneously with the "Rub & buzz" measurement. The polarity result is determined on the second unfiltered channel.

For more settings, see [chapter 5.25, "Level Measurements"](#), on page 463.

SCPI command:

`SENSe[1]:FUNCtion RUBBuzZ`

Meas Time

Used to select the measurement time to match the measurement speed to the signal frequency.

In most cases – especially with sweeps – selecting "Gen Track" is recommended, since the "Rub & Buzz" measurement requires the use of the internal function generator.

With the automatic measurement modes, the measurement time is adapted to the (measured) signal frequency, provided that an AC signal is detected that is sufficiently strong and whose frequency is not too low ($f \geq 10$ Hz). However, since the fundamental is filtered out, these measurement modes are meaningful only in exceptional cases, e.g. where modification of the generator frequency cannot be accepted, such modification being unavoidable with "Gen Track".

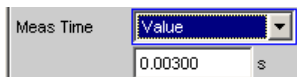
- "Auto Fast" The "Rub & Buzz" measurement is performed, as far as possible, over complete AC periods of the strongest harmonic detected. With high frequencies, the measurement time is extended so that the maximum algorithmic error does not exceed 1 %. With very weak, low-frequency or pure DC signals, the maximum measurement time is limited to 100 ms (corresponding to 1 period at 10 Hz).



- "Auto" The "Rub & Buzz" measurement is performed, as far as possible, over complete AC periods of the strongest harmonic detected. With high frequencies, the measurement time is extended so that the maximum algorithmic error does not exceed 0.05 %. With very weak, low-frequency or pure DC signals, the maximum measurement time is limited to 200 ms (corresponding to 2 periods at 10 Hz).



- "Value " The "Rub & Buzz" measurement is performed for a fixed period of time, which is to be entered in the next parameter field.



This option is recommended for measurement tasks in which a modification of the generator frequency cannot be accepted, such modification being unavoidable with "Gen Track". The longer the measurement time, the more accurately the measurement results can be determined for "Rub & Buzz" and, optionally, for the level monitor RMS.

- "Gen Track" The RMS measurement is performed over (at least) 1 whole period of the generator signal; if necessary, the generator frequency is adapted to the sampling rate of the analyzer to do so. In the case of high frequencies, the measurement time is extended to several periods in order to increase the measurement accuracy.



When used with the R&S UPV Universal Generator, this measurement mode provides the highest measurement accuracy and a very short measurement time.

Recommended setting for the "Rub & Buzz " measurement, because the R&S UPV Universal Generator is generally used as the signal source.

Remote command:

[SENSe<n1>:FUNction:APERture:MODE](#) on page 930

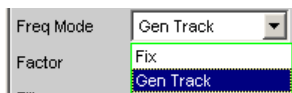
[SENSe<n1>:VOLTage:APERture](#) on page 931

Freq Mode

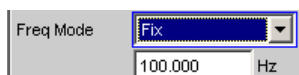
Used to define the highpass filter frequency or band.

It can either

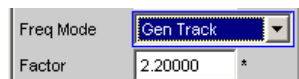
- be set to a fixed frequency,
- The highpass filter can track the generator with n times the generator frequency.
- A combination of the above can be selected. This is done by defining a tracking range by entering an upper and a lower frequency; outside this range, the pass frequency of the filter is maintained at the respective limit frequency.



"Fix" Use of a highpass filter with a fixed pass frequency, which is to be entered in the next menu line.



"Gen Track" Use of a tracking highpass filter whose pass frequency follows a multiple of the generator (nominal) frequency, which is to be entered in the next menu line.



Moreover, the frequency limits for the tracking range can be selected. On attaining the lower or upper limit (FrqLim Low or Upp), the filter frequency is maintained at the limit frequency. This yields a tracking highpass filter that becomes a fixed-frequency highpass filter below FrqLim Low and above FrqLim Upp.

If the filter is to act as a tracking filter over the entire frequency range, the frequency limits are to be set to the minimum and maximum values.

Remote command:

[SENSe<n1>:FREQuency:SELeCt](#) on page 933

Factor

Used to enter the factor by which the pass frequency should be higher than the generator frequency. Meaningful values for "Rub & Buzz" measurements would be around approx. 5. The factor is visible only under "Freq Mode: Gen Track".



If the product of the generator frequency and the factor attains the value of FrqLim Upp, the highpass filter becomes a fixed-frequency filter operating at the upper limit frequency, then non Rub & Buzz measured value is being determined. Any other measurement performed simultaneously (e.g. frequency response measurement with the level monitor function) is carried out at a correspondingly higher speed.

Remote command:

[SENSe<n1>:FREQuency:FACTor](#) on page 933

Frq Lim Low

Lower limit of the highpass filter tracking range. Can be displayed only under "Freq Mode: Gen Track".

Frq Lim Low Hz

If the product of the generator frequency and the factor is lower than the limit entered here, the pass frequency of the highpass filter is set permanently on this value.

This limit has no effect on the calculation of the "Rub & Buzz" value.

Remote command:

[SENSe<n1>:FREQuency:LIMit:LOWer](#) on page 938

Frq Lim Upp

Upper limit of the highpass filter tracking range. Can be displayed only under "Freq Mode: Gen Track".

Frq Lim Upp Hz

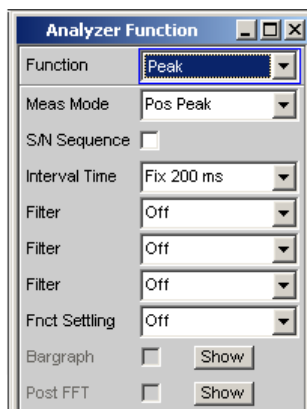
If the product of the generator frequency and the factor is higher than the value entered here, the pass frequency of the highpass filter is set permanently on this value.

This limit has no effect on the calculation of the "Rub & Buzz" value.

Remote command:

[SENSe<n1>:FREQuency:LIMit:UPPer](#) on page 938

5.25.5 Peak Measurement



Measurement of the peak value of any given signal, and the rise and fall of the measured value all occur without a delay. The measured value contains both AC and DC components.

SCPI command:

[SENSe\[1\]:FUNCtion](#) PEAK

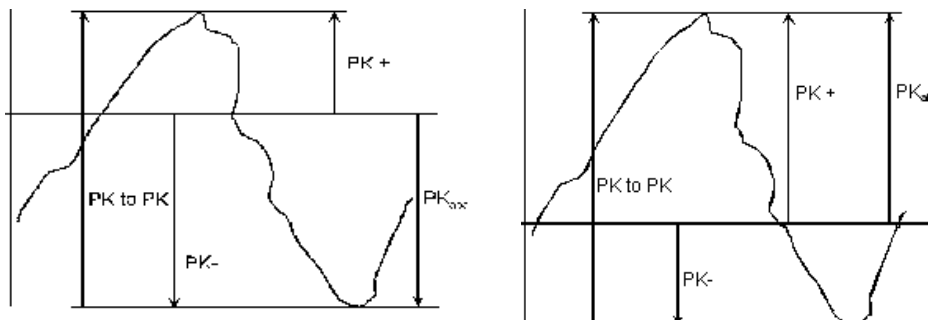
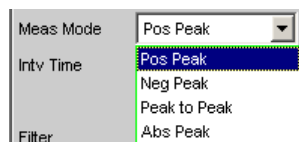


If a square wave is applied, it is limited with respect to bandwidth by the upper measurement limit of the selected analyzer, and overshoots occur at the edges (Gibbs phenomenon). The overshoots are also measured during the peak analysis, which means that the returned measured value may be greater than the input peak. FS values greater than 1 may be measured, especially in the digital range.

For more settings, see [chapter 5.25, "Level Measurements"](#), on page 463.

Meas Mode

Used to select the measurement mode.



Result of Peak measurement on 2 example signals depending on selected measurement mode

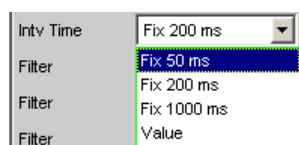
- "Pos Peak" The highest positive voltage value is measured.
- "Neg Peak" The (numerically) highest negative voltage value is measured.
- "Peak to Peak" The difference between the highest and lowest level is measured (peak-to-peak voltage).
- "Abs Peak" The numerically highest (positive or negative) voltage value is measured.

Remote command:

`SENSe<n1>:FUNction:MMODE` on page 931

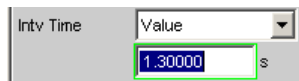
Intv Time

Used to select the measurement interval within which the peak search is to be performed. When the interval time has expired, the peak value memory is reset and the next peak value is sought.



- "Fix 50 ms" Measurement interval 50 ms.
- "Fix 20 ms" Measurement interval 200 ms.
- "Fix 1000 ms" Measurement interval 1000 ms.

"Value " The interval time is entered in the parameter field below.



Note: If a multichannel analyzer is used, max. 1.44 million samples can be observed. In these analyzers, the maximum measurement time is therefore dependent on the sampling rate or the analog bandwidth; for example, for a 40 kHz analog bandwidth it is 15 s. If a longer measurement time is needed, the measurement must be carried out with one of the two-channel analyzers (up to 100 s).

Remote command:

[SENSe<n1>:VOLTage:INTVtime:MODE](#) on page 934

[SENSe<n1>:VOLTage:INTVtime](#) on page 934

5.25.6 Quasi Peak Measurement

Measurement of the peak value of any given signal, and the rise and fall of the measured value, all occur with defined time constants. The measurement is implemented as an RFI voltage measurement to CCIR 468-4 and DIN 45405.

Due to the constants for rise time and fall time, the measured quasi peak value is frequency-dependent. The displayed level is adjusted internally to 1 kHz sinusoidal, that is, in the settled state the quasi peak value at this frequency corresponds to the measured value of a RMS measurement.



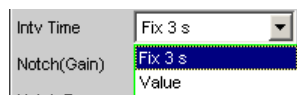
This measurement requires uninterrupted monitoring of the measurement signal over an extended period of time. It is not meaningful to carry out this kind of measurement with a multichannel analyzer, which only performs short, single measurements. It is therefore only available with two-channel analyzers.

For more settings, see [chapter 5.25, "Level Measurements"](#), on page 463.

SCPI command: [SENSe\[1\]:FUNCTION QPEak](#)

Intv Time

Used to select the measurement interval within which the Quasi Peak measurement is to be performed. Once this interval has expired, the peak hold is deleted and the next peak value is determined, starting with the instantaneous value.



"Fix 3 s" Measurement interval 3000 ms.

"Value " The interval time is entered in the parameter field below.

The image shows a control panel with two fields. The first field is labeled 'Intv Time' and has a dropdown menu with 'Value' selected. The second field is a text input box containing the number '4.00000' followed by a small 's' for seconds. The text input box is highlighted with a green border.

Note: In order to obtain settled measured values, the measurement time for triggered measurements and sweeps should not be less than 3 seconds.

Remote command:

[SENSe<n1>:VOLTage:INTVtime:MODE](#) on page 934

[SENSe<n1>:VOLTage:INTVtime](#) on page 934

5.25.7 DC voltage measurement

Measurement of the DC voltage component of an analog or digital signal. The "DC measurement" is not a separate measurement function, but a measurement method that can be selected under "Level Monitor"). This makes it possible to perform any other desired measurement function at the same time as a DC level measurement, see "Level Monitor" on page 613

The level is acquired at the Monitor level, which means after the prefilter and the analog notch filter that can optionally be switched on (in the two-channel analog analyzer).

The measurement is performed using zero-crossing detection to eliminate the level component of any superimposed periodic AC signal that may be present. As a result, the measurement time is not constant, but instead is an integer multiple of the period of the superimposed AC signal.

In the case of very weak signals or signals with no AC component, the upper measurement time limit is 100 ms.

If "DC" is selected as a measurement function, a reference to the Level Monitor is shown and the previously configured measurement function is maintained.

Remote control command:

[SENSe6:FUNCtion](#) DC

5.26 Signal-to-Noise Measurements

The R&S UPV provides signal-to-noise measurements ("", "S/N measurements") according to a number of different weighting methods. Each of these measurement functions measures the level with and without a signal: For measurement of the signal the set generator signal is output; for noise measurement the generator signal is turned off and the noise level of the DUT is measured. The measured signal-to-noise ratio is displayed as the measurement result.

The S/N sequence consists of two complete level measurement cycles that are performed and displayed independently of one another.

- The measured values for level monitor, input monitor, post FFT and waveform are displayed for signal measurement first, and then for noise measurement.

- The frequency and phase are measured only during signal measurement. The measured values remain unchanged during noise measurement.
- The result of the function can be determined only at the end of noise measurement. In continuous measurement mode the display shows the latest valid result or "---" during signal measurement.

The internal generator (universal or low distortion) must be used during noise measurements, since an external generator cannot be controlled by the measurement function. If the DUT is inadvertently not connected to the internal generator, measured values of around 0 dB would be determined.

The signal for noise measurement is generated by an analog or digital generator depending on the DUT:

- In the case of an analog generator instrument, the generator output voltage is switched off and the output impedance remains unchanged.
- In the case of digital generator instruments, a level value of 0.0 fullscale is output with an unchanged clock rate (all bits on 0).



If the analog universal generator is used, care must be taken to ensure that the correct Volt Range is selected on the Generator Config Panel (see [chapter 5.2.1, "Analog Generator Config Panel"](#), on page 238). In Auto mode the analog gain is canceled during noise measurement, which on the one hand brings about an improvement in the inherent noise (and therefore in the S/N dynamic response), but on the other hand results in a longer measurement time.

The level weighting method can be chosen from the following:

- RMS: Root-mean-square broadband measurement
- Peak: Peak-value measurement.
- "Quasi Peak": peak-value measurement with quasi-peak weighting; that is, measured values rise and fall with defined time constants.

When the analog analyzer is used, switching off the generator causes a DC jump at the analyzer input, and this must not be allowed to affect the highly sensitive noise measurement.

There are two measures which will solve this problem:

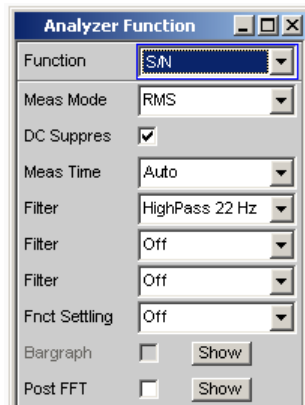
- The S/N measurement should preferably be carried out using a low-frequency highpass or comparable weighting filter. Failing to use a suitable filter will result in an error message.
- For measurement at low frequencies, where a highpass filter cannot be used, the recommended alternative is a file-defined delay filter with around 1.5 s of delay. This allows the DC jump to decay before the noise measurement starts.

S/N measurement can be performed via the S/N measurement function. This measurement function is found at menu item "Meas Mode" and offers a choice of level weighting methods.

Conversely it is also possible, as in the case of the earlier instruments R&S UPD and R&S UPL, to activate the S/N sequence during level measurements. This alternative

operating mode ensures compatibility with the earlier models mentioned, and in particular enables remote-control programs to be used unchanged.

5.26.1 S/N Measurement Function



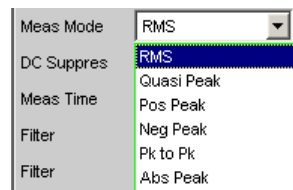
Measurement function for determining the signal to noise of a DUT.

SCPI command: `SENSe[1]:FUNction S/N`

For more settings, see [chapter 5.25, "Level Measurements"](#), on page 463.

Meas Mode

Used for choosing the level weighting method for signal and noise measurement.



"RMS"	Both level measurements are carried out in the form of broadband RMS measurements.
"Quasi Peak"	Both level measurements are carried out in the form of peak value measurements with the aid of a quasi peak rectifier, that is, the level measured value tracks the signal trace using defined rise and fall times.
"Pos Peak"	Both level measurements are carried out in the form of peak value measurements of the highest positive level.
"Neg Peak"	Both the level measurements are carried out in the form of peak value measurements of the highest negative level
"Pk to Pk"	Both level measurements are carried out in the form of peak to peak measurements
"Abs Peak"	Both the level measurements are carried out in the form of peak value measurements of the absolute magnitude of the highest level.

Remote command:

`SENSe<n1>:FUNction:MMODE` on page 931

DC Suppress

Used to activate DC suppression (in the digital analyzer only).



You can decide whether any DC level which may be present in the RMS value should be taken into account or suppressed.

This parameter field is not available in the analog analyzer because the suppression function is already provided by the AC coupling which can be set up using the hardware.

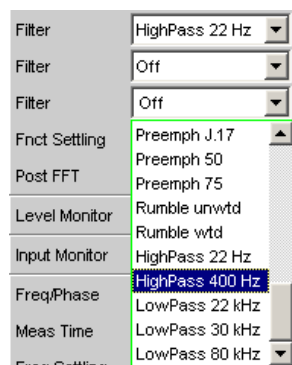
- | | |
|---------------|--|
| "deactivated" | DC suppression deactivated.
The DC component of the measurement signal is not suppressed ("DC coupling") and is included in the measurement result. |
| "activated" | DC suppression activated.
The DC component of the measurement signal is suppressed ("AC coupling"); the measurement result includes the AC component only.
For DC suppression in the digital analyzer, the DC level is measured and subtracted from the total RMS value. |

Remote command:

`SENSe<n1>:FUNCtion:DCSuppression` on page 935

Filter

Activating a digital filter in the test channel. Up to three user-defined or weighting filters can be looped into the test channel. At least one of the three filters in the analog analyzer should be a highpass or comparable weighting filter in order to filter out the DC jump when the generator is turned off. For this purpose, HighPass 22 Hz is activated in Filter #1 by default.



The user-definable filters are configured as filters 01 to 09 in the filter panel (see [chapter 5.44, "User-Definable Filters"](#), on page 628) and can then be used (repeatedly if necessary) in the analyzer.

For a description of selectable weighting filters, see [chapter 5.45, "Weighting Filters"](#), on page 637.

The filters chosen in this way work during noise measurement only. During signal measurement they are bypassed. This makes it possible to apply a deliberate weighting to the noise signal without affecting the other signal level.

Note: The input filter "prefilter" in the configuration part of the analyzer affects both signal measurement and noise measurement. Thus if there is a need for a filter that also

filters the signal component, it can be chosen as a prefilter. Moreover the analog bandwidth can be restricted with the aid of the "Bandwidth" parameter field, which corresponds to an additional lowpass filter.

Remote command:

`SENSe<n1>:FILTer<n2>` on page 958

For a description of the filters and their setting parameters, see [chapter 5.43.4, "Filter Table"](#), on page 628.

Meas Time

This is used for choosing the measurement time for the purpose of adapting the measurement speed to the waveform or, in the case of single tone signals, to the signal frequency.

The priority can be set to a short measurement time or high accuracy depending on specific measurement requirements.

In automatic measurement modes the measurement time is adapted to the measured signal frequency, provided an AC signal that is sufficiently strong and not too low in frequency is present ($f \geq 10$ Hz).

Note: With severely noise-corrupted or distorted signals and multi-tone signals, the automatic measurement modes (especially "Auto Fast") may no longer be able to clearly detect the signal period. For the avoidance of measurement errors, such signals should therefore preferably be measured using "Gen Track" or "Value".

"Auto Fast"

For use with the RMS measurement mode only.

Level measurements are performed as far as possible over whole AC periods. In the case of high frequencies, the measurement time is extended so that a maximum algorithmic error of 1 % is not exceeded.

In the case of low-noise DUTs the upward measurement time for noise measurement is limited to 100 ms (corresponding to 1 period at 10 Hz).



This setting is recommended when the excitation (in signal measurements) is a single tone signal, particularly when the low-distortion generator is being used, if the aim is to achieve the highest measurement speed.

"Auto" For use with the RMS measurement mode only. Level measurements are performed as far as possible over whole AC periods. In the case of medium or high frequencies, the measurement time is extended so that a maximum algorithmic error of **0.05 %** is not exceeded. In the case of low-noise DUTs, the upper measurement time is limited to 200 ms (corresponding to 2 periods at 10 Hz).



This setting is recommended when the excitation (in signal measurements) is a single tone signal, particularly when the low-distortion generator is being used, if the aim is to achieve the highest measurement accuracy.

"Gen Track" For use with the RMS measurement mode only. Level measurements are performed over at least 1 whole period of the generator signal. For this purpose the generator frequency is adapted as necessary to the sampling rate of the analyzer. In the case of high frequencies, the measurement time is extended to several periods in order to increase the measurement accuracy.



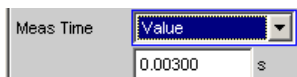
This setting is recommended when the excitation (in signal measurements) is a single tone signal and the R&S UPV Universal Generator is used.

Note: If the Low Distortion Generator option is used, "Gen Track" should be avoided on account of the rigid coupling to the generator's nominal frequency, otherwise measuring inaccuracy resulting from slight frequency offset could occur.

Note: If "Stereo Sine" is used as the generator signal, measurement channel 1 tracks generator channel 1 and measurement channel 2 tracks generator channel 2.

Note: If "Arbitrary" is used as the generator signal, the measurement time is synchronized to the number of samples in the loaded file. As a result, measurement is always performed over a complete period of the (repeatedly output) ARB signal.

"Value " Measurement is performed inside a predefined time which has to be entered in the following parameter field.



In order to **avoid** errors caused by the termination of measurements, the chosen measurement time should be an integer multiple of the period and, due to the noise measurement, should not be too short. In Quasi Peak measurement mode, the measurement time should not be significantly less than 3 s because of the long rise time constants. This setting is recommended when the excitation (in signal measurements) consists of noise signals or multitone signals.

"Fix 50 ms"	For use with peak measurement modes only The measurement time is 50 ms.
"Fix 200 ms"	For use with peak measurement modes only The measurement time is 200 ms.
"Fix 1000 ms"	For use with peak measurement modes only The measurement time is 1000 ms.
"Fix 3 s"	For use with the "Quasi Peak" measurement mode only 3000 ms is the recommended measurement time for quasi peak measurements.

Remote command:

[SENSe<n1>:FUNctIon:APERture:MODE](#) on page 930

[SENSe<n1>:VOLTage:APERture](#) on page 931

5.26.2 S/N Sequence in Level Measurements

In order to ensure compatibility with the previous models R&S UPD and R&S UPL, the R&S UPV also has the capability of activating the S/N sequence in level measurements; as a result, particularly remote control programs can still be used without any modifications.

For more settings, see [chapter 5.25, "Level Measurements"](#), on page 463.

S/N Sequence

Used for activating the S/N sequence in order to determine the signal to noise.

Signal-to-noise measurement can thus be performed in the "RMS", "Peak" and "Quasi Peak" level measurement modes.

"deactivated"	The S/N sequence is disabled. A pure level measurement is carried out.
"activated"	The S/N sequence is enabled Level measurement is performed with the generator signal switched on and then with it switched off. The S/N measurement result is determined from this.

Remote command:

[SENSe<n1>:FUNctIon:SNSequence](#) on page 936

5.27 Distortion Measurements

The R&S UPV provides various methods for measuring distortions. These methods can be used to determine harmonic or intermodulation distortions of a DUT.

The measurement signals required in each case can be generated by the internal generator (recommended) or by an external signal source.

- **THD** (total harmonic distortion) is a distortion measurement over the first 8 harmonics or over any given combination of the first 8 harmonics. The noise between the

harmonics is not measured. An ultra-pure sine-wave signal is required as the measurement signal.

- **THD+N & SINAD** (total harmonic distortion + noise) is a distortion measurement that measures the energy of the broadband noise **and** (optionally) of all harmonics within a selectable frequency band. An ultra-pure sine-wave signal is required as the measurement signal.
- **Mod Dist** is a modulation factor analysis that determines the total intermodulation factor of the 2nd **and** 3rd order of a low-frequency interfering signal to a high-frequency useful signal. The interfering signal should have the same or a higher amplitude than the useful signal (preferably an amplitude ratio of 4 : 1).
- **DFD** is a difference-tone factor analysis that determines the 2nd and 3rd order intermodulation products generated by two sine-wave signals of the same amplitude.
- **DIM** is a dynamic intermodulation measurement for which a low-frequency square-wave signal and a sine-wave signal of a higher frequency are used.



The individual distortion components can be assessed visually using the bar graph or (Post) FFT, see also [chapter 5.30.3, "Post FFT"](#), on page 529.



The measured values can only have the full dynamic range if both the signal source and the analyzer are at full-scale level. If the measured values are worse than expected, the following rules should be checked and observed.

- The **digital generator** should use all available audio bits; the (overall) signal should have a level of 1.0 FS and as little dither as possible.
- The **analog analyzer** should be operated in the optimum range, preferably in the "Auto" mode. If the "Fix" or "Lowest" mode is used, it is important to ensure that the selected range is not significantly higher than the applied total voltage.

The individual distortion components (harmonics or intermodulation products) and thus the distortion measured values are calculated using FFT. The FFT value is automatically adapted to the measurement signal. The longer the required FFT, the longer the necessary integration time and therefore the longer the total measurement time. You can choose the **minimum** FFT value when Post FFT is enabled:

Min FFT Size	16 k
Window	0.5 k
Level Monitor	1 k
Input Monitor	2 k
	4 k
	8 k
Freq/Phase	16 k
	32 k
Meas Time	64 k
Freq Settling	128 k
FFT Monitor	256 k

By increasing the minimum FFT value you can increase the ratio of measurement accuracy to measurement speed loading, since the distortion components are then measured in a narrower band.

If the selected FFT value is not large enough to capture the measurement signal, increase the FFT gradually by a factor of 2.

The maximum FFT value depends on the bandwidth or sampling rate:

- at a 22 kHz bandwidth (analog) the FFT value can be increased to a maximum of 64 k,
- at sampling rates of less than 50 kHz (digital) or at a 40 kHz bandwidth (analog) the FFT value can be increased to a maximum of 128 k,
- at sampling rates of greater than 50 kHz (digital) or at an 80 or 250 kHz bandwidth (analog) the FFT value can be increased to a maximum of 256 k,

The maximum integration time in the analog analyzer (fast mode) is therefore around 1.4 s.

5.27.1 General Settings

This chapter contains the settings that occur in a number of distortion measurements where they have the same meaning.

Dynamic Mode

Adapting the achievable dynamic range to the quality of the DUT. Only available in the two-channel analog analyzer; the digital analyzers and the multichannel analog analyzers always perform measurements with the full dynamic range (without any reduction in speed).



When measurements are performed with a higher dynamic range (**Precision**), the measurement time gets longer. Conversely, with a short measurement time (**Fast**) the full dynamic range of the R&S UPV analyzer is not used to the full. The decision as to whether a fast measurement would be sufficient or whether a precision measurement is required should therefore be made depending on the DUT (by comparing the fast and precision measurements). If the measured value from the precision measurement is not better than that from the fast measurement, the user can decide against a high dynamic range in favor of a shorter measurement time.

Note: Since notch measurement is not meaningful for dynamic intermodulation measurement (DIM) or for 3rd order (d3) difference frequency distortion (DFD) analysis, it is not made available.

"Fast"



A fast measurement with low dynamic range is performed (fast measurement).

This is recommended in the case of signals with poor dynamic response (less than 30 dB).

It is necessary when measuring total harmonic distortion in signals with fundamentals higher than 115 kHz.

"Prec"

A precision measurement with maximum dynamic range but a longer measurement time is performed.

Following preliminary measurement to determine the fundamental frequency and the total level (in the case of total harmonic distortion measurements) or the single signal components (in the case of intermodulation measurements), the main measurement is performed with activated analog filter and post-gain of the residual signal (to increase the dynamic range).

The analog filter reduces the modulation of the fed-in signal components to make it possible to amplify the residual signal to be measured without the danger of overloading.

Either a notch filter (for narrowband suppression of the harmonic with total harmonic distortion measurements or of the dominant interfering signal with Mod Dist) or a lowpass filter (for suppressing the dual tone in the case of DFD d2) is used as analog filter.

The total measurement time is just over twice that required for the "Fast" dynamic mode.

Note: When measuring total harmonic distortion (THD and THD+N), precision measurements with fundamentals higher than 115 kHz are identified as invalid because the notch filter does not work in this frequency range. Fast mode must then be used for such measurements.

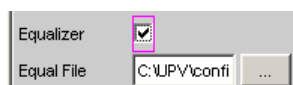
Note: If the dynamic range of the measurement signal (including any out-of-band signals) is lower than 30 dB, the post-gain is reduced incrementally to 12 or 0 dB to prevent overranging. This "notch-ranging" once again increases the measurement time; the measured value is, however, no more accurate than that obtained using the "Fast" measurement. The "Fast" dynamic mode should therefore be selected in such cases.

Remote command:

`SENSe<n1>:FUNction:DMODE` on page 931

Equalizer

Used for activating/deactivating a precorrector table for the FFT bins.



In this way, the frequency response of a transmission link can be precorrected, for example, and in so doing the measurement point is transformed into another reference point.

When precorrection is enabled, the computed FFT bins are multiplied by a frequency-dependent factor, after which they are used to calculate the distortion measurement and applied to the display.

The factor is determined by interpolation between the two adjacent frequency reference points in the precorrector table.

Precorrection of the FFT spectrum is an attractive alternative to filtering the input signal, since the precorrector file can simply be generated from the frequency response requiring precorrection and need not be in the form of a coefficient file or pole/zero file.

Application:

In acoustic measurements (e.g. with mobile telephones) on artificial ears of type 3.2 or higher, it is possible to compensate for the transfer function ERP (ear reference point) to DRP (drum reference point). Measurement of the sound waves by the microphone applied to the "eardrum" can thus be referred to the required measurement point (at the auricle).

Note: The precorrector table is created after acquiring or reading in the trace data from the DUT in the "DispConfig" panels.

- | | |
|---------------|---|
| "deactivated" | The precorrector is disabled. The FFT bins are used and displayed without change. The measured value is calculated from the original FFT spectrum. |
| "activated" | The precorrector is enabled. The next entry field, which is "Equal File", for the file name of the precorrector table, is activated and the file shown there is loaded. The measured value is calculated from the precorrected FFT spectrum. |

Remote command:

[SENSe<n1>:VOLTage:EQualize](#) on page 937

[MMEMory:LOAD:IEQualize](#) on page 936

Bargraph

Used for activating bargraph computation and display. In addition the "Bargraph1" window can be opened from here.



Configuration of the bargraphs is reserved for the "Bargraph1 Config" and/or "Bargraph2 Config" windows. The actual display takes place in the "Bargraph1" or "Bargraph2" windows.

Note: When measuring total harmonic distortion "(THD+N & SINAD)" there is no point in having a bargraph display, since the measurement does not involve discrete harmonics but rather the entire harmonic spectrum complete with noise. Therefore "Bargraph" is not available and the graph is not updated.

- | | |
|---------------|--|
| "deactivated" | Bargraph computation (and update) disabled.
Recommended for increasing the measurement speed (e.g. for sweeps or remote control). |
| "activated" | Bargraph computation (and update) enabled. The remaining settings dynamically define the associated measurement function. |

Remote command:

[SENSe<n1>:FUNCTion:BARGraph](#) on page 936

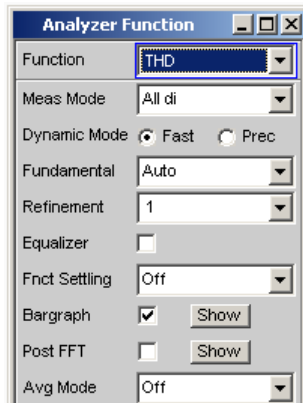
Post FFT

Activation of the Post FFT; furthermore, the graphics window "FFT Graph1" can be opened from here.



For details, see [chapter 5.30.3, "Post FFT"](#), on page 529.

5.27.2 THD



THD (total harmonic distortion) is a measurement of distortion over the first 8 harmonics or over any combination of the first 8 harmonics (d2 to d9), wherein the amplitudes of the individual harmonics amplitudes are measured selectively. The root from the square sum of the harmonics can be displayed either as an RMS or as a ratio to the total RMS. Unlike with THD+N & SINAD measurement, the noise between the harmonics is **not** measured.

An ultra-pure sine-wave signal is required as the measurement signal. The selected frequency of this sine-wave signal should be such that the significant components of the distortion spectrum are still below the upper measurement limit.

If the first harmonic lies above the set IF bandwidth, an error message appears in the user info line and the measured value is identified as invalid (---).

The "sine" signal function of the internal generator is recommended as the **signal source**. If the optional low-distortion generator is available, it should be activated for measurements on low-distortion DUTs. The sine-wave level and frequency can be varied or swept.

SCPI command:

`SENSe[1]:FUNCtion THD`

For alternative distortion measurement, see [chapter 5.27.3, "THD+N & SINAD"](#), on page 504.

For more distortion measurements, see [chapter 5.27, "Distortion Measurements"](#), on page 494.

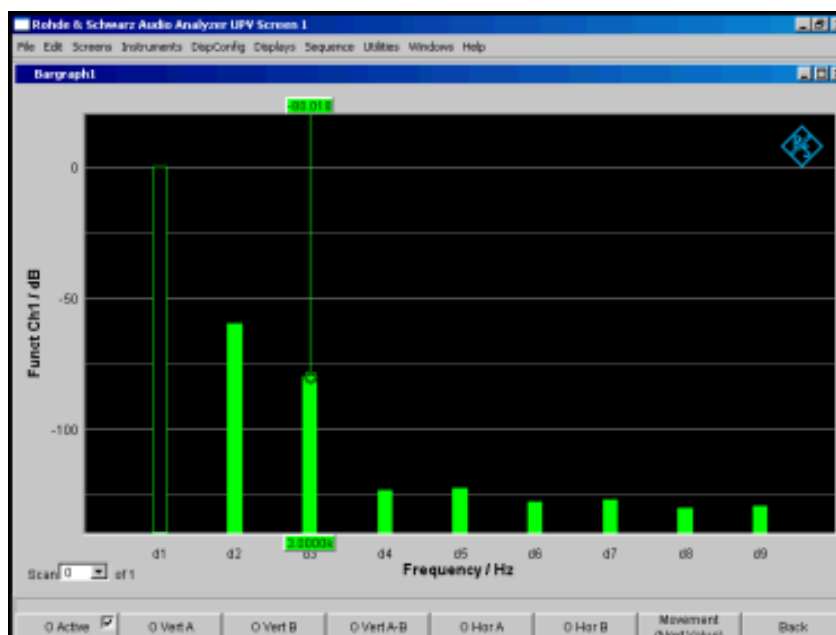
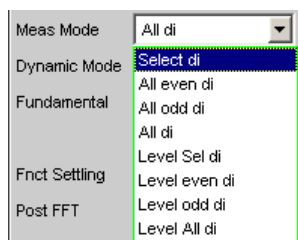


Fig. 5-25: THD measurement of a 1 kHz sine-wave signal with two harmonics of -60 dB and -80 dB

Meas Mode

Used to select the harmonics to be taken into consideration in the THD measured value and to select the calculation formula for the measured value.



Note: All 8 harmonics – and the fundamental – are always displayed in the graph irrespective of the selected measurement mode.

The term **Level** indicates that the measurement result is displayed as an RMS value and is **not** relative to the total RMS value (as is customary with distortion measurements).

"Select di" The distortion of any given combination of harmonics d2 to d9 (root from the square sum of the selected harmonics) is measured **relative** to the total RMS value.

$$U_{THD} [dB] = 20 \cdot \log \frac{\sqrt{U_{d2}^2 + U_{d3}^2 + \dots}}{TotalRMS}$$

The measured value can be displayed in % as well as in dB.

"All even di" The **distortion** of all **even** harmonics d2 to d8 (root from the quadratic sum of the even harmonics) is measured **relative** to the total RMS value.

$$U_{THD} [dB] = 20 \cdot \log \frac{\sqrt{U_{d2}^2 + U_{d4}^2 + U_{d6}^2 + U_{d8}^2}}{TotalRMS}$$

The measured value can be displayed in % as well as in dB.

"All odd di" The **distortion** of all **odd** harmonics d3 to d9 (root from the quadratic sum of the odd harmonics) is measured **relative** to the total RMS value.

$$U_{THD} [dB] = 20 \cdot \log \frac{\sqrt{U_{d3}^2 + U_{d5}^2 + U_{d7}^2 + U_{d9}^2}}{TotalRMS}$$

The measured value can be displayed in % as well as in dB.

"All di" The distortion of all harmonics d2 to d9 (root from the square sum of all 8 harmonics) is measured relative to the total RMS.

$$U_{THD} [dB] = 20 \cdot \log \frac{\sqrt{U_{d2}^2 + U_{d3}^2 + \dots + U_{d8}^2 + U_{d9}^2}}{TotalRMS}$$

The measured value can be displayed in % as well as in dB.

"Level Select di" The distortion voltage of any given combination of harmonics d2 to d9 (root from the square sum of the selected harmonics) is measured.

$$U_{THD} [V] = \sqrt{U_{d2}^2 + U_{d3}^2 + \dots}$$

The measured value is displayed in voltage units (volts or FS).
The desired harmonics are selected in the parameter fields below.

"Level even di" The distortion voltage of all even harmonics d2 to d8 (root from the square sum of the even harmonics) is measured.

$$U_{THD} [V] = \sqrt{U_{d2}^2 + U_{d4}^2 + U_{d6}^2 + U_{d8}^2}$$

The measured value is displayed in voltage units (volts or FS).

"Level odd di" The distortion voltage of all odd harmonics d3 to d9 (root from the square sum of the even harmonics) is measured.

$$U_{THD} [V] = \sqrt{U_{d3}^2 + U_{d5}^2 + U_{d7}^2 + U_{d9}^2}$$

The measured value is displayed in voltage units (volts or FS).

"Level all di" The distortion voltage of all harmonics d2 to d9 (root from the square sum of all 8 harmonics) is measured.

$$U_{THD} [V] = \sqrt{U_{d2}^2 + U_{d3}^2 + \dots + U_{d8}^2 + U_{d9}^2}$$

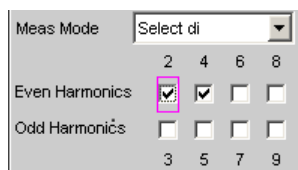
The measured value is displayed in voltage units (volts or FS).

Remote command:

[SENSe<n1>:FUNction:MMODE](#) on page 931

Even Harmonics

Used to select the desired even harmonics; only available if "(Level) Select di" is selected under "Meas Mode".



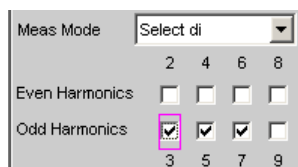
Remote command:

[SENSe<n1>:FUNctIon:DIStortion<n3>](#) on page 937

<n3> designates harmonics 2 to 9

Odd Harmonics

Used to select the desired odd harmonics; only available if "(Level) Select di" is selected under "Meas Mode".



Remote command:

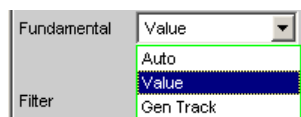
[SENSe<n1>:FUNctIon:DIStortion<n3>](#) on page 937

<n3> designates harmonics 2 to 9

Fundamental

Used to determine the fundamental frequency.

With precision measurement (in the two-channel analog analyzer only), this field is also used to determine the notch frequency of the automatically activated analog notch filter.



"Auto" The fundamental frequency is determined (separately for each channel) by means of internal frequency measurement. Recommended when using the low-distortion generator or an external signal source.

"Value " Fixed fundamental frequency; the value must be entered in the parameter field below.



Recommended for signals with a high noise component if an external generator is used as the signal source.

"Gen Track" The fundamental frequency changes with the generator (nominal) frequency. This can be changed by means of manual entry in the Generator Function panel or owing to a generator frequency sweep. Setting reliability in the case of signals with a high noise component is thus improved and measurement speed is increased.

Note: If the Low Distortion Generator option is used, "Gen Track" should be avoided on account of the rigid coupling to the generator's nominal frequency, otherwise measuring inaccuracy resulting from slight frequency offset could occur.

An error message is output if an unsuitable signal function is selected in the generator (e.g. a multi-tone signal or noise signal).

Recommended when using the internal universal generator.

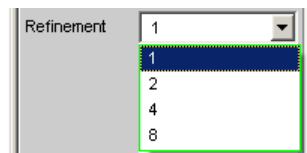
Remote command:

`SENSe<n1>:VOLTage:FUNDamental:MODE` on page 938

`SENSe<n1>:VOLTage:FUNDamental` on page 937

Refinement

Improvement of the signal-to-noise ratio



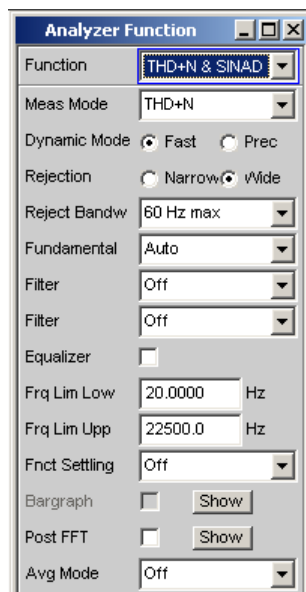
"1" The refinement factor 1 is suitable for the THD measurement on signals with good S/N ratio.

"2, 4, 8" With an adverse S/N ratio and low total harmonic distortion, the noise signal can receive a higher level than the distortion product in the analysis bandwidth, thereby leading to hardly any informative measurement results. With the refinement factors 2, 4 or 8, the analysis bandwidth is reduced accordingly, thereby increasing the frequency resolution, which leads to an improvement in the S/N ratio in increments of 3 dB each.

Remote command:

`SENSe<n1>:FUNCTION:REFNment` on page 937

5.27.3 THD+N & SINAD

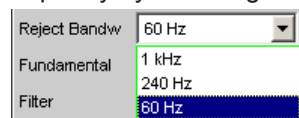


THD+N & SINAD (total harmonic distortion + noise) is a distortion measurement that measures and displays the energy of the broadband noise **without the fundamental** (residual signal) within a selectable frequency band (optionally, the energy can also be displayed relative to the total energy). This measurement function allows different measurement modes; it is also possible to eliminate the harmonics, except for the fundamental, so that the measured value only contains non-harmonic components and noise.

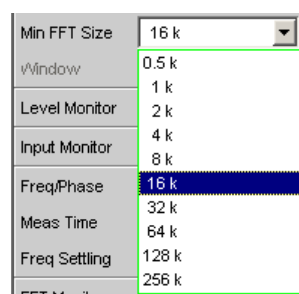
An FFT is used to record the spectrum, filter out the fundamental and calculate the total remaining energy (residual spectrum) – comprising of harmonics and broadband noise – within the band limits specified with "Frq Lim Low" and "Frq Lim Upp". The FFT value is automatically adapted to the measured fundamental frequency; the lower the frequency is, the longer the required FFT and, therefore, the integration time will be.

The user can select the **minimum FFT value**:

- implicitly by selecting the rejection bandwidth (with deactivated Post FFT)



- explicitly by selecting the minimum FFT length "Min FFT Size " with activated "Post FFT ".



Here a compromise must be made between measurement speed and measurement accuracy:

- A small (initial) FFT length and a large rejection bandwidth ("Rejection Bandwidth") mean a short measurement time; the filtered-out sideband of the fundamental is, however, relatively large. Non-harmonic signal components close to the fundamental are not measured.
- A large (initial) FFT length means a long sampling time; the filtered-out sideband of the fundamental is, however, relatively small so that signal components (non-harmonics and noise) close to the fundamental are also measured.

If the selected FFT value is not large enough to determine the fundamental of the measurement signal, the length of the FFT is increased gradually by a factor of 2.

The maximum FFT value depends on the bandwidth or sampling rate:

- at a 22 kHz bandwidth (analog) the FFT value can be increased to a maximum of 64 k,
- at sampling rates of less than 50 kHz (digital) or at a 40 kHz bandwidth (analog) the FFT value can be increased to a maximum of 128 k,
- at sampling rates of more than 50 kHz (digital) or a bandwidth of 80 or 250 kHz (analog) the FFT value can be increased to a maximum of 256 k.

The maximum integration time in the two-channel analog analyzer (fast mode) is therefore around 1.4 s.

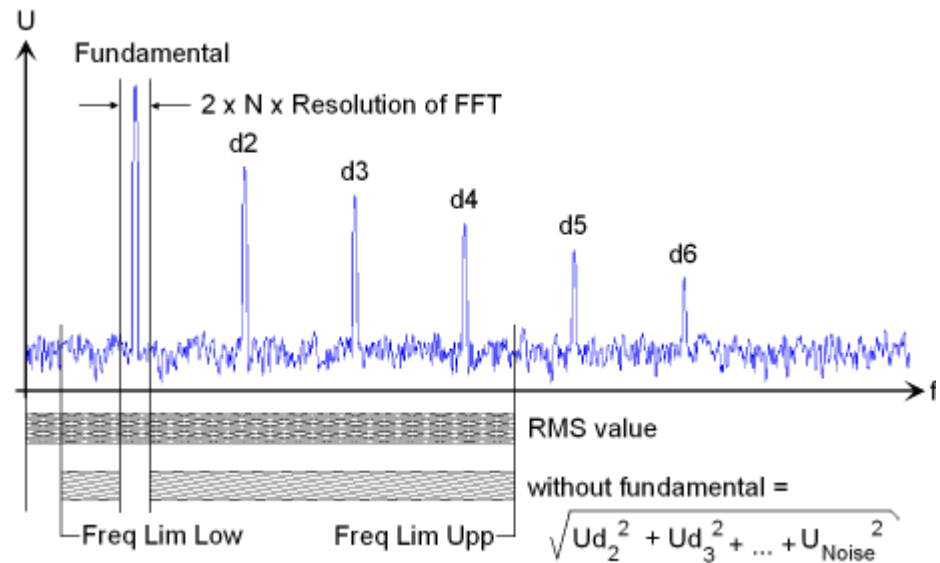


Sideband suppression is designed for the shortest possible measurement time. For very low frequency signals (less than 12 Hz), sideband suppression can be improved – at the cost of a longer measurement time – by increasing the minimum FFT size to 128 K (with 48 kHz sampling rate and 22 kHz bandwidth) or 256 K (with 96 kHz sampling rate and 40 kHz bandwidth).

The energy of the noise and (if applicable) the harmonics (i.e. without fundamental) can be displayed as RMS value with "Meas Mode" = "Level THD+N" or set in relationship to the total RMS with "Meas Mode" = "THD+N". The total RMS value is band-limited to "FrqLim Upp" and is identified in the following figure with **RMS value**.

An ultra-pure sine-wave signal is required as the measurement signal. The selected frequency of this sine-wave signal should be such that the significant components of the distortion spectrum are still below the upper measurement limit.

The "Sine" signal function of the internal generator is recommended as the signal source. If the optional low-distortion generator is available, it should be activated for measurements on low-distortion DUTs. The sine-wave level and frequency can be varied or swept.



SCPI command:

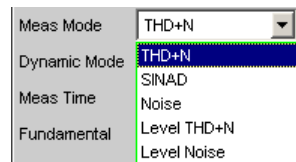
`SENSe[1]:FUNCtion THDNsndr`

For alternative distortion measurement, see [chapter 5.27.2, "THD"](#), on page 499.

For more distortion measurements, see [chapter 5.27, "Distortion Measurements"](#), on page 494.

Meas Mode

Used to select the THD+N measurement method and the calculation formula for the measured value.



The term **Level** indicates that the measurement result is displayed as an RMS value and is not relative to the total RMS value (as is customary with distortion measurements).

With the **Noise** measurements, it is also possible to filter all harmonics (except the fundamental) out of the overall signal.

Note: The noise energy of the respective sideband is also filtered out with each harmonic so that with very low frequencies - with theoretically with large numbers of harmonics - a large part of the noise energy is lost. To counter this, measurement is performed with a very fine frequency resolution, which (compared to the THD+N measurement) results in a considerably longer measurement time. The Level measurement modes should therefore only be used for high frequencies.

"THD+N" The **total distortion** – broadband noise **and** harmonic – is measured **relative** to the total RMS value.

$$U_{THD+N} [dB] = 20 \cdot \log \frac{\sqrt{U_{d2}^2 + U_{d3}^2 + \dots + U_{Noise}^2}}{TotalRMS}$$

The total RMS value is band-limited to Frq Lim Upp.

The measured value can be displayed in % as well as in dB.

"SINAD" Measurement method similar to THD+N, but the result is displayed as a **positive** dB value, i.e. the total RMS value is relative to the residual signal (overall spectrum without fundamental).

$$U_{SINAD} [dB] = 20 \cdot \log \frac{TotalRMS}{\sqrt{U_{d2}^2 + U_{d3}^2 + \dots + U_{Noise}^2}}$$

The total RMS value is band-limited to Frq Lim Upp.

"Noise" The noise factor – broadband noise **without** harmonics – is measured **relative** to the total RMS value.

$$U_{Noise} [dB] = 20 \cdot \log \frac{\sqrt{U_{Noise}^2}}{TotalRMS}$$

The total RMS value is band-limited to Frq Lim Upp.

The measured value can be displayed in % as well as in dB.

"Level THD+N" The **total distortion voltage** – consisting of broadband noise **and** the harmonic – is measured.

$$U_{THD+N} [V] = \sqrt{U_{d2}^2 + U_{d3}^2 + \dots + U_{Noise}^2}$$

The measured value is displayed in voltage units (volts or FS).

"Level Noise" The **noise voltage** (broadband noise **without** the harmonics) is measured.

The measured value is displayed in voltage units (volts or FS).

Remote command:

[SENSe<n1>:FUNction:MMODE](#) on page 931

Rejection

Used to select the fundamental rejection. Only available in "Dynamic Mode Fast" as well as in multichannel analog and digital analog analyzers.



"Narrow" The fundamental is suppressed extremely narrowly. As a result, it is also possible to detect noise components which are immediately next to the carrier.

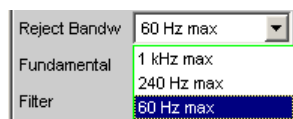
"Wide" A digital notch filter with properties like those previously common in analog measuring instruments is used to suppress the fundamental. The broader filtering range produces slightly better measured values since noise components close to the carrier are also suppressed. Recommended if the measurement results are to be comparable to those of analog measuring instruments.

Remote command:
[SENSe<n1>:THDN:REJection](#) on page 938

Reject Bandw

Used to select the suppression bandwidth ("Rejection Bandwidth") by implicitly entering the initial FFT value.

Only functions with deactivated Post FFT; with activated Post FFT, the initial FFT value must be specified explicitly by the user.



The larger the bandwidth is (absolute frequency band around the fundamental), the smaller the initial FFT and the higher the measurement speed will be.

The actual initial value of the FFT is determined automatically taking the sampling rate, the analog bandwidth and the dynamic range of the used analyzer into consideration.

The **final value** of the FFT is determined by the frequency of the measurement signal; it is increased automatically with low frequencies.

Apart from the measurement frequency, the actual measurement time also depends on the analog bandwidth and sampling frequency.

Note: When the Post FFT is activated, the internally calculated initial FFT value is entered in the "Min FFT Size" parameter field. It can then be freely changed by the user.

"1 kHz max" The suppression bandwidth is a maximum of 1 kHz, i.e. 500 Hz both below and above the fundamental. The initial FFT value is very small (e.g. 1 k at an analog bandwidth of 22 kHz and a sampling rate of 48 kHz), and the measurement time is very short – especially at higher frequencies. Non-harmonic signal components close to the fundamental are not measured. Recommended for fast measurement of the harmonics.

"240 Hz max" The suppression bandwidth is a maximum of 240 Hz, i.e. 120 Hz both below and above the fundamental. The initial FFT value is at least 4 k. Compromise between measurement time and loss of sideband energy

"60 Hz max" The suppression bandwidth is a maximum of 60 Hz, i.e. only 30 Hz both below and above the fundamental.
The initial FFT value is not below 16 k.
Recommended for measuring signal components close to the fundamental and especially for noise measurements as this bandwidth ensures that the fundamentals and harmonics are suppressed as narrowly as possible.

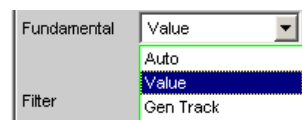
Remote command:

[SENSe<n1>:FUNction:APERture:MODE](#) on page 930

Fundamental

Used to determine the fundamental frequency.

With precision measurement (in the analog analyzer only), this field is also used to determine the notch frequency of the automatically activated analog notch filter.



"Auto" The fundamental frequency is determined (separately for each channel) by means of internal frequency measurement.
Recommended when using the low-distortion generator or an external signal source

"Value " Fixed fundamental frequency; the value of which must be entered in the parameter field below



Recommended for signals with a high noise component if an external generator is used as the signal source

"Gen Track" The fundamental frequency changes with the generator (nominal) frequency. This can be changed by means of manual entry in the Generator Function panel or owing to a generator frequency sweep. Setting reliability in the case of signals with a high noise component is thus improved and measurement speed is increased.

Note: If the Low Distortion Generator option is used, "Gen Track" should be avoided on account of the rigid coupling to the generator's nominal frequency, otherwise measuring inaccuracy resulting from slight frequency offset could occur.

An error message is output if an unsuitable signal function is selected in the generator (e.g. a multi-tone signal or noise signal).

Recommended when using the internal universal generator.

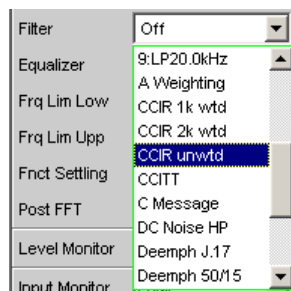
Remote command:

[SENSe<n1>:VOLTage:FUNDamental:MODE](#) on page 938

[SENSe<n1>:VOLTage:FUNDamental](#) on page 937

Filter

Two digital filters (user-definable filters or weighting filters) in the measurement path.



The filters used here only affect the residual signal. In other words, the THD+N reference value is always the RMS signal at the Monitor level, regardless of the filters selected here.

By contrast, the input filter ("Pre Filter") affects the residual signal **and** the total RMS value.

Five measurement scenarios for THD+N, SINAD and noise can thus be distinguished based on the selected input and function filters:

- Scenario 1 – Input and function filter **off**:
Reference value is the **unweighted** input signal, band-limited to Frq Lim Upp (such as R&S UPL / UPD **without** weighting filter).
- Scenario 2 – Prefilter **off**, function filter **on**:
Reference value is the **unweighted broadband** input signal.
- Scenario 3 – Prefilter as weighting filter, function filter **off**:
Reference value is the weighted input signal, band-limited to Frq Lim Upp.
- Scenario 4 – Prefilter as **weighting** filter, function filter **on**:
Reference value is the **weighted, broadband** input signal.
- Scenario 5 – Prefilter as **lowpass** filter with cutoff frequency like Frq Lim Upp, function filter as **weighting filter**:
Reference value is the unweighted input signal, band-limited to "Frq Lim Upp " (as with R&S UPL / UPD with weighting filter).

For a description of selectable weighting filters, see [chapter 5.45, "Weighting Filters"](#), on page 637.

Note: The previous generation of instruments R&S UPL and R&S UPD did not allow a prefilter to be selected. Consequently, only measurement scenarios 1 and 5 were possible with these instruments.

Note: The upper band limit can be limited in the analog analyzer using the "Bandwidth" parameter field, which has the same effect as an additional lowpass filter.

Remote command:

`SENSe<n1>:FILTer<n2>` on page 958

For a description of the filters and their setting parameters, see [chapter 5.43.4, "Filter Table"](#), on page 628.

Frq Lim Low

Used to enter the lower band limit for calculating the distortion voltage; this limit does not affect calculation of the total RMS.

Frq Lim Low Hz

Remote command:

[SENSe<n1>:FREQUENCY:LIMit:LOWer](#) on page 938

Frq Lim Upp

Used to enter the upper band limit for calculating the distortion voltage **and** the total RMS value.

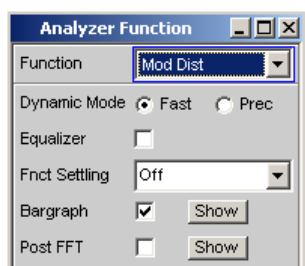
Frq Lim Upp Hz

Note: If the fundamental of the measurement signal is above "Frq Lim Upp", the referenced measurements (THD+N, SINAD and Noise) are not to be performed because the energy of the fundamental is filtered out in the reference value. An error message appears in the user info line and the measured value is identified as invalid (---).

Remote command:

[SENSe<n1>:FREQUENCY:LIMit:UPPer](#) on page 938

5.27.4 MOD DIST

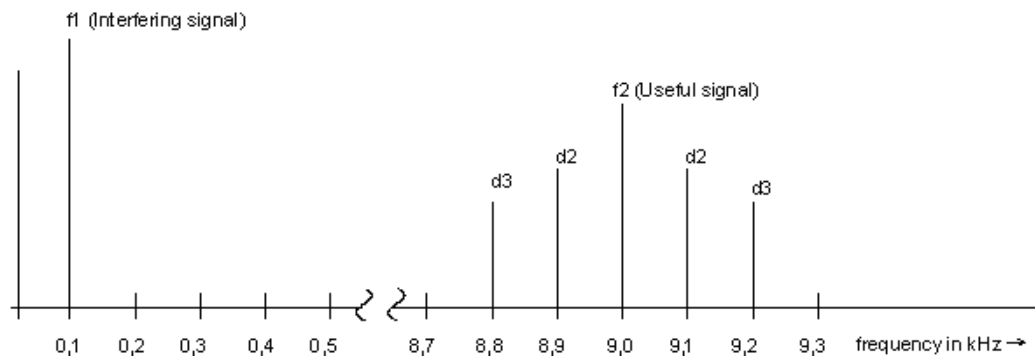


Mod Dist is a modulation factor analysis which determines the intermodulation of a low-frequency (dominant) interfering signal to a high-frequency useful signal. According to IEC 60268 Part 3, the interfering signal should be 60 Hz and the useful signal should be 7 kHz; the amplitude ratio should preferably be 4 : 1. The R&S UPV measures the 2nd and 3rd order intermodulation products selectively (measurements are therefore largely unaffected by noise) and calculates their square sum. Contrary to the recommendation in IEC 60268, the **total** intermodulation factor is therefore measured to ensure that this measurement method is comparable to the customary SMPTE measurement method.



The measurement algorithm is highly tolerant with respect to the level ratio of the interfering signal to the useful signal. The level of the interfering signal is allowed to reach up to 48 dB below the level of the (higher-frequency) useful signal. The level of the useful signal may be max. 68 dB lower than that of the interfering signal.

The "Mod Dist" signal function of the internal universal generator is recommended as the **signal source**. This allows the frequencies of the interfering and useful signal as well as their amplitude ratio to be varied. Furthermore, it is also possible to sweep the total level and useful frequency.



$$d2 = \frac{|U_{(f1+f2)}| + |U_{(f2-f1)}|}{U_{(f2)}}$$

2nd order intermodulation product (5 - 1)

$$d3 = \frac{|U_{(f2-2f1)}| + |U_{(f2+2f1)}|}{U_{(f2)}}$$

3rd order intermodulation product (5 - 2)

$$MODDIST[dB] = 20 \cdot \left(\lg \sqrt{d2^2 + d3^2} \right)$$

Total intermodulation factor in dB (5 - 3)

SCPI command:

`SENSe[1]:FUNCtion MDIST`

For alternative intermodulation measurement, see [chapter 5.27.5, "DFD"](#), on page 513.

For more distortion measurements, see [chapter 5.27, "Distortion Measurements"](#), on page 494.

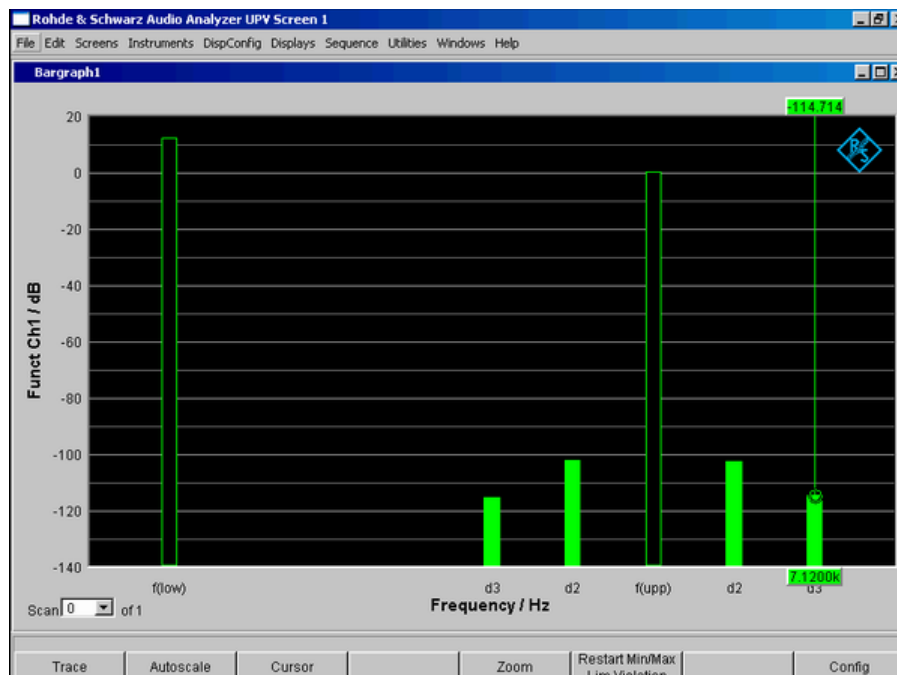
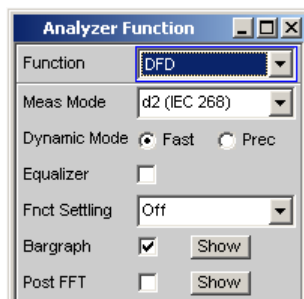


Fig. 5-26: Mod-Dist measurement with 7 kHz useful signal and quadrupled interferer at 60 Hz

5.27.5 DFD



DFD is a difference-tone factor analysis which determines the intermodulation products generated by two sine-wave signals of the same amplitude. Depending on the selected measurement mode, the R&S UPV measures the 2nd or 3rd order intermodulation products selectively in accordance with DIN IEC 60268 Part 3. Measurements are therefore largely unaffected by noise. The arithmetical center frequency of the double-tone signal should be selected from the third-octave band (5, 6.3, 8, 10, 12.5, 16, 20 kHz) and the frequency difference should preferably be 80 Hz.

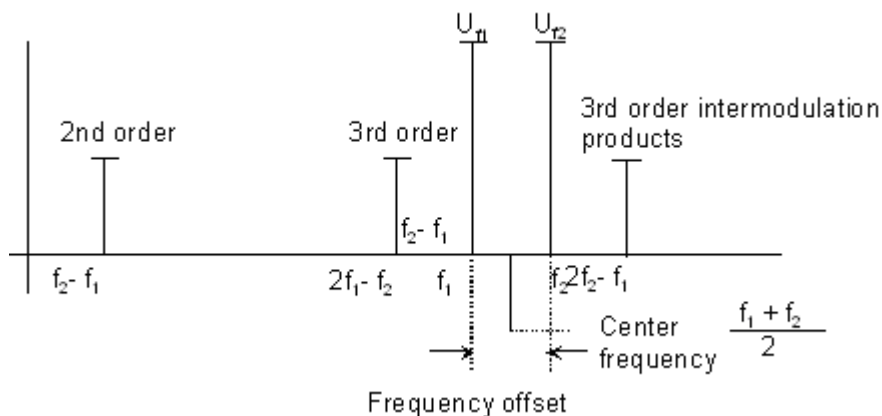
The "DFD" signal function of the internal universal generator is recommended as the **signal source**. This allows the center frequency and difference frequency (for IEC 60268) and the upper frequency and difference frequency (for IEC 60118) to be varied. Furthermore, it is also possible to sweep the center frequency and upper frequency.

SCPI command:

`SENSe[1]:FUNCTION DFD`

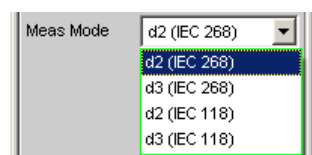
For alternative intermodulation measurement, see [chapter 5.27.4, "MOD DIST"](#), on page 511.

For more distortion measurements, see [chapter 5.27, "Distortion Measurements"](#), on page 494.



Meas Mode

Used to select the order of the intermodulation products and the measurement standard.



IEC 60268 applies the measured intermodulation products to the double upper frequency; IEC 60118 applies them to the single upper frequency only. The results according to IEC 60268 are therefore approx. 6 dB better than the results according to IEC 60118.

"d2 (IEC 268)" Measurement of the 2nd-order intermodulation product relative to the **double** amplitude at the upper frequency (acc. to IEC 60268):

$$d_2 [dB] = 20 \cdot \lg \frac{|U_{(f_2-f_1)}|}{2 \cdot U_{(f_2)}}$$

"d3 (IEC 268)" Measurement of the 3rd-order intermodulation products referenced to the **double** amplitude at the upper frequency (acc. to IEC 60268):

$$d_3 [dB] = 20 \cdot \lg \frac{|U_{(2f_2-f_1)}| + |U_{(2f_1-f_2)}|}{2 \cdot U_{(f_2)}}$$

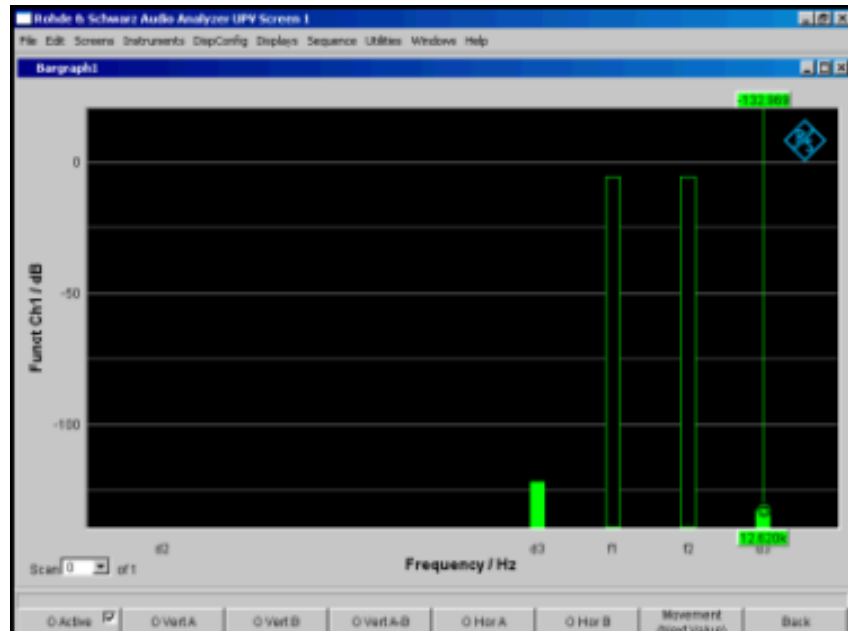


Fig. 5-27: DFD-d3 measurement in accordance with IEC 60268

"d2 (IEC 118)" Measurement of the 2nd-order intermodulation product referenced to the **single** amplitude at the upper frequency (acc. to IEC 60118):

$$d_2 [dB] = 20 \cdot \lg \frac{|U_{(f_2-f_1)}|}{U_{(f_2)}}$$

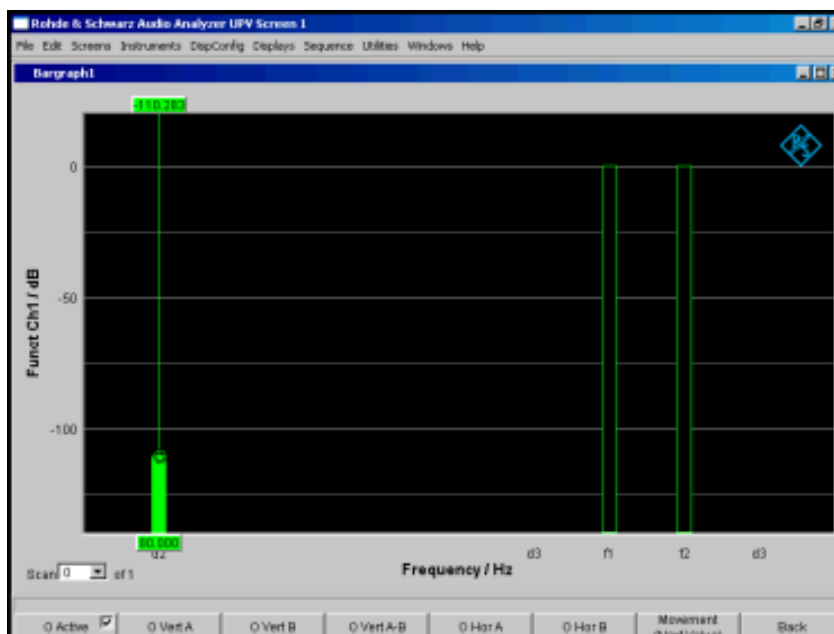


Fig. 5-28: DFD-d2 measurement in accordance with IEC 60118

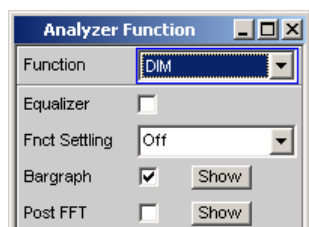
"d3 (IEC 118)" Measurement of the lower 3rd-order intermodulation product referenced to the single amplitude at the upper frequency (acc. to IEC 60118):

$$d_3 [dB] = 20 \cdot \lg \frac{|U_{(2f_1-f_2)}|}{U_{(f_2)}}$$

Remote command:

`SENSe<n1>:FUNction:MMODE` on page 931

5.27.6 DIM (dynamic intermodulation distortion analysis)



DIM is an analysis of intermodulation distortion that determines the nine components of dynamic intermodulation in the audible range caused by a mixture of a low-frequency square-wave signal and a high-frequency sine-wave signal. It is mainly used to deter-

mine the nonlinear distortion of amplifiers that are forced to operate up to their maximum rise speed due to the short rise time of the square-wave signal.

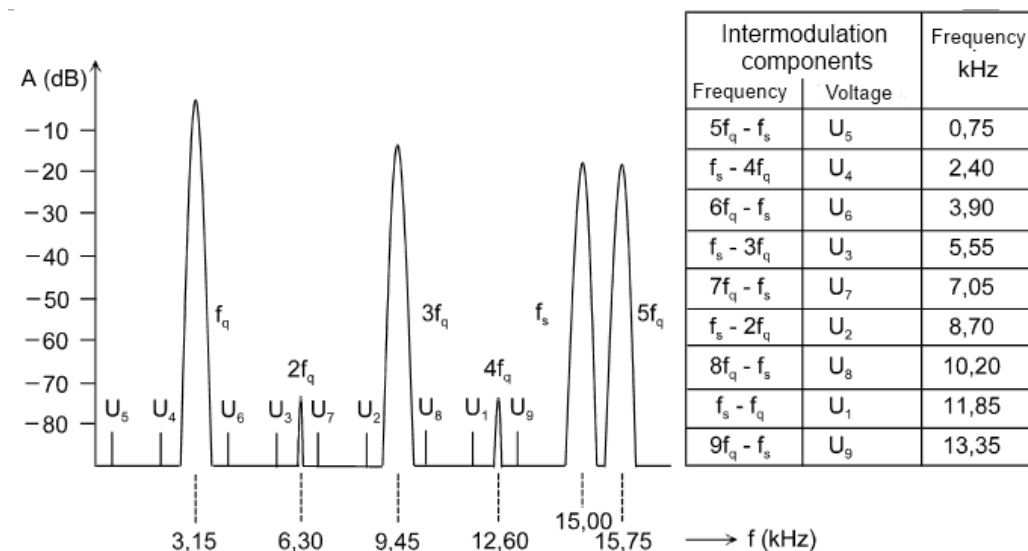
According to Part 3 of IEC 60268, the amplifier is to be operated under nominal conditions (fully loaded). The square-wave signal with a basic frequency of 3.15 kHz has to be limited to 30 kHz (or optionally 100 kHz) via a one-pin lowpass filter. The peak amplitude of the sine-wave signal with a frequency of 15 kHz must be 12 dB below the square-wave signal. In radio broadcasting, the square-wave/sine-wave combination of 2.96/14 kHz is common. A mode with a reduced sine wave frequency (2.96/8 kHz) is often used for making measurements on narrow band DUTs.

The R&S analyzer UPV supports all 3 frequency pairs and automatically determines the combination that is created in each case, provided the frequency drift is within the tolerance range stipulated by DIN IEC. This is only possible if the DUT can transfer the sine wave frequency without significant attenuation. The allowable deviation of the sine-wave signal from the nominal level is 20%.

The "DIM" signal function of the internal universal generator is recommended as the **signal source** (see chapter 5.27.6, "DIM (dynamic intermodulation distortion analysis)", on page 516). This signal function provides a standard-compliant frequency setting – including with respect to frequency accuracy.

Remote-control command:

SENSe[1]:FUNCtion DIM



The measurement result is the RMS value of the selectively measured intermodulation components (up to the 9th order) relative to the RMS value of the sine-wave signal and is displayed in dB (or, optionally, in %).

$$d[dB] = 20 \cdot \lg \frac{\sqrt{U_1^2 + U_2^2 + U_3^2 + \dots + U_9^2}}{U_s}$$

For alternative intermodulation measurement, see chapter 5.27.4, "MOD DIST", on page 511.

For more distortion measurements, see [chapter 5.27, "Distortion Measurements"](#), on page 494.

Since the used frequency pair is recognized automatically, you do not have to make any **special** settings.

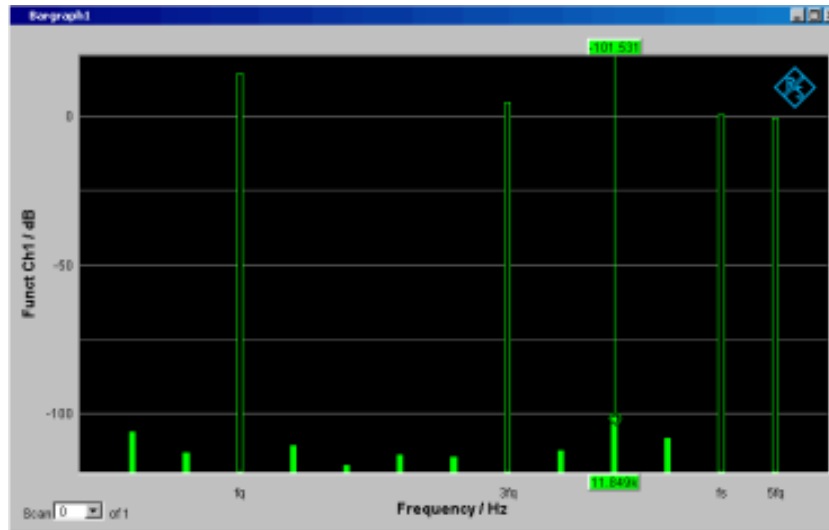


Fig. 5-29: DIM measurement with 3.15 kHz square-wave signal and 15 kHz sine-wave signal

5.28 Polarity Measurement



Polarity measurement is used to test whether a DUT (such as a cable) forwards an applied signal with the identical or reversed polarity.

To determine the polarity, a peak measurement is performed for a measurement time of 20 ms and the highest positive peak is compared with the highest negative peak.

The signal applied to the DUT must therefore fulfill the following requirements:

- The positive amplitude must be greater than the negative amplitude.
- The repetition rate must be 50 Hz or an integer multiple thereof.

The "Polarity" signal function of the internal universal generator is recommended as the **signal source**. However, the polarity signals of other R&S audio analyzers (e.g. R&S UPL, R&S UPD) can also be used. If using an external signal source, something like a sine² burst signal with 50 % duty cycle can be applied.

Function

Switching the measurement function to polarity measurement

The measurement result for the function is displayed as

- + 1.0 Pol for a **non-reversed** signal and
- - 1.0 Pol for a **reversed** signal

No further settings are needed.

Note: When using polarity signals that are not DC free (e.g. sine² burst), measurements in the analog analyzer should preferably be performed using DC coupling in order to keep the negative amplitude as low as possible.

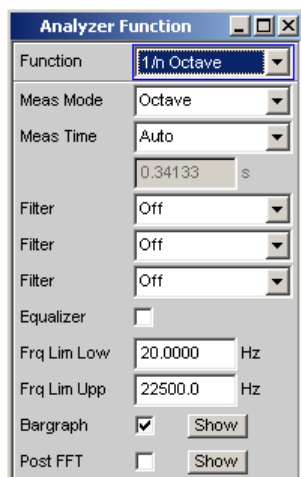
Remote command:

`SENSe[1]:FUNCtion POLarity`

5.29 Frequency Band Analysis

5.29.1 Nth Octave Analysis

This measurement function can be selected only if the R&S UPV-K6 option (extended analysis functions) is installed. It is offered in the analyzers "Analog", "Analog 8 Chan", "Analog 16 Chan", "Digital Audio", "I2S Board" and "USI Dual Chan". It is not available in the analyzers "USI 8 Chan" and "Dig Bitstream".



Nth octave analysis is a selective level measurement performed simultaneously in a number of adjacent frequency bands. The levels of the individual frequency bands are, however, not measured by narrow bandpass filters as in the case of conventional octave or third analysis, but instead with the aid of a special high-resolution FFT by integration of the FFT bins (frequency lines) in the respective band.

The advantage compared to the filter method is the significantly higher frequency resolution, which enables bandwidths down to 1/24th of an octave. The bandwidth of the subbands is theoretically fully scalable by varying "n" or using frequency tables, such as the "Critical Bands" defined by means of the Bark scale. The advantage compared to pure FFT is the logarithmic or user-definable stepping of the frequency range.

Each subband has the relative bandwidth of upper band limit minus lower band limit:

$$2^{\frac{2n}{\sqrt{2}}} - \frac{1}{2^{\frac{2n}{\sqrt{2}}}}$$

Relative bandwidth (5 - 4)

Referred to the band center this gives the following results:

- Octave analysis 70.71 %,
- Third octave analysis (third analysis) 23.16 %,
- Sixth octave analysis 11.56 %,
- Twelfth octave analysis 5.78 %,
- Twenty-fourth octave analysis 2.89 %,

The reference frequency is 1 kHz. All other band center frequencies are computed by reference to this frequency by multiplying or dividing by $2^{\frac{1}{n}}$.

Selecting the frequency bands to be measured involves specifying the upper and lower limit frequencies. A separate RMS value is determined for each selected frequency band by integrating all the FFT bins in the said band together with the attenuated bins in the adjacent band. The total RMS value of all the selected frequency bands is applied to the display of measurement results for the function.

The measurement range of the nth octave analysis starts at a nominal band center frequency of 16 Hz and ends at half the sampling rate or the bandwidth of the analog analyzer.

The exact, computed frequency bands are used in measurements and for numerical displays (e.g. with the X value displayed graphically as a cursor or for values displayed in the "Data List"). The nominal band center frequencies (in line with DIN 323) are given only for the numerical display of the third and the twelfth octave. Only the octave frequencies are captioned in the graphical display due to space restrictions.



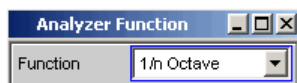
Since nth octave analysis is usually performed in the audio range only, the bandwidth in the analog analyzer should be set to 22 kHz. This avoids not only needlessly large FFTs but also long computation times.

A good candidate for use as the excitation signal in the nth octave analysis is the frequency-defined Pink Noise that can be created with the R&S UPV Generator (see [chapter 5.6.9, "Random"](#), on page 309). Unlike white noise, $\sqrt{1/f}$ its level roll-off compensates for the apparent level increase encountered with nth octave analysis, which results from the absolute bandwidth increasing as the frequency increases. If possible the spacing of the frequency lines on the FFT size should be synchronized ("Spacing Anlr Track").

Function

For selecting FFT based nth octave analysis.

The RMS value of the signal is displayed in the range "Frq Lim Low" to "Frq Lim Upp" as the measurement result for the function.

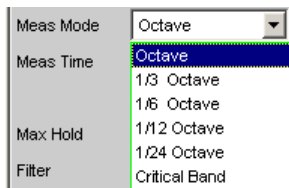


Remote command:

`SENSe[1]:FUNCTION NOCTave`

Meas Mode

This defines the measurement mode and thus implicitly the center frequencies and relative bandwidth of the bandpass filters.



The center frequencies of the subbands are spaced at intervals of $2^{1/n}$ from the 1 kHz reference frequency. The exact values can be taken from the Data List bargraph.

The band limits of a subband are at a distance of $2^{1/(2^n)}$ from the center frequency.

The larger the chosen value of "n" the narrower the bands and the longer the minimum measurement time.

"Octave"	The audio range is divided into octave bands.
"1/3 Octave"	The audio range is divided into third octave bands.
"1/6 Octave"	The audio range is divided into sixth octave bands.
"1/12 Octave"	The audio range is divided into twelfth octave bands.
"1/24 Octave"	The audio range is divided into twenty-fourth octave bands. Due to the extremely narrow bands, analysis is only possible with effect from 21.5 Hz.
"Critical Bands"	The audio range is divided into "critical bands" according to the Bark scale. The band limits are on the Bark scale and the center frequencies are 0.5 Bark above the lower band limit in each case. Due to the division into "critical bands" the low frequency bands are wider than in the case of the comparable third octave analysis, for which reason both the required FFT size and the measurement time are smaller.

Remote command:

`SENSe<n1>:FUNCTION:MMODE` on page 931

Meas Time

For selecting the measurement time.

The minimum measurement time is the same as the sampling time of the FFT and is therefore defined by the FFT size used. When a longer measurement time is selected, a greater number of FFTs is performed and averaged, reducing both the update rate and fluctuations in the measured values.

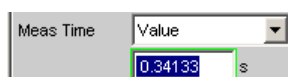
In turn the required FFT size is dependent on the sampling rate or the analog bandwidth and the width of the narrowest subband, that is, on the measurement mode and the lower band limit.

"Auto" This sets the minimum possible measurement time.



This setting is recommended for the purpose of measuring independently of the lower band limit and measurement mode, and always using the highest measurement speed.

"Value " A numerical value for the measurement time is entered in the next parameter field.



The measurement time entered is rounded to an integer multiple of the minimum measurement time and thus implicitly defines the number of averages.

This setting is recommended for the purpose of reducing the update rate and fluctuations in the measured values.

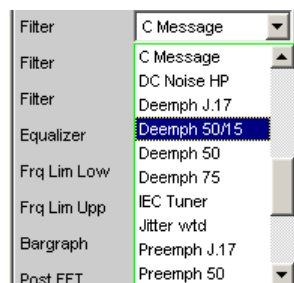
Remote command:

[SENSe<n1>:FUNction:APERTure:MODE](#) on page 930

[SENSe<n1>:VOLTage:APERTure](#) on page 931

Filter

Activating a digital filter in the test channel. Up to three user-defined or weighting filters can be looped into the test channel:



The user-definable filters are configured as filters 01 to 09 in the filter panel (see [chapter 5.44, "User-Definable Filters"](#), on page 628) and can then be used (repeatedly if necessary) in the analyzer.

For more information on the available weighting filters, see [chapter 5.45, "Weighting Filters"](#), on page 637.

Note: Regardless of the digital filters selected here, a further input filter ("prefilter") can be looped into the test channel. Moreover, the analog bandwidth can be restricted with

the aid of the "Bandwidth" parameter field, which corresponds to an additional lowpass filter.

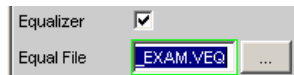
Remote command:

[SENSe<n1>:FILTer<n2>](#) on page 958

For a description of the filters and their setting parameters, see [chapter 5.43.4, "Filter Table"](#), on page 628.

Equalizer

Used for activating/deactivating a precorrector table for the FFT bins.



In this way, the frequency response of a transmission link can be precorrected, for example, and in so doing the measurement point is transformed into another reference point.

When precorrection is enabled the computed FFT bins are multiplied by a frequency-dependent factor after which they are used to calculate the nth octave bands and applied to the display.

The factor is determined by interpolation between the two adjacent frequency reference points in the precorrector table.

Precorrection of the FFT spectrum is an attractive alternative to filtering the input signal, since the precorrector file can simply be generated from the frequency response requiring precorrection and need not be in the form of a coefficient file or pole/zero file.

Application:

In acoustic measurements (e.g. with mobile telephones) on artificial ears of type 3.2 or higher, it is possible to compensate for the transfer function ERP (ear reference point) to DRP (drum reference point). Measurement of the sound waves by the microphone applied to the "eardrum" can thus be referred to the required measurement point (at the auricle).

Note: The precorrector table is created after acquiring or reading in the trace data from the "DUT" in the "DispConfig" panels.

- "deactivated" The precorrector is disabled. The FFT bins are used and displayed without change. The levels of the subbands are calculated from the original FFT spectrum.
- "activated" The precorrector is enabled. The next entry field, which is "Equal File", for the file name of the precorrector table, is activated and the file shown there is loaded. The levels of the subbands are calculated from the precorrected FFT spectrum.

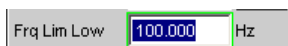
Remote command:

[SENSe<n1>:VOLTagE:EQualize](#) on page 937

[MMEMory:LOAD:IEQualize](#) on page 936

Frq Lim Low

For entering the lower band limit for computing the subbands and the total RMS value.



Display and computation of the subbands starts at the band in which the lower limit frequency is located. The lower subband is measured in full, that is, the limit frequency entered does not alter the energy content of the lower band.

The lower the frequency of the lower limit frequency, the narrower the frequency bands which have to be measured. In order to not to drop below a minimum number of bins per band, the FFT resolution and the FFT size must be increased in the narrower frequency bands.

The lower limit frequency therefore has a decisive influence on the measurement speed and should therefore not be lower than the measurement task requires.

Remote command:

[SENSe<n1>:FREQUENCY:LIMit:LOWer](#) on page 938

Frq Lim Upp

For entering the upper band limit for computing the subbands and the total RMS value.



Display and computation of the frequency bands ends at the band in which the upper limit frequency is located. The upper subband is measured in full, that is, the limit frequency entered does not alter the energy content of the upper band.

The upper limit frequency has no effect on the measurement speed.

Remote command:

[SENSe<n1>:FREQUENCY:LIMit:UPPer](#) on page 938

Bargraph

Used for activating bar graph computation and display. In addition the "Bargraph1" window can be opened from here.



Configuration of the bar graphs is reserved for the "Bargraph1 Config" and/or "Bargraph2 Config" windows. The actual display takes place in the "Bargraph1" or "Bargraph2" windows.

"deactivated" Bargraph computation (and update) disabled. Only the band-limited total RMS value is measured.

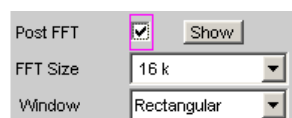
"activated" Bargraph computation (and update) enabled.

Remote command:

[SENSe<n1>:FUNCTION:BARGraph](#) on page 936

Post FFT

For activating/deactivating Post FFT. At the same time it is possible to switch between automatic and manual selection of the FFT size and window. In addition the "FFT Graph1" window can be opened from here.



Configuration of the FFT Graph is reserved for the "FFT Graph1 Config" and/or "FFT Graph2 Config" windows. The actual display takes place in the "FFT Graph1" or "FFT Graph2" windows.

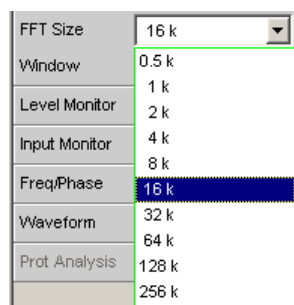
- "deactivated" Post FFT deactivated.
The necessary Post FFT size is computed automatic from the sampling rate and the width of the narrowest subband (defined by the lower limit frequency and the measurement mode).
The received samples are weighted using the Hann window function.
- "activated" Post FFT is enabled and can be displayed. The FFT size and window can be selected manually.
- Note:** When Post FFT is turned on the FFT size and window are loaded with the recommended standard settings. The manual settings are discarded when Post FFT is turned off.

Remote command:

[SENSe<n1>:FUNCTION:FFT:STATE](#) on page 937

FFT Size

This is the FFT size to be used in computing the subbands, and is adjustable in powers of 2 from 512 (0.5 k) to 256 k.



When using manual selection the FFT size should not be less than the recommended value (which is produced when Post FFT is activated), otherwise there will be too few FFT bins in the lower subbands.

With every increase in FFT size the measurement accuracy and stability increase, particularly in the relatively narrow lower subbands. At the same time, however, the measurement time doubles.

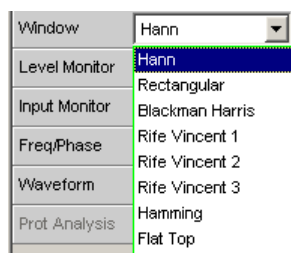
Unnecessarily high FFT sizes should be avoided in order to reduce measurement times.

Remote command:

[SENSe<n1>:FUNCTION:FFT:SIZE](#) on page 941

Window

Selection of the window function.



For details, see [chapter 5.30.2, "Window Function"](#), on page 527.

5.30 FFT Analysis

The "FFT" analysis (**F**ast **F**ourier **T**ransformation) enables the input signal to be displayed in the spectral range (frequency range). For this purpose, the (digitized) input signal is recorded over a selectable period and transformed into the frequency range by a fast "DFT" (**D**iscrete**F**ourier **T**ransformation). The result is a "list" of equidistant frequency lines (bins) which indicate the magnitude or the phase of the respective frequency components. The graphical display of the magnitude or phase bins is referred to as a spectrum or spectral display.

According to system theory, the "FFT" analysis assumes that the signal is periodic, i.e. it continues continuously beyond the observed time period. Since this ideal state only exists in a few exceptional cases, the input signal can if required be weighted using a window which attenuates both ends of the observed signal section with respect to zero.

The recording time for the "FFT", i.e. the length of the measurement interval (integration time), is determined using the **FFT** size and, like the frequency resolution, also depends on the sampling rate and bandwidth used.

In the R&S UPV, 2 different types of "FFT" can be selected:

- The "Post FFT" for distortion measurements is calculated with double precision using up to 256 k points, thus ensuring a very high frequency resolution and dynamic range. The size of the FFT and the used window cannot be selected, but instead are preset according to the requirements of the respective measurement function. The Post FFT is displayed in the "FFT Function" graphical window.
- The "FFT as measurement function" (Function FFT) is, like the Post FFT, also calculated with double precision but additionally allows a number of other functions such as averaging and undersampling (limiting the frequency range to increase the frequency resolution) as well as free selection of the FFT size and window. The Function FFT is displayed in the "FFT Function" graphical window.

5.30.1 Size of the FFT

The size of the FFT together with the sampling rate and bandwidth determines the length of the measurement interval (integration time) and thus the frequency resolution of the calculated spectrum. The following correlations apply:

- Integration time = FFT size / Sampling rate

- Number of lines = FFT size / 2
- Frequency resolution = Sampling rate / FFT size = 1 / Integration time

Therefore, if a higher sampling rate and bandwidth are used, a higher FFT size will be required to produce the same frequency resolution.

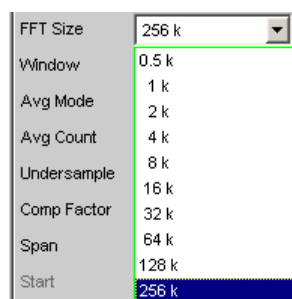
Other variables which appear as display fields in the group of FFT parameter fields are derived from the FFT size, see "Resolution" and "Meas Time".



In the analog analyzer, the internal sampling rate is determined by the selected bandwidth.

FFT Size

Size of the "Function FFT", can be set in powers of 2 from 512 (0.5 k) to 256 k.



Not only the integration time but also the time required to calculate the transformation and graphical display increase with increasing FFT size. This results in a disproportionate increase in the total measurement time. Unnecessarily high FFT sizes should therefore be avoided in order to reduce the measurement time.

Note: For the Post FFT, no fixed "FFT size" but only a (variable) lower limit ("Min FFT Size") can be entered. The measurement function carried out in each case can dynamically increase the FFT size as a function of the sample signal frequency.

Other variables which appear as display fields in the group of FFT parameter fields are derived from the "FFT size":

Remote command:

`SENSe<n1>:FUNction:FFT:SIZE` on page 941

5.30.2 Window Function

According to system theory, the FFT analysis requires a periodic signal which continues continuously beyond the observed time period. Normally, however, there is no continuous continuation (even with periodic signals). The FFT would interpret any discontinuity at the boundaries of the signal section as a pulse whose (white) spectrum would be superimposed on the wanted signal spectrum. In order to prevent this "leakage" effect, the input signal is weighted using a window which attenuates both ends of the observed signal section with respect to zero. As a result, the signal is continuous for the FFT; there is, however, a reduction in selectivity, indicated by a relatively wide bell-shaped curve. By selecting the window function, the user makes a compromise between selectivity (frequency selectivity, width of bell-shaped curve at top), crosstalk

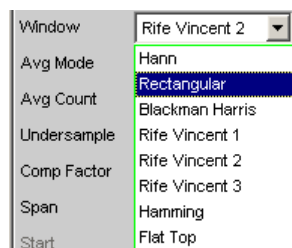
between adjacent lines (width of bell-shaped curve at bottom), slope of the bell-shaped curve and "leakage" suppression in the far-off range.

Selecting the rectangular window deactivates windowing.

Window

Selection of the window function.

With the Post FFT of the distortion and level measurements, the window cannot be selected by the user but instead is preset by the respective measurement function and displayed here.



"Hann" This window combines selectivity with good leakage suppression in the "far-off range " but has a relatively wide bell-shaped curve around the signal lines.

Recommended application: Standard window.

"Rectangular" Window function deactivated (by using a rectangular window with a constant weighting of 1).
If the signal fits in the section for the FFT exactly with an integer multiple of periods, there is no discontinuity at the section boundaries. A window is then not required and the maximum frequency resolution is possible. This feature may be of advantage when using a special generator signal ("FFT noise") as it allows fast measurement of frequency responses at specific frequencies.

Recommended application: Feasible only with special signals.

"Blackman
Harris" Only for Function FFT.

The slope of the bell curve is very steep up to approx. 80 dB; below that, however, this window has considerable leakage.

"Rife Vincent
x" The suppression of far-off interference is very good for all 3 windows. The width of the bell-shaped curve at the bottom of the individual lines drops and the width at the top increases as the Rife Vincent number increases. It is therefore possible to set various compromises between frequency resolution and the suppression of adjacent lines.
Recommended application: For exact determination of frequency

"Hamming" This window does not provide any significant advantages; it was implemented simply to complete the range.

"Flat Top" Only for Function FFT.
 Here, the region around the carrier is deliberately distorted to such an extent that at least two adjacent lines (in the case of excitation with one sine-wave line only) always have roughly the same magnitude. This allows the amplitude to be read off very precisely from the graph. In contrast, the frequency selectivity is rather poor.
 Recommended application: For exact determination of level

Remote command:

`SENSe<n1>:FUNction:FFT:WINDow` on page 942

5.30.3 Post FFT

For distortion measurements, the Post FFT displays the frequency spectrum recorded for calculating the measured values. It can be activated for the measurement functions THD+N & SINAD, THD, DFD, Mod Dist, DIM, ChirpBased Meas and RMS measurements.

Measurement is performed in the same level as the associated measurement function, i.e. downstream of all filters.

The respective measurement function adjusts the FFT size and window to its specific requirements. For example, the required FFT size increases as the signal frequency decreases. The settings for the Post FFT cannot therefore be selected by the user and can vary from measurement to measurement.

The Post FFT is calculated with double precision using up to 256 k points, thus ensuring a very high frequency resolution and dynamic range.

The Post FFT of a measurement channel is displayed in the graphical windows "FFT, Panel 1" or "FFT, Panel 2" either as a magnitude or phase. Since 2 traces are displayed in each graphical window, the magnitude and phase of both channels can be recorded simultaneously.

Post FFT

Used to activate the Post FFT. In addition the "FFT Graph1" graphical window can be opened from here.



Configuration of the FFT Graph is reserved for the "FFT Graph1 Config" and/or "FFT Graph2 Config" windows. The actual display takes place in the "FFT Graph1" or "FFT Graph2" windows.

Note: In measurement functions for which users cannot select Post FFT, this menu line is grayed out. In this case, there are two options:

1. FFT is not needed by any currently selected measurement and is therefore not computed in order to save time. There is no live FFT in the FFT graph.



2. FFT is needed by at least one selected measurement (e.g. phase measurement, precision frequency measurement) and cannot be deactivated. The internally used FFT can be displayed in the FFT graph.

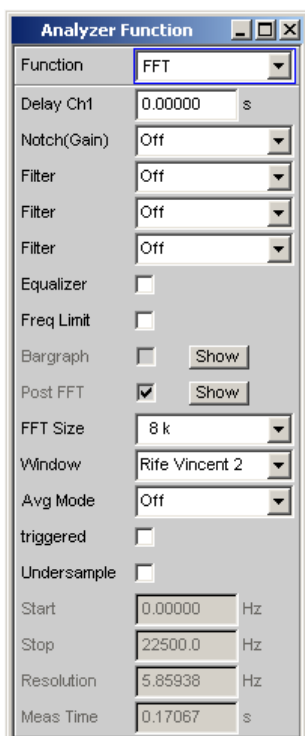


- "deactivated" Post FFT deactivated.
Recommended for increasing the measurement speed (e.g. for sweeps or remote control).
- "activated" Post FFT activated; the associated measurement function defines the remaining settings dynamically.

Remote command:

[SENSe<n1>:FUNction:FFT:STATe](#) on page 937

5.30.4 FFT Measurement Function



The "FFT" can be selected as a separate measurement function (Function FFT). Unlike the other FFT analyses, all FFT parameters can be determined by the user.

The following additional functions are also available:

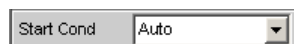
- Delay compensation
- DC suppression (digital only)
- Filtering (3 user-definable filters and – in the two-channel analog analyzer – 1 analog notch)
- Averaging

Measurement is performed in the same level as the other measurement functions, i.e. downstream of all filters.

The Function FFT is calculated with double precision using up to 256 k points, thus ensuring a very high frequency resolution and dynamic range.

The Function FFT of a measurement channel is displayed in the graphical windows "FFT, Panel 1" or "FFT, Panel 2" either as a magnitude or phase. Since 2 traces are displayed in each graphical window, the magnitude and phase of both channels can be recorded simultaneously.

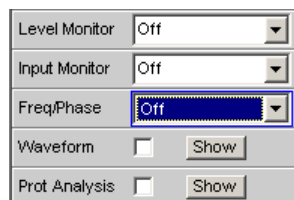
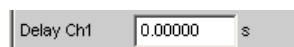
The FFT can be generated continuously if the sampling rate is less than 100 kHz or the analog bandwidth is 40 kHz. For this purpose, it is necessary to ensure that no special functions (such as delay compensation) are enabled and that no "supplementary" measurement (such as waveform monitoring or frequency measurement) takes longer than the actual FFT. To ensure this, it is advisable to switch off all other measurements:



only in generator and analyzer:



analog only:



Function

Used to change the measurement function to FFT analysis.

The band-limited and, possibly, filtered RMS is displayed as the function measurement result. The RMS is calculated by means of integration over all magnitude frequency lines from "Start" to "Stop".

The frequency and phase value derived from the FFT is displayed as the "Freq/Phase" measurement result if "Precision" is set as "Meas Time" for the frequency measurement.

With AC coupling (analog) or "DC Suppress" (digital), the DC component (bell-shaped curve) is not included in the measurement. If a Window function is used, it is 5 bins wide, so that the bottom 6 bins are not included in the RMS result.

Note: To include very low frequency signals in the RMS value, either the FFT size must be selected sufficiently large (so that the desired signal components are above the 6th bin) or the rectangular window must be used (which ignores only the DC bin).

The panel segment shown here represents a digital FFT that is band-limited to 12 kHz.

With this FFT, the "Start" value is always 0.0 Hz; the "Stop" value is the resulting bandwidth. Resolution and Meas Time depend on the selected FFT size and the compression factor.

Remote command:

`SENSe[1]:FUNCtion FFT`

Delay Ch1, Delay Ref Chan

Used to activate the delay compensation.

Delay Ch1 s

Delay Ref Chan s

This compensates delay differences of the DUT.

Two-channel analyzers:

The time by which Channel 1 is to be offset relative to Channel 2 is entered. If the delay of Channel 2 is shorter than that of Channel 1, this can be compensated by entering a negative time.

Multichannel analyzers:

The time by which the channel specified as the "Ref Channel" in the Analyzer Config Panel is to be offset relative to the other channels. If the delay of the other channels is shorter than that of the "Ref Channel", this can be compensated by entering a negative time.

The compensation of delay differences is particularly useful for phase measurements since a time offset of both sample signals causes a frequency-dependent phase displacement and can thus invalidate the phase measurement result.

Note: Delay compensation cannot be selected when the "Compressed" or "Undersample" waveform modes are used or when "Undersample" is enabled. Delay compensation must also be switched off (set to 0.0 s) for continuous FFT generation.

Remote command:

`SENSe<n1>:CHANnel:DELay` on page 940

DC Suppress

Used to activate DC suppression (in the digital analyzer only).

DC Suppres

For DC suppression in the digital analyzer, the DC level is measured in the Monitor level and subtracted from the input samples.

This parameter field is not available in the analog analyzer because the suppression function is already provided by the AC coupling which can be set up using the hardware.

- "deactivated" DC suppression deactivated.
The DC component of the sample signal is not suppressed ("DC coupling") and is included in the measurement result and the graphical display.
Recommended when using a highpass or bandpass filter because additional DC suppression is not necessary in these cases and would increase the calculation time (slightly).
- "activated" DC suppression activated.
The DC component of the sample signal is suppressed ("AC coupling"); the measurement result and the graphical display only include the AC component.

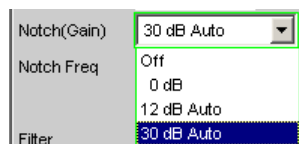
Remote command:

[SENSe<n1>:FUNCtion:DCSuppression](#) on page 935

Notch(Gain)

Used to activate the analog notch filter and select the notch gain.

Only available in the two-channel analog analyzer.



In the two-channel analog analyzer, a second-order analog notch filter can be activated for narrowband suppression of unwanted frequency lines. When the notch filter is activated, the user can choose between 3 different gain factors.

Note: If frequency components occur outside the analyzer frequency range, the notch gain could cause overloading of the analyzer. In this case, the notch gain is reduced incrementally, which is indicated by "Auto" in the list items 12 dB and 30 dB.

- "Off" Analog notch filter deactivated.
- "0 dB" Analog notch filter activated; no gain in effect.
- "12 dB Auto" Analog notch filter activated; gain 12 dB.
- "30 dB Auto" Analog notch filter activated; gain 30 dB.

Remote command:

[SENSe<n1>:NOTCh](#) on page 942

Notch Freq

Numeric or automatic selection of the notch-filter center frequency; only appears in the two-channel analog analyzer if "Notch(Gain)" is activated.

- "Value " The user can enter the notch-filter center frequency in the next parameter field. If "Value" is selected, the center frequency last active is displayed.



"Gen Track" The notch-filter center frequency is adopted from the generator panel (if possible). If the generator signals are unsuitable (e.g. noise), an error message is output and the center frequency last valid is retained.



Remote command:

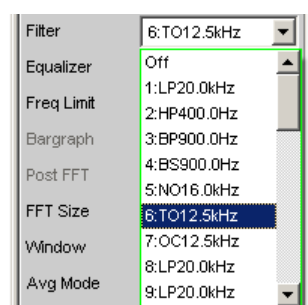
[SENSe<n1>:NOTCh:FREQuency:MODE](#) on page 943

[SENSe<n1>:NOTCh:FREQuency](#) on page 943

Filter

3 separate filters can be looped into the measurement path. Apart from those filters which can be user-defined in the filter panel, filters can also be selected from a set of supplied weighting filters.

Selecting "OFF" deactivates the respective filter.

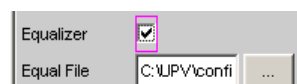


Remote command:

[SENSe<n1>:FILTer<n2>](#) on page 958

Equalizer

Used for activating/deactivating a equalizer table for the FFT bins.



In this way the frequency response of a transmission link can be equalized, for example, and in so doing the measurement point is transformed into another reference point.

When equalization is enabled the computed FFT bins are multiplied by a frequency-dependent factor after which they are used to calculate the total RMS value and applied to the display.

The factor is determined by interpolation between the two adjacent frequency reference points in the equalizer table.

Equalization of the FFT spectrum is an attractive alternative to filtering the input signal, since the equalizer file can simply be generated from the frequency response requiring equalization and need not be in the form of a coefficient file or pole/zero file.

Application:

In acoustic measurements (e.g. with mobile telephones) on artificial ears of type 3.2 or higher, it is possible to compensate for the transfer function "ERP" (ear reference point) to "DRP" (drum reference point). Measurement of the sound waves by the microphone applied to the "eardrum" can thus be referred to the required measurement point (at the auricle).

Note: The equalizer table is created after acquiring or reading in the trace data from the "DUT" in the "DispConfig" panels.

"deactivated" The equalizer is disabled; the FFT bins are used and displayed without change.

"activated" The equalizer is enabled; the next entry field "Equal File" for the file name of the equalizer table is activated and the file shown there is loaded.

Remote command:

[SENSe<n1>:VOLTage:EQualize](#) on page 937

[MMEMory:LOAD:IEQualize](#) on page 936

Freq Limit

RMS value calculation on the basis of the FFT bins between frequency marks

Freq Limit	<input checked="" type="checkbox"/>
Frq Lim Low	20.0000 Hz
Frq Lim Upp	43500.0 Hz

"deactivated" The frequency limits for calculating the RMS value from the FFT bins is based on the Start and Stop values of the FFT (shown but not accessible), i.e. the calculation is broadband-based.

"activated" The bandwidth for calculating the RMS value from the FFT bins can be limited. In the two following fields, the lower and upper band limits are indicated – as for the THD+N measurement. When the bandwidth is reduced, the device only looks for the frequency in this range when in "Meas Time" = "Prec" measuring mode. If the frequency of the broadband signal is to be determined, either the time for measuring the frequency must be set to "Meas Time" = "Fast" or the bandwidth limitation must be disabled. When the AC coupling is enabled (or "DC-Suppress" in the digital range), the RMS calculation starts above the DC bell curve. When the Window function is disabled, i.e. "Window" = "Rectangular", only the DC bin (otherwise the first 6 bins) are suppressed. Thus, with DC suppression the actual lower frequency limit depends on the Window function, which means that the FFT size may be larger than the value selected by the user. Applying band limits that have been limited with both of the following parameter fields to the limits of the x-axis in the FFT graphic would not be desirable in most cases, and is not done.

Remote command:

[SENSe<n1>:FREQuency:LIMit](#) on page 940

Freq Lim Low

Lower band limit for RMS value calculation based on the FFT bins.

Freq Limit	<input checked="" type="checkbox"/>	
Frq Lim Low	20.0000	Hz
Frq Lim Upp	43500.0	Hz

Remote command:

[SENSe<n1>:FREQuency:LIMit:LOWer](#) on page 938

Freq Lim Upp

Upper band limit for RMS value calculation based on the FFT bins.

Freq Limit	<input checked="" type="checkbox"/>	
Frq Lim Low	20.0000	Hz
Frq Lim Upp	43500.0	Hz

Remote command:

[SENSe<n1>:FREQuency:LIMit:UPPer](#) on page 938

Avg Mode

Used to activate the averaging function and select the averaging method.

Avg Mode	Exponential
Avg Count	Off
Zooming	Normal

When averaging is activated, an additional parameter field appears in which the average count can be specified.

Note: The energy of the individual bins is averaged, not their levels. This is necessary so that the displayed RMS value, which is computed by integration over all bins (of the averaged FFT), can be correctly determined.

- "OFF" No averaging; each FFT analysis result is displayed immediately and is independent of previous analyses.
- "Exponential" Averaging is performed continuously and displayed. When the current result is calculated, the previous measurements are taken into consideration using a constant factor. The weighting of the current measurement (n) and of the previous measurements (n-1) is determined by the selectable average count (k); the displayed result of the nth measurement (n ≥ 2) is derived using the following formula:

$$AVG(n) = \frac{1}{k} \cdot FFT(n) + \frac{k-1}{k} \cdot AVG(n-1)$$

- "Normal" The specified number of FFT cycles is performed, the partial results added together and then divided by this number. The result does not appear until all "k" cycles have been completed.

Remote command:

[SENSe<n1>:FUNCTion:FFT:AVERage:MODE](#) on page 941

Avg Count

Used to enter the average count; only if averaging is activated.



With "normal averaging", the number entered here determines how many consecutive FFTs are used for averaging.

With "exponential averaging", the number "k" entered here determines the extent to which the previous measurements are taken into consideration in the result. The weighting of the previous measurements is $(k-1)/k$.

If, for example, $k = 20$ is entered as the average count, the current analysis result is weighted by 5 % and the previous measurements by 95 %.

Remote command:

[SENSe<n1>:FUNctIon:FFT:AVERage](#) on page 941

triggered

Triggered FFT



Selectable only with averaging switched off.

"deactivated" Untriggered FFT

"activated" Triggered FFT

The trigger condition is set in the Waveform menu.

Forces activation of the waveform in "Meas Mode" "Standard " (for normal FFT) or in "Meas Mode" "Undersampling" (for Undersampling FFT).

All triggers can be selected, including "Manual" (results in untriggered operation and is therefore not recommended) and "Genburst" (only available on two-channel analyzers).

A "Pretrigger" can be selected.

The parameter field "Autotrigger" at the end of the Waveform menu is permanently disabled (view only) to ensure that data is only collected when the trigger condition occurs.

Remote command:

[SENSe<n1>:FUNctIon:FFT:TRIGgered](#) on page 942

Undersample

Enables undersampling for the FFT.

This functionality is available only

- with installed R&S UPV-K6 option (advanced analysis functions)
- in the "FFT" measuring function
- in conjunction with the post FFT for the distortion measuring functions "THD" and "THD+N"
- if the "FFT" measuring function or the post FFT feature a deactivated "Avg Mode".
- if, in conjunction with the post FFT for the distortion measuring functions "THD" and "THD+N", the "Dynamic Mode" parameter field is set to "Fast".

It is used to increase the frequency resolution for low frequencies so that measurements can be made on extremely low-frequency signals (deep into the infrasonic range) and they can be visualized (along with their harmonics).

Undersample	<input checked="" type="checkbox"/>	
Comp Factor	16	
Span	1.50 kHz	
Start	0.00000	Hz
Stop	1499.63	Hz
Resolution	0.36621	Hz
Meas Time	2.73067	s

In contrast to graphic zooming of a broadband FFT (Undersample OFF), an undersampled FFT analyzes a selectable frequency segment with the full FFT size. The compression factor can be adjusted by powers of 2. The frequency resolution is doubled with each change in the compression factor (with a constant FFT size). However, the measurement time also doubles in parallel. In the interest of short measurement times, unnecessarily high compression factors (and unnecessarily large FFT sizes) should be avoided.

There are two ways to achieve a particular frequency resolution:

- Broadband FFT with large FFT size
- Undersample FFT over a limited frequency band ("Span") with a small FFT size

The time required to acquire the measurement data is the same in both cases. The total time is slightly less with an undersampled FFT, since the smaller number of points means that it takes less time to perform the FFT computation and generate the graphical display. A smaller number of points is also advantageous for external processing of the bins. If the desired frequency resolution is higher than what can be achieved with the maximum FFT size, an undersampled FFT is the only way this requirement can be met.

In the two-channel analog analyzer – when the largest FFT size is used with compression – a frequency resolution of 178 μ Hz (with an FFT bandwidth of 23 Hz) can be achieved. However, in this case the sampling time is about 1.5 hours (5592 s)! The same values apply for the digital analyzer with a sampling rate of 48 kHz.

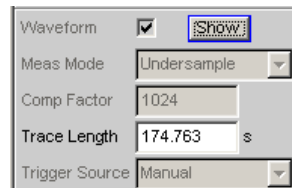
"deactivated" Undersampling disabled; a broadband FFT analysis is performed.

"activated"

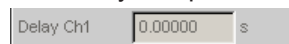
Undersampling enabled; the FFT analysis is performed using a reduced bandwidth but higher frequency resolution. The parameter fields shown above are displayed.

If "Undersample FFT" is enabled, some instrument settings are configured to fixed default values that cannot be changed by the user:

- "Waveform Monitor" is enabled and configured with fixed settings. The FFT compression factor is copied to the Waveform Compression factor. Although "Trace Length" can be entered by the user, its minimum value is limited to the FFT measurement time.

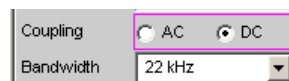


- FFT delay compensation is disabled.

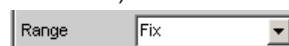


The following "recommendations" also apply:

- The analog analyzer should be set to DC coupling and the narrowest bandwidth



- Autoranging in the analog analyzer should be disabled (for both channels)



- If signal components outside the selected FFT bandwidth are expected to be present, they must be blocked by using a digital lowpass filter in order to avoid corrupting the measurement. This filter can be enabled as a function filter or a prefilter. Its cut-off frequency should be less than or equal to the selected FFT bandwidth.

If the "Comp Factor" undersampling factor or the "Span" is changed, a warning indicates the necessity of the lowpass filter.



Note: Continuous processing of the measurement data over a relatively long time is only guaranteed for sampling rates up to 96 kHz or analog bandwidths up to 40 kHz. If the sampling rate is too high or the bandwidth is too large, the measurement will be terminated with a suitable error message. If this happens, it may be necessary to reduce the number of analyzer filters that are being used.

Remote command:

[SENSe<n1>:FUNction:FFT:USAMple](#) on page 942

Comp Factor

Numeric entry of the compression factor; only possible if "Undersample FFT" is enabled.

Comp Factor	16
-------------	----

The compression factor entered is adjusted to the closest integer power of 2 (2, 4, 8, ..., 1024).

The number specified here determines the reduction factor for the total band (sampling frequency / 2). The resulting frequency band corresponds to the "Span" value.

Note: If a multichannel analyzer is used, max. 1.44 million samples can be monitored. This is why compression is only possible up to a factor of 4.

Remote command:

[SENSe<n1>:FUNction:FFT:CMpFactor](#) on page 941

Span

Selection of the FFT bandwidth; only possible if "Undersample FFT" is enabled.

Span	1.50 kHz
Start	12.00 kHz
Stop	6.00 kHz
Resolution	3.00 kHz
Meas Time	1.50 kHz
Level Monitor	750 Hz
Input Monitor	375 Hz
Freq/Phase	188 Hz
	94 Hz
	47 Hz
	23 Hz

The displayed parameter list is generated dynamically as a function of the current sampling rate (or bandwidth). The selected value is directly related to the compression factor; reducing the span by a factor of two thus corresponds to doubling the compression factor.

If a multichannel analyzer is used, max. 1.44 million samples can be monitored. Therefore, only 2 compression levels are available here; for example 24 kHz and 12 kHz with an analog bandwidth of 40 kHz.

In the case of an undersample FFT, the selected "Span" value determines the frequency band that is analyzed by the FFT. The start and end values of this frequency band are shown under "Start" (always 0 Hz) and "Stop".

The frequency range that is actually shown ("Stop" value) is one bin smaller than the selected "Span" value.

Remote command:

[SENSe<n1>:FUNction:FFT:SPAN](#) on page 942

Start

Start value of the FFT frequency band (display only)

Start	0.00000	Hz
-------	---------	----

Remote command:

[SENSe<n1>:FUNction:FFT:START?](#) on page 942

Stop

End value of the FFT frequency band (display only)

Stop	1499.99	Hz
------	---------	----

In the case of a broadband FFT in the digital analyzer, this is 23 or 48 times the sampling frequency; in the case of an undersample FFT, the value here is the "Span" value less one bin.

Remote command:

[SENSe<n1>:FUNction:FFT:STOP?](#) on page 942

Resolution ← Stop

Displays the frequency resolution.

Resolution	5.85938	Hz
------------	---------	----

The frequency resolution is the quotient of sampling rate and FFT size.

Remote command:

[SENSe<n1>:FUNction:FFT:RESolution?](#) on page 941

Meas Time ← Stop

Displays the integration time.

Meas Time	170.667	ms
-----------	---------	----

The integration time is the quotient of FFT size and sampling rate.

Remote command:

[SENSe<n1>:FUNction:FFT:MTIME?](#) on page 941

5.31 Perceptual evaluation of speech quality (PESQ)

This measuring function is available only with installed R&S UPV-K61 option and it is provided as single-channel measurement for the analyzers Analog, Dig Audio, I²S and USI Dual Chan.

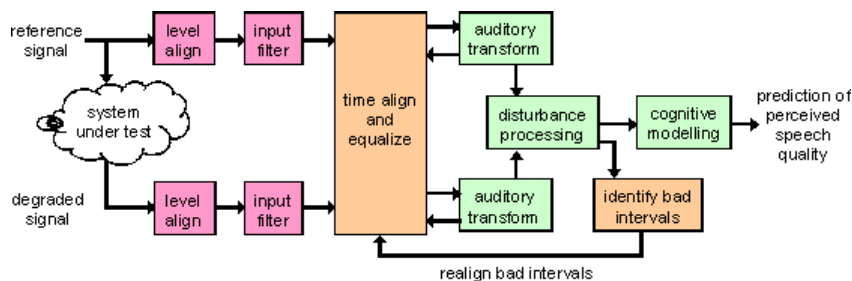
The Perceptual Evaluation of Speech Quality (PESQ) measurement process, which was published by the **International Telecommunication Union** in 2001 as **Recommendation ITU-T P.862**, permits the measurement of the quality of voice signals which are transmitted at a low bit rate with the assistance of highly compressing psychoacoustic coding processes. PESQ employs an algorithm that enables these signals to be evaluated by comparing them with reference signals. The R&S UPV provides this measurement – licensed by **OPTICOM Dipl.-Ing. M. Keyhl GmbH, Erlangen, Germany**. PESQ® is a registered trademark of said company and of Psytechnics Ltd., UK.

A common feature of all psychoacoustic coding methods is that they utilize the properties of the human hearing to modify the transmitted signal so that the portions of the signal that would in any case not be perceived are removed from the signal. Compression can be made even simpler with speech signals, since they occupy considerably less bandwidth than other types of signals such as music. When speech compression is used, it is necessary to be able to determine objectively, with the aid of psycho-

acoustic measuring methods, whether such speech transmission paths produce unacceptable changes to the signal.

PESQ was developed using a large number of recordings containing sentences spoken by a variety of speakers in a variety of languages. The recordings were made using several different speech encoders having different levels of quality and with typical network transmission disturbances. In a series of listening tests, an adequate number of test listeners classified these examples on the well-known speech quality scale ranging from 1 (bad) to 5 (excellent).

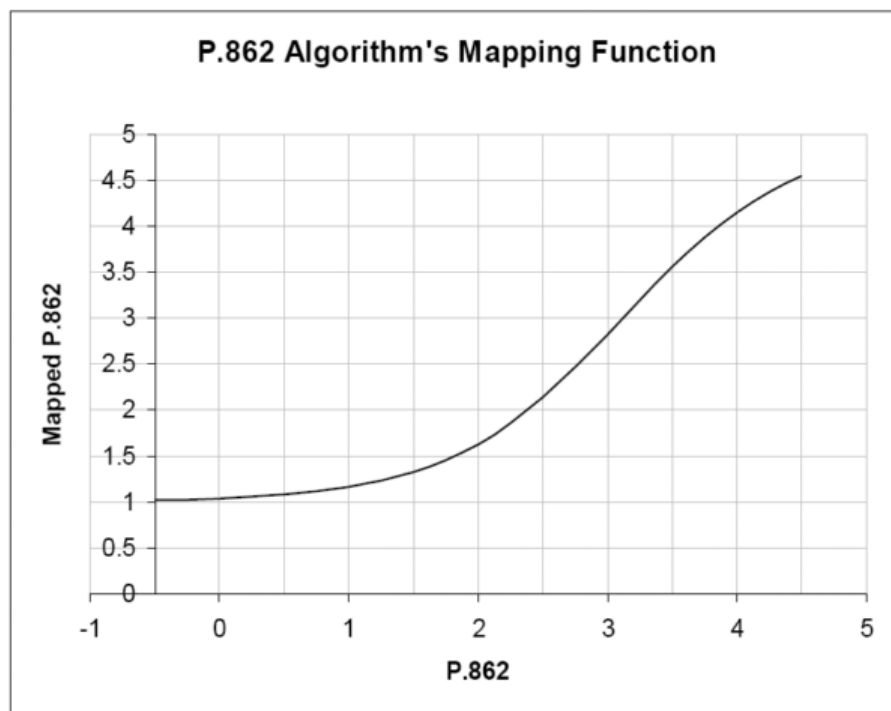
The goal in the development of PESQ was to develop a method for determining an objective measured value MOS (mean opinion score) that correlates very well with the listening test results, based on comparing the original, undegraded speech signal (the reference signal) with the degraded signal (the measured signal). This means that in order to perform a PESQ measurement, the reference signal must be connected to the input of the system under test and the measurement signal must be taken from the output of the system under test.



Remote-control command: `SENSe<n1>:FUNction` on page 929 PESQ

5.31.1 PESQ Value and MOS Value

With recommendation P.862 the ITU has standardized a method for calculating objective measured values to match the subjective MOS values of the listening test results. The calculation of the objective MOS value is based on the PESQ value and is performed by using a mapping function such as the example shown below.



The MOS value is plotted on the y-axis according to P.862.1; the x-axis shows the associated PESQ value according to P.862.

The R&S UPV implements the three most important measuring methods, which differ only slightly from each other and have been approved by the ITU:

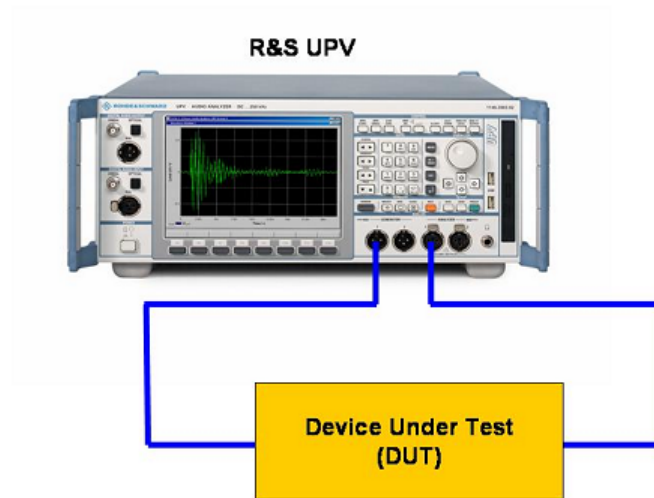
- "ITU-T P.862: "
The measured value is the PESQ Score. The range of values extends from -0.5 (worst) to +4.5 (best).
- "ITU-T P.862.1: "
The measured value is called the MOS-LQON (Listening Quality Objective Narrow-band). The range of values extends from -0.5 (worst) to +4.5 (best).
- "ITU-T P.862.2: "
This is the wideband extension of P.862. The measured value is the MOS-LQOW (Listening Quality Objective Wideband). The range of values extends from -0.5 (worst) to +4.5 (best). Note that measurements obtained using this option cannot be compared with results obtained in accordance with P.862 or P.862.1!

The measured values can be displayed for the total signal or made with reference to the speech component or the silence component of the signal. The latter is particularly interesting because it shows how well a codec substitutes background noise.

5.31.2 Electrical PESQ Measurements

Producers of new psychoacoustic coding methods wish to optimize their algorithms for speech transmission, and network operators need suitable test tools that supplement the already commonly used signal and distortion measurements. This type of measure-

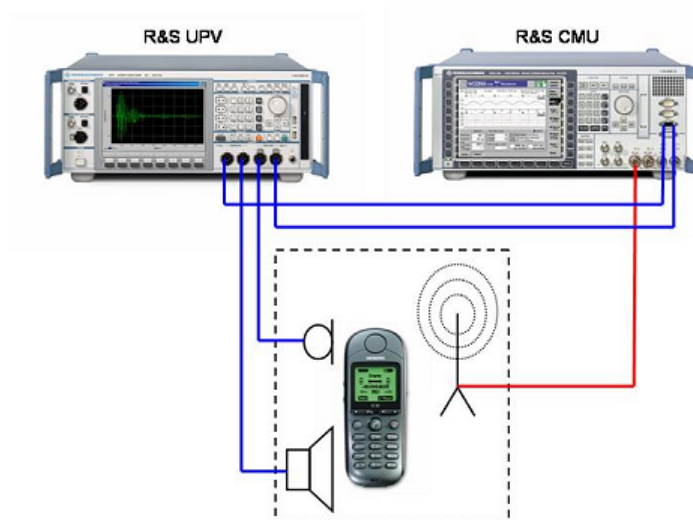
ment is typically performed electrically, directly at the input and output ports of the R&S UPV.



The figure shows how the reference signal is routed from the generator output to the device under test, and the output of the device under test is fed back to the analyzer as the measurement signal. At the same time, the original reference signal is routed internally to the analyzer so it can access both signals for the evaluation.

5.31.3 Acoustic PESQ Measurements

Manufacturers of mobile telephones increasingly wish use speech quality as a way to make their products stand out from the competition. Speech quality is essentially influenced by the coding method used in the mobile telephone. In this case, PESQ measurements are made under realistic conditions by using an acoustic link to the mobile telephone. The measurement setup consists of a combination of the R&S CMU radio communication tester and the R&S UPV audio analyzer.



The reference signal is sent to the mobile telephone via an acoustic transducer (artificial mouth). It is coded in the mobile telephone and then sent to the R&S CMU via a radio link. It is decoded in the CMU and sent to the input of the analyzer as the measurement signal. As with electrical measurement, the original reference signal is also routed internally to the analyzer so that it can access both signals for the evaluation. In the opposite direction, the reference signal is sent to the R&S CMU, where it is coded and transmitted to the mobile telephone via the radio link. Another acoustic transducer (artificial ear) converts the speech signal emerging from the speaker of the mobile telephone into the measurement signal.

Good acoustic coupling between mobile phone and artificial ear is needed for measurements in receiving direction of the phone. Any background noise should be as low as possible. Thus acoustic measurements should be conducted in a sound isolated chamber.

PESQ measurements should not be used for hands-free measurements or to assess the influence of background noise.

The advantages of the R&S UPV can be fully exploited with acoustic measurements: Due to the outstanding characteristics of the analog hardware, no PESQ-relevant quality impairments arise in the measured signal even when there are large differences in signal level between the output and input signals. In addition, a simple application running in the R&S UPV can utilize the dual-channel capability of the R&S UPV to make measurements in both directions (transmit and receive) without any changes to the test setup. The results can then be displayed in a single graph. Relevant application documents and programs can be found under www.Rohde-Schwarz.com, Downloads, Application Notes: **1GA49**: Psychoacoustic Audio Quality Measurements Using R&S®UPV Audio Analyzer and **1GA50**: Calibration Tool for PESQ Speech Quality Tests.

5.31.4 PESQ Graphs

For PESQ measurements, the "Waveform Monitor " is used to check the signal in the time domain. In particular, the specified silence periods at the start and end of the test signal can be checked, as well as correct signal amplitude.

- The waveform is activated in the analyzer function panel and configured with regard to the trigger condition and memory depth. The Waveform graphics dialog can also be opened from here.
- The scaling (including limit checking and the reference source) are selected in the Waveform Config panel.
- The graphic display is shown in the Waveform graphics dialog.

The R&S UPV offers in form of the "PESQ graph " panels two more graphic displays in connection with the PESQ measurement. This is because the measurement process analyzes the signals in small increments and determines the measured value (PESQ_MOS) and the time delay (Delay) between the reference signal and the measured signal for each increment. The measurement display always shows the selected measured value relative to the entire signal. Using the graphs, it is also possible to see the regions of the reference signal where the measured codec deviates from the expected behavior. The values plotted against time are displayed in the "PESQ Graph"

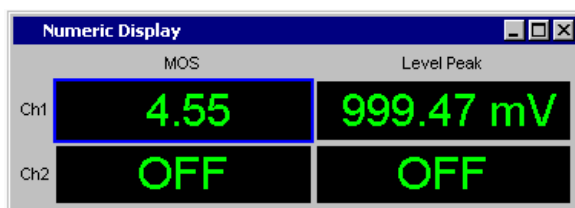
graphical systems. In wideband mode P862.2 the MOS value against time can not be displayed with the current version of the PESQ software.

- The desired signal (PESQ or MOS versus time or delay versus time) in "PESQ Graph Config", as well as the scaling – including the limit test – is selected.
- The graph is shown in the PESQ Graph graphics dialog.

In addition, the reference and/or measurement signal curves as well as a display of the dropouts can be shown in the PESQ Graph windows. Depending on the signal selected on the other axis, the resolution on the x-axis is selected automatically so that both signals can always be displayed in the same graphic. For example, the resolution of "MOS versus time" is much smaller than "reference signal versus time", so the graph shows the reference signal in reduced resolution – but without swallowing samples. In contrast, in the display of "delay versus time" vis-à-vis "reference signal versus time" there is a much higher resolution on the x-axis; it corresponds to the resolution of the WAV file.

- In "PESQ Graph Config" the desired comparison signal (reference signal versus time or measurement signal versus time or dropouts versus time) and the scaling is selected.
- The graph is shown in the PESQ Graph graphics dialog.
- "Reference signal versus time" corresponds to the waveform of the reference signal.
- "Measurement signal versus time" corresponds to the waveform of the measurement signal. This waveform can also be shown in full resolution in a separate graphic via the "Waveform Monitor" function.
- "Dropouts versus time" corresponds to a hypothetical representation in which the values of an amplitude- and time-corrected measurement signal and the reference signal are subtracted from each other in proper phase relation and thus only the stray signals deviate from the zero line.

The "Numeric Display " shows the PESQ or MOS value.



The Level Monitor indicates the RMS or peak value of the total test signal (after the measurement). During measurement intermediate values are displayed. The peak indication should be used to check the correct level for the selected measurement range. The peak value must not be more than 3 dB above the nominal value of the measurement range.

5.31.5 PESQ Measurement Function

The Perceptual Evaluation of Speech Quality (PESQ) measurement process, which was published by the **International Telecommunication Union** in 2001 as **Recom-**

Recommendation ITU-T P.862, permits the measurement of the quality of voice signals which are transmitted at a low bit rate with the assistance of highly compressing psychoacoustic coding processes. PESQ employs an algorithm that enables these signals to be evaluated by comparing them with reference signals. A general introduction to PESQ can be found in [chapter 5.31](#), "Perceptual evaluation of speech quality (PESQ)", on page 541.

In Recommendation P.862.3, the ITU defined the criteria by which reference signals for the PESQ measurement must be generated:

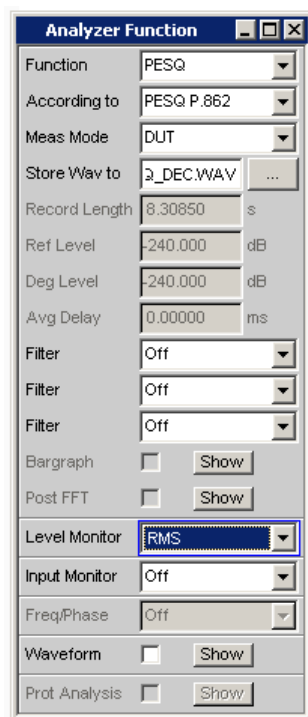
- The reference signal must be mono and have a sample rate of 8 kHz or 16 kHz.
- There should be at least 0.5 seconds of silence at the beginning and end of the signal. Silence of up to 2 seconds is recommended for devices under test with large delay.
- In realtime mode of R&S UPV (Meas Mode = DUT) the length of the test signal is identical to the length of the reference signal. The delay of the device under test must not be longer than the silence at the end of the reference signal, because otherwise the end of the speech signal is not measured.
- The ratio between speech and silence must be suitable for the particular application. The duration of the speech portion should be at least 3.2 seconds and should be within 40 % to 80 % of the total signal length.
- The speakers must come as close as possible to the application in pitch and cadence; for example, at least one female and one male voice should dictate representative texts in the target language.

It is strongly recommended to follow ITU-T P.862.3 paper.

Function

switching the measurement function to PESQ

Note: PESQ measurements require the generator settings "Bandwidth = Play Auto", generator function "Play" and analyzer settings single channel with "Fix Range".



The measurement plays back the WAV file selected in the generator and compares its content with the measured signal. Only files with a sample rate of 8 or 16 kHz can be used as a source.

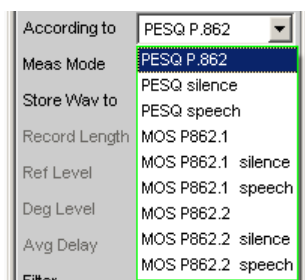
Note: The PESQ measurement is always performed as a single measurement. i.e. even when the START button is pressed the measurement is also automatically ended as soon as the measured values are available.

Remote command:

[SENSe<n1>:FUNctIon](#) on page 929

According to

Select the display mode for the PESQ or MOS value



This setting specifies whether the PESQ value or MOS value should be referenced to the entire signal or only to the speech portion or the silence portion.

Switching over the display mode does not trigger a new measurement but calculates the desired PESQ or MOS value from the last logged record according to the selected process. The respective measurement result is thus immediately available.

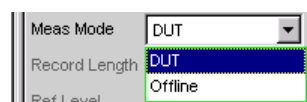
"PESQ P.862"	The measured PESQ value is referenced to the entire reference signal. The calculation conforms to the ITU-T P.862 standard. The y-axis label in the PESQ/POLQA graphic is called "PESQ Score".
"PESQ Silence"	The measured PESQ value is referenced to the silence portion of the reference signal. The calculation conforms to the ITU-T P.862 standard. The y-axis label in the PESQ/POLQA graphic is called "PESQ Score (SI)".
"PESQ Speech"	The measured PESQ value is referenced to the speech portion of the reference signal. The calculation conforms to the ITU-T P.862 standard. The y-axis label in the PESQ/POLQA graphic is called "PESQ Score (SP)".
"MOS P862.1"	The measured MOS value is referenced to the entire reference signal. The mapping of the measurement conforms to the ITU-T P.862.1 standard. The y-axis label in the PESQ/POLQA graphic is called "MOS-LQON".
"MOS P862.1 silence"	The measured MOS value is referenced to the silence portion of the reference signal. The mapping of the measurement conforms to the ITU-T P.862.1 standard. The y-axis label in the PESQ/POLQA graphic is called "MOS-LQON (SI)".
"MOS P862.1 speech"	The measured MOS value is referenced to the speech portion of the reference signal. The mapping of the measurement conforms to the ITU-T P.862.1 standard. The y-axis label in the PESQ/POLQA graphic is called "MOS-LQON (SP)".
"MOS P862.2"	The measured MOS value is referenced to the entire reference signal. The mapping of the measurement conforms to the ITU-T P.862.2 standard. The y-axis label in the PESQ/POLQA graphic is called "MOS-LQOW".
"MOS P862.2 silence"	The measured MOS value is referenced to the silence portion of the reference signal. The mapping of the measurement conforms to the ITU-T P.862.2 standard. The y-axis label in the PESQ/POLQA graphic is called "MOS-LQOW (SI)".
"MOS P862.2 speech"	The measured MOS value is referenced to the speech portion of the reference signal. The mapping of the measurement conforms to the ITU-T P.862.2 standard. The y-axis label in the PESQ/POLQA graphic is called "MOS-LQOW (SP)".

Remote command:

[SENSe<n1>:FUNCTION:PESQ:ACCORDing](#) on page 944

Meas Mode

Select the measurement mode for PESQ measurement



This setting specifies whether a measurement is to be made in realtime (DUT) or whether an offline evaluation of a previously stored WAV file is to be performed ("Offline").

- "DUT" The PESQ measurement is performed in realtime. The reference WAV file is played back; the measurement signal is simultaneously recorded at the analyzer. The measurement signal has the same length as the reference signal. If there is a delay in the device under test, the silence at the end of the reference signal must be longer than this delay to make sure that the speech portion is completely recorded. The evaluation is performed immediately after playback of the reference signal is finished.
- "Offline" The PESQ measurement is to be performed for already stored WAV files. After the files containing the reference signal and the measurement signal are specified, the evaluation can be started by pressing the START button.
Possible sample rate of the stored WAV files can be 8, 16, 48 or 96 kHz. The length of the recorded signal must be at least the length of the generator reference signal.

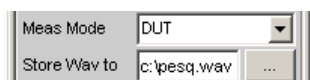
Remote command:

[SENSe<n1>:FUNctIon:MMODE](#) on page 931

Store WAV to

Allows the measured signal to be stored as a WAV file

(only if Meas Mode="DUT").



The WAV file is always stored in the same sample rate in which the reference signal is present.

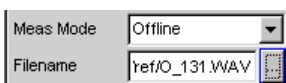
Remote command:

[MMEMory:STORe:PWAVeform](#) on page 944

File Name

Selects the WAV file containing the stored measurement data

(only if Meas Mode = "Offline")

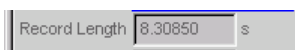


Remote command:

[MMEMory:LOAD:PWAVeform](#) on page 943

Record Length

Shows the length of the WAV file selected for the reference signal in the generator function panel.

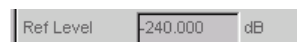


Remote command:

[SENSe<n1>:FUNctIon:RECORD:LENGth](#) on page 952

Ref Level

Shows the RMS value of the reference signal (after the measurement)



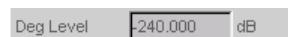
The RMS value of the reference signal is shown in dB relative to the full-scale value of the reference signal file.

Remote command:

[SENSe<n1>:FUNction:PESQ:REFLevel?](#) on page 944

Deg Level

Shows the RMS value of the measurement signal (after the measurement)



The RMS value of the measurement signal is shown in dB referenced to the full scale value of the measurement signal file.

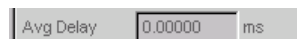
The PESQ algorithm is configured properly if the difference between Ref Level and Deg Level is as small as possible, less than 10 dB is recommended. PESQ measurement can compensate for differences of up to 30 dB.

Remote command:

[SENSe<n1>:FUNction:PESQ:DEGLLevel?](#) on page 944

Avg Delay

Shows the average time offset between the reference signal and the measurement signal (after the measurement)



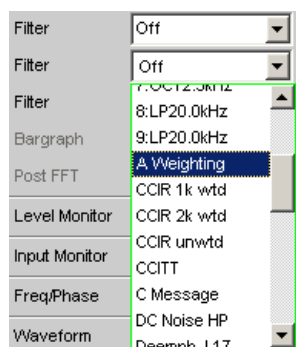
The reference and measurement signals are internally divided into small time frames. The time offset between the two signal paths is measured for each of these frames. The displayed value is the average of all of the measured offset values for the entire signal.

Remote command:

[SENSe<n1>:FUNction:PESQ:AVGDelay?](#) on page 944

Filter

Activating a digital filter in the test channel. Up to three user-defined or weighting filters can be looped into the test channel:



The user-definable filters are configured as filters 01 to 09 in the filter panel (see [chapter 5.44, "User-Definable Filters"](#), on page 628) and can then be used (repeatedly if necessary) in the analyzer.

The selectable weighting filters are described in the section [chapter 5.45, "Weighting Filters"](#), on page 637.

Note: Regardless of the digital filters selected here, a further input filter ("prefilter") can be looped into the test channel.

Remote command:

`SENSe<n1>:FILTer<n2>` on page 958

For a description of the filters and their setting parameters, see [chapter 5.43.4, "Filter Table"](#), on page 628.

5.32 Audio quality measurements (PEAQ)

This measuring function is available only with installed R&S UPV-K62 option and is provided as dual-channel measurement with the analyzers Analog, Dig Audio, I²S and USI Dual Chan.

The "Perceptual Evaluation of Audio Quality" ("PEAQ") measurement process, which was published by the International Telecommunication Union in 1998 as Recommendation ITU-R BS.1387, permits the measurement of the quality of sound signals which are transmitted at a low bit rate with the assistance of compressing psychoacoustic coding processes. "PEAQ" employs an algorithm that enables these signals to be evaluated by comparing them with reference signals. The R&S UPV provides this measurement – licensed by OPTICOM Dipl.-Ing. M. Keyhl GmbH, Erlangen, Germany. "PEAQ"® is a registered trademark of said company.

A common feature of all psychoacoustic coding methods is that they utilize the properties of the human hearing to modify the transmitted signal so that the portions of the signal that would in any case not be perceived are removed from the signal. Whether such a transmission link for general sound signals such as music causes impermissible changes to the signal must be objectively verifiable with the assistance of suitable psychoacoustic measurement procedures.

A large number of recordings containing music signals of different kinds were used for developing "PEAQ". The recordings were overlaid with interference typically caused by filters and also by using various coders and thus qualities. A sufficiently large number of test listeners classified these examples in a series of listening tests on the familiar scale for audio quality from 1 (bad) to 5 (excellent). In contrast to the measurement of speech quality also available in the R&S UPV ("PESQ"), with "PEAQ" the listeners have always had the comparison with the original signal. A negative scale, the so-called "SDG" value ("Subjective Difference Grade") emerges from the comparison for the difference between the quality of the test signal and the quality of the reference signal. The worse the test signal becomes compared to the reference signal, the more negative the "SDG" value.

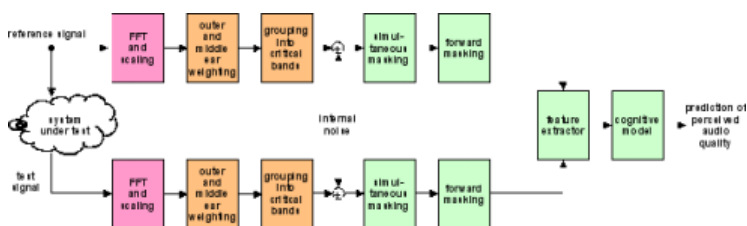
"SDG" = "Grade"_{Signal Under Test} – "Grade"_{Reference Signal}

Impairment	Grade	SDG
Imperceptible	5.0	0.0
Perceptible, but not annoying	4.0	-1.0
Slightly annoying	3.0	-2.0
Annoying	2.0	-3.0
Very annoying	1.0	-4.0

The goal in the development of "PEAQ" was to develop a method for determining an objective measured value MOS (mean opinion score) that correlates very well with the listening test results, based on comparing the original, undegraded speech signal (the reference signal) with the degraded signal (the measured signal). Though the results of subjective and objective assessment correlate very well, is it not possible to directly compare the numeric results of "SDG " and "ODG ".

The "PEAQ " measurement is then performed in such a way that the system to be tested is connected at its input to the reference signal and the measurement signal is measured at its output.

The next figure shows the block diagram of the PEAQ algorithm's Basic model.



The "PEAQ " measurement process was designed for signals with small impairments (almost transparent studio quality) and a constant delay. But it is nevertheless suitable for the assessment of signals with larger impairments.

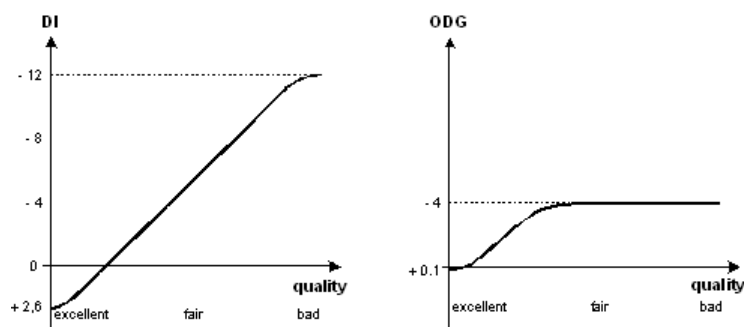
It is not suitable, for example, for assessing loudspeakers, cables, speech codecs, and IP-based interference (variable delay and packet losses).

It was not yet validated for codecs with extremely low bit rates, e.g. those ones using the method of spectral band replication.

Remote-control command: `SENSe[1]:FUNcTion PEAQ`

5.32.1 DI value and ODG value

The "ODG " value ("Objective Difference Grade ") directly corresponds to the result of the objective measurement and correlates with the "SDG " value of the listening test. The calculation is done using a so-called mapping function, as shown here in the example.



"Distortion Index " ("DI ") and Objective Difference Grade ("ODG ")

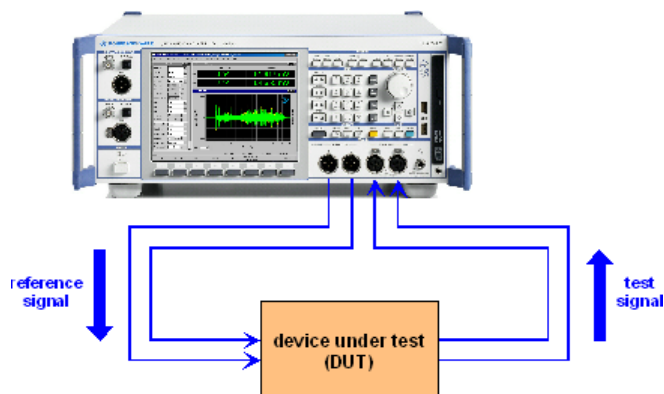
The "ODG " or "DI " value calculated by the "PEAQ " algorithm is depicted on the y-axis; the x-axis points in the direction of sinking "SDG " values, i. e. lower quality.

The R&S UPV calculates both the "ODG " and the "DI " value for each measurement and displays them in channels 1 and 2 of the function column of the Numeric Display respectively. Since the saturation of the mapping functions for "ODG " and "DI " are different, the following basic rule applies when reading them off:

- "ODG " should be read off as long as "ODG " is greater than -3.6
- "DI " should be read off as soon as "ODG " becomes smaller than -3.6

5.32.2 PEAQ measurements

The manufacturers of psychoacoustic compression processes such as MP3 or also surround coders want to optimize their algorithms for sound transmission; manufacturers of playback devices are able to assess the audio quality in addition to the usual signal and distortion measurements.



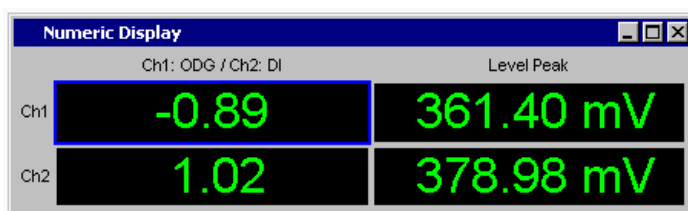
The figure shows how the reference signal is routed from the generator output to the device under test, and the output of the device under test is fed back to the analyzer as the measurement signal. At the same time, the original reference signal is routed internally to the analyzer so it can access both signals for the evaluation.

5.32.3 PEAQ graphics

With PEAQ measurement, the "Waveform Monitor " is used to check the signal in the time domain. The recommended periods of silence at the beginning and the end of the test signal and also the correct level range can be checked here.

- The waveform is activated in the analyzer function panel and configured with regard to the trigger condition and memory depth. The Waveform graphics dialog can also be opened from here.
- The scaling (including limit checking and the reference source) are selected in the Waveform Config panel.
- The graphic display is shown in the Waveform graphics dialog.

The "Numeric Display " shows the ODG and the DI value.



The Level Monitor indicates the RMS or peak values of both channels of the total test signal (after the measurement). During measurement intermediate values are displayed. The peak indication should be used to check the correct level for the selected measurement range. The maximum peak value must not be more than 3 dB above the nominal value of the measurement range.

5.32.4 PEAQ measurement function

The Perceptual Evaluation of Audio Quality (PEAQ) measurement process, which was published by the International Telecommunication Union in 1998 as Recommendation ITU-R BS.1387, permits the measurement of the quality of sound signals which are transmitted at a low bit rate with the assistance of compressing psychoacoustic coding processes. PEAQ is an algorithm that permits these signals to be analyzed by comparing them with the reference signal. A general introduction to PEAQ, can be found in [chapter 5.32, "Audio quality measurements \(PEAQ\)"](#), on page 552. PEAQ is available in the R&S UPV as a digital and an analogue measurement and mixed operation is also possible.

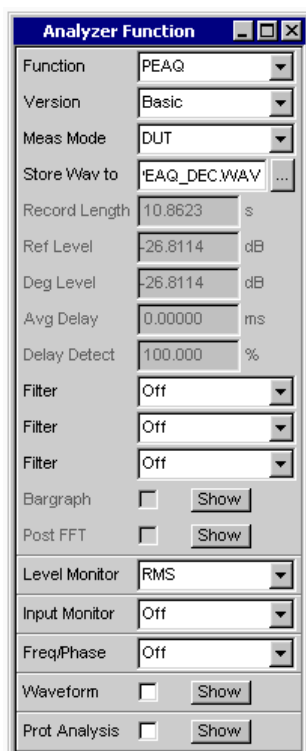
- The reference signal must be dual-channel and available with a sample rate of 48 kHz.
- There should be at least 0.5 seconds of silence at the beginning and end of the signal.
- In realtime mode of R&S UPV (Meas Mode = "DUT ") the length of the test signal is identical to the length of the reference signal. The delay of the device under test must not be longer than the silence at the end of the reference signal, because otherwise the end of the music signal is not measured.

- The ODG value is displayed in channel 1 and the DI value in channel 2. Both values are, however, respectively based on the overall dual-channel signal.

Function

Switching over the measurement function to "PEAQ".

Note: The "PEAQ " measurement requires the settings bandwidth = PlayAuto or a fixed bandwidth of 22 kHz and generator function Play for the analog generator. The analogue analyzer must be set to dual-channel, with 22 kHz bandwidth and with fixed range (the same for both channels). In digital domain generator and analyzer must be set to dual-channel and 48 kHz sample rate.



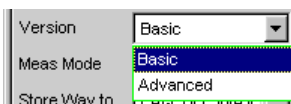
The measurement plays back the WAV file selected in the generator and compares its content with the measured signal. Only files with a sample rate of 48 kHz can be used as a source.

Remote command:

[SENSe<n1>:FUNction](#) on page 929

Version

Selection of the model version for the calculation of "ODG " and "DI " value



This setting specifies whether the Basic or the Advanced model is to be used.

"Basic" The measured value is based on the ITU-R BS-1387 basic procedure with just one ear model.

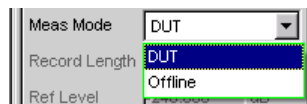
"Advanced" The measured value is based on the advanced procedure with a second ear model for refining the time resolution.

Remote command:

[SENSe<n1>:FUNction:PEAQ:VERSion](#) on page 946

Meas Mode

Selection of the measurement mode for the "PEAQ " measurement.



This setting specifies whether a measurement is to be made in real time ("DUT ") or whether an offline evaluation of a previously stored WAV file is to be performed ("Offline").

"DUT" The PEAQ measurement is performed in realtime. The reference WAV file is played back; the measurement signal is simultaneously recorded at the analyzer. The evaluation is performed immediately after playback of the reference signal is finished. The sample rate of the stored WAV files must be 48 kHz, otherwise the PEAQ measuring function is aborted.

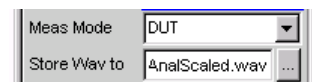
"Offline" The PEAQ measurement is to be performed on previously stored WAV files. After the files containing the reference signal and the measurement signal are specified, the evaluation can be started by pressing the START button.
The sample rate of the stored WAV files must be 48 kHz, otherwise it is rejected. The length of the recorded signal must be at least the length of the generator reference signal.

Remote command:

[SENSe<n1>:FUNction:MMODE](#) on page 931

Store WAV to

Permits the measured signals to be stored as a WAV file (with Meas Mode = "DUT " only).



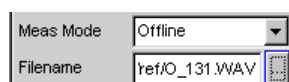
The WAV file is always stored with a sampling rate of 48 kHz.

Remote command:

[MMEMory:STORE:PWAVEform](#) on page 944

File Name

Selects the WAV file with the stored measurement data (with Meas Mode = DUT only)

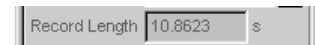


Remote command:

[MMEMory:LOAD:PWAVEform](#) on page 943

Record Length

Shows the length of the WAV file selected for the reference signal in the generator function panel.

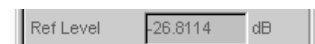


Remote command:

[SENSe<n1>:FUNction:RECORD:LENGTH](#) on page 952

Ref Level

Displays the RMS value of the reference signal after measurement.



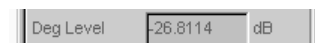
The RMS value of the reference signal is shown in dB relative to the full-scale value of the reference signal file. Both channels are averaged.

Remote command:

[SENSe<n1>:FUNction:PEAQ:REFLevel?](#) on page 945

Deg Level

Displays the RMS value of the measurement signal after measurement.



The "RMS " value of the measurement signal is shown in dB referenced to the full scale value of the measurement signal file for the "PEAQ " algorithm. Both channels are averaged.

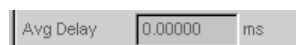
The PEAQ algorithm is configured properly if the difference between Ref Level and Deg Level is as small as possible, less than 10 dB is recommended. PEAQ measurement can compensate for differences of up to 30 dB.

Remote command:

[SENSe<n1>:FUNction:PEAQ:DEGLevel?](#) on page 945

Avg Delay

Displays the time offset between the reference and the measurement signals after measurement.



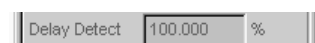
The PEAQ algorithm can only correctly process signals with a constant time offset of less than 1 second.

Remote command:

[SENSe<n1>:FUNction:PEAQ:AVGDelay?](#) on page 945

Delay Detect

Displays (after the measurement) how good the algorithm could compensate the time offset between the reference and the measurement signal.



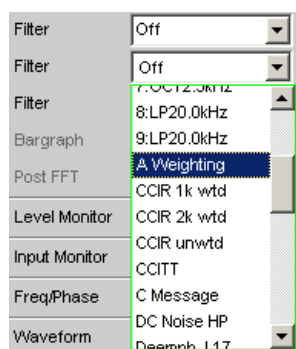
The value should be close to 100 %. For strongly periodic signals and/or signals with severe distortions this value can be significantly lower. Values below 70 % indicate that the ODG and DI values may become uncertain. In this case a subjective verification – by listening to the signals - is recommended.

Remote command:

`SENSe<n1>:FUNction:PEAQ:DELDetect` on page 945

Filter

Activating a digital filter in the test channel. Up to three user-defined or weighting filters can be looped into the test channel:



The user-definable filters are configured as filters 01 to 09 in the filter panel (see [chapter 5.44, "User-Definable Filters"](#), on page 628) and can then be used (repeatedly if necessary) in the analyzer.

For more information on the available weighting filters, see [chapter 5.45, "Weighting Filters"](#), on page 637.

Note: Regardless of the digital filters selected here, a further input filter ("prefilter") can be looped into the test channel.

Remote command:

`SENSe<n1>:FILTer<n2>` on page 958

For a description of the filters and their setting parameters, see [chapter 5.43.4, "Filter Table"](#), on page 628.

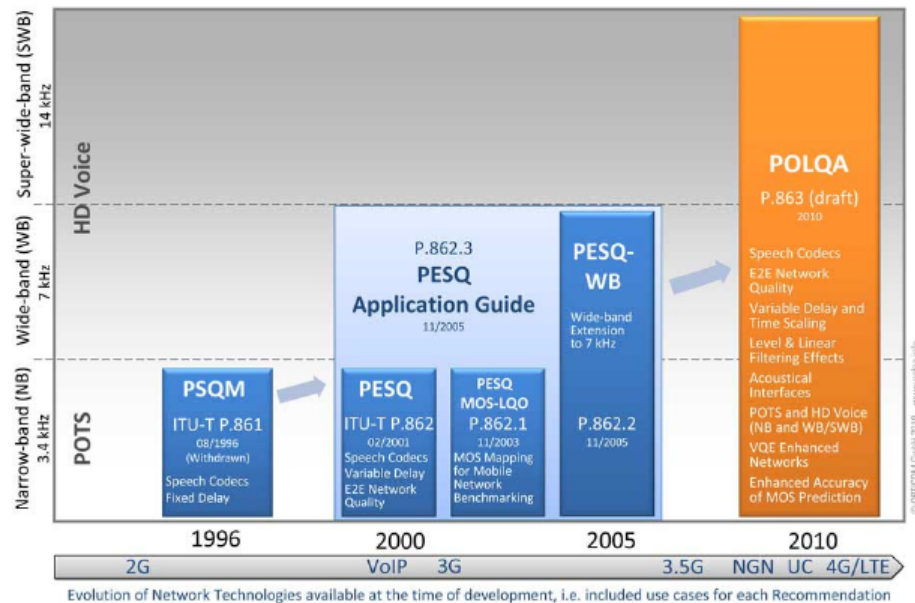
5.33 Objective listening quality measurements (POLQA)

This measuring function is available only with installed R&S UPV-K63 option, and as single-channel measurement is possible only with the analog analyzer.

The Perceptual Objective Listening Quality (POLQA) measurement process, which was published by the **International Telecommunication Union** in 2010 as **Recommendation ITU-T P.863**, permits the measurement of the listening quality of sound signals which are transmitted with the assistance of highly specialized psychoacoustic coding processes. POLQA is an algorithm which permits these signals to be analyzed by comparing them with the reference signal. The R&S UPV provides this measurement – licensed by **OPTICOM Dipl.-Ing. M. Keyhl GmbH, Erlangen, Germany**. POLQA® is a registered trademark of said company.

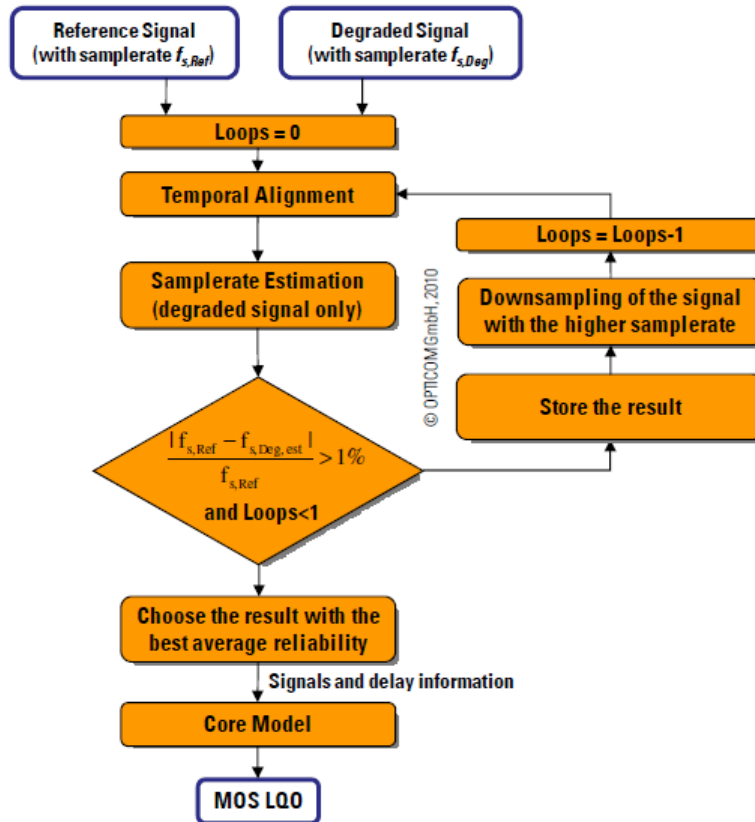
What is POLQA: POLQA is an uncompromising continuous development of the PSQM and PESQ measuring methods with respect to the larger transmission bandwidths and sampling rates of the new mobile radio standards HD Voice, 3G and 4G/LTE. The goal is to optimize not only the pure voice transmission, but it should also be possible to play back music signals distortion-free with up to 48 kHz.

Evolution of ITU-T Recommendations for Voice Quality Testing (P.86x - Full Reference MOS-LQO)



Who needs POLQA: Mobile radio operators, measuring technology providers, particularly providers of benchmarks for the mobile radio networks 3G, 4G/LTE and NGN. All users of the PESQ algorithm will require POLQA in the future. POLQA will offer a significantly improved accuracy for 3G as well as good support for Next Gen Networks and 4G/LTE.

Similar to PESQ and PEAQ, the goal in the development of POLQA was to develop a method for determining an objective measured value MOS (mean opinion score) that correlates very well with the listening test results, based on comparing the original, undegraded voice or music signal (the reference signal) with the degraded signal (the measured signal). This means that in order to perform a POLQA measurement, the reference signal must be connected to the input of the system under test and the measurement signal must be taken from the output of the system under test.

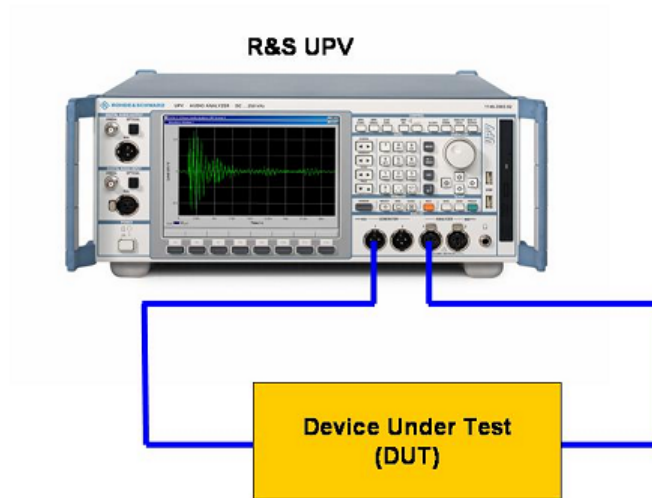


Remote-control command:

[SENSe<n1>:FUNction](#) on page 929 POLQa

5.33.1 Electrical POLQA measurements

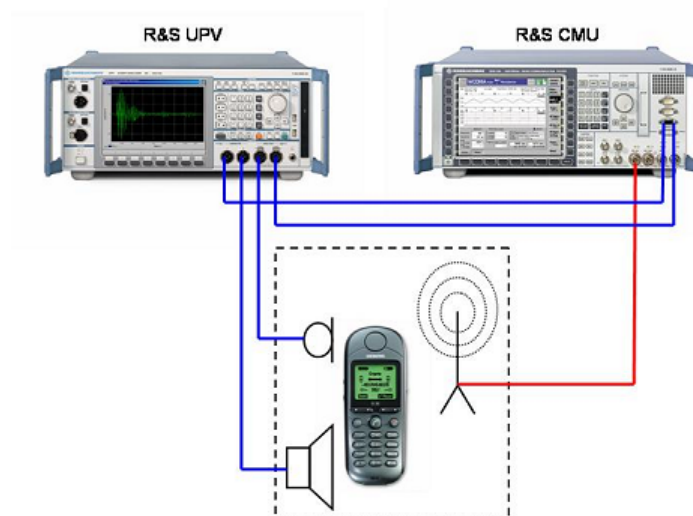
Producers of new transmission methods in mobile radio wish to optimize their algorithms for sound transmission, and network operators need suitable test tools that supplement the already commonly used signal and distortion measurements. In contrast to the currently used PESQ measurement, the focus is now not just on voice/music, but also increasingly more on music signals. This type of measurement is typically performed electrically, directly at the input and output ports of the R&S UPV.



The figure shows how the reference signal is routed from the generator output to the device under test, and the output of the device under test is fed back to the analyzer as the measurement signal. At the same time, the original reference signal is routed internally to the analyzer so it can access both signals for the evaluation.

5.33.2 Acoustic POLQA measurements

Manufacturers of cellular devices increasingly wish to use sound quality as a way to make their products stand out from the competition. In contrast to the currently used PESQ measurement, the focus is now not just on voice/music, but also increasingly more on music signals. Sound quality is essentially influenced by the coding method used in the cellular device. In this case, POLQA measurements are made under realistic conditions by using an acoustic link to the cellular device. The measurement setup consists of a combination of the R&S CMU radio communication tester and the R&S UPV audio analyzer.



The reference signal is sent to the cellular device via an acoustic transducer (artificial mouth). It is coded in the cellular device and then sent to the R&S CMU via a radio link. It is decoded in the CMU and sent to the input of the analyzer as the measurement signal. As with electrical measurement, the original reference signal is also routed internally to the analyzer so that it can access both signals for the evaluation. In the opposite direction, the reference signal is sent to the R&S CMU, where it is coded and transmitted to the cellular device via the radio link. Another acoustic transducer (artificial ear) converts the voice or music signal emerging from the speaker of the cellular device into the measurement signal.

Good acoustic coupling between mobile phone and artificial ear is needed for measurements in receiving direction of the phone. Any background noise should be as low as possible. Thus acoustic measurements should be conducted in a sound isolated chamber.

The advantages of the R&S UPV can be fully exploited with acoustic measurements: Due to the outstanding characteristics of the analog hardware, no POLQA-relevant quality impairments arise in the measured signal even when there are large differences in signal level between the output and input signals. Level differences in the signal path without DUT can be compensated at any time with an additional gain parameter.

5.33.3 POLQA measuring function

The Perceptual Objective Listening Quality (POLQA) measurement process, which was published by the **International Telecommunication Union** in 2010 as **Recommendation ITU-T P.863**, permits the measurement of the listening quality of sound signals which are transmitted with the assistance of highly specialized psychoacoustic coding processes. POLQA is an algorithm which permits these signals to be analyzed by comparing them with the reference signal. The R&S UPV provides this measurement – licensed by **OPTICOM Dipl.-Ing. M. Keyhl GmbH, Erlangen, Germany**. POLQA® is a registered trademark of said company.

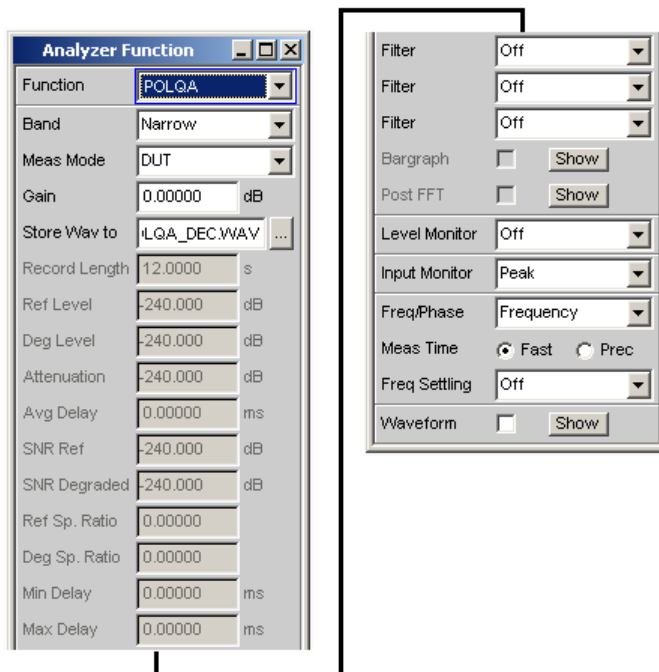
In Recommendation P.863, the ITU defined the criteria by which reference signals for the POLQA measurement must be generated:

- The reference signal must be mono and have a multiple sample rate of 8 kHz.
- There should be at least 0.5 seconds of silence at the beginning and end of the signal. Silence of up to 2 seconds is recommended for devices under test with large delay.
- In realtime mode of the R&S UPV, the length of the test signal is identical to the length of the reference signal. The delay of the device under test must not be longer than the silence at the end of the reference signal, because otherwise the end of the voice or music signal is not measured.
- The ratio between voice/music and silence must be suitable for the particular application. The length of the voice component should be between 1 s and 3 s and the breaks between 1 s and 2 s.

Function

Switching the measurement function to "PEAQ".

Note: For analog measurements in the generator, the "POLQA measurement" requires the setting Bandwidth = Play Auto as Play generator function. The analyzer must be set single-channel with Fix Range. For digital measurements, the sampling rate of generator and analyzer must be set the same as in the played file.

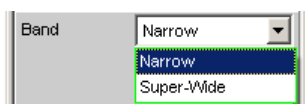


Remote command:

`SENSe[1]:FUNCTION POLQa`

Band

Selection of the bandwidth for the POLQA algorithm. "Narrow" mode is available for narrowband and "Super-wide" mode is available for super-wideband.



In principle, the POLQA measurement can be performed with all sampling rates that are an integer multiple of the ITU specification, since corresponding resampling algorithms are internally implemented. However, the measurement results are only compliant with ITU-T if reference sampling rate as well as analyzer bandwidth belong together.

"Narrow" Measurement based on the ITU-T P.863 NB specification, sampling rate reference: 8 kHz

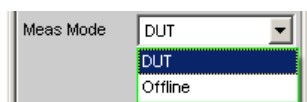
"Super-wide" Measurement based on the ITU-T P.863 SWB specification, sampling rate reference: 48 kHz

Remote command:

`SENSe<n1>:FUNCTION:POLQa:BAND` on page 947

Meas Mode

Selection of the measurement mode for the "POLQA" measurement.



This setting specifies whether a measurement is to be made in real time ("DUT") or whether an offline evaluation of a previously stored WAV file is to be performed ("Offline").

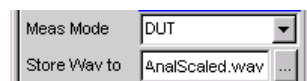
- "DUT" The POLQA measurement is performed in realtime. The reference WAV file will be played back, and the measurement signal will be recorded by the analyzer at the same time. The evaluation is performed immediately after playback of the reference signal is finished.
- "Offline" The POLQA measurement is to be performed for already stored WAV files. After the files containing the reference signal and the measurement signal are specified, the evaluation can be started by pressing the START button.
 The sample rate of the stored WAV files must be an integer multiple of 8 kHz. The length of the recorded signal must be at least the length of the generator reference signal.

Remote command:

[SENSe<n1>:FUNction:MMODE](#) on page 931

Store WAV to

Permits the measured signals to be stored as a WAV file (with Meas Mode = "DUT" only).



The WAV file is always stored with a sampling rate of 48 kHz.

Remote command:

[MMEMory:STORE:PWAVEform](#) on page 944

File Name

Selects the WAV file with the stored measurement data (with Meas Mode = DUT only)



Remote command:

[MMEMory:LOAD:PWAVEform](#) on page 943

Autom. Gain

Activates the automatic level adjustment of the measured signal.



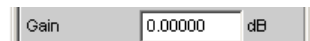
This parameter can be used to switch on an automatic adjustment of the measured audio level to the audio level of the reference signal. Then POLQA carries out the evaluation with ideal modulation of the signals.

Note: For measurements in "Super-wide"band mode and with "Autom. Gain" switched on, the measurements are no longer ITU-compliant, since the dependency of the MOS-LQO value is no longer taken into account by the measured level! Therefore we recommend always measuring in "Super-wide"band mode with "Autom. Gain" **switched off** and in "Narrow"band mode with "Autom. Gain" **switched on**.

Remote command:

[SENSe<n1>:FUNction:POLQa:AUTogain](#) on page 946

Gain



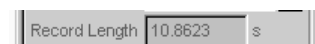
This parameter allows compensating additional gains or attenuations of then transmission path. See the description of the "Attenuation" display value.

Remote command:

[SENSe<n1>:FUNction:POLQa:GAIN](#) on page 947

Record Length

Shows the length of the WAV file selected for the reference signal in the generator function panel.

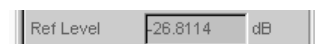


Remote command:

[SENSe<n1>:FUNction:RECORD:LENGTH](#) on page 952

Ref Level

Displays the RMS value of the reference signal after measurement.



If the "RMS" value of the reference signal is shown in dB referenced to the full scale value of the reference signal file.

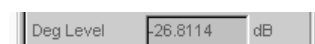
The POLQA algorithm is configured properly if the difference between Ref Level and Deg Level is as small as possible. See also the description of the "Attenuation" display value.

Remote command:

[SENSe<n1>:FUNction:POLQa:REFLevel?](#) on page 948

Deg Level

Displays the RMS value of the measurement signal after measurement.



The "RMS" value of the measurement signal is shown in dB referenced to the full scale value of the measurement signal file for the "POLQA" algorithm.

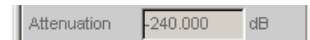
The POLQA algorithm is configured properly if the difference between Ref Level and Deg Level is as small as possible. See also the description of the "Attenuation" display value.

Remote command:

[SENSe<n1>:FUNction:POLQa:DEGLLevel?](#) on page 947

Attenuation

Displays the gain between reference and measurement signal after measurement determined by the POLQA algorithm. Since this value affects the overall result of the measurement, the transmission path to and from the DUT must be adjusted prior to the actual measurement!



Attenuation	-240.000	dB
-------------	----------	----

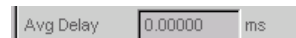
The POLQA algorithm responds strongly - compared to PESQ and significantly more sensitive than PEAQ - to amplitude falsifications between reference and measurement signal. For this reason, it is very important that the transmission path performs neither a gain nor an attenuation of the signal for a measurement at the "golden device". This must be ensured using an adjustment measurement (e.g. without DUT). For the adjustment, the gain parameter in the panel must be changed until this value is as close to 0 dB as possible after a measurement.

Remote command:

[SENSe<n1>:FUNction:POLQa:ATTenuation?](#) on page 946

Avg Delay

Shows the average time offset between the reference signal and the measurement signal (after the measurement).



Avg Delay	0.00000	ms
-----------	---------	----

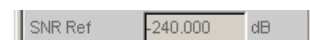
The reference and measurement signals are internally divided into small time frames. The time offset between the two signal paths is measured for each of these frames. The displayed value is the average of all of the measured offset values for the entire signal.

Remote command:

[SENSe<n1>:FUNction:POLQa:AVGDelay?](#) on page 947

SNR Ref

Displays the S/N value in dB across the entire reference signal after the measurement.



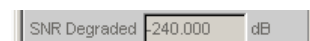
SNR Ref	-240.000	dB
---------	----------	----

Remote command:

[SENSe<n1>:FUNction:POLQa:SNRRef?](#) on page 948

SNR Degraded

Displays the S/N value in dB across the entire measurement signal after the measurement.



SNR Degraded	-240.000	dB
--------------	----------	----

Remote command:

[SENSe<n1>:FUNction:POLQa:SNRDeg?](#) on page 948

Ref Sp. Ratio

Shows the time ratio between voice/music and silence in the reference signal after the measurement.



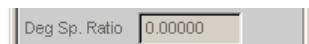
The reference signal is internally divided into small time frames. For each of these frames, the ratio between useful signal (voice/music) and silence (noise) is determined. This value indicates the overall ratio across all frames.

Remote command:

[SENSe<n1>:FUNction:POLQa:REFSpratio?](#) on page 948

Deg Sp. Ratio

Shows the time ratio between voice/music and silence in the measurement signal after the measurement.



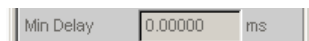
The measurement signal is internally divided into small time frames. For each of these frames, the ratio between useful signal (voice/music) and silence (noise) is determined. This value indicates the overall ratio across all frames.

Remote command:

[SENSe<n1>:FUNction:POLQa:DEGSpratio?](#) on page 947

Min Delay

Displays the minimum time offset between the reference and the measurement signals after measurement.



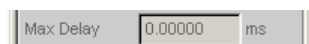
The reference and measurement signals are internally divided into small time frames. The time offset between the two signal paths is measured for each of these frames. The displayed value is the smallest determined value for the entire signal.

Remote command:

[SENSe<n1>:FUNction:POLQa:MINDelay?](#) on page 948

Max Delay

Displays the maximum time offset between the reference and the measurement signals after measurement.



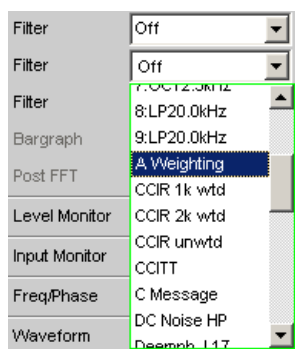
The reference and measurement signals are internally divided into small time frames. The time offset between the two signal paths is measured for each of these frames. The displayed value is the largest determined value for the entire signal.

Remote command:

[SENSe<n1>:FUNction:POLQa:MAXDelay?](#) on page 947

Filter

Activating a digital filter in the test channel. Up to three user-defined or weighting filters can be looped into the test channel:



The user-definable filters are configured as filters 01 to 09 in the filter panel (see [chapter 5.44, "User-Definable Filters"](#), on page 628) and can then be used (repeatedly if necessary) in the analyzer.

For more information on the available weighting filters, see [chapter 5.45, "Weighting Filters"](#), on page 637.

Note: In the POLQA algorithm, all required filters are already implemented. If additional filters are activated, the displayed result does no longer correspond to the ITU-T P.863 standard!

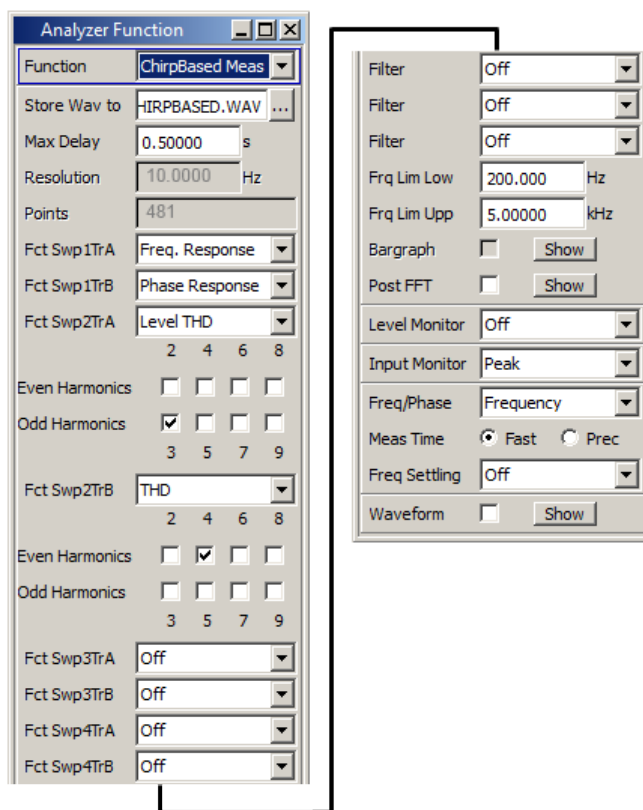
Remote command:

`SENSe<n1>:FILTer<n2>` on page 958

For a description of the filters and their setting parameters, see [chapter 5.43.4, "Filter Table"](#), on page 628.

5.34 Chirp-Based Measurement

Evaluation of the impulse response of a DUT for the stimulus signal generated by the "Chirp" generator function.



When the DUT is excited by a logarithmic sine-wave sweep as a stimulus signal by means of the "Chirp" generator function, the chirp-based measurement can be used to determine the frequency responses of the fundamental and all harmonics simultaneously. This results in a considerable time saving compared to the customary sweep methods that perform a separate measurement together with evaluation of the harmonics for each frequency sample. It is not possible to specify the precise time saving because the chirp parameters have to be adjusted as precisely as possible to the frequency range and the settling characteristics of the DUT in order to achieve the shortest possible measurement times.

Owing to its short measurement time, "chirp-based" measurement is of particular interest for production applications. With the evaluation algorithms, attention was paid to minimizing the measurement time while at the same time increasing the accuracy of the results.

5.34.1 Settings

Chirp-based measurement settings in the Analyzer Function control panel.

Store Wav to

Allows the measured signal to be stored as a WAV file.

Remote command:

[MMEMory:STORe:PWAVeform](#) on page 944

Max Delay

Maximum expected settling time of the DUT. The measurement time is extended by this time.

Remote command:

[SENSe<n1>:VOLTage:APERture](#) on page 931

Resolution

Frequency resolution = (Sampling rate / 2) / FFT size of the FFT used internally for the chirp-based measurement.

The "Sweep Time" set in the "Chirp" generator function determines the "Resolution".

Remote command:

[SENSe<1>CHIRpbased:RESolution?](#) on page 950

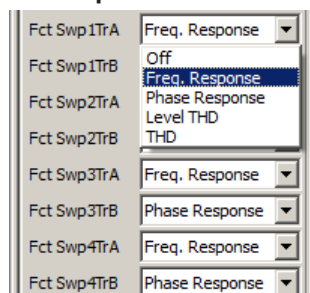
Points

Number of points in the chirp result.

The "Sweep Time" set in the "Chirp" generator function determines the number of points. The trace data (suffix 2 to 9) described under [chapter 5.34.2, "Data Buffers"](#), on page 574 is available with this number of points.

Remote command:

[SENSe<1>CHIRpbased:POINTs?](#) on page 950

Fct SwpXTrY

Evaluation of the impulse response with respect to the desired measurement result.

The title of the 8 combo boxes indicates in which of the sweep graphic subsystems and with which trace the measurement result is shown. Swp1 to 4 designates sweep subsystem Sweep Graph 1 to 4, and TrA and TrB designate trace A (green) and B (yellow) used in this sweep subsystem to represent the desired measurement result.

Example: If "Phase Response" is selected in the combo box with the title "Fct Swp3TrB", the phase response is represented by trace B (yellow curve) in the Sweep Graph3 window. The graphic is configured accordingly in the DispConfig panel "Sweep Graph3 Config".

All level values are calculated as RMS values.

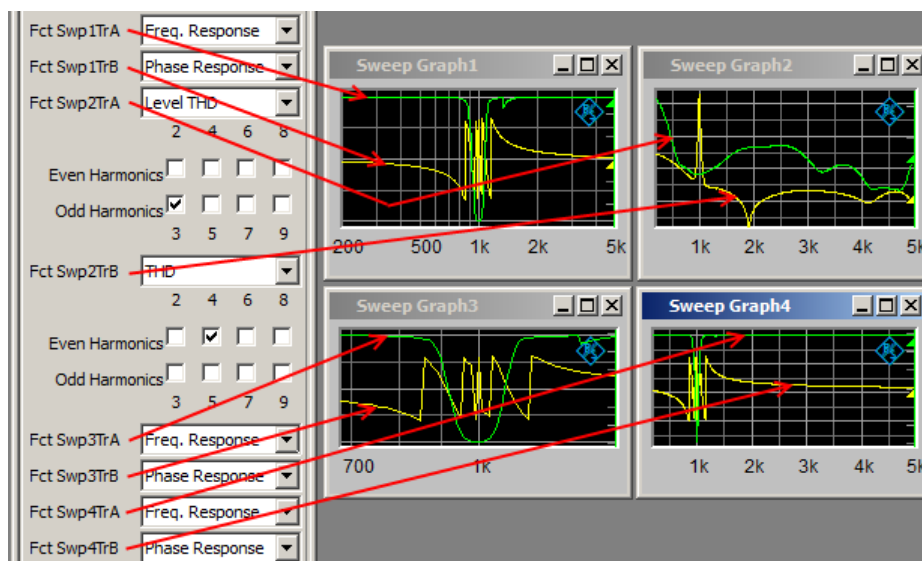


Fig. 5-30: Assignment of chirp-based measurement results to sweep windows

- "Off" No evaluation
- "Freq. Response" Level over frequency (frequency response)
- "Phase Response" Phase over frequency (phase response)
- "Level THD" RMS value of the selected harmonic distortion products (distortion value) over frequency
 THD = Total Harmonic Distortion. Distortion is measured as an RMS value using the harmonics to be set in the panel shown below. For details on the calculation, see [chapter 5.27.2, "THD"](#), on page 499. The RMS value is displayed in voltage units (analog measurement mode: V, dBu, dBV, etc.; digital measurement mode: FS, dBFS, etc.).
- "THD" Total harmonic distortion over frequency
 The total harmonic distortion measurement shows the relationship between the RMS value of the harmonics set in the panel below and the total RMS value, and gives the result in the units % or dB. For details on the calculation, see [chapter 5.27.2, "THD"](#), on page 499.

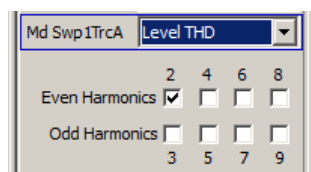
Remote command:

[SENSe<1>CHIRpbased:MMODE:SWEep<n>:A](#) on page 949

[SENSe<1>CHIRpbased:MMODE:SWEep<n>:B](#) on page 949

Even Harmonics, Odd Harmonics

Selection of the desired harmonics. This panel only appears if the chirp-based measurement function "Level THD" or "THD" is selected.



The RMS value of the selected harmonics is measured. The chirp-based measurement function "Level THD" or "THD" above it determines whether the RMS value is displayed directly or in relation to the total RMS value. For details on the calculation, see [chapter 5.27.2, "THD"](#), on page 499.

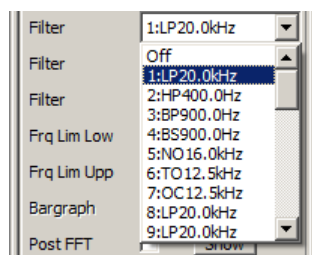
Remote command:

`SENSe<n>CHIRPbased:DISTortion<di>:SWEep<n>:A` on page 949

`SENSe<n>CHIRPbased:DISTortion<di>:SWEep<n>:B` on page 949

Filter

Three digital filters (user-definable filters or weighting filters) in the measurement path.



The user-definable filters are configured as filter 01 to 09 in the filter panel (see [chapter 5.44, "User-Definable Filters"](#), on page 628) and can then be used (repeatedly if necessary) in the analyzer.

For more information on the available weighting filters, see [chapter 5.45, "Weighting Filters"](#), on page 637.

Note: Regardless of the digital filters selected here, a further input filter ("prefilter") can be looped into the measurement path. Moreover, the analog bandwidth can be restricted with the aid of the "Bandwidth" parameter field, which corresponds to an additional lowpass filter.

Remote command:

`SENSe<n1>:FILTer<n2>` on page 958

For a description of the filters and their setting parameters, see [chapter 5.43.4, "Filter Table"](#), on page 628.

Frq Lim Low / Frq Lim Upp

The frequency range set in the Chirp generator function can be limited for the evaluation.

If the selected "Frq Lim Low" value is higher than the Start Freq value, the time from the "Start Freq" value of the generator up to the point where the "Frq Lim Low" value is reached is not displayed in the sweep graphic. In this way it is possible to, for example, hide the settling characteristics of a DUT in the sweep graphic.

If the "Frq Lim Low" and "Frq Lim Upp" values are outside the "Start Freq" and "Stop Freq" values of the generator (the generator values have been entered incorrectly or changed), the graphical representation of the sweep trace is adapted automatically to the generator values. However, the "Frq Lim Low" and "Frq Lim Upp" values are not necessarily adapted to the "Start Freq" and "Stop Freq" values of the generator.

Remote command:

`SENSe<n1>:FREQuency:LIMit:LOWer` on page 938
`SENSe<n1>:FREQuency:LIMit:UPPer` on page 938

5.34.2 Data Buffers

On completion of the measurement, the traces of the selected chirp-based measurement functions are shown in the sweep graphics. At the same time, this data is available in the internal data buffers in the same display units that were selected in the corresponding sweep subsystem. The raw data for Freq. Response, Phase Response and the harmonics are additionally available in the basic units V, FS or degrees.

The data of the chirp-based measurement is stored in max. 89 data buffers and can be read out using the SCPI command `SYSTem:MEMory:DATA<n3>` on page 1016, whereby the suffix <i> represents the values 1 to 89.

A maximum of 1024 data buffers can be addressed. Data buffers 90 to 1024 are not used by the chirp-based measurement and are freely available. All 1024 data buffers are freely available outside the chirp-based measurement.

The content of the internal data buffers is split into **trace data** and **raw data**. The trace data is available in exactly the same number as the sweep reference points in the sweep graphics and is calculated from the raw data. The number of values in a raw data set is always considerably higher than in a trace data set. The values of both data sets are always in the basic units. However, the trace data sets can also be read out in the unit which was selected in the graphical display. The values on the x-axis are addressed with the suffix 1, the values on the y-axis (trace data) with the suffix 2 to 9 and the raw data with 10 to 89. The "Example for reading in raw data" given below shows how the suffix is calculated for a certain data set.

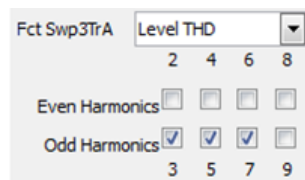


The raw data of the harmonics is always available up to the highest selected harmonic, even if the checkmark for the harmonic is not set. The data buffers of the harmonics that are larger than the highest selected harmonic are empty.

Example: If d7 is selected as the only harmonic, the raw data of d2, d3, d4, d5 and d6 will still be available. The data buffers for d8 and d9 are empty and, when queried, return the NaN value "3.40282E+38".

Example for reading in trace data:

The trace data is addressed with the suffix 1 to 9. On Trace A (green) in Sweep Graph 3, "Level THD" is represented by the harmonics 3, 5 and 7.



The buffer that contains the trace data for "Level THD" is addressed with the suffix 6, as shown in the table below. The values are available in the basic unit V or FS.

Example for reading in raw data based on example above:

The raw data is addressed with the suffix 10 to 89. In this example, it is assumed that measurement was performed on the channel Ch2.

The suffix for the raw data of the harmonics is calculated from the channel number and the number of the harmonics.

Raw data for Freq. Response: $\langle i \rangle = (\text{Channel number } 1 \text{ to } 8) * 10$

Raw data for Phase Response : $\langle i \rangle = (\text{Channel number } 1 \text{ to } 8) * 10 + 1$

Raw data for harmonics: $\langle i \rangle = (\text{Channel number } 1 \text{ to } 8) * 10 + (\text{No. of harm. } 2 \text{ to } 9)$

The suffixes of harmonics 3, 5 and 7 that were measured on channel 2 are therefore required: According to the formula "Raw data of harmonics", this results in the suffixes 23, 25 and 27. If the raw data of the harmonics not selected (i.e. 2, 4 and 6) is also to be read in, this results in the suffixes 22, 24 and 26. Raw data for the harmonics 8 and 9 is not available. The query with the suffixes 28 and 29 would each return the NaN value "3.40282E+38" as the query response.

Table 5-8: Meaning of suffixes

Suffix No.	Content of data buffer	Description
1	Frequency values	Raw data: X values, given in the basic unit Hz, to which all levels or degree values of the raw data from suffix 10 and higher refer. The SCPI command "TRACe:SWEep<i>:LOAD:AX?" is used to read out the trace data in the selected unit. "TRACe:SWEep<i>:LOAD:COUNT:AX?" is used to determine the number of available values. Correspondence to the SCPI commands is shown again in SYSTem:MEMory:DATA<n3> on page 1016.
2	Fct Swp1 TrA	Trace data in the basic unit of the 8 sweep graphics. For the measurement function "Freq. Response", the data set contains level values in V or FS; for "Phase Response", the data set contains values in degrees; for "Level THD", the data set contains level values in V or FS; for "THD", the data set contains values in %. The SCPI command "TRACe:SWEep<i>:LOAD:AY BY?" is used to read out the trace data in the selected unit. "TRACe:SWEep<i>:LOAD:COUNT:AY BY?" is used to determine the number of available values. Correspondence to the SCPI commands is shown again in SYSTem:MEMory:DATA<n3> on page 1016.
3	Fct Swp1 TrB	
4	Fct Swp2 TrA	
5	Fct Swp2 TrB	
6	Fct Swp3 TrA	
7	Fct Swp3 TrB	
8	Fct Swp4 TrA	
9	Fct Swp4 TrB	
10	Ch1 freq. response	
11	Ch1 phase response	Raw data of the "Phase Response" function measured on channel 1. Degree values over frequency in the basic unit degrees.
12	CH1 frequency response of harm. d2	Raw data of the harmonics, measured on channel 1. Level values (RMS) over frequency. The values are always available in the basic unit V or FS. The data buffers of the unused harm. remain empty and, when queried, return the NaN value "3.40282E+38".
13	CH1 d3	
14	CH1 d4	
15	CH1 d5	
16	CH1 d6	
17	CH1 d7	

Suffix No.	Content of data buffer	Description	
18	CH1 d8		
19	CH1 d9		
20	Ch2 freq. response	Raw data of the "Freq. Response", "Phase Response" and the harmonics, measured on channel 2.	
21	Ch2 phase response		
22	CH2 frequency response of harm. d2		
23	CH2 d3		
24	CH2 d4		
25	CH2 d5		
26	CH2 d6		
27	CH2 d7		
28	CH2 d8		
29	CH2 d9		
30 to 39	Raw data for Ch3		Raw data for Ch3 to Ch8, as described for Ch1.
40 to 49	Raw data for Ch4		
50 to 59	Raw data for Ch5		
60 to 69	Raw data for Ch6		
70 to 79	Raw data for Ch7		
80 to 89	Raw data for Ch8		

The data can be read out from the user-definable data buffers in the basic unit. If the data is to be read out in the unit that is set in the sweep graphic, the [TRACe:SWEEp<i>:LOAD](#) commands can be used. For a comparison of these commands, see [SYSTem:MEMory:DATA<n3>](#) on page 1016.

5.35 Analysis in the Time Domain

Besides analysis in the frequency domain, the R&S UPV can also be used to analyze input signals in the time domain. Time and frequency-domain analyses can be performed simultaneously and irrespective of the selected measurement function.

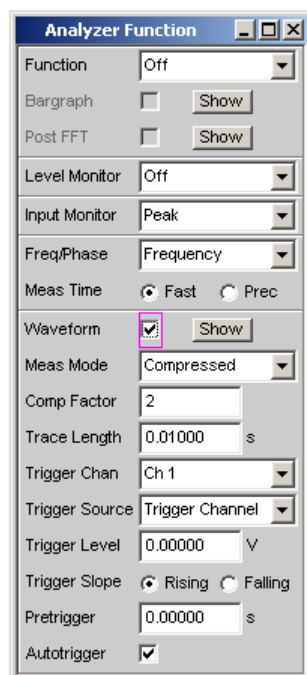
5.35.1 Waveform Monitor

The waveform monitor is used for signal analysis in the time domain. Both channels of the active analyzer can be measured and displayed simultaneously and synchronously.

- The "Analyzer Function" panel is used to activate the waveform monitor and to configure its trigger condition and memory depth. The Waveform graphical window can also be opened from here.
- The scaling (including limit checking and the reference source) are selected in the Waveform Config panel.
- The graphical display is shown in the Waveform graphical window.



Continuous waveform measurement can be performed with sampling rates below 100 kHz or an analog bandwidth up to 40 kHz. For this it must be ensured that neither the selected measurement function nor any other measurement performed at the same time (e.g. a level monitor or a frequency measurement) requires more time than the waveform measurement. To ensure this, it is advisable to switch off all other measurements and to use manual triggering.



Waveform

Used to activate the waveform monitor; the **graphic** is configured and displayed in the Waveform ("Config") configuration and graphical window.

Click the "Show" button to open the Waveform graphic. The graphic – like any other window – can be closed by pressing the CLOSE key or by clicking the title bar button , provided that the graphic is the active window.

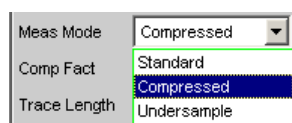
- "deactivated" Waveform monitor deactivated
Recommended for increasing the measurement speed (e.g. for sweeps or remote control).
- "activated" Waveform monitor activated; the parameter fields shown above appear.

Remote command:

SENSe7:FUNCtion ON | OFF

Meas Mode

Used to select the operating mode.



Note: If "Undersample FFT" is enabled, the waveform mode cannot be selected. Instead, it is automatically set to "Undersample".

In certain measurement functions (e.g. "Record") "Meas Mode" cannot be selected, but instead stays at "Standard".

- "Standard" Uncompressed recording of all samples. A maximum of 480000 samples can be stored. The possible recording length depends only on the bandwidth (analog) or sampling rate (digital); at a sampling rate of 48 kHz or an analog bandwidth of 22 kHz, the recording length is, for example, 10 s.
Recommended for short recordings (maximum of a few seconds) and for periodic signals.
- "Compressed" Compressed recording of the samples produced by peak value rectification. Specifying a value (n) for the "Comp Fact" (compression factor) in the next operator field means that the highest value out of every n consecutive samples is determined and this peak value is used as the input signal for the waveform function. The maximum recording time increases in proportion to the factor n.
Since this waveform contains only positive data, a logarithmic display is possible.
Recommended for recording low-frequency signals if the standard recording time is too short or the only aspect of interest is the peak value trace (envelope).
- Note:** "Delay Ch1" or "Delay Ref Chan" (only for the "FFT" measurement function) cannot be used in this mode and is thus set to 0 s.
- Note:** Continuous processing of the measurement data over a relatively long time is only guaranteed for sampling rates up to 96 kHz or analog bandwidths up to 40 kHz. If the sampling rate is too high or the bandwidth is too large, the measurement will be terminated with a suitable error message. If this happens, it may be necessary to reduce the number of analyzer filters that are being used.

"Undersample" Compressed recording of the samples produced by undersampling. Specifying a value (n) for the "Comp Fact" (compression factor) in the next operator field means that only every nth sample is recorded. The maximum recording time increases in proportion to the factor n. Recommended for recording low-frequency signals if the standard recording time is too short and the **signal trace** over time is of interest.

Note: "Delay Ch1" or "Delay Ref Chan" (only for the "FFT" measurement function) cannot be used in this mode and is thus set to 0 s.

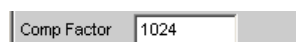
Note: Continuous processing of the measurement data over a relatively long time is only guaranteed for sampling rates up to 96 kHz or analog bandwidths up to 40 kHz. If the sampling rate is too high or the bandwidth is too large, the measurement will be terminated with a suitable error message. If this happens, it may be necessary to reduce the number of analyzer filters that are being used.

Remote command:

[SENSe7:MMODE](#) on page 951

Comp Factor

Used for entering the compression factor in compressed recording.



Comp Factor 1024

The factor entered here is the factor by which

- the maximum recording time and pretrigger time increases compared to standard recording
- the time resolution deteriorates compared to standard recording

The size of the trace memory (480000 samples) and pretrigger memory (19200 samples) remains unaffected.

A reduction in the compression factor reduces the maximum possible recording time and therefore where appropriate also the set recording and pretrigger times.

An increase in the compression factor does not alter the set recording time, but only the maximum possible recording and pretrigger times. You can then set a longer recording time ("Trace Length") and a longer pretrigger time.

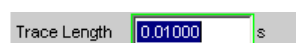
Note: If Undersample FFT is enabled, the waveform compression factor cannot be selected. Instead, it is automatically set to match the FFT compression factor.

Remote command:

[SENSe7:CMPFactor](#) on page 951

Trace Length

Used to enter the recording length (memory depth), including an optional pretrigger, in seconds.



Trace Length 0.01000 s

A maximum of 48000 samples can be stored. Apart from the bandwidth (analog) and sampling rate (digital), the possible recording length also depends on the selected operating mode (the compression factor):

- The higher the bandwidth or sampling rate is, the shorter the maximum possible recording length will be.
- The recording length can be multiplied by using one of the compression modes.

Note: If a multichannel analyzer is used, max. 1.44 million samples can be monitored. This corresponds to, for example, 15 s at an analog bandwidth of 40 kHz. Therefore, if one of the compression modes is used, the recording length is automatically limited to this time.

The recording length does not depend on the length of the time axis (selected in the "Waveform Config" panel).

The lower the selected recording length is, the higher the update rate for the graphic will be.

If a long recording time is set, any section of the recorded samples can be analyzed by reducing the graphical time axis (also possible at a later stage).

Note: The selected "Trace Length" (not the length of the displayed trace section) determines the recording time for each measurement and thus also the total measurement time. If a high measurement speed is required (e.g. for sweeps or remote-control mode), the memory depth should not be longer than the measurement time of the measurement function.

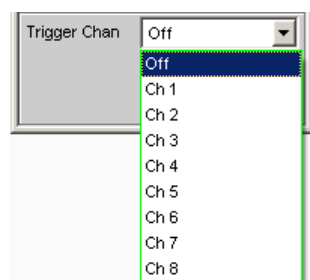
Note: If "Undersample FFT" is enabled, the lower limit of the waveform recording length is set to the FFT measurement time.

Remote command:

[SENSe7:TRIGger:TRCLength](#) on page 952

Trigger Chan

Used to select the channel whose event triggers a measurement.



If a measurement channel which was inactive is selected as a trigger channel, it is automatically switched on. A warning appears if the channel selected as a trigger channel is switched off.

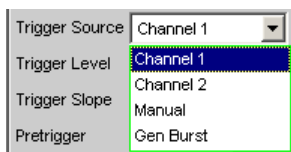
Switching off the measuring channel, which was selected as the trigger channel, therefore changes the trigger channel after this warning has been acknowledged.

Remote command:

[TRIGger:CHANnel](#) on page 909

Trigger Source

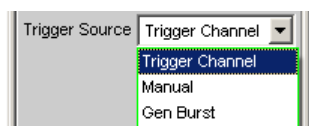
Used to activate the trigger and to select the trigger source.



Note: If Undersample FFT is enabled, the waveform trigger source cannot be selected. Instead, it is automatically set to Manual.

Selects the source (usually one of the measurement channels) which is to trigger measurement recording if the trigger threshold is overranged or underranged.

Note: In the case of multichannel analyzers, the trigger channel must be defined before it can be used as trigger source for the waveform. If no trigger channel is activated, the trigger source is automatically set to "Manual".



- "Channel 1" Measurement channel 1 triggers recording. Only available in the two-channel analyzers if measurement channel 1 (or both channels) is activated.
- "Channel 2" Measurement channel 2 triggers recording. Only available in the two-channel analyzers if measurement channel 2 (or both channels) is activated.
- "Trigger Chan" The measurement channel selected as "Trigger Chan" triggers the recording. Only available in the multichannel analyzers if the trigger channel is not deactivated.

Note: If the trigger channel is deactivated, the "Trigger Source" is not operable.



- "Manual" Recording is triggered as soon as the measurement starts.

"Gen Burst" Recording is synchronized to the start of the generator signal (preferably Sine Burst).
 Not available in multichannel analyzers.
 The generator signal is first muted briefly (approx. 3 ms) and then restarted with zero-degree phase ("Burst On" phase). Measurement data recording is started at the same time, taking internal signal delays into account.
 It is thus possible to graphically determine the signal delay of the DUT from the waveform display by selecting "Gen Burst" and using a suitable signal from the internal generator (see [chapter 5.35.2, "Delay Measurement"](#), on page 584).

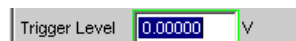
Note: In this mode, the settling time of any filter that may be enabled is not taken into account for starting the measurement. In other words, the measurement starts without any delay and thus includes the settling phase of the filters.

Remote command:

[SENSe7:TRIGger:SOURce](#) on page 951

Trigger Level

Entering the trigger level



Recording is triggered according to the "Trigger Slope" when this level is overranged or underranged.

When measurement has been started or recording has been triggered (in the case of continuous measurement), a new recording cycle is not armed again until the trigger threshold is violated in the opposite direction.

Remote command:

[SENSe7:TRIGger:LEVel](#) on page 951

Trigger Slope

Used to select the signal edge on which measurement is to be triggered (trigger slope).



"Rising" "Triggering" takes place when the level on the measurement channel selected as trigger source exceeds the trigger threshold for the first time.
 (Re-)arming takes place as soon as a level below the trigger threshold occurs.

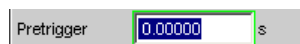
"Falling" "Triggering" takes place when the level on the measurement channel selected as "Trigger Source" drops below the trigger threshold for the first time.
 (Re-)arming takes place as soon as a level above the trigger threshold occurs.

Remote command:

[SENSe7:TRIGger:SLOPe](#) on page 951

Pretrigger

Used to activate the pretrigger and to enter the pretrigger interval in seconds:



The pretrigger is deactivated by entering a pretrigger time of 0.0 s.

Entering a pretrigger time shifts the trigger point within the recording time selected as "Trace Length".

The pretrigger memory is 19200 samples in size, i.e. 4 % of the maximum possible trace length. With a compressed waveform display ("Compressed" or "Undersample"), the maximum possible pretrigger time (and the trace length) is increased by the compression factor.

The pretrigger memory is filled from the start of the measurement and always contains the latest samples of the time frame selected as the pretrigger, before triggering occurs. For so long as the pretrigger is not completely full, triggering remains locked. It is only armed when the pretrigger memory is full and is at least one sample below the trigger threshold.

The pretrigger memory is filled from the front in the manner of a shift register, so that the older samples move back one position as each new sample is added:

- If the pretrigger time is longer than the total trace length, triggering takes place when the trace length is reached. The pretrigger memory (which is only partially full) is then displayed.
- If the desired pretrigger interval has expired, the older samples in the back part are replaced by newer samples.

The **trigger point** is always $t = 0.0$ s; the pretrigger time is given as a negative time.

Note: The total length of the waveform trace is 480000 samples and is entered under Trace Length. If the pretrigger is used, the recording duration for the triggered section of the signal is reduced.

Remote command:

[SENSe7:TRIGger:PRE](#) on page 951

Autotrigger

For activating the autotrigger, that is, forced triggering, when the trigger condition is not fulfilled ("true") within the time selected as "Trace Length".



"deactivated"

Autotrigger off

The triggering of waveform recording – and thus the termination of a single measurement that has been started – occurs only when the trigger event has occurred (i.e. has changed to "true").

If an unfavorable trigger condition is chosen (e.g. the trigger level is too high) the measurement continues indefinitely and must be interrupted manually (STOP key).

This setting is recommended if the waveform is to be displayed only if the trigger condition is fulfilled.

"activated" Autotrigger on
 When the trace length has expired, forced triggering occurs, that is, the waveform is then displayed untriggered, as in the case of manual triggering.
 This setting is recommended if you wish to ensure that the measurement terminates, or in the case of an unknown signal trace.

Remote command:

`SENSe7:TRIGger:AUTO` on page 951

5.35.2 Delay Measurement

The delay measurement function is used to measure signal delays in a DUT (e.g. between the input and the output). For this purpose, a known signal is applied to the input of the DUT and the time required for the signal to appear at the output of the DUT is measured.

With this type of measurement, it is essential for the time measurement to be started exactly when the signal appears at the input of the DUT, i.e. at the output of the generator. The internal delays of the generator and the analyzer must be taken into account automatically. To allow measurements to be made at the D/A and A/D converters, this synchronization must effectively extend over both domains – from analog to digital and from digital to analog.

Just like the previous UPD and R&S UPL instruments, the R&S UPV provides a specific waveform measurement mode for this measurement task: "Gen Burst" mode. In this operating mode, the start of the measurement (and thus the start of waveform recording) is synchronized to the start of the generator signal (preferably Sine Burst):

- The generator signal is muted briefly (approx. 3 ms) and then restarted with zero-degree phase (in the case of a burst signal with "Burst On")
- The analyzer does not start recording until it receives an internal trigger signal from the generator and the internal signal delays of the generator and analyzer being used have expired.



As the generator signal contains an (intentional) signal dropout and reset at the start of each measurement cycle in this operating mode, it should only be used for measuring delays and not for measuring signal quality.

The delay of the DUT can be read directly from the waveform display by comparison with the start of the generator signal. A sine burst signal is particularly suitable for this type of measurement, since it has a zero level before and after the burst if the "Low Level" value, burst duration and burst interval parameters are suitably configured.



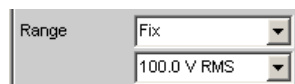
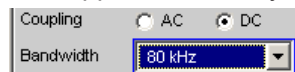
Internal triggering to the generator signal cannot be applied if a multichannel analyzer is used. Instead, however, one of the measurement channels – as reference and trigger channel – can record the generator signal and trigger the waveform measurement while two other channels are displayed as waveform.

Sine Burst is equally suitable for single and continuous measurements, since the trigger for the next measurement is automatically re-armed by the burst pause. However, any other type of generator signal can also be used for single measurements, since the start of the signal can be recognized from the brief signal blanking interval. The settings for operation with a sine burst signal are described below:



To run the delay measurement as a continuous measurement or sweep, Burst must be selected as the generator function with Low Level = 0 (no offset) so that arming can be performed by the burst pause.

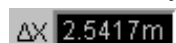
- The measurement can be made using "one or two channels". If only one signal is to be observed, the unused channel should be disabled in the Analyzer Config panel, and Trace B should be disabled in the Waveform Config panel.
- The "Filter" and "Equalizer" should not be used unless absolutely necessary. If a filter or filters are used, it must be borne in mind that the settling of the filter will be visible in the waveform trace, since in this case the start of the measurement cannot be delayed by the filter settling time as is otherwise usual.
- In the case of "analog measurement", the two-channel analog analyzer must be used, autoranging must be disabled ("Range Fix" for the measurement channels used) and the input coupling must be set to "DC". A range that is large enough to acquire the expected signal level without overranging must be selected. 80 kHz should be selected as the bandwidth in order to obtain the highest possible time resolution. For very long delays (> 2 s), the bandwidth must be reduced. 250 kHz is not supported for delay measurement.



- With "pure analog measurements" (analog generator and analog analyzer), the generator and analyzer should be configured with the same bandwidth. With "D/A measurements", it is recommended that you adapt the generator bandwidth to the analyzer sampling rate (i.e. 22 kHz bandwidth for 48 kHz sampling rate, 40 kHz bandwidth for 96 kHz sampling rate, 80 kHz bandwidth for 192 kHz sampling rate).

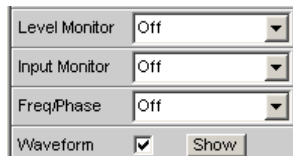


- For evaluation of the measurement, the "waveform window" must be visible and a vertical graphic cursor (or two cursors for two-channel measurements) must be enabled ("Movement Next Sample"). With a two-channel measurement, this allows the relative delay of the two measurement signals to be read in addition to the absolute delay of each signal.



The x-axis should initially be scaled automatically so that the entire waveform trace can be seen. The graphic zoom function can then be used for more precise examination of the signal start.

- A "measurement function" with a short measurement time (e.g. FFT with an FFT size of 1 k) should be selected in the "Analyzer Function panel", and all unnecessary supplementary measurement functions (especially frequency and level monitoring) should be disabled. The Waveform Monitor must be enabled.



- "Meas Mode Standard" should be selected in the "Waveform menu" (Analyzer Function panel); it is not necessary to select "Undersample" except for very long delays (> 9 s). "Trigger Source" must be set to "Gen Burst".



- Generally, the "generator function" should be set to "Sine Burst"; it is, however, also possible to use other signals from the internal generator to perform single measurements.
- The "Low Level" of the burst signal must be set to 0.0 (V or FS), especially for continuous measurements, so that the burst pause can arm the trigger for the next measurement. The voltage must be greater than 0.0, otherwise the message "No Generator Signal" will be displayed and it will not be possible to trigger the measurement.
- "Burst on Delay" is normally not necessary. It can be used to lengthen the standard generator mute time (3 ms) at the start of the measurement.

The following settings depend on the length of the expected delay and apply to the generator function "Sine Burst".

- The "recording length" (Trace Length) should be around 110% of the maximum expected delay, but at least 10 ms. Reducing the recording time increases the update rate with continuous measurements and the time resolution of the graphical display.
- The "Burst Interval" should be 110% to 200% of the recording time, but at least 100 ms longer than the recording time. The interval can be set to any desired value for single measurements. The maximum permissible interval for continuous measurements is 2 s; if the selected value is too large, a timeout will occur during continuous measurement and the message "No Generator Signal" will be displayed. The shorter the interval, the higher the update rate with continuous measurement.
- The "frequency" of the burst signal should be selected such that the period of the signal is approximately 2% to 10% of the recording time. If possible, it should be a subharmonic of the generator sampling frequency.
- The "burst duration" should not exceed 10% of the recording time, and it should be set to an integer multiple of the period (1 to 5 cycles) so that the test signal will not have a DC component.

The following two examples show configurations for very short (1 ms) and very long (1 s) delays:

Delay DUT 1 ms

Trace Length ms

Generator Function	
Function	Sine Burst
Sweep Ctrl	Off
Frequency	1000.00 Hz
Voltage	1.00000 FS
Low Level	0.00000 FS
On Time	1.00000 cyc
Interval	110.000 ms
Burst on Delay	0.00000 s
Filter	Off
Equalizer	<input type="checkbox"/>
DC Offset	<input type="checkbox"/>
	0.00000 FS

Delay DUT 1 s

Trace Length s

Generator Function	
Function	Sine Burst
Sweep Ctrl	Off
Frequency	25.0000 Hz
Voltage	1.00000 FS
Low Level	0.00000 FS
On Time	2.00000 cyc
Interval	2.00000 s
Burst on Delay	0.00000 s
Filter	Off
Equalizer	<input type="checkbox"/>
DC Offset	<input type="checkbox"/>
	0.00000 FS

5.36 Offline Analysis Record

Analyzer Function	
Function	Record
Record File	user\Myfile.wav ...
BitsPerSample	Auto
Record Length	10.0000 s
File Length	30720044
Trigger Source	Manual
Filter	Off
Filter	Off
Bargraph	<input type="checkbox"/> Show
Post FFT	<input type="checkbox"/> Show

All R&S UPV measurement functions can of course be executed online (in realtime), which produces results quickly and is indispensable particularly for use in production and in adjustment procedures. They can all, however, be used offline as well.

This is done by first recording the signal that needs to be measured and then playing it back and analyzing it at a later time.

The R&S UPV provides the "Record" function for the purpose of recording the signal. Since the standard WAV format is used for playback, in principle any recording instrument that creates WAV files can be used. When recording analog signals, the R&S UPV analyzer or a similar high-quality 24 bit A/D converter should preferably be used in order to take full advantage of the extensive dynamic range of the R&S UPV during offline measurements.



This measurement requires uninterrupted monitoring of the sample signal over an extended period of time. When using a multichannel analyzer, which only performs single measurements that are limited by time, it does not yield meaningful results. "RECORD" is therefore only available with two-channel analyzers.

These files are played back for analysis with the aid of the "PLAY" generator function (see [chapter 5.6.11, "Play"](#), on page 317), while the R&S UPV analyzer – connected internally to the generator – executes all the required measurements one after the other. All available interfaces can be used for this; an analog sample signal can thus be examined losslessly, for example during offline analysis, via one of the optional R&S UPV digital interfaces.

The maximum recording time depends on the required format (mono/stereo, 8/16/32 bit), the sampling rate and the available memory, and can last up to one day (8 bit mono recording at 48 kHz). In the case of a two-channel analog recording with a 22 kHz bandwidth, the maximum is three hours.



Due to considerations of memory space and performance, the smallest possible bandwidth or sampling rate should be used.

Data partition of the hard disk (D:) or a network drive can be used as the storage location for the WAV file, and a USB stick can also be used for short files.

In order to synchronize the start of the recording on a certain level (e.g. interference peak), a trigger system can be activated. A pretrigger optionally also records the events leading up to the trigger event.

The signal is stored unchanged or filtered according to choice. As with all level measurements, a maximum of three further filter banks with user-definable filters is available in addition to the prefilter, and can be used to weight and band-limit the signal.

5.36.1 Applications

The following situations or applications call for offline measurement and the use of the Record function:

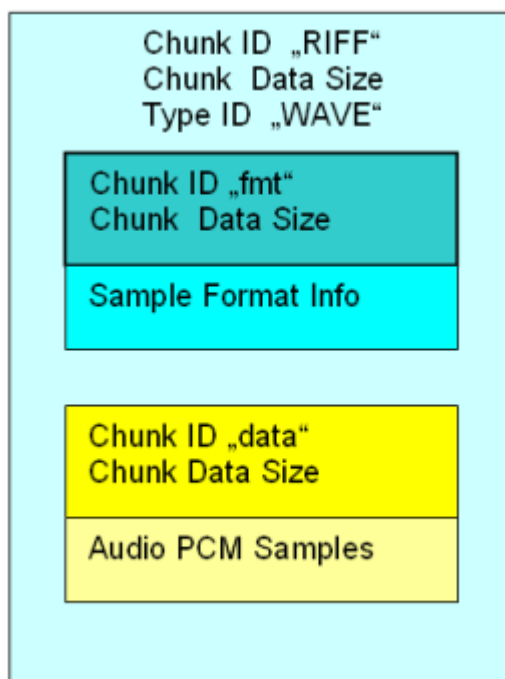
- The signal to be measured does not occur cyclically or occurs only sporadically.
- The DUT is available for only a short time.
- The intention is to use a single signal to carry out more different measurements than the Audio Analyzer can carry out simultaneously.

- The signal to be measured needs to be analyzed with the aid of an external diagnostics program.
- The place or time of the measured value acquisition are not favorable to technical assessment.

5.36.2 Recording Format

Sample signals can be recorded as WAV files in PCM format at a sampling rate of up to 192 kHz (digital) or at a bandwidth of 80 kHz (analog).

The WAV format supported during Record and Play is based on the RIFF (Resource Interchange File Format) specification developed by Microsoft and IBM in 1991. This standard is virtually a container for all possible multimedia resources such as video, audio, bitmaps or even text in RTF format. RIFF has meanwhile become an interchange format which is now cross-platform (Windows, Unix/Linux, Mac OS). This means that the analysis of a PCM coded audio stream acquired with the aid of the R&S UPV is not limited to tools that will run in Windows. The one thing to be aware of is that some older audio analysis software supports only the standard WAV format with up to 16 bit resolution.



Recording takes place in standard or extended WAV format, depending on the word width. The extended format (with 32 bit integer) is necessary in the case of analog signals and in the case of more than 16 audio bits in the digital analyzer. The R&S UPV automatically determines the smallest possible format and all header entries on the basis of sampling rate or bandwidth, number of channels (mono or stereo) and word width (number of audio bits).

Acquisition is in dual-channel mode in the stereo format; if only one channel is switched on, the system switches automatically to a suitable mono format.

Playback and offline measurement can take place regardless of the word width during acquisition. In the case of the larger word widths, audio bits that are not present are zero-filled and in the case of the smaller word widths unused audio bits are rounded. In this way recorded signals (analog or digital) can be played back and measured via one of the optional digital interfaces (e.g. I²S) with a narrower word width in order to examine what effect different word widths may have. In the case of stereo acquisitions the two channels can also be played back and examined individually (mono).



For analog signals acquired in dual-channel mode to be played back as stereo signals, either the R&S UPV-B3 option or a digital option must be installed. Otherwise the two channels must be played back and examined in sequence.

The sampling rate set for the acquisition should also be used on playback. In the analog analyzer and generator, the set bandwidth implicitly defines the sampling rate:

- Bandwidth 22 kHz: Recording / playback with 48 kHz sampling rate
- Bandwidth 40 kHz: Recording / playback with 96 kHz sampling rate
- Bandwidth 80 kHz: Recording / playback with 192 kHz sampling rate

When the WAV file is loaded, the generator issues an appropriate warning if the generator sampling rate does not match the sampling rate entered in the WAV file.



For analog playback of digital signals that have been acquired using a sampling rate that is not suited for the analog generator (e.g. audio CDs with 44.1 kHz), the analog generator provides the bandwidth setting "Play Auto". When this setting is used the generator sampling rate is automatically set to the sampling rate of the WAV file.

5.36.3 Monitoring the Recording

Important signal parameters are measured and displayed during the actual recording. These include:

- Frequency and in some cases the sampling rate
- Peak value at input level (prior to prefilter)
- Peak or RMS value at monitor level (after prefilter)
- RMS value at function level (after the function filters)

In addition the following are displayed so that the signal can be assessed graphically:

- The waveform monitor, continuously, from the start of the Record function to the triggering of recording,
- The start of the recording, if necessary taking into account the pretrigger, in the time and frequency domains (waveform monitor and post FFT).

Additional acoustic monitoring of the acquisition is available via the audio monitor.

5.36.4 Recording Modes of the Record Function

Depending on the application, the RECORD function can be for a continuous or single measurement, and may be either triggered or started manually:

- The recommended method for examining a signal at a later time or with an external analysis program is "manual single recording" over a fixed time period.
- To look for a seldom occurring event the most suitable method is "triggered single recording", provided the event is capable of being triggered.
- To analyze sporadically occurring events that can be triggered, the recommended method is "triggered continuous recording". Create a separate file for each trigger event. This then receives the time stamp of the event concerned.
- The "manual continuous recording" is required to search for faults that cannot be triggered, yet can be identified by the user (by listening or by the measured values): The user selects a maximum recording time and stops the recording as soon as the event being searched for occurs. The starting time of the acquisition is deferred so that the desired recording time is not exceeded even if the event takes a very long time to occur.

A continuous recording is started in the usual way with the START key, and a single recording is started with the SINGLE key. Once started, a continuous recording can be terminated as a single recording at any time with the aid of the SINGLE key. A continuous recording must and a single recording can be halted and terminated by pressing STOP key.



After closing a manual continuous recording, a short merge procedure is required in order to shorten the recording to the desired length. The file is not ready for playback or copying until the relevant message has disappeared from the status line.



A triggered continuous recording which deliberately or otherwise has not been stopped keeps writing to the data medium until it is full. This means that no data is lost except for the last incompletely written WAV file. However, in order to continue working with the data medium (e.g. to store trace data or setups), the data medium should be "tidied up" as soon as possible.

5.36.5 Operating the Record Function

In preparation for recording, select any file name from the hard drive or network drive. Short files may also be stored on a USB stick. The R&S UPV then checks how much storage is available on the medium and determines the maximum recording time according to the sampling rate or bandwidth, the number of channels and the word width. You then only need to enter the length of the acquisition and you can start recording straight away ("Trig Source Manual").

In order to synchronize the start of recording with a particular level, a trigger system can be activated ("Trig Source Channel 1 / Channel 2). In this case the length of an optional pretrigger can also be specified in addition to the trigger conditions (trigger

channel, exceeding or dropping below a selectable trigger threshold). This makes it possible to record the history of events leading up to the trigger event.

The settings cannot be changed after the "recording" function has been started. Any user entry or change of the sampling rate (if "Sample Freq Auto" is enabled) causes recording to stop immediately (the same as pressing the STOP key). In contrast to online measurements, recording is not restarted automatically after a user entry; it must be triggered explicitly by the user.

There are one or two restrictions on the permitted settings compared to online measurements. These are checked when the Record function starts, and an error message is issued if necessary:

- Autoranging is not possible in the analog analyzer; "Range" must be set to "Fix".
- "Auto" must be set as the "Start Condition"; the Record function provides a dedicated trigger system for triggering.
- Only time triggered automatic sweeps ("dwell sweeps") are permitted in the generator. WAV files for external sweeps can be created with the aid of these sweeps (see [chapter 5.36.6, "Create WAV files for external sweeps"](#), on page 597).
- The sampling rate must not exceed 200 kHz; in the analog analyzer, the bandwidth must not be set to 250 kHz.
- Only one analyzer filter should be enabled at high sampling rates (digital sampling rates greater than 100 kHz or analog bandwidths greater than 40 kHz).



Continuous processing of the measured values over a relatively long time is only guaranteed for sampling rates up to 96 kHz or analog bandwidths up to 40 kHz. If the sampling rate is too high or the bandwidth is too large, the measurement will be terminated with a suitable error message. If this happens, it may be necessary to reduce the number of analyzer filters that are being used.

Function

For activating offline analysis by switching the measurement function to "Record".

The RMS value of the signal is displayed as the result of the measurement function.



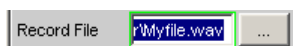
Remote command:

`SENSe[1]:FUNCtion RECOrd`

Record File

For entering the drive, path and file name of the WAV file.

The recommended data medium is the data partition of the hard disk (default setting "D:\UPV\USER") or a fast network drive (at least 100 Mbits/s). Due to their low transfer rate, USB sticks and USB drives should be used for short files only.



Note: When Record and Play are operated simultaneously, you should take care that the same file is not used. This way of operating is not actually prohibited, but the results are not usually meaningful.

Once the file name is entered (acquisition does not start yet) a check is made to see how much storage is available on the data medium. An existing WAV file having the name you specified is deemed to be free memory space, since it will be overwritten during recording. The size of the available storage together with the required formats are used to compute the maximum possible recording length and this is entered as the upper limit in the following menu item "Record Length".

Note: The maximum size of a WAV file is 4 GByte. Only 30 % of the available storage is provided for a single WAV file. The remainder is kept free for a second temporary WAV file and for other user files (e.g. setups, trace data, screenshots).

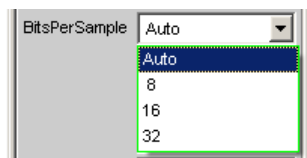
In "triggered continuous recording" mode, the file names of the individual WAV files must be generated automatically. For this the selected file name is given a numeric name extension which starts at 0 and is incremented for each subsequent acquisition. To avoid inadvertently overwriting the generated WAV files when starting a new recording, this counter is only reset when a new file name is entered in "Record File" or the R&S UPV is closed.

Remote command:

[SENSe<n1>:FUNctIon:RECOrd:FILE](#) on page 952

Bits per Sample

Number of bits per sample in which the waveform format is coded.



"Auto" Digital: Orients itself to the audio bits. The next suitable number of bits per samples is set.
 Analog: The 24 bits of the ADC are rounded to 32 bits per sample in the float format.

"8, 16, 32" 8-bit integer, 16-bit integer, 32-bit float format

Remote command:

[SENSe<n1>:FUNctIon:RECOrd:BPS](#) on page 952

Record Length

For entering the recording time.



The maximum recording time depends on the following parameters:

- The amount of memory available on the used data medium; around 30 % of the current storage capacity can be used.
- The maximum size of a WAV file, being around 4 GB (232-1 bytes for samples plus header information)
- The number of channels to be acquired (1 or 2)

- The sampling rate (in the analog analyzer this is determined from the selected bandwidth)
- The word width (8, 16, or 32; always 32 in the analog analyzer)

If these parameters are subsequently changed, the recording time is reduced as necessary.

For a dual-channel analog acquisition (22 kHz bandwidth * 48 kHz sampling rate) the maximum time is three hours due to the size restriction on the WAV files (186.414 min).

Note: In the case of triggered continuous recording the recording lengths are summed, as are also the storage requirements of the individual WAV files, so that in the worst case the data medium becomes completely filled. It is therefore best to work with only short recording times in this recording mode.

Remote command:

[SENSe<n1>:FUNction:RECOrd:LENGth](#) on page 952

File Length

This displays the file length in bytes



The file length depends on the following parameters:

- The selected recording time
- The number of channels to be acquired (1 or 2)
- The sampling rate (in the analog analyzer this is determined from the selected bandwidth)
- The word width (8, 16, or 32; always 32 in the analog analyzer)

With maximum recording time and sufficient storage capacity, this comes to 4 GB.

In "triggered continuous recording" mode the number specified here is the length of each individual file. The total storage needed for this operating mode is therefore n times greater.

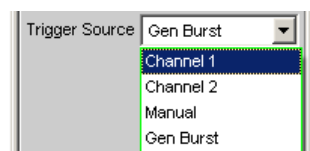
Note: If recording is terminated prematurely, the actual length of the WAV file is correspondingly less.

Remote command:

[SENSe<n1>:FUNction:RECOrd:FLENGth?](#) on page 952

Trigger Source

For activating / deactivating the Record trigger system and selecting the trigger source.



Selects the source which is intended to trigger recording on exceeding or dropping below the trigger level.

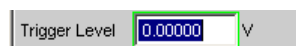
"Channel 1"	For activating the Record trigger system; measurement channel 1 triggers recording. Only selectable if measurement channel 1 is switched on (or both channels).
"Channel 2"	For activating the Record trigger system; measurement channel 2 triggers recording. Only selectable if measurement channel 2 is switched on (or both channels).
"Manual"	For deactivating the Record trigger system; recording starts immediately as soon as the Record function starts.
"Gen Burst"	Recording is synchronized to the start of the generator signal (preferably Sine Burst). Not available in multichannel analyzers. The generator signal is first muted briefly (approx. 3 ms) and then restarted with zero-degree phase ("Burst On" phase). Measurement data recording is started at the same time, taking internal signal delays into account. It is thus possible to graphically determine the signal delay of the DUT from the waveform display by selecting "Gen Burst" and using a suitable signal from the internal generator (see chapter 5.35.2, "Delay Measurement" , on page 584). Note: In this mode, the settling time of any filter that may be enabled is not taken into account for starting the measurement. In other words, the measurement starts without any delay and thus includes the settling phase of the filters.

Remote command:

[SENSe<n1>:FUNctIon:RECOrd:TRIGger:SOURce](#) on page 953

Trigger Level

For entering the trigger threshold; appears only when the trigger system is active.



Depending on the trigger slope, recording is triggered on exceeding this level threshold (Trigger Slope Rising) or dropping below it (Trigger Slope Falling).

Once the Record function has started or (in "triggered continuous recording" mode) once the old recording has ended, a new recording is only alerted (armed) again if at least one sample is below the trigger threshold (for Trigger Slope Rising) or above the trigger threshold (for Trigger Slope Falling).

Remote command:

[SENSe<n1>:FUNctIon:RECOrd:TRIGger:LEVel](#) on page 953

Trigger Slope

Used to select the signal edge on which measurement is to be triggered (trigger slope); appears only when the trigger system is active.



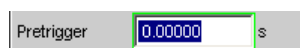
"Rising"	"Triggering" takes place when the level on the measurement channel selected as trigger source exceeds the trigger threshold for the first time. (Re-)arming takes place as soon as a level below the trigger threshold occurs.
"Falling"	"Triggering" takes place when the level on the measurement channel selected as trigger source drops below the trigger threshold for the first time. (Re-)arming takes place as soon as a level above the trigger threshold occurs.

Remote command:

[SENSe<n1>:FUNction:RECOrd:TRIGger:SLOPe](#) on page 953

Pretrigger

For activating / deactivating the pretrigger and entering the pretrigger interval in seconds.



The pretrigger is deactivated by entering a pretrigger time of 0.0 s.

Entering a pretrigger time shifts the trigger point within the selected recording time; the total recording time stays unchanged.

The size of the pretrigger memory is 19200 samples, which is therefore 100 ms to 400 ms depending on the sampling rate.

When the waveform monitor is on, the pretrigger time is visible as a negative time segment of the time axis.

Remote command:

[SENSe<n1>:FUNction:RECOrd:TRIGger:PRE](#) on page 953

Filter

For activating a digital filter in the acquisition data stream.

Up to three user-definable or weighting filters can be looped into the acquisition data stream in order to apply a weighting to the acquired samples or to carry out band limiting.



If the intention is to acquire the samples as raw data, all three filters and the prefilter (in the "Analyzer Config" panel) must be off. Filtering can then take place during offline measurement.

The user-definable filters are configured as filter 01 to 09 in the filter panel (see [chapter 5.44, "User-Definable Filters"](#), on page 628) and can then be used (repeatedly if necessary) in the analyzer.

For more information on the available weighting filters, see [chapter 5.45, "Weighting Filters"](#), on page 637.

Note: Regardless of the digital filters selected here, a further input filter ("prefilter") can be looped into the acquisition data stream. Moreover, the analog bandwidth can be restricted with the aid of the "Bandwidth" parameter field, which corresponds to an additional lowpass filter. Due to considerations of memory space and performance, the Record function should always be operated using the smallest possible bandwidth.

Remote command:

`SENSe<n1>:FILTer<n2>` on page 958

For a description of the filters and their setting parameters, see [chapter 5.43.4, "Filter Table"](#), on page 628.

5.36.6 Create WAV files for external sweeps

When there is an internal connection between the generator and the analyzer, the "Record" function can be used in conjunction with the internal generator to create WAV files for external sweeps. This should preferably take place in a digital domain (via a digital audio or I²S interface) because then any format can be generated (8 or 16 bit standard, 32 bit extended) using any sampling rate (e.g. 44.1 kHz) without the need for D/A and A/D conversion. In fact even an analog interface is suitable if need be, for instance if there is no digital option installed; but then only the 32 bit extended format can be generated.

Select the desired signal form from the generator and activate a time triggered automatic sweep, as normal

Sweep Ctrl	Auto Sweep
Next Step	Dwell Value
Dwell	1.00000 s

or a list sweep.

Sweep Ctrl	Auto List
Next Step	Dwell File
Dwell File	C:\UPV\confi ...

The sweep can be one-dimensional or two-dimensional (z sweep); the dwell time may be specified as a constant value or with the aid of a dwell list.

The Record function should be set as an untriggered single or continuous recording; a triggered (single) recording is also allowed.

Trigger Source	Manual
----------------	--------

If you wish filters to be used, you may switch them on in the generator or analyzer.

Pressing the START key starts a continuous sweep in the generator and at the same time also starts the untriggered single recording in the analyzer. When the set recording time is reached, acquisition stops and the generator sweep keeps running unchanged until halted by the STOP key or, in the case of two-dimensional sweeps, until the z-axis has been processed.

Pressing the SINGLE key starts a single sweep in the generator and at the same time also starts the untriggered single recording in the analyzer. If the set recording time is shorter than the sweep time, acquisition stops and the generator sweep keeps running until the end of the sweep. If the sweep ends before the set recording time is reached, recording is also stopped (prematurely).

Pressing the STOP key halts the sweep and the recording immediately in all cases.

In order to create a WAV file containing exactly one sweep cycle, "Record Length" should be set to the maximum value and a single sweep should then be started with the SINGLE key. If a two-dimensional sweep needs to be recorded, the START key should be used.



The special mode "triggered continuous measurement" is not useful and is therefore not used; instead, a normal single recording is triggered when the trigger system is activated.

5.37 Infrasound Measurements

"Infrasound" refers to the frequency range extending from the lower limit of the human auditory range (16 Hz) down to the low millihertz region.

Although the R&S UPV is primarily designed for use in the audible frequency range, it can work with frequencies much lower than 10 Hz (i.e. generate and acquire such signals for measurement). It is recommended that the R&S UPV-K6 option (Extended Analysis Functions) is installed in order to take full advantage of the infrasound functionality of the R&S UPV.

5.37.1 Infrasound Signals

The following types of signals can be used for simulations in the infrasound range:

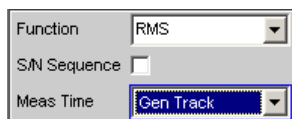
- Multi-sine for frequencies down to 1 Hz; with a frequency resolution of 1 Hz
- Sine for frequencies down to 100 mHz, or down to 10 mHz if the R&S UPV-K6 option (Extended Analysis Functions) is installed.
- Stereo Sine for frequencies down to 100 mHz, or down to 10 mHz if the R&S UPV-K6 option (Extended Analysis Functions) is installed.

These signals can be output via any desired digital or analog interface.

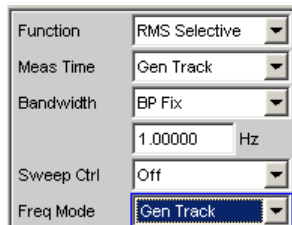
5.37.2 Infrasound Analysis

The measurement options with infrasound are limited to the following types of measurements:

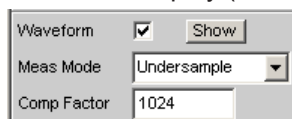
- RMS measurement (wideband, without S/N sequencer) with a fixed measurement time or generator tracking



- RMS measurement (selective with fixed bandwidth) with fixed measurement time or generator tracking down to a sampling rate / 48000 (limited to 1 Hz).



- Waveform display (recommended operating mode: Undersample)



- Frequency measurement ("measuring time" **Precision** only with R&S UPV-K6 option and active Undersample FFT)

The frequency resolution can be increased considerably by undersampling if the R&S UPV-K6 option (Extended Analysis Functions) is installed.

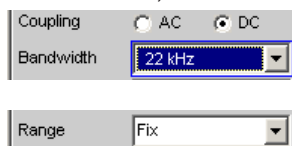
In this case, the following types of measurements are also possible:

- FFT in the "Undersample" operating mode
- Phase measurement (only if "Undersample FFT" is enabled)
- Level monitor measurements (only if "Undersample FFT" is enabled)
- Input peak measurement (only if "Undersample FFT" is enabled)

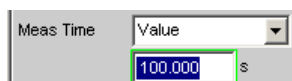
The automatic operating modes, which are optimized for the audible frequency range, cannot be used for analyzing infrasonic signals,

Consequently, the following restrictions must be observed:

- "Analog analyzer": The autoranger must be switched off, the input coupling must be set to DC, and the smallest possible bandwidth should be selected.



- "RMS measurement": The only modes that can be used for "Meas Time" are "Gen Track" and "Value". The longest measurement time is 100 s, which means that signals as low as 10 mHz can be captured.



"Undersampling " can be used to visualize extremely low-frequency signals in an FFT and distinguish them from DC. With undersampling, the compression factor can either be entered directly (in which case it is automatically rounded to the nearest power of 2)

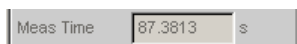
or set by entering the desired FFT bandwidth. If the FFT bandwidth is entered, the compression factor is calculated automatically from the FFT bandwidth.

The following aspects must always be taken into account when selecting the compression factor:

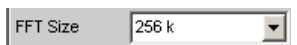
- The "measurement bandwidth " is decreased by the selected compression factor



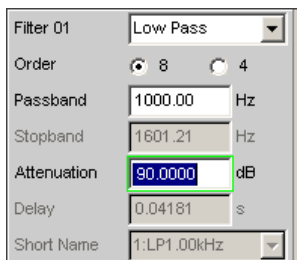
- The "measurement time " is increased by the selected compression factor



- The "FFT Size " should be as large as possible. For a given frequency resolution, reducing the FFT size causes the compression factor to increase, which unnecessarily limits the FFT bandwidth. Although the computation time is somewhat less with a smaller FFT size, this is far more than offset by the increased sampling time.



- "High-frequency signal components " (outside the selected FFT bandwidth) will be visible in the observed frequency band as image frequencies. Consequently, it is necessary to use a suitable "lowpass filter " with a cutoff frequency that adequately suppresses signal components outside the selected FFT bandwidth. It can be configured as an input filter or as a function filter selected from the FFT menu. If the analog analyzer is used, it is of course also possible to use an external analog filter.



If the lowpass filter is configured as a prefilter, it **also** affects the level monitor and fast frequency measurements. If it is configured as a function filter, it only affects the FFT and waveform displays and precision frequency measurements.

Bearing these aspects in mind, the compression factor or FFT bandwidth (span) should be dimensioned according to the signal components to be examined, as follows:

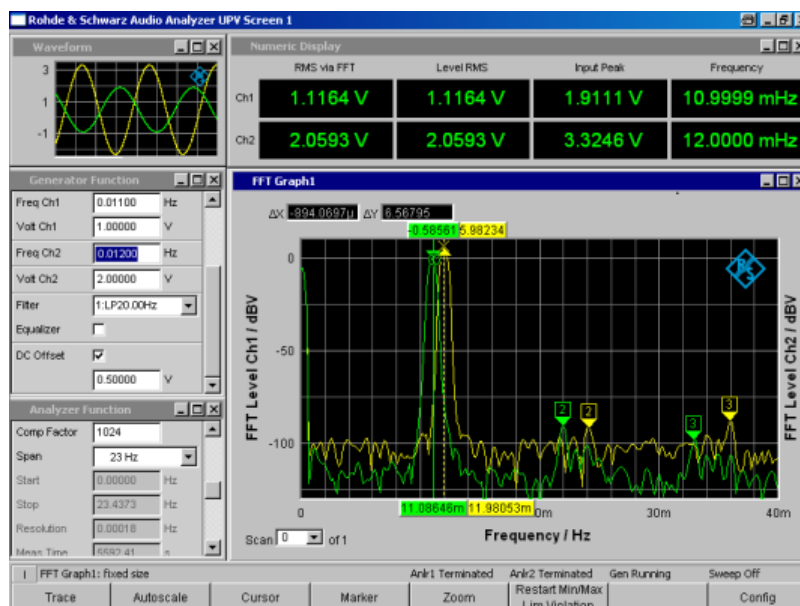
- Generally speaking, the compression factor should be as small as possible in order to minimize the measurement time.
- The FFT size should be set to 256 K.
- The compression factor must be large enough to allow the signal components under investigation to be visualized with sufficient frequency resolution.

- The FFT bandwidth must be large enough to acquire the highest frequencies under investigation.

The following sample measurement of a stereo signal with offset shows the maximum frequency resolution that can be achieved in the analog domain (0.18 mHz). The measurement time is approx. 93 minutes. After the measurement data has been recorded, the graphic zoom function can be used to examine selected regions of the 256 K-FFT e.g. the range of 0 mHz to 40 mHz as shown in the example).



The measurements described here should be performed as single measurements due to their long measurement times.



5.38 Protocol Analysis

To be able to select the protocol analysis in the digital audio instrument, the R&S UPV-B2 (digital audio interface) and R&S UPV-K21 (digital audio protocol) options have to be installed; if the R&S UPV-B20 (digital audio interface, 48 kHz) option is installed, the R&S UPV-K21 (digital audio protocol) option cannot be used.

The Digital Audio interface can be used not only to analyze the audio data content of both channels, but also at the same time to decode the channel-status information and display transmission errors by means of error flags.

5.38.1 Activating and Configuring the Protocol Analysis

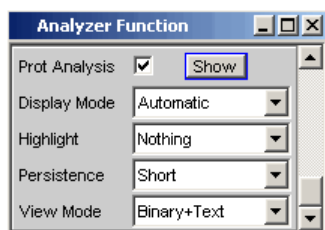
The protocol analysis is configured in the Analyzer Function panel. The channel-status information and error flags are displayed in a separate window known as the Dig Analyzer Protocol window. This window can be opened via the "Menu bar - Displays - Dig


Analyzer Protocol" from within the Analyzer Config panel or from within the Analyzer Function panel.

The setting parameters for the protocol analysis appear at the end of the Analyzer **Function** panel.

Prot Analysis

For activating the protocol analyzer.



Click the "Show" button to open the "Dig Analyzer Protocol" window. You can close the window, as with any other, by means of the CLOSE button or by clicking on the  button in the title bar.

"deactivated" The protocol analyzer is off.
This setting is recommended for increasing the measurement speed (e.g. in the case of sweeps or in remote-control mode), if protocol data is not currently needed.
The current channel-status information is frozen when this feature is switched off.

"activated" The protocol analyzer is on. The parameter fields shown above are displayed.
The channel-status information is read out from both channels at the end of a single measurement. When a continuous measurement is running the channels are read in sequence, that is, only one channel is updated each measurement cycle.

Note: The internal hardware determines the channel-status information for channels 1 and 2 on a sequential basis only. This information is therefore available only after $2 \cdot 192$ samples at the earliest. A single measurement must therefore capture at least 384 samples, which can lengthen the measurement time during fast measurements.

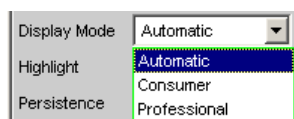
Remote command:

[SENSe8:FUNCTION ON | OFF](#)

[SENSe8:PROTOCOL:DISPLAY](#) on page 954

Display Mode

For selecting the display format of the channel-status information.



Depending on the format bit (bit #0 of the channel-status bits), the following bit fields have a different meaning. This menu item defines whether the channel-status information is interpreted according to the Consumer format or the Professional format.

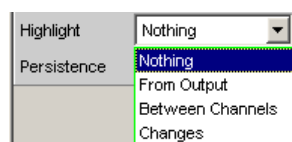
- "Automatic" The channel-status bits are interpreted in the format specified by bit #0. If this bit changes, the format is changed automatically to the correct one.
- "Consumer" The channel-status bits are always interpreted in Consumer format in accordance with the IEC 60958-3 standard regardless of the state of bit #0. This avoids the possibility that a bit error in bit #0 might cause the display format to switch over.
- "Professional" The channel status bits are always interpreted in Professional format in accordance with the IEC 60958-4 or AES3 standard regardless of the state of bit #0. This avoids the possibility that a bit error in bit #0 might cause the display format to switch over.

Remote command:

[SENSe8:PROTOCOL:MODE](#) on page 954

Highlight

For defining whether and if so when channel-status information is to be highlighted.



Highlighted channel-status information is displayed in red instead of black.

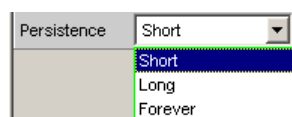
- "Nothing" Channel-status information is not highlighted.
- "From Output" Changes compared to the channel-status information generated by the R&S UPV generator are highlighted. This setting is only worthwhile when the internal generator is used and channel-status information is being generated.
- "Between Channels" Differences between the two channels are highlighted. The differences are displayed on both channels.
- "Changes" This is for highlighting all changes since the start of the measurement, that is, since the START key was last used.

Remote command:

[SENSe8:PROTOCOL:HIGHLIGHT](#) on page 954

Persistence

For defining how long a highlight should stay.



Regardless of the setting selected here, all highlighting is reset when the START key is used.

- "Short" Highlighting is only brief and is reset after one second.

"Long" Highlighting is reset after five seconds.

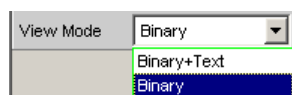
"Forever" Highlighting is never reset.

Remote command:

[SENSe8:PROTOCOL:PERSistence](#) on page 954

View Mode

For defining how the channel-status information should appear.



"Binary+Text" The bit fields are displayed both as binary values (MSB first) and in plain text.

"Binary" The bit fields are displayed only as binary values (MSB first). This reduces the space required by the "Dig Analyzer Protocol" window.

Remote command:

[SENSe8:PROTOCOL:VIEW](#) on page 954

5.38.2 Channel-Status Information Display

The R&S UPV decodes the first five bytes of each channel and displays the current information from the individual bit fields in a readable form for both channels in the "Dig Analyzer Protocol" window.

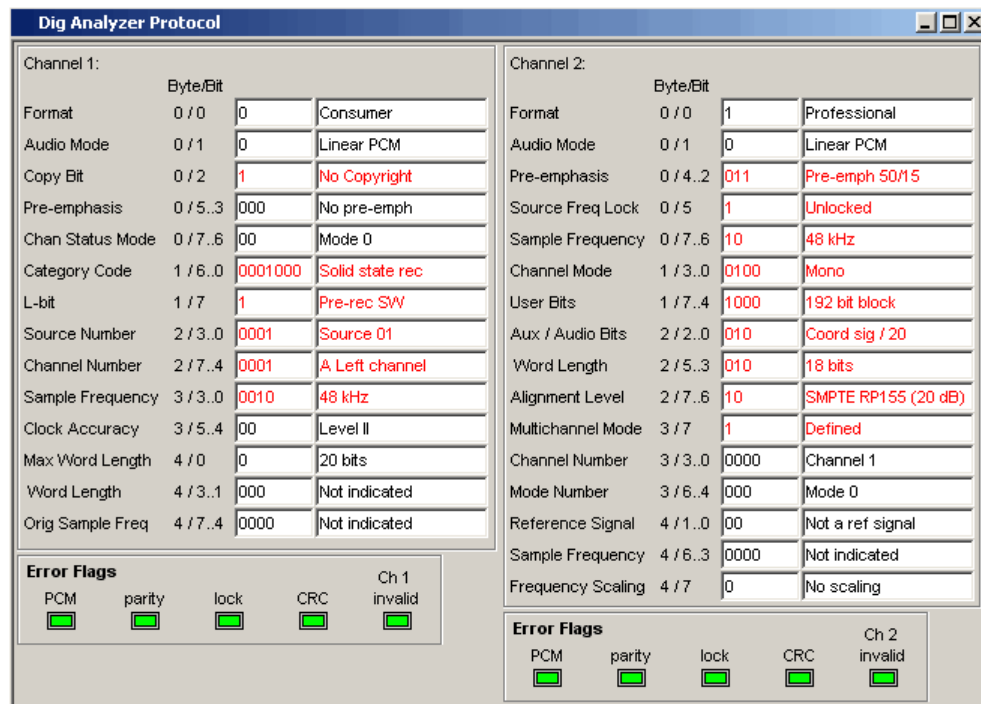


Digital Audio instrument: Channel information is always decoded and displayed for both channels, regardless of whether only one or both audio channels are being measured.

There are two different formats, defined by the value of the first bit:

- The format for the consumer area (Consumer format); bit #0 = 0
- The format for the professional area (Professional format); bit #0 = 1

In the Automatic display mode the correct format (Consumer or Professional) is set for each channel according to its format bit, so that even data streams with a different format in channels 1 and 2 can be displayed.



When the format is predefined the meaning of the individual bit fields, as well as the interpretation of the content and even of the position and length of the bit fields depend on other, preceding bit fields. These formats are continually being developed by the IEC standardization committee, for which reason new and previously reserved bit combinations are added. The Dig Analyzer Protocol window can be upgraded to the latest state with the aid of updates to the R&S UPV software.

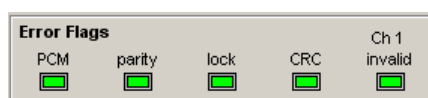
The values and meanings currently available for a bit field can be found in IEC standard 60958-3 (Consumer Applications) or IEC 60958-4 (Professional Applications), or the Protocol Generator panel.

5.38.3 Error Flag Display

In addition to channel-status information, the "Dig Analyzer Protocol" window also displays the "Error-Flags " which indicate errors in the data stream. When an error occurs the color of the "LED "changes from green to red. As soon as the error disappears the "LED " goes back to green.



Just as with the channel-status information, the error flags are read at the end of a measurement cycle. The error flag update rate therefore depends on the measurement time of the function that has been set. In the case of single measurement the status read at the end of the measurement stays unchanged until a new measurement has started and finished.



- **"PCM"** indicates whether the signal is Linear PCM-coded (green) or not (red). This error flag corresponds to audio mode (bit #1 of the channel-status data).
- **parity** indicates whether parity checking has detected an error (red).
- **lock** indicates whether a valid digital signal is present (green); if the DUT delivers no clock or the input is open, "lock" is (red).
- In the Professional format, **CRC** indicates that CRC checking has detected an error (red). IN the Consumer format, no CRC error is indicated (green).
- **CH1 invalid** or **CH2 invalid** indicates the status of the validity bit in the protocol. Red means that the corresponding channel is invalid.



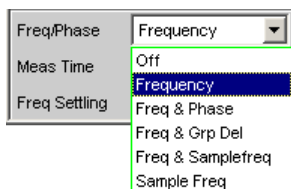
All error flags will be set (red) if a Lock error occurs.

5.39 Frequency, Phase and Group Delay Measurement

The frequency measurement and combined frequency/phase/group delay measurement are performed upstream of the function-specific digital filters, but downstream of the prefilter. In the two-channel analog analyzer, the frequency is measured downstream of the notch filter (if the analog notch filter is activated). If the fundamental is rejected with the notch filter, the frequency meter determines the frequency of the residual signal.

Freq Phase

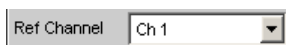
Used to activate the frequency measurement (for the reference channel) and to select the measured value for the other channels.



With 1-channel measurements, it is only possible to select the frequency measurement here; measurement of the sampling frequency can be selected here in the digital analyzer.

With 2-channel or multichannel measurements, the frequency on the other channels is often the same as the frequency on the reference channel. In such cases, it is advisable to display a frequency-related measured value instead of the frequency in the measurement window of the other channels.

Note: In two-channel analyzers, the "reference channel" is always "channel 1", in multichannel analyzers, the reference channel is "user-definable in the Analyzer Config Panel".



"Off"

Frequency measurement is deactivated.

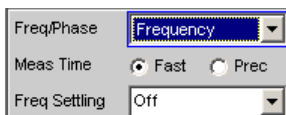


Note: For signals for which no zero crossing can be detected (e.g. weak noise signals, pure DC signals or very low frequency AC signals), the frequency measurement can be switched off, which will considerably reduce the total measurement time.

Note: For frequency measurements, the input signal – beginning in the zero crossing – must be observed over one complete period, but with at least 100 samples. For function measurements with an extremely short measurement time (e.g. peak measurement 1 ms interval), the frequency measurement should therefore be deactivated.

"Frequency"

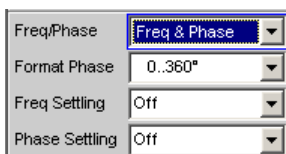
Frequency measurement is performed on all activated channels.



"Freq & Phase"

Only available for two-channel measuring mode or in a multichannel analyzer.

Frequency measurement is performed on the reference channel; the measurement windows of the other channels contain the phase of the other channel referenced to the reference channel.



If a phase is shown as invalid, the frequencies of this channel and the reference channel are different or one of the channels does not have an input signal.

Note: This measuring mode should only be selected if the frequency on the reference channel is identical with the frequency on at least one other measurement channel.

"Freq & Grp Del"

Only available for two-channel measuring mode or in a multichannel analyzer.

Frequency measurement is performed on the reference channel; the measurement windows of the other channels contain the group delay of the respective channel referenced to the reference channel.



Note: This measuring mode should only be selected if the frequency on the reference channel is identical with the frequency on at least one other measurement channel. The group delay measurement should only be used in the case of frequency changes (e.g. with frequency sweeps); a group delay is not defined in the case of constant frequency.

The group delay is measured by differentiation of phase with respect to frequency, i.e. by evaluating the difference quotient.

$$t_2 [s] = \frac{\Delta\varphi}{2 \cdot \pi \cdot \Delta f}$$

where

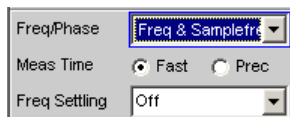
$$\Delta\varphi = \varphi_{2mes} - \varphi_{1mes}$$

The following points must be taken into consideration when selecting a frequency sweep for measuring the group delay:

- The frequency step size and the number of sweep points must be selected such that no phase shifts of more than 180° occur between two consecutive sweep points.
- The spacing should be linear; with logarithmic spacing the frequency increments at the bottom could become too small and the phase shifts at the top could become too large.
- In the case of group delay measurement over frequency (e.g. by means of a generator frequency sweep), the first sweep point is undefined because a reference point for calculating the delta values of frequency and phase is only available as of the 2nd frequency value.

Note: For signals with a poor S/N ratio, the quality of the group delay measurement can be considerably improved by increasing the "FFT size" or by "FFT" averaging (Avg Normal). "To this effect, the measurement function is to be set to FFT."

"Freq & Sample Freq" Only available for two-channel or multichannel measuring mode in the digital analyzer.
The sampling frequency is measured on the channel last activated. On all other channels (i.e. channel 1 in two-channel analyzers), a frequency measurement is performed.



Note: In this measuring mode, the audio frequency of the last channel is not measured.

The sampling frequency is measured with a resolution of 22.9 mHz and an update interval of approx. 700 ms.

Note: If the sampling frequency is changed by more than 3 Hz, a precision measurement is performed that takes max. 1.5 s. If the "Sample Freq" measurement is activated, therefore, the total time required by a single measurement may be extended to up to 1.5 s.

"Sample Freq" Only available in the digital analyzer.
The measurement windows contain the sampling frequency.



In this measuring mode, the audio frequency is not measured.

The sampling frequency is measured with a resolution of 22.9 mHz and an update interval of approx. 700 ms.

Note: If the sampling frequency is changed by more than 3 Hz, a precision measurement is performed that takes max. 1.5 s. If the "Sample Freq" measurement is activated, therefore, the total time required by a single measurement may be extended to up to 1.5 s.

Remote command:

`SENSe3:FUNCtion OFF | FREQuency | FQPHase | FQSamplefrequency | SFrequency`

Meas Time

Used to select the measurement speed.



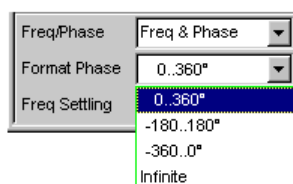
- "Fast" The frequency and (if applicable) phase measurement is optimized with respect to speed. A 4 k FFT is used as the measurement basis for high frequencies and the phase; low frequencies are determined by means of an evaluation of period (with interpolation). This measuring mode does not require any additional processing performance, i.e. the total measurement time of all activated measurement functions does not increase.
- Recommended for pure frequency measurements on single-tone signals or for phase measurements on signals whose frequency is not too low (higher than 2 % of the bandwidth and 1 % of the sampling frequency).
- Note:** In the case of distortion measurements the frequency must be very accurately determined. The accurate result of this frequency measurement is then displayed. The frequency accuracy in fast mode therefore depends on the measurement function selected.
- "Prec" The frequency and (if applicable) phase measurement is optimized with respect to precision. A precision FFT with up to 256 k points is used as the measurement basis. The FFT length is automatically adapted to the measured signal frequency so that measurement can always be performed with the smallest possible FFT (and, therefore, in the shortest possible time).
- Depending on the activated measurement function, the total measurement time can increase in this measuring mode since it may be necessary to calculate an (additional) FFT.
- Note:** Digital or analog filters which are active in the activated function measurement are also used in the frequency measurement. If only the unfiltered frequency or phase measurement result is required, the function measurement should be deactivated.
- Recommended for signals with a high noise component, multi-tone signals and for measuring the phase of low frequencies.

Remote command:

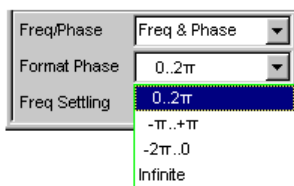
[SENSe3:FREQuency:APERture:MODE](#) on page 955

Format Phase

Used to select the phase display format; only available if phase measurement is activated.



or



depending on whether degrees or RAD has been selected for the phase unit.

"0..360°"	The phase is displayed in the range 0° to 360°; only available if "°" has been selected for the phase unit.
"-180..180°"	The phase is displayed in the range +/- 180°; only available if "°" has been selected for the phase unit.
"-360..0°"	The phase is displayed in the range -360° to 0°; only available if "°" has been selected for the phase unit.
"0..2π"	The phase is displayed as a radian from 0 to 2π; only available if "RAD" has been selected for the phase unit.
"-π..+π"	The phase is displayed as a radian from -π to +π; only available if "RAD" has been selected for the phase unit.
"-2π..0"	The phase is displayed as a radian from -2π to 0; only available if "RAD" has been selected for the phase unit.
"Infinite"	The phase is displayed continuously (-∞ to +∞).

Note: The continuous phase display is mainly used for frequency sweeps, to allow the phase characteristic to be displayed even in the case of phase displacement above 360°. This measuring mode is usually unsuitable for measurements without frequency variation since such measurements do not have a valid previous value.

The continuous phase is measured by adding the phase difference between two consecutive phase measurement results to the phase measured value of the first measurement result:

$$\varphi_2 = \varphi_1 + \Delta\varphi$$

where

$$\Delta\varphi = \varphi_{2mes} - \varphi_{1mes}$$

When configuring a frequency sweep for measuring the continuous phase, the frequency step size and the number of sweep points must be selected such that no phase shifts of more than 180° occur between two consecutive sweep points.

Remote command:

[SENSe3:PHASe:FORMat](#) on page 955

5.40 Input Monitor

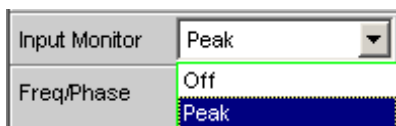
The input monitor is a pure level meter that acts as a level monitor and measures the input level upstream of **all** digital filters (thus also **upstream** of the prefilter). In the two-

channel analog analyzer, only the analog notch filter (if activated) is located upstream of the measurement point of the input monitor.

For other level measurement options, see [chapter 5.25, "Level Measurements"](#), on page 463, and [chapter 5.41, "Level Monitor"](#), on page 612.

Input Monitor

Used to activate the input level meter and to select the measurement method.



"Off"	The "Input Monitor " is switched off.
"Peak"	<p>The peak input value is measured. The numerically highest input sample is determined within a preset interval.</p> <p>Note: In contrast to peak measurement, which – like all measuring functions – takes place downstream of the filters, no interpolation filter (oversampling filter) is used.</p>
"Phase To Ref"	<p>Measurement of the phase between the selected digital input and the reference input.</p> <p>Selectable only in the digital analyzer when the jitter/phase measurement mode is activated.</p> <p>The jitter measurement data (function, level and frequency) is simultaneously displayed in the other measurement windows.</p>
"Dig Inp Amp"	<p>Measurement of the digital input amplitude at the selected digital input ("Bal " or "Unbal ").</p> <p>Selectable only in the digital analyzer when the common/input measurement mode is activated.</p> <p>The common-mode voltage data (function, level and frequency) is simultaneously displayed in the other measurement windows.</p> <p>Note: The common-mode voltage is only measurable at the balanced input socket (Bal). If the unbalanced ("Unbal") input has been selected as "Input", only the digital input amplitude can be displayed. The measured values for the common measurement (function, level and frequency values) are not displayed.</p>

Remote command:

[SENSe2:FUNcTION](#) OFF | IPEak | PHASetoref | DIGinpampl

5.41 Level Monitor

The level monitor is a level meter which is used to determine the level downstream of the prefilter but upstream of the function-specific digital filters. In the two-channel analog analyzer, the analog notch filter (if activated) is also located upstream of the measurement point of the level monitor.

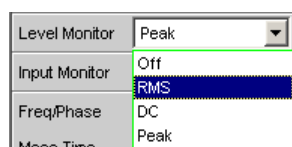
For other level measurement options, see [chapter 5.25, "Level Measurements"](#), on page 463 and [chapter 5.40, "Input Monitor"](#), on page 611.



The level monitor works with period detection and measures the input signal – starting at the zero crossing – across a complete period, but at least with 100 samples. With function measurements with extremely short measuring times (e.g. peak measurement with 1 ms interval time), the level monitor should therefore be switched off.

Level Monitor

Used to activate the level monitor and to select the measurement method.



- "Off" The level monitor is deactivated.
- "RMS" A broadband RMS measurement is performed which – with the frequency measurement switched on – uses automatic period detection. (The measurement method in this case corresponds to the "RMS measurement function" in the "Meas Time Auto mode"). With weak signals, measurement is performed over a fixed period of 100 ms. Any superimposed DC components are also measured, but (in the analog analyzer) are suppressed by the system hardware if the AC coupling is activated.
- Note:** In the case of multitone signals without dominant components, period detection cannot deliver reliable results; in this case, the RMS result exhibits slightly larger fluctuations.
- "DC" A DC voltage measurement with automatic AC suppression is performed. With weak signals, measurement is performed over a fixed period of 100 ms.
- In the analog analyzer, DC coupling should be selected for this measurement mode because the DC component of the measurement signal is filtered out with AC coupling. A suitable warning will be displayed if the coupling is switched to AC with DC measurement enabled, or if the mode is switched to DC measurement with AC coupling selected; however, the measurement is performed.
- Note:** In the case of multitone signals without dominant components, AC period detection cannot deliver reliable results; in this case, the DC result exhibits slightly larger fluctuations.

"Peak" A measurement of the input peak value is performed. The numerically highest input same is determined within a predefined time interval that is also obtained from the period length of the measurement signal. With weak signals, measurement is performed over a fixed period of 100 ms.

Note: In contrast to peak measurement, which – like all measuring functions – takes place downstream of the filters, no interpolation filter (oversampling filter) is used.

Remote command:

`SENSe6:FUNCtion OFF | LRMS | DC | PEAK`

5.42 Settling Methods

5.42.1 Applications

Every signal that is output by the R&S UPV generator passes through several delay elements until it returns via the "DUT" to the measurement hardware of the R&S UPV analyzer. The delay times must be taken into account in order to prevent a new measurement being started – after a signal change – before the new signal becomes visible on the analyzer. The total measurement time, therefore, is made up of the actual measurement time and the delay time.

The internal delays of the R&S UPV are known and taken into account automatically on starting a measurement. The instrument delays are in the range of a few milliseconds, depending on the sampling rate. What may actually cause problems are delays and settling times that occur in the "DUT" and, possibly, also on the transmission lines from the generator to the "DUT" and from the "DUT" to the analyzer.

If they are **known** and **constant** for all signal changes that occur, the total delay may be entered as "Start Condition Delay", and is then treated as a waiting time prior to the start of the measurement – same as the internal delays.

If external delays and settling times are **known but not constant**, the worst-case value can be entered as the delay. In the case of most measurements, however, this will unduly extend total measurement time, especially where the actual measurement time is significantly shorter than the waiting time. Conditions are particularly difficult if external waiting times or the settling characteristics are **unknown** or if an external signal source is used.

For all of these cases, it would be preferable to determine – by way of measurement – the time at which the DUT settled, and only then to carry out the desired measurement.

The purpose of the settling method described here is to determine the settling time by means of a measurement. The basic idea is to perform as many measurements as possible while settling is still in progress and to determine the time at which the signal has settled to an extent that the measured value can be regarded as stable. This time is determined based on the – continuously decreasing – difference between successive measured values.

The settling method is particularly reliable when combined with a trigger condition, as with an external sweep or an external level trigger. In such cases, the trigger condition is not fulfilled until a signal change is detected in the measured value and stabilizes over several measurements.

If there is no such trigger condition (such as with manually started single measurements), in the case of very long delays or very short measurement times it may happen that the desired number of measurements is completed before the signal change becomes visible on the analyzer.

With manually started single measurements, therefore, the external signal delay should be entered as exactly as possible as "Delay" under "Start Condition", while the settling method is activated as well.

- The external signal delay is entered as a fixed delay under "Start Condition".
- The settling time is dynamically measured with the settling method.

The following types of settling can be activated and also combined with one another as desired (i.e. several types of settling can be used simultaneously):

- Settling in the "Start Condition" menu, i.e. with an external level or frequency sweep or with an external level trigger. An additional delay is not required.
- Function settling in the case of distortion measurements and (most) level measurements. As the measurement time becomes shorter relative to the signal delay, it becomes more important to compensate for the signal delay.
- Frequency Settling (not for multichannel analyzers)
- Phase Settling (not for multichannel analyzers)

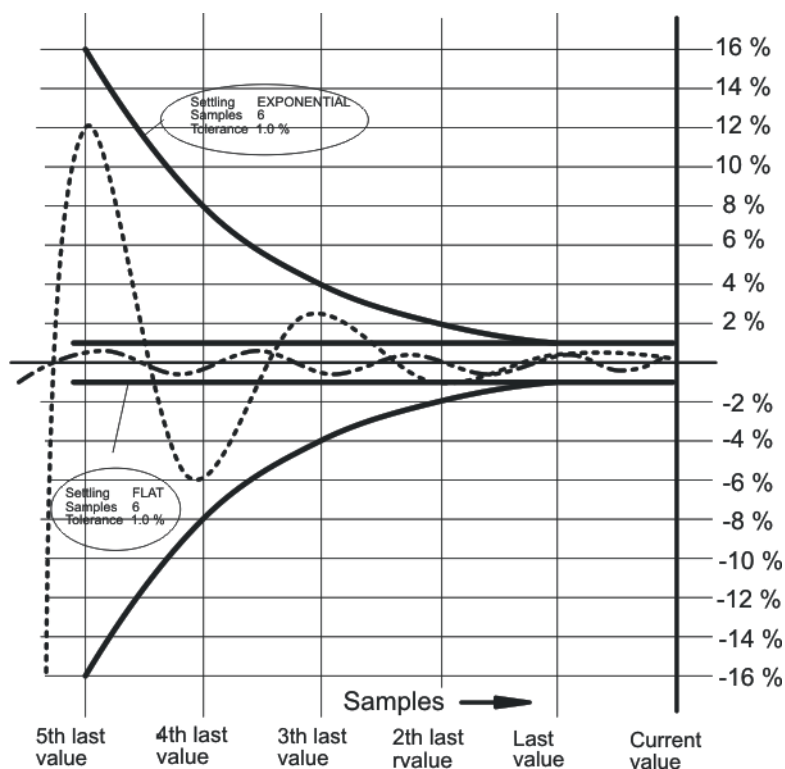
5.42.2 Settling Algorithms

The R&S UPV offers two different settling algorithms. As a feature common to both algorithms, each current measured value is compared with up to five of the immediately preceding measured values and is accepted as valid only if the differences between the current value and the preceding values are within specified tolerances.

In addition, an averaging function is available in order to reduce measured-value variations.

"Flat Settling" employs a tolerance mask with a completely flat characteristic (tolerance "band"). The "capture range" of this mask is determined by fixed tolerance limits. In the case of very small tolerance values, this algorithm yields a measurement result only after the DUT settles almost completely.

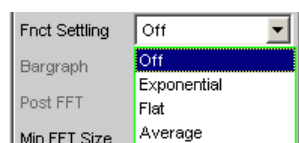
"Exponential Settling" uses a tolerance mask with an exponential characteristic (tolerance "funnel") whose "capture range" enlarges toward the earlier measured values, i.e. larger deviations are tolerated for the earlier values. This algorithm is suitable for level and distortion measurements, where most DUTs likewise exhibit an exponential settling characteristic.



5.42.3 Settling for Measurement Functions

Funct Settling

Used to activate the settling measurement for results of measurement functions and to select the settling method.



Results of measurement functions are not valid until the selected settling condition is fulfilled.

With the S/N measurement function and with level measurement functions in the S/N mode, the instrument determines the settling times separately for the useful signal plus noise and for the noise signal only. This yields two level values, of which the signal-to-noise quotient is formed.

Function Settling is available for most level measurement functions (except rub & buzz) and for distortion measurements.

The following applies to settling measurements, irrespective of the selected unit:

- With level measurements, the settling measurement is based on the results in volts (analog) or FS (digital).
- With distortion measurements, the settling measurement is based on the results in %.

Note: For the FFT measurement function, averaging of FFT data is available instead of a settling measurement, which is possible for measured values only (see section "Avg Mode" on page 536).

"Off"	<p>Function Settling is switched off. The measurement time is very short, since only a single measurement is performed.</p> <p>This setting is recommended if the DUT settling time</p> <ul style="list-style-type: none"> • can be ignored. • is known and taken into account by entering a fixed delay.
"Exponential"	<p>Function Settling is switched on and the exponential method is employed. Since several measurements have to be performed, the measurement time is considerably longer than if Function Settling is switched off.</p> <p>This setting is recommended if the DUT settling time cannot be taken into account by entering a fixed delay because</p> <ul style="list-style-type: none"> • it is not known. • it is not constant.
"Flat"	<p>Function Settling is switched on and the flat method is employed. All measurement samples should occur within a tolerance band of uniform width. This method, therefore, usually requires a higher number of measurements than the (softer) exponential method.</p> <p>This setting is recommended if it must be ensured that the results of several successive measurements are settled.</p>
"Average"	<p>The arithmetic average of a selectable number of successive results (obtained with a measurement function) is formed.</p> <p>This setting is recommended in order to compensate for measured-value variations. Where possible, the DUT settling time should additionally be taken into account by entering a corresponding delay under "Start Condition".</p>

Remote command:

[SENSe<n1>:FUNction:SETTling:MODE](#) on page 956

Samples

Designates the number of measured values to be covered by the settling algorithm, i.e. it defines how many measured values are to be used in the settling measurement or for averaging.



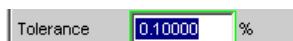
Note: In this exceptional case, the term "sample" is used to designate an internal measurement result instead of a digital sample.

Remote command:

[SENSe<n1>:FUNction:SETTling:COUNT](#) on page 956

Tolerance

The tolerance value designates the maximum permissible value by which the current measured value may differ from the preceding measured values so that it is still classified as settled.

A screenshot of a control panel with a label 'Tolerance' on the left and a numeric input field on the right. The input field contains the value '0.10000' followed by a '%' symbol. The input field has a green border and a blue highlight.

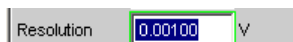
With exponential settling, the selected tolerance value applies only to the difference between the current and the last preceding measured value; for each earlier measured value, the tolerance value increases by a factor of 2.

Remote command:

[SENSe<n1>:FUNction:SETTling:TOLerance](#) on page 956

Resolution

The resolution value designates the maximum permissible absolute value by which the current measured value may differ from the preceding measured values in order to be accepted as settled, although the tolerance condition may be violated. This means that a measured value is regarded as not settled only if it fails to meet both the tolerance and the resolution condition.

A screenshot of a control panel with a label 'Resolution' on the left and a numeric input field on the right. The input field contains the value '0.00100' followed by a 'V' symbol. The input field has a green border and a blue highlight.


With exponential settling, the selected resolution value applies only to the difference between the current and the last preceding measured value; for each earlier measured value, the resolution increases by a factor of 2.

Remote command:

[SENSe<n1>:FUNction:SETTling:RESolution](#) on page 956

Timeout

Defines the maximum time that a settling algorithm is allowed to detect a settled result after the start of a measurement.

A screenshot of a control panel with a label 'Timeout' on the left and a numeric input field on the right. The input field contains the value '5.00000' followed by an 's' symbol. The input field has a green border and a blue highlight.

If no stable measured value is detected during this time, the measurement is aborted. An invalid measured value is output in the numeric display, the sweep and also via the remote line.

Defining a timeout is important especially with the "true" settling methods, because, with these methods, a settled value may never be detected if tolerance limits are too narrow. If averaging is employed, on the other hand, the number of measurements, and thus the measurement time, are finite and the timeout may be deactivated, as it were (by entering the maximum value of 2000 s).

Note: If a multichannel analyzer is used, max. 1.44 million samples can be monitored. In these analyzers, the maximum timeout is therefore dependent on the sampling rate and the analog bandwidth; at 40 kHz analog bandwidth, for example, it is 15 s.

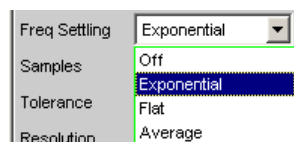
Remote command:

[SENSe<n1>:FUNction:SETTling:TOUT](#) on page 957

5.42.4 Settling for Frequency Measurements

Freq Settling

Used to activate the settling function for frequency measurements and to select the settling method (not for multichannel analyzers).



Results of frequency measurements are valid only if the selected settling condition is fulfilled.

The settling measurement is always based on Hz irrespective of the selected unit.

Note: The settling function is not performed for the sampling rate (digital analyzers). Even if "Sample Freq" is selected as the frequency measurement, the settling function is performed for the signal frequency.

"Off" Frequency Settling is switched off. There is no extension of the overall measurement time since only one measurement is performed.

This setting is recommended if the signal delay in the "DUT "

- can be ignored.
- is known and taken into account by entering a fixed delay.

"Exponential" Frequency Settling is switched on and the exponential method is employed. Since this method requires several measurements to be performed, the overall measurement time is longer than if the settling function is switched off.

Frequency settling of a DUT does not follow an exponential characteristic, but rather, in the event of a frequency change, there is usually a maximum of only one invalid intermediate value. Therefore this settling mode is usually impractical. It is more advisable to use the flat algorithm and a reduced number of samples.

"Flat" Frequency Settling is switched on and the flat method is employed. This setting is recommended if it must be ensured that the results of several successive measurements are settled.

"Average" The arithmetic average of a selectable number of successive measured frequency values is formed.

This setting is recommended in order to compensate for measured-value variations. Where possible, the DUT signal delay should additionally be taken into account by entering a corresponding delay under "Start Condition".

Remote command:

`SENSe<n1>:FUNCtion:SETTling:MODE` on page 956

Samples

This value designates the number of measured values collected by the settling algorithm, i.e. it indicates how many measured frequency values are to be used for the settling or averaging.



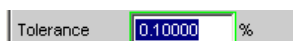
Note: In this exceptional case, the term "sample" is used to designate an internal measurement result instead of a digital sample.

Remote command:

[SENSe<n1>:FREQuency:SETTling:COUNT](#) on page 956

Tolerance

The tolerance value designates the maximum permissible value by which the current measured value may differ from the preceding measured values so that it is still classified as settled.



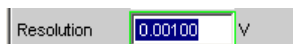
With exponential settling, the selected tolerance value applies only to the difference between the current and the last preceding measured value; for each earlier measured value, the tolerance value increases by a factor of 2.

Remote command:

[SENSe<n1>:FREQuency:SETTling:TOLerance](#) on page 956

Resolution

The resolution value designates the maximum permissible absolute value by which the current measured value may differ from the preceding measured values in order to be accepted as settled, although the tolerance condition may be violated. This means that a measured value is regarded as not settled only if it fails to meet both the tolerance and the resolution condition.



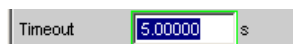
With exponential settling, the selected resolution value applies only to the difference between the current and the last preceding measured value; for each earlier measured value, the resolution increases by a factor of 2.

Remote command:

[SENSe<n1>:FREQuency:SETTling:RESolution](#) on page 956

Timeout

Defines the maximum time that a settling algorithm is allowed to detect a settled result after the start of a measurement.



If no stable measured value is detected during this time, the measurement is aborted. An invalid measured value is output in the numeric display, the sweep and also via the remote line.

Defining a timeout is important especially with the "true" settling methods, because, with these methods, a settled value may never be detected if tolerance limits are too narrow. If averaging is employed, on the other hand, the number of measurements, and thus the measurement time, are finite and the timeout may be deactivated, as it were (by entering the maximum value of 2000 s).

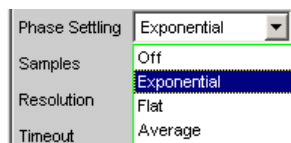
Remote command:

`SENSe<n1>:FREQuency:SETTling:TOUT` on page 957

5.42.5 Settling for Phase Measurements

Phase Settling

Used to activate the settling function for phase measurements and to select the settling method (not for multichannel analyzers).



Results of phase measurements are valid only if the selected settling condition is fulfilled.

The settling measurement is always based on ° irrespective of the selected unit.

- | | |
|---------------|--|
| "Off" | Phase Settling is switched off. There is no extension of the overall measurement time since only one measurement is performed.

This setting is recommended if the signal delay in the DUT <ul style="list-style-type: none"> • can be ignored. • is known and taken into account by entering a fixed delay. |
| "Exponential" | Phase Settling is switched on and the exponential method is employed. Since this method requires several measurements to be performed, the overall measurement time is longer than if the settling function is switched off.

Phase settling of a DUT does not follow an exponential characteristic, but rather, in the event of a frequency change, there is usually a maximum of only one invalid intermediate value. Therefore this settling mode is usually impractical. It is more advisable to use the flat algorithm and a reduced number of samples. |
| "Flat" | Phase Settling is switched on and the flat method is employed.

This setting is recommended if it must be ensured that the results of several successive measurements are settled. |

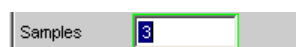
"Average" The arithmetic average of a selectable number of successive phase results is formed.
This setting is recommended in order to compensate for measured-value variations. Where possible, the DUT signal delay should additionally be taken into account by entering a corresponding delay under "Start Condition".

Remote command:

[SENSe<n1>:PHASe:SETTling:MODE](#) on page 956

Samples

Designates the number of measured values to be covered by the settling algorithm, i.e. it defines how many measured phase values are to be used in the settling measurement or for averaging.



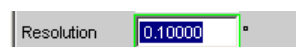
Note: In this exceptional case, the term "sample" is used to designate an internal measurement result instead of a digital sample.

Remote command:

[SENSe<n1>:PHASe:SETTling:COUNT](#) on page 956

Resolution

The resolution value designates the maximum permissible absolute value by which the current measured value may differ from the preceding measured values.



For phase measurements, specifying the resolution value is meaningful only. This is the absolute value by which the current measured phase value may differ – in ° – from the preceding measured phase values. Specifying a tolerance value for phase results would not be meaningful, since minimal phase variations in the order of around 0° would result in major relative tolerance variations, which would mean a constant violation of the tolerance condition.

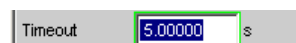
With exponential settling, the selected resolution value applies only to the difference between the current and the last preceding measured value; for each earlier measured value, the resolution increases by a factor of 2.

Remote command:

[SENSe<n1>:PHASe:SETTling:RESolution](#) on page 956

Timeout

Defines the maximum time that a settling algorithm is allowed to detect a settled result after the start of a measurement.



If no stable measured value is detected during this time, the measurement is aborted. An invalid measured value is output in the numeric display, the sweep and also via the remote line.

Defining a timeout is important especially with the "true" settling methods, because, with these methods, a settled value may never be detected if tolerance limits are too narrow. If averaging is employed, on the other hand, the number of measurements, and thus the measurement time, are finite and the timeout may be deactivated, as it were (by entering the maximum value of 2000 s).

Remote command:

`SENSe<n1>:PHASe:SETTling:TOUT` on page 957

5.42.6 Settling for Start Conditions (Event-Triggered Measurements)

The settling procedure can also be applied to all event-triggered measurements – i.e. measurements that are measured-value-triggered rather than time-triggered.

With external sweeps, the sample signal never changes simultaneously with the start of the frequency or level measurements that monitor the sample signal for changes. In the event of a value change, therefore, the monitoring routine usually does not measure the new frequency or level value but an intermediate value, i.e. a value between the old and the new value. If the trigger threshold (variation) is smaller than the actual value change, it may happen that even the measured intermediate value triggers the next measurement in a sweep. This does not produce a falsified measured value (Y value of the sweep display) since the next measurement is not started until the signal change is detected. However, the sweep parameter (X value of the sweep display) that triggers the next measurement is too close to the preceding X value.

To ensure that the X values of an external sweep are also measured with great accuracy, the settling procedure should be applied to external sweeps as well.

Due to a frequency change, some DUTs take a long time until the level has settled (e.g. hearing aids with a sound level limiter or compander/expander circuits with short level rise times and long decay times). With such DUTs, therefore, it is not sufficient to apply the settling procedure to the trigger routine only. In addition, then, a start delay or Function Settling should be activated.



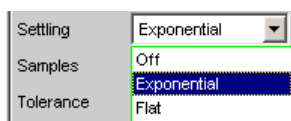
Timeout monitoring is not meaningful in settling procedures applied to event triggers (i.e. not time triggers), since it takes an indefinite period of time until the external event triggering a measurement occurs, and an early abortion of the monitoring routine would be of no avail.



If a multichannel analyzer is used, max. 1.44 million samples can be monitored. In these analyzers, the maximum time for detecting (and settling to) the external trigger condition is therefore dependent on the sampling rate and the analog bandwidth; at 40 kHz analog bandwidth, for example, it is 15 s.

Settling

Used to activate the settling measurement for the frequency/level monitoring routine in the case of external sweeps and external level/edge triggering, and to select the "settling" method.



Results of trigger signal measurements are valid only if the selected "settling" condition is fulfilled.

The following applies to settling measurements, irrespective of the selected unit:

- With external level sweeps and external level/edge triggering, the settling measurement is based on the results of the trigger signal measurement in volts (analog) or FS (digital).
- With external frequency sweeps, the settling measurement is based on the results of the trigger signal measurement in Hz.

Note: Averaging the results of trigger signal measurements would not provide conclusive information and is therefore not implemented.

"Off"	The frequency/level monitoring routine is performed without the settling function. This setting offers the shortest possible response time to a detected signal change. It is not sure, however, whether the nominal trigger value (X value of the sweep display) is actually attained.
"Exponential"	The settling function is switched on for the frequency/level monitoring routine, and the exponential method is employed. Since several measurements have to be performed, the response time to the detected signal change becomes longer. This setting is recommended for external level sweeps and external level/edge triggering since most DUTs exhibit an exponential level settling characteristic.
"Flat"	The settling function is switched on for the frequency/level monitoring routine, and the flat method is employed. Since several measurements have to be performed, the response time to the detected signal change becomes longer. This setting is recommended for external frequency sweeps if the actual trigger value (X value of the sweep display) is to be determined very accurately. In the event of a frequency change, the DUT will usually yield a maximum of only one invalid intermediate frequency value. Therefore it is sufficient to set the number of samples to a value of "2", so that only two or three measurements of the trigger signal are performed.

Remote command:

[SENSe<n1>:TRIGger:SETTling:MODE](#) on page 956

Samples

Designates the number of measured values to be covered by the settling algorithm, i.e. it defines how many frequency or measured level values are to be used for settling.



With "n" samples set, the following number of trigger-value measurements are to be expected:

- With frequency triggering and flat settling: n or n+1
- With level triggering and exponential settling: > n

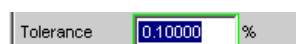
Note: In this exceptional case, the term "sample" is used to designate an internal measurement result instead of a digital sample.

Remote command:

[SENSe<n1>:TRIGger:SETTling:COUNT](#) on page 956

Tolerance

The tolerance value designates the maximum permissible value by which the current trigger value may differ from the preceding trigger values so that it is still classified as settled.



With exponential settling, the selected tolerance value applies only to the difference between the current and the last preceding trigger value; for each earlier trigger value, the tolerance value increases by a factor of 2.

Remote command:

[SENSe<n1>:TRIGger:SETTling:TOLerance](#) on page 956

Resolution

The "Resolution" value designates the maximum permissible absolute value by which the current trigger value may differ from the preceding trigger values in order to be accepted as settled, although the tolerance condition may be violated. This means that a trigger value is regarded as not settled only if it fails to meet both the tolerance and the resolution condition.

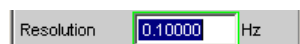


Fig. 5-31: (for external frequency sweeps)



Fig. 5-32: (for external digital level sweeps)

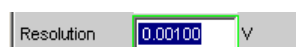


Fig. 5-33: (for external analog level sweeps)

With exponential settling, the selected resolution value applies only to the difference between the current and the last preceding trigger value; for each earlier measured value, the resolution increases by a factor of 2.

Remote command:

[SENSe<n1>:TRIGger:SETTling:RESolution](#) on page 956

5.42.7 Examples of Settling

The examples below are based on the following settings:

Settling	Exponential	
Samples	6	
Tolerance	1.00000	%
Resolution	0.00100	V

With the above settings, the current measured value may deviate:

- from the last measured value by a max. of +/- 1% (or +/- 0.086 dB),
- from the 2nd-last measured value by a max. of +/- 2 % (or +/- 0.172 dB),
- from the 3rd-last measured value by a max. of +/- 4 % (or +/- 0.340 dB),
- from the 4th-last measured value by a max. of +/- 8 % (or +/- 0.668 dB),
- from the 5th-last measured value by a max. of +/- 16% (or +/- 1.289 dB)

For an analog level measurement with a result of 1 V this means that

- the last measured value must be between 0.99 and 1.01 V.
- the 2nd last measured value must be between 0.98 and 1.02 V.
- the 3rd last measured value must be between 0.96 and 1.04 V.
- the 4th last measured value must be between 0.92 and 1.08 V.
- the 5th last measured value must be between 0.84 and 1.16 V

For a distortion measurement with a result of 0.01% this means that

- the last measured value must be between 0.0099 and 0.0101%
- the 2nd-last measured value must be between 0.0098 and 0.0102%
- the 3rd-last measured value must be between 0.0096 and 0.0104%
- the 4th-last measured value must be between 0.0092 and 0.0108%
- the 5th-last measured value must be between 0.0084 and 0.0116%

in settled state.

5.43 Filter

This section describes the describes the settling options for the filter, see [chapter 5.44, "User-Definable Filters"](#), on page 628, and [chapter 5.45, "Weighting Filters"](#), on page 637.

The user-definable filters are configured in the Filter panel. They can then be used in the analyzer as prefilters and function filters and also in the generator.

The weighting filters and the fixed highpass and lowpass filters are not selected in the Filter panel. They are selected together with the user-configurable filters in the selection fields of the analyzer and generator.

Here, there is an overview of the filters which can be set up in the analyzer and generator, together with the remote-control parameters, see [chapter 5.43.4, "Filter Table"](#), on page 628.

5.43.1 Analyzer Prefilter

A filter which influences all measurement functions can be selected in the Analyzer Config panel. One of the user-definable filters in the Filter Panel or a weighting filter can be selected. This means that prefiltering is possible without having to select the required filter for every single measurement function.

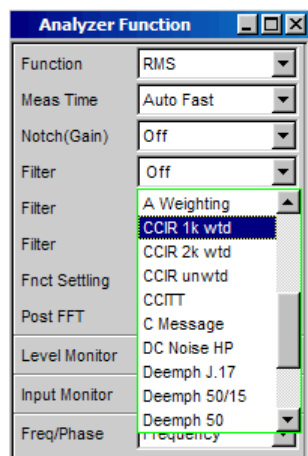


SCPI command:

[INPut:FILTer CMES, page 958](#)

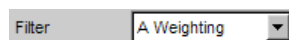
5.43.2 Analyzer Function Filters

In the Analyzer Function panel, up to 3 of the user-definable filters in the Filter panel or weighting filters can be looped into the measurement path regardless of which level measurement method is selected.



5.43.3 Generator Filters

Most of the generator signals can be filtered in the time domain. A user-defined filter, a weighting filter, or a highpass or lowpass filter can be selected in the Function panel.



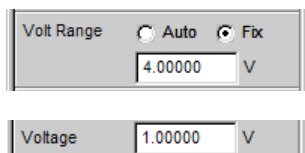
Remote-control command: [SOURce:FILTer](#) on page 960

If a filter with gain is used (such as the "CCIR 1k wtd" weighting filter), the generator signal level must be selected as described below in such a way that overranging cannot occur with the maximum filter gain.

Analog generator:

In the Generator Config panel, set "Voltage Range" to "Fix", and in the Generator Function, panel set the level low enough to ensure that the amplified level will always be less than the selected fixed voltage range.

Example:



Here the maximum allowable gain of the filter is 4 (12 dB).

Digital generator:

Select a level that is low enough to ensure that the level plus the maximum gain of the filter will always be less than the full-scale level.

With both types of generator (analog and digital), any DC offset that has been configured must be taken into account when setting the level.

5.43.4 Filter Table

The overview of the filters which can be set up in the analyzer and generator, together with the remote-control parameters, is located under the description of the commands, see [INPut<n1>:FILTer](#) on page 958.

5.44 User-Definable Filters

In the Filter panel, 9 filters (defined as Filter 01 to Filter 09) can be defined individually as lowpass filters, highpass filters, bandpass filters, bandstop filters, notch filters, third-octave filters or octave filters.

These filters are implemented as recursive, elliptical eighth-order digital filters (exception: fourth order is also possible for lowpass and highpass filters). All filters are calculated by means of frequency transformation from a database with standardized reference lowpass filters. The ripple in the passband is 0.1 dB; stopband attenuation is available in steps of approx. 10 dB.

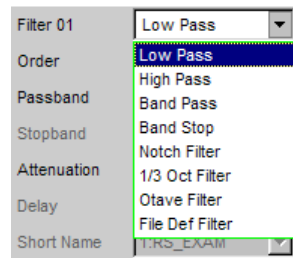
The user only has to enter the passband and the minimum stopband attenuation. The frequencies of the stopband are calculated and displayed taking the required stopband attenuation into consideration. The implemented stopband attenuation is always equal to or greater than the specified value.

Apart from the parameters entered in the Filter panel, the sampling rate must also be known to allow calculation of the filter. The other parameters (stop frequency, delay and the attenuation actually implemented) can therefore only be calculated and displayed after the filter has been activated in the analyzer or generator.

5.44.1 Filters 01 to 09

Selection of the filter type for the filters 1 to 9.

Filters 01 to 09



Remote command:

[SENSe<n1>:UFILter<n2>](#) on page 958

5.44.2 Lowpass Filter and Highpass Filter

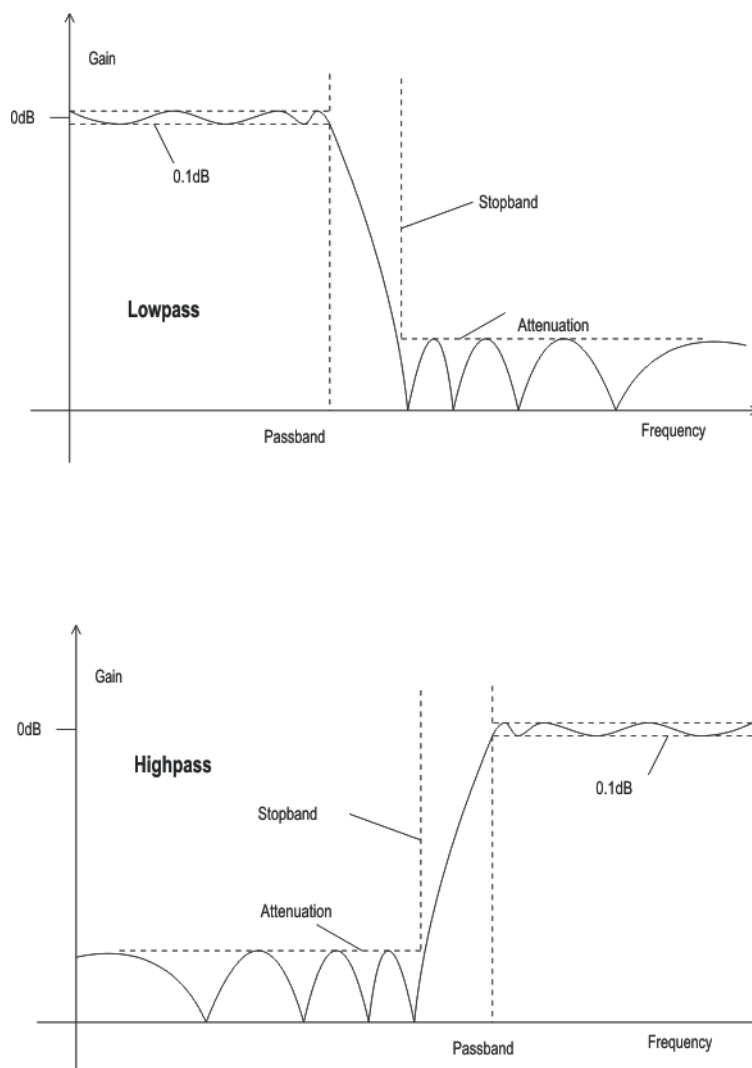


Fig. 5-34: Lowpass and highpass frequency response with filter parameters

Order

Used to specify the filter order. Only available for lowpass and highpass filters. Low-order filters have edges with a lower rate of rise, but settle more quickly.

"4" 4th Order Filter

"8" 8th Order Filter

Remote command:

[SENSe<n1>:UFILter<n2>:ORDer](#) on page 959

Passband

Used to specify the corner frequency (-0.1 dB) of the passband in lowpass and highpass filters

Remote command:

[SENSe<n1>:UFILter<n2>:PASSb](#) on page 959

Stopband

Displays the cutoff frequency of the stopband in the case of lowpass and highpass filters; the cutoff frequency is derived from the selected passband and the stopband attenuation. This value is only updated after the filter is activated.

Remote command:

[SENSe<n1>:UFILter<n2>:STOPb](#) on page 960

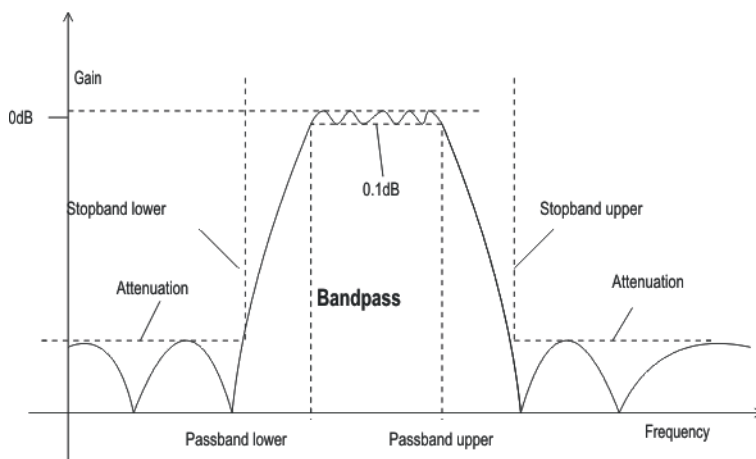
5.44.3 Bandpass Filters and Bandstop Filters

Fig. 5-35: Bandpass frequency response with filter parameters

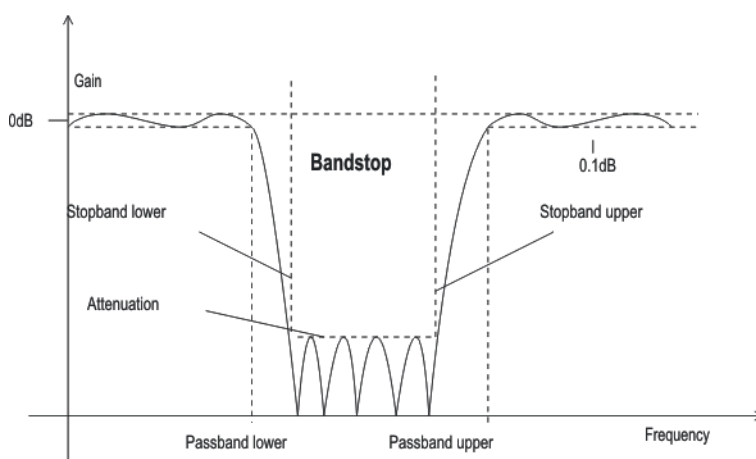


Fig. 5-36: Bandstop frequency response with filter parameters

Passb Low

Used to specify the lower corner frequency (- 0.1 dB) of the passband for bandpass or bandstop filters.

Remote command:

[SENSe<n1>:UFILter<n2>:PASSb:LOWer](#) on page 959

Passb Upp

Used to specify the lower corner frequency (- 0.1 dB) of the passband for bandpass or bandstop filters.

Remote command:

[SENSe<n1>:UFILter<n2>:PASSb:UPPer](#) on page 960

Stopb Low

Displays the lower cutoff frequency of the stopband in the case of bandpass and band-stop filters; the cutoff frequency is derived from the selected passband and the stop-band attenuation. This value is only updated after the filter is activated.

Remote command:

[SENSe<n1>:UFILter<n2>:STOPb:LOWer](#) on page 960

Stopb Upp

Displays the upper cutoff frequency of the stopband in the case of bandpass and band-stop filters; the cutoff frequency is derived from the selected passband and the stop-band attenuation. This value is only updated after the filter is activated.

Remote command:

[SENSe<n1>:UFILter<n2>:STOPb:UPPer](#) on page 960

5.44.4 Notch Filter, Third-Octave Filter and Octave Filter

Third-octave and octave filters are bandpass filters whose passband is geometrically symmetrical to the center frequency, whereby the passband frequencies are derived from the center frequency as follows:

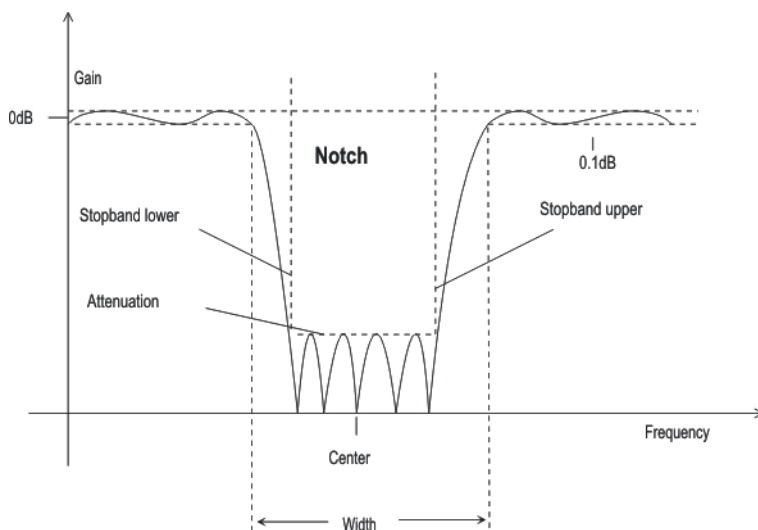


Fig. 5-37: Notch filter frequency response with designation of the filter parameters

Third-octave filter:	Passband low = $CenterFreq / \sqrt[6]{2}$
	Passband upp = $CenterFreq \times \sqrt[6]{2}$
	Bandwidth = $\sqrt[6]{2} - (1/\sqrt[6]{2}) = 0.2315 = 23.15\%$
Octave filter:	Passband low = $CenterFreq / \sqrt{2}$
	Passband upp = $CenterFreq \times \sqrt{2}$
	Bandwidth = $\sqrt{2} - (1/\sqrt{2}) = 0.7071 = 70.71\%$



With the third-octave and octave filters, the 0.1 dB bandwidth is reduced until an attenuation of approx. 3 dB is obtained for the cutoff frequencies. The displayed numeric value for "Width" is therefore less than the 3 dB bandwidth of the third-octave and octave filter.

Center Freq

Used to specify the center frequency. The notch filter has a transmission zero at the center frequency; the attenuation at this frequency is considerably greater than the specified stopband attenuation.

Remote command:

`SENSe<n1>:UFILter<n2>:CENTer` on page 959

Width

For notch filter: used to specify the difference between the upper and lower cutoff frequency (- 0.1 dB) of the passband.

For third-octave and octave filter: displays the width of the passband.

Remote command:

`SENSe<n1>:UFILter<n2>:WIDTh` on page 960

Stopb Low

Displays the lower cutoff frequency of the stopband; the cutoff frequency is derived from the selected passband and the stopband attenuation (only for the notch filter). This value is only updated after the filter is activated.

Remote command:

`SENSe<n1>:UFILter<n2>:STOPb:LOWer` on page 960

Stopb Upp

Displays the upper cutoff frequency of the stopband; the cutoff frequency is derived from the selected passband and the stopband attenuation (only for the notch filter). This value is only updated after the filter is activated.

Remote command:

`SENSe<n1>:UFILter<n2>:STOPb:UPPer` on page 960

5.44.5 File-Defined Filter

If the filters installed on the instrument do not satisfy the requirements of the application concerned, it is possible to read in a filter from a file. Two file formats are supported in which the filter is described either by the coefficients of the transfer function (*.coe) or by the poles and zeros (*.zpz or *.npz and *.xpz) in the z level.

5.44.5.1 File Def Filter**File Def Filter**

Filter 01	File Def Filter
Filename	C:\UPV\Conf... <input type="button" value="..."/>
Delay	41.6667 <input type="text"/> <input type="text" value="µs"/>
Short Name	1:RS_EXAM

A file can be loaded in which the filter is described either by the coefficients of the transfer function (*.coe) or by the poles and zeros (*.zpz or *.npz and *.xpz) in the z level.

The button opens a browser that can be used to select the filter file.

Remote command:

`SENSe<n1>:UFILter<n2>:FNAMe` on page 959

5.44.5.2 Coefficients of the transfer function

The filter in the file must be an IIR filter with four pairs of poles and zeros in the form of four consecutive biquads.

The transfer function $S(z)$ is then derived as follows:

$$S(z) = \text{gain} \cdot \frac{\prod_{i=0}^3 (z^2 + z \cdot b1i + b2i)}{\prod_{i=0}^3 (z^2 - z \cdot a1i - a2i)}$$

Example:

See `RS_EXAM.COE` in `D:\UPV\USER`



The coefficient file `*.COE` is only valid for the sampling rate determined during the design stage, i.e. the frequency response of the filter is standardized to this sampling rate. If a different sampling rate is set in the R&S UPV, the frequency response changes accordingly.

5.44.5.3 Poles and zeros of the transfer function

The filter is defined by specifying the poles and zeros on the Z level. Four pairs of poles and zeros are permitted. Unused poles and zeros must be placed at the origin of the Z level.

The transfer function $S(z)$ is then derived as follows:

$$S(z) = \text{gain} \cdot \frac{\prod_{i=0}^3 (Z - Zoi)(Z - Zoi^*)}{\prod_{i=0}^3 (Z - Zpi)(Z - Zpi^*)}$$

where: $z0$ = zeros, zp = poles, z^* = conjugate complex number. (5 - 5)

File format *.zpz

Example:

See `RS_EXAM.ZPZ` in `D:\UPV\USER`



The `*.ZPZ` poles/zeros file is only valid for the sampling rate determined during the design stage, i.e. the frequency response of the filter is standardized to this sampling rate. If a different sampling rate is set in the R&S UPV, the frequency response changes accordingly.

File format *.npz

Example:

See the `RS_EXAM.NPZ` file in the `D:\UPV\USER` directory



Poles and zeros in the *.NPZ are standardized to the sampling frequency specified there. If a different sampling rate is set in the R&S UPV poles and zeros are converted to this rate so that the frequency response of the filter remains unchanged. A reference point for the frequency response, defined in terms of a reference frequency and the reference gain at this frequency, must be specified in the file.

File format *.xpz

This file format is an extension of the "npz" format. The file can contain multiple parameter sets for the pole and zero locations. For each parameter set, the associated sampling frequency must be specified, along with the sampling frequency range within which the pole and zero locations can be transformed such that the frequency response of the filter remains within the specified tolerance. This file format allows filters with tight tolerances to be used over a wide range of sampling frequencies.



Poles and zeros in the *.XPZ file are normalized to the sampling frequencies specified for the individual parameter sets. If a different sampling rate is configured in the R&S UPV, the pole and zero locations in the allowable frequency range are transformed to correspond to the actual sampling frequency so the frequency response of the filter remains unchanged. A reference point for the frequency response, defined in terms of a reference frequency and the reference gain at this frequency, must be specified in the file.

5.44.6 Parameters Common to All Filters

Attenuation

Used to specify the desired filter attenuation of the stopband in dB. When the filter is activated, the attenuation actually implemented must be entered here (this attenuation is normally greater than the entered value). Filter attenuation in steps of approx. 10 dB is possible.

Remote command:

`SENSe<n1>:UFILter<n2>:ATTenuation` on page 959

Delay

Displays the estimated settling time of the filter. This value is only updated after the filter is activated.

Exception: With file-defined filters, a settling time is calculated and displayed after the coefficients are read in. This settling time can then be changed manually.

Remote command:

`SENSe<n1>:UFILter<n2>:DELAy` on page 959

Short Name

Displays a short name under which the filter can be called up in the analyzer or generator. The short name consists of the filter type code (2 letters) and the frequency. (LP = lowpass filter, HP = highpass filter, BP = bandpass filter, BS = bandstop filter, TZ = third-octave filter, OC = octave filter, NO = notch filter).

The name of the file is shown here in the case of file-defined filters.

5.44.7 Filter Settling Time

The settling time of the filter can be estimated from the filter parameters. Certain filters (e.g. filters with steep edges and narrowband bandpass filters) have longer settling times.

When measurement is started (e.g. by making new settings, pressing the start key or in the case of a sweep), the R&S UPV waits until this settling time expires for every filter before performing the actual signal integration. If (in exceptional cases) the calculated time is too short, the filters cannot settle properly before the measurement is started. This can result in unstable measured values.

The following trick can be used to remedy this problem:

If the `DELAY.COE` file-defined filter (in the `D:\UPV\USER` directory) is selected, a settling time can be entered there, which is added to the settling time of the other filters when measurement is performed. The `DELAY.COE` filter has no other function.



If a multichannel analyzer is used, the total settling time of all activated analyzer filters is limited to 150 000 samples (at 40 kHz analog bandwidth, this corresponds to a settling time of approx. 1.5 s). If this is not long enough (e.g. if four very steep-edged filters are used), an additional delay may be entered under "Start Condition".

With continuous measurement, the filter settling time is added only with the (re)start of the first measurement. All further measurements in this case are performed without delay.



If a multichannel analyzer is used, the signal is not monitored continuously during continuous measurement; the filter settling time is therefore added with each subsequent measurement as well.

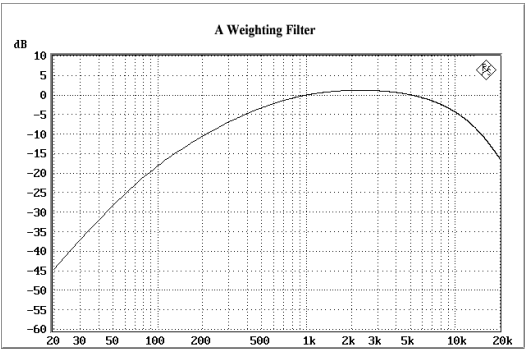
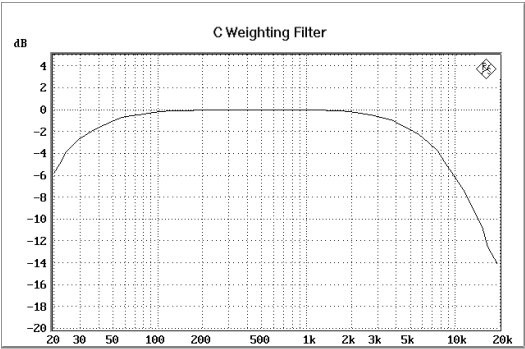
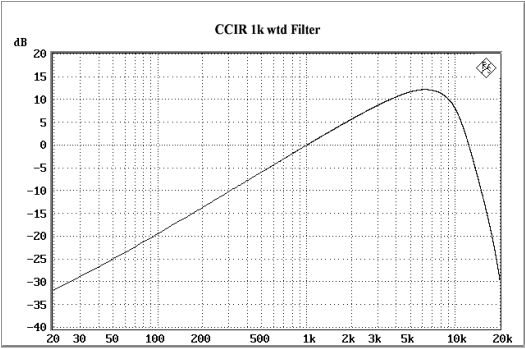
5.45 Weighting Filters

In addition to the user-definable filters, the R&S UPV also offers a large number of weighting filters which conform to the relevant standards.

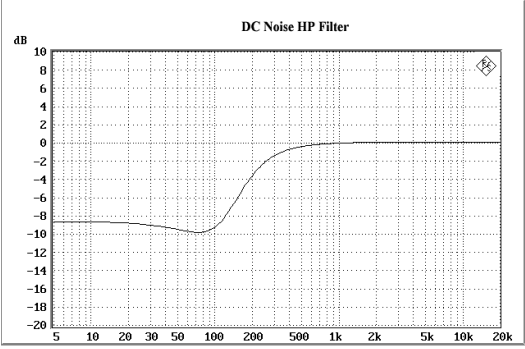
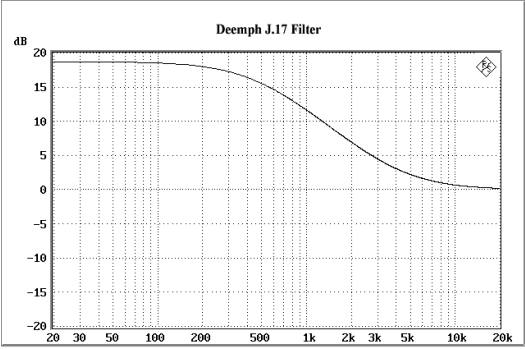
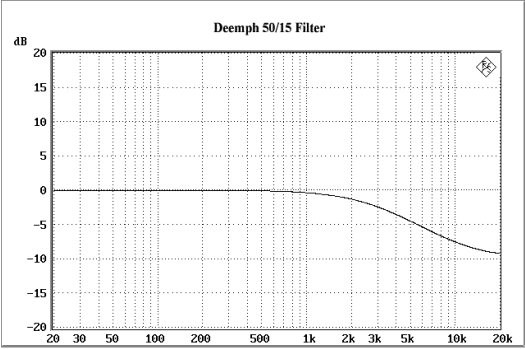
The weighting filters and the fixed highpass and lowpass filters are not selected in the Filter panel. They are selected together with the user-configurable filters in the selection fields of the analyzer and generator.

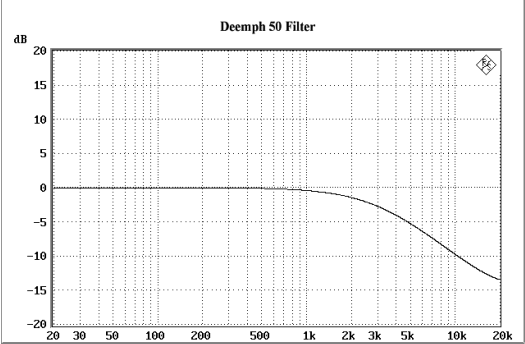
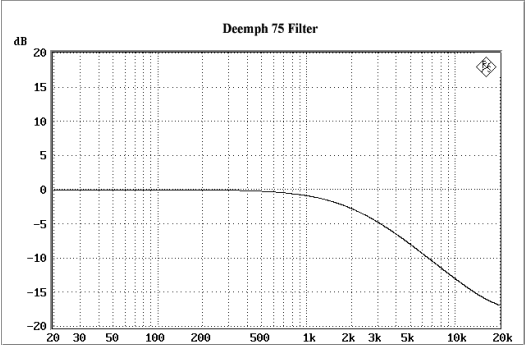
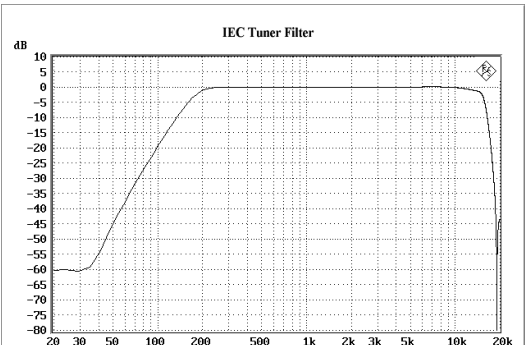
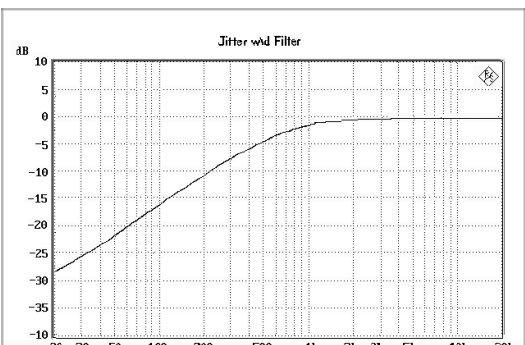
Remote-control command:

INPut<n1>:FILTer on page 958

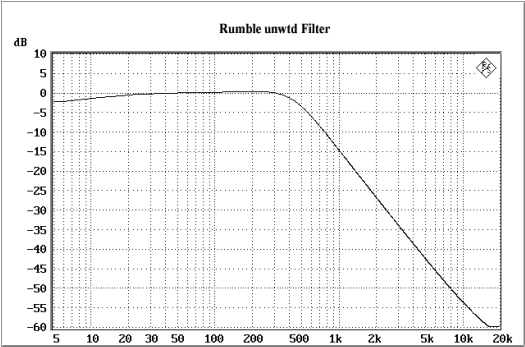
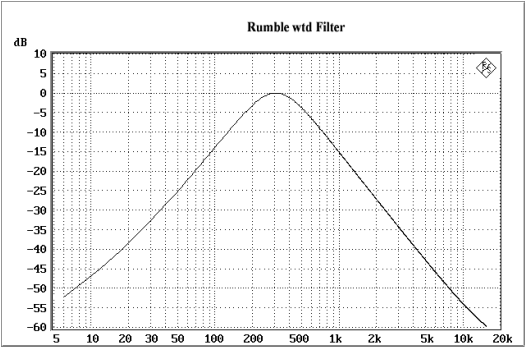
Filters:	A Weighting	
Standards:	DIN 45412, DIN 45633 IEC 179, IEC 651 ANSI S1.4	
Application:	Weighted noise measurement	
Filters:	C Weighting	
Standards:	IEC 179, IEC 651 ANSI S1.4	
Application:	Weighted noise measurement	
Filters:	CCIR 1k wtd	
Standards:	Standards: CCIR Rec. 468-4 DIN 45405 CCITT Rec. N21 CISPR 6-76 ITU-T J.16	
Application:	Weighted noise measurement	

Filters:	CCIR 2k wtd	
Standards:	Dolby	
Application:	NAB standard	
Filters:	CCIR unwtd	
Standards:	Standards: CCIR Rec. 468-4 ITU-T J.16	
Application:	Bandpass from 20 Hz to 20 kHz for band-limited unweighted measurement to CCIR	
Filters:	CCITT	
Standards:	Standards: ITU-T Rec. O. 41 CISPR 6-76 ITU-T Rec. P.53	
Application:	Psophometric weighting	
Filters:	C Message	
Standards:	IEEE 743-1995	
Application:	Weighted noise measurement	

Filters:	DC Noise HP	 <p>The graph shows the frequency response of the DC Noise HP Filter. The y-axis represents gain in dB, ranging from -20 to 10. The x-axis represents frequency in Hz on a logarithmic scale from 5 to 20k. The curve starts at approximately -10 dB at 5 Hz, remains relatively flat until about 100 Hz, then rises to cross 0 dB at approximately 500 Hz and continues to rise slightly towards 10 dB at 20k Hz.</p>
Standards:	Standard: ARD Spec. 3/4 ARD Spec. 12/2	
Application:	Highpass filter for measurement of DC noise (tape recorders)	
Filters:	Deemph J.17	 <p>The graph shows the frequency response of the Deemph J.17 Filter. The y-axis represents gain in dB, ranging from -20 to 20. The x-axis represents frequency in Hz on a logarithmic scale from 20 to 20k. The curve starts at approximately 18 dB at 20 Hz and decreases steadily, crossing 0 dB at approximately 10k Hz and reaching about -5 dB at 20k Hz.</p>
Standards:	ITU-T J.17	
Application:	Weighted noise measurement	
Filters:	Deemph 50/15	 <p>The graph shows the frequency response of the Deemph 50/15 Filter. The y-axis represents gain in dB, ranging from -20 to 20. The x-axis represents frequency in Hz on a logarithmic scale from 20 to 20k. The curve starts at 0 dB at 20 Hz, remains flat until about 1k Hz, then decreases to approximately -10 dB at 20k Hz.</p>
Standards:	CCIR Rec. 651	
Application:	Compact disc	

Filters:	Deemph 50	
Standards:	ARD Spec. 5/3.1	
Application:	Weighted noise measurement	
Filters:	Deemph 75	
Standards:	ARD Spec. 5/3.1	
Application:	Weighted noise measurement	
Filters:	IEC Tuner	
Standards:	DIN/IEC 60315-4	
Application:	Measurements on FM tuners	
Filters:	Jitter wtd	
Standards:	AES 3	
Application:	Application: Weighting of jitter transfer function 1st order HP -3 dB at 700 Hz -20 dB at 70 Hz	

Filters:	Preemph 50/15	<p>Preemph 50/15 Filter</p>
Standards:	CCIR Rec. 651	
Application:	Compact disc	
Filters:	Preemph 50	<p>Preemph 50 Filter</p>
Standards:	ARD Spec. 5/3.1	
Application:	Weighted noise measurement	
Filters:	Preemph 75	<p>Preemph 75 Filter</p>
Standards:	ARD Spec. 5/3.1	
Application:	Weighted noise measurement	

Filters:	Rumble unwtd	
Standards:	Standards: DIN 368.3 DIN 45539	
Application:	Unweighted noise measurement	
Filters:	Rumble wtd	
Standards:	DIN 45539	
Application:	Weighted noise measurement	

5.46 Highpass and Lowpass

In addition to the user-definable filters and the weighting filters, the R&S UPV also offers a selection of preset highpass and lowpass filters.

The weighting filters and the fixed highpass and lowpass filters are not selected in the Filter panel. They are selected together with the user-configurable filters in the selection fields of the analyzer and generator.

Remote-control command: `INPut<n1>:FILTer` on page 958

HighPass 22 Hz	Highpass (3rd-order Butterworth) with 3 dB cutoff frequency at 22.4 Hz
HighPass 400 Hz	Highpass (3rd-order Butterworth) with 3 dB cutoff frequency at 400 Hz
LowPass 22 kHz	Lowpass (4th-order Butterworth) with 3 dB cutoff frequency at 22.4 kHz
LowPass 30 kHz	Lowpass (3rd-order Butterworth) with 3 dB cutoff frequency at 30 kHz

LowPass 80 kHz	Lowpass (3rd-order Butterworth) with 3 dB cutoff frequency at 80 kHz
AES 17	20 kHz lowpass (8th-order elliptic) in accordance with the AES 17 standard. Passband: ripple max. +/- 0.1 dB up to 20 kHz Stopband: attenuation > 60 dB for 24 kHz and higher

5.47 Signal Monitoring

5.47.1 Auxiliaries Panel

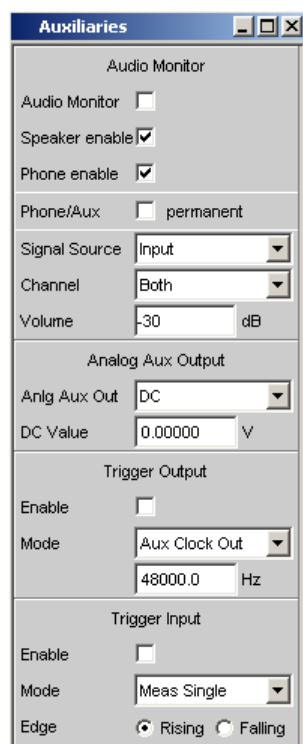


Fig. 5-38: Auxiliaries panel

Various functionalities are brought together in the Auxiliaries panel:

"Audio Monitor "

The Audio Monitor allows audio monitoring of many different sources within the R&S UPV. Applied and measured analog signals, external digital signals and also analog input signals which have been converted into digital signals and processed can all be monitored by ear.

"Analog Aux Output "

Optionally a DC voltage for powering e.g. hearing aids or channel 1 of the signal being monitored by ear can be output via the Analog Aux Output.

"Trigger Output "

Trigger Output delivers a clock signal or a pulse triggered by a measurement, depending on the "Mode" setting.

"Trigger Input "

Various measurements can be started or the internal trigger system can be tested via the Trigger Input.

You can monitor a signal by ear at many different points on the signal path with the aid of the "Audio Monitor" control panel in the Auxiliaries panel. The signal to be monitored can be an analog or digital signal, or an externally applied or internally generated signal.

To allow audio monitoring of digital signals, the Audio Monitor output has an audio-monitoring D/A converter which converts the digital signals into analog signals.

The audio monitoring signal is output from a loudspeaker integrated in the R&S UPV, at a 6.3 mm jack socket at the bottom right-hand side of the R&S UPV front panel, or at the BNC socket labeled "Anlg Aux Out" at the rear of the R&S UPV. The maximum output voltage can be up to 5 V in normal operation (without overranging), depending on the selected configuration.



Audio monitoring is not possible at sampling rates exceeding 200 kHz, nor generally if multichannel analyzers are used.

CAUTION

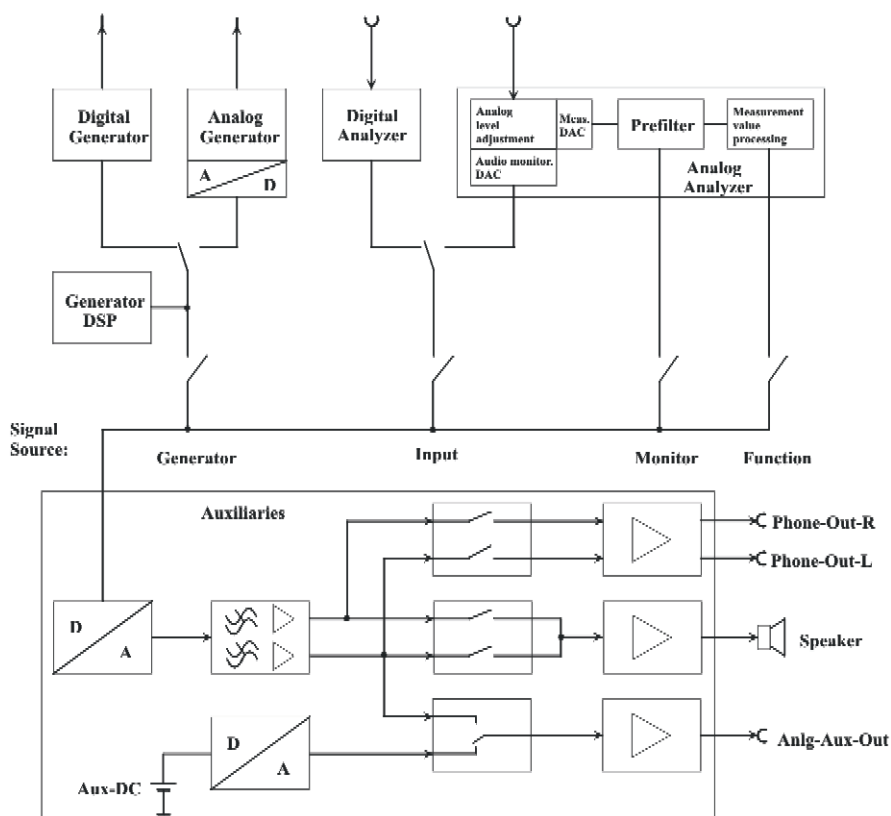
Possible hearing loss caused by very high sound pressure in the headphones

The output voltage of the built-in headphones amplifier is influenced by the incoming signal, by instrument settings such as the selected measurement range and test function, and by the set volume.

If the volume is set to maximum, the built-in headphones amplifier may generate high output voltages with an RMS value of up to 8 V in case of overranging. Depending on the headphones' sensitivity, this may produce very high sound pressure levels that may cause hearing damage.

To monitor varying input signals, therefore, it is advisable to reduce the volume and take off the headphones until the signal has settled.

The block diagram below shows the points along the signal processing path at which the signal is tapped and fed to the audio monitoring output:

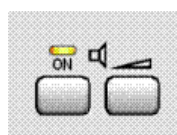


Audio Monitor

Activates/deactivates the audio monitoring function.



The monitoring signal is then output using the volume or voltage set at "Volume", and in the subsequent parameter fields you can select whether the internal loudspeaker, the headphone jack or both are to be used for playback.



The illustration above shows a section of the R&S UPV front-panel keypad. The internal loudspeaker can be operated directly via these keys. The left-hand key has a toggle function, i.e. the audio monitor is activated/deactivated alternately each time the key is pressed. The ON key on the front panel therefore equates to the "Audio Monitor" checkbox in the Auxillaries panel. Pressing the right-hand key opens the window used for setting the volume.

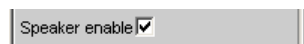
Remote command:

[AUXillaries:AUDMonitor](#) on page 962

Speaker enable

The internal loudspeaker plays back the signal selected at "Signal Source" with the volume that was set at "Volume", provided the monitoring option has been activated by selecting the "Audio Monitor" checkbox.

If the internal loudspeaker was disabled earlier and selected again, the Audio Monitor checkbox in the field above is also checked. At the same time the Speaker LED on the front panel begins to shine.



Remote command:

[AUXiliaries:SPEaker:STATe](#) on page 963

Phone enable

The signal selected at "Signal Source" is output with the volume that was set at "Volume" on the front phone jack, provided the monitoring option has been activated by selecting the "Audio Monitor" checkbox.

If the phone output was disabled earlier and selected again, the Audio Monitor checkbox in the field above is also checked. At the same time the Speaker LED on the front panel begins to shine.



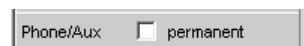
Remote command:

[AUXiliaries:PHONe](#) on page 962

Phone Aux permanent

Phone Out and Anlg Aux Out are **always** active if the checkbox in this field has been selected. Activating the Audio Monitor via the checkbox in the first parameter field of the Auxiliaries panel or the front panel key with the speaker symbol then affects only the internal loudspeaker. With this setting, the "Phone enable" checkbox is selected and grayed out, which means it cannot be altered.

If the OUTPUT OFF key on the front panel is operated, Phone Out and Anlg Aux Out are also turned off at the same time.

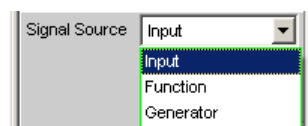


Remote command:

[AUXiliaries:PHPermanent](#) on page 963

Signal Source

Used to select the audio monitoring point along the signal path.



"Input" Audio monitoring of a signal applied at the analyzer inputs. The input signal of the activated analyzer is automatically switched to the audio monitoring output.

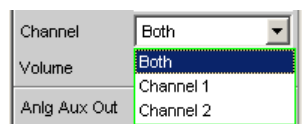
- "Function" The input signal can undergo digital post-processing (processing type depends on the set measurement function) before it is listened to by the user.
So as to avoid overloading in the active filter, level attenuation is carried out in the case of certain weighting filters in order to compensate for the increase in the frequency response. This attenuation is of course taken into account in the measured value display, but is just noticeable in the level of the monitor output.
Note: If high requirements are placed on the internal processing of measured values (sample rates of 192 kHz or more while using several filters), the audio monitoring output is muted in this operating mode in order not to slow down the measurement. This deactivation does not corrupt the measurement result. Pressing the START button automatically reactivates the audio monitoring output.
- "Generator" The digital data signal from the DSP for the currently activated generator is fed to the audio monitoring output via the audio monitoring D/A converter. If the analog generator is being monitored, the audio monitoring D/A converter is actuated using the same digital signals as those fed to the main D/A converter of the analog generator. Audio monitoring is **not** possible with the "DIM" or "Sine" generator functions with activated Low Dist. The following message appears after switching on one of these functions: Speaker not available for generator function DIM or Low Dist activated!

Remote command:

[AUXiliaries:SPEaker:SOURce](#) on page 963

Channel

Used to select the audio monitoring channel



This menu item is used to decide whether both channels (Stereo) or just one channel (either Channel 1 or 2) are to be monitored.

- "Both" The audio monitoring signal is output on both channels at the audio monitoring output. The internal loudspeaker outputs the signal from both channels.
- "Channel 1" Only the signal applied and analyzed via Channel 1 or generated internally is output at the audio monitoring output.
- "Channel 2" Only the signal applied and analyzed via Channel 2 or generated internally is output at the audio monitoring output.

Remote command:

[AUXiliaries:SPEaker:CHANnel](#) on page 963

Volume

Used to set the volume



If the "Input " and "Generator " were selected as signal source, then a volume may be selected within the range of -120 dB (lowest volume or output voltage) to 0 dB (highest volume or output voltage). This setting affects all three internal signal paths: The internal loudspeaker, the jack socket on the front panel of the instrument and the BNC socket (Anlg Aux Out) at the rear of the instrument.

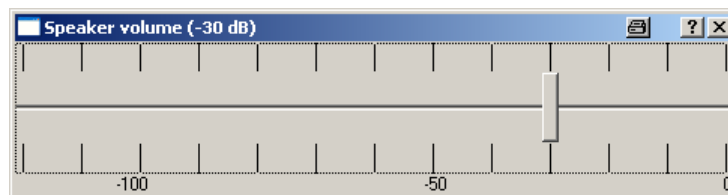
If "Function " is selected as signal source, then the volume may be raised up to +120 dB. This is done by multiplying the digital signal by a corresponding factor prior to D/A conversion. Signals of low digital modulation can then also be heard at sufficient volume.

Note: Volume settings above 0 dB may cause the enlarged digital signal to be overdriven and thus the audio monitoring signal to be distorted.

The output voltage can be adjusted by entering values directly in the panel. If Direct mode is active (the entry field has a magenta frame when the field is selected and the selection is confirmed with "Enter"), the output voltage can be adjusted almost steplessly using the cursor keys or the rotary knob.



If the loudspeaker volume symbol (right key) on the R&S UPV keypad is pressed, the following panel appears on the screen:



In this panel, the volume can be adjusted in steps of 1 dB using the rotary knob or cursor keys => or <= or in steps of 10 dB using the keys "Page Up" and "Page Down".

If a mouse is connected to the R&S UPV, the horizontal slider can be operated directly.

On an external keypad, this panel can be called up by pressing CTRL F9. The output voltage can then be adjusted using the same keys as on the R&S UPV front-panel keypad. The keys "Tab" and "Shift Tab" are used to adjust the output voltage in steps of 1 dB.

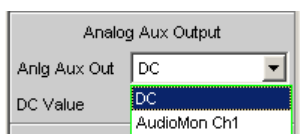
The entry window is closed again by pressing the ENTER key or by pressing the loudspeaker volume symbol again. If a mouse is used, the window is closed by simply clicking the cross in the top right-hand corner.

Remote command:

[AUXiliaries:SPEaker:VOLume](#) on page 963

Anlg Aux Out

Auxiliary BNC output at the rear of the R&S UPV.



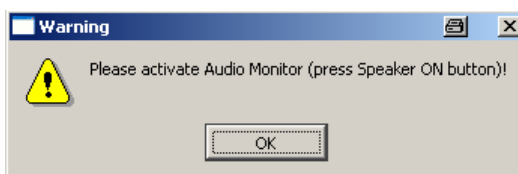
"DC" The auxiliary output supplies DC voltage to the BNC socket at the rear of the instrument. This voltage can be used to power an external DUT (**D**evice **U**nder **T**est, e.g. a hearing aid).

Note: The OUTPUT OFF key on the R&S UPV front panel is without effect if Anlg Aux Out is set to "DC".

The DC current is still provided at the output to ensure that the "DUT" keeps the operating voltage/point!

"AudioMon Ch1" The left-hand channel of the audio monitoring signal is output at the rear BNC socket.

If you select this setting and the Audio Monitor (top line) is still not activated, the message below appears (only if Phone/Aux = permanent is **not** checked):



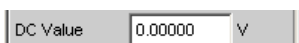
This requests you to activate the Audio Monitor so that a signal is output from the BNC output on the rear of the R&S UPV.

Remote command:

[AUXiliaries:AAUXout](#) on page 962

DC Value

Magnitude of the DC voltage level at the rear BNC socket.



The DC output voltage can be adjusted between -2.5 V and +2.5 V.

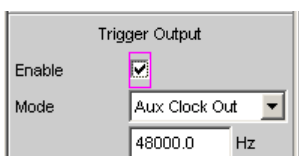
This line appears only if "DC" has been set as Anlg Aux Out in the parameter field above.

Remote command:

[AUXiliaries:DCValue](#) on page 962

Trigger Output

Auxiliary BNC output at the rear of the R&S UPV.



Enable

For enabling or disabling the trigger output.



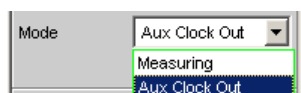
If the trigger output is deactivated, there is a low level at the TRIGGER OUT BNC jack on the rear of the instrument.

Remote command:

[AUXiliaries:TRIGger:OUTPut:ENABle](#) on page 964

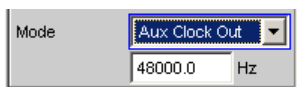
Mode

The R&S UPV outputs either a pulse, while a measurement is running, or a square-wave signal.



"Measuring" While a measurement is being performed in a 2-channel analyzer, the R&S UPV outputs a low or high level, depending on the setting in the Edge line. In multichannel analyzers, the trigger signal is not available and is muted. A corresponding warning will then be output.

"Aux Clock Out" The frequency of the internal DDS oscillator on the Digital Main Board (DMB) is output as a square-wave signal. If "Aux Clock Out" is selected as the Mode in Trigger Output, an additional line appears so that you can enter a frequency:



The frequency of the DDS oscillator can be used for synchronization purposes.

At the bandwidths 22 kHz, 40 kHz and 80 kHz (in the Generator Config panel), the frequency is independent of the sampling frequency of the generator.

If "Play Auto" is selected, the frequency is 512 times the sampling frequency (master clock) with which a waveform signal has been acquired by the analyzer (recorded waveforms) and can be played back via the generator ("Play Auto" bandwidth in the Generator Config panel and "Play" function in the Generator Function panel).

Remote command:

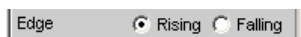
[AUXiliaries:TRIGger:OUTPut:MODE](#) on page 964

[AUXiliaries:TRIGger:OUTPut:FREQUency](#) on page 964

Edge

This line defines whether you want the R&S UPV to output a high or low level during measurement.

This parameter field appears only if "Measuring" was set as the Mode.

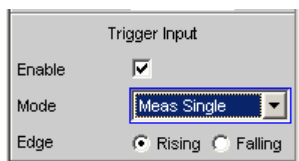


Remote command:

[AUXiliaries:TRIGger:OUTPut:EDGE](#) on page 964

Trigger Input

Auxiliary BNC input at the rear of the R&S UPV.



Enable

For enabling or disabling the trigger input.

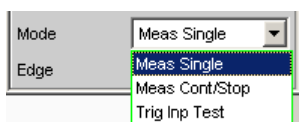


Remote command:

[AUXiliaries:TRIGger:INPut:ENABle](#) on page 963

Mode

The presence of a pulse on the "Trigger In" BNC connector can trigger various events.



- "Meas Single" The trigger pulse launches a single measurement. The START, SINGLE and STOP/CONT keys on the front panel are disabled.
- "Meas Cont/Stop" The trigger pulse launches a continuous measurement. Due to the toggle function the measurement can be started or stopped while running. The START, SINGLE and STOP/CONT keys on the front panel are disabled.
- "Trig Inp Test" All LEDs light up according to the voltage that is present (TTL level).
Low = Off
High = On

Remote command:

[AUXiliaries:TRIGger:INPut:MODE](#) on page 964

Edge

This line defines whether you want the R&S UPV to react on the rising or falling edge of the input signal.

This line is not visible if the "Trig Inp Test" mode has been selected.

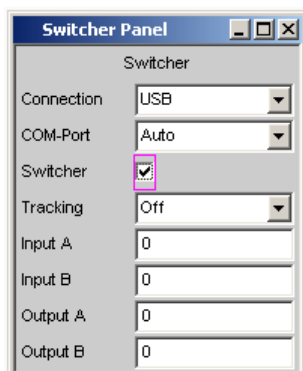


Remote command:

[AUXiliaries:TRIGger:INPut:EDGE](#) on page 963

5.48 Switcher Panel

This section describes how to connect and operate the R&S UPZ switcher on the R&S UPV.



5.48.1 Connecting Switcher to R&S UPV

The R&S UPZ audio switchers can be connected to the R&S UPV.

Older R&S UPZ models .02/.03 that do not have a USB interface are connected using the RS232 interfaces of both instruments.



The new R&S UPZ models .12 and .13 have a USB interface and can be connected to the R&S UPV directly using a USB cable. A driver has to be installed before initial startup! The description for this can be found in the operating manual for the R&S UPZ Audio Switcher, Chapter "Startup", "Connecting Control Lines" ff..

The R&S UPZ may be used as an input switcher or an output switcher. An input switcher makes it possible to connect up to eight different DUTs to the two analyzer inputs without having to change connectors each time. An output switcher can supply up to eight DUTs with the generator channels delivered by the R&S UPV.

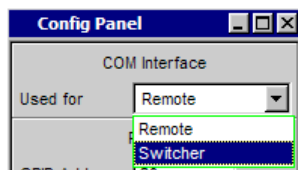
Up to 16 input switchers and 16 output switchers can be connected to the R&S UPV, making up to 128 channels available.

The two busbar connectors A and B on the front panel of the R&S UPZ have to be connected to the R&S UPV. In the case of an input switcher the XLR connectors on the busbar are connected to the analyzer inputs, and in the case of an output switcher the XLR connectors on the busbar are connected to the generator outputs.

The R&S UPZ is controlled via the COM interface of the R&S UPV, which is not only used for operating the R&S UPZ but can also be used to remotely control the R&S UPV.

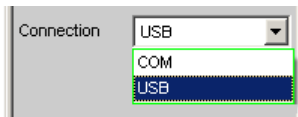
COM Interface Used for

In the Config panel, the serial interface labeled "COM" on the rear side of the instrument can optionally be used for remote control or controlling the R&S UPZ switcher.



See "COM Interface Used for" on page 659

Connection



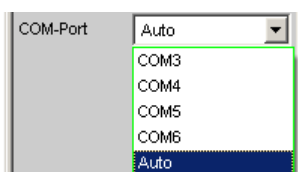
Determines whether a switcher should be addressed directly via the RS232 interface or via the USB interface using a **USB to serial adapter**.

- "COM" Prepares the RS232 connection to a switcher. If the Switcher panel is activated by setting the "Switcher" checkmark, the RS232 interface is searched for a switcher, the connection is established if necessary and the panel is opened. If no switcher is found, an error message appears.
- "USB" Prepares the USB connection to a switcher via a **USB to serial adapter**; see the "COM-Port" parameter field. The following "COM-Port" parameter field with the settings COM3 to COM6 allows a fast call setup, although the easy-to-use setting "Auto" is recommended! If the Switcher panel is activated by setting the "Switcher" checkmark, the RS232 interface is searched for a switcher, the connection is established if necessary and the panel is opened. If no switcher is found, an error message appears.

Remote command:

`SWITcher:CONNECTION` on page 965

COM Port



The R&S UPZ is fitted with an RS232 interface for connection to a control unit. The R&S UPV does not have this interface but instead provides several USB interfaces. The R&S UPZ is therefore connected to the R&S UPV by means of a **USB to serial adapter** that can be purchased from a retailer at low cost. The driver software for this adapter must be installed on the R&S UPV.

Note: Selecting the COM port sets the RS232 parameter in such a way as to guarantee the connection to the switcher without any further settings. The easy to handle setting "Auto" is recommended!

After installing the **USB to serial adapter** or changing the COM port, the R&S UPV must be restarted.

"COM3 to COM6"	<p>Direct specification of the COM port occupied by a switcher. The call setup to the switcher is done quickly. Note that the COM port number may change if the switcher is connected to another USB port. Therefore, the direct specification of the COM port is recommended only if it is ensured that the wiring of the switcher does not change.</p> <p>If the COM port that the switcher uses to communicate is to be entered here, the port has to be determined after installation of the USB to serial adapter by using the Windows XP Device Manager: Open Start, Settings, Control Panel, System, Hardware, Device Manager, Ports (COM&LPT) and right-click the USB to serial adapter entered there to open its Properties. With Port setting, Advanced, you can determine the interface to report it with this parameter field to the control software of the R&S UPV, or the COM interface listed in the Device Manager is adjusted to the COM port selected in the R&S UPP.</p>
"Auto"	<p>All COM ports from 3 to 256 are searched for a connected switcher and, if necessary, the connection is established. This search process takes longer than the direct input of the COM port, but it generally leads to immediate success without having to observe the COM port number.</p>

Remote command:

[SWITcher:COMPort](#) on page 965

5.48.2 Default Setting

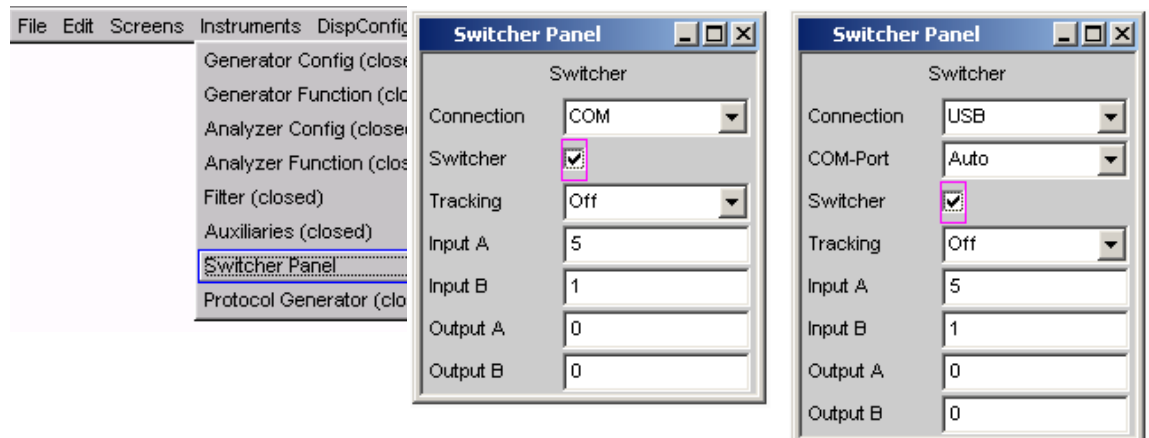
If the switcher is operated for the first time after loading the R&S UPV default setup (preset), the channels are set to a defined default state: All channels of the two switcher types are set to "0", i.e. open. If additionally tracking is activated for the first time, tracking "B vs A" is set to "-1" and tracking "Out vs Inp" is set to "0".

This ensures that when the user interface is opened all channels are open and thus prohibited states in the test setup are avoided.

If you wish to obtain the same setting as in the default state manually, simply enter "All" as the Tracking setting and set any channel to "0". All the others are then also adapted.

5.48.3 Operation

Open the panel for operating the switcher as follows: "Menu – Instruments – Switcher Panel "

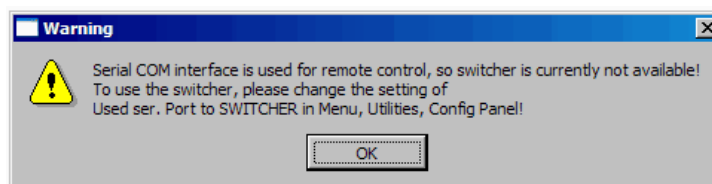


Switcher

Switcher

The checkbox activates or deactivates the operation of the switcher. This status is not dependent on whether the panel itself is open or not.

Operation can only be activated if a setting was previously made in the "Config Panel" to specify that the COM interface is to be used to control the switcher (COM Interface used for Switcher). If not, the following note appears



Remote command:

[SWITcher:STATe](#) on page 966

Tracking

The channels of the connected switchers can be used not only independently of one another ("Tracking" "OFF"), but together as well. This makes it possible to select a channel offset between the two busbars and/or between input and output switchers. When one of the operator fields Input A/B or Output A/B is then used, the other one(s) is/are automatically adapted by the R&S UPV in accordance with the offset that has been set. Channels < 0 are set to 0, that is, the busbar is switched off.

"Off" Tracking is off and the channels can be connected independently of one another.

"B vs A" The channels are switched to an offset between the busbars A and B. This offset can be set in the parameter field "B vs A".

Application:

Measurements of multichannel DUTs.

"Out vs Inp" The channels of input and output switchers are switched to an offset that can be set in the parameter field "Out vs Inp".

Application:

Crosstalk measurements in the adjacent channel.

"All " Combines both tracking options described above.

Remote command:

[SWITcher:TRACking](#) on page 966

B vs A

For entering the channel offset between the busbars A and B, in common for input and output switchers.

This operator field only appears when tracking "B vs A" or "All" is selected.

Remote command:

[SWITcher:OFFSet:BVSA](#) on page 965

Out vs Inp

For entering the channel offset between input and output switchers.

This operator field only appears when tracking "Out vs Inp" or "All" is selected.

Remote command:

[SWITcher:OFFSet:OVSI](#) on page 965

Input A

For entering the channel number of the input switcher that is to be connected to busbar A.

It is not possible to set this channel to busbar B. If this is attempted, a correction is made to the next higher or next lower channel number.

Remote command:

[SWITcher:INPA](#) on page 965

Input B

For entering the channel number of the input switcher that is to be connected to busbar B.

It is not possible to set this channel to busbar A. If this is attempted, a correction is made to the next higher or next lower channel number.

Remote command:

[SWITcher:INPB](#) on page 965

Output A

For entering the channel number of the output switcher that is to be connected to busbar A. This setting changes its significance when -1 is set under "Output B", see under that section.

It is not possible to set this channel to busbar B. If this is attempted, a correction is made to the next higher or next lower channel number.

Remote command:

[SWITcher:OUTA](#) on page 966

Output B

Used to enter the channel number of the output switcher that is to be connected to busbar B. Here it is possible to enter "-1" as the channel number. The result is that **all** channels **of all** connected switchers are closed in busbar B, with the exception of the one that is selected in busbar A. This setting is useful for worst-case crosstalk measurements. If no channel is selected in busbar A ("Output A" = 0), all channels in busbar B are closed.

It is not possible to set this channel to busbar A. If this is attempted, a correction is made to the next higher or next lower channel number.

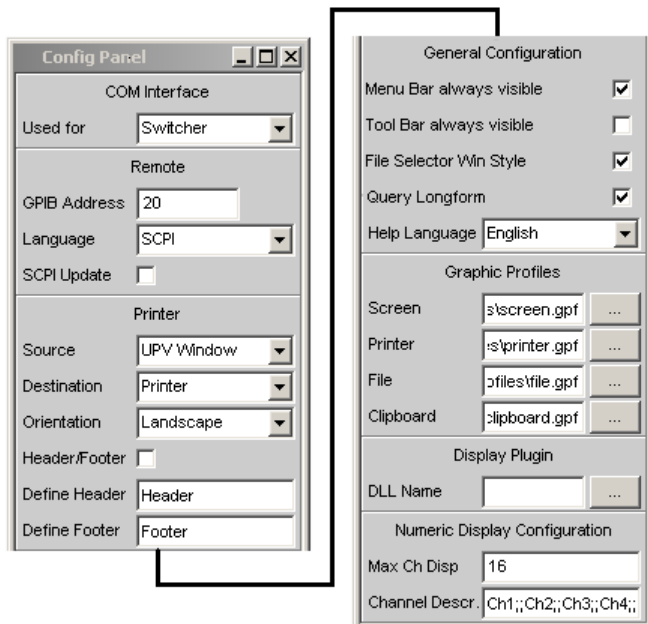
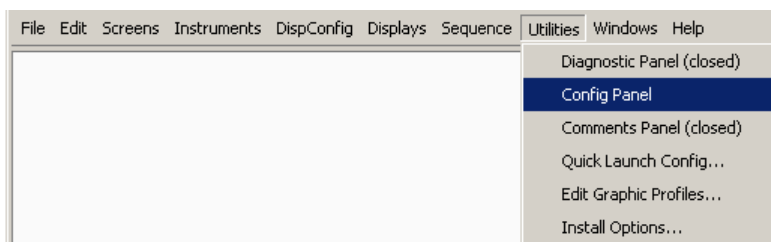
Remote command:

[SWITcher:OUTB](#) on page 966

5.49 Config panel

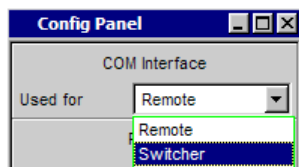
This section describes the Config panel of the R&S UPV where settings are made that affect the behavior of the instrument (across all panels in some cases).

The panel is called up using the menu line:



COM Interface Used for

The serial interface labeled "COM" on the rear side of the instrument can optionally be used for remote control or controlling the R&S UPZ switcher.



A new selection becomes effective as soon as the R&S UPV is restarted.

"Remote" The COM interface can be used for remote control of the R&S UPV.

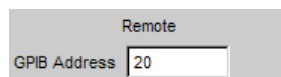
"Switcher" The COM interface is used for control of the R&S UPZ.

Remote command:

-

GPIB Address

Entering a IEC/IEEE bus address



The IEC/IEEE bus address of the instrument is factory-set to 20 and can be modified here. Addresses from 0 to 30 are permissible. For more information, see [chapter 6.3.1, "Remote Control by IEC/IEEE Bus "](#), on page 804.

Remote command:

[SYSTem:COMMunicate:GPIB:ADDRess](#) on page 1035

SCPI update

Determines whether the panels are to be updated during remote control mode (checked) or not.



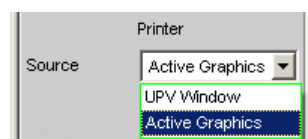
For reasons of speed, this update should be switched **off**. The panels then show the device status **before** the change to remote control mode. While generating a remote control program it can be useful to enable updating so that you can see the effect of the remote control commands.

Remote command:

[SYSTem:DISPlay:SCPiupdate](#) on page 1035

Source

Selection of the screen content to be output.



"UPx Window" This setting outputs the entire screen of the R&S UPV as a bitmap. This is the default after firmware installation.

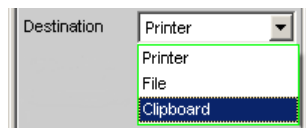
"Act. Graphics" This setting outputs the momentarily active graphical window as a vector graphic. This applies to the FFT Graph, Waveform, Bargraph, Sweep Graph and PESQ graphics. The type of graphic depends on the target device.

Remote command:

[HCOPY:SOURce](#) on page 1019

Destination

Selection of the destination for the screen content to be output.



"Printer" The screen content selected under "Source" is output direct to the printer set as the default printer under Windows. Graphs are output in vector format, screenshots as bitmaps.

"File" The screen content selected under "Source" is output to a file specified under "File Name". The selected file extension determines the format of the graph, either vector or bitmap format. Screenshots are always output as bitmaps.

"Clipboard" The screen content selected under "Source" is output direct to the Windows clipboard and can be used direct in other applications. The output is always as bitmap.

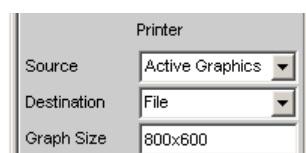
Note: If the instrument is being remotely controlled from the Windows Remote Desktop, the "Clipboard" setting allows you to transport graphics direct between the instrument and the host computer.

Remote command:

[HCOPY:DESTination](#) on page 1019

Graph Size

Resolution for vector graphs.



A change to the resolution is only provided for the "Source" = Act. Graphic and "Destination" = File | Clipboard settings. These settings produce a vector graph whose resolution can be specified.

Bitmaps whose resolution cannot be changed without a major loss of quality are used for the settings "Source" = UPV Window or "Destination" = Printer, which is why an option to define the resolution is not available.

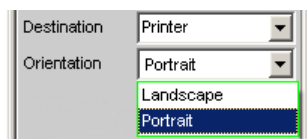
The setting made here remains unaffected by preset or by loading a setup; it is therefore bound to the device.

Remote command:

[HCOPY:GSIZe](#) on page 1019

Orientation

Selection of the orientation required on the Windows printer (only if "Destination" is configured as "Printer").



"Portrait" Output on the printer is in portrait format.

"Landscape" Output on the printer is in landscape format.

Remote command:

[HCOPY:PRINter:ORIENTATION](#) on page 1020

Header/Footer

Selection of the required header and footer in the output.



"activated" The header and footer are visible.

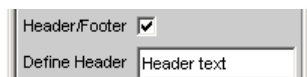
"deactivated" The header and footer are not visible.

Remote command:

[HCOPY:PRINter:ADDITION](#) on page 1020

Define Header

Desired text for the header.



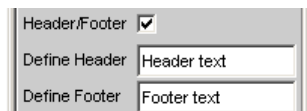
Not available if Header/Footer has been activated. This text forms the title in the middle of the header line.

Remote command:

[HCOPY:PRINter:HEADER](#) on page 1020

Define Footer

Desired text for the footer.



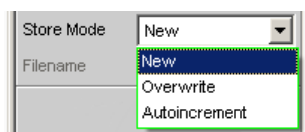
Not available if Header/Footer has been activated. This text forms the legend in the middle of the footer line.

Remote command:

[HCOPY:PRINter:FOOTER](#) on page 1020

Store Mode

Selection of the mode for output to a file.



Only available if "Destination" is set to File.

- "New" Pressing H COPY opens the file selection box in which you enter the name of the destination file. See also the section [chapter 5.62.1, "Saving Setups"](#), on page 798.
- "Overwrite" Output is always to the file of "File Name", which is overwritten without asking you each time.
- "Autoincrement" Output is to a file whose name is composed of two parts: The beginning of the file name is the name entered as "File Name", followed by a consecutive number that is incremented by 1 every time you press H COPY.

Remote command:

`HCOPY: FILE:MODE` on page 1019

Filename

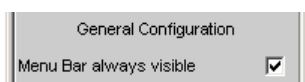
Selection of the desired file name for the output to a file. Only available if "Destination" is set to File and "Store Mode" is not set to New. The file selection box opens for you to change the file name (see section [chapter 5.61, "Loading and Saving"](#), on page 796). Enter the file name without an extension; the "File Type" setting in the file selection box defines the file type.

Remote command:

`HCOPY: FILE` on page 1019

Menu bar always visible

Permanently displays the menu bar.



The audio analyzer allows you to have the menu bar displayed at the top edge of the screen all the time. This feature is primarily for operation with the mouse.

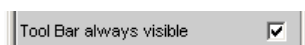
- "activated" The menu bar is permanently displayed on the top edge of the screen.
- "deactivated" The menu bar appears at the top edge of the screen as soon as you move the mouse pointer to the left-hand edge of the screen. The bar disappears again after a function has been selected.

Remote command:

-

Toolbar always visible

Permanently displays the toolbar.



The R&S UPV allows you to have the toolbar displayed at the right-hand edge of the screen all the time. This feature is primarily intended in the case of operation with the mouse.

"activated" The toolbar is permanently displayed on the right-hand edge of the screen.

"deactivated" The toolbar appears on the right-hand edge of the screen as soon as the mouse is moves there. It disappears again as soon as the mouse moves away from the right-hand edge of the screen.

Remote command:

-

File Selector Win Style

The style of the "File Select" window.



"activated" The familiar "File Select" window from MS Windows is used for selecting files. This makes for very convenient operation when using a mouse, but also allows for very limited operation using the front panel.

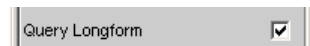
"deactivated" For selecting files, the R&S UPV uses its integrated "File Select" window which is completely accessible via the front panel and also allows file names to be entered via the numeric keys using the cell phone method.

Remote command:

[SYSTem:WINStyle](#) on page 1038

Query Longform

Query response in short or long form.



"activated" The response to a SCPI query is in long form, e.g. query: TRIGGER:SOURce? -> Response: **CH1Freq**.

"deactivated" The response to a SCPI query is in short form, e.g. query: TRIGGER:SOURce? -> Response: **CH1F**.

Remote command:

[SYSTem:QLONG](#) on page 1037

Help Language

Both the context-sensitive help and the online help are available in English and German. The R&S UPV has to be restarted for a language change to take effect. For more information, see [chapter 4.14, "Help System"](#), on page 214.

"English"

"German"

Remote command:

[SYSTem:HELP:LANGuage](#) on page 1036

Max Ch Disp

Number of simultaneously displayed channels in the numeric display for multi-channel instruments.



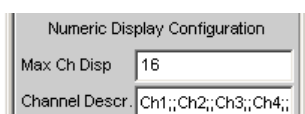
The remaining channels can be reached via the scrollbar.

Remote command:

[SYSTem:MAXChdisp](#) on page 1036

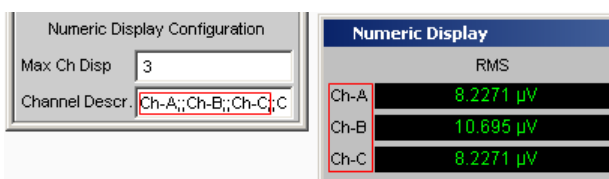
Channel Descr.

Labeling of the display fields in the numeric display.



The labeling of the display fields in the Numeric Display is generally Ch1, Ch2, Ch3, etc., but it can be changed with the "Channel Descr." parameter field.

The respective string is called: "**Ch-A;;Ch-B;;Ch-C;;Ch-D;;Ch5;;Ch6;;Ch7;;Ch8;;Ch9;;Ch10;;Ch11;;Ch12;;Ch13;;Ch14;;Ch15;;Ch16**".



Remote command:

[SYSTem:CHNString](#) on page 1034

5.50 Curve, Spectrum and Bar Graph Display

The most informative method of displaying measurement results is usually a two-dimensional graphic. Measured values as a function of frequency, measurements over a time axis and so on are just a few examples of the many possible applications. The Audio Analyzer R&S UPV makes a distinction between the following graphic windows: Sweep Graph, FFT Graph, Waveform, Bar Graph, PESQ/POLQA and Impulse Response. These windows are set up and modified using the associated configuration panel and displayed as traces or bar graphs.

5.50.1 Graphical Display, Explanation of the Elements

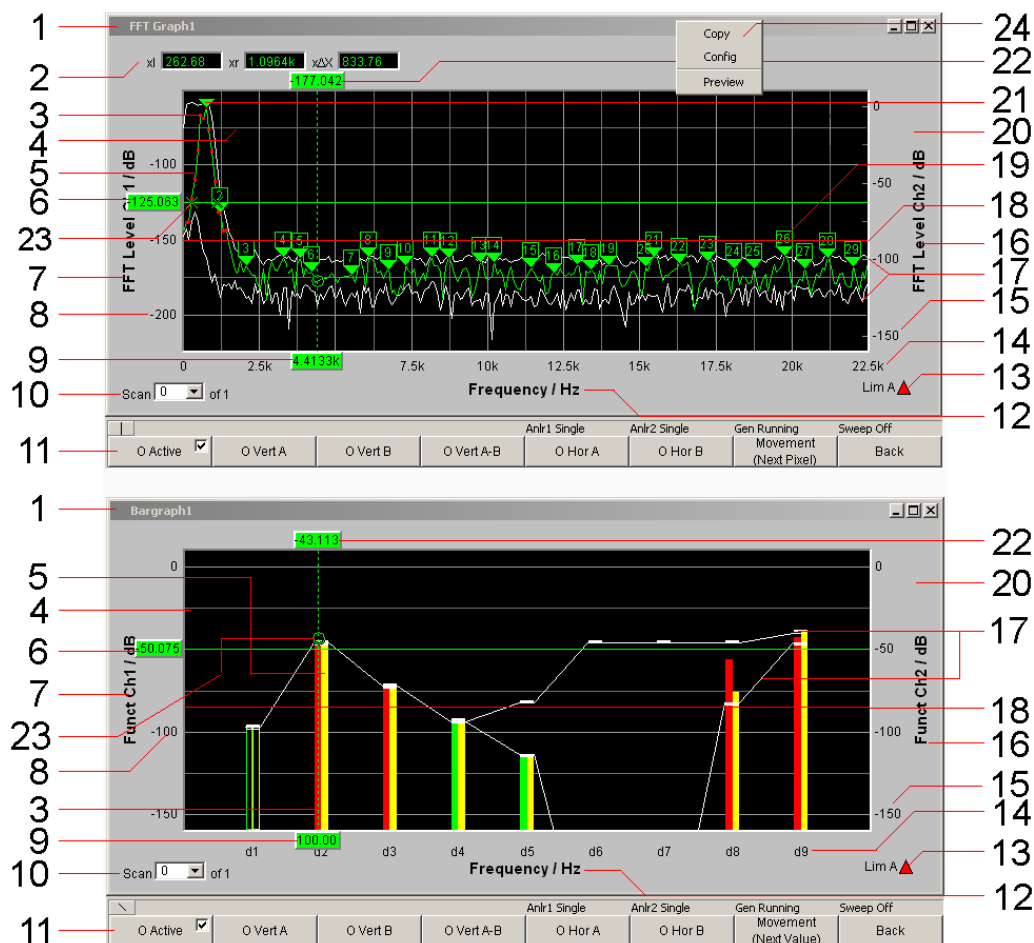
Whether a graphical display is shown as a trace or a bar graph depends on the selected display configuration panel.

- The sweep graphs, FFT graphs, waveform, PESQ/POLQA and Impulse Response graphical windows are displayed as traces, whereas

- the bar graphs display the measurement results of the analyzer measurement functions THD, THD+N & SINAD, Mod Dist, DFD, DIM, Third Octave or 1/n Octave as bar graphs.

For information on how to set up the various display configurations, see [chapter 5.50.2, "Calling Up"](#), on page 671.

The individual elements in the trace and bar graph displays are virtually identical but for one or two exceptions. Only a bar graph which requires a symbolic x-axis (that is, the bar graph for the analyzer measurement functions THD, THD+N & SINAD, Mod Dist, DFD, and DIM), does not offer certain elements, such as markers or grid lines for the x-axis.



1: Name of the graphical window

To be set via the menu bar "Displays" or "Disp Config" and the "Display Show" button in the corresponding panel

2: Additional cursor values ΔX , ΔY , ol, or, o ΔX xl, xr, x ΔX

ΔX : Difference between the X values if the O and X cursors are both activated as the vertical cursor at the same time.

ΔY : Difference between the Y values if the O and V cursors are both activated as the vertical cursor at the same time.

Only for traces (not for bar graphs):

ol: The point to the left of the marker at which the O cursor intersects the trace.

or: The point to the right of the marker at which the O cursor intersects the trace.

o ΔX : Difference between ol and or.

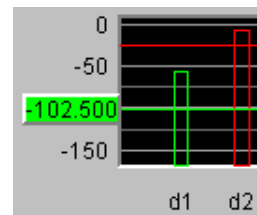
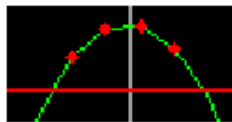
xl: The point to the left of the marker at which the X cursor intersects the trace.

xr: The point to the right of the marker at which the X cursor intersects the trace.

x ΔX : Difference between xl and xr.

3: Limit violations

Limit violations are indicated by red dots on traces or by red bars in bar graphs:



4: Main grid, subgrid

Set in the associated DispConfig panel using the parameter fields



in the sections Trace A, Trace B and x-axis.

In graphic systems Bargraph1 | 2, a grid cannot be set for the x-axis, since this makes no sense for an unscaled x-axis.

5: Trace / bar graph display

Depending on the selected graphic

6, 22: Cursor Y value

Vertical cursors:

Y value, or if O Vert A-B / X Vert A-B is set, the difference between the Y values for the A and B trace / A and B line.

Horizontal cursors:

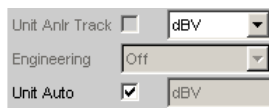
Y value on the Y1 and/or Y2 axis.

7, 16: Labeling of y-axis

Consists of the label and unit; set with



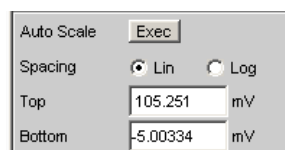
and



See [chapter 5.50.3, "Parameter Fields of the Panel"](#), on page 673.

8, 15: Scaling of y-axis

Automatic ("Auto Scale ") or scaling ("Top, Bottom ") of the y-axis to be set manually, to be set using

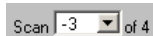


See [chapter 5.50.3, "Parameter Fields of the Panel"](#), on page 673.

9: Cursor X-value

X value for vertical cursors.

10: Scan number



Multiscan mode:

When you use the NEXT SCAN toggle key to scroll through the scans, the current value is entered here. Number 0 means the most recent scan. The lower the negative number, the older the scan.

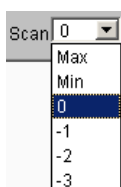
The **of 4** shown in the example indicates the currently set history and informs the user how many scans are stored in the memory or saved in the file. This value is set in the associated DispConfig panel using



See ["History"](#) on page 675.

The entries Min and Max denote the min/max curves, provided these are switched on and are also available in single-scan mode.

Right-clicking the arrow opens a box



in which the desired scan can be selected by clicking the appropriate number. The cursors, markers, limit values and so on are then referenced to this scan.

11: Softkey bar

The softkey menu for the graphical window allows quick configuration of all the important and frequently used settings, especially cursor, marker, and zoom functions by means of the keys provided below the menu or by clicking the mouse.

See [chapter 5.50.3, "Parameter Fields of the Panel"](#), on page 673.

12: Label of x-axis

Only for displaying curves, not in graphic system Bargraph1 | 2:

Consists of the label and unit; set with

X-Axis	Frequency	Label Auto	<input type="checkbox"/>	Frequency
Unit	Hz	Unit Auto	<input type="checkbox"/>	Hz

See [chapter 5.50.3, "Parameter Fields of the Panel"](#), on page 673.

13: Limit display

Lim A	<input type="checkbox"/>	Lim B	<input type="checkbox"/>
-------	--------------------------	-------	--------------------------

"Limit Upper"



Limit Upper is activated and there is no limit violation.

"Limit Lower"



Limit Lower is activated and there is no limit violation.

"Limit Upper past"



The "Limit Upper" value has been violated in the past but there is currently no limit violation. The violation is indicated until the START key is pressed again.

"Limit Lower past"



The "Limit Lower" value has been violated in the past but there is currently no limit violation. The violation is indicated until the START key is pressed again.

"Limit Upper current"



The "Limit Upper" value is currently being violated.

"Limit Lower current"



The "Limit Lower" value is currently being violated.

14: Scaling of x-axis

Only for displaying curves, not in graphic system Bargraph1 | 2:

Automatic or manually set scaling of the x-axis; set with

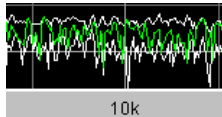
Scaling	<input checked="" type="radio"/> Manual	<input type="radio"/> Auto	Spacing	<input checked="" type="radio"/> Lin	<input type="radio"/> Log
Left	161.172	Hz	Right	2.17582	kHz

See [chapter 5.50.3, "Parameter Fields of the Panel"](#), on page 673.

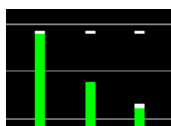
17: Min/Max curve

The min/max curves are displayed in white.

The min curve represents the lowest value of Y in a measurement sequence and the max curve represents the highest.



In the graphic system Bargraph1 | 2 the minimum and maximum values are shown as small white blocks.



To be set in the upper part of the associated panel via the parameter field.



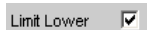
The min/max curves are to be thought of as scans of a multiscan display. If "Show Min Max" is on, there is a single scan from three scans.

18: Limit line

Fixed limit value or fixed limit value curve from a file, for activation in the associated DispConfig panel via the parameter fields



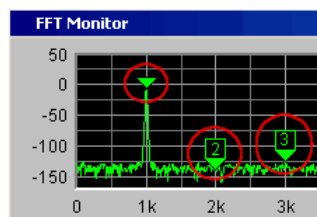
and



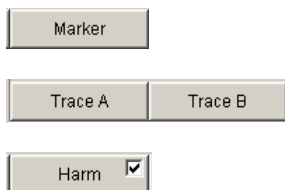
in the sections Trace A and Trace B.

19: Harmonic markers

In the following example, starting from the X position of the marker (1 kHz), the harmonics (2 kHz and 3 kHz) are marked.



The harmonic markers are activated using the softkeys:

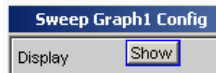


Available in the graphics subsystems

FFT

20: Graphical window

The graphical window to each graphics subsystem is opened from each Display Config Panel using



or directly from the menu bar

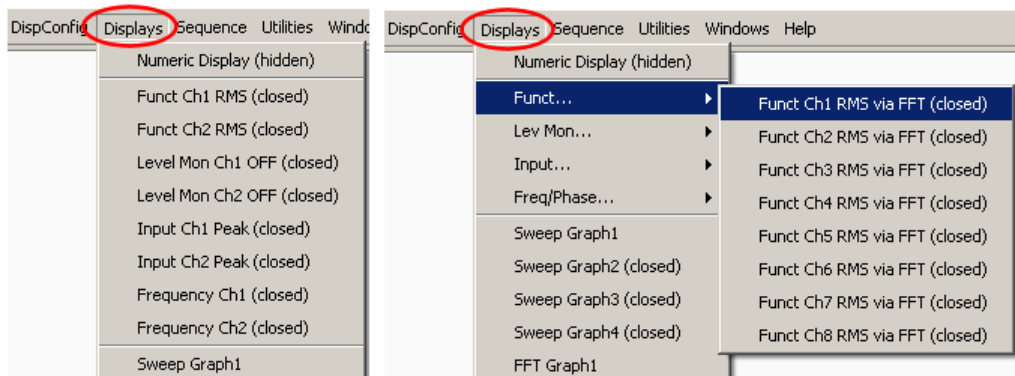


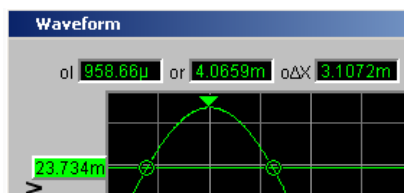
Fig. 5-39: Display menu for two and multichannel instruments

21: Marker

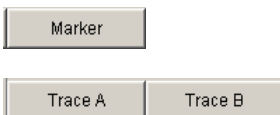
Marking of the value on the x-axis from which the left and right intersections of a horizontal cursor will be displayed with the curve.

Additionally for the graphic systems FFT Graph1 | 2:

Marking of a value on the x-axis from which harmonics are calculated.



The marker is set using the softkeys:



Available in the graphics subsystems

Sweep, FFT, Waveform, PESQ/POLQA, Impulse Response

23: Cursor intersection points

The **O** or **X** at which the cursor line intersects the trace / lines identify the cursor so that a reference to the labels in the softkey bar, such as **O Vert A** or **X Hor A**, is provided.

24: Copy / Config / Preview

Right-clicking anywhere in the graphical display calls up a context menu, left-clicking on one of the entries executes the corresponding function.

Copy:

Copies the graphic to the clipboard (default 800 x 600 pixel). Resolution and aspect ratio of the graphic can be changed in the Config panel in the Printer area with the "Graph Size" parameter field if the "Destination" parameter field is set to "File" or "Clipboard". With a reduction of the resolution, picture elements such as axis labels can be omitted. Compared to the "Copy" function, the shortcut CTRL+C copies the graphic to the clipboard with the exact resolution and aspect ratio as shown on the monitor.

Config:

Opens the corresponding DispConfig panel.

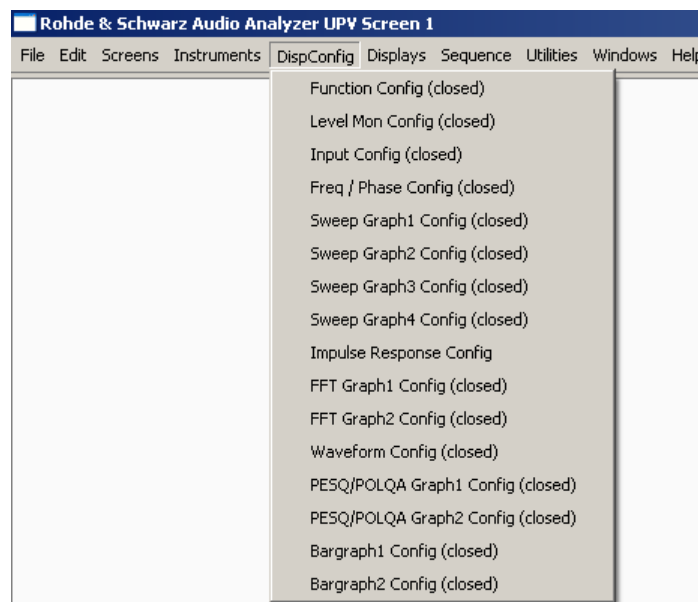
Preview:

Shows a print preview, if the print source "Source" = "Active Graphics" is set in the Config panel in the Printer area. The graphics is always offered with all picture elements in the aspect ratio 4:3.

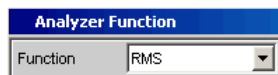
5.50.2 Calling Up

The Display Configuration panel is used to set how measurement results **are graphically** displayed. **What will be measured and how** is set in the "Analyzer Config" and "Analyzer Function" panels or, in the case of sweeps, defined in "Generator Config" and "Generator Function".

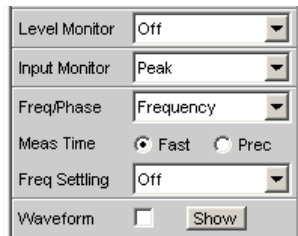
The display configuration panels are opened via the menu bar of the R&S UPV.



A number of different display configuration panels can be selected simultaneously, some of them in two or four windows, e.g. the measurement data sets for the analyzer measurement function RMS



and the measurement data sets for the additional measurement functions Level Monitor, Input Monitor, Freq/Phase Measurement and Waveform



can be displayed at the same time.

- "Sweep "in 4 windows
Listed in the menu as "Sweep Graph1 Config" to "Sweep Graph4 Config".
The panel is used to configure the display of measurement results from a measurement sequence (sweep) as a diagram in the Cartesian coordinate system. Two dependent values can be displayed as TRACE A and Trace B over an independent x-axis.
- "FFT Graph " in two windows
Listed in the menu as "FFT Graph1 Config " and "FFT Graph2 Config ".
The panel offers the configuration for displaying a frequency spectrum if the measurement function FFT or the measurement functions RMS, RMS Selective, S/N, THD, THD & SINAD, Mod Dist, DFD, DIM. and Record "with post-FFT " is selected in the analyzer panel.
- "Waveform" in a window
Listed in the menu as "Waveform Config".
The panel is used to configure the display of a waveform (trace of the signal over time) if Waveform is selected as the additional measurement function in the analyzer panel.
- "Bar Graph" in two windows
Listed in the menu as "Bargraph1 Config " and "Bargraph2 Config ".
The panel offers the configuration for displaying a bargraph **with symbolic, i.e. non-scaled x-axis** if the measurement function THD, THD+N & SINAD, Mod Dist, DFD, or DIM is selected in the analyzer panel. The panel offers the configuration for displaying a bar graph "with an x-axis in Hz" if the measurement function Third Octave or 1/n Octave is selected in the analyzer panel.
- "PESQ/POLQA" in two windows
Listed in the menu with "PESQ/POLQA Graph1 Config" and "PESQ/POLQA Graph2 Config".
The panel offers the configuration for displaying the PESQ and POLQA measurement if the PESQ or POLQA measurement function is selected in the analyzer panel.

5.50.3 Parameter Fields of the Panel

The layout of the display configuration panels is almost identical for all of the graphic systems. Depending on the graphic system, parameter fields may be omitted or different parameter lists may appear in the selection fields.

For example, the display configuration panels for FFT and Sweep offer various choices for the sources of the measurement results.

The differences are explained for the individual parameter fields.

"Sweep " for two-channel instrument	"FFT " for two-channel instrument	"Sweep " for a multichannel instrument
<p>The source of the measurement results (FFT Level) and the channel number (Ch1) are combined in the selection list (FFT Level Ch1)</p>		<p>The source of the measurement results and the channel number are separated, since the manifold possible combinations can no longer be displayed in a selection box.</p>

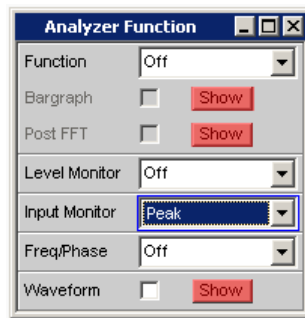
Display



Clicking this button in the Display parameter field activates the graphical display of traces or bar graphs.

To close it, provided it has the focus, click on the CLOSE button or on the X in the title bar.

A duplicate of this "Show button" can also be found in the Analyzer Function panel so that you can conveniently call up the graphic display for Bar Graph, FFT, or Waveform from there.



Data List



Clicking the button opens a separate window in which the measurement results for Trace A and Trace B and the values to the corresponding x-axis are displayed numerically. To close it, provided it has the focus, click on the CLOSE button or on the X in the title bar (see [chapter 5.51, "Result List"](#), on page 735).

Copy to other Windows



The "Copy to other Windows" function is available for the respective first window of the Sweep, FFT, Bar Graph and PESQ/POLQA sub-systems; in other words, for all sub-systems which have more than one window.

As the name says, settings from the first window are copied into all the sub-system's other windows. This happens **once** when the "Exec" button is pressed.

This copying process is performed for almost all commands following a new installation of the R&S UPV.

If only specific command areas are to be transferred from the first window to the subsequent windows, limitations can be set in the dialog box which opens when the "Config..." button is pressed.

The checkmarks in the dialog can easily be assigned to the respective panel areas, which are marked by thin lines, by means of their labels.

The selection of command areas made here is unaffected by preset or by loading a setup; it is therefore bound to the device.

Remote command:

[SENSe<n1>:CONFIg:COPIother](#) on page 993

Scan



For the graphics subsystems Sweep Graph 1 to 4: Used to specify whether **one** (Single) or **several** (Multi) measurement sequences are recorded or loaded from a file.

Available in the graphics subsystems

Sweep

If a Z sweep is set in the generator, Scan will automatically be set to Multi, provided that X-Source = Sweep is set in the display panel.

Refer also to [chapter 5.55, "Measured value Sequences"](#), on page 768.

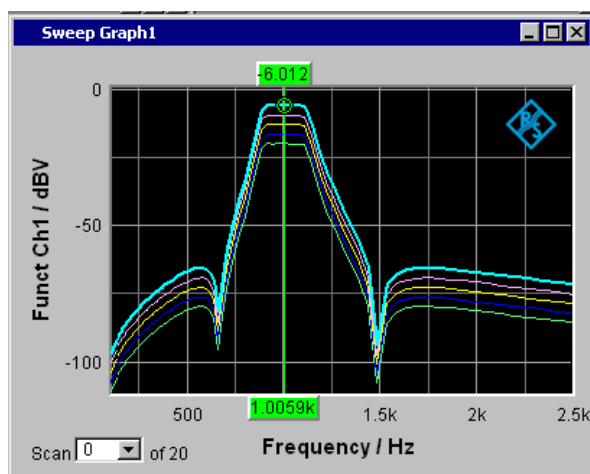
"Single" Only one trace (measurement sequence) or one trace pair (TRACE A and B) is to be recorded or loaded.
The display can be in the form of a trace or a bar graph.

The following parameter fields are hidden:

- History
- New Scan
- Import From

If the "Show Min Max" checkbox is selected, two scans are added to the single measurement sequence, and the toggle key NEXT SCAN can be used to choose between three scans.

"Multi" With this setting, **not just one** measurement sequence or pair of measurement sequences (Trace A and Trace B) is recorded/loaded and displayed but any number of sequences and sequence pairs.



However, only the number selected in the **History** parameter field is stored internally and written to file or read from file; the maximum for this number is 20. The scans that are not stored are only available in the graphic and are lost if the graphical window is moved or resized, if rescaling is performed, if trace files are stored/loaded or if setups are stored/loaded.

The following parameter fields become available:

- History
- New Scan
- Import From

Remote command:

[DISPlay:SWEEp<n2>:SMODE](#) on page 988

History

History

Only available if "Scan" is set to "Multi" and therefore only for the graphic systems Sweep Graph 1 to 4.

Available in the graphics subsystems

Sweep

History determines how many scans are stored in the memory or saved in the file. It is not possible to select "1" as this number represents single-scan mode.

When the X-source in the display panel is set to Sweep, when a Z-sweep is set in the generator, and when the number of Z-sweep points is larger than the number of scans set in History, the number of sweep points will be transferred from the generator to the "History" field.

Remote command:

`DISPlay:SWEEp<n2>:HISTory` on page 987

Show Min Max

Show Min Max

If the checkbox is activated, the Min/Max curves will be displayed.

The Min curve represents the lowest value of a measurement sequence and the Max curve the highest value. Recording of Min/Max values will be restarted each time the START key is pressed.

If Min/Max scans have already been recorded and measurement is stopped, the Min/Max curves can be hidden and shown by selecting and unselecting the checkbox.

A MIN/MAX display is also possible for graphic systems which do not have any scans (e.g. FFT Graph), i.e. a MIN scan and a MAX scan are recorded. The "Show Min Max" function is not available in the Waveform graphic system.

Available in the graphics subsystems

Sweep, FFT, Bar Graph, PESQ/POLQA, Impulse Response

The min/max curves are to be thought of as scans of a multiscan display. If "Show Min Max" is on, there is a single scan from three scans.

If a tracefile containing Min/Max scans is loaded with the following Y-source command files, then this checkmark is set automatically so that these scans are displayed in the graphic: Trace A Trace B

Remote command:

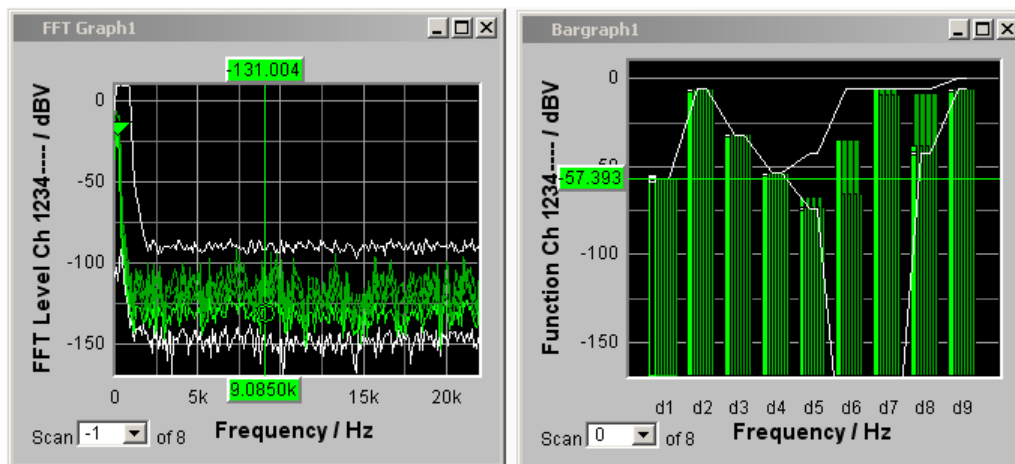
`DISPlay:SWEEp<n2>:MINMax` on page 987

Multi Ch Mode

Multi Ch Mode

This parameter field is offered for all 8-channel analyzer instruments in the FFT and Bargraph subsystems and allows 8 curves or bars to be displayed in **one** graphical window.

Upon activating this function, the "Channels" parameter field and the option for Trace B disappear in the corresponding Config panel. In the graphical window of the FFT, up to 8 curves are displayed above each other in the same color, in the graphical window of the bar graph display, the bars are shown with a slight offset. The display of the active channel is brightened. The cursor and marker settings refer to it. The active channel can be changed with the "Scan" combo box in the lower left corner of the graphical window. "Show Min/Max" is used to display the min and max values of **all** curves/bars in white. In addition to the measurement result source (Y-source), the left y-axis labeling shows the activated channels, e.g. FFT level **Ch 1234----** / dBV



Remote command:

[DISPlay:BARGraph<n2>:MCHMode](#) on page 988

[DISPlay:FFT<n2>:MCHMode](#) on page 988

Y-Source

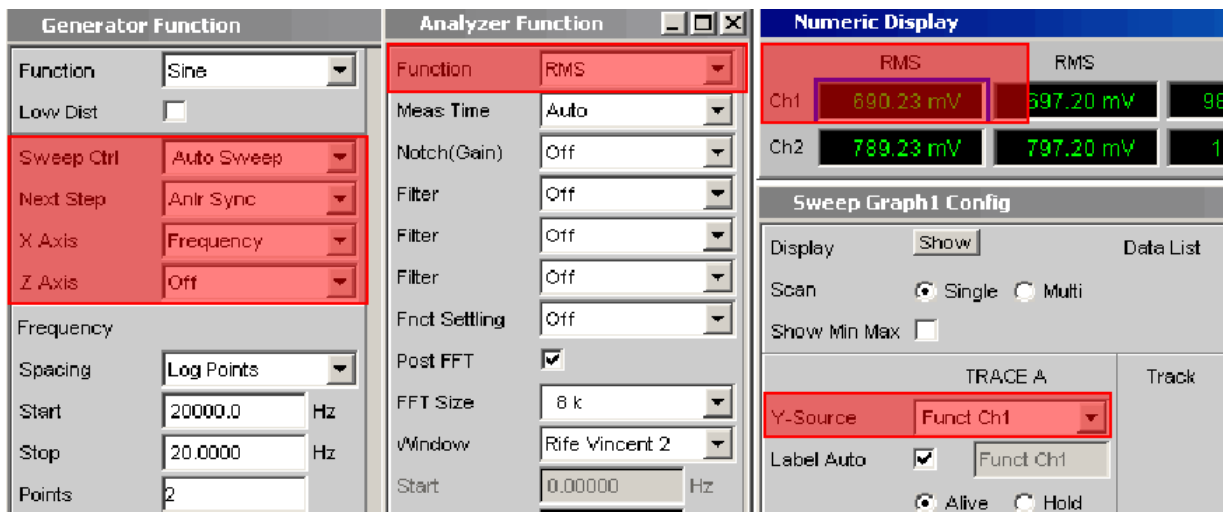
Sweep Graph graphic system



Used to select which sweep measurement results (obtained from one of the sweep functions listed below) are to be collected as TRACE A or as TRACE B and displayed graphically on the left-hand or right-hand y-axis.

Example:

The frequency response of a DUT is determined by means of a generator frequency sweep and the analyzer measurement function "RMS" and displayed in the Sweep Graph graphic system as Trace A.



For more information on Y Source, see [chapter 5.55, "Measured value Sequences"](#), on page 768. For displaying the traces, refer also to "X-axis" on page 350.

"Off" No trace is displayed or an available trace is deleted.

"Funct Chx, Function"

The **function** measurement result obtained by means of a generator sweep with the set analyzer measurement function for

- channel 1 or
- channel 2 or
- the channel number specified under the following "Channel" parameter field in the case of a multichannel instrument

is displayed as Trace A or Trace B over a basic physical quantity selected under x-axis.

The measurement result is displayed in the numeric display:

Numeric Display				
	RMS	Level RMS	Input Peak	Frequency
Ch1	-80.035 dBFS	-79.947 dBFS	-76.963 dBFS	5.7839 kHz
Ch2	-77.756 dBFS	-77.669 dBFS	-74.684 dBFS	5.7839 kHz

"Frequency Chx, Frequency"

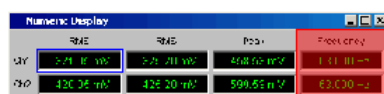
The **Frequency** measurement result for the additional Freq/Phase measurement function.

- channel 1 or
- channel 2 or
- the channel number specified under the following "Channel" parameter field in the case of a multichannel instrument



is displayed as Trace A or Trace B over a basic physical quantity selected under x-axis.

The measurement result is displayed in the numeric display:



"LevMon RMS Chx, LevMon RMS"

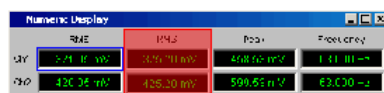
The **RMS** measurement result of the additional LevelMonitor = RMS measurement function for

- channel 1 or
- channel 2 or
- the channel number specified under the following "Channel" parameter field in the case of a multichannel instrument



is displayed as Trace A or Trace B over a basic physical quantity selected under x-axis.

The measurement result is displayed in the numeric display:



"LevMon DC Chx, LevMon DC"

The **DC** measurement result of the additional LevelMonitor = DC measurement function for

- channel 1 or
- channel 2 or
- the channel number specified under the following "Channel" parameter field in the case of a multichannel instrument



is displayed as Trace A or Trace B over a basic physical quantity selected under x-axis.

The measurement result is displayed in the numeric display:



"LevMon Peak Chx, LevMon Peak"

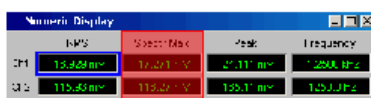
The **Peak** measurement result of the additional LevelMonitor = Peak measurement function for

- channel 1 or
- channel 2 or
- the channel number specified under the following "Channel" parameter field in the case of a multichannel instrument



is displayed as Trace A or Trace B over a basic physical quantity selected under x-axis.

The measurement result is displayed in the numeric display:



"Inp Peak Chx, Inp Peak"

The **Peak** measurement result of the additional InputMonitor = Peak measurement function for

- channel 1 or
- channel 2 or
- the channel number specified under the following "Channel" parameter field in the case of a multichannel instrument



is displayed as Trace A or Trace B over a basic physical quantity selected under x-axis.

The measurement result is displayed in the numeric display:



"Phase"

The **Phase** measurement result of the additional Freq/Phase = Freq & Phase measurement function

If you are using a multichannel instrument, set the channel reference by means of the following "Channel" parameter field.



is displayed as Trace A or Trace B over a basic physical quantity selected under x-axis.

The measurement result is displayed in the numeric display:



"Group Delay" The **Group Delay** measurement result of the additional measurement function.

Freq/Phase = Freq & Grp Del

If you are using a multichannel instrument, set the channel reference by means of the following "Channel" parameter field.



is displayed as Trace A or Trace B over a basic physical quantity selected under x-axis.

The measurement result is displayed in the numeric display:



"File: Trace A" Trace A is loaded from a file.

"

The file name is entered in the subsequent parameter field.

"File: Trace B" Trace B is loaded from a file.

The file name is entered in the subsequent parameter field.

Remote command:

[DISPlay:SWEEp<n2>:A:YSource](#) on page 986

[DISPlay:SWEEp<n2>:B:YSource](#) on page 986

Y-Source

FFT Graph graphic system



Used to select which measurement results obtained with the **FFT** or **Post FFT** analyzer measurement function are displayed graphically as TRACE A or as TRACE B.

Section of the Analyzer Function panel:



For more information on Y Source (see [chapter 5.55, "Measured value Sequences"](#), on page 768).

"Off" No trace is displayed or an available trace is deleted.

"FFT Level Chx, FFT Level"

Chx, FFT Level"

- channel 1 or
- channel 2 or
- the channel number specified under the following "Channel" parameter field in the case of a multichannel instrument

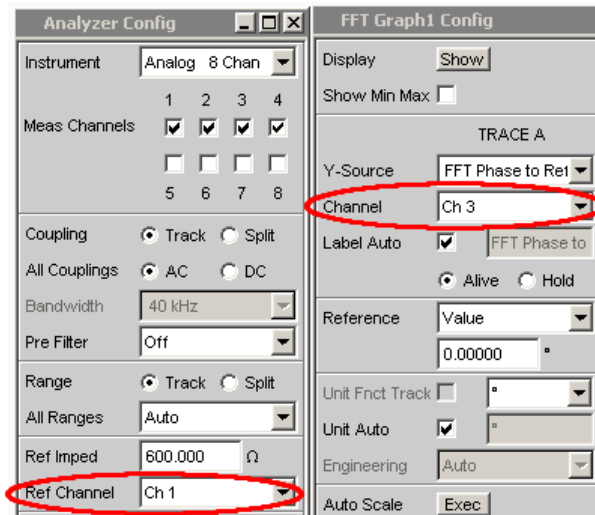
of the **FFT** or **Post FFT** analyzer measurement function is displayed as Trace A or Trace B over a frequency x-axis.

- "FFT Phase Chx, FFT Phase"
- The FFT phase is the phase characteristic versus the frequency of
- channel 1 or
 - channel 2 or
 - the channel number specified under the following "Channel" parameter field in the case of a multichannel instrument
- of the **FFT** or **Post FFT** analyzer measurement function which is displayed as Trace A or Trace B over a frequency x-axis.

"FFT Phase Ch2-Ch1, FFT Phase to Refch"

The phase **difference** between the phase characteristic obtained from the calculation of the complex FFT for

- channel 2 and channel 1
- the channel number specified under the following "Channel" parameter field and the reference channel specified in the "Ref Channel" parameter field in the Analyzer Config panel in the case of a multichannel instrument



of the **FFT** or **Post FFT** analyzer measurement function which is displayed as Trace A or Trace B over a frequency x-axis.

In contrast to a comparably slow frequency sweep with phase measurement, the phase measurement using FF provides very rapid phase measurement results.

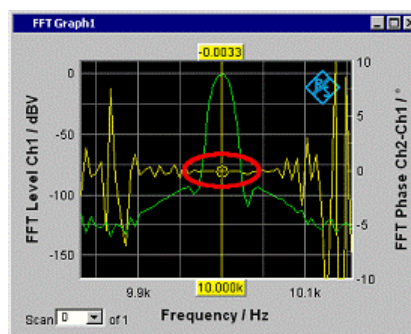


Fig. 5-40: The yellow trace shows the phase characteristic near the 10 kHz frequency line.

"File: Trace A "

Trace A is loaded from a file.

The file name is entered in the subsequent parameter field.

"File: Trace B"

Trace B is loaded from a file.

The file name is entered in the subsequent parameter field.

Remote command:

`DISPlay:FFT<n2>:A:YSource` on page 985

`DISPlay:FFT<n2>:B:YSource` on page 985

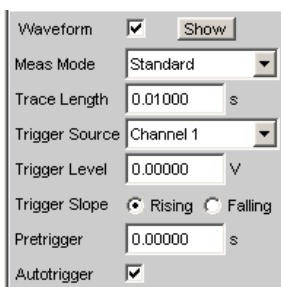
Y-Source

Waveform graphic system



Used to select which measurement results obtained with the additional measurement function **Waveform** are displayed graphically as TRACE A or as TRACE B and displayed graphically on the left-hand or right-hand y-axis.

Section of the Analyzer Function panel:



For more information on Y Source (see [chapter 5.55, "Measured value Sequences"](#), on page 768).

"Off" No trace is displayed or an available trace is deleted.

"Level Chx, Level"

The level measurement result for

- channel 1 or
- channel 2 or
- the channel number specified under the following "Channel" parameter field in the case of a multichannel instrument

of the Waveform measurement function is displayed as Trace A or Trace B over a time x-axis.

"File: Trace A "

Trace A is loaded from a file.

The file name is entered in the subsequent parameter field.

"File: Trace B" Trace B is loaded from a file.

The file name is entered in the subsequent parameter field.

Remote command:

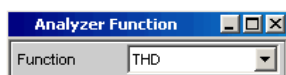
`DISPlay:WAVeform<n2>:A:YSource` on page 985

`DISPlay:WAVeform<n2>:B:YSource` on page 985

Y-Source**Bar Graph graphic system**

Used to select whether the measurement result for channel 1 or channel 2 from the analyzer measurement function THD, THD+N & SINAD, Mod Dist, DFD, DIM, Third Octave or 1/n Octave is to be obtained as TRACE A or as TRACE B and displayed graphically on the left-hand or right-hand y-axis.

Section of the Analyzer Function panel:



For more information on Y Source (see [chapter 5.55, "Measured value Sequences"](#), on page 768).

"Off" No trace is displayed or an available trace is deleted.

"Funct Chx, Function"

The function measurement result for

- channel 1 or
- channel 2 or
- the channel number specified under the following "Channel" parameter field in the case of a multichannel instrument

of the THD, THD+N & SINAD, Mod Dist, DFD and DIM analyzer measurement functions is displayed as Trace A or Trace B via a Third Octave or 1/n Octave that is not true to scale over a x-axis that is to scale.

"File: Trace A "

Trace A is loaded from a file.

The file name is entered in the subsequent parameter field.

"File: Trace B" Trace B is loaded from a file.

The file name is entered in the subsequent parameter field.

Remote command:

[DISPlay:BARGraph<n2>:A:YSource](#) on page 985

[DISPlay:BARGraph<n2>:B:YSource](#) on page 985

Y-Source**PESQ/POLQA graphical system**

Used to select which measurement results obtained with the additional measuring function **PESQ** or "POLQA" are collected as TRACE A or TRACE B and graphically displayed on the left or right y-axis.

PESC: Perceptual evaluation of speech quality

is a method for assessing the speech quality of transmission systems.

"Off" No trace is displayed or an available trace is deleted.

"PESQ & MOS"	<p>Function value of the PESQ_MOS or POLQA measurement. Depending on whether the measuring function PESQ or POLQA is set, a PESQ or MOS result is graphically displayed:</p> <p>MOS result MOS (mean opinion score) is described in the ITU Recommendation P.862.1 or P.862.2. All measurement results of the PESQ measurement of the settings identified with MOS... under "According to" in the Analyzer Function panel as well as the measurement result of the POLQA measuring function.</p> <p>PESQ result PESQ (perceptual evaluation of speech quality) is described in the ITU Recommendation P.862. All measurement results of the PESQ measurement of the settings identified with PESQ... under "According to" in the Analyzer Function panel.</p>
"Delay"	The delay measurement shows the time offset between the reference and the measurement signal. The signal is divided into a specific number of time intervals. Each time interval is displayed as a point, and all points taken together form a trace.
"Ref Signal"	Waveform of the signal output on the generator.
"Deg Signal"	Waveform of the measured signal in the resolution of the reference signal.
"Dropouts"	Measured dropouts displayed as if the difference between the reference signal and the time-corrected measurement signal would be displayed. This representation is rejected for the POLQA measurement.
"File: Trace A "	Trace A is loaded from a file. The file name is entered in the subsequent parameter field.
"File: Trace B "	Trace B is loaded from a file. The file name is entered in the subsequent parameter field.

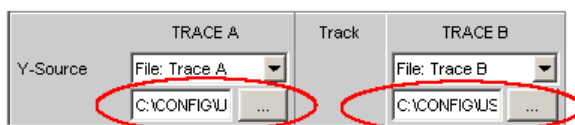
Remote command:

[DISPlay:PESQ<n2>:A:YSource](#) on page 986

[DISPlay:PESQ<n2>:B:YSource](#) on page 986

Trace File

All graphic systems



File name of the trace files to be loaded for parameter fields Y-Source = File: Trace A and/or File: Trace B.

If a file cannot be loaded because it does not match the current graphic system or is defective, "not loaded" is displayed.

If a trace file that contains Min/Max scans is loaded, "Show Min Max" is enabled automatically so that these scans are displayed in the graphic.

If files with different x-axes are loaded one after the other, the last file always determines the x-axis. If a sweep with a different x-axis is then loaded, it will determine the x-axis.

For file format, see [chapter 5.6.9, "Random"](#), on page 309.

Remote command:

[DISPlay:SWEEp<n2>:A:YSource:FILE](#) on page 986

[DISPlay:SWEEp<n2>:B:YSource:FILE](#) on page 986

Channel



Channel number for multichannel instrument

For multichannel instruments it is no longer possible to show the source of the measurement results and the channel numbers in a combined display, due to the large number of possible combinations in the selection list for the Y-source. The source of the measurement results (Y-Source) and the channel number (Channel) are therefore offered in separate parameter fields.

For "Y-Source = OFF", "File: Trace A" or "File: Trace B", a channel specification is meaningless and this parameter field is hidden.

Available in the graphics subsystems

Sweep, FFT, Waveform, Bar Graph, Impulse Response

"Ch1 to Ch8" Channel number 1 to 8

"Ch1 to Ch16" if the R&S UPV-B48 option is fitted two times.

Remote command:

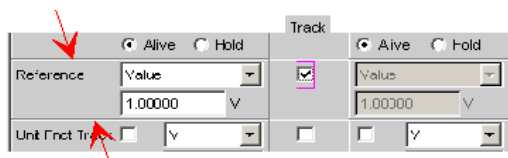
[DISPlay:SWEEp<n2>:A:CHANnel](#) on page 977

[DISPlay:SWEEp<n2>:B:CHANnel](#) on page 977

Track



If a checkbox is available in the "Track" column, the settings for the parameters concerned can be transferred from "TRACE A" to "TRACE B". The horizontal partition lines in the panel indicate the parameters for which tracking applies. Tracking capabilities are available for the "Reference", "Scaling" and "Limit" functions.



Available in the graphics subsystems

Sweep, FFT, Waveform, Bar Graph, PESQ/POLQA, Impulse Response

"activated" The contents of the parameter fields for "TRACE A" are transferred to "TRACE B". The parameter fields for "TRACE B" then appear grayed out and cannot be accessed.
Setting **changes** in "TRACE A" are immediately applied to "TRACE B".

Example:

"deactivated" The parameter fields for "TRACE A" and "TRACE B" can be accessed and changed separately.

Example:

Remote command:

[DISPlay:SWEEP<n2>:TRACk:LIMit](#) on page 988

[DISPlay:SWEEP<n2>:TRACk:REFerence](#) on page 989

[DISPlay:SWEEP<n2>:TRACk:SCALing](#) on page 989

Label Auto

This setting is for whether the label for the left (Trace A) or right (Trace B) y-axis is oriented on the setting in the "Y-Source" parameter field, or is freely configurable.

Available in the graphics subsystems

Sweep, FFT, Waveform, Bar Graph, PESQ/POLQA, Impulse Response

"activated"



The label (which is selected under TRACE A or Trace B), i.e. the name of the measurement result which is displayed as TRACE A or Trace B, is displayed dimmed (not accessible) in the text field to the right of the checkbox and also on the y-axis in the graphical display.



Fig. 5-41: Here rotated by 90°.

"deactivated"



A user-definable label appears on the y-axis of the graphical display.

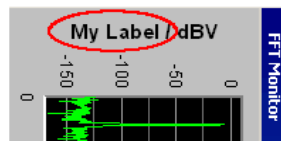


Fig. 5-42: Here rotated by 90°.

Remote command:

`DISPlay:SWEEp<n2>:A:LABel:AUTO` on page 978

`DISPlay:SWEEp<n2>:A:LABel:USER` on page 978

`DISPlay:SWEEp<n2>:B:LABel:AUTO` on page 978

`DISPlay:SWEEp<n2>:B:LABel:USER` on page 978

Alive / Hold



Available in all graphic subsystems

Used to enable or freeze the display of new measured values for Trace A or Trace B (refer also to [chapter 5.55, "Measured value Sequences"](#), on page 768).

"Alive" New measured values are displayed.

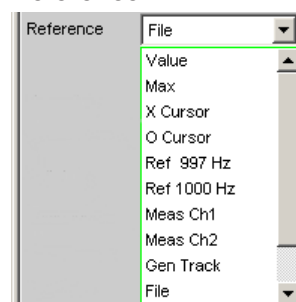
"Hold" The last trace remains in the display.

Remote command:

`DISPlay:SWEEp<n2>:A:UPDate` on page 985

`DISPlay:SWEEp<n2>:B:UPDate` on page 985

Reference



Used to select the reference for referenced units (e.g. dBr, V/Vr or Δ Hz) for Trace A or Trace B.

Can be a single integer value or a reference trace. The reference can be a sequence of measured values, the current generator frequency or voltage, or it can be loaded from a file (e.g. as a reference trace).

The reference value applies to all integer values in the trace, i.e. measured values, top, bottom and limit values, as well as to all scans of a trace. The same reference value thus applies to all scans.

The Reference parameter field is hidden if you select the function measurement result with Funct Ch1 | Funct Ch2 | Function under Y-source and if an intermodulation measurement is set in the analyzer function panel. Intermodulation measurement results are measurement results that have already been referenced and cannot be referenced again.

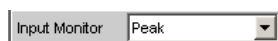
Available in the graphics subsystems

Sweep, FFT, Waveform, Bar Graph, Impulse Response

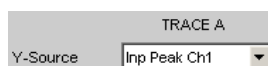
"Meas Panel" The reference value from the associated measurement function configuration panel is used.

Example:

The additional Input Monitor measurement function is activated in the analyzer panel:

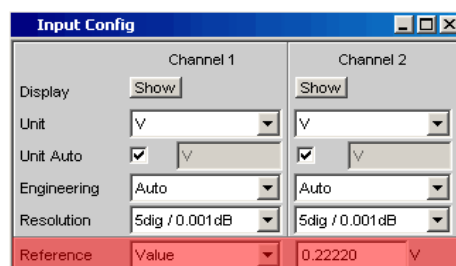


In the Sweep Graph1 graphic system, the result of the Input Peak measurement for channel 1 is selected as the source for Trace A:



The measurement results of the additional Input Monitor Peak measurement function are therefore plotted as Trace A on the Y1-axis.

In the Input Config panel, the reference value for the additional measurement function is set to 0.2222 V.



If Reference is now set to Meas Panel,



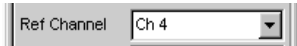
the reference value from the Input Config panel is entered here and used if **referenced units** are selected.

In the case of **referenced units**, this transfer of the reference value allows the comparison of measured values in the numerical display field or the combo display with measured values in the graphical display.

Available in the graphics subsystems

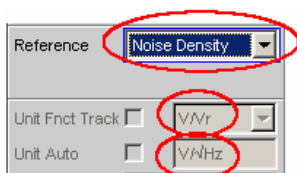
Sweep, FFT, Bar Graph

"Value " A numeric value with unit must be entered as the reference value in the parameter field below.

"Max "	The maximum Y value of the measurement sequence is actuated once as the reference value. The display then returns to Value and the maximum Y value is displayed as the new reference value in the parameter field below.
"X-Cursor"	The Y value of the * Cursor is actuated once as the reference value. The setting then returns to Value and the reference value is displayed in the subsequent parameter field.
"O Cursor"	The Y value of the O Cursor is actuated once as the reference value. The setting then returns to Value and the reference value is displayed in the subsequent parameter field.
"Ref 997 Hz"	The Y value at 997 Hz is actuated once as the reference value. The setting then returns to Value and the reference value is displayed in the subsequent parameter field. If the x-axis is not a frequency axis (e.g. in the case of level sweeps or waveform displays), an error message is displayed and the reference value remains unchanged.
"Ref 1000 Hz"	As for Ref 997 but with 1000 Hz
"Meas Ref Ch"	This option is only available for multichannel instruments. Every level measurement result of the channel specified in the Analyzer Config panel under Ref Channel
	
	is saved as a reference value. If a referenced unit is selected in the Unit parameter field, the measurement result is referenced to this variable reference value and displayed.
"Meas Ch1"	Moving reference value Every level measurement result for channel 1 is saved as reference value and used as a referenced display, provided a reference unit was selected. These options are only available for two-channel measurement.
"Meas Ch2"	As for Meas Ch1 but with channel 2
"Gen Track"	The reference trace is deleted and the currently applicable generator voltage, and then each newly set generator voltage, is used as the reference value.
"File"	The reference trace is loaded from a file. The file name is entered in the subsequent parameter field (see chapter 5.55, "Measured value Sequences" , on page 768). If Trace A is to be referenced, then the Trace A from the specified reference file is used; if Trace B is to be referenced, then Trace B is used. An error message occurs if the necessary reference trace is not present in the file.
"File Intern"	"File Intern" has to be offered and displayed only if "File:Trace A or File: Trace B is set at "Y-Source" and a trace file containing a reference value scan in addition to the data scan is loaded.

"Noise Density, Noise Density dB"

Noise density measurement.
 Offered only in the FFT subsystem.
 If you perform an FFT analysis via a noise signal, the level of a bin will change with respect to its width. The width of a bin, which is also called analysis bandwidth, depends on the FFT size. Thus, the level of a bin changes with respect to the FFT size.
 To relativize this effect, i.e. to become independent of the actual analysis bandwidth, you calculate the noise density. This is the noise power that would occur in an intended analysis bandwidth of 1 Hz.
 The noise density depends on the FFT window. When calculating the noise density, the set window is taken into consideration to eliminate the effect of the window.
 Thus, the noise-density measurement is not an independent measurement function but a referenced level display, based on the relative unit V/Vr.



Depending on the selection "Noise Density" or "Noise Density dB", the FFT graphic displays the result in the unit $V/\sqrt{\text{Hz}}$ or $\text{dBV}/\sqrt{\text{Hz}}$.

"Hold"

No further changes are made to the reference value or reference trace. If a trace file having a reference value or reference trace is loaded, the reference values from the file have no effect, and the reference value or reference trace last set is used.
 If a floating reference value (Meas Ch1, Meas Ch2 or Gen Track) was set before the switchover to "Hold", this reference trace is used.
 If "Hold" is selected in the absence of any valid reference trace data, a warning is issued and the last chosen valid reference is set again.

Remote command:

`DISPlay:SWEEp<n2>:A:REFerence` on page 983

`DISPlay:SWEEp<n2>:B:REFerence` on page 983

Reference Value



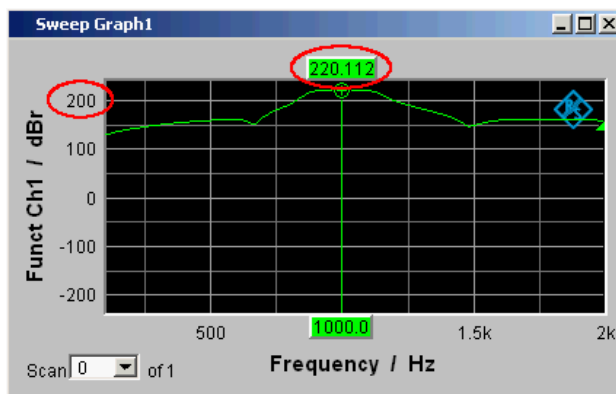
Reference value with unit for the reference parameter Value.

Regardless of the graphic system, the value range allows the value 0 V or negative values to be entered. A reference value of 0 V or a negative reference value makes good sense for display units, such as ΔV or ΔW , but causes problems in the case of logarithmic units such as dBr and in the case of units that have the reference value in the denominator, such as V/Vr .

To get round these problems, a reference value around 0.0 (or more exactly: between $-1.0E-12$ and $1.0E-12$) is always computed using the value $1.0E-12$.

Negative reference values $< -1.0E-12$ are computed using their magnitude, that is, they are made into positive values.

As a result, trace displays in the referenced unit dBr, for instance, at a reference value of 0.0 V have very high values for the upper limit, since the trace data is computed internally using the reference value $1.0E-12$.



Available in the graphics subsystems

Sweep, FFT, Waveform, Bar Graph, Impulse Response

Remote command:

[DISPlay:SWEEp<n2>:A:REFerence:VALue](#) on page 983

[DISPlay:SWEEp<n2>:B:REFerence:VALue](#) on page 983

Reference File



File name for the reference parameter File.

Available in the graphics subsystems

Sweep, FFT, Waveform, Bar Graph

Remote command:

[DISPlay:SWEEp<n2>:A:REFerence:FILE](#) on page 983

[DISPlay:SWEEp<n2>:B:REFerence:FILE](#) on page 983

Normalize



If a referenced unit (e.g. dBr or V/Vr) and a floating reference value, as in Reference = Meas Ch1, Meas Ch2, Gen Track, or a reference trace held in a file, as in "File" or "File Intern", are used, the displayed trace is normalized with the aid of the above by shifting the whole curve, that is, multiplying it by the normalization value.

The normalization value is transferred to all scan data sets; the same normalization value therefore applies to all scans.

The "Normalize" parameter field is hidden if you select the function measurement result with Funct Ch1 | Funct Ch2 | Function under Y-source and if an intermodulation measurement is set in the analyzer function panel. Intermodulation measurement results are measurement results that have already been referenced and cannot be referenced again.

Available in the graphics subsystems

Sweep, FFT, Bar Graph

"OFF"	Normalization is deactivated.
"Value "	Fixed normalization value which is entered as a multiplication factor or a dB value in the parameter field below.
"O Cursor"	The trace is normalized once only at the o cursor to 0 dBr or $V/V_r = 1$. For this purpose, the referenced trace value is read out and the reciprocal value is entered in the parameter field below. The parameter then changes back to VALUE.
"X-Cursor"	As for the o cursor.

Remote command:

[DISPlay:SWEEp<n2>:A:NORMAlize](#) on page 982

[DISPlay:SWEEp<n2>:B:NORMAlize](#) on page 982

Normalize Value

Used to enter a fixed normalization value as a factor. This value applies to all scans.

Available in the graphics subsystems

Sweep, FFT, Bar Graph

Remote command:

[DISPlay:SWEEp<n2>:A:NORMAlize:VALue](#) on page 982

[DISPlay:SWEEp<n2>:B:NORMAlize:VALue](#) on page 982

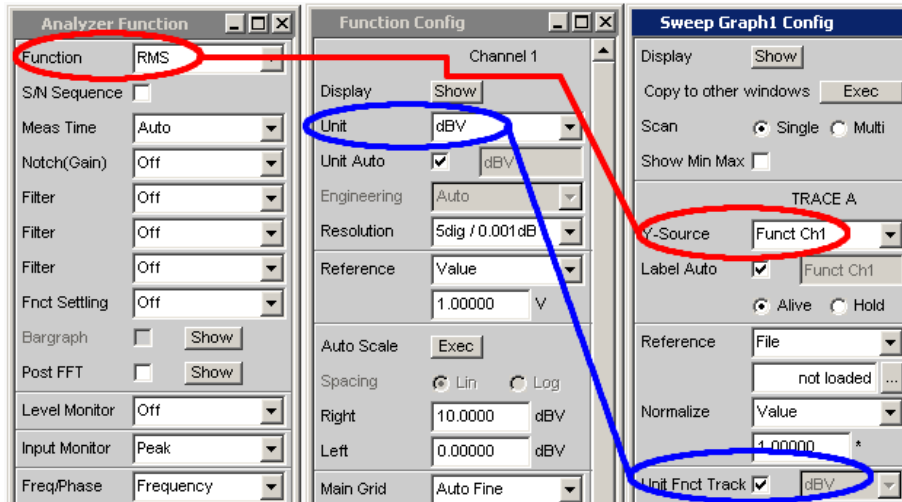
Unit Fnct Track

Used to determine whether the unit is the same as that set in the analyzer or whether it can be user-selected. This parameter field is displayed only for graphics systems that are referenced to the measurement function in the analyzer and whose display unit can be set in the corresponding Config panel.

Example:

In the sweep subsystem, "y-source" is set to "Funct Ch1".

In the Analyzer panel, RMS has been set as measurement function for which dBV has been selected as the unit in the Function Config panel.



The dBV display unit for the RMS measurement function can be transferred to the Display panel which is indicated by the "Unit Fcn Track" checkboxes.

Example:

For the additional measurement function Waveform, there is no individually assigned unit that may be set in a Config panel. Thus, no unit can be transferred from the analyzer for the Waveform graphics subsystem and the checkboxes for "Unit Fcn Track" are not offered here.

Available in the graphics subsystems

Sweep, FFT, Bar Graph

"activated"



The unit selected in the analyzer is used for the measurement data displayed on the y-axis and for the displayed top, bottom and limit values.

It is displayed in gray (cannot be accessed) next to the checkbox and also on the y-axis of the graphical display.

If a logarithmic unit (dBU, dBV, dBr, dBm, dBFS or dBUI) appears here, the parameter field below (Spacing) cannot be accessed and its parameter is set to Lin (it would be pointless to display measured values with a logarithmic unit on an axis with logarithmic spacing).



Fig. 5-43: Here rotated by 90°.

The unit which appears here depends on the parameter selected under Trace A or Trace B, e.g. Level Ch1, Phase Ch1 and on the analyzer instrument, e.g. "Analog" or Digital Audio.

In the event of changing between similar units (e.g. dBU, dBV, dBr, or dBr), a new value is computed for the subsequent parameter fields "Top", "Bottom", "Main Grid Steps", "Limit Lower Value", "Limit Upper Value", "Limit Shift Parallel", "Limit Shift Symmetrical"; in the event of changing between different units (e.g. dBV, W), a value entered earlier is retrieved.

"deactivated"



The unit can be user-selected from the list of available parameters. If a logarithmic unit (dBU, dBV, dBr, dBm, dBFS or dBUI) is selected here, the parameter field below (Spacing) cannot be accessed and its parameter is set to Lin (it would be pointless to display measured values with a logarithmic unit on an axis with logarithmic spacing).

Remote command:

[DISPlay:SWEEp<n2>:A:UNIT:TRACk](#) on page 985

[DISPlay:SWEEp<n2>:B:UNIT:TRACk](#) on page 985

Unit



This parameter field without the "Unit Fcnct Track" is displayed only for the graphic system Waveform, since this additional measurement function is independent of a function setting in the analyzer and even delivers measurement results when the measurement function is turned off. Therefore tracking the unit of the measurement function is meaningless.

The list of units offered at this point is dependent on whether the analog or digital analyzer is selected and in the digital case, on whether the Meas Mode = Audio Data, Jitter/Phase and Common/Input. The unit can be user-selected from the parameter list.

If a logarithmic unit (dBu, dBV, dBr, dBm, dBFS, dBUI) is selected, or a linear unit in which negative numbers can occur (e.g. ΔV , ΔW), the following parameter field Spacing is displayed as not user-accessible and its parameter is set to Lin since it makes no sense to display measured values with a logarithmic unit or negative values on a logarithmically scaled axis.

In the event of changing between similar units (e.g. dBu, dBV, dBm, dBr), a new value is computed for the following parameter fields

"Top", "Bottom",

"Main Grid Steps",

"Limit Lower Value", "Limit Upper Value",

"Limit Shift Parallel", "Limit Shift Symmetrical";

in the event of changing between different units (e.g. dBV, W), a value entered earlier is retrieved.

Available in the graphics subsystems

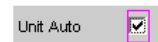
Sweep, FFT, Waveform, Bar Graph, Impulse Response

Remote command:

[DISPlay:SWEEp<n2>:A:UNIT](#) on page 984

[DISPlay:SWEEp<n2>:B:UNIT](#) on page 984

Unit Auto



Used to determine whether the unit label displayed on the y-axis for Trace A or Trace B is the same as the unit set in the "Unit Funct Track" or "Unit" parameter field or whether it can be user-selected.

Available in the graphics subsystems

Sweep, FFT, Waveform, Bar Graph, Impulse Response

"activated"



Used to determine whether the unit label displayed on the y-axis for Trace A or Trace B is the same as the unit set in the Unit Funct Track or Unit parameter fields and are therefore generated automatically by the R&S UPV.

"deactivated"



A user-defined unit label can be entered.

Example:

The output level $U_{0\text{dBspl}}$ which is output at a sound pressure of 0 dBspl (spl = sound pressure level) is specified for high-quality microphones.

If the measured microphone output level is displayed in the referenced unit dBr and entered for the reference value $U_{0\text{dBspl}}$, the level displayed on the R&S UPV will be in dBr, but corresponds to the sound pressure in dBspl. An axis labeling using the unit dBspl would be desirable in the graphical display. To allow this, the unit label can be changed from dBr to dBspl.

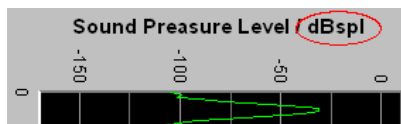


Fig. 5-44: Here rotated by 90°.

Remote command:

[DISPlay:SWEEP<n2>:A:UNIT:AUTO](#) on page 984

[DISPlay:SWEEP<n2>:B:UNIT:AUTO](#) on page 984

Unit User String



User-defined unit designation if Unit Auto is not selected.

The specified designation appears on the y-axis label instead of the usual units.

Available in the graphics subsystems

Sweep, FFT, Waveform, Bar Graph, Impulse Response

Remote command:

[DISPlay:SWEEP<n2>:A:UNIT:USER](#) on page 985

[DISPlay:SWEEP<n2>:B:UNIT:USER](#) on page 985

Engineering



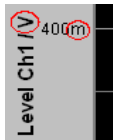
Conversion of the Trace A- or Trace B-related cursor and scaling values in the graphical display by a factor of 1000.

This parameter field cannot be accessed if a dB or % unit is selected in the "Unit Funct Track" or "Unit" parameter field above since these units do not have an engineering function.

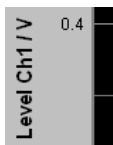
Available in the graphics subsystems

Sweep, FFT, Waveform, Bar Graph, Impulse Response

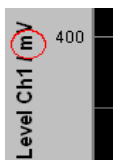
"Auto" Automatic engineering assignment from p to M. The cursor and scaling values are displayed **with** the engineering symbol. The y-axis is labeled with the unit **without** engineering.



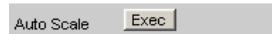
"Off" Engineering is deactivated. Values are always displayed at 1.0 E⁰



"μ, m, k" Engineering fixed to μ, m or k. The cursor and scaling values are displayed **without** the engineering symbol. The y-axis is labeled **with** Engineering **and** the unit.



Auto Scale



One-off automatic scaling of the y-axes for Trace A or Trace B.

Available in the graphics subsystems

Sweep, FFT, Waveform, Bar Graph, PESQ/POLQA, Impulse Response

"Exec" Pressing this button triggers a **one time** scaling process which uses the minimum and maximum values of the existing measurement sequence for Trace A or Trace B. The end values of the new scaling are approx. 5% less or greater than the exact values. The determined values are entered in the Top and Bottom parameter fields below. If the "Track" checkbox is enabled for this range, then using "Exec" causes automatic scaling of both y-axes in Trace A, taking the highest maximum value and the lowest minimum value of **both** traces into account. If the Min/Max curves are switched on, these are used for the autoscaling.

Spacing



Linear or logarithmic spacing of the y-axis for Trace A or Trace B.

For logarithmic units (dB units) and linear units in which negative numbers can occur (e.g. ΔV , ΔW), this parameter field is displayed as not user-accessible and is set to "Lin", since it makes no sense / is not possible to display dB values or negative values logarithmically.

Available in the graphics subsystems

Sweep, FFT, Waveform, Bar Graph, PESQ/POLQA, Impulse Response

"Lin"	Linear spacing of the y-axis. If a logarithmic unit (dB unit) has been selected in the "Unit Fnc Track" line, this line is displayed as not user-accessible and its parameter is set to "Lin", since it would be pointless to display measured values with a logarithmic unit on an axis with logarithmic spacing.
"Log"	Logarithmic spacing of the y-axis. This parameter is available only if a linear unit whose value range cannot contain any negative numbers (e.g. V, W, etc.) has been selected in the "Unit Fnc Track" parameter field.

Example:

Although ΔV is a linear unit, the measurement results can be negative, which means that logarithmic display is not possible.

Remote command:

[DISPlay:SWEEp<n2>:A:SPACing](#) on page 984

[DISPlay:SWEEp<n2>:B:SPACing](#) on page 984

Top



Used to set the top value of the y-axis for Trace A or Trace B

If Auto Scale has been triggered, the value is reset on the basis of the current trace data.

Negative values or the value 0.00000 are not permitted if Spacing = Log.

Available in the graphics subsystems

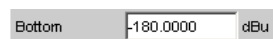
Sweep, FFT, Waveform, Bar Graph, PESQ/POLQA, Impulse Response

Remote command:

[DISPlay:SWEEp<n2>:A:TOP](#) on page 984

[DISPlay:SWEEp<n2>:B:TOP](#) on page 984

Bottom



Used to set the bottom value of the y-axis for Trace A or Trace B

If Auto Scale has been triggered, the value is reset on the basis of the current trace data.

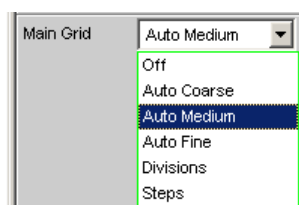
This value must always be lower than the top value.

Negative values or the value 0.0000 are not permitted if Spacing = Log.

Available in the graphics subsystems

Sweep, FFT, Waveform, Bar Graph, PESQ/POLQA, Impulse Response

Remote command:

[DISPlay:SWEEp<n2>:A:BOTTom](#) on page 977[DISPlay:SWEEp<n2>:B:BOTTom](#) on page 977**Main Grid**

Division of the graphical display with horizontal main gridlines.

Available in the graphics subsystems

Sweep, FFT, Waveform, Bar Graph, PESQ/POLQA, Impulse Response

"Off" No main gridlines are used in the graphical display.

"On" With the setting Spacing = Log:
Decadic division of a **logarithmically** divided y-axis with the aid of main gridlines.

"Auto Coarse, Auto Medium, Auto Fine"

Only selectable with the setting Spacing = Lin:

Coarse, medium or fine division of a y-axis with main gridlines. One or two, 3 or 4, 8 or 9 main gridlines are displayed depending on the scale end values.

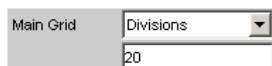
Main gridlines may be **hidden** if the graphical window is reduced in size.

"Divisions" Only selectable with the setting Spacing = Lin:
Preset division of a y-axis with main gridlines.
The desired number of divisions is set in the parameter field below.
These main gridlines are **not** hidden if the graphical window is reduced in size!

"Steps" Only selectable with the setting Spacing = Lin:
Preset division of a y-axis in a fixed step size.
The step size is set in the parameter field below.
These main gridlines are **not** hidden if the graphical window is reduced in size!

Division

With the setting Spacing = Lin:



Used to enter the number of main gridline divisions for a y-axis (setting Spacing = Lin) linearly divided by main grid lines.

If, for example, 2 is entered, the y-axis is divided into **two sections**, i.e. **one** main gridline is displayed.

Available in the graphics subsystems

Sweep, FFT, Waveform, Bar Graph, PESQ/POLQA, Impulse Response

Steps

With the setting Spacing = Lin:



Used to enter the main gridline step size for a y-axis.

Available in the graphics subsystems

Sweep, FFT, Waveform, Bar Graph, PESQ/POLQA, Impulse Response

Sub Grid

Subdivision of the main gridlines in a graphical display using subgridlines.

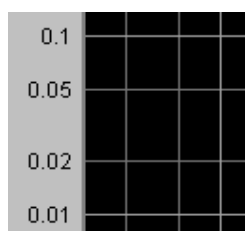
Available in the graphics subsystems

Sweep, FFT, Waveform, Bar Graph, PESQ/POLQA, Impulse Response

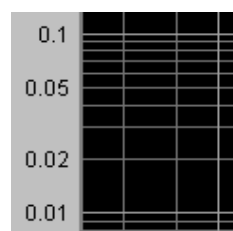
"Off" Subgridlines are deactivated.

"2, 4, 5 " With the setting Spacing = Lin:
 Subdivision of the main gridlines of a y-axis into 2, 4 or 5 sections.
 If, for example, 2 is selected, the area between two main gridlines is divided into **2** sections, i.e. **one** subgridline appears between the main gridlines.
 These subgridlines are **not** hidden if the graphical window is reduced in size!

"Coarse , Fine " With the setting Spacing = Log:
 Coarse or fine subdivision of the main gridlines of a y-axis with subgridlines.



Coarse: Only Subgridlines 2 and 5



Fine: All subgridlines

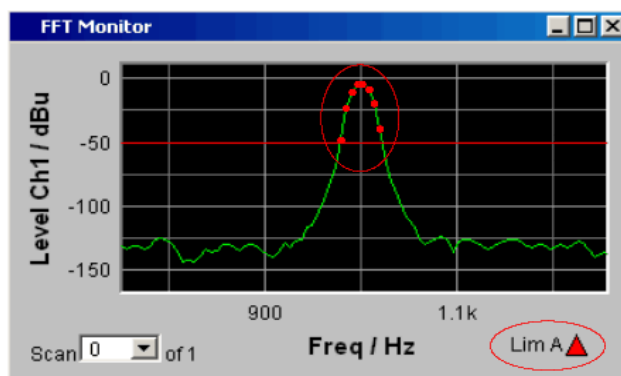
Limit Upper



It is possible to define for a measurement an upper limit / limit curve, such that each measured value is compared with the upper limit or limit curve. The limit / limit curve is plotted in red in the coordinate system of the graphical display.

Limit violations are marked by red dots on a curve or by red bars on a bar graph.

An additional display in the bottom right corner of the graphical display with an arrow pointing **upward** marks the **overranging** of the upper limit or limit line.



See [chapter 5.51.1, "Graphical Display, Explanation of the Elements"](#), on page 735 for the meaning of the limit violation symbols.

Pressing the START key causes the existing limit overranging to be reset and new violations to be recorded.

Available in the graphics subsystems

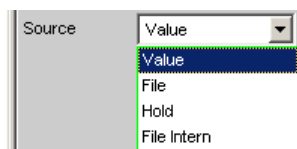
Sweep, FFT, Waveform, Bar Graph, PESQ/POLQA, Impulse Response

Remote command:

[DISPlay:SWEEp<n2>:A:LIMUpper](#) on page 981

[DISPlay:SWEEp<n2>:B:LIMUpper](#) on page 981

Source



Used to determine how the upper limit is set.

"Value "



Available in the graphics subsystems

Sweep, FFT, Waveform, Bar Graph, PESQ/POLQA, Impulse Response

Input of a fixed limit value for the Source = Value setting.

In the parameter field below, an upper limit constant for all X values is entered in the unit which has been selected in the Unit Funct Track parameter field. If a relative unit is selected, the associated reference value (a few parameter fields higher up) is used.

All scans of a trace (except the Min/Max scans) are compared to this common limit and the limit violations are marked.

"File"



Available in the graphics subsystems

Sweep, FFT, Waveform, Bar Graph, PESQ/POLQA, Impulse Response

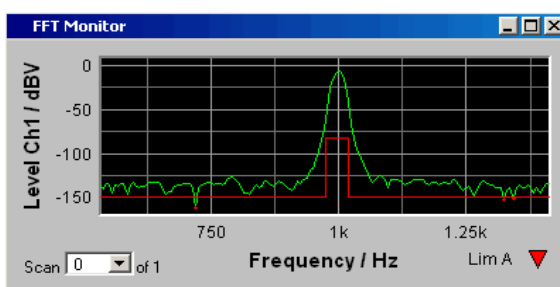
Limits are checked by using a limit file.

The name of the limit file is entered in the parameter field below.

This limit file contains reference values for a limit curve in a special format (see [chapter 5.58.4, "Limit Files"](#), on page 786).

Each new scan interpolates the entries in the limit file to the X values of the scan.

All scans of a trace (except the Min/Max scans) are compared to this common limit curve and the limit violations are marked.



"File Intern"

Available in the graphics subsystems

Sweep, FFT, Waveform, Bar Graph, PESQ/POLQA, Impulse Response

"File Intern" is provided and displayed only if "File: Trace A or File: Trace B is set at "Y-Source" and a trace file is loaded that contains a limit scan in addition to the data scans.

The Limit Upper curve from the trace file is displayed in the graph and all scans are compared to this limit curve (except the Min/Max scans).

"Hold"

Available in the graphics subsystems

Sweep, FFT, Waveform, Bar Graph, PESQ/POLQA, Impulse Response

Sweep, FFT, Waveform, Bar Graph

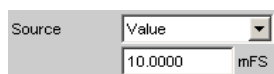
The limit value or limit trace is no longer changed. If a trace file is loaded with limit value or limit trace, the limit values from the file are not applied but instead the previously set limit value or limit trace is used. If "Hold" is selected when no valid limit trace data is already available, a warning is issued and the last valid Limit selection is reset.

Remote command:

[DISPlay:SWEEp<n2>:A:LIMUpper:SOURce](#) on page 981

[DISPlay:SWEEp<n2>:B:LIMUpper:SOURce](#) on page 981

Source Value



Upper limit value if "Value" has been selected under "Source".

Available in the graphics subsystems

Sweep, FFT, Waveform, Bar Graph, PESQ/POLQA, Impulse Response

Remote command:

[DISPlay:SWEEp<n2>:A:LIMUpper:SOURce:VALue](#) on page 982[DISPlay:SWEEp<n2>:B:LIMUpper:SOURce:VALue](#) on page 982**Source Filename**

File name for an upper limit curve if "File" has been selected under "Source".

Available in the graphics subsystems

Sweep, FFT, Waveform, Bar Graph, PESQ/POLQA, Impulse Response

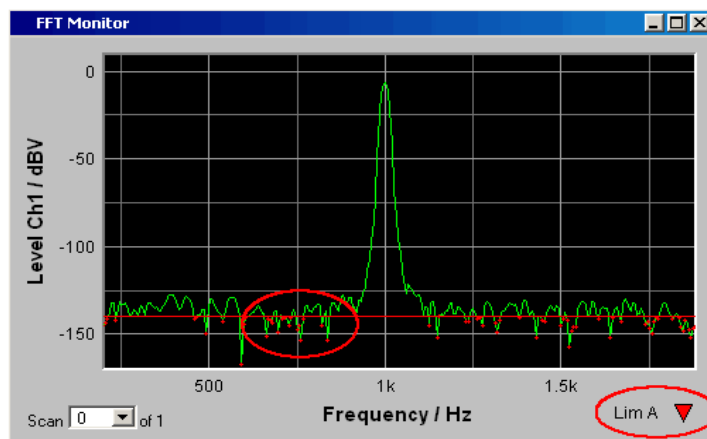
Remote command:

[DISPlay:SWEEp<n2>:A:LIMUpper:SOURce:FILE](#) on page 982[DISPlay:SWEEp<n2>:B:LIMUpper:SOURce:FILE](#) on page 982**Limit Lower**

A lower limit / limit curve can be defined for the measurement, whereby each measured value is compared with the limit / limit curve. The limit / limit curve is plotted in red in the coordinate system of the graphical display.

Limit violations are marked by red dots on a curve or by red bars on a bar graph.

An additional display in the bottom right corner of the graphical display with an arrow pointing **downward** marks the **underranging** of the lower limit or limit line.



Pressing the START key causes the existing limit underranging to be reset and new violations to be recorded.

Available in the graphics subsystems

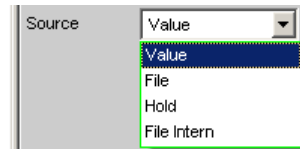
Sweep, FFT, Waveform, Bar Graph, PESQ/POLQA, Impulse Response

Remote command:

DISPlay:SWEEp<n2>:A:LIMLower on page 979

DISPlay:SWEEp<n2>:B:LIMLower on page 979

Source

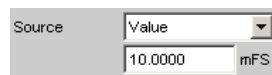


Used to determine how the lower limit is set.

"Value "

Available in the graphics subsystems

Sweep, FFT, Waveform, Bar Graph, PESQ/POLQA, Impulse Response

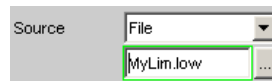


Input of a fixed limit value for the Source = Value setting. In the parameter field below, a lower limit constant for all X values is entered in the unit which has been selected in the Unit Funct Track parameter field. If a relative unit is selected, the associated reference value (a few parameter fields higher up) is used. All scans of a trace are compared to this common limit and the limit violations are marked.

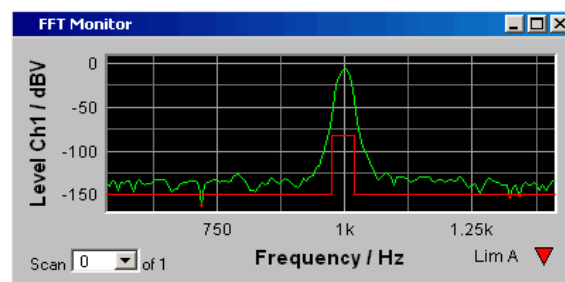
"File"

Available in the graphics subsystems

Sweep, FFT, Bar Graph, PESQ/POLQA, Impulse Response



Available to all graphic systems except Waveform. Limits are checked by using a limit file. The name of the limit file is entered in the parameter field below. This limit file contains reference values for a limit curve in a special format (see chapter 5.58.4, "Limit Files", on page 786). Each new scan interpolates the entries in the limit file to the X values of the scan. All scans of a trace are compared to this common limit curve and the limit violations are marked.



"File Intern"

Available in the graphics subsystems

Sweep, FFT, Bar Graph, PESQ/POLQA, Impulse Response
Sweep, FFT, Bar Graph, PESQ/POLQA, Impulse Response
Sweep, FFT, Bar Graph

"File Intern" has to be offered and displayed only if "File:Trace A or File: Trace B is set at "Y-Source" and a trace file containing limit scans in addition to the data scans is loaded.

The Limit Lower curve from the trace file is displayed in the graph and all scans (except the Min/Max scans) are compared to this limit curve.

"Hold"

Available in the graphics subsystems

Sweep, FFT, Waveform, Bar Graph, PESQ/POLQA, Impulse Response

The limit value or limit trace is no longer changed. If a trace file is loaded with limit value or limit trace, the limit values from the file are not applied but instead the previously set limit value or limit trace is used. If "Hold" is selected when no valid limit trace data is already available, a warning is issued and the last valid Limit selection is reset.

Remote command:

[DISPlay:SWEEp<n2>:A:LIMLower:SOURce](#) on page 979

[DISPlay:SWEEp<n2>:B:LIMLower:SOURce](#) on page 979

Source Value



Lower limit value if "Value" has been selected under "Source".

Available in the graphics subsystems

Sweep, FFT, Waveform, Bar Graph, PESQ/POLQA, Impulse Response

Remote command:

[DISPlay:SWEEp<n2>:A:LIMLower:SOURce:VALue](#) on page 980

[DISPlay:SWEEp<n2>:B:LIMLower:SOURce:VALue](#) on page 980

Source Filename



Filename for a lower limit curve if "File" has been selected under "Source".

Available in the graphics subsystems

Sweep, FFT, Bar Graph, PESQ/POLQA, Impulse Response

Sweep, FFT, Bar Graph, PESQ/POLQA, Impulse Response

Sweep, FFT, Bar Graph

Remote command:

[DISPlay:SWEEp<n2>:A:LIMLower:SOURce:FILE](#) on page 980

[DISPlay:SWEEp<n2>:B:LIMLower:SOURce:FILE](#) on page 980

Limit Shift

Limit Shift

This enables limit lines or limit curves to be shifted according to the parameters in the subsequent parameter fields "Parallel" and "Symmetrical".

If the Limit Shift function is enabled without activating limit monitoring, the subsequent parameter fields should be regarded as default settings.

Available in the graphics subsystems

Sweep, FFT, Waveform, Bar Graph, Impulse Response

Remote command:

`DISPlay:SWEEp<n2>:A:LIMShift` on page 980

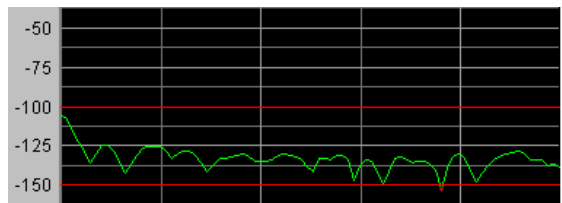
`DISPlay:SWEEp<n2>:B:LIMShift` on page 980

Parallel

This enables limit lines or limit curves to be parallel shifted.

In this way limit curves derived from a "golden unit", for example, can be adapted very easily to new circumstances

Parallel dBV



The limit lines, which were determined using -100 dBV and -150 dBV, are to be parallel shifted by a value of 25 dBV to -75 dBV and -125 dBV.

Parallel dBV



Available in the graphics subsystems

Sweep, FFT, Waveform, Bar Graph, Impulse Response

Sweep, FFT, Waveform, Bar Graph, Impulse Response

Sweep, FFT, Waveform, Bar Graph

Remote command:

`DISPlay:SWEEp<n2>:A:LIMShift:PARallel` on page 980

`DISPlay:SWEEp<n2>:B:LIMShift:PARallel` on page 980

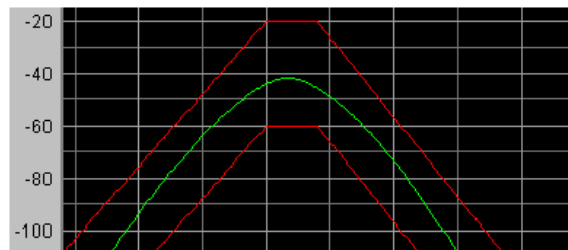
Symmetrical

This enables a tolerance band formed from two limit lines or limit curves to be made broader or narrower

In this way a tolerance band derived from a "golden unit", for example, can be very easily narrowed or broadened.

Although a single limit curve may be symmetrically shifted it is not very meaningful, and would be better done using the "Parallel" parameter field.

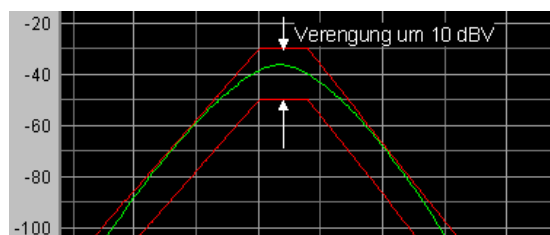
Symmetrical 0.00000 dBV



The limit curves that are separated by 40 dBV, such as after loading a file, are **in each case** to be shifted by 10 dBV

Symmetrical 10.0000 dBV

and their signs are to be reversed. This produces a symmetrical shift in both curves. Following the symmetrical shift, the two curves have a separation of only 20 dBV.



Available in the graphics subsystems

Sweep, FFT, Waveform, Bar Graph, Impulse Response

Sweep, FFT, Waveform, Bar Graph, Impulse Response

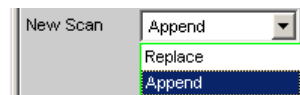
Sweep, FFT, Waveform, Bar Graph

Remote command:

[DISPlay:SWEEp<n2>:A:LIMShift:SYMMetrical](#) on page 981

[DISPlay:SWEEp<n2>:B:LIMShift:SYMMetrical](#) on page 981

New scan



This parameter field appears only for graphic systems that allow multiscans ("Scan" = "Multi"), and is therefore only available for Sweep Graph 1 to 4 graphic systems.

Available in the graphics subsystems

Sweep

"Replace" means that a selected scan of the current trace will be replaced.

"Append" means that a selected scan will be appended to the current trace.

Here it is irrelevant whether the scan originates from a **measurement** or is imported from a trace file specified in the "Import from" parameter field below.

See [chapter 5.55, "Measured value Sequences"](#), on page 768).

"Replace"	Replace. The scan (selected using NEXT SCAN or by means of the scan number in the graphical display) is replaced by the scan from a measurement or from the trace file specified in the "Import from" parameter field below.
"Append"	The scans from a measurement or from the trace file specified in the "Import from" parameter field below are appended to the current trace.

Import from



This parameter field appears only for graphic systems that allow multiscans ("Scan" = "Multi"), and is therefore available to the following graphic system:

Available in the graphics subsystems

Sweep

It is used to enter the name of a trace file whose scans are to replace a current scan or are to be appended to the current trace.

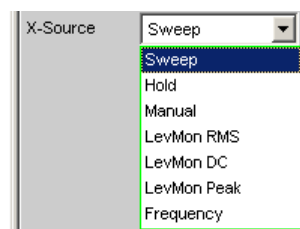
Whether scans are to be replaced or appended is determined in the "New scan" parameter field above:

Replace: "New scan" = "Replace"

Append: "New scan" = "Append"

See [chapter 5.55, "Measured value Sequences"](#), on page 768).

X-Source



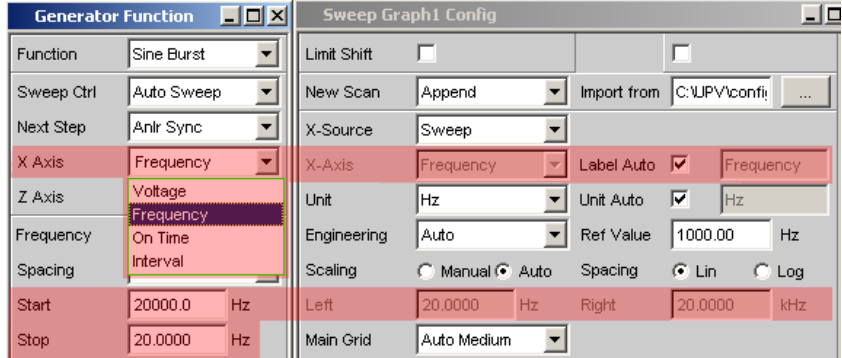
Determines the response of the following x axis parameter field.

Available in the graphics subsystems

Sweep

"Sweep "

The following x-axis parameter field is not available in a sweep that is switched on in the Generator Function panel; as a result, the x-axis in the DispConfig panel sweep is adapted to the x-axis sweep setting in the generator automatically.



The sweep is turned off in the generator



the x-axis parameter field is operable and the user can select the functionality.

When the "x-source " in the display panel is set to "Sweep ", and when a z-sweep is set in the generator, and when the number of z-sweep points in the generator is larger than the number of scans set in History, the number of sweep points from the generator will be entered in the History field.

"Hold"

The "x-axis " is displayed as not operable. The x-axis retains the current setting at the time of the switchover to "Hold " and helps prevent the x-axis from being unintentionally destroyed.

"Manual" The following x-axis parameter field is operable and completely independent of a sweep setting in the generator. It is reserved for the special case of graphically displaying self-generated or manipulated trace data records that are transferred from the controller via the IEC bus to the R&S UPV.

Example:

The distortion of an amplifier versus its **output** voltage is to be graphically displayed by means of a generator sweep.

At first glance, this does not seem to be possible, for normally only the generator voltage supplied by the R&S UPV (i.e. the amplifier's **input** voltage) can be swept and projected onto the x-axis.

However, the user would like to display the distortion factor over the **output voltage** on the amplifier in order to be able to assess how the distortion factor changes if the amplifier reaches its limits.

To be able to display the output voltage on the x-axis, this voltage must be measured in addition to the distortion. From these two series of measurements, it is possible to generate a trace data set and save it as a trace file using Visual Basic, for example, in order to graphically display the data set with the setting "Manual " and the following "x-axis " = "Voltage " parameter field.

"LevMon RMS" The measured level monitor RMS value is plotted on the x-axis if the level monitor is on.

"LevMon DC" The measured level monitor DC value is plotted on the x-axis if the level monitor is on.

"LevMon Peak" The measured level monitor peak value is plotted on the x-axis if the level monitor is on.

"Frequency" The measured frequency is plotted on the x-axis.

Remote command:

[DISPlay:SWEEp<n2>:X:SOURce](#) on page 990

X-axis

The parameter displayed in the selection field depends on the graphic subsystem in which the parameter field is offered.

For the graphic subsystem FFT Graph, the parameter is always "Frequency " and cannot be changed.

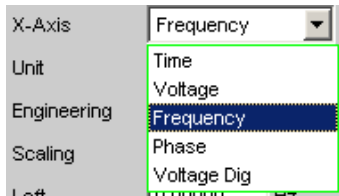


For the graphic subsystems Waveform, PESQ/POLQA and Impulse Response, the parameter is always "Time" and can also not be changed.



The Bar Graph graphics subsystem has an unscaled x-axis that is not displayed, and thus cannot be changed.

In contrast, for the graphic subsystem Sweep Graph1 ... 4, the functionality of this parameter field is determined by the "X-Source " parameter field above it, which is only offered in the display configuration panel Sweep Graph1 ... 4, and by the sweep setting of the generator.

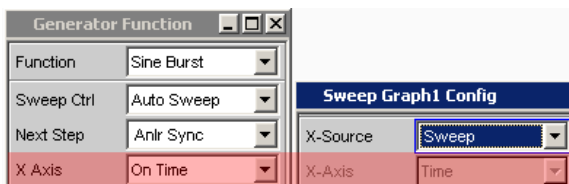


See [chapter 5.50.3, "Parameter Fields of the Panel"](#), on page 673.

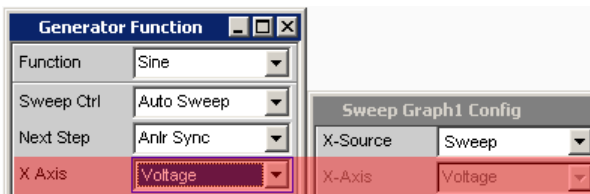
Available in the graphics subsystems

Sweep, FFT, Waveform, PESQ/POLQA, Impulse Response

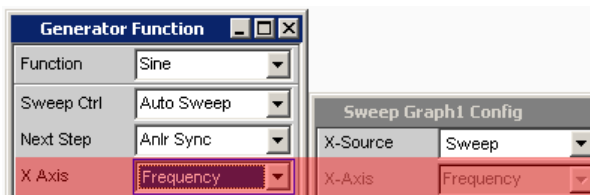
"Time" Depending on the current sweep setting, the x-axis is displayed as the time axis.



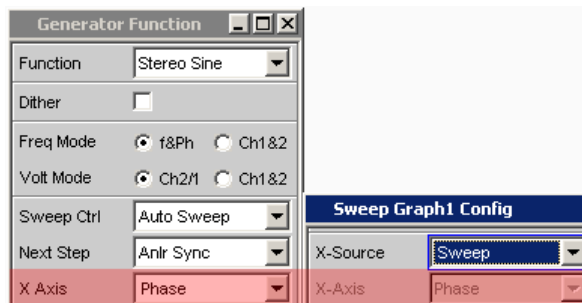
"Voltage" Depending on the current sweep setting, the x-axis is displayed as the analog level axis.



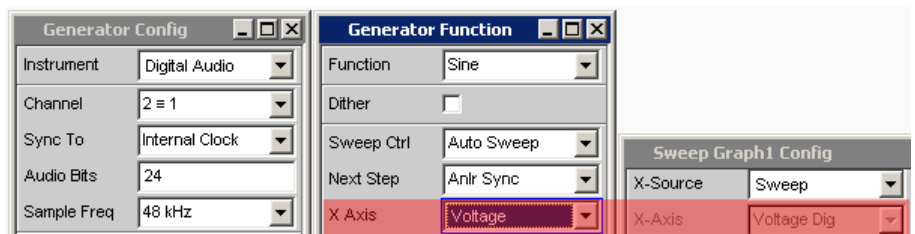
"Frequency" Depending on the current sweep setting, the x-axis is displayed as the frequency axis.



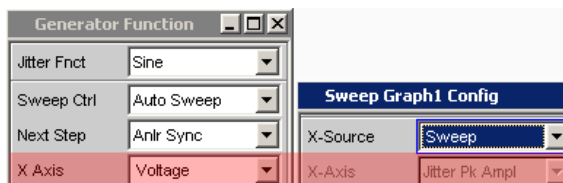
"Phase" Depending on the current sweep setting, the x-axis is displayed as the phase axis. Only available if the generator function Stereo Sine is selected.



"Voltage Dig" Depending on the current sweep setting in the digital generator instruments, the x-axis is displayed as the digital phase axis.



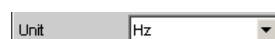
"Jitter Pk Ampl" Depending on the current sweep setting in the generator instrument "Digital Impairment", the x-axis is displayed as Jitter Peak Amplitude.



Remote command:

[DISPlay:SWEEp<n2>:X:AXIS](#) on page 989

Unit



This defines the unit of the values for measurement results, cursor scaling and left/right scaling of the x-axis as well as the units available for the "Ref Value" reference value for referenced units.

The list of units is determined by the setting in the "x-axis" parameter field. If "Frequency" is selected in that field, frequency units are offered here. If "Voltage" is selected in that field, voltage units are offered, and so on.

Recorded measurement sequences can be redisplayed with different units at any time.

Available in the graphics subsystems

Sweep, FFT, Waveform, PESQ/POLQA, Impulse Response

Remote command:

[DISPlay:SWEEp<n2>:X:UNIT](#) on page 991

Engineering



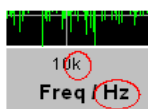
Displays the cursor and scaling values of the x-axis in the graphical display.

This parameter field cannot be accessed if a dB or % unit is selected in the Unit Funct Track parameter field above since these units do not have an engineering function.

Available in the graphics subsystems

Sweep, FFT, Waveform, PESQ/POLQA, Impulse Response

"Auto" Automatic engineering assignment from p to M. The cursor and scaling values are displayed **with** the engineering symbol. The x-axis is labeled with the unit **without** engineering.



"Off" Engineering is deactivated. Values are always displayed in 1.0 E⁰



"μ, m, k" Engineering fixed to μ, m or k. The values to be displayed are multiplied by the factor 1.0 E⁶, 1.0 E³ or 1.0 E⁻³. The cursor and scaling values are displayed **without** engineering symbol. The x-axis is labeled **with** Engineering and Unit.



Label Auto

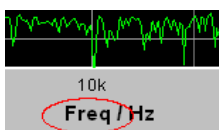
Used to determine whether the x-axis label is the same as that set in the x-axis parameter field or whether the label can be user-selected.

Available in the graphics subsystems

Sweep, FFT, Waveform, PESQ/POLQA, Impulse Response



The label in the x-axis parameter field is displayed in gray (cannot be accessed) in the text field to the right of the checkbox and also on the x-axis in the graphical display.



"deactivated"



A user-definable label appears on the x-axis of the graphical display.



Remote command:

[DISPlay:SWEEp<n2>:X:LABel:AUTO](#) on page 989

[DISPlay:SWEEp<n2>:X:LABel:USER](#) on page 989

Unit Auto



Used to determine whether the unit label displayed on the x-axis is the same as the unit set in the Unit parameter field or whether it can be user-selected.

Available in the graphics subsystems

Sweep, FFT, Waveform, PESQ/POLQA, Impulse Response

"activated"

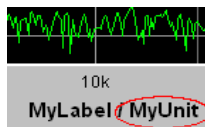


The unit label displayed on the x-axis is the same as the unit set in the Unit parameter field and is therefore generated automatically by the R&S UPV.

"deactivated"



A user-defined unit label can be entered.



Remote command:

[DISPlay:SWEEp<n2>:X:UNIT:AUTO](#) on page 991

Unit User String



User-defined unit designation if Unit Auto is not selected. This designation appears on the y-axis label instead of the usual unit.

Available in the graphics subsystems

Sweep, FFT, Waveform, PESQ/POLQA, Impulse Response

Remote command:

[DISPlay:SWEEp<n2>:X:UNIT:USER](#) on page 991

Ref Value



Reference value with unit for referenced units of the x-axis.

Available in the graphics subsystems

Sweep, FFT, Waveform, Impulse Response

Remote command:

[DISPlay:SWEEp<n2>:X:REFerence:VALue](#) on page 990**Scaling**Scaling Manual Auto

Manual or automatic scaling of the x-axis.

Available in the graphics subsystems

Sweep, FFT, Waveform, PESQ/POLQA, Impulse Response

- "Manual" Manual scaling
The scaling of a graphical display is determined using the "Left " and "Right " parameter fields below.
Each time the "Manual " parameter is set, the graphical display is deleted and then replotted with the scale end values entered under "Left " and "Right ".
- "Auto" Automatic scaling
Auto Scale uses suitable default values for **one-off** scaling of the x-axis. These values depend on the measurement task and the subsystem (e.g. the start/stop values of the sweep or FFT are used in the generator and analyzer panel).
The entry fields for the "Left " and "Right " parameter fields below are displayed in gray (cannot be accessed) with the obtained values.

Remote command:

[DISPlay:SWEEp<n2>:X:SCALing](#) on page 990**Spacing**Spacing Lin Log

Linear or logarithmic spacing of the x-axis.

For logarithmic units (dB units) and linear units in which negative numbers can occur (e.g. ΔV , ΔW), this parameter field is displayed as not user-accessible and is set to "Lin", since it makes no sense / is not possible to display dB values or negative values logarithmically.

Available in the graphics subsystems

Sweep, FFT, Waveform, PESQ/POLQA, Impulse Response

- "Lin" Linear spacing of the x-axis.
- "Log" Logarithmic spacing of the x-axis.

Remote command:

[DISPlay:SWEEp<n2>:X:SPACing](#) on page 990**Left**Left Hz

Used to set the left-hand value on the x-axis.

This parameter field can only be accessed if "Scaling" = "Manual" is selected.
Negative values or the value 0.00000 are not permitted if "Spacing" = "Log".

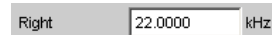
Available in the graphics subsystems

Sweep, FFT, Waveform, PESQ/POLQA, Impulse Response

Remote command:

[DISPlay:SWEEp<n2>:X:LEFT](#) on page 990

Right



Used to set the right-hand value on the x-axis.

This parameter field can only be accessed if "Scaling" = "Manual" is selected.

This value must always be higher than the Left value.

Negative values or the value 0.0000 are not permitted if "Spacing" = "Log".

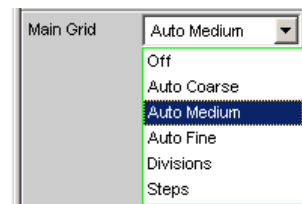
Available in the graphics subsystems

Sweep, FFT, Waveform, PESQ/POLQA, Impulse Response

Remote command:

[DISPlay:SWEEp<n2>:X:RIGHT](#) on page 990

Main Grid



Division of the graphical display with vertical main gridlines.

Available in the graphics subsystems

Sweep, FFT, Waveform, PESQ/POLQA, Impulse Response

"Off" No main gridlines are used in the graphical display.

"On" With "Spacing" = "Log":
Decadic division of a **logarithmic** divided x-axis with the aid of main gridlines.

"Auto Coarse, Auto Medium, Auto Fine"
With "Spacing" = "Lin":
Coarse, medium or fine division of an x-axis with main gridlines. One to two, 3 to 4 or 8 to 9 main gridlines are displayed depending on the scale end values.
Main gridlines may be **hidden** if the graphical window is reduced in size.

- "Divisions" With "Spacing" = "Lin":
Preset division of an x-axis with main gridlines.
The desired number of divisions is set in the parameter field below.
These main gridlines are **not** hidden if the graphical window is reduced in size!
- "Steps" With "Spacing" = "Lin":
Preset division of an x-axis in a fixed step size.
The step size is set in the parameter field below.
These main gridlines are **not** hidden if the graphical window is reduced in size!

Division

With the setting Spacing = Lin:

Used to enter the number of main gridline divisions for an x-axis.

If, for example, 2 is entered, the y-axis is divided into **two sections**, i.e. **one** main gridline is displayed.

Available in the graphics subsystems

Sweep, FFT, Waveform, PESQ/POLQA, Impulse Response

Step

With the setting Spacing = Lin.

Used to enter the main gridline step size for an x-axis.

The unit of the value is linked to the unit selected in the Unit Funct Track parameter field.

Available in the graphics subsystems

Sweep, FFT, Waveform, PESQ/POLQA, Impulse Response

Sub Grid

Subdivision of the main gridlines in a graphical display using subgridlines.

Available in the graphics subsystems

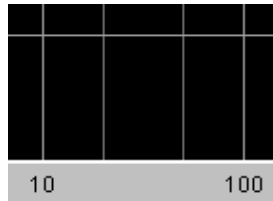
Sweep, FFT, Waveform, PESQ/POLQA, Impulse Response

- "Off" Subgridlines are deactivated.
- "2, 4, 5" With Spacing = Lin:
Subdivision of the main gridlines in a **linearly** divided x-axis into 2, 4 or 5 sections.
If, for example, **2** is selected, the y-axis is divided into two sections, i.e. **one** subgridline appears between the main gridlines.
These subgridlines are **not** hidden if the graphical window is reduced in size!

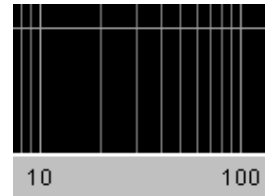
"Coarse, Fine"

With Spacing = Log:

Coarse or fine subdivision of the main gridlines of a **logarithmically** divided x-axis by subgridlines.

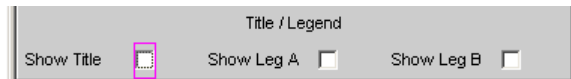


Coarse: Subgridline 2 and 5 only



Fine: All subgridlines

Show Title Show Leg A , Show Leg B



Permits or prevents the display of free texts in the graphical displays.

Available in the graphics subsystems

Sweep, FFT, Waveform, Bar Graph, PESQ/POLQA, Impulse Response

"activated" Permits the display of free texts in the graphical displays.

"deactivated" Prevents the display of free texts in the graphical displays.

Remote command:

[DISPlay:SWEEp<n2>:TITLe:SHOW](#) on page 988

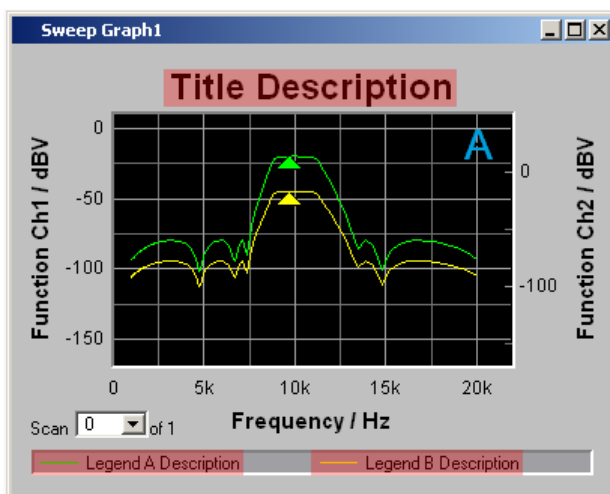
[DISPlay:SWEEp<n2>:A:LEGEnd:SHOW](#) on page 979

[DISPlay:SWEEp<n2>:B:LEGEnd:SHOW](#) on page 979

Title Descript, Leg A Descript, Leg B Descript



Input fields for free text for display in the graphical displays.



Available in the graphics subsystems

Sweep, FFT, Waveform, Bar Graph, PESQ/POLQA, Impulse Response

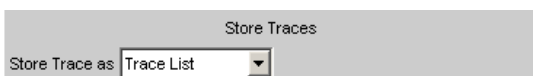
Remote command:

[DISPlay:SWEEp<n2>:TITLE:DESCRiption](#) on page 988

[DISPlay:SWEEp<n2>:A:LEGEnd:DESCRiption](#) on page 978

[DISPlay:SWEEp<n2>:B:LEGEnd:DESCRiption](#) on page 978

Store Trace as



This specifies the format in which the current trace is to be stored.

Depending on this setting, further command lines for modifying the data set that has to be stored are added or removed.

"Trace List" A trace is stored complete with all its scans, X and Y data, limit data and reference values. This file can be loaded as a trace file at parameter field "Y-Source", File: Trace A or File: Trace B and can be displayed.

Available in the graphics subsystems

Sweep, FFT, Waveform, Bar Graph, PESQ/POLQA, Impulse Response

"Equalization List" A trace is stored as an equalization file in order to make it available to the generator as a preemphasis file.

Each time an equalization file is stored the generator equalization file is loaded again, regardless of whether or not "Modify Equ. " is enabled. Then whenever a new equalization file is saved the precorrector becomes immediately effective on the next sweep scan. If the name of the stored equalization file and of the equalization file used in the generator are not identical, a warning is issued to notify that the newly created equalization file will now be used in the generator.

Available in the graphics subsystems

Sweep, FFT

"Sweep List"	<p>A trace is stored as a sweep list. If an "Auto List "– or "Manu List " Sweep is set in the generator, the sweep parameters are read from this file.</p> <p>Available in the graphics subsystems Sweep, FFT</p>
"Limit List"	<p>A trace is stored as a limit list. This file can be loaded at "Limit Upper" or "Limit Lower". It can then be displayed as a limit curve and used for limit monitoring.</p> <p>Available in the graphics subsystems Sweep, FFT, Bar Graph, PESQ/POLQA, Impulse Response</p>
"DataList Select"	<p>The filtered data of a trace is stored complete with all its scans, X and Y data, limit data and reference values. Data filtering is set in the measured value list via softkey menu item "Selection".</p> <p>The following filters can be selected:</p> <ul style="list-style-type: none"> • Upper limit violations only • Lower limit violations only • Upper and lower limit violations • Harmonics only • Peaks only. <p>A trace file stored in the "DataList Select" mode in conjunction with filters enabled in the measured value list usually consists of significantly fewer data sets than when unfiltered and the number of data sets for Trace A and Trace B is usually different.</p> <p>Available in the graphics subsystems Sweep, FFT, Bar Graph, PESQ/POLQA, Impulse Response</p>

Remote command:

[MMEMory:SWEEp<n2>:STAS](#) on page 992

Trace

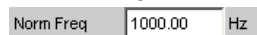


This is offered for "Store Trace as an" = "Equalization List" or "Limit List" and specifies whether the data set of Trace A or Trace B will be used for creating the corresponding lists.

Remote command:

[MMEMory:SWEEp<n2>:TRACe](#) on page 993

Norm Freq



This is offered for "Store Trace as " = "Equalization List ".

This specifies the frequency whose voltage value is used for normalization. If the frequency selected is that at which the frequency response curve is at its maximum, the precorrector file contains only values from 0.0 to 1.0. If a different frequency is selected, factors greater than 1.0 also occur.

Remote command:

[MMEMory:SWEEp<n2>:EQualization:NORMfrequency](#) on page 992

Invert

Invert

This is offered for "Store Trace as " = "Equalization List ".

The effect of inverting the frequency response in the generator by means of an equalization file created with the "Invert" setting is that the same DUT - with the precorrector enabled - now receives an undistorted frequency response.

Application: Constant (i.e. frequency response independent) power output, preemphasis/deemphasis.

If there is **no** check in the box, the equalization data set that is acquired corresponds to the frequency response of the DUT.

If the DUT is removed and a generator sweep is carried out using this equalization data set, the DUT can be simulated since a frequency response arises as if the DUT were present.

Remote command:

[MMEMory:SWEEp<n2>:EQualization:INVert](#) on page 991

Modify Equ.

Modify Equ.

This is offered for "Store Trace as " = "Equalization List ".

The current generator equalization data set is taken into account when the new equalization list is stored in order to obtain a significantly more accurate precorrection.

What is the purpose of multistage preemphasis?

Example:

At high frequencies a loudspeaker frequency response has a roll-off of approx. 10 dB. The intention is to compensate the frequency response by means of a generator pre-emphasis (equalization). For this purpose a generator sweep is started and the frequency response curve is acquired. An equalization file is created from this trace and made available to the generator. Another sweep is started using the equalization file and the frequency response is acquired.

The frequency response now seems considerably better, though the expected straight line has not appeared and there are inaccuracies in regions showing greater generator level increases.

The causes for this are **non-linearities** in the loudspeaker system. An increase in the generator level of 10 dB has not, as first expected, also increased the loudspeaker sound pressure by 10 dB but rather by only (for example) 9.8 dB due to non-linearities.

In order to compensate for these inaccuracies a further equalization using "Modify Equ." can be performed. This second scan, based on the data set of the equalization file loaded in the generator, usually produces the expected flat frequency response.

If "Modify Equ." is enabled and a new equalization file is created but equalization is not yet enabled in the generator, equalization is turned on by default using the newly created file name.

Remote command:

[MMEMory:SWEEp<n2>:EQUalization:MODify](#) on page 991

Offset

Offset

This is offered for "Store Trace as " = "Limit List ".

When a limit file is generated, an offset value is added to the Y data. This value is specified in the following parameter field.

Offset allows, for example, two limit files to be generated from a "golden unit", together forming a tolerance band, by generating a limit file for Upper Limit with an offset value of say 10 dBV and a limit file for Lower Limit with an offset value of -10 dBV. This produces a tolerance band with a width of 20 dBV so that the ideal frequency response of a selected DUT can be compared with the currently different DUT.

Remote command:

[MMEMory:SWEEp<n2>:LIMit:OFFSet](#) on page 992

Offset Value

10.0000 dBV

This is offered for "Store Trace as " = "Limit List ", if the "Offset " checkbox is activated.

It is an additive value for generating limit files based on the trace data set of an ideal DUT. Generating two limit files, one with a positive and the other with a negative offset, allows a tolerance band to be generated

Remote command:

[MMEMory:SWEEp<n2>:LIMit:OFFSet:VALue](#) on page 992

Store Trace to

Store Trace to C:\UPV\config\user\mytrace.trc

This stores the current trace, complete with all scans, in the format specified by Store Trace as, under the specified file name.

Available in the graphics subsystems

Sweep, FFT, Waveform, Bar Graph, PESQ/POLQA, Impulse Response

Remote command:

[MMEMory: SWEep<n2>: STORe](#) on page 992

Resolution

Resolution 3 dig. / 0.1 dB

Used to set the number of digits used to display the cursor and scaling values in the graphical window.

If "Engineering " is set to "Auto ", the Resolution setting only applies to the cursor values and not to the scale values.

Available in the graphics subsystems

Sweep, FFT, Waveform, Bar Graph, PESQ/POLQA, Impulse Response

"3 dig. / 0.1 dB, 4 dig. / 0.01 dB, 5 dig. / 0.001 dB, 6 dig. / 0.0001 dB, 7 dig. / 0.00001 dB"

Significance of the parameter list using an example:

5 dig. / 0.001 dB

5 dig.:

Values which are displayed with a linear unit (V, Hz, etc) are output with 5 digits:

4986.2
Freq / Hz

0.001 dB:

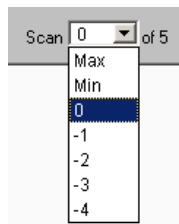
Values which are displayed with a logarithmic unit (dBV, dBu, etc.) are output to three decimal places:

58.926
/ dBV

If the numeric values can no longer be displayed with the selected resolution, they are rounded off and shown as an exponent:

5.0E+6
Freq / mHz

Scan



This is a display for the current scan and an opportunity to select a scan in the graphical display. For those graphic systems that allow multiscan recording (Sweep Graph 1 to 4), the desired scan can be selected here. Number 0 means the most recent scan. The lower the negative number, the older the scan.

Scans identified as Min and Max are available to all graphic systems, provided they are enabled by



checking the box.

When you use the NEXT SCAN toggle key to scroll through the scans, the current value is entered here.

Available in the graphics subsystems

Sweep, FFT, Waveform, Bar Graph, PESQ/POLQA, Impulse Response

Remote command:

[DISPlay:SWEp<n2>:SCANoffset](#) on page 917

5.50.4 Softkey Menu

Using an extensive softkey menu the display can be, among other things,

- automatically scaled (Autoscale)
- expanded (Zoom)
- measured using vertical and horizontal cursors (Cursor) or
- provided with markers (Marker).

Table 5-9: Explanation of the individual softkey menu items:




"Level 1 "	"Level 2 "	"Level 3 "	"Level 4 "	Brief description
"Trace "				
	"Show A" <input checked="" type="checkbox"/>			(Temporarily) show/hide graphical display of Trace A
	"Show B" <input checked="" type="checkbox"/>			Ditto for Trace B
	"Back "			Move back by one menu level
"Autoscale "				Single scaling of coordinate system using minimum and maximum values

"Level 1 "	"Level 2 "	"Level 3 "	"Level 4 "	Brief description
	"A"			For Trace A
	"B "			Ditto for Trace B
	"A&B "			Ditto for Trace A and B
	"X-axis "			Ditto for x-axis
	"All "			Ditto for Trace A, B, and x-axis
	"Back "			Move back by one menu level
"Cursor "				Cursor settings
	"O <--> X"			Used to determine whether O or X cursor is moved with rotary knob
	"O Cursor "			O cursor settings
		"O Active " <input checked="" type="checkbox"/>		Activate/deactivate O cursor
		"O Vert A "		O cursor becomes vertical cursor on Trace A
		"O Vert B "		Ditto on Trace B
		"O Vert A-B "		Ditto on Trace A and Trace B and shows difference between Y values.
		"O Hor A "		O cursor becomes horizontal cursor on Trace A
		"O Hor B "		Ditto on Trace B B
		"Movement (Next Pixel) "		Movement behavior of O cursor when it is moved
			"Next Pixel "	Pixel-by-pixel movement
			"Next Bin " "Next Sample " "Next Value " "Next Step "	Between reference points
			"Next Peak "	Movement between partial curve peaks
			"Next Harmonic "	FFT display: movement between harmonics
		"Back "		Move back by one menu level

"Level 1 "	"Level 2 "	"Level 3 "	"Level 4 "	Brief description
	"X-Cursor "			X cursor settings
		"X Active " <input checked="" type="checkbox"/>		Activate/deactivate X cursor
		"X Vert A "		X cursor becomes vertical cursor on Trace A
		"X Vert B "		Ditto on Trace B
		"X Vert A-B "		Ditto on Trace A and Trace B and shows difference between Y values.
		"X Hor A "		X cursor becomes horizontal cursor on Trace A
		"X Hor B "		Ditto on Trace B
		"Movement (Next Pixel) "		Movement behavior of X cursor when it is moved
			"Next Pixel "	Pixel-by-pixel movement
			"Next Bin " "Next Sample " "Next Value " "Next Step "	Between reference points
			"Next Peak "	Movement between partial curve peaks
			"Next Harmonic "	FFT display: movement between harmonics
		"Back "		Move back by one menu level
	"Set O Cursor "			Sets O cursor ...
		"Max "		... to trace maximum
		"Min "		... ditto for minimum
		"Marker A "		... to position of Marker A
		"Marker B "		... to position of Marker B
		"Value "		... to a value that can be entered later
		"Back "		Move back by one menu level
	"Set X Cursor "			Sets X cursor ...
		"Max "		... to trace maximum
		"Min "		... ditto for minimum

"Level 1 "	"Level 2 "	"Level 3 "	"Level 4 "	Brief description
		"Marker A "		... to position of Marker A
		"Marker B "		... to position of Marker B
		"Value "		... to a value that can be entered later
		"Back "		Move back by one menu level
	"Back "			Move back by one menu level
"Marker "				Marker settings
	"Trace A "			Marker settings for Trace A
		"Off"		Marker deactivated
		"Set to O Cursor "		Set marker to position of O cursor
		"Set to X Cursor "		Set marker to position of X cursor
		"Set to Value "		Set marker to a value that can be entered later
		"Track to Max" <input checked="" type="checkbox"/> ""		Set marker to maximum of Trace A. Marker changes with maximum
		"Harm " <input checked="" type="checkbox"/>		Harmonics are calculated and displayed based on X position of marker
		"Back "		Move back by one menu level
	"Trace B "			Marker settings for Trace B
		"Off"		Marker deactivated
		"Set to O Cursor "		Set marker to position of O cursor
		"Set to X Cursor "		Set marker to position of X cursor
		"Set to Value "		Set marker to a value that can be entered later

"Level 1 "	"Level 2 "	"Level 3 "	"Level 4 "	Brief description
		"Track to" Max <input checked="" type="checkbox"/>		Set marker to maximum of Trace B. Marker changes with maximum
		"Harm " <input checked="" type="checkbox"/>		Harmonics are calculated and displayed based on X position of marker
		"Back "		Move back by one menu level
"Zoom "				Increase / reduce size of graphical display
	"Act Curs In "			Size of graphical display is increased around active cursor (solid line). If active cursor is a vertical cursor, a section of x-axis is displayed; if it is a horizontal cursor, a section of y-axis is displayed. In both cases, displayed section is adjusted so that cursor appears at center of display.
	"Act Curs Out "			Ditto for reducing size of graphical display
	"Betw V Curs "			Zooming between two vertical cursors
	"Betw H Curs "			Zooming between two horizontal cursors
	"Unzoom "			Undoes all zoom operations
	"Undo "			Undoes zoom operation last performed. Several zoom operations can be undone. Entering new axis limits (Top, Bottom, Left, Right) resets undo memory.
	"Autoscale "			Automatic scaling of coordinate system using minimum and maximum values
		"A"		For Trace A
		"B "		Ditto for Trace B
		"A&B "		Ditto for Trace A and B
		"X-axis "		Ditto for x-axis

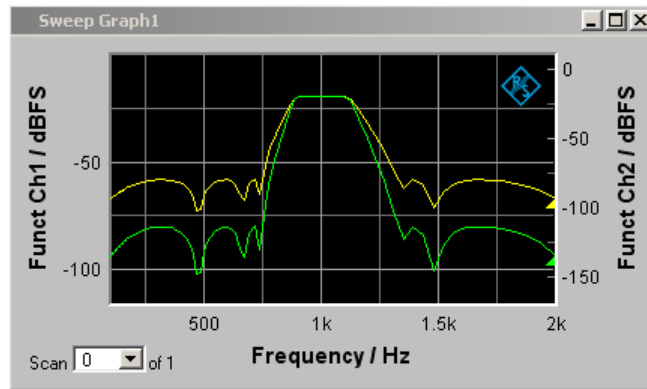
"Level 1 "	"Level 2 "	"Level 3 "	"Level 4 "	Brief description
		"All "		Ditto for Trace A, B, and x-axis
		"Back "		Move back by one menu level
"Restart Min/Max " "Lim Violation "				Deletes Min/Max curves and limit violation symbols for graphical display and restarts collection of Min/Max data and checking of limit violations.
	"MinMax A "			Min/Max curves of Trace A
	"MinMax B "			Ditto for Trace B
	"MinMax A+B "			Ditto for Trace A and Trace B
	"Lim Viol A "			Limit violation symbols for Trace A, i.e. red dots which indicate limit violations on trace, and red triangular symbols for limit violations are deleted and only a gray triangle is displayed.  or  -> 
	"Lim Viol B "			Ditto for Trace B
	"Lim Viol A+B "			Ditto for Trace A and Trace B
	"Back "			Move back by one menu level
"Config "				Opens associated Config panel

5.50.5 Single Scan

Scan Single Multi

For the two independent y-axes (Trace A and Trace B) on the graphical display, the user can display two out of eight simultaneously acquired measured values. These can include not only level measurement results, frequencies or total harmonic distortions from the left and right channels, but also physically different values such as voltage and phase. The measurement function relevant to the measured value display is set in the Analyzer Function panel, and the measurement function relevant to the trace display is selected from the Graphics Configuration panel at "Y-Source".

The graph shows a single sweep on Trace A (green) and Trace B (yellow).



In addition the setting



produces two further scans in which the Min and Max curves are generated, exactly as in the following graph which shows a crowded set of curves.

5.50.6 Trace Group

With the R&S UPV, the number of measurement sequences is not restricted to x number of scans. Instead, Sweep Graphs 1 to 4 can be set for the graphics system (see [chapter 5.50.1, "Graphical Display, Explanation of the Elements"](#), on page 664).

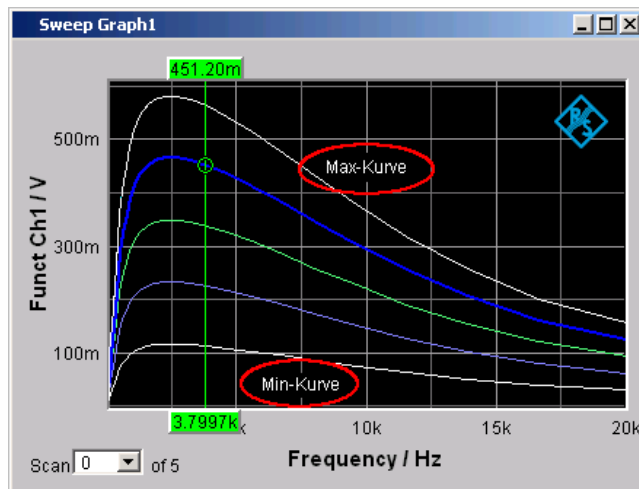


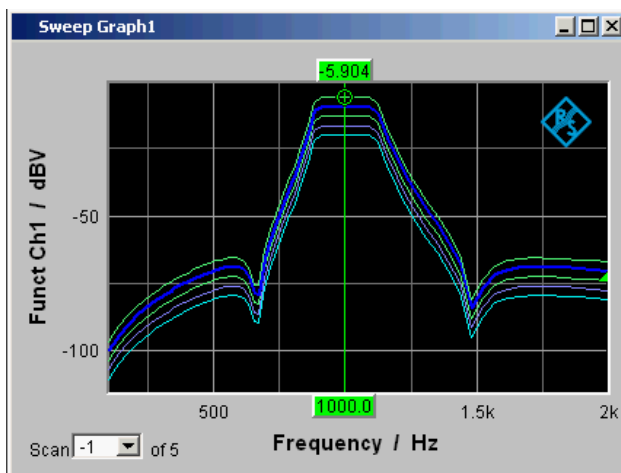
between 2 and 20 in the appropriate configuration panels. In addition the setting



produces two further scans in which the Min and Max curves are generated.

A trace group with Min/Max curves is shown as the graphical display.





All of the recorded measurement sequences are saved (both internally and, if the user requires, as a file) and can be displayed, rescaled and reloaded as a single unit.

With the generator, a second sweep (the Z sweep) is possible in addition to the X sweep. It is called the Z sweep because it is usually displayed on the z-axis of a 3D coordinate system. When this operating mode is selected, the number of scans set under "History" is automatically set to the number of Z-points.

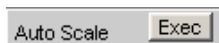
Generally, in a graphical window which allows scans to be recorded, a trace group or a trace pair consisting of Trace A and Trace B each with one trace group will be displayed in the respective graphical window if History is set to ≥ 2 .

If History is set to the maximum value of 20 and "Show Min Max" is activated: a maximum of 44 scans are displayed

Trace A	20	Scans
Trace A	1	Min trace
Trace A	1	Max trace
Trace B	20	Scans
Trace B	1	Min trace
Trace B	1	Max trace
-----	----	-----
total	44	Traces

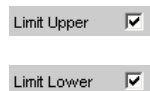
As long as a measurement is running and scans are performed, they are displayed in gray. When the measurement is completed or the scan was stopped by means of Hold, the scans are displayed in automatically assigned colors.

In the case of automatic scaling of the y-axis



all available traces are taken into account in order to determine the maxima and minima.

All other actions, e.g. setting the cursor to the Min or Max value, always relate to the current scan. For limit violation monitoring, which is set up using

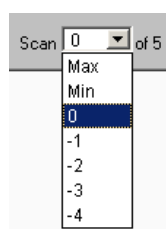


all traces are checked against the same two limit curves. The symbol for limit violation



always relates to the current trace pair.

The current scan (one trace if only Trace A or Trace B is activated, two traces if both traces are activated) is changed in the graphical window or result list using the NEXT SCAN toggle key or the selection field.



The number in the "Scan" selection field



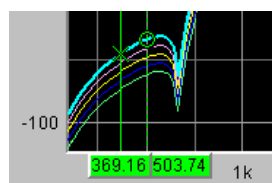
displays for graphic systems that allow multiscan recording (Sweep Graph 1 to 4) the current value, the so-called scan index. Number 0 means the most recent scan. The lower the negative number, the older the scan.

Scans identified as Min and Max are available to all graphic systems, provided they



are activated.

If Cursor is switched on in the graph, an O or X identifies the intersection of the cursor with the current trace or trace pair. If the scan index changes, this marking jumps to the next scan.



If the measured value list is enabled,



the lists are reconfigured after every change in the scan index, because only one scan is displayed in the measured value list.

5.50.7 Interpolation on the Common x-axis

So that any number of traces can be used as reference or displayed simultaneously for comparison and measured with the cursors, such traces should actually all have the same X values. The R&S UPV, however, can use any X divisions, by interpolating the measured value sequences, reference traces and limit curves onto the current x-axis. The Equalization Lists are also interpolated on the x-axis of the generator sweep and the waiting time curves for sweep stepping.

Reference traces, limit curves and waiting time curves therefore need consist of only a few interpolation points. The interpolation takes into account whether the x and y-axes are divided on a linear or logarithmic basis, because segments of ellipses are generally produced from straight lines in the other display.

5.51 Result List

All measured values from all graphic subsystems can also be displayed in lists instead or in combination with the graphical windows.

5.51.1 Graphical Display, Explanation of the Elements

The screenshot shows a window titled "Waveform Data List 1" with a "Config" button in the top right. The window contains a table with the following columns: X A (s), Y A (V), X B (s), and Y B (V). The data rows are numbered 83 to 97. The Y A column values are in red text. A blue box highlights the value "20.340 m" in the Y B column of row 87. At the bottom, there is a "Scan" dropdown set to "0 of 1", a "Selection:" label with "All" below it, and a "Lim A" label with a red triangle cursor pointing to it.

	X A (s)	Y A (V)	X B (s)	Y B (V)
83	1.7083 m	33.707 m	1.7083 m	33.707 m
84	1.7292 m	30.835 m	1.7292 m	30.835 m
85	1.7500 m	27.630 m	1.7500 m	27.630 m
86	1.7708 m	24.118 m	1.7708 m	24.118 m
87	1.7917 m	20.340 m	1.7917 m	20.340 m
88	1.8125 m	16.341 m	1.8125 m	16.341 m
89	1.8333 m	12.166 m	1.8333 m	12.166 m
90	1.8542 m	7.8522 m	1.8542 m	7.8522 m
91	1.8750 m	3.4553 m	1.8750 m	3.4553 m
92	1.8958 m	-979.89 μ	1.8958 m	-979.89 μ
93	1.9167 m	-5.4014 m	1.9167 m	-5.4014 m
94	1.9375 m	-9.7675 m	1.9375 m	-9.7675 m
95	1.9583 m	-14.027 m	1.9583 m	-14.027 m
96	1.9792 m	-18.135 m	1.9792 m	-18.135 m
97	2.0000 m	-22.038 m	2.0000 m	-22.038 m

1: Columns with measured values

Trace A, Trace B and the associated x-axes are displayed as numeric values in a maximum of four columns.

2: Arrow

Colored arrow symbols indicate the direction in which a cursor left the display window.

3: Measured value with limit violation

A limit violation, which is identified by red dots / red bars on the traces and bar graphs, is indicated by red measured values in the result list.

4: Cursor markers

A colored rectangular marking indicates the row containing the value at which the cursor is located (also applies to traces and bar graphs). "o" or "x" to the left of the measurement number indicates the O or X cursor.

168	978.52
o 169	984.38
170	990.23
x 171	996.09
172	1.0020 k

Pressing the "Find Cursor" softkey adjusts the display window so that the data set appears together with the cursor at the center of the display.

5: Numbering of measured values

The individual measured values are numbered consecutively from 1 to n.

6: Scan number

If a trace consists of several scans, the desired scan can be selected here by pressing the NEXT SCAN rocker key or using the mouse. In the result list, only the values of the selected scans are shown. The scan number shown in this display field indicates which scan is listed.

7: Symbols indicating limit violations

Lim A  Lim B 

"Limit Upper"



Limit Upper is activated and there is no limit violation.

"Limit Lower"






Limit Lower is activated and there is no limit violation.

"Limit Upper past"



The "Limit Upper" value has been violated in the past but there is currently no limit violation. The violation is indicated until the START key is pressed again.

"Limit Lower past"		The "Limit Lower" value has been violated in the past but there is currently no limit violation. The violation is indicated until the START key is pressed again.
"Limit Upper current"		The "Limit Upper" value is currently being violated.
"Limit Lower current"		The "Limit Lower" value is currently being violated.

8: Display filter

If the result list has the focus, a softkey menu appears. Pressing the "Selection " button opens the next softkey level where it is possible to select the measured values according to the following criteria, i.e. to list only those rows which satisfy the selection criteria:

"All ", "Lim upper ", "Lim lower ", "Lim upp&low ", "Harmonics ", "Peaks "

9: Selection frame

Used to scroll through the result list. When the selection frame reaches the top or bottom of the result list, the list is scrolled below the window.

10: Config

Right-clicking anywhere opens a context menu, left-clicking opens the corresponding DispConfig panel.

5.51.2 Calling Up

A data list button can be found in the first line of every display configuration panel



and can be used to open a measured value list for each graphic system or for additional graphic display.

Trace A, Trace B and the associated x-axes are displayed as numeric values in a maximum of four columns.

The column on the left-hand side contains the number of the measured value, a colored marking indicating the row containing the value at which the cursor is located and may also contain colored arrow symbols indicating the direction in which a cursor left the display window. Pressing the "Find Cursor " softkey adjusts the display window so that the data set appears together with the cursor at the center of the display.

In the columns for the Y values of Trace A and Trace B digits highlighted in color by pressing the "Selection" softkey indicate whether the measurement result is violating the "Limit Upper" and/or "Limit Lower" parameters or whether the value is a harmonic or a peak.

Hidden sections of the data set can be shown in the display window using the scrollbar on the right-hand side of the panel or using the blue selection frame.

5.51.3 Parameter Fields of the Panel

The result list does not have its own panel; it is configured according to the settings in the display configuration panel from which it was opened.

The following parameter fields and softkey functions affect the result list (and, at the same time, the traces and bar graphs):

Unit Funct Track

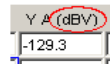


Used to determine whether the unit is the same as that set in the analyzer or whether it can be user-selected.

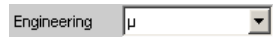
Unit



The unit set here is displayed above the measurement result column for Trace A, Trace B or above the values on the x-axis:



Engineering



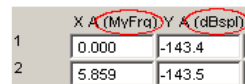
The measured values for Trace A or Trace B and the values on the x-axis are displayed with the engineering selected in this parameter field:



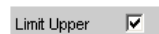
Unit Auto



Used to determine whether the unit label displayed above the measurement result column for Trace A, Trace B or above the values on the x-axis is the same as the unit set in the "Unit Funct Track" or Unit parameter field, or whether it can be user-selected.



Limit Upper



If a "Limit Upper" value or scan is set here, the measured values which violate the limit are displayed in red if "Limit Upper" or "LimUpp&Low" is set under the "Selection" soft-key.



Limit Lower

Limit Lower

If a "Limit Lower" value or scan is set here, the measured values which violate the limit are displayed in red if "Limit Lower" or "LimUpp&Low" is set under the "Selection" soft-key.

Resolution

Resolution 4dig / 0.01dB

Used to set the number of digits used to display the measurement results for Trace A and Trace B and the values on the x-axis.

Y A (dBv)
-143.66
-149.42

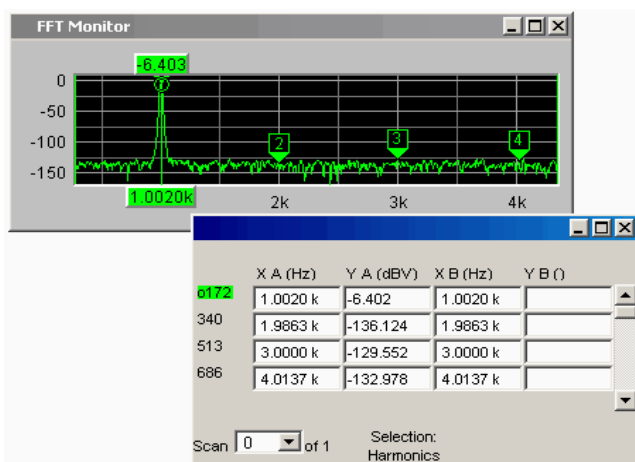
Selection Harmonics

Marker

Trace A Trace B

Track to Max Harm

If harmonics are shown in the graphical display (activated using the softkey menu), a display filter which only shows the values of the harmonics can be applied to the list display by setting "Harmonics" under the "Selection" softkey. There are gaps in the numbering of the values on the left side of the window.

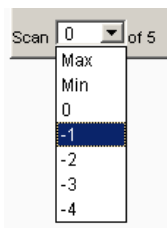


Scan



This field and option in the graphical display also appears in the result list. It indicates the selected scan for Sweep Graph 1 to 4 graphic subsystems which have multi-scan recording.

The current value for the respective scan is entered here by scrolling through the scans using the NEXT SCAN key; this value can then be changed.



Number 0 means the most recent scan. The lower the negative number, the older the scan.

5.51.4 Softkey Menu

Explanation of the individual menu items:

Level 1	Level 2	Brief description
"Close "		Used to close the result list.
"Find Cursor "		Used to adjust the display window containing the result list so that the data set appears together with the cursor at the center of the display. If both cursors are activated, this button is used to toggle between the two cursors.

Level 1	Level 2	Brief description
"Selection " Remote control command: <code>DISPlay:SWEp<n2>:DLIST: FILTer</code> on page 986		The following values are listed in the result list:
	"All "	All
	"Lim upper "	Only those values which over-range the upper limit
	"Lim lower "	Only those values which under-range the lower limit
	"Lim upp&low "	Only those values which over-range the upper limit and under-range the lower limit
	"Harmonics "	Only harmonics
	"Peaks "	Partial trace maxima

5.52 Numeric display

The numeric display provides a clear overview of max. 8 measurement results (two-channel instruments) or max. 64 measurement results (multichannel instruments) from max. four analyzer measurement functions from the Analyzer Function panel. If all of the analyzer measurement functions are activated, the individual columns are assigned the measurement functions in the following sequence (from left to right):

Measurement results for Analyzer Function, Level Monitor, Input Monitor, Freq/Phase.

	RMS	Lev RMS	Input Peak	Frequency
Ch1	495.59 mV	500.60 mV	705.85 mV	1000.0 Hz
Ch2	594.59 mV	600.60 mV	846.85 mV	1000.0 Hz

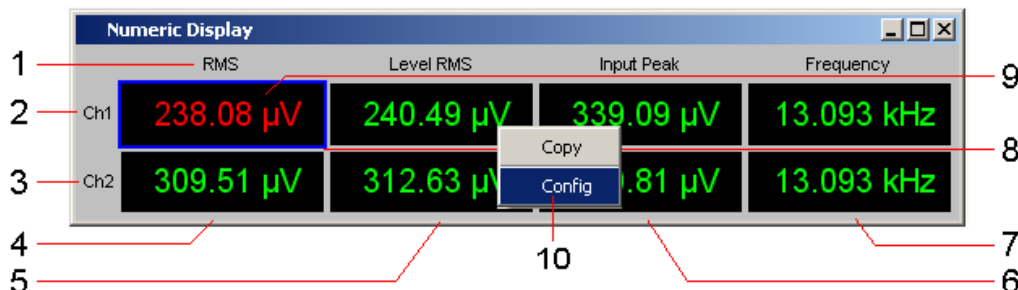
If certain analyzer measurement functions in the Analyzer Function panel are deactivated, the associated measurement results are hidden. The name of the measurement function, however, clearly indicates which column refers to which measurement function.

	RMS	Frequency
Ch1	6.2370 mV	1.6000 kHz
Ch2	105.24 mV	1600.0 Hz

For more detailed information on the assignment of the individual measurement results to the analyzer measurement functions see [chapter 5.53, "Combo Display"](#), on page 745).

5.52.1 Graphical Display, Explanation of the Elements

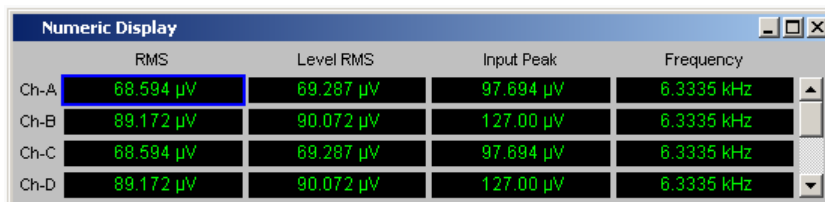
The explanation of the elements is based on the numeric display for two-channel instruments.



For multichannel instruments, the only difference are the additional lines Ch3 to Ch8 or Ch3 to Ch16.

The number of simultaneously displayed channels can be set for multichannel instrument in the Config panel in the panel section "Numeric Display Configuration" with the "Max Ch Disp" parameter field. The remaining channels can be reached via the scrollbar.

The labeling of the display fields is generally Ch1, Ch2, Ch3, etc., but it can be changed with the "Channel Descr." parameter field. The respective string is called: "Ch-A;;Ch-B;;Ch-C;;Ch-D;;Ch5;;Ch6;;Ch7;;Ch8;;Ch9;;Ch10;;Ch11;;Ch12;;Ch13;;Ch14;;Ch15;;Ch16".



1: Name of measurement function

Name of the current measurement function from left to right:

Function, Level Monitor, Input Monitor, Freq/Phase

If the measurement function is changed in the analyzer panel, the labels here also change.

2, 3: Measurement result for Channel 1, Measurement result for Channel 2

In the sequence specified above.

4: Measurement result function, column 1

Measurement results of the function which is set in the **Analyzer Function** in the "Function" field.



5: Measurement result for Level Monitor, column 2

Measurement results for the set **Level Monitor** function.

**6: Measurement result for Input Monitor, column 3**

Measurement results for the **Input Monitor** function.

**7: Measurement result for the Freq/Phase measurement function, column 4**

Measurement result for the Freq/Phase measurement function.

With the setting "Frequency" or "Sample Freq" either display of the frequency measurement result or with the setting of **Freq & Phase-**, **Freq & GrpDel** or **Freq & Samplefreq** display of the frequency measurement result in the first row and display of phase, group delay or sample frequency measurement result in the second and, if necessary, following rows.

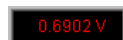
**8: Selection frame**

If the numeric display has the focus, measurement results can be selected by moving the blue selection frame with the rotary knob or by clicking with the mouse. Clicking with the rotary knob or double-clicking with the mouse opens the associated combo display (see [chapter 5.53, "Combo Display"](#), on page 745).

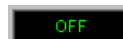
9: Limit violation display

Measurement result displayed in green:

Limit monitoring is deactivated or the measurement result is within the preset limits.



Measurement result displayed in red: Current limit value violation is present. For setting the limit values, see [chapter 5.53, "Combo Display"](#), on page 745).



The measurement is deactivated in the analyzer panel.



No measurement result is available (yet).

10: Copy / Config

Right-clicking anywhere calls up a context menu, left-clicking on one of the entries executes the corresponding function.

Copy:

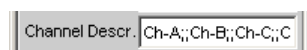
Copies measured value and unit as ASCII character string to the clipboard (same as CTRL+C).

Config:

Opens the corresponding DispConfig panel.

Max Ch Disp

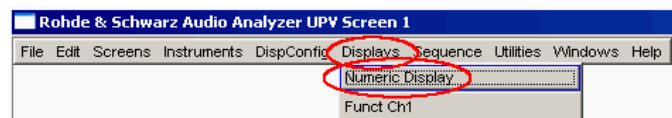
The number of simultaneously displayed channels can be set for multichannel instrument using the button "Utilities", "Config Panel" in the panel section "Numeric Display Configuration" in the parameter field "Max Ch Disp", see ["Max Ch Disp"](#) on page 664

Channel Descr.

The labeling of the display rows in the Numeric Display can be entered via the menu bar under the button "Utilities", "Config Panel" in the panel section "Numeric Display Configuration" in the parameter field "Channel Descr.", see ["Channel Descr."](#) on page 664

5.52.2 Calling Up

The numeric display field is opened via the menu bar.

**5.52.3 Parameter Fields of the Panel**

The numeric display does not have its own panel; however, a number of settings made in the measurement result configuration panels in the combo displays affect the way in which the measurement results are displayed:

Unit

Unit Auto

Resolution

Engineering

Reference

Limit Lower

Limit Upper

For more detailed information see [chapter 5.53, "Combo Display"](#), on page 745).

5.52.4 Softkey Menu

The numeric display does not have its own softkey menu; however, the softkey functions of the combo displays affect the way in which the measurement results are displayed.

For more detailed information see [chapter 5.53, "Combo Display"](#), on page 745).

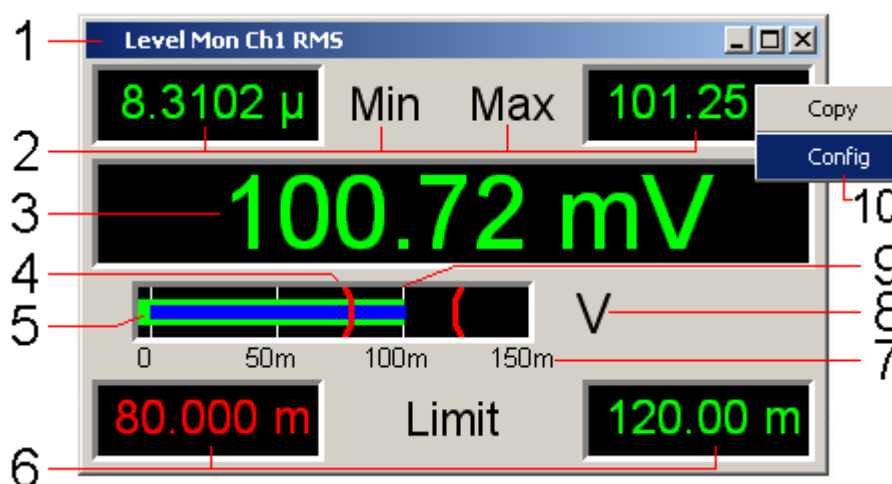
5.53 Combo Display

It is often the case that the measurement results in the numeric display do not contain adequate information. Additional features such as analog bargraphs, limit monitoring or the storage of maximum and minimum values are frequently required.

The combo display is used for this purpose. Additional information can be displayed for every measurement shown in the numeric display.

The free selection and free scalability mean that especially important or critical results can be monitored and tracked even when viewing the screen of the R&S UPV from a relatively long distance away.

5.53.1 Graphical Display, Explanation of the Elements



1: Measuring function

Measuring function in the combo display title field

2: Minimum value / maximum value

Highest/lowest value measured since the START key was pressed; set with

Show Min Max

3: Measurement display

Current measured value.

If the measured value changes to red, there is a limit violation.

4: Limit marker

Displays the

Limit Lower	<input checked="" type="checkbox"/>	<input type="text" value="200.000"/>	mV
Limit Upper	<input checked="" type="checkbox"/>	<input type="text" value="400.000"/>	mV

lower and upper limit specified under in the bargraph.

5: Bargraph

Green:

Displays the measurement result as a bar on a scale. If the bar changes to red, there is a limit violation.

Blue:

Min/Max bargraph The ends of the blue bar indicate the lowest and highest measured value since START

6: Lower / Upper Limit

Numeric displays of the lower/upper limit specified under

Limit Lower	<input checked="" type="checkbox"/>	<input type="text" value="200.000"/>	mV
Limit Upper	<input checked="" type="checkbox"/>	<input type="text" value="400.000"/>	mV

If the value changes to red,

<input type="text" value="1000.000"/>	Limit	<input type="text" value="90.000"/>
---------------------------------------	-------	-------------------------------------

this means that a violation of the lower/upper limit occurred after START. This limit violation is indicated until the hold function is reset by START or by entering a new lower/upper limit.

7: Scaling

Measurement range of the bargraph; set with

Auto Scale	<input type="button" value="Exec"/>
Spacing	<input checked="" type="radio"/> Lin <input type="radio"/> Log
Left	<input type="text" value="100.000"/> nV
Right	<input type="text" value="10.0000"/> V

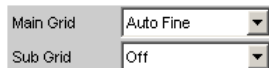
8: Unit

Unit of the bargraph; set with



9: Main gridlines, subgridlines

Main gridlines and subgridlines; set with



10: Copy / Config

Right-clicking anywhere calls up a context menu, left-clicking on one of the entries executes the corresponding function.

Copy:

Copies measured value and unit as ASCII character string to the clipboard (same as CTRL+C).

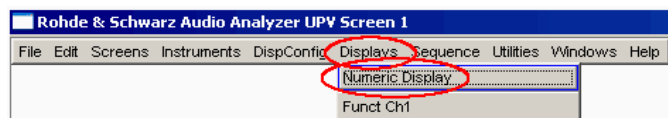
Config:

Opens the corresponding DispConfig panel.

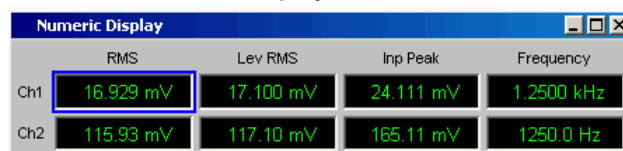
5.53.2 Calling Up

There are several ways to open the combo display:

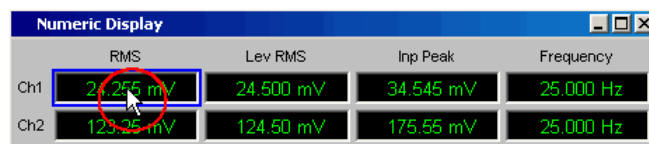
- Open the Display menu.



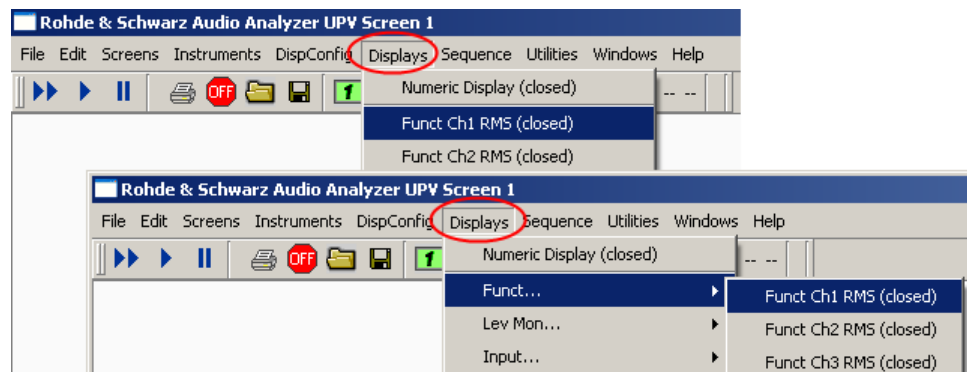
Select the Numeric Display menu item.



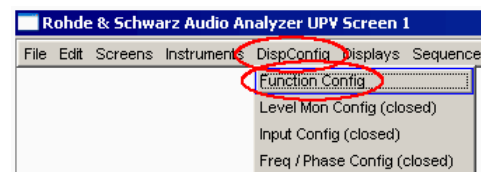
Move the blue selection frame to the desired measurement result using the rotary knob and then click with the rotary knob or, with mouse operation, double-click the desired measurement result in the numeric display.



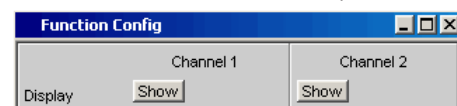
- Open the combo display directly via the menu bar.
The menus differ slightly in two-channel or multichannel instruments.



- Select a measurement result configuration panel from the menu field as follows:



Click the "Show" button in the Display field of the configuration panel (possible only for two-channel instruments).



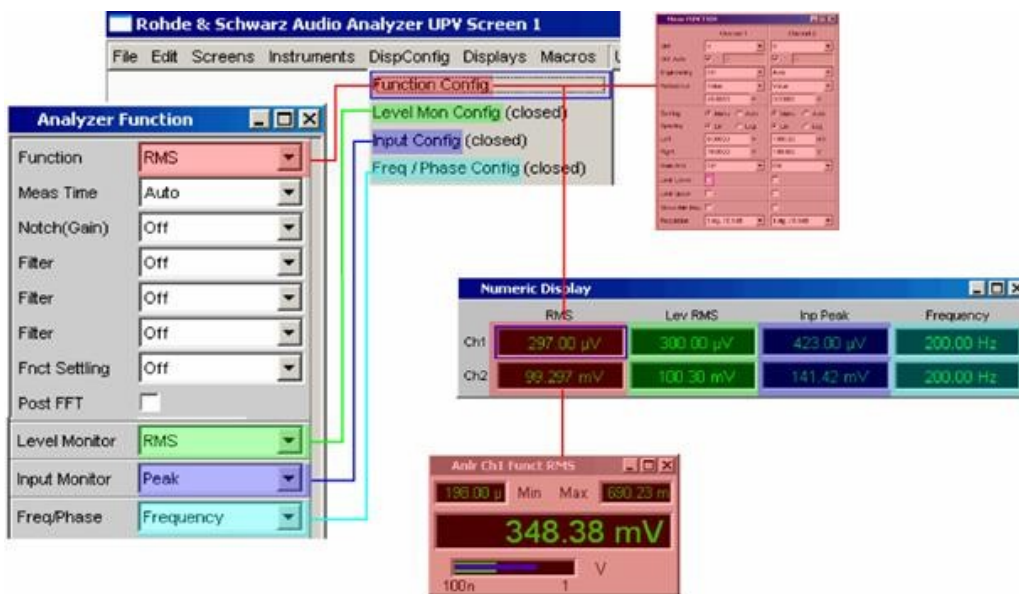
The measurement result configuration panels are used to determine how measurement results are **displayed** in the numeric display and the combo display. **What is measured and how measurement is performed** is configured in the analyzer panel.

The measurement result configuration panels are opened in the menu.

4 different measurement result configuration panels are available.

- **Function Config**
The panel is used to configure how the measurement results for the analyzer measurement function "Function" are displayed.
- **Level Mon Config**
The panel is used to configure how the measurement results for the additional measurement function "Level Monitor" are displayed.
- **Input Config**
The panel is used to configure how the measurement results for the additional measurement function "Input Peak" are displayed.
- **Freq / Phase Config**
The panel is used to configure how the measurement results for the additional measurement function "Freq/Phase" are displayed.

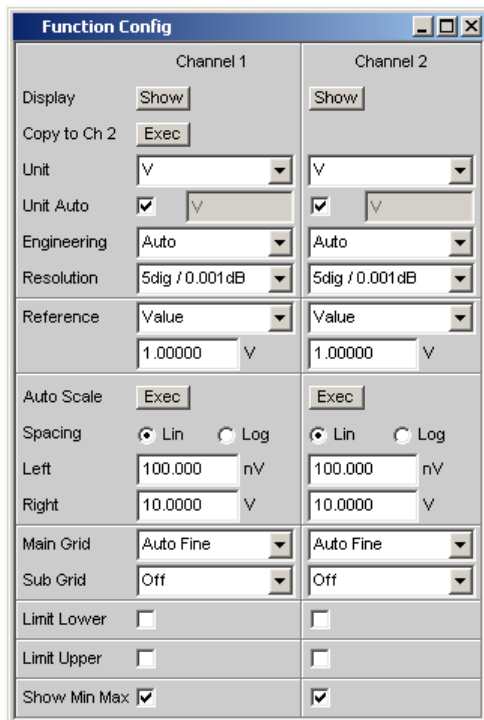
The illustration below shows the assignment of the analyzer measurement functions to the measurement result configuration panels and the measurement result displays.



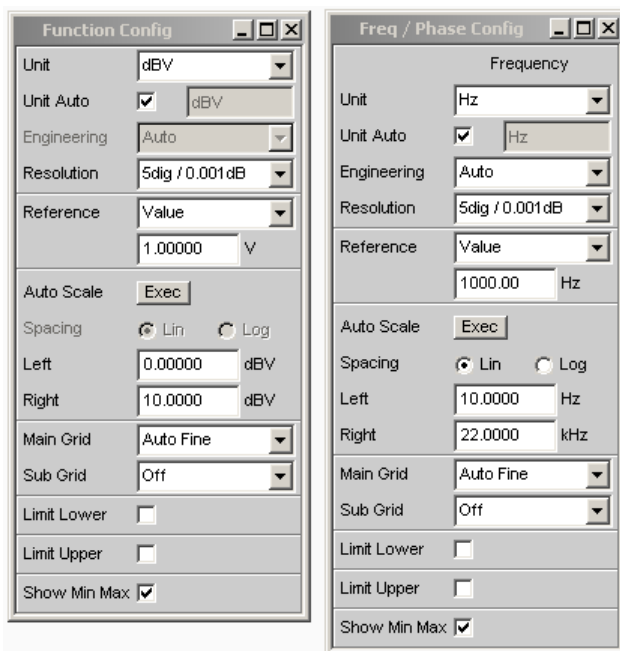
5.53.3 Parameter Fields of the Panel

The layout of the measurement result configuration panels is almost identical for all of the displays. The differences are explained in the respective setting function description.

For **two-channel instruments**, channel 1 and channel 2 can be configured separately for each measurement function. For this reason, both columns are always provided for the Function, Level Monitor and Input Peak measurement results.



For the configuration of the measurement result displays of Function, Level Monitor and Input Monitor in the case of **multichannel instruments**, all channels are configured fully identically, therefore, only one column is provided. For **two and multichannel instruments**, the configuration panel of the pure frequency measurement always has one column.



For **two and multichannel instruments**, the configuration panel for the Freq/Phase measurement results in operating mode "Freq & Phase" and "Freq & Grp Del" always features two columns.



Display

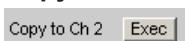


Only for two-channel instruments:

Clicking the Show button activates the combo display for a measured value.

To close it, provided it has the focus, press CLOSE or click the  button in the title bar.

Copy to Ch2



Only for two-channel instruments:

For two-channel measurements, the "Copy to Ch2" function is available for the "Function Config," "Level Mon Config" and "Input Config" measurement result configuration panels.

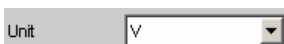
As the name says, the parameter fields from the first channel are transferred to the second channel. This happens **once** for almost all parameter fields when the Exec button is pressed.

In the Freq/Phase configuration panel, this parameter field is not available as the transfer of frequency parameter fields makes no sense in the phase area.

Remote command:

[SENSe<n1>:CONFIg:COPIother](#) on page 993

Unit



This parameter field is used to determine the unit in which the measurement results are to be displayed.

The parameter list available in this parameter field depends on whether the analog or digital analyzer instrument has been selected and under which of the 4 analyzer measurement functions the panel was opened.

- Function
- Level Monitor
- Input measurement
- Frequency/phase measurement

Approx. 30 different units are available to allow all measurement functions of the analyzer to be displayed.

If a logarithmic unit (dBu, dBV, dBr, dBm, dBFS, dBUI) is selected, or a linear unit in which negative numbers can occur (e.g. ΔV , ΔW), the following parameter field "Spacing" is displayed as not user-accessible and its parameter is set to "Lin" since it makes no sense to display measured values with a logarithmic unit or negative values on a logarithmically scaled axis.

Remote command:

[SENSe<n1>:UNIT<n2>](#) on page 1000

[SENSe3:FREQuency:UNIT](#) on page 996

[SENSe3:PHASe:UNIT](#) on page 999

Unit Auto

Used to determine whether the unit label displayed in the numeric display and in the combo display is the same as that set in the Unit parameter field above or whether it can be user-selected.

"activated"



The unit label displayed in the numeric display and in the combo display is the same as the unit set in the Unit parameter field and is therefore generated automatically by the R&S UPV.

"deactivated"

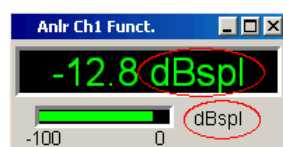


A user-definable unit label can be entered.

Example:

The output level U0dBspl which is output at a sound pressure of 0 dBspl (spl = Sound pressure level) is specified for high-quality microphones.

If the measured microphone output level is displayed in the referenced unit dBr and entered for the reference value U0dBspl, the level displayed on the R&S UPV will be in dBr, but corresponds to the sound pressure in dBspl. A numeric value using the unit dBspl would be desirable in the measurement result display. To allow this, the unit label can be changed from dBr to dBspl.



Remote command:

`SENSe<n1>:UNAuto<n2>` on page 1000

`SENSe<n1>:USERunit<n2>` on page 1001

`SENSe3:FREQuency:UNAuto` on page 996

`SENSe3:FREQuency:USERunit` on page 996

`SENSe3:PHASe:UNAuto` on page 999

`SENSe3:PHASe:USERunit` on page 999

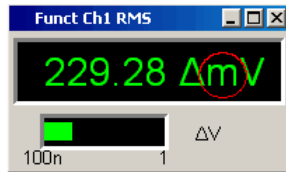
Engineering

Computes the measurement results in the numeric display field and in the combo display using a power of ten that is divisible by three.

This parameter field cannot be accessed if a dB or % unit is selected in the Unit parameter field above since these units do not usually have an engineering function.

"Auto"

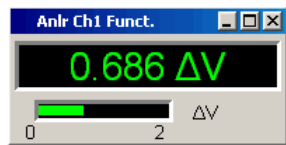
Automatic engineering assignment from p to M, for the measurement result, limits and Min/Max values; depends on the magnitude of the respective value.



"Off"

Engineering is **deactivated**.

Measurement result, limits and Min/Max values are always displayed in the format 1.0 E⁰.



"μ, m, k"

Engineering fixed to μ, m or k.

The values to be displayed are multiplied by the factor 1.0 E⁶, 1.0 E³ or 1.0 E⁻³.

Measurement results, limits and Min/Max values are displayed with the selected engineering.



Resolution

Resolution 3 dig. / 0.1dB

Used to set the number of digits used to display the measurement result, limits and Min/Max values.

"<resolution>" "x dig. / x dB"

Significance of the parameter list using an example:

5 dig. / 0.001 dB

5 dig.:

Values which are displayed with a linear unit (V, Hz, etc.) are output with 5 digits:



0.001 dB:

Values which are displayed with a logarithmic unit (dBV, dBu, etc.) are output to three decimal places:



If the numerical values can no longer be displayed with the selected resolution (e.g. because the number of places is too high with the selected engineering setting) the display is rounded in exponential style:



Reference

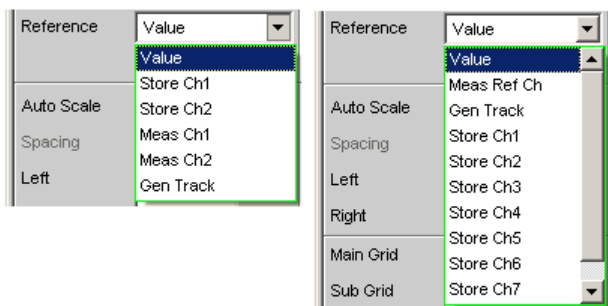
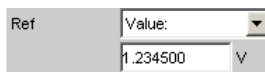


Fig. 5-45: Reference menu for two and multichannel instruments

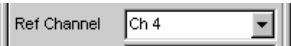
Used to select the reference for referenced units for the measurement result.

"Value "

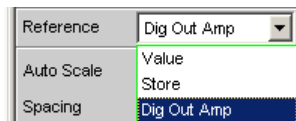
A numeric value with unit must be entered as the reference value in the parameter field below.



Note: If manual switchover is made from a variable reference value (Meas Ch1, Meas Ch2, Gen Track) to Value, the fixed reference value (Value) last valid will be restored.

- "Store" The current measurement result of a single-channel measurement is stored under Value when the ENTER key is pressed or the rotary knob/mouse key is clicked; this measurement result is then displayed as the new reference value. The reference value does not change while measurements are being performed. This option is only available for 1-channel measurement.
- "Store Ch1 ... " The current measurement result for the specified channel is stored under Value when the ENTER key is pressed or the rotary knob/mouse key is clicked; this measurement result is then displayed as the new reference value. The reference value does not change while measurements are being performed. These options are only available for two-channel or multichannel measurement.
- "Meas Ch1, Meas Ch2 " These options are only available for two-channel measurement. Every level measurement result for channel 1 or channel 2 is stored as the reference value. If a referenced unit has been selected in the "Unit" parameter field, the measurement result is referenced to this variable reference value and displayed.
- "Meas Ref Ch" This option is only available for multichannel instruments. Every level measurement result of the channel specified in the Analyzer Config panel under "Ref Channel "
- 
- is saved as a reference value. If a referenced unit has been selected in the Unit parameter field, the measurement result is referenced to this variable reference value and displayed.
- "Gen Track" The currently valid and every newly set generator voltage is stored as the reference value and can then be used for referenced display (by all channels). If a referenced unit has been selected in the "Unit" parameter field, the measurement result is referenced to this reference value and displayed.

"Dig Out Amp" Physical amplitude as reference value.



Can be selected only if the analyzer tool "Digital Audio" has been selected in the "Meas Mode" = "Common/Input" and the measurement function "Input Monitor" = "Dig Inp Amp" has been selected. The reference value is the physical amplitude configured in the Config section of the "Digital Audio" generator, "Bal Ampl" or "Unbal Ampl". Depending on which input was selected in the "Digital Audio" analyzer (Input = "Bal (D-Sub)" or "Unbal (BNC)"), the corresponding level setting from the Generator Config Panel is used as the reference value.

Remote command:

[SENSe<n1>:REFerence<n2>:MODE<n3>](#) on page 1000

[SENSe3:FREQuency:REFerence:MODE](#) on page 995

[SENSe3:PHASe:REFerence:MODE](#) on page 998

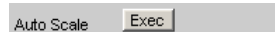
[SENSe<n1>:REFerence<n2>](#) on page 999

[SENSe3:GROupdelay:REFerence](#) on page 996

[SENSe3:FREQuency:REFerence](#) on page 995

[SENSe3:PHASe:REFerence](#) on page 998

Auto Scale



One-off automatic scaling of the bargraph.

"Exec" Clicking this button triggers **one-off** scaling of the bargraph; the current minimum and maximum values are used for the scaling process. The determined values are entered in the "Left" and "Right" parameter fields below. For multichannel instruments, the **lowest minimum value** and the **highest maximum value of all open combo displays** are determined and entered for all channels in the "Left" and "Right" parameter fields below.

Spacing



Linear or logarithmic spacing of the bargraph.

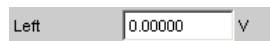
"Lin" Linear spacing of the bargraph. If a logarithmic unit (dB unit) was selected in the "Unit" parameter field, this field is displayed as not user-accessible and is set to "Lin" since it makes no sense / is not possible to use a logarithmic bargraph to display negative values, or measurement values that have a logarithmic unit.

"Log" Logarithmic spacing of the bargraph.
This parameter is only available if a linear unit (V, W, etc) has been selected in the "Unit" parameter field and its value range cannot contain negative numbers.

Example:

Although ΔV is a linear unit, the measurement results can be negative, which means that logarithmic display is not possible.

Left



Used to set the left-hand value on the bargraph.

Negative values or the value 0.00000 are not allowed when "Spacing" = "Log", in which case they cannot be entered.

Remote command:

[SENSe<n1>:LEFT<n2>](#) on page 996

[SENSe3:FREQuency:LEFT](#) on page 994

[SENSe3:PHASe:LEFT](#) on page 997

Right



Used to set the right-hand value on the bargraph.

This value must always be higher than the Left value.

Negative values or the value 0.0000 are not allowed when "Spacing" = "Log", in which case they cannot be entered.

Remote command:

[SENSe<n1>:RIGHT<n2>](#) on page 1000

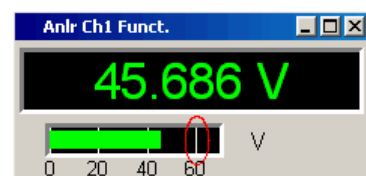
[SENSe3:FREQuency:RIGHT](#) on page 995

[SENSe3:PHASe:RIGHT](#) on page 999

Main Grid



Division of the bargraph with vertical main gridlines.



"Off" No main gridlines are used in the bargraph.

"On" With the setting "Spacing" = "Log":
Decadic division of a **logarithmically** divided bargraph with main gridlines.

"Auto Coarse, Auto Medium, Auto Fine"

With the setting "Spacing" = "Lin":

Coarse, medium or fine division of a bargraph with main gridlines.

One to two, 3 to 4 or 8 to 9 main gridlines are displayed depending on the scale end values.

Main gridlines may be **hidden** if the combo display is reduced in size.

"Divisions"

With the setting "Spacing" = "Lin":

Preset division of a bargraph with main gridlines.

The desired number of divisions is set in the parameter field below.

These main gridlines are **not** hidden if the combo display is reduced in size.

"Steps"

With the setting "Spacing" = "Lin":

Preset division of a bargraph with linear scaling in a fixed step size.

The step size is set in the parameter field below.

These main gridlines are **not** hidden if the combo display is reduced in size.

Division

With the setting "Spacing" = "Lin":

Main Grid	Divisions
	3

Used to enter the number of main gridline divisions for a bargraph with linear scaling.

If, for example, 2 is entered, the bargraph is divided into **two sections**, i.e. **one** main gridline is displayed.

Steps

With the setting "Spacing" = "Lin":

Main Grid	Steps
	10.0000

Used to enter the main gridline step size for a bargraph with linear scaling.

The unit of the value is not linked to the unit selected in the "Unit" parameter field; the value can be given in different units.

Sub Grid

Sub Grid	2
----------	---

Subdivision of the main gridlines in a bargraph using subgridlines.

"Off" Subgridlines are deactivated.

"2, 4, 5"

With the setting "Spacing" = "Lin":

Subdivision of the main gridlines of a **linearly** divided bargraph into 2, 4 or 5 sections.

If, for example, **2** is selected, the area between two main gridlines is divided into **2** sections, i.e. **one** subgridline appears between the main gridlines.

These subgridlines are **not** hidden if the combo display is reduced in size.

"Coarse, Fine "

With the setting "Spacing" = "Log":

Coarse or fine subdivision of the main gridlines of a **logarithmically** divided bargraph with subgridlines.

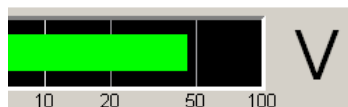


Fig. 5-46: Coarse: Subgridlines 2 and 5 only

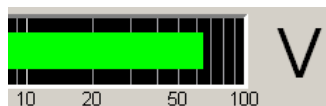


Fig. 5-47: Fine: All subgridlines

Limit Lower

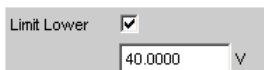
Limit Lower

Used to activate/deactivate the lower limit check.

"activated"

The lower limit check is activated.

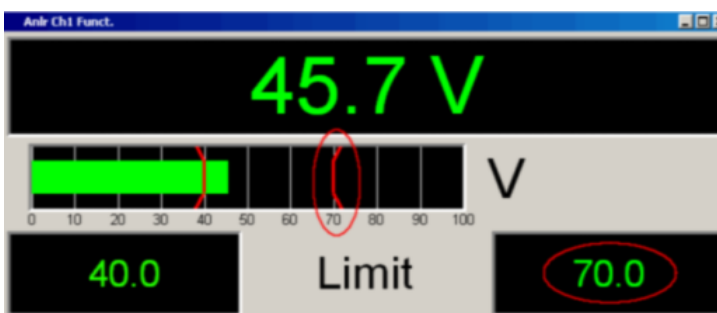
The parameter field below is used to enter a lower limit in the units selected in the Unit parameter field.



A lower limit can be defined for the measurement result; every measured value is then compared with this limit.

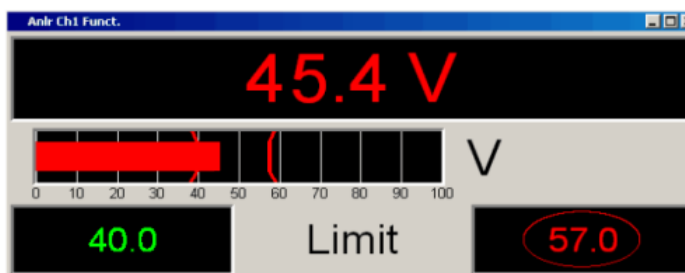
If a relative unit is selected, the associated reference value (a few parameter fields higher up) is used.

The lower limit is displayed as a value (bottom left) and as a red limit marker in the bargraph.



As soon as a limit is underranged, the measurement result and bargraph change from green to red; if the limit violation no longer exists, the measurement result and bargraph are displayed in green again. A red measured value in the numeric display also indicates a limit violation:

In order to monitor limit violations over a long period of time without having to watch the measurement result display continuously, the lower limit is displayed permanently in red as soon as it is underranged after the START key has been pressed.



START key or re-entering the limit resets the hold function. This hold function is not visible in the numeric display.

"deactivated" The lower limit check is deactivated.

Remote command:

[SENSe<n1>:LIMLower<n2>](#) on page 997

[SENSe<n1>:LIMLower<n2>:VALue](#) on page 997

SENSe<n1>: <n1> = 1 | 2 | 6 (function measurements | Input Monitor | Level Monitor) ;

LIMLower<ch>: <ch>= 1 | 2 (2 for two-channel instruments only)

[SENSe3:FREQuency:LIMLower](#) on page 994

[SENSe3:FREQuency:LIMLower:VALue](#) on page 994

SENSe3 = Frequency, phase or group delay measurement

[SENSe3:PHASe:LIMLower](#) on page 997

[SENSe3:PHASe:LIMLower:VALue](#) on page 998

SENSe3 = Frequency, phase or group delay measurement

Limit Upper

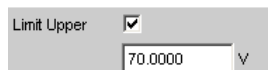
Limit Upper

Used to activate/deactivate the upper limit check.

"activated"

The upper limit check is activated.

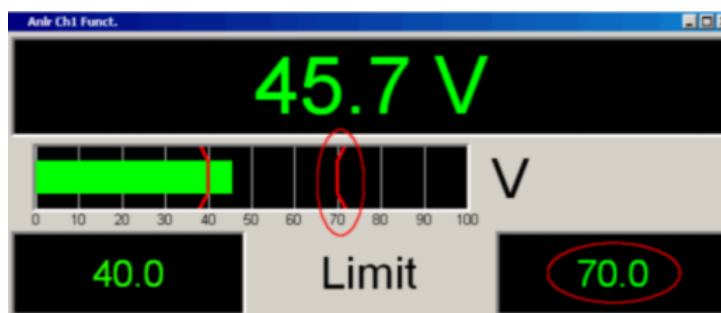
The parameter field below is used to enter an upper limit in the unit selected in the Unit parameter field.



An upper limit can be defined for the measurement result; every measured value is then compared with this limit.

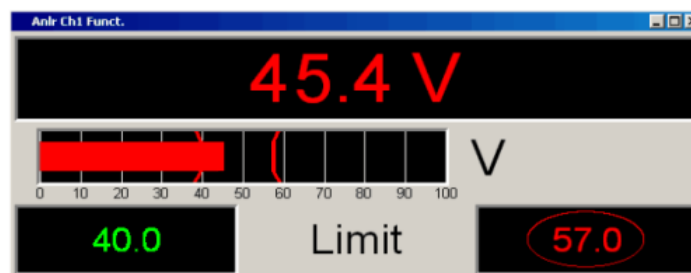
If a relative unit is selected, the associated reference value (a few parameter fields higher up) is used.

The upper limit is displayed as a value (bottom right) and as a red limit marker in the bargraph.



As soon as a limit is overranged, the measurement result and bargraph change from green to red; if the limit violation no longer exists, the measurement result and bargraph are displayed in green again. A red measured value in the numeric display also indicates a limit violation:

In order to monitor limit violations over a long period of time without having to watch the measurement result display continuously, the upper limit is displayed permanently in red as soon as it is overranged after the START key has been pressed.



START key or re-entering the limit resets the hold function. This hold function is not visible in the numeric display.

"deactivated" The upper limit check is deactivated.

Remote command:

`SENSe<n1>:LIMUpper<n2>` on page 997

`SENSe<n1>:LIMUpper<n2>:VALue` on page 997

`SENSe<n1>: <n1> = 1 | 2 | 6` (function measurements | Input Monitor | Level Monitor) ;
`LIMLower<ch>: <ch>= 1 | 2` (2 for two-channel instruments only)

`SENSe3:FREQuency:LIMUpper` on page 995

`SENSe3:FREQuency:LIMUpper:VALue` on page 995

SENSe3 = Frequency, phase or group delay measurement

`SENSe3:PHASe:LIMUpper` on page 998

`SENSe3:PHASe:LIMUpper:VALue` on page 998

SENSe3 = Frequency, phase or group delay measurement

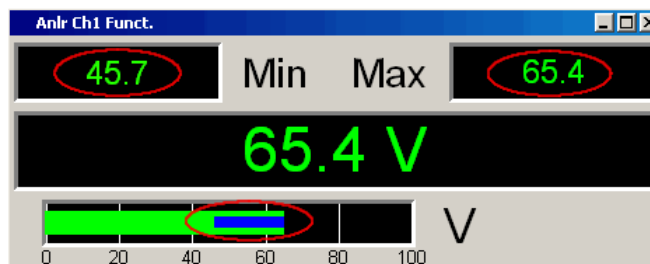
Show Min Max

Show Min Max

Used to activate/deactivate the Min/Max display.

Two numeric values and the ends of the blue bar inside the green bar indicate the lowest and highest values measured.

"activated" The lowest and highest value measured since START are displayed. The Min/Max values are shown in the top left and right corners of the combo display.



The ends of the blue Min/Max bar indicate the lowest and highest values measured since START.

START resets min/max value recording and the collection of measured values begins again.

"deactivated" The Min/Max display is deactivated.

5.53.4 Softkey Menu

Two-channel instruments:

Every combo display has its own softkey menu. The settings selected in the menu apply exclusively to the associated combo display and affect no other combo display.

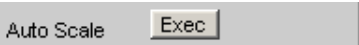



Multichannel instruments:

If a softkey menu from a combo display of a specific measurement function (e.g. Level Monitor) was used, the chosen setting affects **all** open combo displays for this mea-

surement function. In the case of multichannel instruments, there are no customized settings for individual channels.

The settings for "Store Reference", "Show Min/Max", "Show Lim Low" and "Show Lim Upp" can therefore be immediately displayed 1 to 1 in the associated measurement result configuration panel.



"Store Reference "	The current measured value is stored as a reference value. If, for example, the reference unit dBr is selected as the unit, the next measured value is 0.0 dBr.
"Autoscale "	One-time scaling of the bargraph on the basis of the minimum and maximum values. Corresponds to  in the associated configuration panel.
"Show Min Max "	If the box is checked, the min/max values are displayed. Corresponds to  in the associated configuration panel.
"Show Lim Low "	If the box is checked, the lower limit is displayed. Corresponds to  in the associated configuration panel.
"Show Lim Upp "	If the box is checked, the upper limit is displayed. Corresponds to  in the associated configuration panel.
"Restart Min/Max "	Resets min/max value recording and the collection of measured values begins again. Corresponds to START
"Restart Lim Violation "	Resets the red color marking (measured value, bar and limit) for indicating a limit violation and restarts a test for a limit violation.
"Config "	Opens the configuration panel for this combo display.

5.54 Limit Monitoring

Both traces/bar graphs and measurement results can be monitored to determine whether limits or limit curves have been overranged or underranged.

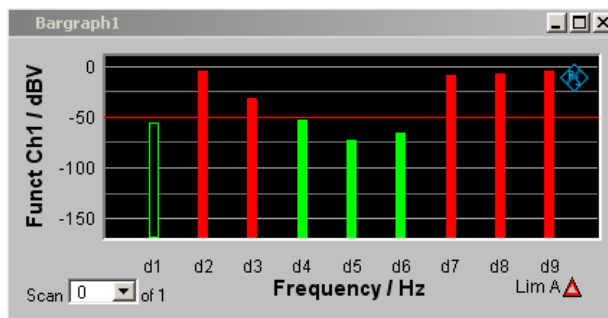
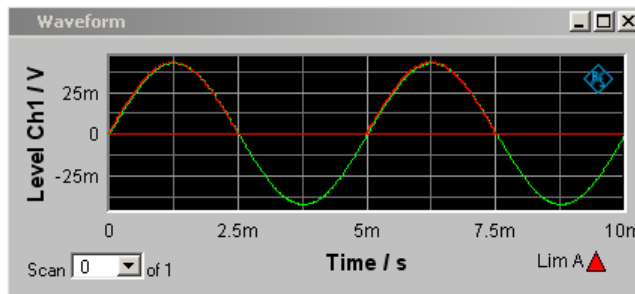
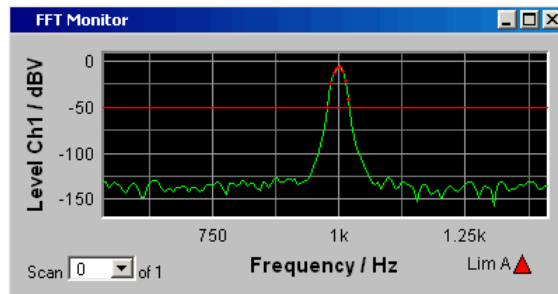
5.54.1 Traces and Bar Graphs

Upper and lower limits or a limit curve can be entered separately for Trace A and Trace B in every display configuration panel for every graphic subsystem.

Limit entered as a value:

Limit Upper	<input checked="" type="checkbox"/>	<input type="checkbox"/>	<input checked="" type="checkbox"/>
Source	Value		Value
	-50.0000		-50.0000
	dBV		dBV

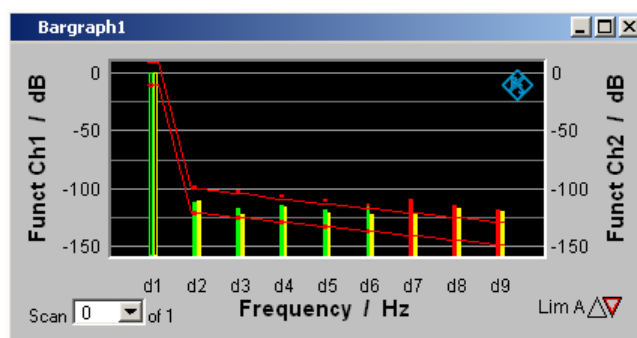
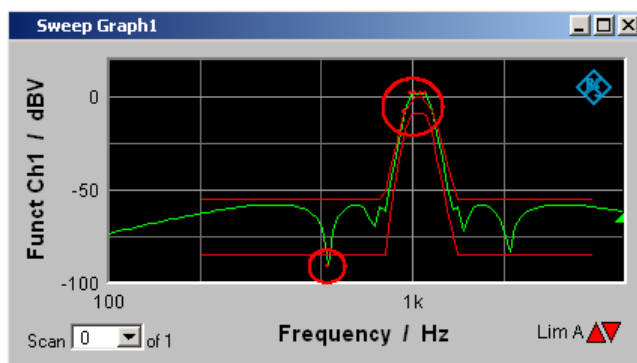
The limit in a graphical display is shown as a straight line.



Limit entered as a curve:

A limit curve can be entered only for the graphic systems Sweep, FFT Function, Bar Graph and PESQ. A limit curve makes no sense for the Waveform graphic system and is not offered.

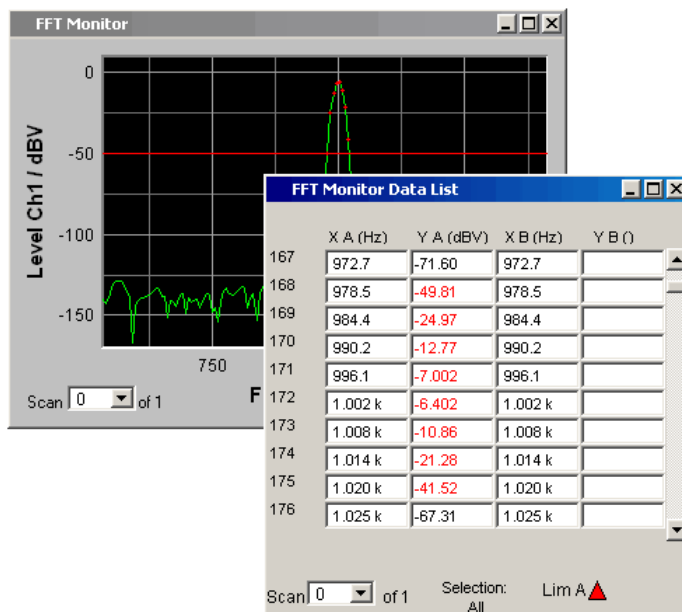
Limit Upper	<input checked="" type="checkbox"/>
Source	File
	Lim.upp
	...



Each measured value is compared with the limit value or the limit curve and in the event of a limit violation is identified as a red dot in the trace display or as a red bar in the bar graph.

If multi-scan recording is performed in the Sweep Graph 1...4 graphic subsystems, all of the scans of a trace are checked against the associated limit or limit curve.







In the list of measured values, rows with measured values out of the tolerance are displayed in red (see [chapter 5.51, "Result List"](#), on page 735).



In addition to the red dots in the trace or the red bars in the bar graph, in the lower right corner of the graphic display and the measured value list there is an indicator of limit violations, so that it is possible to see at a glance whether any limit violation exists. The interpretation is as follows:

Display for limit violations

Lim A  Lim B 

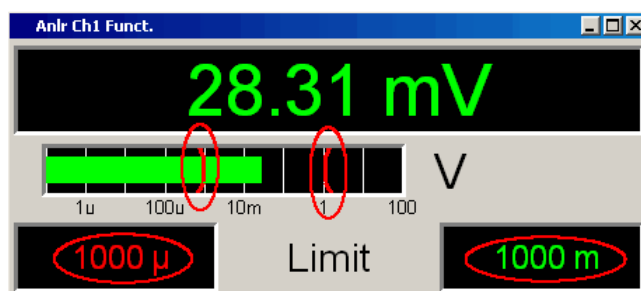
"Limit Upper"		Limit Upper is activated and there is no limit violation.
"Limit Lower"		Limit Lower is activated and there is no limit violation.
"Limit Upper past"		The "Limit Upper" value has been violated in the past but there is currently no limit violation. The violation is indicated until the START key is pressed again.
"Limit Lower past"		The "Limit Lower" value has been violated in the past but there is currently no limit violation. The violation is indicated until the START key is pressed again.
"Limit Upper current"		The "Limit Upper" value is currently being violated.
"Limit Lower current"		The "Limit Lower" value is currently being violated.

5.54.2 Measurement Results

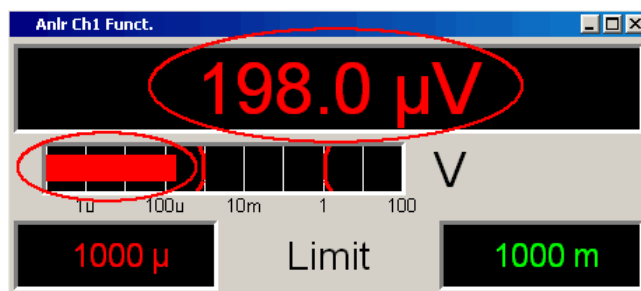
A lower and upper limit can be specified in any measurement result configuration panel:



In the combo display, the limits are displayed as red limit markers (brackets) in the bar graph and as numeric values:



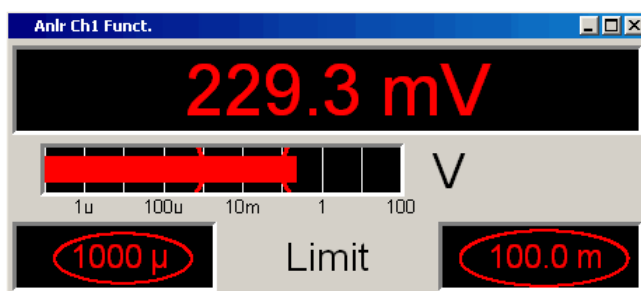
A red measured value and bar indicate that there is a limit violation:



A red measured value in the numeric display also indicates a **current** limit violation:

	Func.	Level-Mon.	Input.	Freq.
ANLR1 Ch1	495.0 μV	500 μV	705 μV	50.0 Hz
ANLR1 Ch2	99.5 mV	101 mV	142 mV	50.0 Hz

In order to indicate that the lower or upper limit was violated in the past, the lower or upper limit is displayed in red until the START key is pressed, which resets the hold function and restarts monitoring of the measured values:



This hold function is **not** visible in the numeric display.

5.55 Measured value Sequences

Measured value sequences consisting of acquired function measurement results, sweeps, FFT data, Waveform data, Bar Graph data, PESQ/POLQA data or Impulse Response data can be stored in a file for different purposes:

- To load the measured values again as a report, to permit comparison or to allow processing at a later stage. When loaded using commands in the display panel, the series of measured values are initially displayed exactly as they were when saved. They can, however, be rescaled or, for example, converted into different units.
- The files are stored in ASCII format so that they can be easily imported into other programs where the data can be processed further (e.g. Microsoft Excel). See section [chapter 5.58, "Format"](#), on page 780 for information on the ASCII format and how data can be imported into other programs.

5.56 Store

5.56.1 Trace Files

When a **Trace list** is saved no distinction is made between Trace A or Trace B.

Both traces are always stored to the file, provided that both traces are switched on. In the multiscan mode, all scans selected by means of the "History" line are stored to the file. If "Show Min Max " is enabled, these scans are stored too.

In addition to measured value sequences, a further range of information is stored necessary so that upon loading the trace list the graph is displayed just as when it was saved:

- Functionality on the x and y-axes
- Axis labeling
- Display units on the axes
- Scaling on the axes (lin/log)
- Left/right and top/bottom values of the axis scaling
- Limit values for the y-axes
- Reference values on the axes

When the trace file is loaded, this information affects the corresponding DispConfig panel so that the parameter fields reproduce the information stored in the file.

Exception: Exception: If "Hold " is set in the parameter fields "Reference ", "Limit Upper " and/or "Limit Lower " the current settings are not overwritten.

The format in which the trace list is stored is the same for all subsystems.

If the file name is specified without an extension, the suggested file name extension is `.TRC`, but any desired extension can be specified.

For a detailed description of the storage format, see section [chapter 5.58.1, "Trace Files"](#), on page 780.



5.56.2 Equalization Files

An **equalization list** is a table that contains frequency points and associated gain factors. The list can be used to apply a predefined frequency response to the generator. The set amplitude of the generator is changed as a function of frequency in accordance with the values specified in the table. Frequency values are stored to the list in the basic unit of Hz, irrespective of the unit used for x-axis value display.

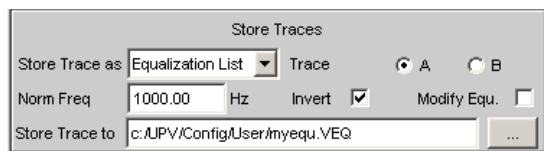
An equalization list in ASCII format is generated from the current measured value sequence, taking into account the settings made under "Trace ", "Norm Freq ", "Invert " and "Modify Equ. ". The list is stored to a file, which can be loaded by selecting it in the "Equalizer" line in the Generator Function panel.

An equalization file may contain up to 1024 X/Y pairs, because a generator sweep can have a maximum of 1024 sweep points. If a measured value sequence contains more than 1024 X/Y pairs, data will be compressed automatically such that only every 2nd, 4th, 8th X/Y pair and so forth is stored to the equalization file.

If an equalization list is generated from a multiscan display (including also the Min/Max scans of a single-scan display), the Y values of the currently selected scan are taken to generate the list.

If the file name is specified without an extension, the suggested file name extension is .VEQ, but any desired extension can be specified.

For a detailed description of the storage format, see section [chapter 5.58.2, "Equalization Files"](#), on page 784.



5.56.3 Sweep Lists

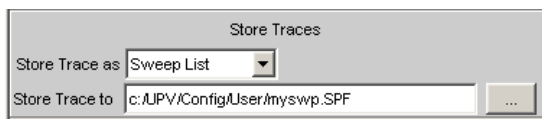
A **Sweep List** contains any desired sweep axis. Since the individual values of X are extracted from a current measured value sequence, they are in ascending order. If the file is then manually processed, the **separations** of the sweep points can be freely selected in order to place a greater number at places of particular interest without drastically increasing the total number of sweep points. The sweep points must, however, be specified in ascending or descending order – they must not change direction. The sweep points are processed by the sweep system in the order in which they are listed. There must be at least two different points in the list.

The file can contain a maximum of 1024 X values, because a generator sweep can have a maximum of only 1024 sweep points. If a measured value sequence has more than 1024 X/Y pairs, the data is compressed automatically by saving only every 2nd, 4th, 8th, etc. value for the sweep list.

If a sweep list is saved from a multiscan display (including the Min/Max scans in the case of a single scan display), the currently selected scan plays no role, since the X values are the same for all scans.

If the file name is specified without an extension, the suggested file name extension is .SPL, but any desired extension can be specified.

For a detailed description of the storage format, see section [chapter 5.58.3, "Sweep Lists"](#), on page 785.



5.56.4 Limit Files

A **Limit list** contains X and Y data that has been extracted from the current measured value sequence. When it is saved, no distinction is made about whether the file will be used later as an Upper Limit or as a Lower Limit. This depends on whether the file is **loaded** as an Upper Limit file or as a Lower Limit file. A limit list that has been obtained from a measured value sequence usually has more interpolation points than necessary, and it is therefore often necessary to process the file further. For information on how to do this see section [chapter 5.59, "Editing"](#), on page 788.

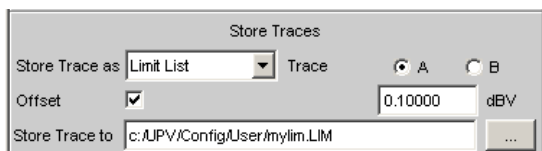
A limit list must contain at least two different points forming a straight line.

If a limit list is saved from a multiscan display (including the Min/Max scans in the case of a single scan display), the Y values are extracted from the currently selected scan.

The file can contain a maximum of 1024 X/Y pairs.

If the file name is specified without an extension, the suggested file name extension is .LIM, but any desired extension can be specified.

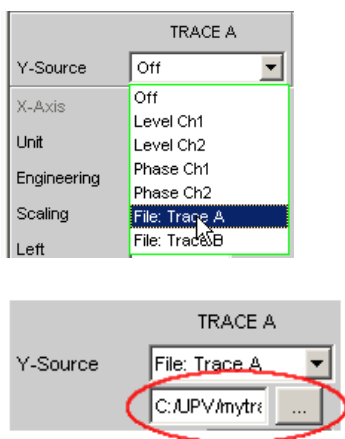
For a detailed description of the storage format, see section [chapter 5.58.4, "Limit Files"](#), on page 786.



5.57 Load

5.57.1 Trace Files

When **traces** are loaded, unlike when they are saved, a distinction is made between Trace A or Trace B. Since the trace file always contains both traces, provided both traces were enabled when saved, a decision is made via the parameter field "Y-Source" = File: Trace A or File: Trace B about which trace to load from the file.



All trace files have the file name extension *.TRC as a default setting, that is, if the file name only is specified, without an extension, this extension is automatically added. Other extensions are allowed. Clicking on the ... button opens the file selector with all known properties.

During the loading procedure, the system tests whether the trace file can be loaded. When trace files are stored an identifier is entered so that it is obvious from which graphic system the file was saved. Trace files can only be loaded into the graphic system from which they were saved; in all other cases the attempt to load is ignored and an error message is issued. Exception: When Bar Graph trace files are being loaded, the system recognizes from the number of stored lines whether the file matches the set measurement function. For example, a Bar Graph trace file with 9 frequency lines in a bar graph display would be rejected for the measurement function DFD, because only 5 lines are expected there.

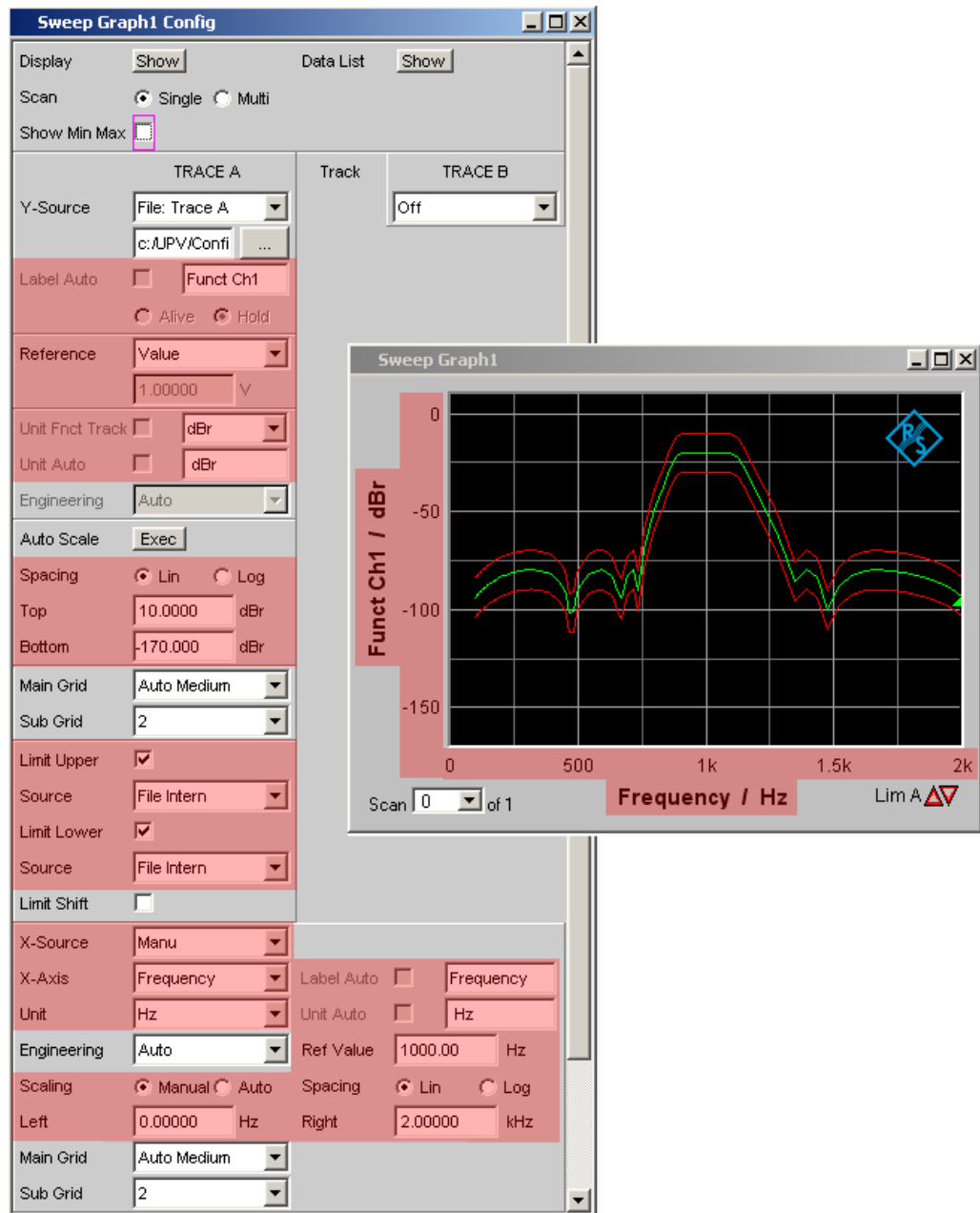
However, if there is ever a need to load a trace file of a different type into a graphic system, acceptance of the file can be forced through by changing the trace file identifier in an ASCII editor; see section [chapter 5.59, "Editing"](#), on page 788.

If a trace file cannot be loaded, or if "Y-Source" = File: Trace A or File: Trace B addresses a trace file in which the required trace does not exist, an appropriate warning is issued and the loading procedure is terminated. The previous trace in the graphical display remains unchanged.

The content of the trace files defines the appearance of the DispConfig panel and the associated display panel.

The appropriate scan is loaded from the trace file, depending whether "Scan" = Single or Multi in the parameter field and whether "Show Min Max" is set.

The following figure shows the parameter fields and wordings which are influenced by the file content.



If the file contains both reference traces and limit traces, **File Intern** is displayed in the corresponding parameter fields. "File Intern" means that there is no individual value (for example in the case of a "Reference", this would be "Limit Upper" or "Limit Lower" with the setting Value) but instead a trace, and that this trace has been taken from a file loaded at Y-Source = File: Trace A or File: Trace B.

Furthermore, all Auto and Tracking checkboxes such as Label Auto, Unit Func Track, Unit Auto etc. are deactivated and grayed out so that they cannot be used. All parameter fields that allow Auto settings, such as "X-Source" or "Scaling", are set to "Manual", since they are preset by the file content.

If Hold is selected in the parameter fields "Reference", "Limit Upper " and/or "Limit Lower ", the **current settings** remain unchanged and are **not altered** by loading a trace file.

Switching the Y-Source:

The display and deletion of traces largely depends on switching the "Y-Source", that is, the source of the traces.

The "Y-Source" parameter field offers two sources for the recording and display of traces:

- **Traces from measurements** are all settings other than "File: Trace A" or "File: Trace B", e.g. Funct CH1, Level Ch1, Phase Ch1 etc.
- **Traces** can be loaded **from File** with File: Trace A or File: Trace B.
- **Off** deletes the trace.

Deleting traces:

Traces are generally always deleted either by using the START key or by switching the "Y-Source " to Off.

When the "Y-Source " is switched between measurement (e.g. "Funct Ch1") and file (e.g. File: Trace A), a trace is always deleted when the basic unit changes.

5.57.1.1 Switching measurements in multiscan mode:

The reaction of the R&S UPV depends largely on whether or not the basic unit changes.

Example:

Basic unit does not change:

The RMS measurement function is set in the analyzer. The selected display unit is dBV. Funct CH1 is set in the Sweep Graph Config panel as the "Y-Source" which means that the results of the RMS measurement are displayed on the y-axis. Also in the analyzer the Level Monitor is set with the measurement function "Peak" and the display unit "dBu".

If the "Y-Source" is switched in the Sweep Graph Config Panel from Funct CH1 to LevelMon Peak Ch1, the basic unit does not change; in both cases, Volt is the basic unit of dBV and dBu!

The current scan is retained.

If the switch takes place during a measurement, the new scan is linked to the old scan already drawn. If the measurement was halted, the new scan is drawn after the SINGLE BUTTON IS PRESSED

The scans in the other channel are unaffected.

Example:**Basic unit changes:**

The RMS measurement function is set in the analyzer. The selected display unit is dBV. "Funct CH1" is set in the Sweep Graph Config panel as the "Y-Source", which means that the results of the RMS measurement are displayed on the y-axis. Also in the analyzer the phase measurement is set with the display unit Rad.

If the "Y-Source" is now switched in the Sweep Graph Config panel from "Funct CH1" to Phase, the basic unit changes, since the basic unit of dBV is Volt and the basic unit of Rad is °.

The current scans are deleted.

If the switch takes place during a measurement, the new scan is redrawn in the cleared graphic window. If the measurement was halted, the new scan is drawn after the SINGLE button is pressed.

The scans in the other channel are unaffected.

5.57.1.2 The last file that was loaded determines the x-axis

If files with different x-axes are loaded one after the other, the last file always determines the x-axis. If a sweep with a different x-axis is then loaded, it will determine the x-axis.

5.57.1.3 Loading a trace file with measurement in progress or halted

On switching from a measurement to loading a trace from a file (e.g. "Y-Source " from "Funct CH1" to File: Trace A), deletion takes place and the trace from the file is displayed immediately, provided the basic unit is permitted in the current graphic subsystem and the basic unit is suitable for the x-axis. The panel content changes according to the parameters stored in the trace file, as described above.

Any attempt to load a trace file containing the results of a phase measurement into the Waveform graphic system would be ignored with an appropriate warning, since a phase measurement result is not provided for in the Waveform graphic system. The current trace would be retained.

5.57.1.4 Switching from a loaded trace file to measurement:

On switching from a trace loaded from file to measurement (e.g. "Y-Source " from File: Trace A to FFT Level Ch1), the current scan is retained, provided the basic unit is suitable. The new scan is drawn when the SINGLE button is pressed. This reaction is particularly important, since in this way new measured value scans can be appended to the scans loaded from a file! If the basic unit is not suitable, the current scans are deleted.

5.57.1.5 Loading trace files, depending on the single scan or multiscan setting:

Depending whether "Scan " = Single or "Scan " = Multi the appearance changes when loading or recording scans.

"Scan " = Multi

If a trace is loaded from a file which contains a multiscan, either all scans are taken from the file or only as many as the number specified in the "History" parameter field. If the file contains only a single scan, this scan is interpreted as a multiscan with only one scan. If "Show Min Max " is checked and Min/Max scans are stored in the trace file, these are also loaded.

"Scan " = Single

If a scan is loaded from a file which contains a multiscan, the first scan is loaded from it. If "Show Min Max " is checked and Min/Max scans are stored in the trace file, these are also loaded. A single scan is then displayed with a maximum of three scans per channel.

If "Y-Source" is switched to File: Trace A or File: Trace B, the "Alive / Hold " parameter field is shown as not user-accessible and has the setting "Hold " since an Alive/Hold option makes no sense for a trace loaded from file.

If "Y-Source" is switched to measurement, the "Alive / Hold " parameter field is again accessible and has the setting "Alive".

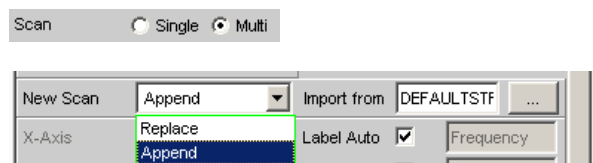
On switching from "Scan " = Single to "Scan " = Multi the single scan is retained and "New Scan " is forced to the Append mode. New scans are added each time the SINGLE button is pressed.

On switching from "Scan " = Multi to Scan = the last scan of the current multiscan is retained.

5.57.1.6 Appending or substituting scans

The parameter field "New Scan" = Append or Replace defines whether scans are appended to existing scans or whether a single scan replaces another.

The parameter fields "New Scan " and "Import from " are offered only for multiscan ("Scan" = "Multi"), since new scans can be appended or substituted only in multiscan recording.



The scans to be appended or substituted may come from a measurement or a file. By far the most frequently used setting is "New Scan " = Append.

There are a number of options for appending or substituting scans. These options depend on the following settings and conditions:

- "Alive / Hold "
- Append or substitute measurement scan
- Append or substitute scan from file
- Is a measurement in progress or halted?
- Which scans and how many scans are stored in a file?

- Does the scan from the file suit the current setting?

The following section should cover the most important possibilities.

5.57.1.7 Appending Measurement Scans to Existing Scans

parameter field "New Scan " = Append

parameter field "Alive / Hold " to Alive.

SINGLE triggers a measurement and appends the new scan to the existing scans.

5.57.1.8 Measurement Scan Replaces an Existing Scan

parameter field "New Scan " = Replace

parameter field "Alive / Hold " to Alive.

Use the NEXT SCAN key to select the scan to be replaced.

SINGLE triggers a measurement and replaces the selected scan with the new scan.

5.57.1.9 Importing Scans from a File and Appending to Existing Scans

parameter field "New Scan " = Append

Parameter field "Alive/Hold" to Hold.

If the parameter field "Alive/Hold" is on "Alive" and a measurement is in progress (single measurement not yet finished or continuous measurement), any attempt to import a file is ignored and a message is issued.

If the parameter field "Alive / Hold " is on "Alive" and a measurement is finished, a scan / multiple scans can be imported from a file and appended to the existing scans.

If an import is allowed, it largely depends on the content of the source file to be imported whether and how the operation proceeds.

A file will be imported only if the basic units from the file match the "Y-Source" setting, or if the unit is allowed in the graphic subsystem. For example if "Y-Source " = Funct Ch1 and the set analyzer measurement function = "RMS", a trace file with the basic unit Volt is suitable. A trace file with the basic unit % would be ignored and an error message would be issued.

When loading a trace file it must be clearly specified which trace is to be loaded from the file (File: Trace A or File: Trace B).

This choice is not needed when importing. Provided the basic units are suitable for the current setting, the file content defines what and how much will be imported:

- If only Trace A or only Trace B is activated in "Y-Source" and the file to be imported contains only one trace and it does not matter whether it is Trace A or Trace B, then this trace is imported.

- If Trace A and Trace B are both activated and the file to be imported contains only one trace, and it does not matter whether it is Trace A or Trace B, this trace is imported to Trace A **and** Trace B.
- If only Trace A or only Trace B is activated and the file to be imported contains a stereo trace, that is, Trace A and Trace B, the corresponding trace is imported, namely A to A or B to B.
- If Trace A and Trace B are both activated and the file to be imported contains a stereo trace, then both traces are imported, namely A to A and B to B.

The following applies to all the cases listed:

All suitable scans from the file are appended. Starting from the first scan, all scans are appended from the file until the maximum number of 20 scans is reached.

If "Hold" is selected in the parameter fields "Reference ", "Limit Upper " and "Limit Lower ", the current settings are not changed by the imported scan.

5.57.1.10 Importing Scans from a File and Replacing an Existing Scan

parameter field "New Scan " = Replace

Parameter field "Alive/Hold" to Hold.

If the parameter field Alive/Hold is on "Alive" and a measurement is in progress (single measurement not yet finished or continuous measurement), any attempt to import a file is ignored and a message is issued.

If the parameter field "Alive/Hold" is on "Alive" and a measurement is finished, a scan can be imported from a file and replace a scan.

If the default settings agree, it largely depends on the content of the import file whether and how the operation proceeds.

A file will be imported only if the basic units from the file match the "Y-Source" setting, or if the unit is allowed in the graphic subsystem. For example if "Y-Source " = Funct Ch1 and the set analyzer measurement function = "RMS", a trace file with the basic unit Volt is suitable. A trace file with the basic unit % would be ignored and an error message would be issued.

When loading a trace file it must be clearly specified which trace is to be loaded from the file (File: Trace A or File: Trace B).

This choice is not needed when importing. Provided the basic units are suitable for the current setting, the file content defines what and how much will be imported:

- If only Trace A or only Trace B is activated in "Y-Source" and the file to be imported contains only one trace and it does not matter whether it is Trace A or Trace B, then this trace is imported.
- If Trace A and Trace B are both activated and the file to be imported contains only one trace, and it does not matter whether it is Trace A or Trace B, this trace is imported to Trace A **and** Trace B.
- If only Trace A or only Trace B is activated and the file to be imported contains a stereo trace, that is, Trace A and Trace B, the corresponding trace is imported, namely A to A or B to B.

- If Trace A and Trace B are both activated and the file to be imported contains a stereo trace, then both traces are imported, namely A to A and B to B.

The following applies to all the cases listed:

If the file contains more than one scan a warning is given and the **first scan** from the file is taken for the Replace function.

If "Hold" is selected in the parameter fields "Reference ", "Limit Upper " and "Limit Lower " the current settings are **not changed** by the imported scan. .

5.57.2 Equalization Files

The loading of equalization files takes place in the generator; see section [chapter 5.6, "Generator Signals"](#), on page 287.

Equalization files from the R&S UPL can still be used.

5.57.3 Sweep Lists

The loading of sweep lists takes place in the generator; see section on page [chapter 5.6, "Generator Signals"](#), on page 287.

Sweep lists from the R&S UPL can still be used.

Sweep lists from the R&S UPL have different file name extensions:

- SPF for frequency values in Hz
- SPV for level values in V, FS or UI
- SPO for on-time values in s
- SPI for interval values in s
- DWL for dwell time values in s

From these file name extensions the R&S UPV recognizes whether the loading procedure is allowed. It is therefore recommended that the file name extensions of the old R&S UPL files should not be changed!

5.57.4 Limit Files

The loading of **limit files** takes place in the DispConfig panels in the parameter fields "Limit Upper ", "Source " = File and "Limit Lower ", "Source " = File.

The Y values of the limit files are always interpolated onto the current x-axis, so that the desired trace is always produced regardless of the number of interpolation points in the limit file. Limit files from the R&S UPL can also be used but, in contrast to limit files from the R&S UPV , there is no plausibility check as to whether the numerical values in the file match the current setting, since R&S UPL files do not contain the associated units.

5.58 Format

5.58.1 Trace Files

All trace data is stored in plain text in ASCII format. The format has been selected so that the data can be processed without a problem in EXCEL.

Structure of the trace file:

Subsystem: UPV FFT TRACE FILE									
Title: Titletext									
Comment: Commenttext									
X Axis;			Trace A;			Trace B;			
X Function			Trace A Function			Trace B Function			
Frequency			Funct Ch1			Funct Ch2			
X-Axis-Label:			Y1-Axis-Label:			Y2-Axis-Label:			
Frequency			Input RMS analog Ch1			THD+N digital CH2			
X-Unit: Hz			A-Unit: dBV			B-Unit: dB			
X-Spacing:			A-Spacing: LIN			B-Spacing: LIN			
LOG									
X-Left: Value			A-Bottom: Value			B-Bottom: Value			
X-Right:			A-Top: Value			B-Top: Value			
Value									
VOID			A-LimLow: Value, FILE or VOID			B-LimLow: Value, FILE or VOID			
VOID			A-LimUpp: Value, FILE or VOID			B-LimUpp: Value, FILE or VOID			
Scan #1			A-Comment: Scan Labeltext			B-Comment: Scan Labeltext			
X-Basic-Unit:			A-Basic-Unit: V			B-Basic-Unit: V			
Hz									
X-Ref: Value			A-Ref: Value, FILE or VOID			B-Ref: Value, FILE or VOID			
A-X/	A-Y	A-	A-	A-RefY	B-X/	B-Y	B-	B-	B-RefY
datacou		LimLow	LimUpp	in V	datacou		LimLow	LimUpp	in V
nt					t				
20.0000	0.201	0.2	0.3	1.01	20.0000	-98.8	-98.5	-90	VOID
..			VOID
20000.0	0.203	0.25	0.4	2.03		-98.1	-98.5	-90	VOID
Scan #2	A-Comment: Scan Labeltext					B-Comment: Scan Labeltext			
X-Ref:	A-Ref: Value or VOID					B-Ref: Value or VOID			
Value									
X/datacou	A-Y	A-	A-	A-RefY	B-X/	B-Y	B-	B-	B-RefY
unt		LimLow	LimUpp	in V	datacou		LimLow	LimUpp	in V
					t				
20.0000	0.201	0.2	0.3	1.01	20.0000	-98.8	-98.5	-90	VOID
..			VOID
20000.0	0.203	0.25	0.4	2.03		-98.1	-98.5	-90	VOID

The individual parameters are TAB separated.

Black: Explanation of fields. These explanations are not stored in the trace file.

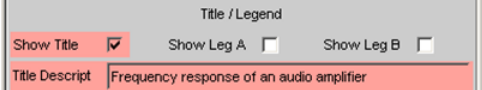
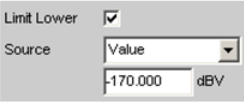
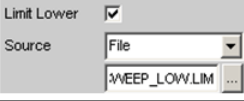
Green: Fixed entries in ASCII format to facilitate assignment of the following data.

Red: Entries which change. These entries are depending on the graphic system and the settings in the corresponding DispConfig panel.

FILE: Not a fixed value, but a trace. Can occur in the case of Limit and Reference.

VOID: No value present because the trace is turned off, or in order to fill a missing range in the event that Trace A and Trace B have different lengths.

Explanation of terms:

Subsystemenkennung			Kennung von welchem Grafik-Subsystem aus diese Trace-Datei angelegt wurde, z.B. UPV SWEEPLIST FILE UPV SWEEP TRACE FILE UPV FFT TRACE FILE UPV WAVEFORM TRACE FILE UPV BARGRAPH TRACE FILE
Title			Eintrag aus dem Grafik-Panel 
Comment			Gerätebezeichnung, Seriennummer, Datum und Uhrzeit wann dieses Trace-File abgespeichert wurde, z.B. "R&S UPP800 Serial no: 123456, 2012-24-5, 12:3:21" Das Datum wird im internationalen Datumsformat (Y-M-D) ausgegeben.
X Axis	Trace A	Trace B	Feste Einträge in der Trace-Datei im ASCII-Format um die Zuordnung der folgenden Daten zu erleichtern.
X Function	Trace A Function	Trace B Function	Messfunktion, die auf der entsprechenden Achse eingestellt ist, z.B. Frequency Function Ch1 Function Ch2
X-Axis-Label	Y1-Axis-Label	Y2-Axis-Label	Beschriftung der X-Achse, der linken Y1-Achse (Trace A) und der rechten Y2-Achse (Trace B) z.B. Frequency/Hz Function Ch1/V Function Ch2/V
X-Unit	A-Unit	B-Unit	Einheit der X-Achse, der linken Y1-Achse (Trace A) und der rechten Y2-Achse (Trace B) der grafischen Darstellung z.B. Hz V V
X-Spacing	A-Spacing	B-Spacing	Lineare oder logarithmische Unterteilung der X-Achse, der linken Y1-Achse (Trace A) und der rechten Y2-Achse (Trace B), z.B. LIN LOG LOG
X-Left	A-Bottom	B-Bottom	Linker Wert der X-Achse, unterer Wert der linken Y1-Achse (Trace A) und der rechten Y2-Achse (Trace B).
X-Right	A-Top	B-Top	Rechter Wert der X-Achse, oberer Wert der linken Y1-Achse (Trace A) und der rechten Y2-Achse (Trace B).
	A-LimLow	B-LimLow	Unterer Grenzwert der linken Y1-Achse (Trace A) und der rechten Y2-Achse (Trace B). Ist hier der Grenzwert VOID eingetragen, ist die Grenzwertüberprüfung ausgeschaltet. Ist hier ein Wert eingetragen, wird für die Grenzwertprüfung der Wert aus dem Konfigurationspanel des Grafiksystems verwendet. Weiter unten im Datenbereich dieses Files erscheint zu jeder Datenzeile unter A-LimLow und B-LimLow dieser Wert.  Ist hier der Schriftzug FILE eingetragen, kommen die Grenzwerte von einer Grenzwert-Datei. Die auf die X-Achse interpolierten Grenzwerte sind weiter unten im Datenbereich dieses Files unter A-LimLow und B-LimLow aufgelistet. 
	A-LimUpp	B-LimUpp	Obere Grenzwert der linken Y1-Achse (Trace A) und der rechten Y2-Achse (Trace B).

Scan #Nr	A-Comment	B-Comment	<p>Scan #Nr: Scan number for the following data set, numbered sequentially 2, 1, 0, -1 to -19. Scan number 2 designates the maximum scan, scan number 1 the minimum scan, provided that</p> <p><input type="checkbox"/> Show Min Max <input checked="" type="checkbox"/></p> <p>is activated. Scan number 0 designates the most recent scan. The more negative the scan number, the older the scan. A-Comment and B-Comment are reserved for future R&S UPV program versions.</p>
X-Basic-Unit	A-Basic-Unit	B-Basic-Unit	<p>Basic unit of the X axis, the left Y axis (Trace A), and the right Y axis (Trace B) in the graphical display. If the following reference values are present, (that is != VOID), these units are identical to the basic unit of the following reference values.</p>
X-Ref	A-Ref	B-Ref	<p>Reference values for referenced units of the X axis, the left Y axis (Trace A), and the right Y axis (Trace B) in the basic unit. The value entered here is taken into the configuration panel of the graphic system as a fixed reference value when the trace file is loaded:</p> <p>Reference <input type="text" value="Value"/> <input type="button" value="v"/> <input type="text" value="1.000000"/> <input type="button" value="v"/></p> <p>If the word FILE is entered for A-Ref and / or B-Ref, the reference values come from a reference file or it is a floating reference value. The reference values interpolated onto the X axis are listed under "A-RefY in unit" and "B-RefY in unit" of the scan data sets. VOID is used as a placeholder for the reference value of a scan which is turned off. Special case: If the intention is to display the result of an intermodulation measurement in % or dB on the Y axis in the Bargraph graphic system, then no further reference is possible for this unit since it is already referenced. The "Reference" parameter field is displayed as inaccessible. Since no X axis is offered there is no X reference value either. In such cases the value 3.402823466385e+038 is entered in the trace file instead of a reference value and stands for NaN (Not a Number).</p>

<p>A-X/<i>datacount</i> A-Y A-LimLow A-LimUpp A-RefY in <i>unit</i> B-X/<i>datacount</i> B-Y B-LimLow B-LimUpp B-RefY in <i>unit</i></p> <p>This wording is arranged horizontally in the trace file.</p>	<p>A-X/<i>datacount</i>: Datacount identifies the number of following data sets (lines) for this scan. The number of data sets for Trace A can be different to the number for Trace B.</p> <p>A-X: X value in the unit specified at X Unit.</p> <p>A-Y: Y value of Trace A in the unit specified at A Unit.</p> <p>A-LimLow: Lower limit of Trace A from a limit file in the unit specified at A Unit. If VOID is entered here, there are no limit values from a file.</p> <p>A-LimUpp: Likewise upper limit.</p> <p>A-RefY in <i>unit</i>: Unit of the reference values of Trace A interpolated onto the X axis from a reference file, e.g. dBV. Caution: The reference values themselves are stored in the basic unit, e.g. V.</p> <p>A-RefY: Reference values of Trace A in the basic unit.</p> <p>B-X/<i>datacount</i>: Datacount identifies the number of following data sets (lines) for this scan. The number of data sets for Trace A can be different to the number for Trace B.</p> <p>B-Y: Y value of Trace B i in the unit specified at B Unit.</p> <p>B-LimLow: Lower limit of Trace B from a limit file in the unit specified at B Unit. If VOID is entered here, there are no limit values from a file.</p> <p>B-LimUpp: Likewise upper limit.</p> <p>B-RefY in <i>unit</i>: Unit of the reference values of Trace B interpolated onto the X axis from a reference file, e.g. dBV. Caution: The reference values themselves are stored in the basic unit, e.g. V.</p> <p>B-RefY: Reference values of Trace B in the basic unit.</p>
---	---

Example of a trace data set:

The trace data set was generated from the FFT Graph subsystem.

```
UPV FFT TRACE FILE
Heading String
R&S UPP800 Serial no: 123456, 2012/24/5, 9:51:42
X Axis Trace A Trace B
Frequency FFT Level Ch1 FFT Level Ch2
Frequency / Hz FFT Level Ch1 / dBV FFT Level Ch2 / V
Hz dBV V
LIN LIN LIN
0 -170 0
22000 10 1
VOID VOID VOID
VOID VOID VOID
Scan #0 Labeltext Labeltext
Hz V V
1000 1.00e+000 1.00e+000
A-X/256 A-Y A-LimLow A-LimUpp A-RefY in dBV B-X/256 B-Y B-LimLow B-LimUpp BRefY
in dBV
0.00e+000 -1.08e+002 VOID VOID 1.00e+000 VOID VOID VOID VOID VOID
9.37e+001 -9.93e+001 VOID VOID 1.00e+000 VOID VOID VOID VOID VOID
```

```

1.87e+002 -1.01e+002 VOID VOID 1.00e+000 VOID VOID VOID VOID VOID
::
2.37e+004 -1.36e+002 VOID VOID 1.00e+000 VOID VOID VOID VOID VOID
2.38e+004 -1.37e+002 VOID VOID 1.00e+000 VOID VOID VOID VOID VOID
2.39e+004 -1.34e+002 VOID VOID 1.00e+000 VOID VOID VOID VOID VOID

```

The individual parameters are stored in the original with a considerably greater number of points. Due to the restricted page width the data set for this display has been reduced in size.

If a data set is subsequently edited manually, comment lines (which can be identified by a '#' at the beginning of the line) can be inserted at any position ahead of the data lines.

A data set must never be interrupted by comments!

5.58.2 Equalization Files

The equalization data is stored in plain text in ASCII format. The format has been selected so that the data can be processed without a problem in EXCEL.

Structure of the equalization file:

Kennung: UPV EQUALIZATION FILE	
Anzahl der folgenden X/Y-Pärchen: 100 # Datacount	
Inverted oder Not inverted: # Inverted	
Normfrequenz: # 1000.000000 Hz # Norm frequency	
Normierungswert: # 0.100177 V # Norm value	
100.000000000000	4891.695800781250
103.072242736816	4622.376953125000
106.238868713379	4368.537597656250
:	:
1027.808593750000	1.006141066551
:	:
2000.000000000000	4583.853027343750

The individual parameters are TAB separated.

Black: Explanation of fields. These explanations are not stored in the equalization file.

Green: Fixed entries in ASCII format.

Red: Entries which change depending on the settings in the corresponding DispConfig panel.

Table 5-10: Explanation of terms:

Identifier	Identifies the file as an equalization file. During loading this identification is used to decide whether the file concerned can be loaded.
Number of following X/Y pairs	Self-explanatory
Inverted or Not inverted	A comment which states whether the equalization factors have been stored inverted or not inverted. The effect of inverting the frequency response in the generator by means of an equalization file created with the "Invert" setting is that the same DUT - with the equalizer enabled - now receives an undistorted frequency response.
Normalization frequency	A comment which states the frequency whose voltage value has been used for normalization.

Normalization value	A comment which states the normalization value with which the Y values were computed as factors.
X/Y pairs	Frequency value in Hz followed by the normalization factor. If the normalization frequency selected on saving the equalization file was that at which the frequency response curve is at its maximum, the equalizer file contains only values from 0.0 to 1.0. If a different frequency is selected, factors greater than 1.0 also occur.

Example of an equalization data set:

```
UPV EQUALIZATION FILE
100 # Datacount
# Inverted
# 1000.000000 Hz # Norm frequency
# 0.100177 V # Norm value
100.000000000000 4891.695800781250
103.072242736816 4622.376953125000
106.238868713379 4368.537597656250
:
1027.808593750000 1.006141066551
:
1940.386596679688 2496.481933593750
2000.000000000000 4583.853027343750
```

If a data set is subsequently edited manually, comment lines (which can be identified by a '#' at the beginning of the line) can be inserted at any position ahead of the X/Y pairs. **A data set must never be interrupted by comments!**

5.58.3 Sweep Lists

The sweep list data is stored in plain text in ASCII format. The format has been selected so that the data can be processed without a problem in EXCEL.

Sweep points must be specified in ascending or descending order – they must not change direction, for example due to editing!

Kennung: UPV SWEEPLIST FILE Anzahl der folgenden X-Werte: 9 #Datacount Basiseinheit: Hz #Basic unit 16.000000000000 20.000000000000 25.000000000000 31.500000000000 40.000000000000 50.000000000000 63.000000000000
--

Black: Explanation of fields. These explanations are not stored in the sweep list.

Green: Fixed entries in ASCII format.

Red: Entries which change depending on the settings in the corresponding DispConfig panel.

Table 5-11: Explanation of terms:

Identifier	Identifies the file as a sweep list. During loading this identification is used to decide whether the file concerned can be loaded.
Number of following X values	Self-explanatory
Basic unit	<p>The X values in the sweep list are always stored in the basic unit. If, for example, the X values in the trace from which the sweep list was derived are in ΔHz, Hz is entered as the basic unit and the X values are recomputed and stored in Hz.</p> <p>Basic units can occur as Hz, V, FS, UI, s and DEG (°).</p> <p>The R&S UPV uses this entry to recognize whether the loading operation is allowed for this file with regard to the current setting.</p> <p>If, for example, an attempt was made to load a sweep list with the basic unit Hz for a voltage list sweep, such a file would be ignored.</p>
X values	X values for a list sweep

Example of a sweep list data set:

```
UPV SWEEPLIST FILE
9 # Datacount
Hz # Basic unit
16.000000000000
20.000000000000
25.000000000000
31.500000000000
40.000000000000
50.000000000000
63.000000000000
80.000000000000
100.000000000000
```

If a data set is subsequently edited manually, comment lines (which can be identified by a **#** at the beginning of the line) can be inserted at any position **ahead of** the frequency values. **A data set must never be interrupted by comments!**

5.58.4 Limit Files

The limit data is stored in plain text in ASCII format. The format has been selected so that the data can be processed without a problem in EXCEL.

Structure of the limit file:

Kennung: UPV LIMIT FILE	
Anzahl der folgenden X/Y-Pärchen: 9 # Datacount	
Offset ON/OFF: # Offset ON	
Offsetwert: # Offset value = 10 dBV	
X- und Y-Einheit: Hz dBV	
100	-70
711	-70
789	-45
875	-10
970	-10
1076	-10
1193	-30
1323	-70
2000	-70

Black: Explanation of fields. These explanations are not stored in the sweep list.

Green: Fixed entries in ASCII format.

Red: Entries which change depending on the settings in the corresponding DispConfig panel.

Table 5-12: Explanation of terms:

Identifier	Identifies the file as a limit file. During loading this identification is used to decide whether the file concerned can be loaded.
Number of following X/Y pairs	Self-explanatory
Offset ON/OFF	A comment which states whether, during the generation of a limit file from a measured value sequence, an offset value was added (ON) or not (OFF) to the Y data.
Offset value	A comment which states which offset value was added to the Y data during the generation of a limit file from a measured value sequence.
X and Y unit	Depending on the selected x-axis and the measurement function, a wide variety of units can be entered here for the X / Y values. Examples for the X values: Hz, °, s, V, FS or UI. Examples for the Y values: V, dBV, dBr, ... V/Vr, °, s, db, % etc.
X/Y pairs	X/Y pairs in the specified units.

Example of a limit data set:

```
UPV LIMIT FILE
9 # Datacount
# Offset ON
# Offset value = 10.0 dBV
Hz dBV
100 -70
711 -70
789 -45
875 -10
970 -10
1076 -10
1193 -30
1323 -70
2000 -70
```

If a data set is subsequently edited manually, comment lines (which can be identified by a '#' at the beginning of the line) can be inserted at any position ahead of the X/Y pairs. A data set must never be interrupted by comments.

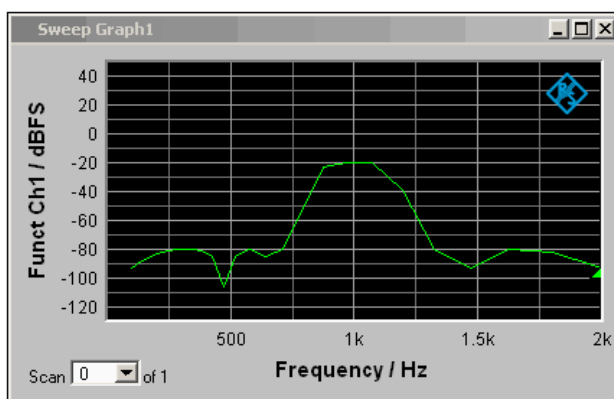
5.59 Editing

The editing of trace files, equalization files, sweep lists and limit files is always carried out in the same way and is illustrated by two examples. The procedure is not explained point by point in the examples – this would be beyond the scope of this description. The examples are really intended for the trained user.

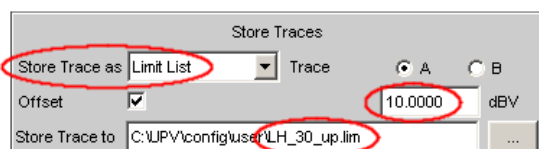
Example:

The intention is to generate a tolerance band from the frequency response of an ideal DUT. This tolerance band will be compared to the other DUTs.

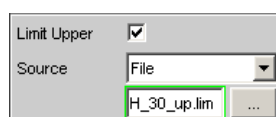
The measured value sequence of this ideal DUT is generated by means of a 30 point sweep.

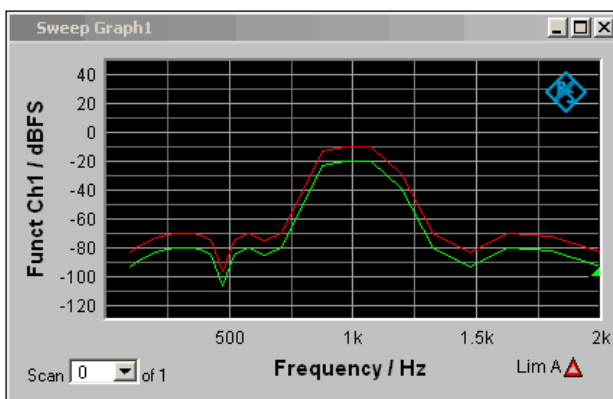


Using "Store Trace as " "Limit List", a limit file with 30 pairs of X/Y values is generated from this measured value sequence and stored as LH_30_up.lim. The Y values of the limit curve are provided with an additive offset of 10 dBV, producing a limit curve that is parallel shifted by 10 dBV compared to the measured value sequence.



If the limit curve is loaded as Limit Upper, the parallel shift can be seen to be upward.





However, the limit curve derived from a measured value sequence is unsuitable as the upper limit of a tolerance band, since horizontal lines should appear to left and right of the passband in the bandpass display. This makes it necessary to modify the limit file.

For this purpose, the file named LH_30_up.lim is loaded into an ASCII editor, such as the Windows Editor, which is present as an accessory on every Windows operating system for the R&S UPV. The editor displays a data set as shown in the left column above.

This data set is then modified as shown in the right column. The modified data record in the right column is stored in the file LH_9_up.lim.

LH_30_up.lim

```

UPV LIMIT FILE
30 # Datacount
# Offset ON
# Offset value = 10.000000 dBV
Hz      dBV
100.000000000000      -83.702377319336
110.882522583008      -82.031776428223
122.949340820313      -80.389442443848
136.329330444336      -78.784820556641
151.165405273438      -77.228446960449
167.616012573242      -75.734764099121
185.856872558594      -74.320167541504
206.082794189453      -73.010757446289
228.509796142578      -71.841300964355
253.377426147461      -70.862701416016
280.951293945313      -70.152404785156
311.525878906250      -69.837203979492
345.427764892578      -70.144065856934
383.019012451172      -71.554283142090
424.701171875000      -75.466735839844
470.919372558594      -96.235939025879
522.167297363281      -75.033081054688
578.992248535156      -69.949821472168
642.001220703125      -75.313186645508
711.867187500000      -69.820259094238
789.336303710938      -44.014369964600
875.236022949219      -13.052226066589
970.483764648438      -9.946021080017
1076.096923828125      -9.984798431396
1193.203369140625      -28.528638839722
1323.054077148438      -70.569931030273
1467.035766601563      -82.768814086914
1626.686279296875      -70.306480407715
1803.710693359375      -71.739479064941
2000.000000000000      -83.138786315918
    
```

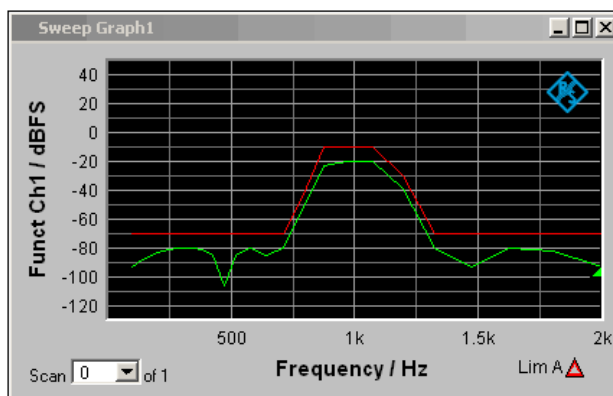
LH_9_up.lim

```

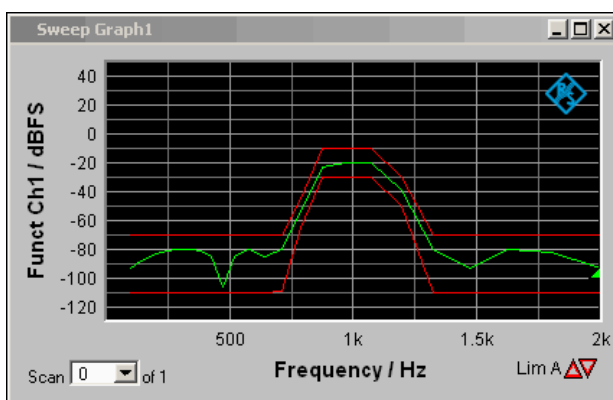
UPV LIMIT FILE
9 # Datacount
# Offset ON
# Offset value = 10.000000 dBV
Hz      dBV
100      -70
711      -70
789      -45
875      -10
970      -10
1076     -10
1193     -30
1323     -70
2000     -70
    
```

When altering the number of X/Y values it is important to make sure that the Datacount entry is adapted accordingly. The identifier **UPV LIMIT FILE** must not be changed. If the tabulator (TAB) is used as a separator between various entries in a line, the file can be processed in EXCEL without any problem. Other separators are also permissible, e.g. ';', '|' or ''.

If the new limit curve named `LH_9_up.lim` is then loaded as "Limit Upper", the result of the modification can be assessed and further processing can be performed if necessary.



A limit file for the lower limit of a tolerance band can be generated in much the same way as the procedure for modifying a limit file for the upper limit of a tolerance band. The two limit files together produce the desired tolerance band.



Example:

The intention is to create a sweep file from the trace data set of a waveform file. Leave to one side the matter of whether this serves any purpose. The example is intended to show that any trace file can be created by editing.



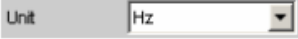
The X values in the waveform trace file are expressed in seconds. But the x-axis in the sweep trace file needs to be displayed in Hz. The level values on the y-axis are to stay unchanged.

The left column shows the original Waveform Trace file, the right table column the Sweep Trace file that was generated through editing.

1	UPV WAVEFORM TRACE FILE	UPV SWEEP TRACE FILE
2	Heading String	Heading String
3	Commenttext	Commenttext
4	X Axis Trace ATrace B	X Axis Trace ATrace B
5	Time Level Ch1 VOID	Frequency Funct Ch1 VOID
6	Time / s Level Ch1 / V VOID	Frequency / Hz Funct Ch1 / V VOID
7	s V VOID	Hz V VOID
8	LIN LIN VOID	LIN LIN VOID
9	0 -0.000273702 VOID	0 -0.000273702 VOID
10	0.0001 0.000946001 VOID	10 0.000946001 VOID
11	VOID VOID VOID	VOID VOID VOID
12	VOID VOID VOID	VOID VOID VOID
13	Scan #0 Labeltext VOID	Scan #0 Labeltext VOID
14	s V VOID	Hz V VOID
15	1 1.00e+00 VOID	1 1.00e+00 VOID
16	A-X/6 A-Y	A-X/6 A-Y
17	0.00000e+00 1.01179e-004	0.00000 1.01179e-004
18	2.08333e-05 6.25051e-004	2.08333 6.25051e-004
19	4.16666e-05 8.90560e-004	4.16666 8.90560e-004
20	6.25000e-05 7.87767e-004	6.25000 7.87767e-004
21	8.33333e-05 3.59082e-004	8.33333 3.59082e-004
22	1.04166e-04 -2.1826e-004	10.4166 -2.1826e-004

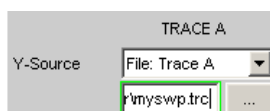
The data sets are displayed in abbreviated form.

Explanation of the changes:

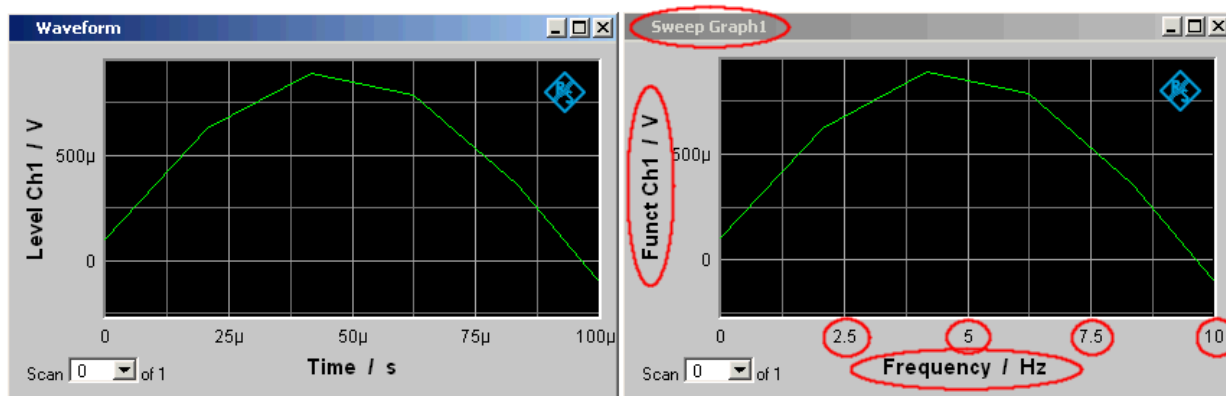
Line	Change
1	UPV SWEEP TRACE FILE The identifier is changed so that the file will be accepted in the sweep graphic system. For information on identifiers see table entry "Subsystem identifier" in section "Trace Files", on page 4.610
2	unchanged
3	unchanged
4	unchanged
5	Frequency The desired function of the X axis is entered here. The wording must be exactly the same as the entry in the parameter list of the X axis selection field. 
	Funct Ch1 The desired function of the Y axis is entered here. The wording must be exactly the same as the entry in the parameter list of the "Y-Source" selection field. 
6	Frequency / Hz The desired label for the X axis is entered here: Funct Ch1 / V The desired label for the Y axis is entered here:
7	Hz The desired unit for the X axis is entered here. The wording must be exactly the same as the entry in the parameter list of the Unit selection field. 
8	unchanged
9	unchanged
10	10 The righthand final value of the X axis is entered here.
11	unchanged
12	unchanged
13	unchanged
14	Hz The basic unit of the unit selected in line 7 is entered here. If for example ΔHz had been entered in line 7, then Hz would still have to be shown here.
15	unchanged
16	unchanged
17	
18	
19	Modified X values
20	
21	
22	

In order to make the changes, the waveform trace file (e.g. mywav.trc) is loaded into an ASCII editor, such as the Windows Editor, which is present as an accessory on every Windows operating system for the R&S UPV. The editor displays a data set as shown in the left column above. This data set is then modified as shown in the right column. The amended data set is saved with another name (e.g. myswp.trc).

After the new data set is loaded in the Sweep graphic system



a trace identical to that of the waveform must be seen, though its x-axis will be totally different.



5.60 Export

The most frequent reason for needing to export trace files, equalization files, sweep lists and limit files is without doubt so that they can be further processed in Microsoft Excel.

The procedure is explained in broad terms in the following example. The examples are really intended for the trained user. A point by point description would be beyond the scope of this description.

Changing the language option:

It is a prerequisite that Microsoft Excel is installed on the R&S UPV, or that a PC is available on which Excel is already installed.

If a PC is to be used, the trace file being exported must be copied to this PC by means of a USB stick, for example.

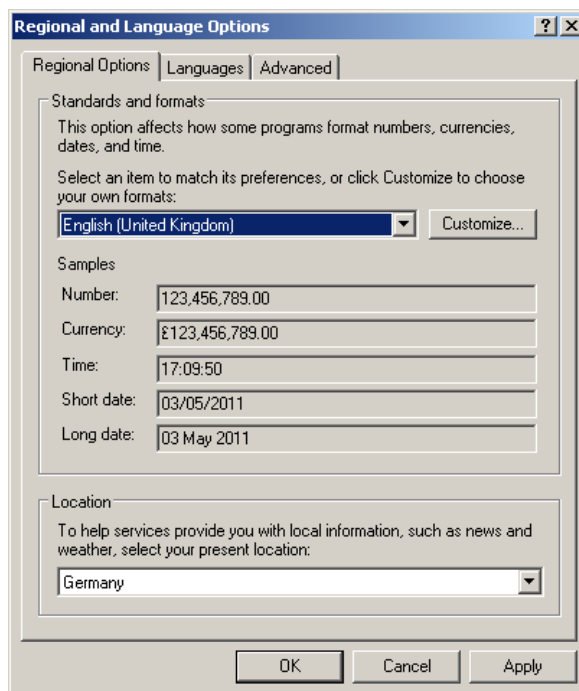
The PC must be changed over to the English language option if this has not already been done.

This is usually not necessary in the case of the R&S UPV since the R&S UPV is delivered with the language option "English (United Kingdom)".

If it is necessary to change the language option, proceed as follows:

Using the operating menu sequence:

Start, Settings, Control Panel, open the window for "Regional and Language Options" and set the language "English (United Kingdom)".



This conversion ensures that in Excel the decimal separator within numbers is interpreted as the decimal point.

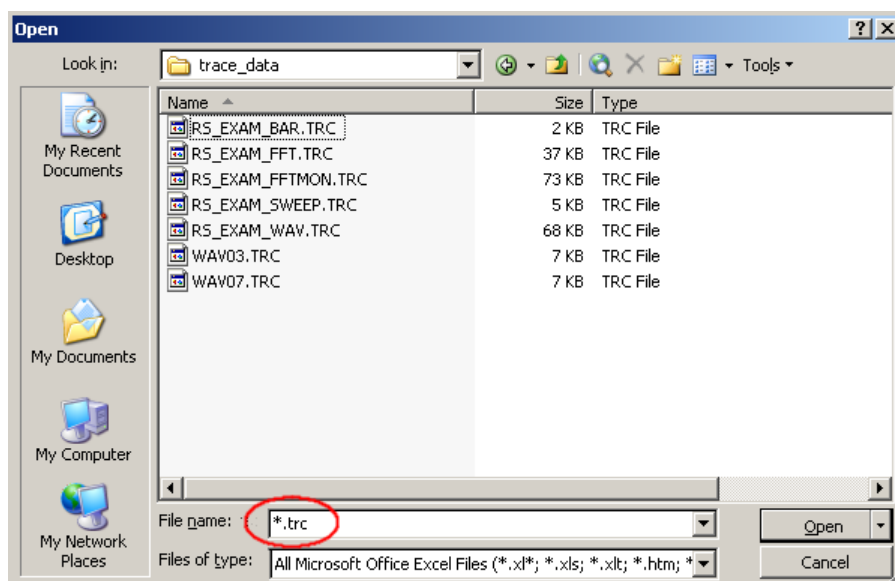
Since the R&S UPV is delivered with an English-language operating system for English-speaking regions, the trace files are generated within the R&S UPV exclusively in the English number format (decimal point rather than decimal comma) and can therefore be processed in Excel without the slightest need for post-processing.

Reading the trace file into Excel:

Open Excel and open the file selector via the menu item File Open.

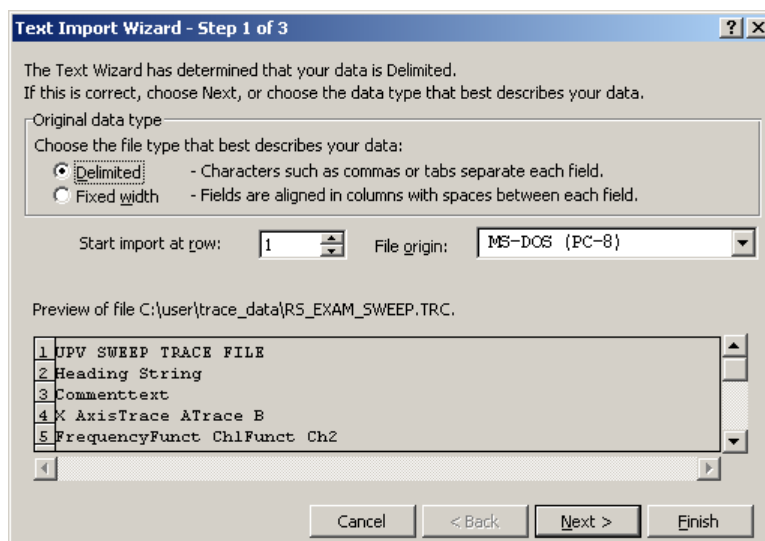
Go to the directory containing the trace file that is to be exported.

In the File name field type the file name extension `*.TRC` and all files with the extension `*.TRC` will appear.



Select the file that is to be exported.

A dialog box opens in which no changes must be made if "Start / Control Panel / Regional and Language Options" is set to the condition as supplied to the customer "English (United Kingdom)".



Finish.

The trace files have been designed by R&S so that without a single entry the data set appears in Excel and can be processed further.

	A	B	C	D	E	F	G	H	I	J
1	UPV SWEEP TRACE FILE									
2	Heading String									
3	Commenttext									
4	X Axis	Trace A	Trace B							
5	Frequency	Funct Ch1	Funct Ch2							
6	Frequency / Hz	Funct Ch1 / V	Funct Ch2 / V							
7	Hz	V	V							
8	LIN	LIN	LIN							
9	100	0	0							
10	20000	0.15	0.17							
11	VOID	VOID	VOID							
12	VOID	VOID	VOID							
13	Scan #0	Labeltext	Labeltext							
14	Hz	V	V							
15	1000	1.00E+00	1.00E+00							
16	A-X/30		A-LimLow	A-LimUpp	A-RefY in V	B-X/30		B-B-LimLow	B-LimUpp	B-RefY in V
17	1.00E+02	1.12E-02	VOID	VOID	1.00E+00	1.00E+02	1.12E-02	VOID	VOID	1.00E+00
18	1.20E+02	1.48E-02	VOID	VOID	1.00E+00	1.20E+02	1.49E-02	VOID	VOID	1.00E+00
19	1.44E+02	1.92E-02	VOID	VOID	1.00E+00	1.44E+02	1.92E-02	VOID	VOID	1.00E+00
20	1.73E+02	2.44E-02	VOID	VOID	1.00E+00	1.73E+02	2.44E-02	VOID	VOID	1.00E+00
21	2.08E+02	3.04E-02	VOID	VOID	1.00E+00	2.08E+02	3.04E-02	VOID	VOID	1.00E+00
22	2.49E+02	3.73E-02	VOID	VOID	1.00E+00	2.49E+02	3.73E-02	VOID	VOID	1.00E+00
23	2.99E+02	4.50E-02	VOID	VOID	1.00E+00	2.99E+02	4.50E-02	VOID	VOID	1.00E+00
24	3.59E+02	5.34E-02	VOID	VOID	1.00E+00	3.59E+02	5.35E-02	VOID	VOID	1.00E+00

If the Language Option is changed, an adaptation of the "Decimal separator" and the "Thousands separator" is necessary, to be configured under Text Import Wizard - Step 3 of 3, "Advanced ..." button.

To obtain an EXCEL file that is similar to the original Trace file, we recommend formatting all cells with "Scientific" with 12 trailing digits.

5.61 Loading and Saving

This section tells you how to load and save different kinds of data sets in the R&S UPV. The file name is chosen through a central file selection box. Its type is defined by the extension. The style of the file selection box can be defined in the configuration menu. The integrated file selection box is set as standard. It enables front panel control and is described below. Optionally the usual Windows file selection box can be used.

5.61.1 Integrated File selection box

The file selection box is split into three or four areas. At the top (Recent area) is a list of the file names last selected. This list will always contain the last ten entries. Below this and split into two is space for selecting the required directory (Directory area, left) and the required file (File area, right). If a data set is to be saved, you will also find an entry field at the bottom for the file name.

At the bottom edge of the file selection box are two buttons "Select" and "File Manager". You can work these buttons either with the rotary knob or the softkey below.

To change between the areas, use the rotary knob or the cursor keys. Each of the areas appears with a blue frame when you select it with the rotary knob. Pressing the rotary knob or the ENTER key changes your selection to the content of the selected

area, and an entry within this area is selected; the ESC key takes you back to selection of an area.



The Directory area and the File area are comprised within the same frame. So to change between the two areas you use the LEFT and RIGHT cursor keys and not the rotary knob.

If a selection is in the Recent area or File area, the RETURN key or a click of the rotary knob will complete selection of the file name and execute the required function. When you are storing data sets, ending entry of the file name with RETURN will complete selection of the file name.

For the creation of new directories when saving or organizing saved data sets during loading, the file selection box has a "File Manager" button to open a functionality which is similar to Windows Explorer except that, like the internal file selection box, it is optimized to be operated with no mouse or keyboard.

5.61.2 File Manager

The file manager is split into three areas. At the top is a selection of the possible types of data sets. These are distinguished by their extensions in the file name. Below this and split into two is space for selecting the required directory (Directory area, left) and the required file (File area, right).

At the bottom edge of the file manager are the buttons Cut, Copy, Paste, Remove, Rename and Create Dir. You can work these buttons either with the rotary knob or the respective softkey below them. These are a substitute for the pop-up menu in Windows Explorer on the right mouse key.

To change between the areas, use the rotary knob or the cursor keys. Each of the areas appears with a blue frame when you select it with the rotary knob. Pressing the rotary knob or the ENTER key changes your selection to the content of the selected area, and an entry within this area is selected; the ESC key takes you back to selection of an area.



The Directory area and the File area are comprised within the same frame. So to change between the two areas you use the LEFT and RIGHT cursor keys and not the rotary knob.

Once a file is selected, you activate a button at the edge of the dialog to trigger the required function.

If you want to shift a file from one directory to another, for example, you first select the source directory in the Directory area, and then the particular file in the File area. The "Cut" button notes the file to be shifted. Then you select the destination directory in the Directory area and choose the "Paste" button. This moves (pastes) the file from the source directory to the destination directory.

5.61.3 Windows File Selection Box

The Windows file selection box is split into three areas: On the left is a selection bar of icons which can be used to jump to different drives and personal directories.

In the upper area are the navigation buttons for such things as changing directories or creating new directories. Directly below is a list of the displayed files.

In the lower area is the entry field for the file name and the buttons for confirming the selection. If files have already been selected in previous steps, the file selection box remembers their names and offers the first matching name from the history as a pre-selection when a file name is being typed.

As usual in Windows programs, this file selection box is best operated with the mouse only.

5.62 Loading and Saving Setups

Setups can be loaded and saved at any time. The front panel keys LOAD and SAVE trigger the required function, opening the appropriate file selection box. Loading and saving setups is also possible through the menu bar. The related entries are in the File menu.

5.62.1 Saving Setups

When saving setups, the R&S UPV distinguishes three types, namely complete setups (*.set), current setups (*.sac) and a report file for visualizing the settings in HTML format (*.html).

- Complete Setup
Saving a complete setup saves the entire instrument settings, plus the position and size of all windows in all screens.
- Current setup
Saving a current setup, in contrast, only saves the instrument settings. A setup saved in this way can be loaded much faster, since the panels do not have to be restored.
- Report File
This file can be opened and viewed in Internet Explorer or a similar browser.

Generator Config

Instrument	Analog
Channel	2 = 1
Output Type	Unbal
Impedance	5 Ω
Common	Float
Bandwidth	22 kHz
Volt Range	Auto
Max Voltage	20.0000 V
Ref Voltage	1.00000 V
Ref Frequency	1000.00 Hz

Generator Function

Function	Sine
-----------------	------

Remote-control command: `MMEMory:STORe:STATe`

5.62.2 Loading Setups

Loading a setup overwrites the settings of the instrument with the settings that were active when setup was saved. Depending on the type of setup to be loaded, only the current settings are overwritten ("current" setup) or the entire settings, including the position and size of all windows in all screens ("complete" setup). Windows that were open when the setup was saved are opened, and windows that were closed when the setup was saved are closed again. This is also done for the screens that are not visible.



Report files with the ending *.html cannot be loaded as setup. They merely serve for visualizing settings.

Remote-control command: `MMEMory:LOAD:STATe` on page 1022



The loading of setups has been considerably optimized as of version 1.4.0 of the R&S UPV software. Above all, setups with a high-resolution FFT or waveform setting are now loaded much faster.

5.63 Printing and Saving**5.63.1 Printing and Saving the Display Screen**

The R&S UPV enables you, at any time, to make and keep an extract of the displayed results for later use. You do this either by a direct printout or by saving to a file or the

Windows clipboard. You make the necessary settings, e.g. selection of the result to be output (source) and where it is to be output (destination), in a configuration panel.

5.63.1.1 Printing the entire display screen

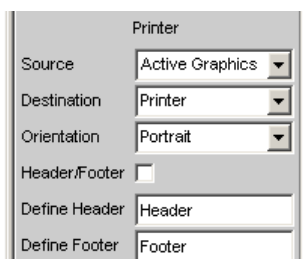
If the entire display screen is printed out, all panels are printed exactly as positioned on the screen. All colors are retained as they are, e.g. measured values are printed in green on a black background. This output mode is less suitable when printing only one graphic, for example. For this purpose, printout of a graphical window as a vector graphic is to be selected.

5.63.1.2 Printing of graphical windows as vector graphics

In this mode, graphical windows can be printed as vector graphics. This has two advantages: First, the printout is performed with maximum printer resolution. This means that an FFT with, for example, 2048 samples can also be printed without any problem in this resolution on DIN A4 with 600 dpi. In contrast, a screen printout could only differentiate a maximum of 800 samples, because it is always coupled to the screen resolution. Second, a black and white printer is used; this means that the background of the graphic remains white and the curves for the traces are printed out in black. Trace A is assigned a solid line, trace B a dotted line.

5.63.2 Configuring Print and Save Operations

The menu "Utilities", "Config Panel", section "Printer" opens a configuration panel for defining the required output parameters.



See "[Source](#)" on page 659.

5.63.3 Starting Print and Save Operations

HCOPY triggers the function to output measured value results. Depending on the selected setting in the configuration panel (see [chapter 5.63.2, "Configuring Print and Save Operations"](#), on page 800), the desired action is carried out immediately.

Remote-control command:

`HCOPY[:IMMEDIATE]` on page 1019



If you trigger H Copy during an ongoing measurement, the measurement is first halted and then the action is executed.

6 Remote Control - Fundamentals

6.1 Remote Control - Fundamentals

6.1.1 Introduction - Remote Control Fundamentals

In this chapter you will find:

- instructions on starting the Audio Analyzer R&S UPV by remote control,
- a general introduction to the remote control of programmable instruments, including details of command structure and syntax, command processing and the status registers,
- a graphic and tabular presentation of the status registers used in the Audio Analyzer R&S UPV,

The remote control commands of the Audio Analyzer R&S UPV are included in Chapter 5, "Instrument functions," and Chapter 7, "Remote control - commands."

To standard the instrument comes with the following interfaces for remote control:

- IEC/IEEE bus interface in line with the IEC 625.1/IEEE 488.2 standard.
- LAN interface; the network card uses 100 MHz Ethernet IEEE 802.3u; the protocol is based on the VXI-11 standard.
- USB interface (device USB)

A controller can be connected on the remote control interfaces, either direct via IEC-bus, USB interface or through a network (LAN). The connectors are located on the rear panel of the instrument.



Remote control via IEC/IEEE bus and USB interface are identical concerning the requirements. The differences to remote control via LAN are minor, they will be described in greater detail below. If remote control via IEC/IEEE bus is described below it also includes remote control via the USB interface!

These connectors are detailed in chapter 9 Maintenance and Interfaces.

SCPI commands (messages) are used for remote control. Commands not derived from the standard nevertheless follow SCPI syntax rules. The instrument supports SCPI version 1999 (Standard Commands for Programmable Instruments). The SCPI standard sets up on the IEEE 488.2 standard, and aims at standardization of device-specific commands, error handling and status registers. For more information on the SCPI concept and definitions, refer to the book "Automatic Measurement Control – A tutorial on SCPI and IEEE 488.2" by John M. Pieper, R&S ordering number 0002.3536.00.

For the purposes of this chapter it is assumed that you are familiar with the programming and operation of the controller. Refer to the appropriate manuals for details of the interface commands.

The requirements of the SCPI standard in terms of command syntax, error handling and configuration of status registers are explained in detail in the respective sections. Tables give you a fast overview of the bit assignments in the status registers. The tables are supplemented by a detailed description of the status registers.

All program examples for IEC/IEEE bus control are written in Visual Basic. A requisite for Visual Basic programming is that the modules NIGLOBAL (Niglobal.bas) and VBIB32 (Vbib_32.bas) are added to the projects.



Manual control aims at the greatest possible operating ease. The focus in remote control is the predictability of device status after a command. Consequently, remote control programs should always produce a default status to start with (e.g. by the *RST command) and then make the required settings.

6.2 Brief Instructions

The following short and simple operating sequence allows rapid setup of the instrument on the IEC/IEEE bus and setting of its basic functions. It is assumed that the IEC/IEEE bus address, factory-set to 20, has not yet been altered.

Interconnect the instrument and the controller by the IEC/IEEE bus cable and power them on.

6.2.1 IEC Bus

Generate and start the following program on the controller:

CALL IBFIND("DEV1", analyzer%)	Open channel to device.
CALL IBPAD(analyzer%, 20)	Send device address to controller.
CALL IBWRT(analyzer%, "*RST;*CLS")	Reset device. Analog generator is set dual-channel to 1 kHz, 0.1 V. Measurement function of analog analyzer is set dual-channel to RMS measurement.
CALL IBWRT(analyzer%, "INPut:TYPE GEN1")	Connect analyzer input internally to generator output channel 1.
CALL IBWRT(analyzer%, "INIT:CONT OFF;*WAI")	Trigger single measurement result.
CALL IBWRT(analyzer%, "SENS1:DATA1?")	Request function measurement result (i.e. result of RMS measurement) from channel 1.
CALL IBRD (analyzer%, M\$)	Read in measurement result.
PRINT M\$	Output measurement result on-screen.

The screen shows the RMS function measurement result in V of the generator signal measured by internal coupling.

Return to manual operation: Press the LOCAL button on the front panel.

6.3 Changing to Remote Control

After powering on, the instrument is always in manual control status (LOCAL) and can be controlled from the front panel or a mouse and external keyboard.

To operate the instrument by remote control via an IEC/IEEE bus, you have to switch it to the REMOTE mode by sending an addressed command while the REN line is set. Otherwise, the instrument will remain in the LOCAL mode. If the REN line is cleared while the instrument is in the REMOTE mode, the instrument automatically resets to LOCAL.

For remote control via Ethernet (LAN), the changeover does not take place automatically by sending a command; rather, the instrument must be set to REMOTE status explicitly, e.g. by sending the interface command **>R** (Go-To-Remote).

In REMOTE status, instrument control from the front panel or by a mouse and keyboard is disabled. But the panels can be opened by the mouse and keyboard to verify settings, for example.

In the Config Panel (in the menu Utilities) you can choose whether or not the panels are to be updated during remote control with the parameter field "SCPI Update", see also "[SCPI update](#)" on page 659.

In the middle of the screen you see the message "Remote Operation Active". On the front panel the LED labeled REM illuminates over the key LOCAL .

Messages appearing during remote control are shown in the status line over the soft-keys.

The instrument remains in REMOTE status until local control is selected either manually with the LOCAL key or in the "Remote Operation Active" window with a mouse click on **X** or by the interface command **>L**. Processing of a command must be completed before changing, otherwise there is an immediate return to remote control. Then the panels are updated.

Changing from manual control to remote control and vice versa does not change the instrument settings.

6.3.1 Remote Control by IEC/IEEE Bus

To be able to control the instrument on the IEC/IEEE bus interface, the instrument and controller must be linked by an IEC/IEEE bus cable. The controller must have an IEC/IEEE bus card, the card drivers and the program libraries for the programming language that is used.

The controller must address the instrument by the set IEC/IEEE bus address. The IEC/IEEE bus address of the instrument is factory-set to 20. It can be altered in the Config Panel (in the Utilities menu) with the "GPIB Address" parameter field, see also "[GPIB Address](#)" on page 659.

Addresses from 1 to 30 are permissible. After setting a new address, the device status of the R&S UPV is saved with the new address. This prevents the R&S UPV from „for-

getting" the new address if switched OFF with the power switch rather than being properly shut down.

Sending the first command starts remote control.

6.3.2 Remote Control via LAN Interface

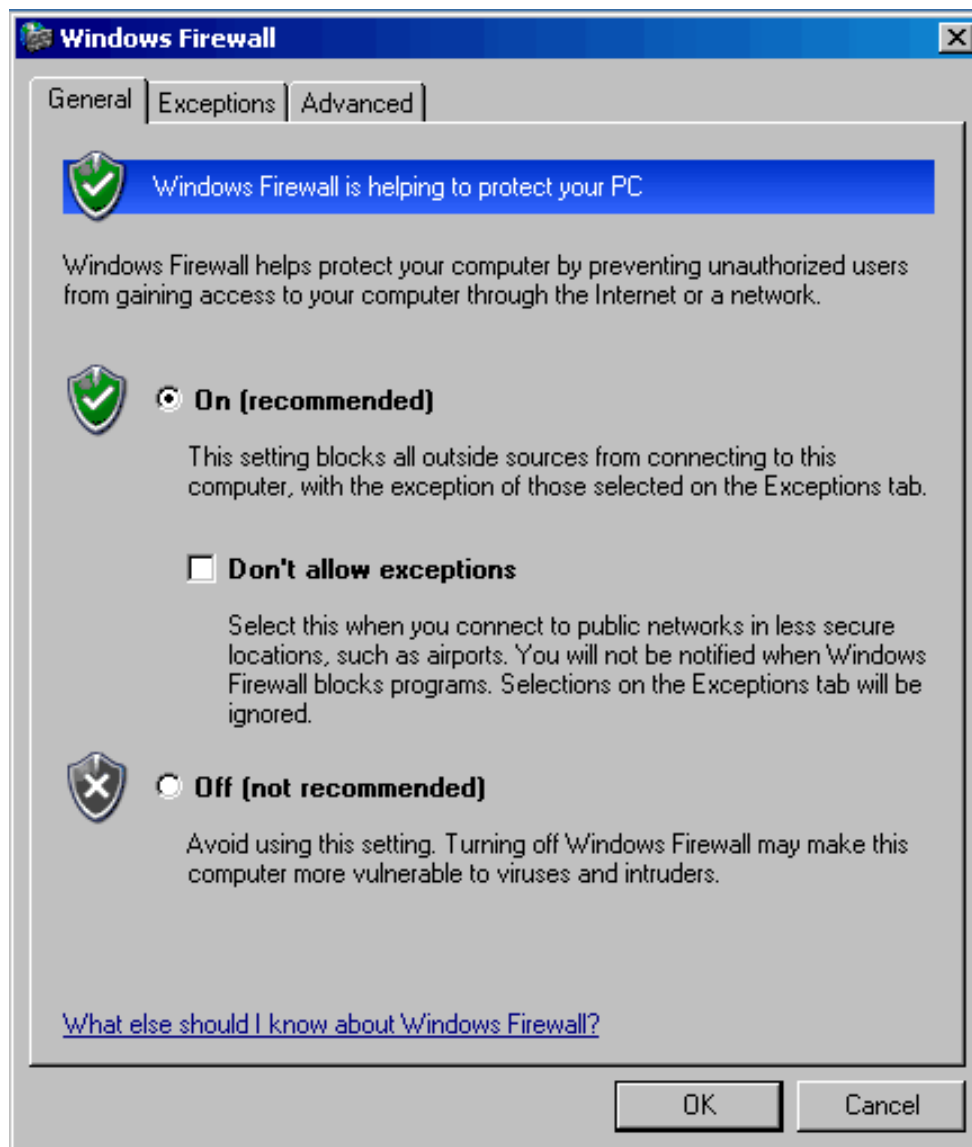
For remote control through a network, the controller and the instrument must be connected via the LAN interface to a common network with TCP/IP network protocol.

Connection of the R&S UPV to a network and querying of the computer name is explained in [chapter 2.10, "Connect R&S UPV to a Network \(LAN\)"](#), on page 67.

R&S UPV is supplied with an activated Windows XP* firewall already installed. In contrast to file transfer via a LAN or manual remote operation with Remote Desktop, which requires only partial disablement (exception) in the firewall, remote control via a LAN is possible only if the firewall is completely deactivated.

Setting remote control:

"Start" - "Programs" - "Windows Firewall" - "Off (not recommended)":



NOTICE

Possible damage of an unprotected controller

Reactivate the Windows XP firewall after you terminate VISA Remote Control setting "On (recommended)", to protect the instrument from users and programs that can access a computer via the network.

Software for instrument control and the VISA program library must be installed on the controller. Instrument control is by the VXI-11 standard protocol.

Only the IP address or the computer name is required for connection setup. The IP address/computer name is part of the "resource name" used by programs to identify and control the instrument. The resource name has the form:

TCPIP::ipaddr::inst0::INSTR

Replace **ipaddr** by the IP address or the computer name of the instrument. For

instance, if the instrument has the IP address 192.1.2.3, TCPIP::

192.1.2.3::inst0::INSTR is the valid resource name. The specification of **inst0** in the resource name is optional and may be omitted. So in this example TCPIP::

192.1.2.3::INSTR is also a valid resource name. A resource name with computer name could be TCPIP::RSUPV1::INSTR.



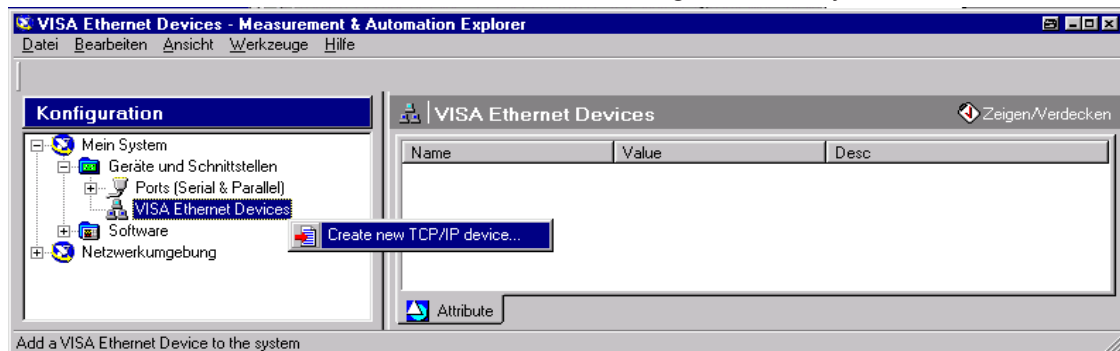
If LXI is installed (standard with the R&S UPV66, optional with the R&S UPV) the IP address of the instrument can also be determined easily by using a Web browser. See [chapter 2.10.3, "Configuration via LXI"](#), on page 73.

TCPIP designates the network protocol used and **INSTR** indicates that the VXI-11 protocol is used. If several instruments are connected to a network, each instrument has its own IP address and associated resource name. The controller distinguishes these instruments by their resource name.

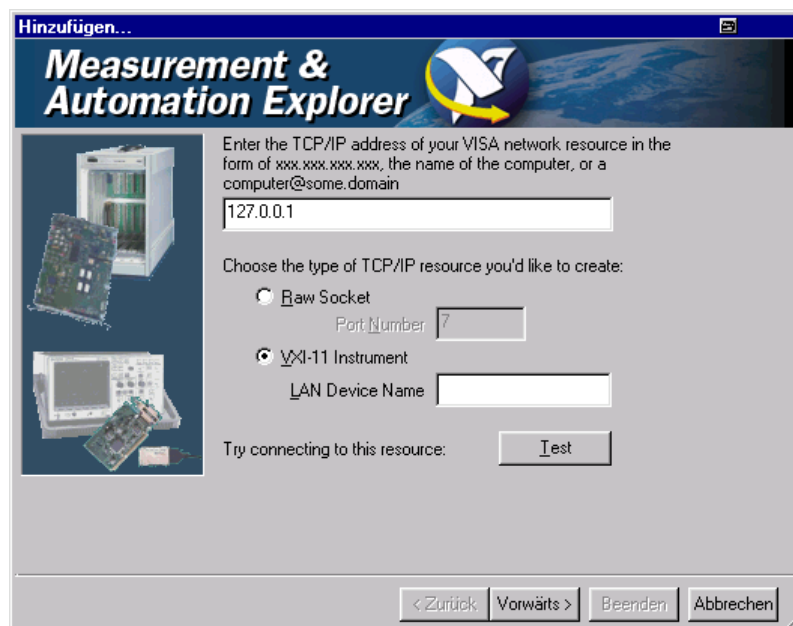
In the example below, the Measurement & Automation Explorer program from National Instruments is used to set up an Ethernet remote control connection. Connection setup with this program is simple and first tests can be performed. R&S UPV is ready configured for networks using DHCP (dynamic host configuration protocol). If this configuration is used, the computer name must be entered at the position of the IP address. It is also possible to assign the R&S UPV a fixed IP address (see [chapter 2.10, "Connect R&S UPV to a Network \(LAN\)"](#), on page 67).

Configuring the control of R&S UPV in the 'Measurement & Automation Control' program.

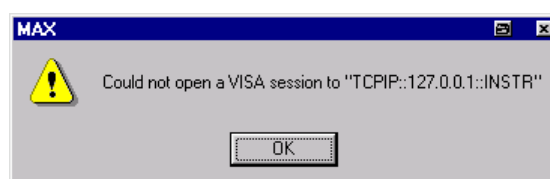
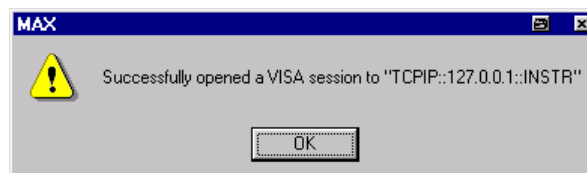
- Launch the program on the control computer.
- Menu "Create new TCP/IP device" with the right mouse key.



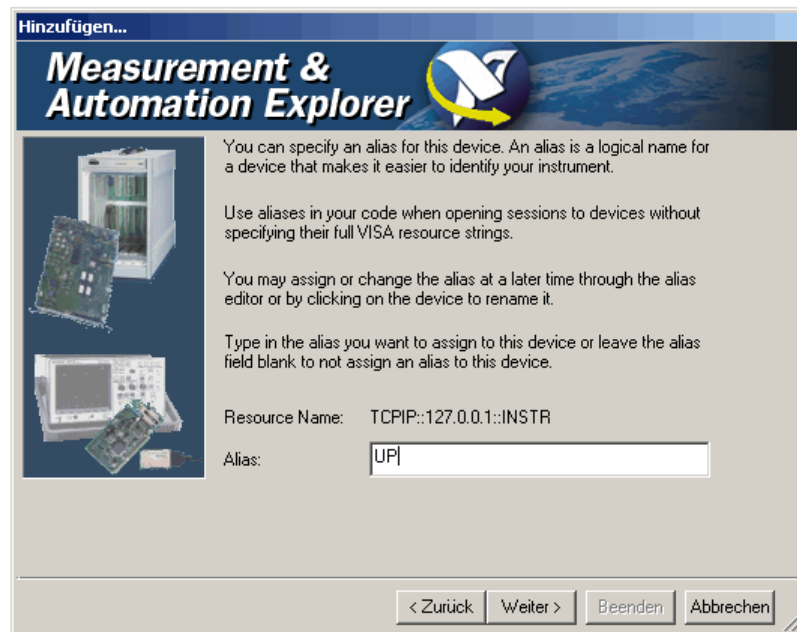
- Enter the IP address of the R&S UPV and select "VXI-11 Instrument" (You can also enter the computer name).



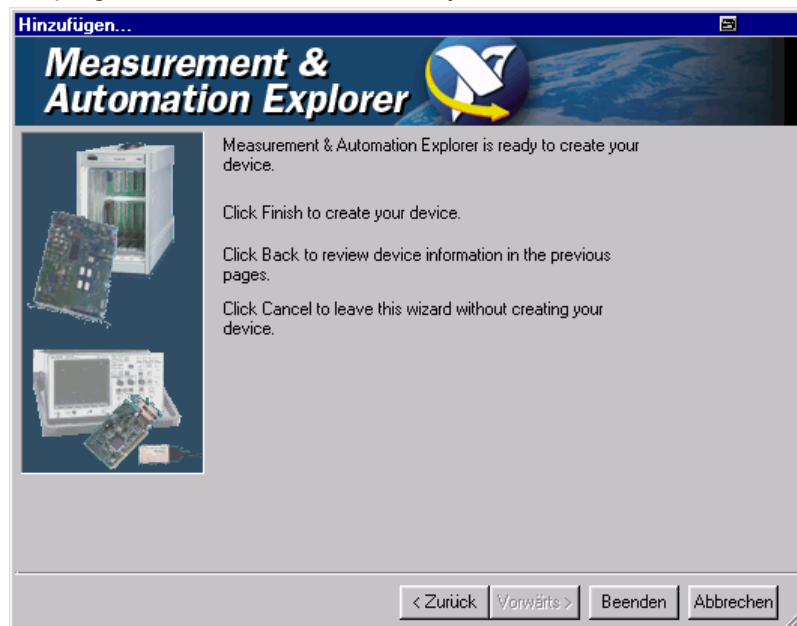
- Press the "Test" button. A message indicates whether the connection to the R&S UPV can be set up or not. If a connection cannot be set up, check whether the controller and the instrument are connected to the network (network cable) and powered on. Correct spelling of the IP address or the computer name can also be checked. For further troubleshooting it is advisable to inform the network administrator. Large networks require specification of additional addresses for connection setup, e.g. gateway and subnet mask, which are known to the network administrator.



- Press the "Next" button. In the next window you can enter an alias for the instrument. This name must not be mistaken for the computer name. It is only used for instrument identification within the program and displayed in the menu as an option in case of an Ethernet link.

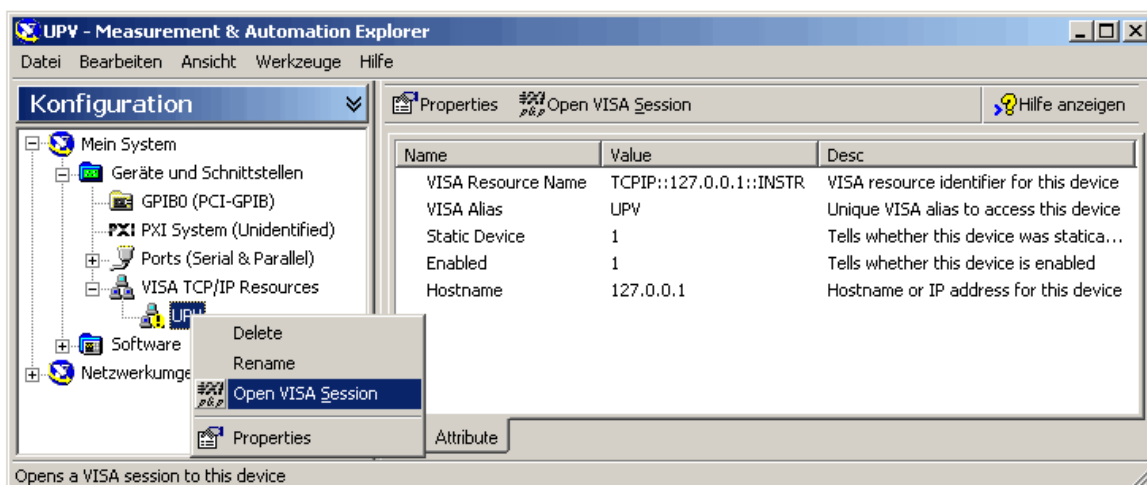


- Press the "Next" and then the "Finish" button. The instrument is now configured in the program and can be addressed by the resource name or alias.

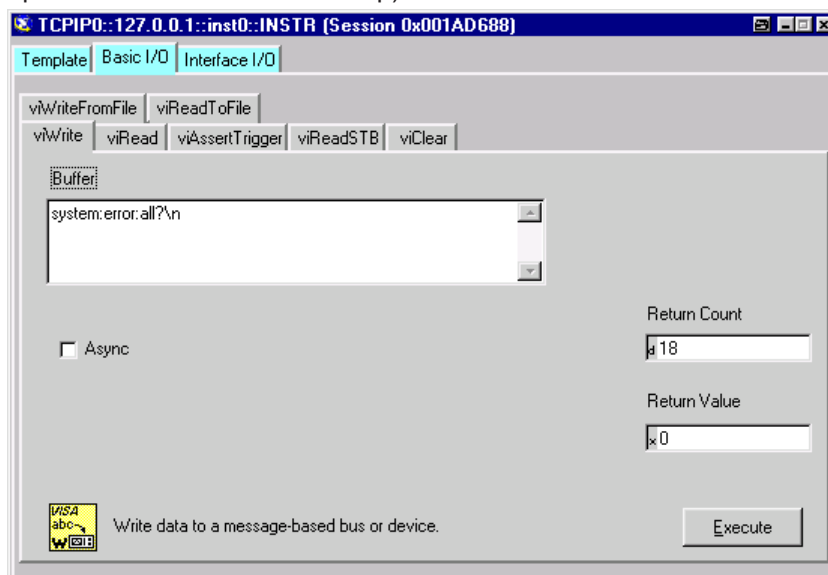


Starting the "Measurement & Automation Control" program for remote control of the R&S UPV.

- Launch the program on the control computer.
- Open panel "Configuration Instruments and Interfaces" and select under "VISA Ethernet Devices" Instrument R&S UPV (=Alias).
- Open the "Open VISA Session" menu with the right mouse key.



- On the "viWrite" tab in the "Basic I/O" panel, commands can be sent to the instrument; instrument responses are displayed on the viRead tab (for further program operation refer to the online help).



Returning to manual control is possible from the front panel or on the LAN interface.

6.3.3 Remote Control via the USB Device Interface

For remote control via the USB bus (not with FMR6, see [chapter 2.6.1, "Retrieving Computer Hardware Information and Windows Operating System"](#), on page 50) the control computer and the instrument must be connected by a USB cable. A program for controlling instruments, such as the VISA program library with USB support (Version 3.4 or later) must be installed in the control computer. The instrument is controlled via the standardized USB protocol.

The only information necessary for establishing a link is the USB Vendor ID of Rohde&Schwarz (0x0AAD), the Class ID of the R&S UPV (0x004D) and the serial

number of the instrument. These IDs form part of the resource name, which the programs use to identify and control the instrument. The resource name has the form:

USB::0x0AAD::0x004D::serialnum::INSTR

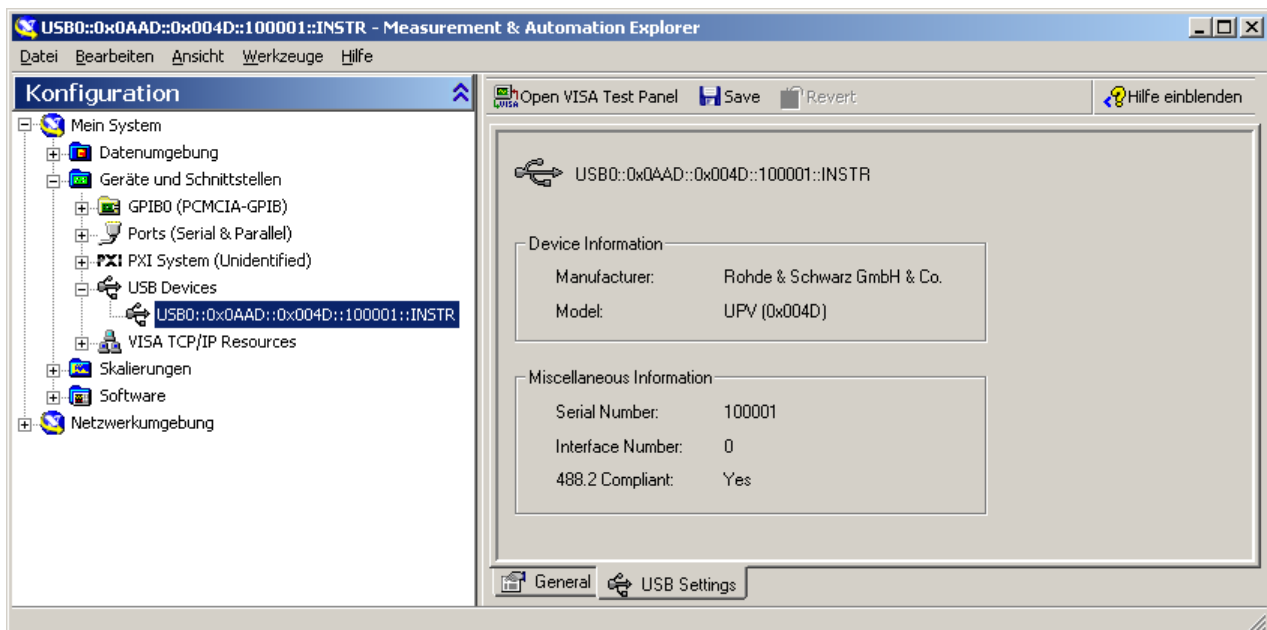
Here **serialnum** must be replaced by the serial number of the instrument. For example, if the serial number of the instrument is 100534, the valid resource name is **USB::0x0AAD::0x004D::100534**.

USB designates the interface that is used. If multiple instruments are connected to the USB bus, each instrument has its own serial number and thus its own associated resource name. The controller distinguishes these instruments by their resource name.

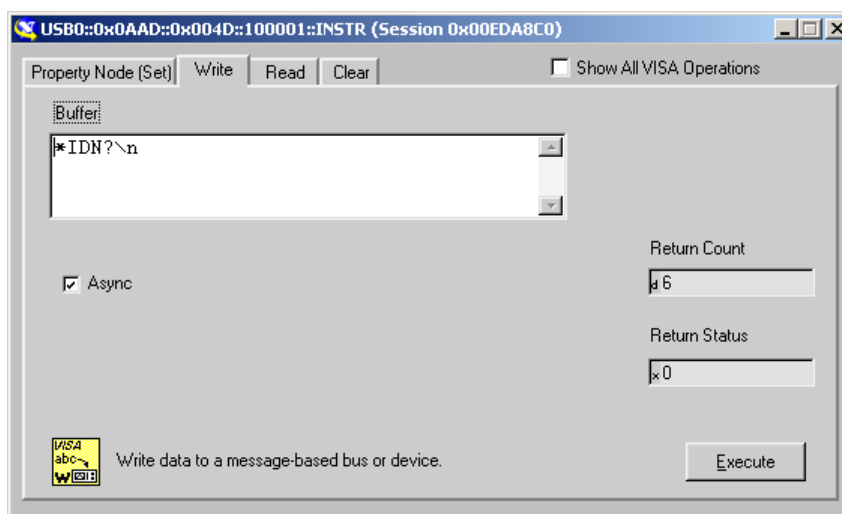
The National Instruments "Measurement & Automation Explorer" program is used in the following example of USB remote control setup. This program makes it easy to establish a connection and get started with testing.

Configuring the control of R&S UPV in the 'Measurement & Automation Control' program.

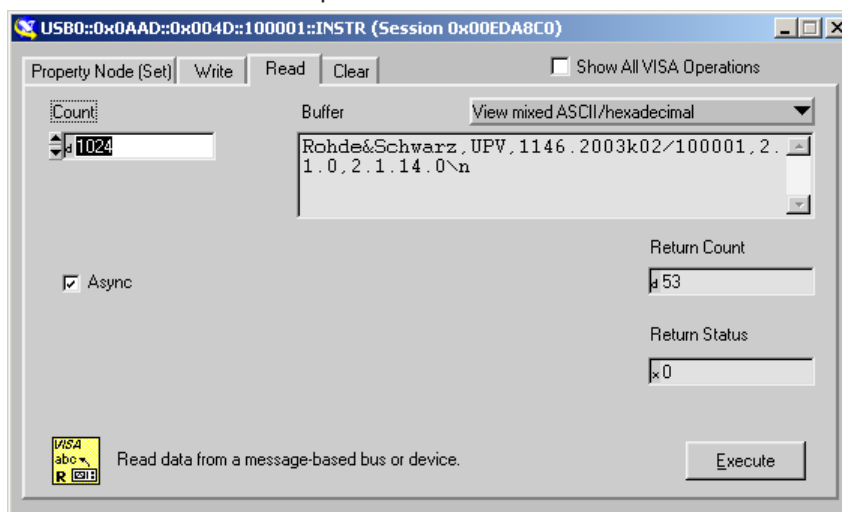
- Launch the program on the control computer.
- Open "USB Devices" in the Instruments and Interfaces window.
- Select R&S UPV.



- Press the "Open VISA Test Panel" button.
- Select the "Write" tab and press the "Execute" button.



- Select the "Read" tab and press the "Execute" button.



If the link is working properly, the identification string of the R&S UPV will be displayed here.

6.4 Messages

The messages transmitted on the data lines of the IEC/IEEE bus or on a TCP/IP network can be divided into two groups:

- Interface messages
- Device-dependent messages

6.4.1 Interface Messages

Interface messages are transmitted on the data lines of the IEC/IEEE bus when the ATN control line is active. They are used for communication between the controller and

the instrument and can only be sent by a controller which has controller functionality on the IEC/IEEE bus.

Interface messages can be further classified as

- – Universal commands
- – Addressed commands

Universal commands affect all devices connected to the IEC/IEEE bus without requiring an address, whereas addressed commands only affect devices addressed as a listener. The interface messages relevant for a device are listed in [chapter 8.4, "Instrument Interfaces"](#), on page 1040.

If an Ethernet connection is present, signaling on a hardware control line is not required. The IEC/IEEE bus interface commands are emulated (see [chapter 8.4, "Instrument Interfaces"](#), on page 1040).

6.4.2 Device-Dependent Messages

Device-dependent messages are transmitted on the data lines of the IEC/IEEE bus when the ATN control line is not active. ASCII code is used for data transmission.

If an Ethernet connection is present, signaling on a hardware control line is not required.

Device-dependent messages are identical for the two interfaces (IEC/IEEE bus and Ethernet). They are differentiated by the direction in which they are sent:

Commands (program messages)

are messages sent by the controller to a device. They operate device functions and request information.

These commands are in turn differentiated by two criteria:

1. The effect they have on the device:

Setting commands	trigger device settings, e.g. a device reset or setting of the generator frequency.
Queries	cause data to be put in the output queue, e.g. for device identification or querying a setting. These commands are formed by adding a question mark to the setting command.

2. Their definition in the IEEE 488.2 and SCPI standard:

Common Commands	are precisely defined by the IEEE 488.2 standard in function and notation. They relate to functions such as the management of standard status registers, reset and self-test.
Device-specific commands	relate to functions that depend on device characteristics such as the frequency setting. A large number of these commands are also standardized by the SCPI consortium. Device-specific extensions following SCPI rules are permitted by the standard.

Device responses (response messages and service request)

are messages sent by a device to the controller after a query. They can include measurement results, device settings or information about device status (see [chapter 6.5.2, "Responses to Queries"](#), on page 818).

The structure and syntax of device-dependent messages are explained in the following section.

6.5 SCPI Command Structure and Syntax

Commands consist of a header and usually one or more parameters. The header and parameters are separated by a "white space" (ASCII code 0 to 9, 11 to 32 decimal, e.g. space). Headers may be composed of several keywords. Queries are formed by adding a question mark direct to the header.



The commands used in the following examples are not implemented in the instrument in every case.

Common Commands

Non-device-specific commands consist of a header preceded by an asterisk "*" and possibly one or more parameters.

Examples:

*RST	RESET, resets the instrument
*ESE 253	EVENT STATUS ENABLE, sets bits of the Event Status Enable Register
*ESR?	EVENT STATUS QUERY, queries of the content of the Event Status register.

Device-specific commands

Hierarchy:

Device-specific commands have a hierarchic structure (see figure below). The different levels are represented by compound headers. Headers at the highest level (root level) have one keyword only. This keyword identifies a whole command system.

Example:

SOURce

This keyword identifies the SOURce command system.

For commands at lower levels the whole path has to be stated. This starts left with the highest level, and the individual keywords are separated by a colon ":".

Example:

SOURce:VOLTAge:OFFSet:STATe ON

This command is on the fourth level of the SOURce system. It sets the DC offset of the generator signal.

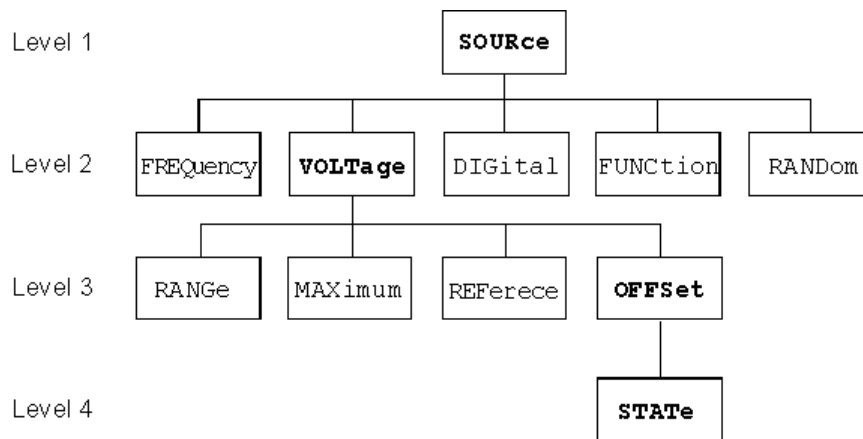


Fig. 6-1: Tree structure of SCPI command systems taking SOURce system as example (extract)

Command level:	<p>Some keywords appear at several levels within a command system. Their effect then depends on the command structure, i.e. where they are inserted in the command header.</p> <p>Example:</p> <pre>SENSe:REFerence:MODE VALue ...</pre> <p>This command contains the keyword <code>REFerence</code> in the second command level.</p> <p>It specifies that the reference value for referenced units in the function measurement system is entered as a value (by a separate command).</p> <pre>SOURce:DIGital:REFerence AZERo AONE</pre> <p>This command contains the keyword <code>REFerence</code> in the third command level.</p> <p>It specifies that the data of the digital reference generator are all 0 or 1.</p>
Optional key-words:	<p>In some command systems it is possible to insert certain keywords in the header or omit them. These keywords are identified in the manual by square brackets. For reasons of compatibility with the SCPI standard, the device must be able to recognize the full length of the command. Some commands become considerably shorter when the optional keywords are omitted.</p> <p>Example:</p> <pre>INSTRument[1][:SElect] ANLG DIG</pre> <p>This command sets the generator to analog or digital signal generation. The following command has the same effect:</p> <pre>INSTRument[1][:SElect] ANLG DIG</pre> <p>means that the command can be sent to the instrument in its detailed form as <code>INSTRument1:SElect ANLG DIG</code>. The command <code>INSTRument ANLG DIG</code> without the keywords identified by brackets has the identical effect</p> <p>Note:</p> <p>An optional keyword cannot be omitted if its effect is specified in more detail by a numeric suffix. In the R&S UPV this applies to the keyword <code>SENSe</code> for example, which can always be omitted for the function measurement = <code>SENSe1</code>, but must always be entered for the</p> <ul style="list-style-type: none"> • input measurement = <code>SENSe2</code>, • frequency/phase measurement = <code>SENSe3</code> and <code>SENSe4</code>, • FFT monitor = <code>SENSe5</code> • level monitor = <code>SENSe6</code> • for the waveform monitor = <code>SENSe7</code> but must always be specified.
Long and short form:	<p>The keywords have a long form and a short form. Keywords may be entered in long or in short form; other abbreviations are not allowed.</p> <p>Examples:</p> <pre>SENSe:POWer:REFerence:RESistance <nu> = SENS:POW:REF:RES <nu></pre> <p>Note:</p> <p>Upper- and lower-case letters are only used to identify the long and short form in the manual; the device itself does not differentiate between the two types of characters.</p>

Parameter:	<p>Parameters must be separated from the header by a "white space". If a command contains several parameters, they are separated by a comma.</p> <p>Example:</p> <pre>OUTPut:SAMPlE:FREQuency 48000 HZ TRACe:SWE:STORe:AX 1.1,1.2,1.3,1.4</pre>
Numeric suffix:	<p>If an instrument has several identical functions or features, e.g. inputs, the desired function can be selected by a suffix to the command. Entries without a suffix are interpreted as having a suffix 1. Optional keywords must be specified if they select a function with the suffix.</p> <p>Example:</p> <pre>SENSe[1]:FUNctIon RMS SENSe2:FUNctIon IPE SENSe6:FUNctIon LRMS SENSe7:FUNctIon ON</pre> <p>These commands activate the measurement functions Function, Input and Level Monitor. The keyword SENSe and the numeric suffixes 2 and 6 must be entered in the command.</p> <p>Note:</p> <p>In case of remote control, suffix counting may differ from the numbers of the corresponding selection used in manual control. SCPI prescribes that suffix counting starts with 1. Suffix 1 is the default state and used when no specific suffix is stated.</p>

6.5.1 Structure of a Program Message

A program message can contain one or more commands. It is terminated by a <New Line> (ASCII code 10 decimal) or <EOI> (EOI line active) together with the last useful character of the program message. Seeing as the <Carriage Return> character (ASCII code 13 decimal) has no effect as a filler before the end character, the combination <Carriage Return><New Line> is also admissible.

Several commands in a program message are separated by a semicolon ";". If the next command belongs to a different command system, the semicolon is followed by a colon. A colon ':' at the beginning of a command marks the root node of the command tree, but can be omitted.

Example:

```
:SENSe:VOLTage:RANGe:MODE FIX;:INPut:MCHannels1 ON
```

This program message contains two commands. The first command belongs to the SENSe system and is used to set a fixed range. The second command belongs to the INPut system and activates channel 1.

If the successive commands belong to the same system and therefore have one or more common levels, the program message may be shortened. The second command following the semicolon then starts at the level below the common levels (see also Fig. 5-1 Tree structure of SCPI command systems taking SOURce system as example (extract)).

The colon after the semicolon must then be omitted.

Example:

```
:DISPlay:SWEep:A:TOP 10 DBFS;:DISPlay:SWEep:A:BOTTom -170 DBFS
```

This program message is shown in **full length** and contains two commands separated by a semicolon. Both commands belong to the `DISPlay` system and its `SWEep` sub-system, i.e. they have two common levels.

In the shortened program message the second command starts at the level below `DISPlay:SWEep`. The colon after the semicolon is omitted.

The shortened form of the program message is:

```
:DISP:SWE:A:TOP 10 DBFS;BOTT -170 DBFS
```

A new program message always starts with the full path however.

Example:

```
:DISPlay:SWEep:A:TOP 10 DBFS
:DISPlay:SWEep:A:BOTTom -170 DBFS
```



An optional keyword cannot be omitted if its effect is specified in more detail by a numeric suffix:

Example:

```
:DISPlay:SWEep1:A:TOP 10 DBFS;:DISPlay:SWEep2:A:BOTTom -170 DBFS
```

cannot, as shown in the example above, be abbreviated, as the keywords `SWEep1` and `SWEep2` have different meanings due to the suffix: `SWEep1` addresses the first sweep graphic subsystem, `SWEep2` the second.

6.5.2 Responses to Queries

Unless expressly specified otherwise, a query is defined for each setting command, which returns the current **value**. It is formed by adding a question mark to the associated setting command. The question mark can be supplemented with `MIN` or `MAX` to query the current **value range** of a numeric parameter.

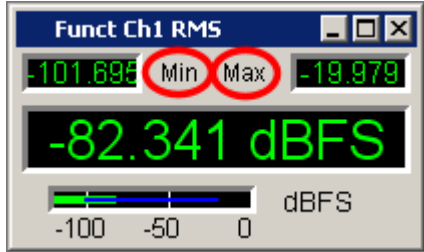
The commands with which measurement results are read out have a **special status**. A question mark extended with `MIN` and `MAX` indicates the minimum and maximum measured value shown in the combo display above the measured value.

If the `MIN` and `MAX` extension is used on text parameters, strings and query only commands which do not retrieve measured values a timeout occurs, followed by an error message in the error queue.

1. Numeric parameter

Example:	Response:
:OUTPut: SAMPlE:FREQuency?	48 KHZ
:OUTPut: SAMPlE:FREQuency? MIN	30 KHZ
:OUTPut: SAMPlE:FREQuency? MAX	200 KHZ

2. Measurement Results

<p>Example:</p> <pre>:SENSe:DATA? :SENSe:DATA? MIN :SENSe:DATA? MAX</pre> 	<p>Response:</p> <pre>-82.341 DBFS -101.695 DBFS -19.979 DBFS</pre>
--	--

3. Strings are returned in single quotation marks.
Extension with MIN AND MAX is not permissible.

<p>Example:</p> <pre>:MMEMory:SWEep:STORe?</pre>	<p>Response:</p> <pre>'MYTRACE.TRC'</pre>
---	--

4. Text parameters (character data) are returned in short form.
Extension with MIN AND MAX is not permissible.

<p>Example:</p> <pre>:SENSe:FUNCTion?</pre>	<p>Response:</p> <pre>RMS</pre>
--	--

6.5.3 Parameter

Most commands require the entry of a parameter. Parameters must be separated from the header by a "white space". Parameters may be numeric values, Boolean parameters, text, character strings or block data. The type of parameter required for the particular command is stated in the details of the command.

Numeric values	Numeric values may be entered in any customary form, i.e. with sign, decimal point and exponent. The range of values is -9.9E37 to 9.9E37. The exponent is denoted by "E" or "e". The exponent alone must not be used.
Numeric strings	The format specified under "Numeric values" also applies to the individual values of a numeric string. Numeric values are to be separated from each other by means of a comma. Numeric strings are not entered between quotation marks. Example: TRACe:SWEep:STORe:AY 0.1,0.2,0.3,0.4,0.5
Units	Physical quantities may be stated with the unit. Permissible unit prefixes are K (kilo), M (milli) and U (micro). The SCPI command determines which unit prefixes are permissible. If the unit is not specified, then the base unit is used. Example: SOURce:FREQuency 1.5 kHz = SOURce:FREQuency 1.5E3

Text parameter	<p>Text parameters follow the syntax rules for keywords, i.e. they also have a long and a short form. They must be separated from the header by a "white space" like any other parameter. A query returns either the long or short form of the text parameter depending on the setting "Longform" in the Config panel.</p> <p>If a text parameter is set which is already set in the data basis of the audio analyzer the internal R&S UPV the internal setting routine is not performed. This behavior increases the speed of the IEC bus control program.</p> <p>Example:</p> <p>Setting command: <code>:SOURce:SWEep:CONTRol ASWeep</code></p> <p>Query: <code>:SOURce:SWEep:CONTRol?</code></p> <p>Response: <code>ASWorASWeep</code></p>
Strings	<p>Character strings must always be entered between single or double quotation marks. Filenames also count as strings. Normally, however, single quotation marks are used, as double quotation marks are used to mark the complete IEC bus command as a string.</p> <p>String commands can be written via IEC bus command, even if the respective setting line is not visible in the panel.</p> <p>Example:</p> <p><code>MMEMemory:LOAD:STATe 'c:\Config\setup\default.xml'</code></p>
Block data	<p>The '#' character identifies the start of a block data record which is defined as follows: <code>#<LengthOfLength><Length><Binary data record> <LengthOfLength></code> specifies how many characters the following length specification has. <code><Length></code> indicates the number of following bytes of the binary data record. The length information consists of ASCII characters. If, for example, the <code><Length></code> of a binary data block is 35, this involves ASCII character '3' and '5' with the binary equivalents 00110011 and 00110101 or the hexadecimal equivalents 0x33 and 0x35. <code><Binary data record></code> designates the binary data record with the specified length.</p> <p>Example:</p> <p><code>MMEMemory:LOAD:STATe 'c:\Config\setup\default.xml'</code></p>

6.5.4 Overview of Syntax Elements

The following list gives you an overview of the syntax elements.

- : The colon separates the keywords of a command. In a command line, the colon following a semicolon identifies the highest command level.
- ; The semicolon separates two commands in a command line. It does not change the path.
- , The comma separates several parameters of a command.
- ? The question mark forms a query.
- * The asterisk identifies a common command.
- " Quotation marks denote the beginning of a character string and terminate it.
- # The double cross denotes the beginning of block data.
- A "white space" (ASCII code 0 to 9, 11 to 32 decimal, eg space) separates header and parameter.
- . Decimal point of numeric values.

6.6 Device Model and Command Processing

The device model shown in the following figure was created from the point of view of processing SCPI commands. The individual components operate independently of each other and simultaneously. They communicate with each other by means of messages.

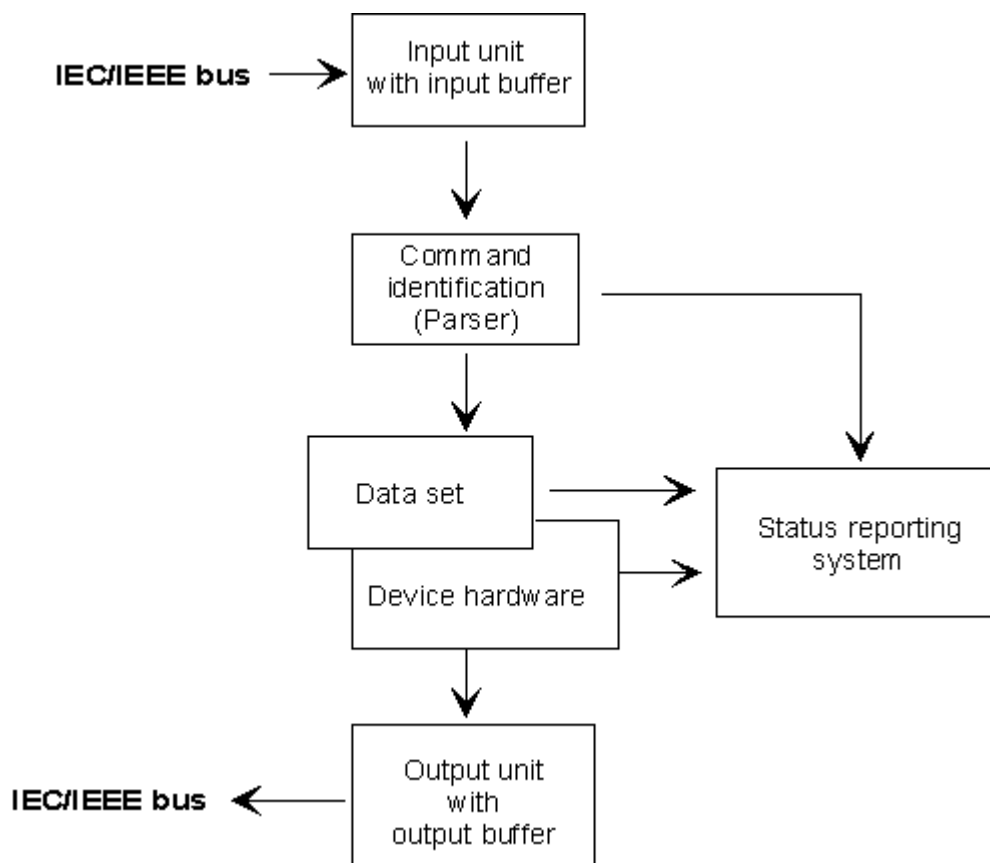


Fig. 6-2: Device model for remote control via IEC/IEEE bus or TCP/IP network

6.6.1 Input Unit

The input unit receives commands in the form of characters from the IEC/IEEE bus or Ethernet and collects them in the input buffer. The input unit sends a message to the command recognition as soon as it detects an end character according to IEEE 488.2 (new line = ASCII code 10 decimal or EOI line becomes active), the interface message DCL or a full input buffer. If the input buffer is full, the IEC/IEEE bus or Ethernet transfer is halted and the data received until then are processed. Then the IEC/IEEE bus or Ethernet transfer is continued. If the buffer is not yet full when the end character is received however, the input unit can receive the next command while the previous command is parsed and executed. Reception of a DCL clears the input buffer and immediately triggers a message to the parser.

6.6.2 Parser Analyzes

The parser analyzes the data received from the input unit. Data are processed in the sequence in which they were received. Only a DCL is given priority; a GET (Group Execute Trigger) for example is not processed until after the previously received commands. Every command detected as correct is immediately forwarded to the database and executed.

Syntax errors are recognized by the parser and forwarded to the status reporting system. The remainder of a program message after a syntax error is, in as much as possible, further analyzed and processed. After the syntax test, the value range of the parameter may be checked.

6.6.3 Database and Device Hardware

The term "device hardware" refers to that part of the device which performs the actual instrument function, e.g. generator setting, analyzer setting. This does not include the controller.

The term "database" denotes a database that manages all the parameters and associated settings required for setting the device hardware.

Setting commands lead to a change in the data set of the database. The database administration enters the new values (e.g. frequency) and immediately sets the hardware.

An IEC/IEEE bus program message that may contain several setting commands is sent to the parser, which examines the IEC/IEEE bus commands for syntax and semantic errors. Once a command is identified as correct, a check is immediately made with current settings to see whether the command is admissible. If the command is admissible, it is transferred to the database of the R&S UPV and the device hardware is set. If existing settings show that the command is illegal, it is rejected, an execution error is sent to the status reporting system and the device hardware is not set for this command. Subsequent commands that are admissible on the basis of the existing settings are executed (see following section). This strictly hierarchic procedure ensures that no illegal device status can occur at any time.

6.6.4 Command Sequence (IEC/IEEE)

Every IEC/IEEE bus command received by the R&S UPV is immediately checked for its admissibility. This is only possible if the R&S UPV knows for which instrument or function the command is intended, i.e. the appropriate instrument or function was activated before.

Example:

- If a trigger channel is to be set in the multi channel analyzer, several start conditions are available which are not available for "Trigger Chan" = Off.
- If these checks and the appropriate error messages were omitted, measurements would be performed with erroneous settings, or even be impossible, and the user would not know why.

Identical menu items in different instruments or functions are addressed by the same command in remote control, so they can only be distinguished by reference to the particular instrument or function.

Example:

- The command `INPut:CHANnel CH1` is permitted for all two-channel analyzer tools.

- To be able to preset individual parameters of functions that are not yet active, each IEC/IEEE bus command would have to be told to which instrument and which function it refers. The internally managed addressing of commands by the R&S UPV would then be the job of the IEC/IEEE bus programmer, who would have to handle a multiple number of commands.

A major feature in operation of the R&S UPV is its ability to note the settings for individual generator and analyzer functions and to restore all required parameters when one of these functions is selected. This does away with the need to reset all parameters when a function is changed.

Example:

- The generator function "Mod Dist" is set with frequencies of 400 Hz and 7 kHz. When you switch to the DFD function, the frequency pair 11 kHz and 12 kHz last used with the DFD function is automatically restored.
- This functionality is also available under IEC/IEE bus control, i.e. even in remote control all parameters are automatically set when the function is changed. This is much faster and surer than the user having to set the parameters each time on the IEC/IEEE bus.
- If the R&S UPV did not have this ability, the user could overwrite parameters for instruments that are not active, and the parameters of the function last used would no longer be available.

Since manual and remote control work with the same internal data sets and a mixture of manual and remote control must be possible, only one uniform method of internal parameter processing can be used for the two modes. Automatic parameter restoration is indispensable for manual control, so it must also be used for remote control.

To relieve the user of the need to watch out for relationships that are in part not apparent, the following applies to both remote control and manual control of the R&S UPV:



Nothing can be set on the R&S UPV that is not admissible.

The disadvantage of this is that sometimes a certain operating sequence has to be adhered to even in remote control. But this is more than compensated by the fact that possible setting errors are immediately indicated by the instrument.

6.6.5 Status Reporting System

The status reporting system collects information about the device status and makes it available to the output unit on request. The structure and function are explained in section [chapter 6.8, "Status Reporting System"](#), on page 828.

6.6.6 Output Unit

The output unit collects the information requested by the controller and which it obtains from database administration. It processes the information in line with SCPI rules and makes it available in the output buffer.

If the device is addressed as a talker and the output buffer does not contain any data or expect data from the database, the output unit sends the error message "Query UNTERMINATED" to the status reporting system. No data are sent on the IEC/IEEE bus or Ethernet, and the controller waits for the set time limit. This procedure is prescribed by SCPI.

6.6.7 Triggering Measurement or Sweep

There are three ways of triggering a measurement or a sweep :

- * By the SCPI-specific command `INIT`
- * By the common command `*TRG`
- * With the addressed command **Group Execute Trigger** `GET`

All three possibilities are equivalent and similar in the time they take to execute.

There are also three ways of waiting for a triggered measurement result, which are looked at in the next section. To demonstrate the three trigger possibilities together with singly triggered measurement results, command synchronization with `*WAI` is used in what follows.

6.6.8 Command Synchronization

To ensure that commands are executed in a certain sequence, one of the commands `*OPC`, `*OPC?` or `*WAI` must be used. As a result of these commands, a certain action is not triggered until the hardware is set and settled. The controller can be forced through appropriate programming to wait for the appearance of an action.

Table 6-1: Synchronization with `*OPC`, `*OPC?` and `*WAI`

Command	Effect	Programming of controller
<code>*OPC</code>	Sets the Operation Complete bit in the ESR after processing all commands sent before <code>*OPC</code> .	- Set bit 0 in ESE - Set bit 5 in STB - Wait for Service Request
<code>*OPC?</code>	Stops further command processing until 1 is returned. This is not the case until the Operation Complete bit is set in the ESR. This bit indicates that the previous setting has been completed.	Send <code>*OPC?</code> directly after the command whose processing should be terminated before other commands can be executed.
<code>*WAI</code>	Stops further command processing until all commands sent before <code>*WAI</code> have been executed.	Send <code>*WAI</code> directly after the command whose processing should be terminated before other commands are executed.

In remote control of the R&S UPV it is essential to wait for the end of a measurement or sweep before the measured results are fetched and the hardware is newly set.

The following table explains the effect of different combinations of measurement or sweep triggering in conjunction with a synchronization command.

Table 6-2: Trigger command with/without synchronization

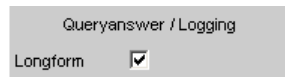
Trigger command with/without synchronization	Description
INIT:CONT OFF;*WAI	<p>A single measurement or sweep is triggered. Subsequent commands are processed after the measurement or sweep is completed.</p> <p>Generator and analyzer setting commands do not trigger a new measurement.</p> <p>A new measurement must be triggered with INIT;*WAI</p> <p>.</p> <p>This command is the simplest to use and should preferably be used to trigger a measurement.</p>
"INIT:CONT ON;*WAI"	<p>A continuous measurement or continuous sweep will be triggered. Subsequent commands will not be processed until the first measurement or the first sweep cycle has been completed.</p> <p>Generator and analyzer configuration commands immediately trigger a restart of the continuous measurement.</p>
"INIT:CONT OFF" without *WAI	<p>When a generator or analyzer setting command is sent during a single measurement, i.e. before the measurement is completed, the measurement is restarted to avoid incorrect results (incorrect results could be obtained, for instance, if the generator voltage is varied during the measurement).</p> <p>Generator or analyzer setting commands sent after the single measurement has been terminated will not trigger a new measurement. A new measurement must be triggered with "INIT".</p>
"INIT:CONT ON" without *WAI	<p>Each generator or analyzer setting command restarts a measurement to avoid incorrect measurement results (incorrect results could be obtained, for instance, if the generator voltage is varied during the measurement).</p>

6.7 Command Recording

The R&S UPV offers the possibility of recording the equivalent IEC/IEEE bus commands in a separate window during manual control. The recording runs as long as the window is open. The contents of the window can be edited (also deleted) and copied to the clipboard.

In this way it is very easy to produce the matching IEC/IEEE bus control program from a manual control sequence without having to look up the commands in the manual. This also eliminates malfunctions through the wrong notation.

From the Config Panel (Menu * Utilities * Config Panel), you can select whether to use the short or long form of the command parameters when recording commands or querying parameters (Query).



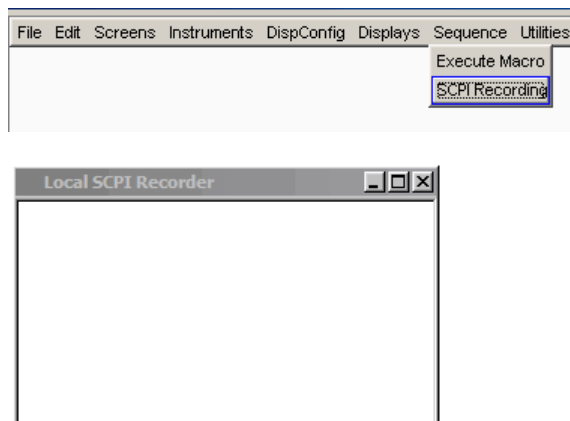
Remote-control command:

```
SYSTem:QLONG ON | OFF
```

Example: If the analog generator has been set to "Output Type" = Bal, the query `OUTPut : TYPE?` returns `BAL` in the short form and `BALanced` in the long form.

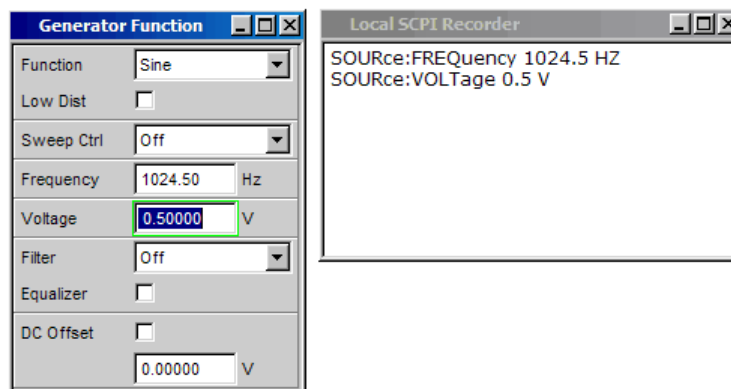
6.7.1 Starting Recording

Open the window through the "Menu" by "Sequence" * "SCPI Recording"



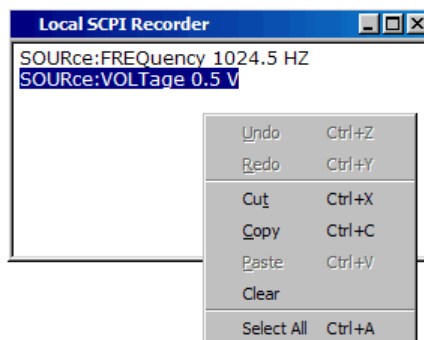
6.7.2 Recording Commands

As long as the SCPI Recording window is opened, almost all settings of manual control are recorded. Exceptions are a few setting commands that affect the graphical representations and whose setting is generally not required via remote control. In this example, the generator frequency was set to 1024.5 Hz and the level to 0.5 V.



6.7.3 Editing Commands

The contents of the SCPI Recording window can be edited and copied through the clipboard into a file. From the commands in this file it is possible to generate an IEC/IEEE bus control program. Open the context menu by clicking on the right mouse key. To operate the SCPI Recorder you need an external keyboard and mouse.



6.8 Status Reporting System

The status reporting system stores all information about the current operating status of the device, (e.g. that it is currently performing a hard copy) and about errors that occurred. This information is stored in the status registers and the error queue. The contents of status registers and the error queue can be queried on the IEC/IEEE bus or via the LAN or USB interface.

Information is hierarchically structured. The highest level is formed by the Status Byte (STB) register defined in IEEE 488.2 and the associated Service Request Enable (SRE) register.

The STB obtains its information from the standard Event Status Register (ESR) also defined in IEEE 488.2 with the associated enable register standard Event Status Enable (ESE) and the registers defined by SCPI, `STATus:OPERation` and `STATus:QUESTionable` and the instrument-specific registers

STATUS:XQUESTIONable, STATUS:QUESTIONable:UNDERrange, STATUS:QUESTIONable:OVERrange and STATUS:QUESTIONable:MEASuring, which contain more detailed information about the instrument.

The status reporting system also includes the IST (Individual Status) flag and the Parallel Poll Enable (PPE) register assigned to it. The IST flag, like the SRQ, combines the complete device status in a single bit. The PPE has the same function for the IST flag as the SRE has for the service request.

The output buffer contains messages that the device sends back to the controller. It is not part of the status reporting system but determines the value of the MAV bit in the STB.

6.8.1 Structure of SCPI Status Register

Each SCPI register consists of five 16 bit parts with different functions (see figure below). The individual bits are independent of each other, i.e. each hardware status is assigned a bit number that is the same for all five parts. For instance, bit 5 of the STATUS:OPERation register is assigned to the Wait for Trigger hardware status in all five parts.

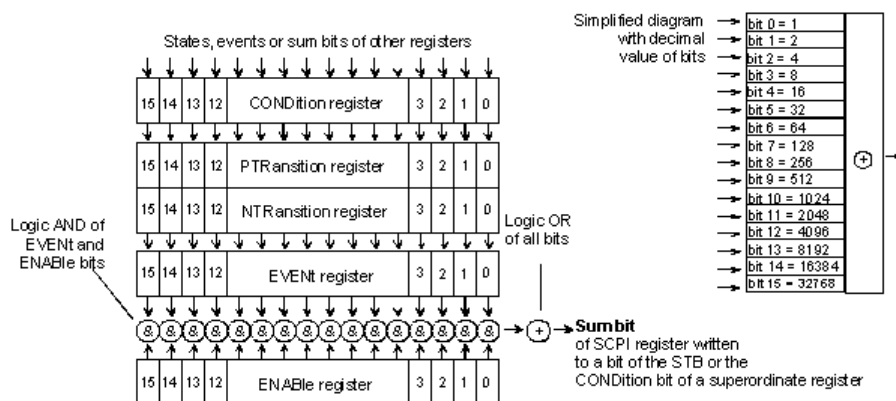


Fig. 6-3: General structure of the status registers

Bit 15 (the most significant bit) is set to 0 in all parts for the STATUS:OPERation, STATUS:QUESTIONable and STATUS:XQUESTIONable, registers, except for the device-specific registers STATUS:QUESTIONable:UNDERrange, STATUS:QUESTIONable:OVERrange, and STATUS:QUESTIONable:MEASuring, for these registers bit 15 denotes channel 16 of a 16 channel R&S UPV with 2x R&S UPV-Option B48.

Queries return the current value of the particular part register to allow a check of the device status. A decimal value between 0 and 32767 ($= 2^{15} - 1$), or between 0 and 65535 ($= 2^{16} - 1$), is returned.

The configuration commands set the respective part register, thus determining which status changes of the R&S UPV cause a change in the status registers. A decimal value between 0 and 32767 ($= 2^{15} - 1$), or between 0 and 65535 ($= 2^{16} - 1$), is set.

- CONDITION**
 The CONDITION part is written directly by the hardware or the summary bit of the subordinate register. Its contents indicate current device status. This register part

can only be read, not written or cleared. Reading the register does not change its contents.

- **PTRansition**

These two transition register parts enable you to define the status change of the `CONDition` part (none, 0 to 1, 1 to 0 or both) that is to be held in the `EVENT` part. The `Positive-TRansition` part acts as a transition filter. On transition of a bit of the `CONDition` part from 0 to 1, the associated PTR bit, decides whether the `EVENT` bit is set to 1.

- PTR bit = 1: the `EVENT` bit is set.
- PTR bit = 0: the `EVENT` bit is not set.

This part can be written and read. Reading does not change its contents.

- **NTRansition**

The `Negative-TRansition` part also works as a transition filter. On transition of a bit of the `CONDition` part from 1 to 0, the associated NTR bit, decides whether the `EVENT` is set to 1.

- NTR bit = 1: the `EVENT` bit is set.
- NTR bit = 0: the `EVENT` bit is not set.

This part can be written and read. Reading does not change its contents.

- **EVENT**

The `EVENT` part indicates whether an event has taken place since the last read out. It is the memory of the `CONDition` part. It only indicates events passed through the transition filters. The `EVENT` part is continuously updated by the device. This part is read-only. Reading clears its contents. This part is often equated with the overall register.

- **ENABLE**

The `ENABLE` determines whether the associated `EVENT` bit contributes to the total bit (see below). Each bit of the `EVENT` part is ANDed to the corresponding `ENABLE` bit ('&' symbol). The results of all logical operations of this part are ORed (symbol '+') and passed on to the summary bit.

`ENABLE` Bit = 0: the associated `EVENT` bit does not contribute to the total bit

`ENABLE` Bit = 1: if the associated `EVENT` bit is 1, the total bit is likewise set to 1.

This part can be written and read as required. Reading does not change its contents.

Summary bit

As stated above, the summary bit for each register is derived from the `EVENT` and `ENABLE` parts. The result is then entered in a bit of the `CONDition` part of the higher-level register. The device automatically generates the summary bit for each register. This enables an event, e.g. an overrange, to lead to a service request through all hierarchy levels.

6.8.2 Overview of Status Registers

R&S UPV status registers

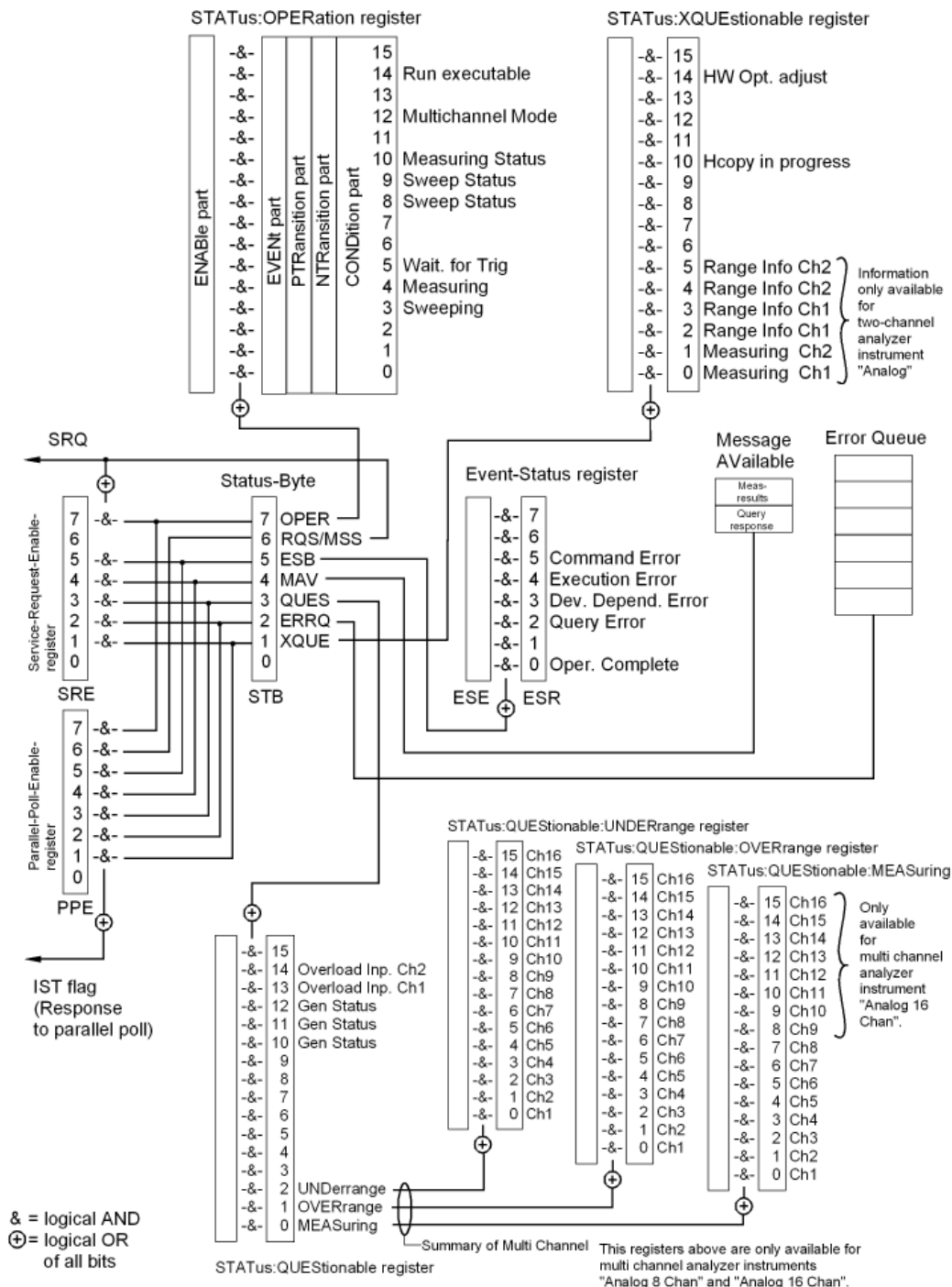


Fig. 6-4: Overview of Status Registers

6.8.3 Status Byte (STB) and Service Request Enable (SRE) Register

The STB is already defined in IEEE 488.2. It gives a rough overview of the device status, collecting information from the lower-level registers. So it is comparable with the CONDITION part of an SCPI register and is at the highest level of the SCPI hierarchy. It is special in that bit 6 acts as the summary bit of all other bits of the status byte.

Reading the STB does **not** delete its content!

The status byte is read out with the `*STB?` or a Serial Poll.

Associated with the STB is the SRE. The function of the SRE corresponds to that of the ENABLE part of the SCPI registers. Each bit of the STB is assigned a bit in the SRE. Bit 6 of the SRE is ignored. If a bit is set in the SRE and the associated bit in the STB changes from 0 to 1, a service request (SRQ) will be generated on the IEC/IEEE bus or Ethernet, which triggers an interrupt in the controller configured for this purpose, and can be further processed by the controller.

The SRE can be set with the `*SRE` command and read out with `*SRE?`.

Reading the `EVENT` deletes the associated bit in the status byte register (e.g. `STAT:OPER:EVEN?` deletes the OPER bit (d7) in the OPERATION register).

Table 6-3: Meaning of bits in status byte

Bit no.	Meaning
7	<p>OPERation status register summary bit</p> <p>This bit is set if an EVENT bit is set in the OPERATION status register and the associated ENABLE bit is set to 1.</p> <p>A set bit indicates that the device is executing an action. The type of action can be determined by querying the OPERATION status register with <code>STATus:OPERation:CONDition?</code> or <code>STATus:OPERation[:EVENT]?</code>.</p>
6	<p>MSS bit (master status summary bit)</p> <p>This bit is set if the device triggers a service request. This is the case if one of the other bits of this register is set together with its mask bit in the service request enable register.</p>
5	<p>ESB bit</p> <p>Summary bit of the event status register. This bit is set if one of the bits in the event status register is set and enabled in the event status enable register.</p> <p>A set bit indicates an error or event that can be specified more precisely by querying the event status register by the command <code>**ESR?</code>.</p>
4	<p>MAV bit (message available)</p> <p>This bit is set if there is a readable message in the output buffer. A measurement result or response to a query (i.e. IEC/IEEE bus command with '?') is present and can be read.</p>
3	<p>QUESTionable status summary bit</p> <p>This bit is set if an EVENT bit is set in the QUESTionable status register and the associated ENABLE bit is set to 1.</p> <p>A set bit denotes a questionable device status, which can be specified more precisely by querying the QUESTionable status register with <code>STATus:QUESTionable:CONDition?</code> or <code>STATus:QUESTionable[:EVENT]?</code>.</p>

Bit no.	Meaning
2	<p>Error queue not empty</p> <p>The bit is set if the error queue has an entry. This can be fetched by the command <code>SYSTEM:ERRor?</code>. If this bit is enabled by the SRE, each entry of the error queue will generate a service request. An error can thus be recognized and specified in more precisely by querying the error queue.</p>
1	<p>XQUESTionable status summary bit</p> <p>This bit is set if an <code>EVENT</code> bit is set in the <code>XQUESTionable</code> status register and the associated <code>ENABLE</code> bit is set to 1.</p> <p>The register can be read by the queries <code>STATUS:XQUESTionable:CONDition?</code> or <code>STATUS:XQUESTionable[:EVENT]</code>?</p>
0	Not used

6.8.4 IST Flag and Parallel Poll Enable (PPE) Register

Similar to the SRQ, the IST flag combines the complete status information in a single bit. It can be queried by a parallel poll, see [chapter 6.8.12.3, "Parallel Poll"](#), on page 844.

The parallel poll enable (PPE) register determines which bits of the STB contribute to the IST flag. The bits of the STB are ANDed with the corresponding bits of the PPE, bit 6 also being used - in contrast to the SRE. The IST flag is the product of ORing all results. The PPE can be set by the `*PRE` command and read by the `*PRE?` query.

6.8.5 STATus:EVENT Register (ESR)

The ESR is already defined in the IEEE 488.2 standard. It is comparable to the `EVENT` part of an SCPI register. The event status register can be read out by the `*ESR?` query.

Reading the ESR deletes its content!

The ESE can be understood as the `ENABLE` part. It can be set by the `*ESE` command and read out by the `*ESE?` query

Table 6-4: Meaning of bits in event status register

Bit no.	Meaning
7	Not used
6	<p>User request</p> <p>This bit is set on pressing the LOCAL key, i.e. when the device is switched to manual control.</p> <p>This bit is set with CTRL+F11 or upon closing the remote window with the mouse, i.e. when the instrument is switched to manual operation.</p>
5	<p>Command error</p> <p>This bit is set if an undefined command or a command with incorrect syntax is received. An error message describing the error more precisely is entered in the error queue.</p>

Bit no.	Meaning
4	Execution error This bit is set if the syntax of a received command is correct but the command cannot be executed due to various marginal conditions. An error message describing the error more precisely is entered in the error queue.
3	Device-dependent error This bit is set if a device-dependent error occurs. An error message describing the error more precisely is entered in the error queue.
2	Query error This bit is set in either of the two following cases: the controller wants to read data from the device but has not sent a query, or it sends new commands to the device before it retrieves existing requested data.
1	Not used
0	Operation complete When the *OPC command is received, this bit is set if all previous commands have been executed.

6.8.6 STATus:OPERation Register

The CONDition register contains information on the operations currently being performed by the device, while the EVENT register contains information on the operations performed by the device since the last readout of the register. It can be read by the query `STATus:OPERation:CONDition?` or `STATus:OPERation[:EVENT]?`.

Reading the EVENT part deletes its content!

Table 6-5: Meaning of bits in STATus:OPERation register

Bit no.	Meaning
15	Not used
14	Run executable If an executable program (*.exe) is started manually or by means of the <code>SYSTEM:PROGRAMm:EXECute 'filename'</code> command, this bit is set to 1; when the program is completed, this bit is reset to 0. The change from 1/ 0 can be checked by means of a Serial poll and Parallel poll, or it can trigger an SRQ in order to fetch measurement data, for example.
13	Not used
12	Multichannel mode 0 = Two-channel operation 1 = Multichannel operation
11	Not used
10	Measuring status Together with bit 4, this bit results in the following statuses: Bit 4, 10
	0 0 = Measuring Terminated
	0 1 = Measuring Stopped
	Single measurement completed
	Measurement has been stopped

Bit no.	Meaning	
	1 0 = Measuring Single	Single measurement in progress
	1 1 = Measuring Cont	Continuous measurement is being performed
8 and 9	Sweep status Together with bit 3, this bit results in the following statuses: Bit 3, 9, 8	
	0 0 0 = Sweep Off	No sweep is being performed
	0 0 1 = Not used	
	0 1 0 = Sweep Stopped	Sweep was halted and can be continued
	0 1 1 = Sweep Waiting	Sweep is waiting to (re)start
	1 0 0 = Sweep Run Manual	Manual sweep is being performed
	1 0 1 = Sweep Run Single	Single sweep is being performed
	1 1 0 = Sweep Run Cont	Continuous sweep is being performed
	1 1 1 = Not used	
7	Not used	
6	Not used	
5	Waiting for trigger This bit is set as long as the R&S UPV is waiting for a trigger event. Example: The generator outputs a sine burst signal with a "Burst on Delay" of 2 s. As trigger condition for the analyzer, a "Lev Trig" is set under "Start Cond". For a period of 2 s, i.e. as long as the trigger condition is not met, this bit is set. Once the trigger event occurs, this bit is reset.	
4	Measuring This bit is set while the R&S UPV is performing a measurement. Bit 10 indicates the measuring status. Together with bit 10, this results in the following statuses: Bit 4, 10	
	0 0 = Measuring Terminated	Single measurement completed
	0 1 = Measuring Stopped	Measurement has been stopped
	1 0 = Measuring Single	Single measurement in progress
	1 1 = Measuring Cont	Continuous measurement is being performed
	Bits 0 and 1 in the STATus:XQUEstionable register indicate which channel this information refers to:	
	0	Measuring Ch1 (bit 0)
	0	Measuring Ch2 (bit 1)
	0 0	= Not used
	0 1	= The information refers only to channel 2
	1 0	= The information refers only to channel 1

Bit no.	Meaning
	1 1 = The information refers to both channels
3	Sweeping This bit is set while the R&S UPV is performing a sweep. Bits 8 and 9 indicate the sweep status.
2	Not used
1	Not used
0	Not used

6.8.7 STATus:QUESTionable Register

This register contains information about questionable device statuses. These may occur when the device is operated beyond its specifications. It can be read by the queries `STATus:QUESTionable:CONDition?` or `STATus:QUESTionable[:EVENT]?`

Reading the `EVENT` part deletes its content!

Bit no.	Meaning								
15	Not used								
14 13	Analyzer status for measurement with the two-channel analog instrument Bit 14, 13 <table border="0"> <tr> <td>0 0 = No Overload</td> <td>Normal operating status (none of the input channels are overloaded)</td> </tr> <tr> <td>0 1 = Anlr1 Overload</td> <td>Input channel 1 is overloaded</td> </tr> <tr> <td>1 0 = Anlr2 Overload</td> <td>Input channel 2 is overloaded</td> </tr> <tr> <td>1 1 = Anlr1, Anlr2 Overload</td> <td>Both input channels are overloaded</td> </tr> </table> <p>One or both input channels with the input impedance of 300 or 600 ohm is overloaded! To protect the analyzer input, the input is switched to high impedance and the generator output is disabled. Measurement is continued.</p> <p>Ways to recover from overload: Remove overvoltage (maximum input voltage on 300 and 600 ohm is 25 V) and switch the generator back on with the <code>OUTPut ON</code> command. The input impedance is reset to the previous value.</p>	0 0 = No Overload	Normal operating status (none of the input channels are overloaded)	0 1 = Anlr1 Overload	Input channel 1 is overloaded	1 0 = Anlr2 Overload	Input channel 2 is overloaded	1 1 = Anlr1, Anlr2 Overload	Both input channels are overloaded
0 0 = No Overload	Normal operating status (none of the input channels are overloaded)								
0 1 = Anlr1 Overload	Input channel 1 is overloaded								
1 0 = Anlr2 Overload	Input channel 2 is overloaded								
1 1 = Anlr1, Anlr2 Overload	Both input channels are overloaded								
12 11 10	Generator status Bit 12, 11, 10 <table border="0"> <tr> <td>0 0 0 = Not used</td> <td></td> </tr> <tr> <td>0 0 1 = Generator Off</td> <td>Both generator channels are off</td> </tr> <tr> <td>0 1 0 = Generator Running</td> <td>Generator outputs signal</td> </tr> <tr> <td>0 1 1 = Not used</td> <td></td> </tr> </table>	0 0 0 = Not used		0 0 1 = Generator Off	Both generator channels are off	0 1 0 = Generator Running	Generator outputs signal	0 1 1 = Not used	
0 0 0 = Not used									
0 0 1 = Generator Off	Both generator channels are off								
0 1 0 = Generator Running	Generator outputs signal								
0 1 1 = Not used									

Bit no.	Meaning
	1 0 0 = Generator Halted Generator outputs zero level 1 0 1 = Generator Overrun The sampling rate on the external input is too high for the selected digital instrument. Samples missing in signal. Both generator channels are off. 1 1 0 = Generator Overload Generator overloaded, output disabled 1 1 1 = Output Off Output disabled
9	Not used
8	Not used
7	Not used
6	Not used
5	Not used
4	Not used
3	Not used
2	Summary of multichannel UNDERrange for multichannel operation Summary bit for the lower-order STATus:QUEStionable:UNDERrange register, which makes the underrange information for the individual channels available during multichannel operation.
1	Summary of multichannel OVERrange for multichannel operation Summary bit for the lower-order STATus:QUEStionable:OVERrange register, which makes the overrange information for the individual channels available during multichannel operation.
0	Summary of multichannel MEASuring for multichannel operation Summary bit for the lower-order STATus:QUEStionable:MEASuring register, which returns the activated channels during multichannel operation.

6.8.8 STATus:QUEStionable:UNDERrange Register

This register only contains underrange information concerning the individual channels of multichannel operation. It can be read by the query

```
STATus:QUEStionable:UNDERrange:CONDition?OR
```

```
STATus:QUEStionable:UNDERrange[:EVENT]?
```

.

Reading the EVENT part deletes its content!

Table 6-6: Meaning of bits in STATus:QUEStionable:UNDERrange register

Bit No.	Meaning
15	Ch 16
14	Ch 15
These bits are only valid if the R&S UPV is equipped with two options B48. 0 = The channel in question is not underranged.	

Bit No.	Meaning	
13	Ch 14	1 = The channel in question is underranged; the measurement result is inaccurate and no longer in line with the specifications of the R&S UPV. The associated summary bit is in the <code>STATUS:QUESTIONABLE</code> register bit 2
12	Ch 13	
11	Ch 12	
10	Ch 11	
9	Ch 10	
8	Ch 9	
7	Ch8	0 = The channel in question is not underranged. 1 = The channel in question is underranged; the measurement result is inaccurate and no longer in line with the specifications of the R&S UPV. The associated summary bit is in the <code>STATUS:QUESTIONABLE</code> register bit 2
6	Ch7	
5	Ch6	
4	Ch5	
3	Ch4	
2	Ch3	
1	Ch2	
0	Ch1	

6.8.9 STATUS:QUESTIONABLE:OVERrange Register

This register only contains overrange information concerning the individual channels of multichannel operation. It can be read by the query

```
STATUS:QUESTIONABLE:OVERrange:CONDITION?OR
```

```
STATUS:QUESTIONABLE:OVERrange[:EVENT]?
```

.

Reading the EVENT part deletes its content!

Table 6-7: Meaning of bits in STATUS:QUESTIONABLE:OVERrange register

Bit No.	Meaning	
15	Ch 16	These bits are only valid if the R&S UPV is equipped with two options B48.
14	Ch 15	
13	Ch 14	0 = The channel in question is not overranged. 1 = The channel in question is overranged. If the measurement result of an over-ranged channel is requested with the <code>SENSx:DATAy?</code> command, the value "3.40282346639e+038" (represents NaN = Not a Number) is returned.
12	Ch 13	
11	Ch 12	
10	Ch 11	
9	Ch 10	The associated summary bit is in the <code>STATUS:QUESTIONABLE</code> register bit 1
8	Ch 9	
7	Ch8	
7	Ch8	0 = The channel in question is not overranged.

Bit No.	Meaning
6	Ch7
5	Ch6
4	Ch5
3	Ch4
2	Ch3
1	Ch2
0	Ch1

1 = The channel in question is overranged. If the measurement result of an over-ranged channel is requested with the SENSx:DATAy? command, the value "3.40282346639e+038" (represents NaN = Not a Number) is returned.

The associated summary bit is in the STATus:QUEStionable register bit 1

6.8.10 STATus:QUEStionable:MEASuring Register

This register only contains information which channels are switched on or off for multi-channel operation. It can be read by the query

```
STATus:QUEStionable:MEASuring:CONDition?OR
```

```
STATus:QUEStionable:MEASuring[:EVENT]?
```

.

Reading the EVENT part deletes its content!

Table 6-8: Meaning of bits in STATus:QUEStionable:MEASuring register

Bit No.	Meaning
15	Ch 16
14	Ch 15
13	Ch 14
12	Ch 13
11	Ch 12
10	Ch 11
9	Ch 10
8	Ch 9
7	Ch8
6	Ch7
5	Ch6
4	Ch5
3	Ch4
2	Ch3
1	Ch2
0	Ch1

These bits are only valid if the R&S UPV is equipped with two options B48.

Returns the setting of channels of multichannel operation in the Analyzer Config panel.

0 = The channel in question is deactivated
1 = The channel in question is activated

The associated summary bit is in the STATus:QUEStionable register bit 0

Returns the setting of channels of multichannel operation in the Analyzer Config panel.

0 = The channel in question is deactivated
1 = The channel in question is activated

The associated summary bit is in the STATus:QUEStionable register bit 0

If a two-channel analyzer is switched on, the bits 0 ... 15 are deleted.

6.8.11 STATus:XQUEstionable Register

This register contains extra information to the status operation register and seldom occurring status information. It can be read by the query

```
STATus:XQUEstionable:CONDition?OR
```

```
STATus:XQUEstionable[:EVENT]?
```

Reading the EVENT part deletes its content!

Table 6-9: Meaning of bits in STATus:XQUEstionable Register

Bit no.	Meaning
15	Not used
14	HW option adjust
13	Not used
12	Not used
11	Not used
10	Hard copy in progress
9	Not used
8	Not used
7	Not used
6	Not used
5 4	Range info Ch 2 for the two-channel measurement mode
	d3 d2
	0 0 = Measurement result valid
	0 1 = Not used
	1 0 = Underrange (measurement result possibly inaccurate) on channel 2
	1 1 = Overage (measurement result invalid) on channel 2
3 2	Range Info Ch 1 for the two-channel measurement mode
	d3 d2
	0 0 = Measurement result valid
	0 1 = Not used
	1 0 = Underrange (measurement result possibly inaccurate) on channel 1
	1 1 = Overage (measurement result invalid) on channel 1

Bit no.	Meaning	
1	Measuring Ch2 for the two-channel measurement mode Bit set: channel 2 is switched on. The information of the MEASuring bit (d4) and the measuring status bit (d10) of the STATUS-OPERation register refers to channel 2..	
	0	Measuring bit (d4) of the STATUS-OPERation register
	0	Measuring status bit (d10) of the STATUS-OPERation register
	0 0	Measuring Terminated Single measurement completed
	0 1	Measuring Stopped Measurement has been stopped
	1 0	Measuring Single Single measurement in progress
	1 1	Measuring Cont Continuous measurement is being performed
0	Measuring Ch1 for the two-channel measurement mode Bit set: channel 1 is switched on. The information of the measuring bit (d4) and the measuring status bit (d10) of the STATUS-OPERation register refers to channel 1.	
	0	Measuring bit (d4) of the STATUS-OPERation register
	0	Measuring status bit (d10) of the STATUS-OPERation register
	0 0	Measuring Terminated Single measurement completed
	0 1	Measuring Stopped Measurement has been stopped
	1 0	Measuring Single Single measurement in progress
	1 1	Measuring Cont Continuous measurement is being performed

If a multichannel analyzer is switched on, the bits 0 ... 5 are deleted.

6.8.12 Use of Status Reporting System

For efficient use of the status reporting system, the information it contains has to be transferred to the controller and further processed. There are various methods, which are described below.

6.8.12.1 Service Request, Use of Hierarchical Structure

Under certain conditions the device may send a service request to the controller. This service request usually triggers an interrupt on the controller to which the control program can respond by suitable actions. As seen in section [chapter 6.8.2, "Overview of Status Registers"](#), on page 831, an SRQ is always triggered when one or more of the bits 1, 2, 3, 4, 5 or 7 of the status byte are set and enabled in the SRE. Each of these bits combines the information from another register, from the error queue or the output buffer. If the ENABLE registers of the status registers are set accordingly, any bit in any status register will be able to trigger an SRQ.

Example:

Use the *OPC command to generate an SRQ.

```
CALL IBWRT(analyzer%, "*ESE 1") to set the bit 0 in the ESE (Operation Complete)
```

```
CALL IBWRT(analyzer%, "*SRE 32") to set the bit 5 in the SRE (ESB)
```

The device generates an SRQ on completion of its settings.

The SRQ is the only way for the device to become active on its own. Each controller program should set the device such that a service request is triggered in case of malfunctions. The program should respond accordingly to the service request.

6.8.12.2 Serial Poll

Serial poll is mainly used for a fast overview of the status of several devices connected to the IEC/IEEE bus or LAN/USB.

Like the *STB? command, the serial poll is used to query the status byte of a device. Querying is implemented by interface messages, however, making it much faster. The serial poll method is already defined in the IEEE 488.1 standard, and used to be the only uniform method of querying the status byte. This method also works with devices that conform neither to SCPI nor to IEEE 488.2.

The VISUAL BASIC command for executing a serial poll is `IBRSP`.

A prerequisite for programming in VISUAL BASIC are that the project contains the modules NIGLOBAL (Niglobal.bas) and VBIB32 (Vbib_32.bas), and the gpibNotify OLE control module .

Example:

Program:

```
Public UPV As Integer
```

```
Public Info As Integer
```

```
Dim StartT As Single
```

```
Dim Response As String * 1000
```

```

Private Sub ReadESR():
' subroutine for readout of ESR
Call ibwrt(UPV, "**ESR?")
' ask for ESR data
Call ibrd(UPV, Response)
' read ESR data
EventList.AddItem "ESR register is: " + Left(Response, ibcctl - 1)
DoEvents
End Sub

'SRQ subroutine in case RQS was set
Private Sub GPIB_Notify(ByVal LocalUPV As Long, ByVal Localbsta As Long, ByVal Localberr As Long,
ByVal Localbctl As Long, RearmMask As Long)
Call ibrsp(UPV, Info):
' do a serial poll and read STB
EventList.AddItem "SRQ " + " was fired after " + Trim(Str(Timer - StartT)) + " s"
EventList.AddItem "STB register is: " + Trim(Str(Info))
Call ReadESR
ibloc UPV
' switch UPV to local
ibonl UPV, 0
' switch interface offline
End Sub

Private Sub Test_Click():
' main program
Call ibdev(0, 20, 0, T3s, 1, 0, UPV)
' attach instrument
Call ibconfig(0, lbcAUTOPOLL, 1)
' enable auto serial polling
Call ibconfig(0, lbcEndBitIsNormal, 1)
' set END bit on EOS match during read
Call ibconfig(0, lbcEOScmp, 0)
' 7 bit EOS char
Call ibconfig(0, lbcEOSrd, 1)
' terminate read by EOS char
Call ibconfig(0, lbcEOSchar, 10)
' EOS character LF as terminator
Call ibclr(UPV)
' device clear
Call ibwrt(UPV, "**IDN?")
' ask for instrument identity
Call ibrd(UPV, Response)
' read query result
EventList.AddItem Left(Response, ibcctl - 1)
' display query result as message box
DoEvents

Call ibwrt(UPV, "**CLS")
' reset registers
Call ibwrt(UPV, "**ESE 1")
' enable operation complete bit to set ESB
Call ibwrt(UPV, "**SRE 32")
' ESB bit generates SRQ
Call ReadESR
' reading clears ESR register

```

```

GPIB.SetupMask = RQS                                'set notify mask to Service Request
GPIB.SetupNotify UPV                                'call and enable notify function
EventList.AddItem "SRQ enabled ..."
DoEvents

EventList.AddItem "sending INIT command ..."
DoEvents
StartT = Timer
Call ibwrt(UPV, "INIT;*OPC")                        'trigger measurement, rise OPC when ready
EventList.AddItem "waiting for SRQ ..."
EventList.AddItem "-----"
DoEvents

'here the program could do anything else until a SRQ is set

End Sub

```

6.8.12.3 Parallel Poll

In the case of a parallel poll up to eight devices are simultaneously requested by a command from the controller to transmit one bit of information on the data lines, i.e. to set the data line assigned to each device to logic 0 or 1. Analogously to the SRE register, which determines the conditions for generating an SRQ, a parallel poll enable (PPE) register is present that is ANDed bit-by-bit with the STB (taking into account bit 6). The results are ORed and the result is then sent (possibly inverted) to the controller as a response to a parallel poll. The result can also be read without a parallel poll by the command *IST.

The device must first be set for parallel poll by the Visual Basic command IBPPC(). This command assigns the device a data line and specifies whether the response is to be inverted. The parallel poll itself is performed with IBRPP().

The parallel poll mode is mainly used to quickly find out which of the many devices connected to the IEC/IEEE bus or LAN/USB caused an SRQ. For this purpose, SRE and PPE must be set to the same value.

6.8.12.4 Queries

Each part of a status register can be read out by queries. The queries are given in the description of the status commands (STATus subsystem). The queries always yield a number representing the bit pattern of the queried register. This number is evaluated by the controller program.

Queries are mainly used after the appearance of an SRQ to obtain more information about the cause of the SRQ.

6.8.12.5 Error Queue Query

Each error in the device causes an entry in the error queue. The entries in the error queue are detailed error messages in plain text that can be read out on the IEC/IEEE bus or LAN/USB by the query `SYSTEM:ERRor?`. Each `SYSTEM:ERRor?` query is answered by an entry from the error queue. If there are no more error messages in the error queue, the device responds with 0 = "No error".

The error queue should be queried in the controller program after each SRQ since the queue entries provide a more precise description of the error cause than the status registers. In particular, in the test phase of a controller program the error queue should be queried at regular intervals since it also registers faulty commands from the controller to the device.

6.8.13 Initializing the Status Reporting System

Commands `*RST`, `SYSTEM:PRESet DCL` and `SDC` do not affect the status reporting system. Commands `*RST` and `SYSTEM:PRESet` affect the instrument settings.

Table 6-10: Resetting device functions

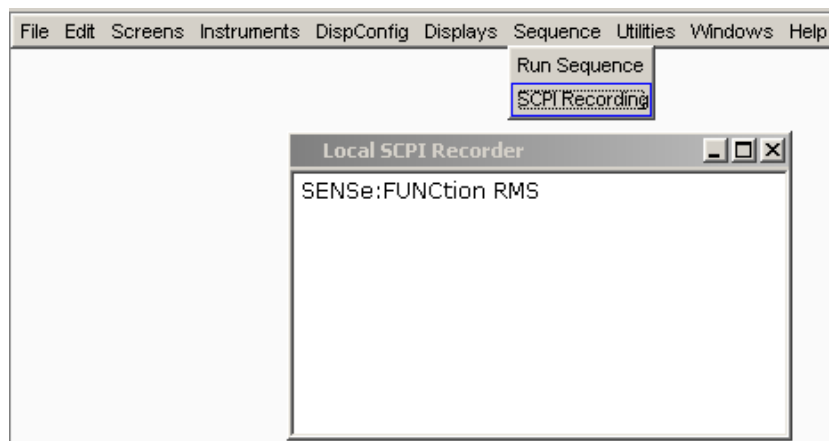
Event	DCL (Device Clear), SDC (Selected DeviceClear)	*RST or SYSTEM:PRESet	STATUS:PRESet	*CLS
Effect				
Clear STB, ESR	–	–	–	yes
Clear SRE, ESE	–	–	–	–
Clear PPE	–	–	–	–
Clear EVENT parts of registers	–	–	–	yes
Delete ENABLE parts of the OPERATION and all QUESTIONable registers	–	–	yes	–
Fill PTRansition parts of all registers with 1, delete NTRansition parts	–	–	yes	–
Clear error queue	–	–	–	yes
Clear output buffer	yes	1)	1)	1)
Clear command processing and input buffer	yes	–	–	–

Event	DCL (Device Clear), SDC (Selected DeviceClear)	*RST or SYS-Tem:PRESet	STATus:PRESet	*CLS
Effect				
Effect on the instrument setting	-	yes	-	-
1) = Any command that is the first in a program message clears the output buffer.				

7 Remote Control - Command Description

The description of each manual setting in [chapter 5, "Instrument Functions"](#), on page 237 also shows the associated remote command. The meaning of the parameter setting fields and the effect of the individual parameters are explained in detail. A link to the command description including the parameters is provided for each setting. In most cases, the parameters shown in the panels can be unambiguously assigned to the parameters included in the remote control commands. For more complex selections or different names for manual and remote settings, the command is extended by a parameter description.

Moreover, the SCPI recording function (see [chapter 6.7, "Command Recording"](#), on page 826 offers a very convenient means of recording manual settings, thus allowing remote control commands to be assigned to the parameter fields in the panels. Since the panels do not provide for any settings relating to the triggering of measurements or reading of results, these functions are not recorded.



This chapter lists all commands. The sequence follows closely the sequence of the description of the manual settings in [chapter 5, "Instrument Functions"](#), on page 237. In addition, the following commands are described:

- Commands that are not available during manual operation and thus cannot be recorded, such as common commands, triggering and output of measurement values
- Commands for using the system, mass memory and status system
- Commands that can only be carried out by using the softkey menu, and thus can also not be recorded.

An alphabetical list at the end of the user documentation offers an overview of all implemented commands.

In [chapter 6, "Remote Control - Fundamentals"](#), on page 802 you will find a general introduction to remote control as well as a description of the status registers.

7.1 Notation of Device-Specific Commands

Long and short form

The mnemonics feature a long form and a short form. The short form is marked by upper case letters, the long form corresponds to the complete word. Either the short form or the long form can be entered; other abbreviations are not permitted.

Example:

INPut:COUPling AC is equivalent to INP:COUP AC.



Case-insensitivity

Upper case and lower case notation only serves to distinguish the two forms in the manual, the instrument itself is case-insensitive.

Numeric suffixes

If a command can be applied to multiple instances of an object, e.g. specific channels or sources, the required instances can be specified by a suffix added to the command. Numeric suffixes are indicated by angular brackets (<1...4>, <n>, <i>) and are replaced by a single value in the command. Entries without a suffix are interpreted as having the suffix 1.

Example:

Definition: DATA:BARGraph:Y<ch>?

Command: DATA:BARG:Y2?

This command reads out the Y axis value of channel 2.

Optional mnemonics

Some command systems permit certain mnemonics to be inserted into the header or omitted. These mnemonics are marked by square brackets in the description. The instrument must recognize the long command to comply with the SCPI standard. Some commands are considerably shortened by these optional mnemonics.

Example:

Definition: STATus:OPERation[:EVENT]?

Command: STAT:OPER:EVENT? is equivalent to STAT:OPER?, the command reads out the content of the EVENT part of the STATus:OPERation register

Parameters

Parameters must be separated from the header by a "white space". If several parameters are specified in a command, they are separated by a comma (.). For a description of the parameter types, refer to [chapter 6.5.3, "Parameter"](#), on page 819..

Example:

Definition: OUTPut:AUDiobits <audiobits>

Command: OUTP:AUD 24

Special characters

	<p>A vertical bar in parameter definitions indicates alternative possibilities in the sense of "or". The effect of the command differs, depending on which parameter is used.</p> <p>Example:</p> <p>Definition: OUTPut:TYPE <type> with parameter <type> = UNBalanced BALanced</p> <p>Command OUTPut:TYPE BALanced selects the balanced input</p> <p>Command OUTPut:TYPE UNBalanced selects the unbalanced input</p>
[]	<p>Mnemonics in square brackets are optional and may be inserted into the header or omitted.</p> <p>Example: INSTrument[SElect] <inst> with parameter <inst> = ANLG DIG</p> <p>INST:SEL ANLG is equivalent to INST ANLG and selects the analog generator.</p>

7.1.1 SCPI Parameters

Many commands are supplemented by a parameter or a list of parameters. The parameters must be separated from the header by a "white space" (ASCII code 0 to 9, 11 to 32 decimal, e.g. blank). Allowed parameters are:

- Numeric values
- Special numeric values
- Boolean parameters
- Text
- Character strings
- Block data

The parameters required for each command and the allowed range of values are specified in the command description.

7.1.1.1 Numeric values

Numeric values can be entered in any form, i.e. with sign, decimal point and exponent. Values exceeding the resolution of the instrument are rounded up or down. The mantissa may comprise up to 255 characters, the exponent must lie inside the value range -32000 to 32000. The exponent is introduced by an "E" or "e". Entry of the exponent alone is not allowed. In the case of physical quantities, the unit can be entered. Allowed unit prefixes are G (giga), MA (mega), MOHM and MHZ are also allowed), K (kilo), M (milli), U (micro) and N (nano). If the unit is missing, the basic unit is used.

Example: SOUR:FREQ:REF 1500 = SOUR:FREQ:REF 1.5E3

7.1.1.2 Units

For physical quantities, the unit can be entered. Allowed units depend on the command used:

- k or K (kilo)
- m or M (milli)
- u or U (micro)

If the unit is missing, the basic unit is used.

Example:

```
SENS:FREQ:REF 1.5kHz = SENS:FREQ:REF 1500
```

Some settings allow relative values to be stated in percent. According to SCPI, this unit is represented by the `PCT` string.

Example:

```
DISPlay:SWEEp:A:TOP 100PCT
```

7.1.1.3 Special numeric values

The texts `MINimum` and `MAXimum` are interpreted as special numeric values. They denote the minimum and maximum value.

The numeric values associated to `MAXimum`/`MINimum` can be queried by adding the corresponding mnemonics to the command. They must be entered following the quotation mark (see also [chapter 6.5.2, "Responses to Queries"](#), on page 818).

Example:

Setting command: `SOUR:VOLT MAX`

Query: `SOUR:VOLT? MAX`

Response: maximum numeric value

7.1.1.4 Boolean Parameters

Boolean parameters represent two states. The "ON" state (logically true) is represented by "ON" or a numeric value 1. The "OFF" state (logically untrue) is represented by "OFF" or the numeric value 0. The character values are provided as the response for a query.

Example:

Setting command: `SENSe:FILTer:AWEighting ON` or `1`

Query: `SENSe:FILTer:AWEighting?`

Response: ON

7.1.1.5 Text parameters

Text parameters observe the syntactic rules for mnemonics, i.e. they can be entered using a short or long form. Like any parameter, they have to be separated from the header by a white space. Command `SYSTem:QLONg OFF | ON` determines if the short or long form is provided in the case of a query.

Example:

Setting command: `SENSe:THD:REJection NARRow`

Query: `SENS:THD:REJ?`

Response: `NARR` or `NARRow` depending on `SYSTem:QLONg` on page 1037

7.1.1.6 Character strings

Strings must always be entered in quotation marks (' or ").

Example:

Definition: `MMEMemory:LOAD:FREQuency <file>`

Setting command: `MMEMemory:LOAD:FREQuency "Test1"` or

`MMEMemory:LOAD:FREQuency 'Test1'`

7.2 Common Commands

The common commands are taken from the IEEE 488.2 (IEC 625–2) standard. Some commands have the same effect on different devices. The headers of these commands consist of an asterisk "*" followed by three letters. Many common commands refer to the status reporting system which is described in detail in [chapter 6.8, "Status Reporting System"](#), on page 828.

Available Common Commands

- [*CLS](#) on page 852
- [*CLS](#) on page 852
- [*ESE](#) on page 852
- [*ESR?](#) on page 852
- [*GTL](#) on page 852
- [*IDN?](#) on page 852
- [*IST?](#) on page 853
- [*OPC](#) on page 853
- [*OPC?](#) on page 853
- [*PRE](#) on page 853
- [*PSC](#) on page 854

- [*RST](#) on page 854
- [*SRE](#) on page 854
- [*STB?](#) on page 854
- [*TRG](#) on page 854
- [*WAI](#) on page 855

***CLS**

CLEAR STATUS sets the status byte (STB), the standard event register (ESR) and the EVENT part of all QUESTIONable and the OPERATION register to zero. The command does not alter the mask and transition parts of the registers. It clears the output buffer.

In order to start a remote control program with a defined initial device status use command [*RST](#) or `SYSTEM:PRESet` to preset the instrument. Then use command [*CLS](#) to clear the ESR Event status register e.g. in case of an aborted synchronization.

***ESE <Value>**

EVENT STATUS ENABLE sets the event status enable register to the value indicated. The query form [*ESE?](#) returns the contents of the event status enable register in decimal form.

Parameters:

<Value> 0 to 255

***ESR? <Value>**

STANDARD EVENT STATUS QUERY returns the contents of the event status register in decimal form (0 to 255) and subsequently sets the register to zero.

Parameters:

<Value> 0 to 255

Usage: Query only

***GTL**

Go To Local ends remote control and returns to manual control.

Usage: Event

***IDN?**

IDENTIFICATION QUERY queries the instrument identification. The instrument type, order and serial number and the firmware version are returned.

Return values:

Example: Return values
Rohde&Schwarz, UPV-2, 1146.2003K02/10001, 2.1.60.0-2-3-0
Rohde&Schwarz, UPV = instrument type
1146.2003K02/10001 = part number/serial number
2.1.60.0 = firmware version
2.3.0 = R&S UPV version

Usage: Query only

***IST? <StatusBit>**

INDIVIDUAL STATUS QUERY returns the contents of the IST flag in decimal form. The IST flag is the status bit which is sent during a parallel poll (see also [chapter 6.8, "Status Reporting System"](#), on page 828).

Parameters:

<StatusBit> 0 | 1

Usage: Query only

***OPC**

OPERATION COMPLETE sets bit 0 in the event status register after all preceding commands have been executed. This bit can be used to initiate a service request (see also [chapter 6.6, "Device Model and Command Processing"](#), on page 821).

***OPC?**

OPERATION COMPLETE QUERY returns a 1 when all previous commands have been processed. It is important that the timeout set on the IEC/IEEE bus is sufficiently long.

***OPT? <Options>**

OPTION IDENTIFICATION QUERY queries the options included in the instrument and returns a list of the options installed. The options are separated from each other by means of commas.

Usage: Query only

***PRE <Value>**

PARALLEL POLL REGISTER ENABLE sets the parallel poll enable register to the indicated value. The query form *PRE? returns the contents of the parallel poll enable register in decimal form.

Parameters:

<Value> 0 to 255

***PSC** <Function>

POWER ON STATUS CLEAR determines whether the contents of the ENABLE registers are preserved or reset during power-up.

The query form ***PSC?** reads out the contents of the power-on-status-clear flag. The response can be 0 or 1.

Parameters:

<Function>	0 1
	0
	Causes the contents of the status registers to be preserved. Thus a service request can be generated when switching on the instrument, if the status registers ESE and SRE are suitably configured.
	1
	Resets the registers.

***RST**

RESET sets the instrument to a defined default status. The command essentially corresponds to pressing PRESET. This command clears the Enable and NTRansition parts of the Operation and Questionable registers and fills the PTRansition part with 1.

In order to start a remote control program with a defined initial device status use command ***RST** or **SYSTEM:PRESet** to preset the instrument. Then use command ***CLS** to clear the ESR Event status register e.g. in case of an aborted synchronization.

***SRE** <Value>

SERVICE REQUEST ENABLE sets the service request enable register to the indicated value. Bit 6 (MSS mask bit) remains 0. This command determines under which conditions a service request is generated. The query form ***SRE?** reads the contents of the service request enable register in decimal form. Bit 6 is always 0.

Parameters:

<Value>	0 to 255
---------	----------

***STB?**

READ STATUS BYTE QUERY reads out the contents of the status byte in decimal form.

Usage: Query only

***TRG**

TRIGGER initiates a measurement or a sweep.

***WAI**

WAIT-to-CONTINUE permits servicing of subsequent commands only after all preceding commands have been executed and all signals have settled (see also [chapter 6.6, "Device Model and Command Processing"](#), on page 821).

7.3 Generator Settings

The generator settings commands are described in the following sequence:

1. Selecting the generator
2. Configuring the different types of generator
3. Setting the generator signal parameters
4. Special function: Rapid Deactivation of Outputs

7.3.1 Selecting the Generator

The generator type is selected with the `INSTRument` command.

INSTRument<n1> <generator_type>

This command selects the generator or analyzer. The active selection is determined by suffix <n1> at `INSTRument`.

Suffix:

<n1>

1 | 2

Suffix 1 (or no suffix) at `INSTRument` defines that selection of the generator is active.

Suffix 2 at `INSTRument` defines that selection of the analyzer is active, see [chapter 7.4.1, "Selecting the Analyzer"](#), on page 891.

Parameters:

<generator_type> ANLG | DIG | I2SBoard | | IMPairment | U2CHannel

ANLG
selects the analog generator

DIG
selects the digital generator

I2SBoard
selects the I²S generator

IMPairment
requires options R&S UPV-B2 (Digital Audio Interfaces) and -K22 (Jitter and Interface Test): selects the generation of impairment using the digital generator.

U2CHannel
selects USI Dual Channel generator

For analyzer parameters see [chapter 7.4.1, "Selecting the Analyzer"](#), on page 891.

Manual operation: See "[Instrument](#)" on page 237

7.3.2 Configuring the Generators

The generator settings are performed in the `OUTPut` and `SOURce` sub systems.

7.3.2.1 Reference Level and Frequency

Common generator commands concern the setting of the reference level and frequency. These settings are performed in the `SOURce` subsystem.

- `SOURce:FREQuency:REFeRence` on page 856
- `SOURce:VOLTage:REFeRence` on page 856

SOURce:FREQuency:REFeRence <reference>

Parameters:

<reference> float

Manual operation: See "[Ref Frequency](#)" on page 242
 See "[Ref Frequency](#)" on page 258
 See "[Ref Frequency](#)" on page 259
 See "[Ref Frequency](#)" on page 266
 See "[Ref Frequency](#)" on page 279

SOURce:VOLTage:REFeRence <reference>

Parameters:

<reference> float

Manual operation: See ["Ref Voltage"](#) on page 241
 See ["Ref Voltage"](#) on page 258
 See ["Ref Voltage"](#) on page 259
 See ["Ref Voltage"](#) on page 266
 See ["Ref Voltage"](#) on page 279

7.3.2.2 Configuring the Analog Generator

- [OUTPut: BANDwidth: MODE](#) on page 857
- [OUTPut: CHANnel](#) on page 857
- [OUTPut: IMPedance](#) on page 857
- [OUTPut: LOW](#) on page 857
- [OUTPut: TYPE](#) on page 858
- [SOURce: VOLTage: MAXimum](#) on page 858
- [SOURce: VOLTage: RANGE](#) on page 858

OUTPut: BANDwidth: MODE <mode>

Parameters:

<mode> B22 | B40 | B80 | AUTO

Manual operation: See ["Bandwidth"](#) on page 240

OUTPut: CHANnel <channel>

Parameters:

<channel> OFF | CH1 | CH2 | CH2Is1

Manual operation: See ["Channel"](#) on page 238
 See ["Channel"](#) on page 251
 See ["Channel"](#) on page 262

OUTPut: IMPedance <impedance>

Parameters:

<impedance> selection | R10 | R200 | R600

Manual operation: See ["Impedance"](#) on page 239

OUTPut: LOW <low>

Parameters:

<low> FLOat | GROund

Manual operation: See ["Common"](#) on page 240

OUTPut:TYPE <type>**Parameters:**

<type> BALanced | UNBalanced

Manual operation: See "Output Type " on page 239

SOURce:VOLTagE:MAXimum <maximum>**Parameters:**

<maximum> float

Manual operation: See "Max Voltage" on page 241

SOURce:VOLTagE:RANGe <range>**Parameters:**

<range> AUTO | FIXed

Manual operation: See "Volt Range" on page 241

7.3.2.3 Configuring the Digital Generator

The generation of the impairment signals requires options R&S UPV-B2 and R&S UPV-K22,

- [OUTPut:AUDiobits](#) on page 859
- [OUTPut:AUXiliary:OUTPut](#) on page 859
- [OUTPut:CHANnel](#) on page 857
- [OUTPut:CSIMulator](#) on page 859
- [OUTPut:IMPedance](#) on page 857
- [OUTPut:IMPedance:UNBalanced?](#) on page 859
- [OUTPut:INTClockfreq](#) on page 859
- [OUTPut:SAMPle:MODE](#) on page 859
- [OUTPut:SIGNAL:BALanced:LEVel](#) on page 860
- [OUTPut:SIGNAL:LEVel](#) on page 860
- [OUTPut:SYNC:OUTPut](#) on page 860
- [OUTPut:SYNC:TYPE](#) on page 860
- [OUTPut:UNBalanced:OUTPut](#) on page 860
- [SOURce:FRAMephase](#) on page 860
- [SOURce:IMPairment](#) on page 860
- [SOURce:PTORef](#) on page 861
- [SOURce:REFerence](#) on page 861
- [SOURce:SRCMode](#) on page 861

- [SOURCE:SYNC:TO](#) on page 861

OUTPut:AUDIobits <audiobits>
Parameters:

<audiobits> integer

Manual operation: See ["Audio Bits "](#) on page 256
 See ["Audio Bits "](#) on page 264
 See ["Audio Bits "](#) on page 273

OUTPut:AUXiliary:OUTPut <output>
Parameters:

<output> AINPut | AINReclock | AOUTput | RGENerator | AUXin

Manual operation: See ["Aux Output"](#) on page 253

OUTPut:CSIMulator <csimulator>
Parameters:

<csimulator> OFF | SIMLong

Manual operation: See ["Cable Sim"](#) on page 258

OUTPut:IMPedance:UNBalanced?
Parameters:

<unbalanced> selection | R10 | R200 | R150 | R600

Usage: Query only

Manual operation: See ["Impedance"](#) on page 239

OUTPut:INTClockfreq <intclockfreq>
Parameters:

<intclockfreq> float

Manual operation: See ["Int Clk Freq"](#) on page 253

OUTPut:SAMPlE:MODE <mode>
Parameters:

<mode> selection | F32 | F44 | F48 | F88 | F96 | F176 | F192 |
 SYNChron | VALue | F08 | F11 | F16 | F22 | F384 | AUTO

Manual operation: See ["Sample Frequency"](#) on page 255
 See ["Sample Freq"](#) on page 263
 See ["Sample Freq"](#) on page 274

OUTPut:SIGNal:BALanced:LEVel <level>**Parameters:**

<level> float

Manual operation: See ["Bal Ampl"](#) on page 257

OUTPut:SIGNal:LEVel <level>**Parameters:**

<level> float

Manual operation: See ["Unbal Ampl"](#) on page 257

OUTPut:SYNC:OUTPut <output>**Parameters:**

<output> selection

Manual operation: See ["Sync Output"](#) on page 252

OUTPut:SYNC:TYPE <type>**Parameters:**

<type> WCLock | BCLock

Manual operation: See ["Sync Out Type"](#) on page 253

OUTPut:UNBalanced:OUTPut <output>**Parameters:**

<output> AINPut | AOUTput

Manual operation: See ["Unbal Output"](#) on page 257

SOURce:FRAMePhase <framephase>**Parameters:**

<framephase> float

Manual operation: See ["Frame Phase"](#) on page 255

SOURce:IMPairment <impairment>**Parameters:**

<impairment> integer

Manual operation: See ["Add Impairment"](#) on page 251

SOURce:PTORef <ptoref>**Parameters:**

<ptoref> OFF | VALue

Manual operation: See "[Phase To Ref](#)" on page 254

SOURce:REFErence <reference>**Parameters:**

<reference> AZERo | AONE

Manual operation: See "[Ref Gen Data](#)" on page 254

SOURce:SRCMode <srcmode>**Parameters:**

<srcmode> ADATa | JITTer | COMMon

Manual operation: See "[Source Mode](#)" on page 259

SOURce:SYNC:TO <to>**Parameters:**<to> selection | INTClock | GCLock | AINPut | AUXinput | SINPut |
SINVinput | INTern | EXTMasterclock | EXTWordclock |
EFSYnc | ICLock | EMASterclock | EFAMon | EFBCIk**Manual operation:** See "[Sync To](#)" on page 251
See "[Sync To](#)" on page 263
See "[Sync To](#)" on page 272

7.3.2.4 Configuring the I2S-Generator

- [OUTPut:AUDIobits](#) on page 859
- [OUTPut:BCLK:FREQuency?](#) on page 862
- [OUTPut:CHANnel](#) on page 857
- [OUTPut:FBIT](#) on page 862
- [OUTPut:FORMat](#) on page 862
- [OUTPut:FSHape](#) on page 862
- [OUTPut:MCLKratio](#) on page 862
- [OUTPut:POLarity](#) on page 862
- [OUTPut:SAMPle:FREQuency](#) on page 863
- [OUTPut:SAMPle:MODE](#) on page 859
- [OUTPut:WLENgth](#) on page 863
- [OUTPut:WOFFset](#) on page 863

- [SOURCE:SYNC:TO](#) on page 861

OUTPut:BCLK:FREQuency?**Return values:**

<argument> float

Usage: Query only

Manual operation: See "[BCLK Freq](#)" on page 264
See "[BCLK Freq](#)" on page 275

OUTPut:FBIT <fbit>**Parameters:**

<fbit> MSB | LSB

Manual operation: See "[First Bit](#)" on page 265
See "[First Bit](#)" on page 273

OUTPut:FORMat <format>**Parameters:**

<format> SI2S | USERdefined

Manual operation: See "[Format](#)" on page 264

OUTPut:FSHape <fshape>**Parameters:**

<fshape> SQUpuls | BITPulse

Manual operation: See "[Fsync Shape](#)" on page 265

OUTPut:MCLKratio <mclkratio>**Parameters:**

<mclkratio> | M16 | M32 | M64 | M96 | M128 | M192 | M256 | M384 | M512

Manual operation: See "[MCLK Ratio](#)" on page 264

OUTPut:POLarity <polarity>**Parameters:**

<polarity> LFTLow | NEGative | LFTHigh | POSitive

Manual operation: See "[Fsync Polarity](#)" on page 265

OUTPut:SAMPlE:FREQuency <frequency>**Parameters:**

<frequency> float

Manual operation: See ["Sample Frequency"](#) on page 255
See ["Sample Freq"](#) on page 263
See ["Sample Freq"](#) on page 274

OUTPut:WLENGth <wlength>**Parameters:**

<wlength> W16 | W24 | W32

Manual operation: See ["Word Length "](#) on page 263

OUTPut:WOffset <woffset>**Parameters:**

<woffset> integer

Manual operation: See ["Word Offset"](#) on page 266

7.3.2.5 Configuring the USI Dual-Generator

- [OUTPut:AUDiobits](#) on page 859
- [OUTPut:BCLK:FREQuency?](#) on page 862
- [OUTPut:BCLock:JITAmplitude](#) on page 864
- [OUTPut:BCLock:JITFrequency](#) on page 864
- [OUTPut:BSLope](#) on page 864
- [OUTPut:CLOCK](#) on page 864
- [OUTPut:CODing](#) on page 864
- [OUTPut:FBIT](#) on page 862
- [OUTPut:FOFFset](#) on page 865
- [OUTPut:FSLope](#) on page 865
- [OUTPut:FSYNc:FREQuency?](#) on page 865
- [OUTPut:FWIDth](#) on page 865
- [OUTPut:FWIDth:VALue](#) on page 865
- [OUTPut:LBITs](#) on page 865
- [OUTPut:LOGVoltage](#) on page 865
- [OUTPut:MCLock:JITAmplitude](#) on page 866
- [OUTPut:MCLock:JITFrequency](#) on page 866
- [OUTPut:MRATio](#) on page 866
- [OUTPut:MSAMplefrequency](#) on page 866

- [OUTPut:NOSlots](#) on page 866
- [OUTPut:RATio](#) on page 866
- [OUTPut:RESync](#) on page 866
- [OUTPut:SAMple:MODE](#) on page 859
- [OUTPut:SLCOffset](#) on page 867
- [OUTPut:SLCSlope](#) on page 867
- [OUTPut:SLCWidth](#) on page 867
- [OUTPut:SLCWidth:VALue](#) on page 867
- [OUTPut:SLTLength](#) on page 867
- [OUTPut:SPFRame](#) on page 867
- [OUTPut:TXData<n2>](#) on page 867
- [SOURce:SYNC:TO](#) on page 861

OUTPut:BCLock:JITAmplitude <jitamplitude>

Parameters:

<jitamplitude> float

Manual operation: See "[BClk Jitt Ampl](#)" on page 278

OUTPut:BCLock:JITFrequency <jitfrequency>

Parameters:

<jitfrequency> float

Manual operation: See "[BClk Jitt Freq](#)" on page 278

OUTPut:BSLope <bslope>

Parameters:

<bslope> RISING | FALLING

Manual operation: See "[BClk Slope](#)" on page 276

OUTPut:CLOCK <clock>

Parameters:

<clock> CONTinuous | GATed

Manual operation: See "[Clock](#)" on page 270

OUTPut:CODing <coding>

Parameters:

<coding> NONE | ALAW | ULAW

Manual operation: See "[Coding](#)" on page 279

OUTPut:FOFFset <foffset>**Parameters:**

<foffset> integer

Manual operation: See "[Fsync Offset](#)" on page 276

OUTPut:FSLope <fslope>**Parameters:**

<fslope> LFTFalling | LFTRising | FALLing | RISing

Manual operation: See "[Fsync Slope](#)" on page 276

OUTPut:FSYnc:FREQuency?**Return values:**

<argument> float

Usage: Query only**Manual operation:** See "[Fsync Freq](#)" on page 275

OUTPut:FWIDTH <fwidth>**Parameters:**

<fwidth> ONEBit | ONESlot | SQUare | VALue

Manual operation: See "[Fsync Width](#)" on page 275

OUTPut:FWIDTH:VALue <value>**Parameters:**

<value> integer

Manual operation: See "[Fsync Width](#)" on page 275

OUTPut:LBITs <lbits>**Parameters:**

<lbits> integer

Manual operation: See "[Lead Bits](#)" on page 273
See "[Lead Bits](#)" on page 419

OUTPut:LOGVoltage <logvoltage>**Parameters:**

<logvoltage> MV0900 | MV1200 | MV1500 | MV1800 | MV2500 | MV3300

Manual operation: See "[Logic Voltage](#)" on page 279

OUTPut:MClock:JITAmplitude <jitamplitude>**Parameters:**

<jitamplitude> float

Manual operation: See "[MCIk Jitt Ampl](#)" on page 278

OUTPut:MClock:JITFrequency <jitfrequency>**Parameters:**

<jitfrequency> float

Manual operation: See "[MCIk Jitt Freq](#)" on page 278

OUTPut:MRATio <mratio>**Parameters:**

<mratio> integer

Manual operation: See "[MCIk Ratio](#)" on page 277

OUTPut:MSAMplefrequency <msamplefrequency>**Parameters:**

<msamplefrequency> ON | OFF

Manual operation: See "[Mixed Sampfrq](#)" on page 270

OUTPut:NOSLots <noslots>**Parameters:**

<noslots> integer

Manual operation: See "[No of Slots](#)" on page 271

OUTPut:RATio <ratio>**Parameters:**

<ratio> integer

Manual operation: See "[Ratio](#)" on page 270

OUTPut:RESYnc <state>**Parameters:**

<state> ONCE | EXEC | OFF

Manual operation: See "[Resync](#)" on page 280

OUTPut:SLCOffset <slcoffset>**Parameters:**

<slcoffset> integer

Manual operation: See "[SIClk Offset](#)" on page 277

OUTPut:SLCSlope <slcslope>**Parameters:**

<slcslope> RISING | FALLING

Manual operation: See "[SIClk Slope](#)" on page 277

OUTPut:SLCWidth <slcwidth>**Parameters:**

<slcwidth> NEBit | ONESlot | SQUARE | VALUE

Manual operation: See "[SIClk Width](#)" on page 277

OUTPut:SLCWidth:VALue <value>**Parameters:**

<value> integer

OUTPut:SLTLength <sltlength>**Parameters:**

<sltlength> integer

Manual operation: See "[Slot Length](#)" on page 273

OUTPut:SPFrame <spframe>**Parameters:**

<spframe> integer

Manual operation: See "[Samples/Frame](#)" on page 271

OUTPut:TXData<n2> <txdata>**Parameters:**

<txdata> string

Manual operation: See "[TX_DATA1](#)" on page 271See "[TX_DATA3](#)" on page 271See "[TX_DATA4](#)" on page 271

7.3.3 Generator Signals

The generator signals are defined in the `SOURCE` subsystem. The type of generator signal is selected with command `SOURCE:FUNCTION`.

- `SOURCE:FUNCTION` on page 869

7.3.3.1 Sine

- `MMEMORY:LOAD:OEQUALize` on page 868
- `SOURCE:FILTER` on page 960
- `SOURCE:FREQUENCY<n2>` on page 868
- `SOURCE:FUNCTION` on page 869
- `SOURCE:LOWDistortion` on page 869
- `SOURCE:RANDOM:PDF` on page 869
- `SOURCE:SINusoid:DITHer` on page 869
- `SOURCE:SINusoid:DITHer:STATE` on page 870
- `SOURCE:VOLTage<n2>` on page 870
- `SOURCE:VOLTage:EQUalize` on page 870
- `SOURCE:VOLTage:OFFSet<n3>` on page 871
- `SOURCE:VOLTage:OFFSet<n3>:STATE` on page 871
- `SOURCE:VOLTage:SElect` on page 874

`MMEMORY:LOAD:OEQUALize` <oequalize>

Parameters:

<oequalize> string
 filename

Manual operation: See "Equalizer / Equalizer Ch1" on page 293
 See "Equalizer" on page 300
 See "Equalizer" on page 307
 See "Equalizer" on page 315
 See "Equal File" on page 340

`SOURCE:FREQUENCY<n2>` <frequency>

Suffix:

<n2> 1...32 (Multisine) / 1 | 2 (Mod Dist)
 The suffix selects the sine line for Multisine and Mod Dist generator signals.
 For multisine, the suffix selects one of the sinewave 1 to 32.
 For Mod Dist, suffix 1 or no suffix selects the upper frequency and suffix 2 the lower frequency.
 For all other generator signals, the suffix is irrelevant and must be omitted.

Parameters:

<frequency> float

Manual operation:

See ["Frequency"](#) on page 289
 See ["Frequency"](#) on page 291
 See ["Freq Ch1"](#) on page 292
 See ["Freq No i"](#) on page 295
 See ["Frequency"](#) on page 298
 See ["Frequency"](#) on page 301
 See ["Upper Freq"](#) on page 304
 See ["Lower Freq"](#) on page 304
 See ["Upper Freq"](#) on page 306
 See ["Frequency"](#) on page 331
 See ["Mod Freq"](#) on page 332
 See ["Carrier Freq"](#) on page 332
 See ["Frequency"](#) on page 335

SOURce:FUNctioN <function>**Parameters:**

<function> SINusoid | MULTisine | BURSt | | SQUare | S2Pulse | MDISt |
 DFD | DIM | RANDom | USER | ARBitrary | POLarity |
 MODulation | FM | O131 | PLYAnlr | STEReo | DC | PLAY |
 CHIRp

SOURce:LOWDistortion <lowdistortion>**Parameters:**

<lowdistortion> ON | OFF

Manual operation: See ["Low Dist"](#) on page 287

SOURce:RANDom:PDF <pdf>**Parameters:**

<pdf> GAUSSian | TRIangle | RECTangle

Manual operation:

See ["Dither"](#) on page 288
 See ["Dither"](#) on page 290
 See ["Dither"](#) on page 303
 See ["Dither"](#) on page 305
 See ["PDF"](#) on page 312

SOURce:SINusoid:DITHer <dither>**Parameters:**

<dither> float

Manual operation: See ["Dither"](#) on page 288
 See ["Dither"](#) on page 290
 See ["Dither"](#) on page 303
 See ["Dither"](#) on page 305

SOURce:SINusoid:DITHer:STATe <state>

Parameters:

<state> ON | OFF

Manual operation: See ["Dither"](#) on page 288
 See ["Dither"](#) on page 290
 See ["Dither"](#) on page 303
 See ["Dither"](#) on page 305

SOURce:VOLTage<n2> <voltage>

Suffix:

<n2> 1...32 (Multisine)
 The suffix selects one of the sinewave 1 to 32 for Multisine generator signals.
 For all other generator signals, the suffix is irrelevant and must be omitted.

Parameters:

<voltage> float

Manual operation: See ["Voltage"](#) on page 289
 See ["Volt Ch1"](#) on page 292
 See ["Volt No i"](#) on page 296
 See ["Voltage"](#) on page 298
 See ["Voltage"](#) on page 301
 See ["Volt Peak Ch1"](#) on page 322
 See ["Total RMS"](#) on page 331
 See ["Deviation / Mod Depth"](#) on page 332
 See ["Carrier Volt"](#) on page 333
 See ["Voltage"](#) on page 335

SOURce:VOLTage:EQUalize <equalize>

Parameters:

<equalize> integer

Manual operation: See ["Equalizer / Equalizer Ch1"](#) on page 293
 See ["Equalizer"](#) on page 300
 See ["Equalizer"](#) on page 307
 See ["Equalizer"](#) on page 315
 See ["Equalizer"](#) on page 340

SOURce:VOLTage:OFFSet<n3> <offset>**Suffix:**

<n3>

1|2

The suffix is only relevant for generator function "Stereo Sine". It selects the channel 1 or 2 for which the offset is entered. The suffix is irrelevant for all other generator functions and can be omitted.

Parameters:

<offset>

float

Manual operation:

See ["DC Offset"](#) on page 289
See ["Offset Ch1"](#) on page 294
See ["DC Offset"](#) on page 297
See ["DC Offset"](#) on page 300
See ["DC Offset"](#) on page 304
See ["DC Offset"](#) on page 307
See ["DC Offset"](#) on page 315
See ["DC Offset"](#) on page 317
See ["DC Offset"](#) on page 324
See ["DC Offset"](#) on page 330
See ["DC Offset"](#) on page 335
See ["DC Offset"](#) on page 338

SOURce:VOLTage:OFFSet<n3>:STATe <state>**Suffix:**

<n3>

1|2

The suffix is only relevant for generator function "Stereo Sine". It selects the channel 1 or 2 for which the offset is entered. The suffix is irrelevant for all other generator functions and can be omitted.

Parameters:

<state>

ON | OFF

Manual operation:

See ["DC Offset"](#) on page 289
See ["DC Offset"](#) on page 294
See ["Offset Ch2"](#) on page 294
See ["DC Offset"](#) on page 297
See ["DC Offset"](#) on page 300
See ["DC Offset"](#) on page 304
See ["DC Offset"](#) on page 307
See ["DC Offset"](#) on page 315
See ["DC Offset"](#) on page 317
See ["DC Offset"](#) on page 324
See ["DC Offset"](#) on page 330
See ["DC Offset"](#) on page 335
See ["DC Offset"](#) on page 338

7.3.3.2 Stereo Sine

- [MMEMory:LOAD:STEReo<n3>:OEQualize](#) on page 872
- [MMEMory:LOAD:OEQualize](#) on page 868
- [SOURce:FILTer:CHANnels](#) on page 872
- [SOURce:FREQuency<n2>](#) on page 868
- [SOURce:FREQuency:CH2Stereo](#) on page 873
- [SOURce:FREQuency:SElect](#) on page 873
- [SOURce:FUNCTion](#) on page 869
- [SOURce:PHASe<n2>](#) on page 873
- [SOURce:RANDom:PDF](#) on page 869
- [SOURce:SINusoid:DITHer](#) on page 869
- [SOURce:SINusoid:DITHer:STATe](#) on page 870
- [SOURce:STEReo<n2>:FILTer](#) on page 961
- [SOURce:VOLTage<n2>](#) on page 870
- [SOURce:VOLTage:CH2Stereo](#) on page 873
- [SOURce:VOLTage:EQUalize](#) on page 870
- [SOURce:VOLTage:EQUalize:CHANnels](#) on page 873
- [SOURce:VOLTage:OFFSet<n3>](#) on page 871
- [SOURce:VOLTage:OFFSet<n3>:CHANnels](#) on page 874
- [SOURce:VOLTage:OFFSet<n3>:STATe](#) on page 871
- [SOURce:VOLTage:RATio](#) on page 874
- [SOURce:VOLTage:SElect](#) on page 874
- [SOURce:VOLTage:STEReo<n3>:EQUalize](#) on page 874

MMEMory:LOAD:STEReo<n3>:OEQualize <oequalize>

Suffix:

<n3> 1 | 2
 Stereo channel 1 or 2

Parameters:

<oequalize> string

Manual operation: See "[Equalizer Ch2](#)" on page 293

SOURce:FILTer:CHANnels <channels>

Parameters:

<channels> TRACk | SPLit

Manual operation: See "[Filter](#)" on page 292
 See "[Filter](#) " on page 323

SOURce:FREQuency:CH2Stereo <ch2stereo>**Parameters:**

<ch2stereo> float

Manual operation: See "[Freq Ch2](#)" on page 292

SOURce:FREQuency:SElect <select>**Parameters:**

<select> FQPH | FQFQ

Manual operation: See "[Freq Mode](#)" on page 290

SOURce:PHASe<n2> <phase>**Suffix:**

<n2> 1...32

The suffix selects one of the sinewave 1 to 32 for Multisine generator signal.

For all other generator signals, the suffix is irrelevant and must be omitted.

Parameters:

<phase> float

Manual operation: See "[Phase Ch2/1](#)" on page 292
See "[Phase No i](#)" on page 296

SOURce:VOLTage:CH2Stereo <ch2stereo>**Parameters:**

<ch2stereo> float

Manual operation: See "[Volt Ch2](#)" on page 292
See "[Volt Peak Ch2](#)" on page 323

SOURce:VOLTage:EQualize:CHANnels <channels>**Parameters:**

<channels> TRACK | SPLit

Manual operation: See "[Equalizer](#)" on page 293

SOURce:VOLTage:OFFSet<n3>:CHANnels <channels>**Suffix:**

<n3> 1|2

The suffix is only relevant for generator function "Stereo Sine". It selects the channel 1 or 2 for which the offset is entered. The suffix is irrelevant for all other generator functions and can be omitted.

Parameters:

<channels> TRACK | SPLit

Manual operation: See ["DC Offset"](#) on page 294

SOURce:VOLTage:RATio <ratio>**Parameters:**

<ratio> float

Manual operation: See ["Volt Ch2/1"](#) on page 292
 See ["Volt LF:UF"](#) on page 304
 See ["Volt Ch2/1"](#) on page 323

SOURce:VOLTage:SElect <select>**Parameters:**

<select> VLRT | VLVL

Manual operation: See ["Volt Mode"](#) on page 291
 See ["Volt Mode"](#) on page 322

SOURce:VOLTage:STEReo<n3>:EQUalize <equalize>**Parameters:**

<equalize> integer | ON | OFF

Manual operation: See ["Equalizer Ch2"](#) on page 293

7.3.3.3 Multisine

- [MMEMy:LOAD:OEQualize](#) on page 868
- [SOURce:FILTer](#) on page 960
- [SOURce:FREQuency<n2>](#) on page 868
- [SOURce:FUNCTion](#) on page 869
- [SOURce:FUNCTion:MODE](#) on page 875
- [SOURce:MULTisine:COUNT](#) on page 875
- [SOURce:PHASe<n2>](#) on page 873
- [SOURce:RANDom:SPACing:FREQuency](#) on page 875

- [SOURce:RANDom:SPACing:MODE](#) on page 875
- [SOURce:VOLTage<n2>](#) on page 870
- [SOURce:VOLTage:CREStfactor:MODE](#) on page 875
- [SOURce:VOLTage:EQUalize](#) on page 870
- [SOURce:VOLTage:OFFSet<n3>](#) on page 871
- [SOURce:VOLTage:OFFSet<n3>:STATe](#) on page 871
- [SOURce:VOLTage:RMS](#) on page 876
- [SOURce:VOLTage:TOTAl](#) on page 876
- [SOURce:VOLTage:TOTAl:GAIN](#) on page 876

SOURce:FUNCTION:MODE <mode>

Parameters:

<mode> EQUalvoltage | DEFinedvoltage | IEC268 | IEC118 | FM | AM

Manual operation: See "[Voltage Mode](#)" on page 295
 See "[Mode](#)" on page 305
 See "[Mode](#)" on page 332

SOURce:MULTisine:COUNT <count>

Parameters:

<count> integer

Manual operation: See "[No of Sine](#)" on page 295

SOURce:RANDom:SPACing:FREQuency <frequency>

Parameters:

<frequency> float

Manual operation: See "[Spacing](#)" on page 295
 See "[Spacing](#)" on page 313

SOURce:RANDom:SPACing:MODE <mode>

Parameters:

<mode> ATRack | USERdefined

Manual operation: See "[Spacing](#)" on page 295
 See "[Spacing](#)" on page 313

SOURce:VOLTage:CREStfactor:MODE <mode>

Parameters:

<mode> MINimized | DPHase

Manual operation: See "[Crest Factor](#)" on page 295

SOURce:VOLTage:RMS <rms>**Parameters:**

<rms> float

Manual operation: See ["Total RMS"](#) on page 296
See ["Volt RMS"](#) on page 315
See ["Volt RMS"](#) on page 317
See ["Volt RMS"](#) on page 337

SOURce:VOLTage:TOTal <total>**Parameters:**

<total> float

Manual operation: See ["Total Peak"](#) on page 296
See ["Total Voltage"](#) on page 304
See ["Total Voltage"](#) on page 306
See ["Total Voltage"](#) on page 308
See ["Volt Peak"](#) on page 314
See ["Volt Peak"](#) on page 317
See ["Play Peak"](#) on page 330
See ["Total Peak"](#) on page 331
See ["Voltage"](#) on page 334
See ["Volt Peak"](#) on page 337

SOURce:VOLTage:TOTal:GAIN <gain>**Parameters:**

<gain> float

Manual operation: See ["Total Gain"](#) on page 296

7.3.3.4 Sine Burst

- [MMEMory:LOAD:OEQualize](#) on page 868
- [SOURce:FILTer](#) on page 960
- [SOURce:FREQuency<n2>](#) on page 868
- [SOURce:FUNCTion](#) on page 869
- [SOURce:INTerval](#) on page 877
- [SOURce:ONTime](#) on page 877
- [SOURce:ONTime:DELay](#) on page 877
- [SOURce:VOLTage<n2>](#) on page 870
- [SOURce:VOLTage:EQUalize](#) on page 870
- [SOURce:VOLTage:LOWLevel](#) on page 877
- [SOURce:VOLTage:OFFSet<n3>](#) on page 871

- [SOURce:VOLTage:OFFSet<n3>:STATe](#) on page 871

SOURce:INTerval <interval>

Parameters:

<interval> float

Manual operation: See ["Interval"](#) on page 299
 See ["Interval"](#) on page 301
 See ["Interval"](#) on page 338
 See ["Interval"](#) on page 339

SOURce:ONTime <ontime>

Parameters:

<ontime> float

Manual operation: See ["On Time"](#) on page 299
 See ["On Time"](#) on page 301
 See ["Sweep Time"](#) on page 337
 See ["On Time"](#) on page 339

SOURce:ONTime:DELay <delay>

Parameters:

<delay> float

Manual operation: See ["Burst on Delay"](#) on page 299
 See ["Burst on Delay"](#) on page 302
 See ["Burst on Delay"](#) on page 339

SOURce:VOLTage:LOWLevel <lowlevel>

Parameters:

<lowlevel> float

Manual operation: See ["Low Level"](#) on page 299

7.3.3.5 Sine2 Burst

- [SOURce:FILTer](#) on page 960
- [SOURce:FREQuency<n2>](#) on page 868
- [SOURce:FUNCTion](#) on page 869
- [SOURce:INTerval](#) on page 877
- [SOURce:ONTime:DELay](#) on page 877
- [SOURce:ONTime](#) on page 877
- [SOURce:VOLTage<n2>](#) on page 870

7.3.3.6 Mod Dist

- [SOURCE:FILTER](#) on page 960
- [SOURCE:FREQUENCY<n2>](#) on page 868
- [SOURCE:FUNCTION](#) on page 869
- [SOURCE:RANDOM:PDF](#) on page 869
- [SOURCE:SINUSOID:DITHER](#) on page 869
- [SOURCE:SINUSOID:DITHER:STATE](#) on page 870
- [SOURCE:VOLTAGE:OFFSET<n3>](#) on page 871
- [SOURCE:VOLTAGE:OFFSET<n3>:STATE](#) on page 871
- [SOURCE:VOLTAGE:RATIO](#) on page 874
- [SOURCE:VOLTAGE:TOTAL](#) on page 876

7.3.3.7 DFD

- [MMEMORY:LOAD:OEQUALIZE](#) on page 868
- [SOURCE:FILTER](#) on page 960
- [SOURCE:FREQUENCY<n2>](#) on page 868
- [SOURCE:FREQUENCY:DIFFERENCE](#) on page 878
- [SOURCE:FREQUENCY:MEAN](#) on page 878
- [SOURCE:FUNCTION](#) on page 869
- [SOURCE:FUNCTION:MODE](#) on page 875
- [SOURCE:RANDOM:PDF](#) on page 869
- [SOURCE:SINUSOID:DITHER](#) on page 869
- [SOURCE:SINUSOID:DITHER:STATE](#) on page 870
- [SOURCE:VOLTAGE:EQUALIZE](#) on page 870
- [SOURCE:VOLTAGE:OFFSET<n3>](#) on page 871
- [SOURCE:VOLTAGE:TOTAL](#) on page 876

SOURCE:FREQUENCY:DIFFERENCE <difference>

Parameters:

<difference> float

Manual operation: See "[Diff Freq](#)" on page 306

SOURCE:FREQUENCY:MEAN <mean>

Parameters:

<mean> float

Manual operation: See "[Mean Freq](#)" on page 306
 See "[Mean Freq](#)" on page 314

7.3.3.8 DIM

- [SOURCE: BANDwidth](#) on page 879
- [SOURCE: DIM](#) on page 879
- [SOURCE: FUNCTION](#) on page 869
- [SOURCE: VOLTage: TOTal](#) on page 876

SOURCE: BANDwidth <bandwidth>

Parameters:

<bandwidth> F30 | F100

Manual operation: See "[Bandwidth](#)" on page 308

SOURCE: DIM <dim>

Parameters:

<dim> DIMA | DIMB | DIMS

DIMA = '2.96/14'

DIMB = '3.15/15'

DIMS = '2.96/8'

Manual operation: See "[Square Sine](#)" on page 308

7.3.3.9 Random

- [MMEMemory: LOAD: ARBItrary](#) on page 880
- [MMEMemory: LOAD: OEQualize](#) on page 868
- [SOURCE: FILTER](#) on page 960
- [SOURCE: FREQuency: MEAN](#) on page 878
- [SOURCE: FUNCTION](#) on page 869
- [SOURCE: RANDom: DOMain](#) on page 880
- [SOURCE: RANDom: FREQuency: LOWer](#) on page 880
- [SOURCE: RANDom: FREQuency: UPPer](#) on page 880
- [SOURCE: RANDom: PDF](#) on page 869
- [SOURCE: RANDom: SHAPe](#) on page 880
- [SOURCE: RANDom: SPACing: FREQuency](#) on page 875
- [SOURCE: RANDom: SPACing: MODE](#) on page 875
- [SOURCE: VOLTage: EQUalize](#) on page 870
- [SOURCE: VOLTage: OFFSet<n3>](#) on page 871
- [SOURCE: VOLTage: OFFSet<n3>: STATe](#) on page 871
- [SOURCE: VOLTage: RMS](#) on page 876
- [SOURCE: VOLTage: TOTal](#) on page 876

SOURce:RANDom:DOMain <domain>**Parameters:**

<domain> FREQuency | TIME

Manual operation: See "Domain" on page 309
 See "Domain" on page 334

SOURce:RANDom:FREQuency:LOWer <lower>**Parameters:**

<lower> float

Manual operation: See "Lower Freq" on page 314

SOURce:RANDom:FREQuency:UPPer <upper>**Parameters:**

<upper> float

Manual operation: See "Upper Freq" on page 314

SOURce:RANDom:SHAPE <shape>**Parameters:**

<shape> FILE | WHITE | PINK | TOCTave

Manual operation: See "Shape" on page 311

7.3.3.10 Arbitrary

- [MMEMory:LOAD:ARBitrary](#) on page 880
- [SOURce:FILTer](#) on page 960
- [SOURce:FUNCTion](#) on page 869
- [SOURce:VOLTage:OFFSet<n3>](#) on page 871
- [SOURce:VOLTage:OFFSet<n3>:STATe](#) on page 871
- [SOURce:VOLTage:RMS](#) on page 876
- [SOURce:VOLTage:TOTal](#) on page 876

MMEMory:LOAD:ARBitrary <arbitrary>**Parameters:**

<arbitrary> string

Manual operation: See "File" on page 316
 See "File" on page 318
 See "File" on page 325

7.3.3.11 Play

Playing waveforms requires option R&S UPV-B6.

- [MMEMory:LOAD:ARBitrary](#) on page 880
- [SOURce:FILTer](#) on page 960
- [SOURce:FILTer:CHANnels](#) on page 872
- [SOURce:FUNCTion](#) on page 869
- [SOURce:PLAY:CHANnel](#) on page 881
- [SOURce:PLAY:DELay<n3>](#) on page 881
- [SOURce:PLAY:MODE](#) on page 881
- [SOURce:PLAY:MUTing](#) on page 882
- [SOURce:PLAY:REStart](#) on page 882
- [SOURce:PLAY:SCALEpktofs](#) on page 882
- [SOURce:PLAY:TIME](#) on page 882
- [SOURce:VOLTage:OFFSet<n3>](#) on page 871
- [SOURce:VOLTage:OFFSet<n3>:STATe](#) on page 871
- [SOURce:VOLTage:TOTal](#) on page 876

SOURce:PLAY:CHANnel <channel>

Parameters:

<channel> MLEft | MRIGht | STEReo

Manual operation: See "[Channel](#)" on page 319
See "[Channel](#)" on page 326

SOURce:PLAY:DELay<n3> <delay>

Parameters:

<delay> float

Manual operation: See "[Delay Ch1, Delay Ch2](#)" on page 320
See "[Delay Ch1, Delay Ch2](#)" on page 326

SOURce:PLAY:MODE <mode>

Parameters:

<mode> TOCont | TOSingle | TICont | TISingle

Manual operation: See "[Play Mode](#)" on page 321
See "[Play Mode](#)" on page 328
See "[Play Mode](#)" on page 337

SOURce:PLAY:MUTing <muting>**Parameters:**

<muting> OFF | AFTermeas

Manual operation: See "Muting" on page 313
 See "Muting" on page 320
 See "Muting" on page 327

SOURce:PLAY:REStart <state>**Parameters:**

<state> OFF | AUTO | ONCE

Manual operation: See "Restart" on page 321
 See "Restart" on page 327

SOURce:PLAY:SCALepktofs <scalepktofs>**Parameters:**

<scalepktofs> ON | OFF

Manual operation: See "Scale Pk to FS" on page 319

SOURce:PLAY:TIME <time>**Parameters:**

<time> float

Manual operation: See "Time" on page 322
 See "Time" on page 328

7.3.3.12 Play and Anlr

- [MMEMory:LOAD:ARBitrary](#) on page 880
- [SOURce:FILTer](#) on page 960
- [SOURce:FUNction](#) on page 869
- [SOURce:LOOP:CHANnel](#) on page 883
- [SOURce:LOOP:GAIN](#) on page 883
- [SOURce:PLAY:CHANnel](#) on page 881
- [SOURce:PLAY:MODE](#) on page 881
- [SOURce:PLAY:MUTing](#) on page 882
- [SOURce:PLAY:TIME](#) on page 882
- [SOURce:VOLTage:OFFSet<n3>](#) on page 871
- [SOURce:VOLTage:OFFSet<n3>:STATe](#) on page 871
- [SOURce:VOLTage:TOTal](#) on page 876

SOURce:LOOP:CHANnel <channel>**Parameters:**

<channel> OFF | CH1 | CH2 | STEReo | CROSSed

Manual operation: See "[Loop Channel](#)" on page 329

SOURce:LOOP:GAIN <gain>**Parameters:**

<gain> float

Manual operation: See "[Loop Gain](#)" on page 329**7.3.3.13 Polarity**

- [SOURce:FREQuency<n2>](#) on page 868
- [SOURce:FUNCTion](#) on page 869
- [SOURce:VOLTage<n2>](#) on page 870
- [SOURce:VOLTage:TOTal](#) on page 876

7.3.3.14 Modulation

- [SOURce:FILTer](#) on page 960
- [SOURce:FREQuency<n2>](#) on page 868
- [SOURce:FUNCTion](#) on page 869
- [SOURce:VOLTage<n2>](#) on page 870

7.3.3.15 DC (Direct Current Voltage)

- [SOURce:FUNCTion](#) on page 869
- [SOURce:VOLTage:TOTal](#) on page 876

7.3.3.16 Square

- [SOURce:FREQuency<n2>](#) on page 868
- [SOURce:FUNCTion](#) on page 869
- [SOURce:RANDom:DOMain](#) on page 880
- [SOURce:VOLTage<n2>](#) on page 870
- [SOURce:VOLTage:OFFSet<n3>](#) on page 871
- [SOURce:VOLTage:OFFSet<n3>:STATe](#) on page 871

7.3.4 Amplitude Variation

- [SOURCE:AM:MODE](#) on page 884
- [SOURCE:FREQUENCY:AM](#) on page 884
- [SOURCE:INTERVAL](#) on page 877
- [SOURCE:ONTIME](#) on page 877
- [SOURCE:ONTIME:DELAY](#) on page 877
- [SOURCE:VOLTAGE:AM](#) on page 884

SOURCE:AM:MODE <mode>

Parameters:

<mode> OFF | SINusoid | BURSt

Manual operation: See "[Amp Var](#)" on page 338

SOURCE:FREQUENCY:AM <am>

Parameters:

<am> float

Manual operation: See "[Modulation Frequency](#)" on page 339

SOURCE:VOLTAGE:AM <am>

Parameters:

<am> float

Manual operation: See "[Variation](#)" on page 339

7.3.5 Digital Audio Protocol Generator

The Digital Audio Protocol Generator requires option R&S UPV-K21.

The Digital Audio Protocol Generator requires option R&S UPV-K21 (Digital audio protocol)..

- [SOURCE:PROTOCOL:AZERO](#) on page 885
- [SOURCE:PROTOCOL:CHANNELS](#) on page 885
- [SOURCE:PROTOCOL:CH<n3>:BYTE<n4>](#) on page 885
- [SOURCE:PROTOCOL:CRC](#) on page 885
- [SOURCE:PROTOCOL:FILE](#) on page 885
- [SOURCE:PROTOCOL:MODE](#) on page 886
- [SOURCE:PROTOCOL:NUMERICAL:BYTE](#) on page 886
- [SOURCE:PROTOCOL:NUMERICAL:CH](#) on page 886
- [SOURCE:PROTOCOL:NUMERICAL:VALUE](#) on page 886

- [SOURCE:PROTOCOL:VALIDITY](#) on page 886

SOURCE:PROTOCOL:AZERO <state>
Parameters:

<state> ONCE | EXEC

Manual operation: See "[All Bits = Zero](#)" on page 342

SOURCE:PROTOCOL:CH<n3>:BYTE<n4> <byte>

This command combines the following three commands in one :

- [SOURCE:PROTOCOL:NUMERICAL:BYTE](#) on page 886
- [SOURCE:PROTOCOL:NUMERICAL:CH](#) on page 886
- [SOURCE:PROTOCOL:NUMERICAL:VALUE](#) on page 886

Suffix:

<n3> channel 1 or 2

<n4> byte 0 to 3

Parameters:

<byte> 0 to 255
 decimal bit equivalent

Example:

SOUR:PROT:CH:BYTE2 31

Sets the protocol data of byte 2 (the third byte) of channel 1 to 31 = 1Fh = 00011111b .

Manual operation: See "[Channel](#)" on page 343
 See "[Byte Number](#)" on page 343
 See "[Value](#) " on page 343

SOURCE:PROTOCOL:CHANNELS <channels>
Parameters:

<channels> CH2Is1 | SPLit

Manual operation: See "[Channels](#)" on page 345

SOURCE:PROTOCOL:CRC <crc>
Parameters:

<crc> ON | OFF

Manual operation: See "[CRC](#)" on page 342

SOURCE:PROTOCOL:FILE <file>
Parameters:

<file> <file name>

Manual operation: See ["Channel Status File"](#) on page 342

SOURce:PROTOcol:MODE <mode>

Parameters:

<mode> AUTomatic | AUTOMATIC | CONSUMER | PROFESSIONAL | FILE

Manual operation: See ["Coding Mode"](#) on page 341

SOURce:PROTOcol:NUMerical:BYTE <byte>

Parameters:

<byte> integer

Manual operation: See ["Byte Number"](#) on page 343

SOURce:PROTOcol:NUMerical:CH <ch>

Parameters:

<ch> integer

Manual operation: See ["Channel"](#) on page 343

SOURce:PROTOcol:NUMerical:VALue <value>

Parameters:

<value> integer

Manual operation: See ["Value "](#) on page 343

SOURce:PROTOcol:VALidity <validity>

Parameters:

<validity> NONE | CH1And2

Manual operation: See ["Validity"](#) on page 342

7.3.6 Sweeps

The `SOURce:SWEeps:...` commands set the sweeps. List sweeps are loaded with commands of the `MMEMemory-Subsystem`.

- [MMEMemory:LOAD:DWELL](#) on page 888
- [MMEMemory:LOAD:FREQuency](#) on page 888
- [MMEMemory:LOAD:INTerval](#) on page 888
- [MMEMemory:LOAD:ONTime](#) on page 888
- [MMEMemory:LOAD:PHASe](#) on page 888
- [MMEMemory:LOAD:VOLTage](#) on page 888

- [SOURCE:SWEEP:CONTROL](#) on page 888
- [SOURCE:SWEEP:DWELL](#) on page 888
- [SOURCE:SWEEP:FREQUENCY:HALT](#) on page 888
- [SOURCE:SWEEP:FREQUENCY:HALT:VALUE](#) on page 889
- [SOURCE:SWEEP:FREQUENCY:POINTS](#) on page 889
- [SOURCE:SWEEP:FREQUENCY:SPACING](#) on page 889
- [SOURCE:SWEEP:FREQUENCY:START](#) on page 889
- [SOURCE:SWEEP:FREQUENCY:STEP](#) on page 890
- [SOURCE:SWEEP:FREQUENCY:STOP](#) on page 890
- [SOURCE:SWEEP:INTERVAL:HALT](#) on page 888
- [SOURCE:SWEEP:INTERVAL:HALT:VALUE](#) on page 889
- [SOURCE:SWEEP:INTERVAL:POINTS](#) on page 889
- [SOURCE:SWEEP:INTERVAL:SPACING](#) on page 889
- [SOURCE:SWEEP:INTERVAL:START](#) on page 889
- [SOURCE:SWEEP:INTERVAL:STEP](#) on page 890
- [SOURCE:SWEEP:INTERVAL:STOP](#) on page 890
- [SOURCE:SWEEP:NEXTSTEP](#) on page 888
- [SOURCE:SWEEP:ONTIME:HALT](#) on page 889
- [SOURCE:SWEEP:ONTIME:HALT:VALUE](#) on page 889
- [SOURCE:SWEEP:ONTIME:POINTS](#) on page 889
- [SOURCE:SWEEP:ONTIME:SPACING](#) on page 889
- [SOURCE:SWEEP:ONTIME:START](#) on page 889
- [SOURCE:SWEEP:ONTIME:STEP](#) on page 890
- [SOURCE:SWEEP:ONTIME:STOP](#) on page 890
- [SOURCE:SWEEP:PHASE:HALT](#) on page 889
- [SOURCE:SWEEP:PHASE:HALT:VALUE](#) on page 889
- [SOURCE:SWEEP:PHASE:POINTS](#) on page 889
- [SOURCE:SWEEP:PHASE:SPACING](#) on page 889
- [SOURCE:SWEEP:PHASE:START](#) on page 889
- [SOURCE:SWEEP:PHASE:STEP](#) on page 890
- [SOURCE:SWEEP:PHASE:STOP](#) on page 890
- [SOURCE:SWEEP:VOLTAGE:HALT](#) on page 889
- [SOURCE:SWEEP:VOLTAGE:HALT:VALUE](#) on page 889
- [SOURCE:SWEEP:VOLTAGE:POINTS](#) on page 889
- [SOURCE:SWEEP:VOLTAGE:SPACING](#) on page 889
- [SOURCE:SWEEP:VOLTAGE:START](#) on page 889
- [SOURCE:SWEEP:VOLTAGE:STEP](#) on page 890
- [SOURCE:SWEEP:VOLTAGE:STOP](#) on page 890

- [SOURce:SWEep:XAXis](#) on page 890
- [SOURce:SWEep:ZAXis](#) on page 890

MMEMory:LOAD:DWELI <dwelI>
Parameters:

<dwelI> string

Manual operation: See "[Next Step](#)" on page 353

MMEMory:LOAD:FREQuency <frequency>

MMEMory:LOAD:INTerval <interval>

MMEMory:LOAD:ONTime <ontime>

MMEMory:LOAD:PHASe <phase>

MMEMory:LOAD:VOLTage <voltage>
Parameters:

<voltage> string

Manual operation: See "[Tot Volt File, Volt File](#)" on page 358

SOURce:SWEep:CONTrol <control>
Parameters:

<control> OFF | ASWep | ALISt

Manual operation: See "[Sweep Ctrl](#)" on page 301
 See "[Sweep Ctrl](#)" on page 303
 See "[Sweep Ctrl](#)" on page 306
 See "[Sweep Ctrl](#)" on page 308
 See "[Sweep Ctrl](#)" on page 333
 See "[Sweep Ctrl](#)" on page 335
 See "[Sweep Ctrl](#)" on page 348

SOURce:SWEep:DWELI <dwelI>
Parameters:

<dwelI> float

Manual operation: See "[Next Step](#)" on page 353

SOURce:SWEep:NEXTstep <nextstep>
Parameters:

<nextstep> DWELI | ASYNc | LIST

Manual operation: See "[Next Step](#)" on page 353

SOURce:SWEep:FREQuency:HALT <halt>

SOURce:SWEep:INTerval:HALT <halt>

SOURce:SWEep:ONTime:HALT <halt>
SOURce:SWEep:PHASe:HALT <halt>
SOURce:SWEep:VOLTage:HALT <halt>

Parameters:

<halt> VALue | MUTE

Manual operation: See "[Halt](#)" on page 359

SOURce:SWEep:FREQUency:HALT:VALue <value>
SOURce:SWEep:INTerval:HALT:VALue <value>
SOURce:SWEep:ONTime:HALT:VALue <value>
SOURce:SWEep:PHASe:HALT:VALue <value>
SOURce:SWEep:VOLTage:HALT:VALue <value>

Parameters:

<value> float

Manual operation: See "[Halt value](#)" on page 360

SOURce:SWEep:FREQUency:POINts <points>
SOURce:SWEep:INTerval:POINts <points>
SOURce:SWEep:ONTime:POINts <points>
SOURce:SWEep:PHASe:POINts <points>
SOURce:SWEep:VOLTage:POINts <points>

Parameters:

<points> integer

Manual operation: See "[Points](#)" on page 356

SOURce:SWEep:FREQUency:SPACing <spacing>
SOURce:SWEep:INTerval:SPACing <spacing>
SOURce:SWEep:ONTime:SPACing <spacing>
SOURce:SWEep:PHASe:SPACing <spacing>
SOURce:SWEep:VOLTage:SPACing <spacing>

Parameters:

<spacing> LINSteps | LOGSteps | LINPoints | LOGPoints

Manual operation: See "[Spacing](#)" on page 355

SOURce:SWEep:FREQUency:STARt <start>
SOURce:SWEep:INTerval:STARt <start>
SOURce:SWEep:ONTime:STARt <start>
SOURce:SWEep:PHASe:STARt <start>
SOURce:SWEep:VOLTage:STARt <start>

Parameters:

<start> float

Manual operation: See "[Start](#)" on page 356

SOURce:SWEep:FREQuency:STEP <step>

SOURce:SWEep:INTerval:STEP <step>

SOURce:SWEep:ONTime:STEP <step>

SOURce:SWEep:PHASe:STEP <step>

SOURce:SWEep:VOLTage:STEP <step>

Parameters:

<step> float

Manual operation: See "[Step](#)" on page 357

SOURce:SWEep:FREQuency:STOP <stop>

SOURce:SWEep:INTerval:STOP <stop>

SOURce:SWEep:ONTime:STOP <stop>

SOURce:SWEep:PHASe:STOP <stop>

SOURce:SWEep:VOLTage:STOP <stop>

Parameters:

<stop> float

Manual operation: See "[Stop](#)" on page 356

SOURce:SWEep:XAXis <state>

Parameters:

<state> FREQuency | VOLTage | PHASe | | ONTime | INTerval |
INTervall

Manual operation: See "[X-axis](#)" on page 350

SOURce:SWEep:ZAXis <state>

Parameters:

<state> OFF | FREQuency | VOLTage | PHASe | | ONTime | INTerval |
INTervall

Manual operation: See "[Z-axis](#)" on page 351

7.3.7 Rapid Deactivation of Outputs

The outputs of the Audio Analyzer can be switched off in case of malfunction.

OUTPut <output>

Parameters:

<output> ON | OFF

7.4 Analyzer Settings

The commands for selecting and setting the analyzer are described in the following sequence:

1. Selection of Analyzer
2. Setting the various analyzer types

How to start and configure are measurement is described in the following chapters.



For rapid deactivation of outputs see [chapter 7.3.7, "Rapid Deactivation of Outputs"](#), on page 890

7.4.1 Selecting the Analyzer

The analyzer is selected with the `INSTRument` command.

INSTRument<n1> <analyzer_type>

This command selects the generator or analyzer. The active selection is determined by suffix <n1> at `INSTRument`.

Suffix:

<n1> 1 | 2

Suffix 1 (or no suffix) at `INSTRument` defines that selection of the generator is active, see [chapter 7.3.1, "Selecting the Generator"](#), on page 855.

Suffix 2 at `INSTRument` defines that selection of the analyzer is active,

Parameters:

<analyzer_type> A8CHannel | ANLG | DIG | I2SBoard | A16Channel |
U2CHannel | U8CHannel | DIGBitstream

Manual operation: See "[Instrument](#)" on page 364

7.4.2 Configuring the Analog Analyzer

The settings for the analog analyzer are performed in the `INPut` and `SENSE` subsystems.

- [INPut<n1>:BANDwidth:MODE](#) on page 893
- [INPut<n1>:CHANnel](#) on page 895
- [INPut<n1>:COMMon](#) on page 892
- [INPut<n1>:COUPling](#) on page 893
- [INPut<n1>:FILTer](#) on page 958
- [INPut<n1>:IMPedance](#) on page 892

- [INPut<n1>:TYPE](#) on page 896
- [SENSe<n1>:MAX:FFT:SIZE](#) on page 894
- [SENSe<n1>:POWer:REFeRence:RESistance](#) on page 894
- [SENSe<n1>:VOLTage:RANGe<n3>:MODE](#) on page 894
- [SENSe:VOLTage:RANGe<n3>:VALue](#) on page 895
- [TRIGger:DELAy](#) on page 909
- [TRIGger:PLAYbefmeas](#) on page 892
- [TRIGger:SOURce](#) on page 910

INPut<n1>:COMMOn <common>

Suffix:

<n1> 1 | 2

Parameters:

<common> FLOat | GROund

Manual operation: See "[Ch1 Common \(Ch2 Common\)](#)" on page 371

INPut<n1>:IMPedance <impedance>

Suffix:

<n1> 1 | 2

Parameters:

<impedance> selection | R300 | R600 | R200

Manual operation: See "[Chx Imped](#)" on page 370

TRIGger:PLAYbefmeas <playbefmeas>

Parameters:

<playbefmeas> ON | OFF

Manual operation: See "[Play bef. Meas](#)" on page 374

7.4.3 Configuring the Analog Multi Channel Analyzer

The settings for the analog Multi Channel Analyzer are performed in the `INPut`, `SENSe` and `TRIGger` subsystems.

- [INPut<n1>:BANDwidth:MODE](#) on page 893
- [INPut<n1>:COUPling](#) on page 893
- [INPut<n1>:COUPling:CHANnels](#) on page 893
- [INPut<n1>:FILTer](#) on page 958
- [INPut<n1>:MCHannels<n2>](#) on page 893
- [INPut<n1>:RANGe:CHANnels](#) on page 893

- [SENSe<n1>:MAX:FFT:SIZE](#) on page 894
- [SENSe<n1>:POWer:REFeRence:RESistance](#) on page 894
- [SENSe<n1>:REFeRence<n2>:CHANnel](#) on page 894
- [SENSe<n1>:VOLTage:RANGe<n3>:MODE](#) on page 894
- [SENSe:VOLTage:RANGe<n3>:VALue](#) on page 895
- [TRIGger:CHANnel](#) on page 909
- [TRIGger:SOURce](#) on page 910
- [TRIGger:DELay](#) on page 909

INPut<n1>:BANDwidth:MODE <mode>

Parameters:

<mode> B22 | B40 | B80 | | B250

Manual operation: See "[Bandwidth](#)" on page 367
 See "[Bandwidth](#)" on page 391

INPut<n1>:COUPling <coupling>

Suffix:

<n1> 1 to 16 : channel 1 to 16

Parameters:

<coupling> AC | DC

Manual operation: See "[Coupling](#)" on page 367
 See "[Chx Coupling](#)" on page 379

INPut<n1>:COUPling:CHANnels <channels>

Parameters:

<channels> TRACk | SPLit

Manual operation: See "[AC/DC Coupling](#)" on page 379

INPut<n1>:MCHannels<n2> <mchannels>

Parameters:

<mchannels> ON | OFF

Manual operation: See "[Meas Channels](#)" on page 378
 See "[Meas Channels](#)" on page 400
 See "[Meas Channels](#)" on page 415
 See "[Meas Channels](#)" on page 429

INPut<n1>:RANGe:CHANnels <channels>

Parameters:

<channels> TRACk | SPLit

Manual operation: See ["Range"](#) on page 380

SENSe<n1>:MAX:FFT:SIZE <size>

Parameters:

<size> S512 | S1K | S2K | S4K | S8K | S16K | S32K | S64K | S128K | S256K

Manual operation: See ["Max FFT Size"](#) on page 374
 See ["Max FFT Size"](#) on page 384
 See ["Max FFT Size"](#) on page 392
 See ["Max FFT Size"](#) on page 396
 See ["Max FFT Size"](#) on page 411
 See ["Max FFT Size"](#) on page 426
 See ["Max FFT Size"](#) on page 434

SENSe<n1>:POWer:REFerence:RESistance <resistance>

Parameters:

<resistance> float

Manual operation: See ["Ref Imped"](#) on page 373
 See ["Ref Imped"](#) on page 382

SENSe<n1>:REFerence<n2>:CHANnel <channel>

Parameters:

<channel> OFF | CH1 | CH2 | CH3 | CH4 | CH5 | CH6 | CH7 | CH8 | CH9 | CH10 | CH11 | CH12 | CH13 | CH14 | CH15 | CH16

Manual operation: See ["Ref Channel"](#) on page 382
 See ["Ref Channel"](#) on page 424
 See ["Ref Channel"](#) on page 433
 See ["Ref Channel"](#) on page 445

SENSe<n1>:VOLTage:RANGe<n3>:MODE <mode>

Suffix:

<n3> 1 to 8
 <n3> = 1 for setting INPut:MIMPedance:CHANnels TRACK.
 <n3> = 1 to 8 for setting INPut:MIMPedance:CHANnels SPLit. It denotes channel 1 to 8.

Parameters:

<mode> AUTO | FIXed | LOWer

Manual operation: See ["Chx Range"](#) on page 372
 See ["Chx Range"](#) on page 381

SENSe:VOLTage:RANGe<n3>:VALue <value>

Suffix:

<n3> 1 to 8
 <n3> = 1 for setting `INPut:MIMPedance:CHANnels TRACK`.
 <n3> = 1 to 8 for setting `INPut:MIMPedance:CHANnels SPLit`. It denotes channel 1 to 8.

Parameters:

<value> float

Manual operation: See ["Chx Range"](#) on page 372

See ["Chx Range"](#) on page 381

7.4.4 Configuring the Digital Analyzer

The settings for the digital analyzer are performed in the `INPut` and `SENSe` subsystems.

- [INPut<n1>:AUDiobits](#) on page 895
- [INPut<n1>:BANDwidth:MODE](#) on page 893
- [INPut<n1>:CHANnel](#) on page 895
- [INPut<n1>:FILTer](#) on page 958
- [INPut<n1>:SAMPle:FREQuency](#) on page 896
- [INPut<n1>:SAMPle:FREQuency:MODE](#) on page 896
- [INPut<n1>:TYPE](#) on page 896
- [SENSe<n1>:MAX:FFT:SIZE](#) on page 894
- [SENSe<n1>:DMODE](#) on page 896
- [SENSe<n1>:JITTer:REFerence](#) on page 896

INPut<n1>:AUDiobits <audiobits>

Parameters:

<audiobits> integer

Manual operation: See ["Audio Bits"](#) on page 388

See ["Audio Bits "](#) on page 394

See ["Audio Bits"](#) on page 405

See ["Audio Bits"](#) on page 419

See ["Audio Bits"](#) on page 431

INPut<n1>:CHANnel <channel>

Parameters:

<channel> selection | CH1 | CH2 | CH1And2 | CH1Is2 | CH2Is1 | BOTH

Manual operation: See ["Channel"](#) on page 366
 See ["Channel"](#) on page 388
 See ["Channel"](#) on page 393

INPut<n1>:SAMPlE:FREQUency <frequency>

Parameters:

<frequency> float

Manual operation: See ["Sample Freq"](#) on page 389
 See ["Sample Freq"](#) on page 394
 See ["Sample Freq"](#) on page 431

INPut<n1>:SAMPlE:FREQUency:MODE <mode>

Parameters:

<mode> selection | F32 | F44 | F48 | F88 | F96 | F176 | F192 | VALue |
 CHStatus | F08 | F11 | F16 | F22 | F384 | AUTO

Manual operation: See ["Sample Freq"](#) on page 389
 See ["Sample Freq"](#) on page 394
 See ["Sample Freq"](#) on page 406
 See ["Sample Freq"](#) on page 420

INPut<n1>:TYPE <type>

Suffix:

<n1> 1 | 2

Parameters:

<type> selection | BALanced | UNBalanced | GEN1 | GEN2 |
 DBALanced | AESebu | DUNBalanced | SPDif | OPTical | INTern

Manual operation: See ["Chx Input"](#) on page 368
 See ["Input"](#) on page 391

SENSe<n1>:DMODE <dmode>

Parameters:

<dmode> ADATa | JPHase | CINPut

Manual operation: See ["Meas Mode"](#) on page 385

SENSe<n1>:JITTer:REFerence <reference>

Parameters:

<reference> GCLock | INTClock | PLLVari | REFPII

Manual operation: See ["Jitter Ref"](#) on page 389

7.4.5 Configuring the I²S Analyzer

The settings for the I²S analyzer are performed in the `INPut` and `SENSe` subsystems.

- `INPut<n1>:AUDiobits` on page 895
- `INPut<n1>:BCLK:FREQuency?` on page 897
- `INPut<n1>:CHANnel` on page 895
- `INPut<n1>:FORMat` on page 897
- `INPut<n1>:FSLope` on page 897
- `INPut<n1>:INPut` on page 897
- `INPut<n1>:SAMPle:FREQuency` on page 896
- `INPut<n1>:SAMPle:FREQuency:MODE` on page 896
- `INPut<n1>:WLENGth` on page 898
- `INPut<n1>:WOFFset` on page 898
- `SENSe<n1>:MAX:FFT:SIZE` on page 894

`INPut<n1>:BCLK:FREQuency?`

Return values:

<argument> integer

Usage: Query only

Manual operation: See "[BCLK Freq](#)" on page 395
 See "[BCLK Freq](#)" on page 407
 See "[BCLK Freq](#)" on page 421

`INPut<n1>:FORMat <format>`

Parameters:

<format> SI2S | USERdefined

Manual operation: See "[Format](#)" on page 395

`INPut<n1>:FSLope <fslope>`

Parameters:

<fslope> LFTFalling | LFTRising | FALLing | RISing

Manual operation: See "[Fsync Slope](#)" on page 395
 See "[Fsync Slope](#)" on page 408
 See "[Fsync Slope](#)" on page 422

`INPut<n1>:INPut <input>`

Parameters:

<input> INTern | DSUB | PROBe

Manual operation: See ["Input"](#) on page 395
 See ["Input"](#) on page 407
 See ["Input"](#) on page 421

INPut<n1>:WLEnGth <wlength>

Parameters:

<wlength> W16 | W24 | W32

Manual operation: See ["Word Length "](#) on page 393

INPut<n1>:WOffset <woffset>

Parameters:

<woffset> integer

Manual operation: See ["Word Offset"](#) on page 396

7.4.6 Configuring the USI Dual/Eight Channel Analyzer

The settings for the USI Dual Channel and USI 8 Channel analyzer are performed in the `INPut` subsystem. The USI 8 Channel analyzer in addition uses commands from the `SENSe` and `TRIGger` subsystems.

- [INPut<n1>:AUDiobits](#) on page 895
- [INPut<n1>:BCLK:FREQuency?](#) on page 897
- [INPut<n1>:BSLope](#) on page 899
- [INPut<n1>:CLOCK](#) on page 899
- [INPut<n1>:CODing](#) on page 899
- [INPut<n1>:FBIT](#) on page 899
- [INPut<n1>:FILTer](#) on page 958
- [INPut<n1>:FOFFset](#) on page 900
- [INPut<n1>:FSLope](#) on page 897
- [INPut<n1>:FSYNc:FREQuency?](#) on page 900
- [INPut<n1>:FWIDth](#) on page 900
- [INPut<n1>:FWIDth:VALue](#) on page 900
- [INPut<n1>:INPut](#) on page 897
- [INPut<n1>:LBITs](#) on page 900
- [INPut<n1>:LOGVoltage](#) on page 900
- [INPut<n1>:MChannels<n2>](#) on page 893
- [INPut<n1>:MCHSource<n2>](#) on page 901
- [INPut<n1>:MRATio](#) on page 901
- [INPut<n1>:MSAMplefrequency](#) on page 901

- [INPut<n1>:NOSLots](#) on page 901
- [INPut<n1>:RATio](#) on page 901
- [INPut<n1>:RESYnc](#) on page 901
- [INPut<n1>:SAMPle:FREQuency](#) on page 896
- [INPut<n1>:SAMPle:FREQuency:MODE](#) on page 896
- [INPut<n1>:SDELay](#) on page 902
- [INPut<n1>:SLOTs<n2>](#) on page 902
- [INPut<n1>:SLTLength](#) on page 902
- [INPut<n1>:SPFRame](#) on page 902
- [INPut<n1>:SYNCto](#) on page 902
- [INPut<n1>:TIMEout](#) on page 902
- [SENSe<n1>:MAX:FFT:SIZE](#) on page 894
- [SENSe<n1>:REFerence<n2>:CHANnel](#) on page 894
- [TRIGger:CHANnel](#) on page 909

INPut<n1>:BSLope <bslope>

Parameters:

<bslope> RISING | FALLING

Manual operation: See "[BClk Slope](#)" on page 408
 See "[BClk Slope](#)" on page 422

INPut<n1>:CLOCK <clock>

Parameters:

<clock> selection
 CONTinuous | GATed

Manual operation: See "[Clock](#)" on page 401
 See "[Clock](#)" on page 416

INPut<n1>:CODing <coding>

Parameters:

<coding> NONE | ALAW | ULAW

Manual operation: See "[Coding](#)" on page 410
 See "[Coding](#)" on page 423

INPut<n1>:FBIT <fbit>

Parameters:

<fbit> MSB | LSB

Manual operation: See "[First Bit](#)" on page 404
 See "[First Bit](#)" on page 418

INPut<n1>:FOFFset <foffset>**Parameters:**

<foffset> integer

Manual operation: See ["Fsync Offset"](#) on page 408
See ["Fsync Offset"](#) on page 422

INPut<n1>:FSYNc:FREQUency?**Return values:**

<argument> integer

Usage: Query only

Manual operation: See ["Fsync Freq"](#) on page 407
See ["Fsync Freq"](#) on page 421

INPut<n1>:FWIDth <fwidth>**Parameters:**

<fwidth> selection
NEBit | ONESlot | SQUare | VALue

Manual operation: See ["Fsync Width"](#) on page 407
See ["Fsync Width"](#) on page 421

INPut<n1>:FWIDth:VALue <value>**Parameters:**

<value> integer

Manual operation: See ["Fsync Width"](#) on page 407
See ["Fsync Width"](#) on page 421

INPut<n1>:LBITs <lbits>**Parameters:**

<lbits> integer

Manual operation: See ["Lead Bits"](#) on page 405

INPut<n1>:LOGVoltage <logvoltage>**Parameters:**

<logvoltage> selection
MV0900 | MV1200 | MV1500 | MV1800 | MV2500 | MV3300

Manual operation: See ["Logic Voltage"](#) on page 409
See ["Logic Voltage"](#) on page 423
See ["Logic Voltage"](#) on page 432

INPut<n1>:MCHSource<n2> <mchsource>**Parameters:**

<mchsource> RX1Data | RX2Data | RX3Data | RX4Data

Manual operation: See "[Ch1 MeasSour](#)" on page 402
See "[Ch2 MeasSour](#)" on page 403
See "[Ch<n> MeasSour](#)" on page 417

INPut<n1>:MRATio <mratio>**Parameters:**

<mratio> integer

Manual operation: See "[MClk Ratio](#)" on page 409
See "[MClk Ratio](#)" on page 423

INPut<n1>:MSAMplefrequency <msamplefrequency>**Parameters:**

<msamplefrequency> ON | OFF

Manual operation: See "[Mixed Sampfrq](#)" on page 401

INPut<n1>:NOSLots <noslots>**Parameters:**

<noslots> integer

Manual operation: See "[No of Slots](#)" on page 402
See "[No of Slots](#)" on page 416

INPut<n1>:RATio <ratio>**Parameters:**

<ratio> integer

Manual operation: See "[Ratio](#)" on page 401

INPut<n1>:RESYnc <state>**Parameters:**

<state> ONCE | EXEC

Manual operation: See "[Resync](#)" on page 411
See "[Resync](#)" on page 426
See "[Resync](#)" on page 435

INPut<n1>:SDElay <sdelay>**Parameters:**

<sdelay> float

Manual operation: See ["Sampling Del"](#) on page 409
See ["Sampling Del"](#) on page 423
See ["Sampling Del"](#) on page 431

INPut<n1>:SLOTs<n2> <slots>**Parameters:**

<slots> string

Manual operation: See ["Slots"](#) on page 403
See ["Slots"](#) on page 403
See ["Slots"](#) on page 417

INPut<n1>:SLTLength <sltlength>**Parameters:**

<sltlength> integer

Manual operation: See ["Slot Length"](#) on page 405
See ["Slot Length"](#) on page 419

INPut<n1>:SPFRame <spframe>**Parameters:**

<spframe> integer

Manual operation: See ["Samples/Frame"](#) on page 402
See ["Samples/Frame"](#) on page 416

INPut<n1>:SYNCto <syncto>**Parameters:**

<syncto> selection

ICLock | EMASterclock | EFSync | EFAMon | EFBCIk**Manual operation:** See ["Sync To"](#) on page 403
See ["Sync To"](#) on page 417

INPut<n1>:TIMEout <timeout>**Parameters:**

<timeout> float

Manual operation: See ["Timeout"](#) on page 405
See ["Timeout"](#) on page 419

7.4.7 Configure Dig Bitstream Analyzer

The settings for the Dig Bitstream Analyzer are performed in the `INPut`, `SENSe` and `TRIGger` subsystems.

- `INPut<n1>:ALIGnment` on page 903
- `INPut<n1>:AUDiobits` on page 895
- `INPut<n1>:CHMode` on page 903
- `INPut<n1>:CLKFrequency` on page 903
- `INPut<n1>:CLKSource` on page 904
- `INPut<n1>:DTYCycle` on page 904
- `INPut<n1>:DWNFactor` on page 904
- `INPut<n1>:FILTer` on page 958
- `INPut<n1>:LOGVoltage` on page 900
- `INPut<n1>:MCHannels<n2>` on page 893
- `INPut<n1>:SAMPle:FREQuency` on page 896
- `INPut<n1>:SAMPle:FREQuency:MODE` on page 896
- `INPut<n1>:SDELay` on page 902
- `INPut<n1>:RESYnc` on page 901
- `SENSe<n1>:MAX:FFT:SIZE` on page 894
- `SENSe<n1>:REFerence<n2>:CHANnel` on page 894
- `TRIGger:CHANnel` on page 909
- `TRIGger:DELay` on page 909
- `TRIGger:SOURce` on page 910

`INPut<n1>:ALIGnment` <alignment>

Parameters:

<alignment> `RISing` | `FALLing` | `CH1Hch2l` | `CH1Lch2h` | `CH1Rch2f` | `CH1Fch2r`

Manual operation: See "[Alignment](#)" on page 429

`INPut<n1>:CHMode` <chmode>

Parameters:

<chmode> `MONO` | `STEReo`

Manual operation: See "[Channel Mode](#)" on page 429

`INPut<n1>:CLKFrequency` <clkfrequency>

Parameters:

<clkfrequency> `float`

Manual operation: See "[Clock Freq](#)" on page 430

INPut<n1>:CLKSource <clksource>**Parameters:**

<clksource> INTern | EXTern

Manual operation: See "[Clock Source](#)" on page 428

INPut<n1>:DTYCycle <dtycle>**Parameters:**

<dtycle> float

Manual operation: See "[Duty Cycle](#)" on page 430

INPut<n1>:DWNFactor <dwnfactor>**Parameters:**

<dwnfactor> M16 | M32 | M64 | M96 | M128 | M192 | M256 | M384 | M512

Manual operation: See "[Dwnsmpl Fact](#)" on page 431

7.5 Triggering Measurements and Reading Results

This chapter describes how to start single measurements or continuous measurements and how to read results from the instrument by means of remote control commands.

These commands cannot be logged by means of the SCPI recording function.

7.5.1 Starting Measurements

See also [chapter 5.19, "Starting Measurements"](#), on page 438

Continuous measurement

This is the standard operating mode of the measurement system to which the Audio Analyzer is set on switch-on. All types of measurements that are activated are performed continuously. You can start a continuous measurement by pressing START. The START LED is on to indicate that the continuous measurement mode is active.

In this operation mode, every change in the generator, analyzer or filter bank triggers a restart of the continuous measurement in progress. This also applies to the *RST command and the loading of setups.

This ensures that the displayed measurement data is not corrupted by internal switching operations of the analyzer or by a change of the generator signal. The execution time of the setting commands in question takes a bit longer in comparison to a stopped measurement. To keep setting times as short as possible, you should execute longer command sequences in the "terminated" or "stop" state, i.e. during stopped measurements.

Single measurement

The Audio Analyzer carries out a single measurement for all measurement types activated; then the measurement system goes to the "Terminated" state. It is not mandatory that valid results be produced by the measurements: if an error occurs during a measurement, the result is indicated as being invalid. In such case, "----" rather than the measured value will be displayed in the associated result window. With remote control, a NAN ("not a number", $>1.0e37$) value will be returned. You can start a single measurement by pressing SINGLE. The START LED and the SINGLE LED are on to indicate that the single measurement mode is active. In this operation mode, all setting commands that occur after the measurement timing are executed without restart and therefore require less time than during a continuous measurement. This also applies to the *RST command and the loading of setups.

- [INITiate:CONTinuous](#) on page 906
- [INITiate:CONTinuous:TIMEout](#) on page 907
- [INITiate:FORCe](#) on page 908
- [INITiate](#) on page 908
- [ABORt](#) on page 909

INITiate:CONTInuous <state>**Parameters:**

<state>

ON | OFF | WAIT | RStart

ON

Switches to the "continuous measurement" mode. Any continuous or single measurement that is already active is terminated. A new continuous measurement is started. This parameter changes the `INITiate` presetting to the "continuous" mode, i.e. every subsequent `INITiate` command (without parameter) starts a new continuous measurement and thus has the same effect as `INITiate:CONTInuous ON`. Identical to the `START` stroke. This command includes various reset functions: Resets the MIN/MAX indicator, the MIN/MAX values and the limit violations of the measurement displays as well as the highlighting of the protocol analysis. Certain generator signals (burst signals, playback of WAV files by means of the Play function) are reset to the initial state. This command is recommended for continuous result reading.

OFF

Switches to the "single measurement" mode. Any in-progress continuous or single measurement is stopped. A new single measurement is started. This parameter changes the `INITiate` presetting to the "Single" mode, i.e. every subsequent `INITiate` command (without parameter) starts a new single measurement and thus has the same effect as `INITiate:CONTInuous OFF`. In the case of a stopped measurement or in-progress single measurement identical to the `SINGLE` stroke (during in-progress continuous measurement, the `SINGLE` stroke switches to single measurement without stopping the continuous measurement). Identical to `INITiate:FORCe SINGLE`. This command does not involve reset functions, which means that the measurement is started several milliseconds faster. Recommended for single triggered measurements.

WAIT

`CONTInous` measurement in which the `SENSe<n1>:DATA<n2>` commands, which are used to query the measurement results, stop the IEC/IEEE bus until a measurement result is available.

RStart

Resets the measurement or Play function and starts a single measurement or a sweep. it is identical to the `START` stroke.

Manual operation: See "START" on page 441
See "SINGLE" on page 441
See "START" on page 442
See "SINGLE" on page 442
See "START" on page 443
See "SINGLE" on page 444
See "START" on page 458
See "SINGLE" on page 458
See "START" on page 459
See "SINGLE" on page 460
See "START" on page 461
See "SINGLE" on page 461
See "START" on page 462
See "SINGLE" on page 462

INITiate:CONTinuous:TIMEout <timeout>

If timeout occurs without a new measurement result being available, the last measurement result that was read out is returned.

Parameters:

<timeout> 0 ... 1000 s
0 s corresponds to the INIT:CONT ON setting.

INITiate:FORCe <force>**Parameters:**

<force>

START | STOP | SINGLE | CONTInuous

START

Start of a continuous measurement.

Identical to the START stroke.

Identical to INITiate:CONTInuous ON; however, without changing the INITiate presetting.

STOP

Stops a measurement as if STOP/CONT was pressed while a measurement was in progress. (Identical to the ABORt command).

SINGLE

Start of a single measurement.

In the case of a stopped measurement or an in-progress single measurement identical to the SINGLEstroke (during in-progress continuous measurement the SINGLE keystroke switches to single measurement without stopping the continuous measurement).

Identical to INITiate:CONTInuous OFF; however, without changing the INITiate presetting.

CONTInuous

Start of a continuous measurement; however, without reset function.

This retains the MIN/MAX values and limit violations, and measurement is started several milliseconds faster.

Manual operation:

See "STOP/CONT" on page 441

See "STOP/CONT" on page 443

See "STOP/CONT" on page 444

See "START" on page 458

See "SINGLE" on page 458

See "STOP/CONT" on page 459

See "START" on page 459

See "SINGLE" on page 460

See "STOP/CONT" on page 460

See "START" on page 461

See "SINGLE" on page 461

See "START" on page 462

See "SINGLE" on page 462

INITiate

Starts a measurement according to the mode preset by INITiate:CONTInuous (continuous or single measurement).

ABORT

Identical to `INITiate:FORCE STOP`.

Stops a measurement as if STOP/CONT was pressed while a measurement was in progress.

7.5.2 Start Conditions

The following commands define the start conditions for the measurement.

- `TRIGger:CHANnel` on page 909
- `TRIGger:COUNt` on page 909
- `TRIGger:DELAy` on page 909
- `TRIGger:FREQuency:VARIation` on page 910
- `TRIGger:SOURce` on page 910
- `TRIGger:TIMer` on page 910
- `TRIGger:VOLTage:VARIation` on page 910

TRIGger:CHANnel <channel>**Parameters:**

<channel> OFF | CH1 | CH2 | CH3 | CH4 | CH5 | CH6 | CH7 | CH8 | | CH9 |
CH10 | CH11 | CH12 | CH13 | CH14 | CH15 | CH16

Manual operation: See "[Trigger Chan](#)" on page 383
See "[Trigger Chan](#)" on page 425
See "[Trigger Chan](#)" on page 433
See "[Trigger Chan](#)" on page 446
See "[Trigger Chan](#)" on page 580

TRIGger:COUNt <count>**Parameters:**

<count> integer

Manual operation: See "[Points](#)" on page 452

TRIGger:DELAy <delay>**Parameters:**

<delay> float

Manual operation: See "[Delay](#)" on page 374
See "[Delay](#)" on page 384
See "[Delay](#)" on page 434
See "[Delay](#)" on page 451

TRIGger:FREQuency:VARiation <variation>**Parameters:**

<variation> float

Manual operation: See "[Variation](#)" on page 455

TRIGger:SOURce <source>**Parameters:**

<source> AUTO | IMMEDIATE | TIMER | CH1Freq | CH2Freq | CH1Level | CH2Level | CH1Trigger | CH2Trigger | TCHart | CH1Rapidfreq | CH2Rapidfreq | CH1Edgetrigger | CH2Edgetrigger | FREQUENCY | RAPIDfreq | LEVEL | TRIGGER | EDGETRIGGER

Manual operation: See "[Start Cond](#)" on page 374
See "[Start Cond](#)" on page 384
See "[Start Cond](#)" on page 434
See "[Start Cond](#)" on page 446

TRIGger:TIMER <timer>**Parameters:**

<timer> float

Manual operation: See "[Time](#)" on page 452

TRIGger:VOLTage:VARiation <variation>**Parameters:**

<variation> float

Manual operation: See "[Variation](#)" on page 455

7.5.3 External Sweeps and Level-Controlled Measurement Value Triggering

The following commands control the start conditions for external sweeps and level-controlled measurement value triggering (see also [chapter 5.23, "External Sweeps and Level-Controlled Measured value Triggering"](#), on page 453).

- [ARM:FREQuency:START](#) on page 911
- [ARM:FREQuency:STOP](#) on page 911
- [ARM:LEVel:MIN](#) on page 911
- [ARM:VOLTage:START](#) on page 911
- [ARM:VOLTage:STOP](#) on page 911
- [TRIGger:FREQuency:VARiation](#) on page 910
- [TRIGger:VOLTage:VARiation](#) on page 910

ARM:FREQUency:START <start>**Parameters:**

<start> float

Manual operation: See ["Start"](#) on page 454

ARM:FREQUency:STOP <stop>**Parameters:**

<stop> float

Manual operation: See ["Stop"](#) on page 455

ARM:LEVEl:MIN <min>**Parameters:**

<min> float

Manual operation: See ["Min Volt"](#) on page 454

ARM:VOLTage:START <start>**Parameters:**

<start> float

Manual operation: See ["Start"](#) on page 454

ARM:VOLTage:STOP <stop>**Parameters:**

<stop> float

Manual operation: See ["Stop"](#) on page 455

7.5.4 Reading Measurement Results

Depending on the measurements activated in the Analyzer panel, the Audio Analyzer indicates up to eight results in the numeric display in the case of a two-channel instrument and up to 64 results in the case of a multichannel instrument. The results are also available in buffers from where they can be read by remote control.

- [SENSe<n1>:DATA<n2>?](#) on page 911
- [SENSe<n1>:DATA<n2>:ALL?](#) on page 913

SENSe<n1>:DATA<n2>? <data>

The command retrieves the selected measurement result of the selected channel. The type of measurement is defined by suffix <n1>, the channel by suffix <n2> (for suffix range see below).

The figure below shows the assignment of remote control commands to the results indicated in the numeric display for an 8-channel analyzer.

For reasons of compatibility with the R&S UPL, in dual-measurement mode, a phase- or group-delay measurement result can be retrieved with `SENS4 : DATA?` in addition to command `SENS3 : DATA?`.

	RMS	Level RMS	Input Peak	Frequency
Ch1	SENS1 : DATA1?	SENS6 : DATA1?	SENS2 : DATA1?	SENS3 : DATA1?
Ch2	SENS1 : DATA2?	SENS6 : DATA2?	SENS2 : DATA2?	SENS3 : DATA2?
Ch3	SENS1 : DATA3?	SENS6 : DATA3?	SENS2 : DATA3?	SENS3 : DATA3?
Ch4	SENS1 : DATA4?	SENS6 : DATA4?	SENS2 : DATA4?	SENS3 : DATA4?
Ch5	SENS1 : DATA5?	SENS6 : DATA5?	SENS2 : DATA5?	SENS3 : DATA5?
Ch6	SENS1 : DATA6?	SENS6 : DATA6?	SENS2 : DATA6?	SENS3 : DATA6?
Ch7	SENS1 : DATA7?	SENS6 : DATA7?	SENS2 : DATA7?	SENS3 : DATA7?
Ch8	SENS1 : DATA8?	SENS6 : DATA8?	SENS2 : DATA8?	SENS3 : DATA8?

Fig. 7-1: Numeric Display and associated remote control commands

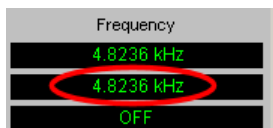
The query with `MIN` and `MAX` indicates the minimum and maximum measured value shown in the combi display above the measured value.

The return value comes in the basic unit (without engineering), e.g. a measurement result of 1.2345 kHz is returned as 1234.5 (Hz), a measurement result of 12.345 µV as 12.345e-006 (V).

If the measurement result of an overranged channel is requested with the `SENSe<n1> : DATA<n2>?` command, the value "3.40282346639e+038" (represents NaN = Not a Number) is returned.

Example

Display of channel 2's current frequency measurement result in the numeric display.



Display of channel 2's current frequency measurement result in the combined display with minimum and maximum values.



Parameters:

<data> float

Example: Reads out the current frequency measurement result and the respective MIN/MAX values from channel 2, see example above for graphical representation:

```
SENS3:DATA2?
```

Response: 4823.6 Hz

```
SENS3:DATA2? MIN
```

Response: 1000 Hz

```
SENS3:DATA2? MAX
```

Response: 20000 Hz

Usage: Query only

SENSe<n1>:DATA<n2>:ALL? <all>

Returns the measurement results of all channels in the form of float values which are separated by a comma. Channels which are switched off are represented by value "9.91E+37".

Dual channel instruments: 2 channels

Multi channel instruments: 1 to 16 channels

Suffix:

<n1>

1 | 2 | 3 | 6

1 = function measurement results

2 = input peak measurement results

3 = frequency , phase measurement results

6 = level monitor measurement results

Parameters:

<all>

float, float , float

Example:

```
INIT:CONT OFF; *WAI
```

```
SENS1:DATA:ALL?
```

Response:

```
1.0006 V,9.91E+37,1.00057 V,9.91E+37,1.00051 V,9.91E+37,9.91E+37,1.00051 V
```

Example:

```
INIT:CONT OFF; *WAI
```

```
SENS3:DATA:ALL?
```

Response:

```
1000 HZ,9.91E+37,-0.00248114
```

```
DEG,9.91E+37,0.00565384
```

```
DEG,9.91E+37,9.91E+37,0.0115933 DEG
```

A query with MIN or MAX returns all stored minimum and maximum measurement results.

Usage: Query only

7.5.5 Output of Trace Data Sets

The commands are grouped for the following subsystems according to their function:

SWEep | FFT | BARGraph | WAVEform | PESQ

Suffix <n2> denotes the graphic window. The value range depends on the subsystem:

For the Subsystem Sweep:	<n2> = 1 ... 4
For the Subsystem FFT:	<n2> = 1 2
For the Subsystem BARGraph:	<n2> = 1 2
For the Subsystems WAVEform:	<n2> = 1
For the Subsystems PESQ:	<n2> = 1 2

- [DISPlay:BARGraph<n2>:SCANoffset](#) on page 917
- [DISPlay:FFT<n2>:SCANoffset](#) on page 917
- [DISPlay:PESQ<n2>:SCANoffset](#) on page 917
- [DISPlay:SWEep<n2>:SCANoffset](#) on page 917
- [DISPlay:WAVEform<n2>:SCANoffset](#) on page 917
- [FORMat](#) on page 916
- [TRACe:BARGraph<n2>:LDList:AX?](#) on page 923
- [TRACe:BARGraph<n2>:LDList:AY?](#) on page 923
- [TRACe:BARGraph<n2>:LDList:BX?](#) on page 923
- [TRACe:BARGraph<n2>:LDList:BY?](#) on page 923
- [TRACe:BARGraph<n2>:LDList:COUNt:AX?](#) on page 924
- [TRACe:BARGraph<n2>:LDList:COUNt:AY?](#) on page 924
- [TRACe:BARGraph<n2>:LDList:COUNt:BX?](#) on page 924
- [TRACe:BARGraph<n2>:LDList:COUNt:BY?](#) on page 924
- [TRACe:BARGraph<n2>:LOAD:AX?](#) on page 920
- [TRACe:BARGraph<n2>:LOAD:AY?](#) on page 920
- [TRACe:BARGraph<n2>:LOAD:BX?](#) on page 920
- [TRACe:BARGraph<n2>:LOAD:BY?](#) on page 920
- [TRACe:BARGraph<n2>:LOAD:COUNt:AX?](#) on page 920
- [TRACe:BARGraph<n2>:LOAD:COUNt:AY?](#) on page 920
- [TRACe:BARGraph<n2>:LOAD:COUNt:BX?](#) on page 920
- [TRACe:BARGraph<n2>:LOAD:COUNt:BY?](#) on page 920
- [DISPlay:BARGraph<n2>:SCANoffset](#) on page 917
- [TRACe:BARGraph<n2>:STORe:AY](#) on page 1015
- [TRACe:BARGraph<n2>:STORe:BY](#) on page 1015
- [TRACe:FFT<n2>:LDList:AX?](#) on page 922
- [TRACe:FFT<n2>:LDList:AY?](#) on page 922
- [TRACe:FFT<n2>:LDList:BX?](#) on page 922
- [TRACe:FFT<n2>:LDList:BY?](#) on page 922

- [TRACe:FFT<n2>:LDList:COUNT:AX?](#) on page 922
- [TRACe:FFT<n2>:LDList:COUNT:AY?](#) on page 922
- [TRACe:FFT<n2>:LDList:COUNT:BX?](#) on page 922
- [TRACe:FFT<n2>:LDList:COUNT:BY?](#) on page 922
- [TRACe:FFT<n2>:LOAD:AX?](#) on page 919
- [TRACe:FFT<n2>:LOAD:AY?](#) on page 919
- [TRACe:FFT<n2>:LOAD:BX?](#) on page 919
- [TRACe:FFT<n2>:LOAD:BY?](#) on page 919
- [TRACe:FFT<n2>:LOAD:COUNT:AX?](#) on page 919
- [TRACe:FFT<n2>:LOAD:COUNT:AY?](#) on page 919
- [TRACe:FFT<n2>:LOAD:COUNT:BX?](#) on page 919
- [TRACe:FFT<n2>:LOAD:COUNT:BY?](#) on page 919
- [DISPlay:FFT<n2>:SCANoffset](#) on page 917
- [TRACe:FFT<n2>:STORe:AY](#) on page 1015
- [TRACe:FFT<n2>:STORe:BY](#) on page 1015
- [TRACe:PESQ<n2>:LDList:AX?](#) on page 923
- [TRACe:PESQ<n2>:LDList:AY?](#) on page 923
- [TRACe:PESQ<n2>:LDList:BX?](#) on page 923
- [TRACe:PESQ<n2>:LDList:BY?](#) on page 923
- [TRACe:PESQ<n2>:LDList:COUNT:AX?](#) on page 923
- [TRACe:PESQ<n2>:LDList:COUNT:AY?](#) on page 923
- [TRACe:PESQ<n2>:LDList:COUNT:BX?](#) on page 923
- [TRACe:PESQ<n2>:LDList:COUNT:BY?](#) on page 923
- [TRACe:PESQ<n2>:LOAD:AX?](#) on page 920
- [TRACe:PESQ<n2>:LOAD:AY?](#) on page 920
- [TRACe:PESQ<n2>:LOAD:BX?](#) on page 920
- [TRACe:PESQ<n2>:LOAD:BY?](#) on page 920
- [TRACe:PESQ<n2>:LOAD:COUNT:AX?](#) on page 920
- [TRACe:PESQ<n2>:LOAD:COUNT:AY?](#) on page 921
- [TRACe:PESQ<n2>:LOAD:COUNT:BX?](#) on page 921
- [TRACe:PESQ<n2>:LOAD:COUNT:BY?](#) on page 921
- [DISPlay:PESQ<n2>:SCANoffset](#) on page 917
- [TRACe:PESQ<n2>:STORe:AY](#) on page 1016
- [TRACe:PESQ<n2>:STORe:BY](#) on page 1016
- [TRACe:SWEep<n2>:LDList:AX?](#) on page 921
- [TRACe:SWEep<n2>:LDList:AY?](#) on page 921
- [TRACe:SWEep<n2>:LDList:BX?](#) on page 921
- [TRACe:SWEep<n2>:LDList:BY?](#) on page 921

- TRACe:SWEep<n2>:LDList:COUNT:AX? on page 921
- TRACe:SWEep<n2>:LDList:COUNT:AY? on page 921
- TRACe:SWEep<n2>:LDList:COUNT:BX? on page 921
- TRACe:SWEep<n2>:LDList:COUNT:BY? on page 921
- TRACe:SWEep<n2>:LOAD:AX? on page 918
- TRACe:SWEep<n2>:LOAD:AY? on page 918
- TRACe:SWEep<n2>:LOAD:BX? on page 918
- TRACe:SWEep<n2>:LOAD:BY? on page 918
- TRACe:SWEep<n2>:LOAD:COUNT:AX? on page 918
- TRACe:SWEep<n2>:LOAD:COUNT:AY? on page 918
- TRACe:SWEep<n2>:LOAD:COUNT:BX? on page 918
- TRACe:SWEep<n2>:LOAD:COUNT:BY? on page 918
- TRACe:SWEep<n2>:STORe:AX on page 1015
- TRACe:SWEep<n2>:STORe:AY on page 1015
- TRACe:SWEep<n2>:STORe:BX on page 1015
- TRACe:SWEep<n2>:STORe:BY on page 1015
- TRACe:WAVeform<n2>:LDList:AX? on page 922
- TRACe:WAVeform<n2>:LDList:AY? on page 922
- TRACe:WAVeform<n2>:LDList:BX? on page 922
- TRACe:WAVeform<n2>:LDList:BY? on page 922
- TRACe:WAVeform<n2>:LDList:COUNT:AX? on page 922
- TRACe:WAVeform<n2>:LDList:COUNT:AY? on page 922
- TRACe:WAVeform<n2>:LDList:COUNT:BX? on page 922
- TRACe:WAVeform<n2>:LDList:COUNT:BY? on page 922
- TRACe:WAVeform<n2>:LOAD:AX? on page 919
- TRACe:WAVeform<n2>:LOAD:AY? on page 919
- TRACe:WAVeform<n2>:LOAD:BX? on page 919
- TRACe:WAVeform<n2>:LOAD:BY? on page 919
- TRACe:WAVeform<n2>:LOAD:COUNT:AX? on page 919
- TRACe:WAVeform<n2>:LOAD:COUNT:AY? on page 919
- TRACe:WAVeform<n2>:LOAD:COUNT:BX? on page 920
- TRACe:WAVeform<n2>:LOAD:COUNT:BY? on page 920
- DISPlay:WAVeform<n2>:SCANoffset on page 917
- TRACe:WAVeform<n2>:STORe:AY on page 1016
- TRACe:WAVeform<n2>:STORe:BY on page 1016

FORMat <format>

Defines the number format for outputting trace data sets.

This setting is not stored in the setup and is set to `ASCII` each time the R&S UPV is switched on.

Parameters:

<format>

REAL | ASCII

REAL

Binary form!

The trace data sets are returned in binary format.

The binary data block has the following structure:

#<lengthofLength><Length><block_data>.

e.g. #234<block_data>

always introduces the binary block

<lengthofLength> indicates how many positions the following length specification occupies (2 in example)

<Length> indicates the number of subsequent bytes (34 in example)

<binary block data> binary block data of specified length

ASCII

Output as an ASCII string, digits with sign, decimal point and any exponent, e.g.

-57.1647, -6.08881, -32.304, -53.6429 ...

DISPlay:BARGraph<n2>:SCANoffset <scanoffset>**DISPlay:FFT<n2>:SCANoffset <scanoffset>****DISPlay:PESQ<n2>:SCANoffset <scanoffset>****DISPlay:WAVEform<n2>:SCANoffset <scanoffset>****DISPlay:SWEep<n2>:SCANoffset <scanoffset>**

Defines the desired scan for outputting trace data sets.

Suffix:

<n2>

The range of suffix <n2> varies depending on the subsystem, see [chapter 7.5.5, "Output of Trace Data Sets"](#), on page 913**Parameters:**

<scanoffset>

2, 1, 0, -1 to -19

2

max scan

1

min scan

0

latest scan

-1 bis -19

the more negative the number, the older the scan.

Example:`"DISP:SWE:SCAN 2`

Selects max scan for output

Manual operation:See "[Scan](#)" on page 726

TRACe:SWEep<n2>:LOAD:AX?
TRACe:SWEep<n2>:LOAD:AY?
TRACe:SWEep<n2>:LOAD:BX?
TRACe:SWEep<n2>:LOAD:BY?
TRACe:SWEep<n2>:LOAD:COUNT:AX?
TRACe:SWEep<n2>:LOAD:COUNT:AY?
TRACe:SWEep<n2>:LOAD:COUNT:BX?
TRACe:SWEep<n2>:LOAD:COUNT:BY?

Command for outputting sweep trace data sets, see (see [TRACe:SWEep<n2>:STORE:BY](#) on page 1015) and outputting the number of sweep data.

The following description shows the basic structure for command groups:

TRACe:Subsys<n2>:LOAD:..

TRACe:Subsys<n2>:LOAD:COUNT:.. and

TRACe:Subsys<n2>:LDList:.. and

TRACe:Subsys<n2>:LDList:COUNT:..

AX designates the X-axis of trace A

AY designates the Y-axis of trace A

BX designates the X-axis of trace B

BY designates the Y-axis of trace B

In the case of a multiscan display or single display with min/max traces, the command [DISPlay:SWEep<n2>:SCANoffset](#) on page 917 selects the desired scan.

The first example queries the sweep data, the second queries the number of data.

Suffix:

<n2> 1 ... 4
 subsystems 1 to 4

Return values:

<argument> integer | float | binary

For the `COUNT` commands, an integer value is returned.

The format of the return values of the other commands depends on the `FORMat` setting:

If `FORMat ASCii` is selected float values are returned.

If `FORMat REAL` is selected a binary data block is returned.

Example:	<p>First example:</p> <pre>TRAC:SWEp1:LOAD:AY?</pre> <p>Outputs the data of the Y-axis of channel A from the first sweep system.</p> <p>Response with the setting <code>FORMat ASC</code>: <code>-57.1647,-6.08881,-32.304,-53.6429 ...</code></p> <p>Response with the setting <code>FORMat REAL</code>: <code>#<Lengthoflength><length><block_data></code></p> <p>Second example</p> <pre>TRACe:SWEp1:LOAD:COUNT:BY?</pre> <p>Outputs the number of data of the Y-axis of channel B from the first sweep subsystem</p> <p>Response: <code>50</code></p>
Usage:	Query only

TRACe:FFT<n2>:LOAD:AX?
TRACe:FFT<n2>:LOAD:AY?
TRACe:FFT<n2>:LOAD:BX?
TRACe:FFT<n2>:LOAD:BY?
TRACe:FFT<n2>:LOAD:COUNT:AX?
TRACe:FFT<n2>:LOAD:COUNT:AY?
TRACe:FFT<n2>:LOAD:COUNT:BX?
TRACe:FFT<n2>:LOAD:COUNT:BY?

Commands for outputting FFT data and outputting the number of FFT data. See also [TRACe:SWEp<n2>:LOAD:COUNT:BY?](#) on page 918.

Suffix:

<n2> 1 | 2
subsystems 1 and 2

Return values:

<argument> integer | float | binary

For the `COUNT` commands, an integer value is returned.
The format of the return values of the other commands depends on the `FORMat` setting:

If `FORMat ASCii` is selected float values are returned.
If `FORMat REAL` is selected a binary data block is returned.

Usage: Query only

TRACe:WAVeform<n2>:LOAD:AX?
TRACe:WAVeform<n2>:LOAD:AY?
TRACe:WAVeform<n2>:LOAD:BX?
TRACe:WAVeform<n2>:LOAD:BY?
TRACe:WAVeform<n2>:LOAD:COUNT:AX?
TRACe:WAVeform<n2>:LOAD:COUNT:AY?

TRACe:WAVeform<n2>:LOAD:COUNT:BX?**TRACe:WAVeform<n2>:LOAD:COUNT:BY?**

Commands for outputting Waveform data and outputting the number of Waveform data. See also [TRACe:SWEep<n2>:LOAD:COUNT:BY?](#) on page 918.

Suffix:

<n2> 1
subsystem 1

Return values:

<argument> integer | float | binary
For the `COUNT` commands, an integer value is returned.
The format of the return values of the other commands depends on the `FORMat` setting:
If `FORMat ASCii` is selected float values are returned.
If `FORMat REAL` is selected a binary data block is returned.

Usage: Query only

TRACe:BARGraph<n2>:LOAD:AX?**TRACe:BARGraph<n2>:LOAD:AY?****TRACe:BARGraph<n2>:LOAD:BX?****TRACe:BARGraph<n2>:LOAD:BY?****TRACe:BARGraph<n2>:LOAD:COUNT:AX?****TRACe:BARGraph<n2>:LOAD:COUNT:AY?****TRACe:BARGraph<n2>:LOAD:COUNT:BX?****TRACe:BARGraph<n2>:LOAD:COUNT:BY?**

Commands for outputting bargraph trace data sets and outputting the number of bargraph data. See also [TRACe:SWEep<n2>:LOAD:COUNT:BY?](#) on page 918.

Suffix:

<n2> 1 | 2
subsystems 1 and 2

Return values:

<argument> integer | float | binary
For the `COUNT` commands, an integer value is returned.
The format of the return values of the other commands depends on the `FORMat` setting:
If `FORMat ASCii` is selected float values are returned.
If `FORMat REAL` is selected a binary data block is returned.

Usage: Query only

TRACe:PESQ<n2>:LOAD:AX?**TRACe:PESQ<n2>:LOAD:AY?****TRACe:PESQ<n2>:LOAD:BX?****TRACe:PESQ<n2>:LOAD:BY?****TRACe:PESQ<n2>:LOAD:COUNT:AX?**

TRACe:PESQ<n2>:LOAD:COUNT:AY?
 TRACe:PESQ<n2>:LOAD:COUNT:BX?
 TRACe:PESQ<n2>:LOAD:COUNT:BY?

Commands for outputting PESQ data sets and outputting the number of PESQ data.
 See also [TRACe:SWEep<n2>:LOAD:COUNT:BY?](#) on page 918.

Suffix:

<n2> 1 | 2
 subsystems 1 and 2

Return values:

<argument> integer | float | binary
 For the `COUNT` commands, an integer value is returned.
 The format of the return values of the other commands depends on the `FORMat` setting:
 If `FORMat ASCii` is selected float values are returned.
 If `FORMat REAL` is selected a binary data block is returned.

Usage: Query only

TRACe:SWEep<n2>:LDList:AX?
 TRACe:SWEep<n2>:LDList:AY?
 TRACe:SWEep<n2>:LDList:BX?
 TRACe:SWEep<n2>:LDList:BY?
 TRACe:SWEep<n2>:LDList:COUNT:AX?
 TRACe:SWEep<n2>:LDList:COUNT:AY?
 TRACe:SWEep<n2>:LDList:COUNT:BX?
 TRACe:SWEep<n2>:LDList:COUNT:BY?

The `TRACe:SWEep<n2>:LDList:...` commands are basically identical to the `TRACe:SWEep<n2>:LOAD:...` commands, see [TRACe:SWEep<n2>:LOAD:BY?](#) on page 918.

They query the data records of filtered trace data and their number.

The filtering of the trace data is performed with command

`DISPlay:SWEep<n2>:DLISt:FILTer ALL | LIMUpper | LIMLower | LIMBoth | HARMonics | PEAKs`

Suffix:

<n2> 1 ... 4
 subsystems 1 to 4

Return values:

<argument> integer | float | binary
 For the `COUNT` commands, an integer value is returned.
 The format of the return values of the other commands depends on the `FORMat` setting:
 If `FORMat ASCii` is selected float values are returned.
 If `FORMat REAL` is selected a binary data block is returned.

Usage: Query only

TRACe:FFT<n2>:LDList:AX?
TRACe:FFT<n2>:LDList:AY?
TRACe:FFT<n2>:LDList:BX?
TRACe:FFT<n2>:LDList:BY?
TRACe:FFT<n2>:LDList:COUNT:AX?
TRACe:FFT<n2>:LDList:COUNT:AY?
TRACe:FFT<n2>:LDList:COUNT:BX?
TRACe:FFT<n2>:LDList:COUNT:BY?

The `TRACe:FFT<n2>:LDList:...` commands are basically identical to the `TRACe:FFT<n2>:LOAD:...` commands, see [TRACe:FFT<n2>:LOAD:COUNT:BY?](#) on page 919.

They query the data records of filtered trace data and their number.

The filtering of the trace data is performed with command

```
DISPlay:FFT<n2>:DLISt:FILTer ALL | LIMUpper | LIMLower | LIMBoth
| HARMonics | PEAKs
```

Suffix:

<n2> 1 | 2
 subsystems 1 and 2

Return values:

<argument> integer | float | binary

For the `COUNT` commands, an integer value is returned.

The format of the return values of the other commands depends on the `FORMat` setting:

If `FORMat ASCii` is selected float values are returned.

If `FORMat REAL` is selected a binary data block is returned.

Usage: Query only

TRACe:WAVeform<n2>:LDList:AX?
TRACe:WAVeform<n2>:LDList:AY?
TRACe:WAVeform<n2>:LDList:BX?
TRACe:WAVeform<n2>:LDList:BY?
TRACe:WAVeform<n2>:LDList:COUNT:AX?
TRACe:WAVeform<n2>:LDList:COUNT:AY?
TRACe:WAVeform<n2>:LDList:COUNT:BX?
TRACe:WAVeform<n2>:LDList:COUNT:BY?

The `TRACe:WAVeform<n2>:LDList:...` commands are basically identical to the `TRACe:WAVeform<n2>:LOAD:...` commands, see [TRACe:WAVeform<n2>:LOAD:COUNT:BY?](#) on page 920.

They query the data records of filtered trace data and their number.

The filtering of the trace data is performed with command

```
DISPlay:WAVeform:DLISt:FILTer ALL | LIMUpper | LIMLower |
LIMBoth | HARMonics | PEAKs
```

Suffix:

<n2> 1
subsystem 1

Return values:

<argument> integer | float | binary
For the `COUNT` commands, an integer value is returned.
The format of the return values of the other commands depends on the `FORMAt` setting:
If `FORMAt ASCii` is selected float values are returned.
If `FORMAt REAL` is selected a binary data block is returned.

Usage: Query only

TRACe:PESQ<n2>:LDList:AX?
TRACe:PESQ<n2>:LDList:AY?
TRACe:PESQ<n2>:LDList:BX?
TRACe:PESQ<n2>:LDList:BY?
TRACe:PESQ<n2>:LDList:COUNT:AX?
TRACe:PESQ<n2>:LDList:COUNT:AY?
TRACe:PESQ<n2>:LDList:COUNT:BX?
TRACe:PESQ<n2>:LDList:COUNT:BY?

The `TRACe:PESQ<n2>:LDList:...` commands are basically identical to the `TRACe:PESQ<n2>:LOAD:...` commands, see [TRACe:PESQ<n2>:LOAD:BY?](#) on page 920.

They query the data records of filtered trace data and their number.

The filtering of the trace data is performed with command

`DISPlay:PESQ<n2>:DLIST:FILTer ALL | LIMUpper | LIMLower | LIMBoth | HARMonics | PEAKs`

Suffix:

<n2> 1 | 2
subsystem 1 and 2

Return values:

<argument> integer | float | binary
For the `COUNT` commands, an integer value is returned.
The format of the return values of the other commands depends on the `FORMAt` setting:
If `FORMAt ASCii` is selected float values are returned.
If `FORMAt REAL` is selected a binary data block is returned.

Usage: Query only

TRACe:BARGraph<n2>:LDList:AX?
TRACe:BARGraph<n2>:LDList:AY?
TRACe:BARGraph<n2>:LDList:BX?
TRACe:BARGraph<n2>:LDList:BY?

TRACe:BARGraph<n2>:LDList:COUNT:AX?
TRACe:BARGraph<n2>:LDList:COUNT:AY?
TRACe:BARGraph<n2>:LDList:COUNT:BX?
TRACe:BARGraph<n2>:LDList:COUNT:BY?

The `TRACe:BARGraph<n2>:LDList:...` commands are basically identical to the `TRACe:BARGraph<n2>:LOAD:...` commands, see [TRACe:BARGraph<n2>:LOAD:BY?](#) on page 920.

They query the data records of filtered trace data and their number.

The filtering of the trace data is performed with command

`DISPlay:BARGraph:DLISt:FILTer ALL | LIMUpper | LIMLower | LIMBoth | HARMonics | PEAKs`

Suffix:

`<n2>` 1 | 2
subsystems 1 and 2

Return values:

`<argument>` integer | float | binary
 For the `COUNT` commands, an integer value is returned.
 The format of the return values of the other commands depends on the `FORMat` setting:
 If `FORMat ASCii` is selected float values are returned.
 If `FORMat REAL` is selected a binary data block is returned.

Usage: Query only

7.5.6 Reading out Multi-channel Records

The `DATA` commands are used to read out multi-channel records.

Only the traces which were available in the windows of the respective systems can be read out with the `TRACe` commands (see [chapter 7.5.5, "Output of Trace Data Sets"](#), on page 913).

That is not enough for the 16-channel version; that is why the traces for all channels switched on in the base unit can be read out with the `DATA` commands.

The `DATA` command tree is available for `SWEep` | `FFT` and `BARGraph` sub-systems.

It does not exist for the `WAVEform` and `PESQ` sub-systems because these sub-systems are designed with two channels. The `TRACe` commands from the previous chapter must be used to read out records from these sub-systems.

- [DATA:BARGraph:COUNT:X<n4>?](#) on page 925
- [DATA:BARGraph:COUNT:Y<n4>?](#) on page 925
- [DATA:BARGraph:X<n3>?](#) on page 926
- [DATA:BARGraph:Y<n3>?](#) on page 926
- [DATA:FFT:COUNT:X<n4>?](#) on page 925
- [DATA:FFT:COUNT:Y<n4>?](#) on page 925

- `DATA:FFT:X<n3>?` on page 926
- `DATA:FFT:Y<n3>?` on page 926
- `DATA:SWEep:COUNT:X<n4>?` on page 925
- `DATA:SWEep:COUNT:Y<n4>?` on page 925
- `DATA:SWEep:X<n3>?` on page 926
- `DATA:SWEep:Y<n3>?` on page 926

DATA:FFT:COUNT:X<n4>?

DATA:BARGraph:COUNT:X<n4>?

DATA:SWEep:COUNT:X<n4>?

Commands for reading out the number of X axis values of a sweep, an FFT or a bar-graph

The example below is exemplary for the FFT and bar graph sub-systems.

Suffix:

<n4> A channel need not be specified for reading out as there is only **one** X axis for all channels. Specifying a channel is nonetheless accepted as long as it is within the valid range.

Return values:

<argument> integer

Example:

`DATA:SWEep:COUNT:X?`

Reads out the number of X axis values from the sweep system.

Response:

100

Usage:

Query only

DATA:FFT:COUNT:Y<n4>?

DATA:BARGraph:COUNT:Y<n4>?

DATA:SWEep:COUNT:Y<n4>?

Commands to read out the number of values on the Y axis of a sweep, an FFT or a BARGraph.

The example below is exemplary for the FFT and BARGraph sub-systems.

Suffix:

<n4> Channel 1 ... 16

Return values:

<argument> integer

Example:

`DATA:SWEep:COUNT:Y?`

Reads out the number of Y axis values from the sweep system.

Response:

100

Usage:

Query only

DATA:FFT:X<n3>?
DATA:BARGraph:X<n3>?
DATA:SWEep:X<n3>?

Commands for reading out the X axis data of a sweep, an FFT or a bar graph.

The example below is exemplary for the FFT and bar graph sub-systems.

Suffix:

<n3> To read out the X axis there is no need to specify a channel, as there is only one X axis for all channels. Specifying a channel is nonetheless accepted as long as it is within the valid range.

Return values:

<argument> float values or block data
 the format of the returned data depends on the setting of format with command `FORMat`.

Example:

`DATA:SWEep:X?`
 Reads out X axis data from the sweep system.
 Response with the `FORMat ASCii` setting:
 100,120.045,144.109,172.997,207.675,249.304,...
 Response with the `FORMat REAL` setting:
 #<Lengthof length><length><block_data>

Usage: Query only

DATA:FFT:Y<n3>?
DATA:BARGraph:Y<n3>?
DATA:SWEep:Y<n3>?

Commands for reading out the Y axis values of a SWEep, an FFT or a BARGraph for the specified channel.

The example below is exemplary for the FFT and BARGraph sub-systems.

Suffix:

<n3> Channel 1 ... 16

Return values:

<argument> float value or block data
 the format of the returned data depends on the setting of format with command `FORMat`.

Example:

`DATA:SWEep:Y5?`
 Reads out channel 5's Y axis data from the sweep system.
 Response with the `FORMat ASCii` setting:
 0.0110738,0.0146608,0.0189856,0.0240953,0.0300301,...
 Response with the `FORMat REAL` setting:
 #<Lengthof length><length><block_data>

Usage: Query only

7.5.7 Output of Protocol Data

- [SENSe8:PROTOcol:CH<n3>:BYTE<n4>?](#) on page 927

SENSe8:PROTOcol:CH<n3>:BYTE<n4>?

Outputs the protocol data of byte <n4> of channel <n3>.

Suffix:

<n1>	8 specifies protocol analysis
<n3>	selects channel 1 or 2
<n4>	selects byte 0 to 4

Return values:

<argument>	0 to 255 Return value = decimal bit equivalent
------------	---

Example:

SENS8:PROT:CH1:BYTE2?
Outputs the protocol data of byte 2 (the third byte) of channel 1.

Usage: Query only

7.5.8 Output of Protocol Errors

- [SENSe8:PROTOcol:ERRor?](#) on page 928
- [SENSe8:PROTOcol:ERRor:CRC<n4>?](#) on page 928
- [SENSe8:PROTOcol:ERRor:INV<n4>?](#) on page 928
- [SENSe8:PROTOcol:ERRor:LOC<n4>?](#) on page 928
- [SENSe8:PROTOcol:ERRor:PAR<n4>?](#) on page 928
- [SENSe8:PROTOcol:ERRor:PCM<n4>?](#) on page 928

SENSe8:PROTocol:ERRor?**Return values:**

<argument> integer

return values:
 0, "No error"
 or
 <n>, "PCM1,PCM2,PAR1,PAR2,..."

The entire string is not returned in quotation marks, but only the mnemonic range.
 <n> represents 10 bits (d0 to d9)
 <n> = 0 to 1023

The individual errors are represented by means of bits in the integer value <n>:

d0: PCM1
 d1: PCM2
 d2: PAR1
 d3: PAR2
 d4: LOC1
 d5: LOC2
 d6: CRC1
 d7: CRC2
 d8: INV1
 d9: INV2

Example:

SENS8:PROT:ERR?
 Response: "4
 Binary equivalent = 0000000100. Thus, d2 is set and the PAR1 error is output.

Usage:

Query only

SENSe8:PROTocol:ERRor:CRC<n4>?**SENSe8:PROTocol:ERRor:INV<n4>?****SENSe8:PROTocol:ERRor:LOC<n4>?****SENSe8:PROTocol:ERRor:PAR<n4>?****SENSe8:PROTocol:ERRor:PCM<n4>?**

These commands query specific protocol errors.

Suffix:

<n4> selects channel 1 or 2

Return values:

<argument> integer

Return values:
 0 = no error
 1 = error

Example:

SENS8:PROT:PAR2?
 Response: 1
 A PAR2 error is present

Usage: Query only

7.6 Sweep Options

The sweep is controlled by commands in the `INITiate` subsystem.

- `INITiate:CONTinuous` on page 906
- `INITiate:FORCe` on page 908

7.7 Selecting Measurement and Mode

The measurement type and measurement mode is selected with the two `SENSe`-commands `SENSe:FUNCTion` and `SENSe:FUNCTion:MMode`.

In addition the more specific measurement mode commands `SENSe:FUNCTion:DMODE`, `SENSe:FUNCTion:APERTure:MODE` and `SENSe:VOLTage:APERTure` are described.

- `SENSe<n1>:FUNCTion` on page 929
- `SENSe<n1>:FUNCTion:APERTure:MODE` on page 930
- `SENSe<n1>:FUNCTion:DMODE` on page 931
- `SENSe<n1>:FUNCTion:MMODE` on page 931
- `SENSe<n1>:VOLTage:APERTure` on page 931

`SENSe<n1>:FUNCTion <state>`

specifies the measurement.

Important:

This command selects all function measurements and several other types of measurement, see below. The following description is valid for all types of measurements. See also [chapter 5.19, "Starting Measurements"](#), on page 438.

Suffix:

<code><n1></code>	specifies the type of measurement.
	1 = function measurement (level / signal to noise / distortion, ...)
	2 = input monitor measurement
	3 = frequency, phase, or group delay measurement
	6 = level monitor measurement
	7 = waveform monitor
	8 = protocol analysis

Parameters:

<state> OFF | IPEak | IPEAK | DC | DIGinpampl | RMS | RMSSelect | QPEak | THD | THDNsndr | MDISst | DIM | DFD | FFT | POLarity | COHerence | PHASetoref | RUBBuzz | NOCTave | FREQUENCY | FQPHase | FQGRoupdelay | SFRequency | FQSamplefrequency | LRMS | ON | SN | RECord | PESQ | POLQa | PEAQ | PLUGin | CHIRpbased

SENSe [1]:
RMS, RUBBuzz, RMSSelect, PEAK, QPEak, SN, THD, THDNsndr, MDISst, DFD, DIM, POLarity, NOCTave, FFT, PESQ, PEAQ, POLQa, COHerence, PLUGin, CHIRpbased

SENSe2:
ON, OFF, IPEak, PHASetoref, DIGinpampl

SENSe3:
ON, OFF, FREQUENCY, FQPHase, FQGRoupdelay, FQSamplefrequency, SFRequency

SENSe6:
PEAK, DC, LRMS

SENSe7:
ON, OFF

SENSe8:
ON, OFF | RECord

Manual operation: See ["Function "](#) on page 518
See ["Function "](#) on page 520
See ["Function "](#) on page 531
See ["Function"](#) on page 547
See ["Function"](#) on page 556
See ["Function"](#) on page 563
See ["Waveform "](#) on page 577
See ["Function "](#) on page 592
See ["Prot Analysis"](#) on page 602
See ["Freq Phase"](#) on page 606
See ["Input Monitor"](#) on page 612
See ["Level Monitor"](#) on page 613

SENSe<n1>:FUNcTion:APERture:MODE <mode>**Parameters:**

<mode> NARRow | MEDium | WIDE | AFASt | AUTO | FAST | SFASst | SLOW | VALue | GENTrack

Manual operation: See ["Meas Time"](#) on page 468
See ["Meas Time"](#) on page 471
See ["Meas Time"](#) on page 482
See ["Meas Time"](#) on page 492
See ["Reject Bandw "](#) on page 508
See ["Meas Time"](#) on page 521

SENSe<n1>:FUNcTion:DMODE <dmode>**Parameters:**

<dmode> FAST | PRECision

Manual operation: See ["Dynamic Mode "](#) on page 496

SENSe<n1>:FUNcTion:MMODE <mmode>**Parameters:**

<mmode> DALL | DODD | DEVen | D2 | D3 | | D2_268 | D3_268 | D2_118 | D3_118 | SElectdi | THDN | SINad | SNDRatio | PPEak | NPEak | PTOPeak | PABSolute | NOISe | LSElectdi | LDEVen | LDODd | LDALI | LTHDn | LNOISe | STANdard | COMPRESSED | USAMple | RMS | QPEak | OCT1 | OCT3 | OCT6 | OCT12 | OCT24 | CBANd | DUT | OFFLine | NARRow | WIDE

Manual operation: See ["Meas Mode "](#) on page 486
See ["Meas Mode "](#) on page 490
See ["Meas Mode "](#) on page 500
See ["Meas Mode "](#) on page 506
See ["Meas Mode "](#) on page 514
See ["Meas Mode "](#) on page 521
See ["Meas Mode "](#) on page 549
See ["Meas Mode "](#) on page 557
See ["Meas Mode "](#) on page 564

SENSe<n1>:VOLTage:APERture <aperture>**Parameters:**

<aperture> float

Manual operation: See ["Meas Time"](#) on page 468
See ["Meas Time"](#) on page 471
See ["Meas Time"](#) on page 482
See ["Meas Time"](#) on page 492
See ["Meas Time"](#) on page 521
See ["Max Delay"](#) on page 571

7.8 Level Measurements

The level measurement is configured using commands of the `SENSe` subsystem.

7.8.1 Filter Settings

- `SENSe<n1>:FILTer<n2>` on page 958
- `SENSe<n1>:NOTCh` on page 942

- [SENSe<n1>:NOTCh:FREQuency:MODE](#) on page 943
- [SENSe<n1>:NOTCh:FREQuency](#) on page 943

7.8.2 RMS and RMS Selective Measurement

- [MMEMory:LOAD:FREQuency:SLCFrequency](#) on page 932
- [SENSe<n1>:BANDwidth](#) on page 932
- [SENSe<n1>:BANDwidth:MODE](#) on page 932
- [SENSe<n1>:FREQuency](#) on page 933
- [SENSe<n1>:FREQuency:FACTor](#) on page 933
- [SENSe<n1>:FREQuency:SElect](#) on page 933
- [SENSe<n1>:FUNCTion](#) on page 929
- [SENSe<n1>:FUNCTion:APERTure:MODE](#) on page 930
- [SENSe<n1>:SWEep:CONTrol](#) on page 933
- [SENSe<n1>:SWEep:POINTs](#) on page 933
- [SENSe<n1>:SWEep:SPACing](#) on page 933
- [SENSe<n1>:SWEep:START](#) on page 934
- [SENSe<n1>:SWEep:STEP](#) on page 934
- [SENSe<n1>:SWEep:STOP](#) on page 934
- [SENSe<n1>:VOLTage:APERTure](#) on page 931
- [SENSe<n1>:VOLTage:INTVtime](#) on page 934
- [SENSe<n1>:VOLTage:INTVtime:MODE](#) on page 934

MMEMory:LOAD:FREQuency:SLCFrequency <filename>

Input of the file name for the list of band-pass / band-stop center frequencies (frequency sweep list). Only available for activated bandpass / band-stop list sweep.

Parameters:

<filename> string

Manual operation: See "[File Name](#)" on page 478

SENSe<n1>:BANDwidth <bandwidth>

Parameters:

<bandwidth> float

Manual operation: See "[Bandwidth](#)" on page 473

SENSe<n1>:BANDwidth:MODE <mode>

Parameters:

<mode> PPCT1 | PPCT3 | PTOct | POCT12 | PFIx | SPCT1 | SPCT3 |
STOCT | SOCT12 | SFIx | PFASt | SFASt

Manual operation: See ["Bandwidth"](#) on page 473

SENSe<n1>:FREQuency <frequency>

Parameters:

<frequency> float

Manual operation: See ["Freq Mode"](#) on page 478

SENSe<n1>:FREQuency:FACTor <factor>

Parameters:

<factor> float

Manual operation: See ["Factor"](#) on page 480
See ["Factor"](#) on page 484

SENSe<n1>:FREQuency:SELEct <select>

Parameters:

<select> CW | FIXed | GENTrack | CH1 | CH1Freq | CH2 | CH2Freq |
AUToboth | REFFrequency

Manual operation: See ["Freq Mode"](#) on page 478
See ["Freq Mode"](#) on page 483

SENSe<n1>:SWEep:CONTrol <control>

Parameters:

<control> OFF | ASweep | ALISt

Manual operation: See ["Sweep Ctrl"](#) on page 475

SENSe<n1>:SWEep:POINts <points>

Parameters:

<points> integer

Manual operation: See ["Points"](#) on page 477

SENSe<n1>:SWEep:SPACing <spacing>

Parameters:

<spacing> LINSteps | LOGSteps | LINPoints | LOGPoints

Manual operation: See ["Spacing"](#) on page 476

SENSe<n1>:SWEep:START <start>**Parameters:**

<start> float

Manual operation: See ["Start"](#) on page 477

SENSe<n1>:SWEep:STEP <step>**Parameters:**

<step> float

Manual operation: See ["Step"](#) on page 477

SENSe<n1>:SWEep:STOP <stop>**Parameters:**

<stop> float

Manual operation: See ["Stop"](#) on page 477

SENSe<n1>:VOLTage:INTVtime <intvtime>**Parameters:**

<intvtime> float

Manual operation: See ["Intv Time"](#) on page 486
See ["Intv Time"](#) on page 487

SENSe<n1>:VOLTage:INTVtime:MODE <mode>**Parameters:**

<mode> FAST | SFASt | SLOW | | FIXEd | FIX3 | VALue | OFF

Manual operation: See ["Intv Time"](#) on page 486
See ["Intv Time"](#) on page 487

7.8.3 Rub & Buzz Measurement

- [SENSe<n1>:FUNCTion](#) on page 929
- [SENSe3:FREQuency:APERTure:MODE](#) on page 955
- [SENSe<n1>:FREQuency:FACTor](#) on page 933
- [SOURce:RANDom:FREQuency:LOWer](#) on page 880
- [SENSe<n1>:FREQuency:SElect](#) on page 933
- [SOURce:RANDom:FREQuency:UPPer](#) on page 880

7.8.4 Peak Measurement

The following commands control the Peak and Quasi Peak measurement.

- [SENSe<n1>:FUNCTION:FFT:SIZE](#) on page 941
- [SENSe<n1>:FILTER<n2>](#) on page 958
- [SENSe<n1>:FUNCTION](#) on page 929
- [SENSe<n1>:FUNCTION:MMODE](#) on page 931
- [SENSe<n1>:FUNCTION:SETTLing:MODE](#) on page 956
- [SENSe<n1>:FUNCTION:SNSequence](#) on page 936
- [SENSe<n1>:VOLTage:INTVtime](#) on page 934
- [SENSe<n1>:VOLTage:INTVtime:MODE](#) on page 934

7.8.5 DC Voltage Measurement

- [SENSe<n1>:FUNCTION](#) on page 929

7.9 Signal-to-Noise Measurements

7.9.1 S/N Measurement Function

- [SENSe<n1>:FILTER<n2>](#) on page 958
- [SENSe<n1>:FUNCTION](#) on page 929
- [SENSe<n1>:FUNCTION:APERTure:MODE](#) on page 930
- [SENSe<n1>:FUNCTION:DCSuppression](#) on page 935
- [SENSe<n1>:FUNCTION:MMODE](#) on page 931
- [SENSe<n1>:VOLTage:APERTure](#) on page 931

SENSe<n1>:FUNCTION:DCSuppression <dcsuppression>

Parameters:

<dcsuppression> ON | OFF

Manual operation: See "DC Suppress" on page 464
 See "DC Suppress" on page 491
 See "DC Suppress" on page 532

7.9.2 S/N Sequence in Level Measurements

SENSe<n1>:FUNction:SNSequence <snsequence>

Parameters:

<snsequence> ON | OFF

Manual operation: See "[S/N Sequence](#)" on page 494

7.10 Distortion Measurements

7.10.1 General Settings

- [MMEMory:LOAD:IEQualize](#) on page 936
- [SENSe<n1>:FUNction:BARGraph](#) on page 936
- [SENSe<n1>:FUNction:FFT:STATe](#) on page 937
- [SENSe<n1>:FUNction:REFNment](#) on page 937
- [SENSe<n1>:VOLTage:EQUalize](#) on page 937
- [MMEMory:LOAD:IEQualize](#) on page 936
- [SENSe<n1>:FUNction:BARGraph](#) on page 936
- [SENSe<n1>:FUNction:DMODE](#) on page 931
- [SENSe<n1>:FUNction:FFT:STATe](#) on page 937
- [SENSe<n1>:FUNction:REFNment](#) on page 937
- [SENSe<n1>:VOLTage:EQUalize](#) on page 937

MMEMory:LOAD:IEQualize <iequalize>

Parameters:

<iequalize> string

Manual operation: See "[Equalizer](#)" on page 497
 See "[Equalizer](#)" on page 523
 See "[Equalizer](#)" on page 534

SENSe<n1>:FUNction:BARGraph <bargraph>

Parameters:

<bargraph> ON | OFF

Manual operation: See "[Bargraph](#)" on page 498
 See "[Bargraph](#)" on page 524

SENSe<n1>:FUNction:FFT:STATe <state>**Parameters:**

<state> ON | OFF

Manual operation: See "Post FFT " on page 524
See "Post FFT " on page 529

SENSe<n1>:FUNction:REFNment <refnment>**Parameters:**

<refnment> N1 | N2 | N4 | N8

Manual operation: See "Refinement" on page 503

SENSe<n1>:VOLTage:EQualize <equalize>**Parameters:**

<equalize> ON | OFF

Manual operation: See "Equalizer " on page 497
See "Equalizer " on page 523
See "Equalizer" on page 534

7.10.2 THD

- [SENSe<n1>:FUNction](#) on page 929
- [SENSe<n1>:FUNction:DIS TORTion<n3>](#) on page 937
- [SENSe<n1>:FUNction:MMODE](#) on page 931
- [SENSe<n1>:VOLTage:FUNDamental](#) on page 937
- [SENSe<n1>:VOLTage:FUNDamental:MODE](#) on page 938

SENSe<n1>:FUNction:DIS TORTion<n3> <distortion>**Parameters:**

<distortion> ON | OFF

Manual operation: See "Even Harmonics " on page 502
See "Odd Harmonics " on page 502

SENSe<n1>:VOLTage:FUNDamental <fundamental>**Parameters:**

<fundamental> float

Manual operation: See "Fundamental " on page 502
See "Fundamental " on page 509

SENSe<n1>:VOLTage:FUNDamental:MODE <mode>

Parameters:

<mode> AUTO | GENTrack | SOURce | VALue | FIXed

Manual operation: See "Fundamental " on page 502
 See "Fundamental " on page 509

7.10.3 THD+N / SINAD

- [SENSe<n1>:FILTer<n2>](#) on page 958
- [SENSe<n1>:FREQuency:LIMit:LOWer](#) on page 938
- [SENSe<n1>:FREQuency:LIMit:UPPer](#) on page 938
- [SENSe<n1>:FUNctIon](#) on page 929
- [SENSe<n1>:FUNctIon:APERTure:MODE](#) on page 930
- [SENSe<n1>:FUNctIon:MMODE](#) on page 931
- [SENSe<n1>:THDN:REJection](#) on page 938
- [SENSe<n1>:VOLTage:FUNDamental](#) on page 937
- [SENSe<n1>:VOLTage:FUNDamental:MODE](#) on page 938

SENSe<n1>:FREQuency:LIMit:LOWer <lower>

Parameters:

<lower> float

Manual operation: See "Frq Lim Low" on page 484
 See "Frq Lim Low " on page 510
 See "Frq Lim Low" on page 523
 See "Freq Lim Low" on page 536
 See "Frq Lim Low / Frq Lim Upp" on page 573

SENSe<n1>:FREQuency:LIMit:UPPer <upper>

Parameters:

<upper> float

Manual operation: See "Frq Lim Upp" on page 485
 See "Frq Lim Upp " on page 511
 See "Frq Lim Upp" on page 524
 See "Freq Lim Upp" on page 536
 See "Frq Lim Low / Frq Lim Upp" on page 573

SENSe<n1>:THDN:REJection <rejection>

Parameters:

<rejection> NARRow | WIDE

Manual operation: See "Rejection " on page 507

7.10.4 MOD DIST

- [SENSe<n1>:FUNction](#) on page 929

7.10.5 DFD

- [SENSe<n1>:FUNction](#) on page 929
- [SENSe<n1>:FUNction:MMODE](#) on page 931

7.10.6 DIM (dynamic intermodulation distortion analysis)

- [SENSe<n1>:FUNction](#) on page 929

7.11 Polarity Measurement

- [SENSe<n1>:FUNction](#) on page 929

7.12 Frequency Band Analysis

Frequency Band Analysis requires R&S UPV-K6

7.12.1 Nth Octave Analysis

- [MMEMory:LOAD:IEQualize](#) on page 936
- [SENSe<n1>:FILTer<n2>](#) on page 958
- [SENSe<n1>:FREQuency:LIMit:LOWer](#) on page 938
- [SENSe<n1>:FREQuency:LIMit:UPPer](#) on page 938
- [SENSe<n1>:FUNction](#) on page 929
- [SENSe<n1>:FUNction:APERTure:MODE](#) on page 930
- [SENSe<n1>:FUNction:BARGraph](#) on page 936
- [SENSe<n1>:FUNction:FFT:STATE](#) on page 937
- [SENSe<n1>:FUNction:FFT:SIZE](#) on page 941
- [SENSe<n1>:FUNction:MMODE](#) on page 931
- [SENSe<n1>:VOLTage:APERTure](#) on page 931
- [SENSe<n1>:VOLTage:EQUalize](#) on page 937

7.13 FFT Analysis

The FFT analysis (Fast Fourier Transformation) allows the input signal to be displayed in the spectral range (frequency range).

- [MMEMory:LOAD:IEQualize](#) on page 936
- [SENSe<n1>:CHANnel:DELay](#) on page 940
- [SENSe<n1>:FILTer<n2>](#) on page 958
- [SENSe<n1>:FREQuency:LIMit](#) on page 940
- [SENSe<n1>:FREQuency:LIMit:LOWer](#) on page 938
- [SENSe<n1>:FREQuency:LIMit:UPPer](#) on page 938
- [SENSe<n1>:FUNctIon](#) on page 929
- [SENSe<n1>:FUNctIon:DCSuppression](#) on page 935
- [SENSe<n1>:FUNctIon:FFT:AVERage](#) on page 941
- [SENSe<n1>:FUNctIon:FFT:AVERage:MODE](#) on page 941
- [SENSe<n1>:FUNctIon:FFT:CMpFactor](#) on page 941
- [SENSe<n1>:FUNctIon:FFT:MTIME?](#) on page 941
- [SENSe<n1>:FUNctIon:FFT:RESolution?](#) on page 941
- [SENSe<n1>:FUNctIon:FFT:SIZE](#) on page 941
- [SENSe<n1>:FUNctIon:FFT:SPAN](#) on page 942
- [SENSe<n1>:FUNctIon:FFT:STATe](#) on page 937
- [SENSe<n1>:FUNctIon:FFT:START?](#) on page 942
- [SENSe<n1>:FUNctIon:FFT:STOP?](#) on page 942
- [SENSe<n1>:FUNctIon:FFT:TRIGgered](#) on page 942
- [SENSe<n1>:FUNctIon:FFT:USAMple](#) on page 942
- [SENSe<n1>:FUNctIon:FFT:WINDow](#) on page 942
- [SENSe<n1>:NOTCh](#) on page 942
- [SENSe<n1>:NOTCh:FREQuency](#) on page 943
- [SENSe<n1>:NOTCh:FREQuency:MODE](#) on page 943
- [SENSe<n1>:VOLTage:EQUalize](#) on page 937

SENSe<n1>:CHANnel:DELay <delay>

Parameters:

<delay> float

Manual operation: See "[Delay Ch1, Delay Ref Chan](#)" on page 532

SENSe<n1>:FREQuency:LIMit <limit>

Parameters:

<limit> ON | OFF

Manual operation: See ["Freq Limit"](#) on page 535

SENSe<n1>:FUNcTion:FFT:AVERAge <average>

Parameters:

<average> integer

Manual operation: See ["Avg Count "](#) on page 537

SENSe<n1>:FUNcTion:FFT:AVERAge:MODE <mode>

Parameters:

<mode> OFF | NORMAl | EXPonential

Manual operation: See ["Avg Mode "](#) on page 536

SENSe<n1>:FUNcTion:FFT:CMpFactor <cmpfactor>

Parameters:

<cmpfactor> integer

Manual operation: See ["Comp Factor"](#) on page 540

SENSe<n1>:FUNcTion:FFT:MTIME?

Return values:

<argument> integer

Usage: Query only

Manual operation: See ["Meas Time"](#) on page 541

SENSe<n1>:FUNcTion:FFT:RESolution?

Return values:

<argument> float

Usage: Query only

Manual operation: See ["Resolution"](#) on page 541

SENSe<n1>:FUNcTion:FFT:SIZE <size>

Parameters:

<size> S512 | S1K | S2K | S4K | S8K | S16K | S32K | S64K | S128K | S256K

Manual operation: See ["FFT Size "](#) on page 525
See ["FFT Size"](#) on page 527

SENSe<n1>:FUNcTion:FFT:SPAN **Parameters:**

 R2 | R4 | R8 | R16 | R32 | R64 | R128 | R256

Manual operation: See "[Span](#)" on page 540

SENSe<n1>:FUNcTion:FFT:START?**Return values:**

<argument> float

Usage: Query only**Manual operation:** See "[Start](#)" on page 540

SENSe<n1>:FUNcTion:FFT:STOP?**Return values:**

<argument> float

Usage: Query only**Manual operation:** See "[Stop](#)" on page 541

SENSe<n1>:FUNcTion:FFT:TRIGgered <triggered>**Parameters:**

<triggered> ON | OFF

Manual operation: See "[triggered](#)" on page 537

SENSe<n1>:FUNcTion:FFT:USAMple <state>**Parameters:**

<state> ON | OFF

Manual operation: See "[Undersample](#)" on page 537

SENSe<n1>:FUNcTion:FFT:WINDow <window>**Parameters:**

<window> RECTangular | HANN | HAMMING | BLACKman_harris | RIF1 | RIF2 | RIF3 | FLATtop

Manual operation: See "[Window](#)" on page 528

SENSe<n1>:NOTCh <notch>**Parameters:**

<notch> OFF | DB0 | DB12 | DB30

Manual operation: See ["Notch\(Gain\)"](#) on page 464
See ["Notch\(Gain\)"](#) on page 533

SENSe<n1>:NOTCh:FREQUency <frequency>

Parameters:

<frequency> float

Manual operation: See ["Notch Freq"](#) on page 533

SENSe<n1>:NOTCh:FREQUency:MODE <mode>

Parameters:

<mode> AUTO | SOURce | GENTrack | FIXed | VALue

Manual operation: See ["Notch Freq"](#) on page 465
See ["Notch Freq"](#) on page 533

7.14 Speech Quality Measurements (PESQ)

PESQ measurements require the following settings:

- generator "Bandwidth = Play Auto"(OUTPut: BANDwidth:MODE AUTO),
- generator function "Play" (SOURce: FUNCTION:SHAPE PLAY)
- analyzer "Single Channel" INPut: CHANnel CH1 | CH2 with "Fix Range" (SENSe: VOLTage: RANGE:MODE FIXed).
- [MMEMory:LOAD:PWAVEform](#) on page 943
- [MMEMory:STORE:PWAVEform](#) on page 944
- [SENSe<n1>:FILTer<n2>](#) on page 958
- [SENSe<n1>:FUNCTION](#) on page 929
- [SENSe<n1>:FUNCTION:MMODE](#) on page 931
- [SENSe<n1>:FUNCTION:PESQ:ACCording](#) on page 944
- [SENSe<n1>:FUNCTION:PESQ:AVGDelay?](#) on page 944
- [SENSe<n1>:FUNCTION:PESQ:DEGLLevel?](#) on page 944
- [SENSe<n1>:FUNCTION:PESQ:REFLevel?](#) on page 944
- [SENSe<n1>:FUNCTION:RECORD:LENGTH](#) on page 952

MMEMory:LOAD:PWAVEform <pwaveform>

Parameters:

<pwaveform> string

Manual operation: See ["File Name"](#) on page 550
See ["File Name"](#) on page 557
See ["File Name"](#) on page 565

MMEMory:STORe:PWAVeform <pwaveform>**Parameters:**

<pwaveform> string

Manual operation: See ["Store WAV to"](#) on page 550
See ["Store WAV to"](#) on page 557
See ["Store WAV to"](#) on page 565
See ["Store Wav to"](#) on page 570

SENSe<n1>:FUNction:PESQ:ACCording <according>**Parameters:**<according> PP862 | PPSI862 | PSILence | PPSP862 | PSPeach | MP8621 |
MPSI8621 | MPSP8621 | MP8622 | MPSI8622 | MPSP8622**Manual operation:** See ["According to "](#) on page 548

SENSe<n1>:FUNction:PESQ:AVGDelay?**Return values:**

<argument> integer

Usage: Query only**Manual operation:** See ["Avg Delay"](#) on page 551

SENSe<n1>:FUNction:PESQ:DEGLLevel?**Return values:**

<argument> integer

Usage: Query only**Manual operation:** See ["Deg Level"](#) on page 551

SENSe<n1>:FUNction:PESQ:REFLevel?**Return values:**

<argument> integer

Usage: Query only**Manual operation:** See ["Ref Level"](#) on page 551

7.15 Audio quality measurements (PEAQ)

The PEAQ measurement requires the settings bandwidth = PlayAuto or a fixed bandwidth of 22 kHz and generator function Play for the analog generator. The analogue analyzer must be set to dual-channel, with 22 kHz bandwidth and with fixed range (the

same for both channels). In digital domain generator and analyzer must be set to dual-channel and 48 kHz sample rate.

- [MMEMory:LOAD:PWAVeform](#) on page 943
- [MMEMory:STORe:PWAVeform](#) on page 944
- [SENSe<n1>:FILTer<n2>](#) on page 958
- [SENSe<n1>:FUNction](#) on page 929
- [SENSe<n1>:FUNction:MMODE](#) on page 931
- [SENSe<n1>:FUNction:PEAQ:AVGDelay?](#) on page 945
- [SENSe<n1>:FUNction:PEAQ:DEGLLevel?](#) on page 945
- [SENSe<n1>:FUNction:PEAQ:DELDetect](#) on page 945
- [SENSe<n1>:FUNction:PEAQ:REFLevel?](#) on page 945
- [SENSe<n1>:FUNction:PEAQ:VERSion](#) on page 946
- [SENSe<n1>:FUNction:RECOrd:LENGth](#) on page 952

SENSe<n1>:FUNction:PEAQ:AVGDelay?

Return values:

<argument> integer

Usage: Query only

Manual operation: See "[Avg Delay](#)" on page 558

SENSe<n1>:FUNction:PEAQ:DEGLLevel?

Return values:

<argument> integer

Usage: Query only

Manual operation: See "[Deg Level](#)" on page 558

SENSe<n1>:FUNction:PEAQ:DELDetect <deldetect>

Parameters:

<deldetect> float

Manual operation: See "[Delay Detect](#)" on page 558

SENSe<n1>:FUNction:PEAQ:REFLevel?

Return values:

<argument> integer

Usage: Query only

Manual operation: See "[Ref Level](#)" on page 558

SENSe<n1>:FUNction:PEAQ:VERSion <version>

Parameters:

<version> BASic | ADVanced

Manual operation: See "[Version](#)" on page 556

7.16 Objective Listening Measurements (POLQA)

- [MMEMory:LOAD:PWAVEform](#) on page 943
- [MMEMory:STORe:PWAVEform](#) on page 944
- [SENSe<n1>:FILTer<n2>](#) on page 958
- [SENSe<n1>:FUNction](#) on page 929
- [SENSe<n1>:FUNction:MMODE](#) on page 931
- [SENSe<n1>:FUNction:POLQa:ATTenuation?](#) on page 946
- [SENSe<n1>:FUNction:POLQa:AUTogain](#) on page 946
- [SENSe<n1>:FUNction:POLQa:AVGDelay?](#) on page 947
- [SENSe<n1>:FUNction:POLQa:BAND](#) on page 947
- [SENSe<n1>:FUNction:POLQa:DEGLLevel?](#) on page 947
- [SENSe<n1>:FUNction:POLQa:DEGSpratio?](#) on page 947
- [SENSe<n1>:FUNction:POLQa:GAIN](#) on page 947
- [SENSe<n1>:FUNction:RECORD:LENGTH](#) on page 952
- [SENSe<n1>:FUNction:POLQa:MAXDelay?](#) on page 947
- [SENSe<n1>:FUNction:POLQa:MINDelay?](#) on page 948
- [SENSe<n1>:FUNction:POLQa:REFLevel?](#) on page 948
- [SENSe<n1>:FUNction:POLQa:REFSpratio?](#) on page 948
- [SENSe<n1>:FUNction:POLQa:SNRDeg?](#) on page 948
- [SENSe<n1>:FUNction:POLQa:SNRRef?](#) on page 948

SENSe<n1>:FUNction:POLQa:ATTenuation?

Return values:

<argument> integer

Usage: Query only

Manual operation: See "[Attenuation](#)" on page 567

SENSe<n1>:FUNction:POLQa:AUTogain <autogain>

Parameters:

<autogain> ON | OFF

Manual operation: See "[Autom. Gain](#)" on page 565

SENSe<n1>:FUNcTion:POLQa:AVGDelay?**Return values:**

<argument> integer

Usage: Query only

Manual operation: See "[Avg Delay](#)" on page 567

SENSe<n1>:FUNcTion:POLQa:BAND <band>**Parameters:**

<band> NARRow | WIDE

Manual operation: See "[Band](#)" on page 564

SENSe<n1>:FUNcTion:POLQa:DEGLLevel?**Return values:**

<argument> integer

Usage: Query only

Manual operation: See "[Deg Level](#)" on page 566

SENSe<n1>:FUNcTion:POLQa:DEGSpratio?**Return values:**

<argument> integer

Usage: Query only

Manual operation: See "[Deg Sp. Ratio](#)" on page 568

SENSe<n1>:FUNcTion:POLQa:GAIN <gain>**Parameters:**

<gain> float

Manual operation: See "[Gain](#)" on page 566

SENSe<n1>:FUNcTion:POLQa:MAXDelay?**Return values:**

<argument> integer

Usage: Query only

Manual operation: See "[Max Delay](#)" on page 568

SENSe<n1>:FUNcTion:POLQa:MINDelay?**Return values:**

<argument> integer

Usage: Query only

Manual operation: See "[Min Delay](#)" on page 568

SENSe<n1>:FUNcTion:POLQa:REFLevel?**Return values:**

<argument> integer

Usage: Query only

Manual operation: See "[Ref Level](#)" on page 566

SENSe<n1>:FUNcTion:POLQa:REFSpratio?**Return values:**

<argument> integer

Usage: Query only

Manual operation: See "[Ref Sp. Ratio](#)" on page 567

SENSe<n1>:FUNcTion:POLQa:SNRDeg?**Return values:**

<argument> integer

Usage: Query only

Manual operation: See "[SNR Degraded](#)" on page 567

SENSe<n1>:FUNcTion:POLQa:SNRRef?**Return values:**

<argument> integer

Usage: Query only

Manual operation: See "[SNR Ref](#)" on page 567

7.17 Chirp Based Measurement

The following commands are required to perform a chirp based measurement.

- [MMEMoRY:STORe:PWAVEform](#) on page 944
- [SOURce:FUNCTion](#) on page 869

- [SOURCE:FILTER](#) on page 960
- [SOURCE:INTERVAL](#) on page 877
- [SOURCE:ONTIME](#) on page 877
- [SOURCE:SWEeP:FREQuency:START](#) on page 889
- [SOURCE:SWEeP:FREQuency:STOP](#) on page 890
- [SOURCE:VOLTage:RMS](#) on page 876
- [SOURCE:VOLTage:TOTal](#) on page 876
- [SOURCE:VOLTage:OFFSet<n3>](#) on page 871
- [SOURCE:VOLTage:OFFSet<n3>:STATe](#) on page 871
- [SENSe<1>CHIRpbased:DISToRTion<di>:SWEeP<n>:A](#) on page 949
- [SENSe<1>CHIRpbased:DISToRTion<di>:SWEeP<n>:B](#) on page 949
- [SENSe<1>CHIRpbased:MMODE:SWEeP<n>:A](#) on page 949
- [SENSe<1>CHIRpbased:MMODE:SWEeP<n>:B](#) on page 949
- [SENSe<1>CHIRpbased:POINts?](#) on page 950
- [SENSe<1>CHIRpbased:RESolution?](#) on page 950
- [SENSe<n1>:FILTer<n2>](#) on page 958
- [SENSe<n1>:FUNction](#) on page 929
- [SENSe<n1>:LIMLower<n2>](#) on page 997
- [SENSe<n1>:LIMLower<n2>:VALue](#) on page 997
- [SENSe<n1>:LIMUpper<n2>](#) on page 997
- [SENSe<n1>:LIMUpper<n2>:VALue](#) on page 997
- [SYSTEM:MEMory:DATA<n3>](#) on page 1016

SENSe<1>CHIRpbased:DISToRTion<di>:SWEeP<n>:A <distortion>

SENSe<1>CHIRpbased:DISToRTion<di>:SWEeP<n>:B <distortion>

Suffix:

<di> 2 ... 9
 harmonics 2 to 9

<n> 1 ... 4
 sweep subsystem 1 to 4

Parameters:

<distortion> **Boolean**
 ON | OFF

Manual operation: See "[Even Harmonics, Odd Harmonics](#)" on page 572

SENSe<1>CHIRpbased:MMODE:SWEeP<n>:A <mmode>

SENSe<1>CHIRpbased:MMODE:SWEeP<n>:B <mmode>

Suffix:

<n> 1 ... 4

Parameters:

<mmode> FRQResponse | PHAResponse | THDLevel | THD

Manual operation: See "[Fct SwpXTrY](#)" on page 571

SENSe<1>CHIRpbased:POINts?**Parameters:**

<points> <points>
float
 unit = Hz

Usage: Query only

Manual operation: See "[Points](#)" on page 571

SENSe<1>CHIRpbased:RESolution?**Parameters:**

<resolution> <resolution>
integer

Usage: Query only

Manual operation: See "[Resolution](#)" on page 571

7.18 Analysis in the Time Domain

In addition to analysis in the frequency domain, the R&S UPV can also be used to analyze input signals in the time domain. Time and frequency-domain analyses can be performed simultaneously and irrespective of the selected measurement function.

SENSe7:FUNCTion:

Analysis in the time domain is selected by using suffix 7 at the SENSe7:FUNCTion command.

- [SENSe7:CMPFactor](#) on page 951
- [SENSe<n1>:FUNCTion](#) on page 929
- [SENSe7:MMODE](#) on page 951
- [SENSe7:TRIGger:AUTO](#) on page 951
- [SENSe7:TRIGger:LEVel](#) on page 951
- [SENSe7:TRIGger:PRE](#) on page 951
- [SENSe7:TRIGger:SLOPe](#) on page 951
- [SENSe7:TRIGger:SOURce](#) on page 951
- [SENSe7:TRIGger:TRCLength](#) on page 952

SENSe7:CMPFactor <cmpfactor>**Parameters:**

<cmpfactor> integer

Manual operation: See ["Comp Factor"](#) on page 579

SENSe7:MMODE <mmode>**Parameters:**

<mmode> STANdard | COMPressed | USAMple

Manual operation: See ["Meas Mode "](#) on page 578

SENSe7:TRIGger:AUTO <state>**Parameters:**

<state> ON | OFF

Manual operation: See ["Autotrigger"](#) on page 583

SENSe7:TRIGger:LEVel <level>**Parameters:**

<level> float

Manual operation: See ["Trigger Level "](#) on page 582

SENSe7:TRIGger:PRE <pre>**Parameters:**

<pre> float

Manual operation: See ["Pretrigger"](#) on page 583

SENSe7:TRIGger:SLOPe <slope>**Parameters:**

<slope> RISing | FALLing

Manual operation: See ["Trigger Slope"](#) on page 582

SENSe7:TRIGger:SOURce <source>**Parameters:**

<source> CH1 | CH2 | MANual | GENBurst | TRGChannel

Manual operation: See ["Trigger Source "](#) on page 580

SENSe7:TRIGger:TRCLength <trclength>

Parameters:

<trclength> float

Manual operation: See ["Trace Length"](#) on page 579

7.19 Offline Analysis

- [SENSe<n1>:FUNction](#) on page 929
- [SENSe<n1>:FILTer<n2>](#) on page 958
- [SENSe<n1>:FUNction:RECOrd:BPS](#) on page 952
- [SENSe<n1>:FUNction:RECOrd:FILE](#) on page 952
- [SENSe<n1>:FUNction:RECOrd:FLENGth?](#) on page 952
- [SENSe<n1>:FUNction:RECOrd:LENGth](#) on page 952
- [SENSe<n1>:FUNction:RECOrd:TRIGger:LEVel](#) on page 953
- [SENSe<n1>:FUNction:RECOrd:TRIGger:PRE](#) on page 953
- [SENSe<n1>:FUNction:RECOrd:TRIGger:SLOPe](#) on page 953
- [SENSe<n1>:FUNction:RECOrd:TRIGger:SOURce](#) on page 953

SENSe<n1>:FUNction:RECOrd:BPS <bps>

Parameters:

<bps> AUTO | L8 | L16 | L32

Manual operation: See ["Bits per Sample"](#) on page 593

SENSe<n1>:FUNction:RECOrd:FILE <file>

Parameters:

<file> string

Manual operation: See ["Record File"](#) on page 592

SENSe<n1>:FUNction:RECOrd:FLENGth?

Return values:

<argument> integer

Usage: Query only

Manual operation: See ["File Length"](#) on page 594

SENSe<n1>:FUNction:RECOrd:LENGth <length>

Parameters:

<length> float

Manual operation: See ["Record Length"](#) on page 550
 See ["Record Length"](#) on page 558
 See ["Record Length"](#) on page 566
 See ["Record Length"](#) on page 593

SENSe<n1>:FUNction:RECOrd:TRIGger:LEVel <level>

Parameters:

<level> float

Manual operation: See ["Trigger Level "](#) on page 595

SENSe<n1>:FUNction:RECOrd:TRIGger:PRE <pre>

Parameters:

<pre> float

Manual operation: See ["Pretrigger"](#) on page 596

SENSe<n1>:FUNction:RECOrd:TRIGger:SLOPe <slope>

Parameters:

<slope> RiSing | FALLing

Manual operation: See ["Trigger Slope "](#) on page 595

SENSe<n1>:FUNction:RECOrd:TRIGger:SOURce <source>

Parameters:

<source> CH1 | CH2 | MANual | GENBurst

Manual operation: See ["Trigger Source "](#) on page 594

7.20 Protocol Analysis

Protocol analysis is selected by using suffix 8 at the `SENSe8:FUNction` command.

- [SENSe<n1>:FUNction](#) on page 929
- [SENSe8:PROTOcol:DISPlay](#) on page 954
- [SENSe8:PROTOcol:MODE](#) on page 954
- [SENSe8:PROTOcol:HIGHlight](#) on page 954
- [SENSe8:PROTOcol:PERSistence](#) on page 954
- [SENSe8:PROTOcol:VIEW](#) on page 954

SENSe8:PROTocol:DISPlay <display>**Parameters:**

<display> ON | OFF

Manual operation: See "[Prot Analysis](#)" on page 602

SENSe8:PROTocol:MODE <mode>**Parameters:**

<mode> AUTomatic | CONSUMER | PROfessional | FILE

Manual operation: See "[Display Mode](#)" on page 602

SENSe8:PROTocol:HIGHLIGHT <highlight>**Parameters:**

<highlight> NOTHing | FOUTput | BETWen | FSTart

Manual operation: See "[Highlight](#)" on page 603

SENSe8:PROTocol:PERSistence <persistence>**Parameters:**

<persistence> SHORt | LONG | FORever

Manual operation: See "[Persistence](#)" on page 603

SENSe8:PROTocol:VIEW <view>**Parameters:**

<view> BINText | BINonly

Manual operation: See "[View Mode](#)" on page 604

7.21 Frequency, Phase and Group Delay Measurement

SENSe3: . . . :

Frequency, phase and group delay measurement is selected by using suffix 3 at the SENSe3: . . . commands.

- [SENSe3:FREQuency:APERTure:MODE](#) on page 955
- [SENSe<n1>:FUNCTion](#) on page 929
- [SENSe3:PHASe:FORMat](#) on page 955

SENSe3:FREQuency:APERture:MODE <mode>**Parameters:**

<mode> PRECision | FAST

Manual operation: See "[Meas Time](#)" on page 609

SENSe3:PHASe:FORMat <format>**Parameters:**

<format> POSitive | POSNegative | NEGative | RAD | RADBipolar |
RADNegative | INFinite

Manual operation: See "[Format Phase](#)" on page 610

7.22 Input and Level Monitor

SENSe2: . . . :

Input monitor is selected by using suffix 2 at the `SENSe<n1>:FUNCTION` command.

SENSe6: . . . :

Level monitor is selected by using suffix 6 at the `SENSe<n1>:FUNCTION` command.

- [SENSe<n1>:FUNCTION](#) on page 929

7.23 Settling Methods

The commands are assigned as follows:

- `SENSe:FUNCTION: . . .`
Settling of the measurement function
- `SENSe:FREQuency: . . .`
Settling of the frequency measurement
- `SENSe:PHASe: . . .`
Settling of the phase measurement
- `SENSe:TRIGger: . . .`
Settling of the start conditions (event-triggered measurements)
- [SENSe<n1>:FREQuency:SETTling:COUNT](#) on page 956
- [SENSe<n1>:FREQuency:SETTling:MODE](#) on page 956
- [SENSe<n1>:FREQuency:SETTling:RESolution](#) on page 956
- [SENSe<n1>:FREQuency:SETTling:TOLerance](#) on page 956
- [SENSe<n1>:FREQuency:SETTling:TOUT](#) on page 957
- [SENSe<n1>:FUNCTION:SETTling:COUNT](#) on page 956
- [SENSe<n1>:FUNCTION:SETTling:MODE](#) on page 956

- [SENSe<n1>:FUNCTION:SETTLing:RESolution](#) on page 956
- [SENSe<n1>:FUNCTION:SETTLing:TOLerance](#) on page 956
- [SENSe<n1>:FUNCTION:SETTLing:TOUT](#) on page 957
- [SENSe<n1>:PHASe:SETTLing:COUNT](#) on page 956
- [SENSe<n1>:PHASe:SETTLing:MODE](#) on page 956
- [SENSe<n1>:PHASe:SETTLing:RESolution](#) on page 956
- [SENSe<n1>:PHASe:SETTLing:TOUT](#) on page 957
- [SENSe<n1>:TRIGger:SETTLing:COUNT](#) on page 956
- [SENSe<n1>:TRIGger:SETTLing:MODE](#) on page 956
- [SENSe<n1>:TRIGger:SETTLing:RESolution](#) on page 956
- [SENSe<n1>:TRIGger:SETTLing:TOLerance](#) on page 956

SENSe<n1>:FUNCTION:SETTLing:COUNT <count>
SENSe<n1>:FREQuency:SETTLing:COUNT <count>
SENSe<n1>:PHASe:SETTLing:COUNT <count>
SENSe<n1>:TRIGger:SETTLing:COUNT <count>

Parameters:

<count> integer

Manual operation: See "[Samples](#)" on page 624

SENSe<n1>:FUNCTION:SETTLing:MODE <mode>
SENSe<n1>:FREQuency:SETTLing:MODE <mode>
SENSe<n1>:PHASe:SETTLing:MODE <mode>
SENSe<n1>:TRIGger:SETTLing:MODE <mode>

Parameters:

<mode> OFF | EXPonential | FLAT | AVERage

Manual operation: See "[Settling](#)" on page 623

SENSe<n1>:FUNCTION:SETTLing:RESolution <resolution>
SENSe<n1>:FREQuency:SETTLing:RESolution <resolution>
SENSe<n1>:PHASe:SETTLing:RESolution <resolution>
SENSe<n1>:TRIGger:SETTLing:RESolution <resolution>

Parameters:

<resolution> float

Manual operation: See "[Resolution](#)" on page 625

SENSe<n1>:FUNCTION:SETTLing:TOLerance <tolerance>
SENSe<n1>:FREQuency:SETTLing:TOLerance <tolerance>
SENSe<n1>:TRIGger:SETTLing:TOLerance <tolerance>

Parameters:

<tolerance> float

Manual operation: See "[Tolerance](#)" on page 625

SENSe<n1>:FUNctIon:SETTLing:TOUT <tout>
SENSe<n1>:FREQuency:SETTLing:TOUT <tout>
SENSe<n1>:PHASe:SETTLing:TOUT <tout>
Parameters:
 <tout> float
Manual operation: See "[Timeout](#)" on page 622

7.24 Filters

The R&S UPV offers several position to switch on predefined filters:

- Analyzer pre-filter
 command `INPut:FILTer`
 This filter is inserted prior to the analysis functions.
- Analyzer function filter
 command `SENSe:FILTer<n2>`.
 Depending on the instrument and the active analyzer function, up to three filters can be connected in series. They are selected by suffix <n2>.
- Generator function filter
 - command `SOURce:FILTer`
 for several generator functions
 - command `SOURce:STEReo2:FILTer`
 for generator function "Stereo Sine".

The `SENSe:UFILter` command is used to configure user filters. The user defined filters can be used for the generator and analyzer functions.

- [INPut<n1>:FILTer](#) on page 958
- [SENSe<n1>:FILTer<n2>](#) on page 958
- [SENSe<n1>:UFILter<n2>](#) on page 958
- [SENSe<n1>:UFILter<n2>:ATTenuation](#) on page 959
- [SENSe<n1>:UFILter<n2>:CENTer](#) on page 959
- [SENSe<n1>:UFILter<n2>:DELay](#) on page 959
- [SENSe<n1>:UFILter<n2>:FNAMe](#) on page 959
- [SENSe<n1>:UFILter<n2>:ORDer](#) on page 959
- [SENSe<n1>:UFILter<n2>:PASSb](#) on page 959
- [SENSe<n1>:UFILter<n2>:PASSb:LOWer](#) on page 959
- [SENSe<n1>:UFILter<n2>:PASSb:UPPer](#) on page 960
- [SENSe<n1>:UFILter<n2>:STOPb](#) on page 960
- [SENSe<n1>:UFILter<n2>:STOPb:LOWer](#) on page 960
- [SENSe<n1>:UFILter<n2>:STOPb:UPPer](#) on page 960
- [SENSe<n1>:UFILter<n2>:WIDTh](#) on page 960
- [SOURce:FILTer](#) on page 960

- [SOURce: MCHannel<n2>: FILTER](#) on page 961
- [SOURce: STEReo<n2>: FILTER](#) on page 961

INPut<n1>:FILTer <filter>

see also [chapter 5.43, "Filter"](#), on page 626

Parameters:

<filter> OFF | UFIL1 | UFIL2 | UFIL3 | UFIL4 | UFIL5 | UFIL6 | UFIL7 | UFIL8 | UFIL9 | AWE | CARM | CCIU | CCIR | CCIT | CMES | DEMP17 | DCN | DEMP5015 | DEMP75 | IECT | JITT | PEMP17 | PEMP50 | PEMP5015 | PEMP75 | HP22 | HP400 | LP22 | LP30 | LP80 | AES17 | CWE | URUM | WRUM

Manual operation: See ["Pre Filter"](#) on page 368
 See ["Pre Filter"](#) on page 380
 See ["Pre Filter"](#) on page 391
 See ["Pre Filter"](#) on page 396
 See ["Pre Filter"](#) on page 410
 See ["Pre Filter"](#) on page 424
 See ["Pre Filter"](#) on page 433

SENSe<n1>:FILTer<n2> <filter>
Suffix:

<n2> Selects the number of filters looped into the measurement path, maximum is 3.

Parameters:

<filter> OFF | UFIL1 | UFIL2 | UFIL3 | UFIL4 | UFIL5 | UFIL6 | UFIL7 | UFIL8 | UFIL9 | AWE | CARM | CCIU | CCIR | CCIT | CMES | DEMP17 | DCN | DEMP5015 | DEMP75 | IECT | JITT | PEMP17 | PEMP50 | PEMP5015 | PEMP75 | HP22 | HP400 | LP22 | LP30 | LP80 | AES17 | CWE | URUM | WRUM

Manual operation: See ["Filter"](#) on page 466
 See ["Filter"](#) on page 491
 See ["Filter"](#) on page 509
 See ["Filter"](#) on page 522
 See ["Filter "](#) on page 534
 See ["Filter"](#) on page 551
 See ["Filter"](#) on page 559
 See ["Filter"](#) on page 568
 See ["Filter "](#) on page 573
 See ["Filter "](#) on page 596

SENSe<n1>:UFILter<n2> <ufilter>
Parameters:

<ufilter> HPASs | LPASs | BPASs | BSTop | BSTOp | NOTCh | TOCTave | FILE

Manual operation: See ["Filters 01 to 09"](#) on page 629

SENSe<n1>:UFILter<n2>:ATTenuation <attenuation>

Parameters:

<attenuation> float

Manual operation: See ["Attenuation"](#) on page 636

SENSe<n1>:UFILter<n2>:CENTer <center>

Parameters:

<center> float

Manual operation: See ["Center Freq"](#) on page 633

SENSe<n1>:UFILter<n2>:DELay <delay>

Parameters:

<delay> float

Manual operation: See ["Delay"](#) on page 636

SENSe<n1>:UFILter<n2>:FNAMe <fname>

Parameters:

<fname> string

Manual operation: See ["File Def Filter"](#) on page 634

SENSe<n1>:UFILter<n2>:ORDer <order>

Parameters:

<order> N4 | N8

Manual operation: See ["Order"](#) on page 630

SENSe<n1>:UFILter<n2>:PASSb <passb>

Parameters:

<passb> float

Manual operation: See ["Passband"](#) on page 631

SENSe<n1>:UFILter<n2>:PASSb:LOWer <lower>

Parameters:

<lower> float

Manual operation: See ["Passb Low"](#) on page 632

SENSe<n1>:UFILter<n2>:PASSb:UPPer <upper>

Parameters:

<upper> float

Manual operation: See "[Passb Upp](#)" on page 632

SENSe<n1>:UFILter<n2>:STOPb <stopb>

Parameters:

<stopb> float

Manual operation: See "[Stopband](#)" on page 631

SENSe<n1>:UFILter<n2>:STOPb:LOWer <lower>

Parameters:

<lower> float

Manual operation: See "[Stopb Low](#)" on page 632
See "[Stopb Low](#)" on page 634

SENSe<n1>:UFILter<n2>:STOPb:UPPer <upper>

Parameters:

<upper> float

Manual operation: See "[Stopb Upp](#)" on page 632
See "[Stopb Upp](#)" on page 634

SENSe<n1>:UFILter<n2>:WIDTh <width>

Parameters:

<width> float

Manual operation: See "[Width](#)" on page 634

SOURce:FILTer <filter>

Parameters:

<filter> OFF | UFIL1 | UFIL2 | UFIL3 | UFIL4 | UFIL5 | UFIL6 | UFIL7 | UFIL8 | UFIL9 | AWE | CARM | CCIU | CCIR | CCIT | CMES | DEMP17 | DCN | DEMP5015 | DEMP75 | IECT | JITT | PEMP17 | PEMP50 | PEMP5015 | PEMP75 | HP22 | HP400 | LP22 | LP30 | LP80 | AES17 | CWE | URUM | WRUM

Manual operation: See "Filter" on page 289
 See "Filter / Filter Ch1" on page 293
 See "Filter" on page 296
 See "Filter " on page 299
 See "Filter " on page 302
 See "Filter " on page 304
 See "Filter " on page 306
 See "Filter " on page 315
 See "Filter " on page 317
 See "Filter / Filter Ch1" on page 323
 See "Filter" on page 330
 See "Filter " on page 333
 See "Filter" on page 338

SOURce: MCHannel<n2>:FILTer <filter>

Parameters:

<filter> OFF | UFIL1 | UFIL2 | UFIL3 | UFIL4 | UFIL5 | UFIL6 | UFIL7 |
 UFIL8 | UFIL9 | AWE | CARM | CCIU | CCIR | CCIT | CMES |
 DEMP17 | DCN | DEMP5015 | DEMP75 | IECT | JITT |
 PEMP17 | PEMP50 | PEMP5015 | PEMP75 | HP22 | HP400 |
 LP22 | LP30 | LP80 | AES17 | CWE | URUM | WRUM

SOURce: STEReo<n2>:FILTer <filter>

Suffix:

<n2> 1 | 2
 1 = filter for channel 1 of generator function "Stereo Sine". Com-
 mand SOURce.STEReo1:FILTer is an alias to command
 SOURce:FILTer.
 2 = filter for channel 2 of generator function "Stereo Sine".

Parameters:

<filter> OFF | UFIL1 | UFIL2 | UFIL3 | UFIL4 | UFIL5 | UFIL6 | UFIL7 |
 UFIL8 | UFIL9 | AWE | CARM | CCIU | CCIR | CCIT | CMES |
 DEMP17 | DCN | DEMP5015 | DEMP75 | IECT | JITT |
 PEMP17 | PEMP50 | PEMP5015 | PEMP75 | HP22 | HP400 |
 LP22 | LP30 | LP80 | AES17 | CWE | URUM | WRUM

Manual operation: See "Filter Ch2" on page 293
 See "Filter Ch2" on page 323

7.25 Audio Monitoring

Various functionalities are brought together in the *AUXiliaries* subsystem:

- Audio Monitor
- Analog Aux Output

- Trigger Output
- Trigger Input
- [AUXiliaries:AAUXout](#) on page 962
- [AUXiliaries:AUDMonitor](#) on page 962
- [AUXiliaries:DCValue](#) on page 962
- [AUXiliaries:PHONe](#) on page 962
- [AUXiliaries:PHPermanent](#) on page 963
- [AUXiliaries:SPEaker:CHANnel](#) on page 963
- [AUXiliaries:SPEaker:SOURce](#) on page 963
- [AUXiliaries:SPEaker:STATe](#) on page 963
- [AUXiliaries:SPEaker:VOLume](#) on page 963
- [AUXiliaries:TRIGger:INPut:EDGE](#) on page 963
- [AUXiliaries:TRIGger:INPut:ENABle](#) on page 963
- [AUXiliaries:TRIGger:INPut:MODE](#) on page 964
- [AUXiliaries:TRIGger:OUTPut:EDGE](#) on page 964
- [AUXiliaries:TRIGger:OUTPut:ENABle](#) on page 964
- [AUXiliaries:TRIGger:OUTPut:FREQuency](#) on page 964
- [AUXiliaries:TRIGger:OUTPut:MODE](#) on page 964

AUXiliaries:AAUXout <aauxout>

Parameters:

<aauxout> DC | GENerator | AUDM1

Manual operation: See "[Anlg Aux Out](#) " on page 649

AUXiliaries:AUDMonitor <audmonitor>

Parameters:

<audmonitor> ON | OFF

Manual operation: See "[Audio Monitor](#) " on page 646

AUXiliaries:DCValue <dcvalue>

Parameters:

<dcvalue> float

Manual operation: See "[DC Value](#)" on page 650

AUXiliaries:PHONe <phone>

Parameters:

<phone> integer
 ON | OFF

Manual operation: See ["Phone enable"](#) on page 647

AUXiliaries:PHPermanent <phpermanent>

Parameters:

<phpermanent> integer
 ON | OFF

Manual operation: See ["Phone Aux permanent"](#) on page 647

AUXiliaries:SPEaker:CHANnel <channel>

Parameters:

<channel> STEReo | CH1 | CH2

Manual operation: See ["Channel"](#) on page 648

AUXiliaries:SPEaker:SOURce <source>

Parameters:

<source> INPut | FUNcTION | GENerator

Manual operation: See ["Signal Source"](#) on page 647

AUXiliaries:SPEaker:STATe <state>

Parameters:

<state> integer

Manual operation: See ["Speaker enable"](#) on page 647

AUXiliaries:SPEaker:VOLume <volume>

Parameters:

<volume> integer

Manual operation: See ["Volume"](#) on page 648

AUXiliaries:TRIGger:INPut:EDGE <edge>

Parameters:

<edge> selection

Manual operation: See ["Edge"](#) on page 652

AUXiliaries:TRIGger:INPut:ENABLE <enable>

Parameters:

<enable> integer

Manual operation: See ["Enable"](#) on page 652

AUXiliaries:TRIGger:INPut:MODE <mode>

Parameters:

<mode> MSINgle | MCONtstop | MStArt

Manual operation: See ["Mode"](#) on page 652

AUXiliaries:TRIGger:OUTPut:EDGE <edge>

Parameters:

<edge> RISing | FALLing

Manual operation: See ["Edge"](#) on page 651

AUXiliaries:TRIGger:OUTPut:ENABLE <enable>

Parameters:

<enable> ON | OFF

Manual operation: See ["Enable"](#) on page 650

AUXiliaries:TRIGger:OUTPut:FREQUency <frequency>

Parameters:

<frequency> float

Manual operation: See ["Mode"](#) on page 651

AUXiliaries:TRIGger:OUTPut:MODE <mode>

Parameters:

<mode> MEASuring | AUXClockout

Manual operation: See ["Mode"](#) on page 651

7.26 Switcher

The following commands control the R&S UPZ Audio Switcher. For further information see the operating manual for the R&S UPZ.

- [SWITcher:COMPort](#) on page 965
- [SWITcher:CONNEction](#) on page 965
- [SWITcher:INPA](#) on page 965
- [SWITcher:INPB](#) on page 965
- [SWITcher:OFFSet:BVSA](#) on page 965

- [SWITcher:OFFSet:OVSI](#) on page 965
- [SWITcher:OUTA](#) on page 966
- [SWITcher:OUTB](#) on page 966
- [SWITcher:STATE](#) on page 966
- [SWITcher:TRACking](#) on page 966

SWITcher:COMPort <comport>**Parameters:**

<comport> selection
COM3 | COM4 | COM5 | COM6 | AUTO

Manual operation: See "[COM Port](#)" on page 654

SWITcher:CONNectioN <connection>**Parameters:**

<connection> COM | USB

Manual operation: See "[Connection](#)" on page 654

SWITcher:INPA <inpa>**Parameters:**

<inpa> integer

Manual operation: See "[Input A](#)" on page 657

SWITcher:INPB <inpb>**Parameters:**

<inpb> integer

Manual operation: See "[Input B](#)" on page 657

SWITcher:OFFSet:BVSA <bvsa>**Parameters:**

<bvsa> integer

Manual operation: See "[B vs A](#)" on page 657

SWITcher:OFFSet:OVSI <ovsi>**Parameters:**

<ovsi> integer

Manual operation: See "[Out vs Inp](#)" on page 657

SWITcher:OUTA <outa>**Parameters:**

<outa> integer

Manual operation: See ["Output A"](#) on page 657

SWITcher:OUTB <outb>**Parameters:**

<outb> integer

Manual operation: See ["Output B"](#) on page 658

SWITcher:STATe <state>**Parameters:**

<state> ON | OFF

Manual operation: See ["Switcher"](#) on page 656

SWITcher:TRACking <tracking>**Parameters:**

<tracking> OFF | BVSA | OVSI | ALL

Manual operation: See ["Tracking"](#) on page 656

7.27 Traces, Spectrum Displays and Bargraphs

7.27.1 Display Configuration

The commands are grouped for the following subsystems according to their function:

FFT | WAVEform | BARGraph | PESQ | SWEep .

The value range for suffix <n2> depends on the subsystem:

For the Subsystem Sweep: <n2> = 1 ... 4

For the Subsystem FFT: <n2> = 1 | 2

For the Subsystem BARGraph: <n2> = 1 | 2

For the Subsystems WAVEform: <n2> = 1

For the Subsystems PESQ: <n2> = 1 | 2

- [DISPlay:BARGraph<n2>:A:BOTTom](#) on page 977

- [DISPlay:BARGraph<n2>:A:CHANnel](#) on page 977
- [DISPlay:BARGraph<n2>:A:LAbel:AUTO](#) on page 977
- [DISPlay:BARGraph<n2>:A:LAbel:USER](#) on page 978
- [DISPlay:BARGraph<n2>:A:LEGend:DESCRiption](#) on page 978
- [DISPlay:BARGraph<n2>:A:LEGend:SHOW](#) on page 978
- [DISPlay:BARGraph<n2>:A:LIMLower](#) on page 979
- [DISPlay:BARGraph<n2>:A:LIMLower:SOURce](#) on page 979
- [DISPlay:BARGraph<n2>:A:LIMLower:SOURce:FILE](#) on page 979
- [DISPlay:BARGraph<n2>:A:LIMLower:SOURce:VALue](#) on page 980
- [DISPlay:BARGraph<n2>:A:LIMShift](#) on page 980
- [DISPlay:BARGraph<n2>:A:LIMShift:PARallel](#) on page 980
- [DISPlay:BARGraph<n2>:A:LIMShift:SYMMetrical](#) on page 981
- [DISPlay:BARGraph<n2>:A:LIMUpper](#) on page 981
- [DISPlay:BARGraph<n2>:A:LIMUpper:SOURce](#) on page 981
- [DISPlay:BARGraph<n2>:A:LIMUpper:SOURce:FILE](#) on page 981
- [DISPlay:BARGraph<n2>:A:LIMUpper:SOURce:VALue](#) on page 982
- [DISPlay:BARGraph<n2>:A:NORMalize](#) on page 982
- [DISPlay:BARGraph<n2>:A:NORMalize:VALue](#) on page 982
- [DISPlay:BARGraph<n2>:A:REFerence](#) on page 983
- [DISPlay:BARGraph<n2>:A:REFerence:FILE](#) on page 983
- [DISPlay:BARGraph<n2>:A:REFerence:VALue](#) on page 983
- [DISPlay:BARGraph<n2>:A:SPACing](#) on page 983
- [DISPlay:BARGraph<n2>:A:TOP](#) on page 984
- [DISPlay:BARGraph<n2>:A:UNIT](#) on page 984
- [DISPlay:BARGraph<n2>:A:UNIT:AUTO](#) on page 984
- [DISPlay:BARGraph<n2>:A:UNIT:TRACk](#) on page 985
- [DISPlay:BARGraph<n2>:A:UNIT:USER](#) on page 985
- [DISPlay:BARGraph<n2>:A:UPDate](#) on page 985
- [DISPlay:BARGraph<n2>:A:YSOURce](#) on page 985
- [DISPlay:BARGraph<n2>:A:YSOURce:FILE](#) on page 986
- [DISPlay:BARGraph<n2>:B:BOTTom](#) on page 977
- [DISPlay:BARGraph<n2>:B:CHANnel](#) on page 977
- [DISPlay:BARGraph<n2>:B:LAbel:AUTO](#) on page 977
- [DISPlay:BARGraph<n2>:B:LAbel:USER](#) on page 978
- [DISPlay:BARGraph<n2>:B:LEGend:DESCRiption](#) on page 978
- [DISPlay:BARGraph<n2>:B:LEGend:SHOW](#) on page 978
- [DISPlay:BARGraph<n2>:B:LIMLower](#) on page 979
- [DISPlay:BARGraph<n2>:B:LIMLower:SOURce](#) on page 979

- [DISPlay:BARGraph<n2>:B:LIMLower:SOURce:FILE](#) on page 979
- [DISPlay:BARGraph<n2>:B:LIMLower:SOURce:VALue](#) on page 980
- [DISPlay:BARGraph<n2>:B:LIMShift](#) on page 980
- [DISPlay:BARGraph<n2>:B:LIMShift:PARAllel](#) on page 980
- [DISPlay:BARGraph<n2>:B:LIMShift:SYMMetrical](#) on page 981
- [DISPlay:BARGraph<n2>:B:LIMUpper](#) on page 981
- [DISPlay:BARGraph<n2>:B:LIMUpper:SOURce](#) on page 981
- [DISPlay:BARGraph<n2>:B:LIMUpper:SOURce:FILE](#) on page 982
- [DISPlay:BARGraph<n2>:B:LIMUpper:SOURce:VALue](#) on page 982
- [DISPlay:BARGraph<n2>:B:NORMAlize](#) on page 982
- [DISPlay:BARGraph<n2>:B:NORMAlize:VALue](#) on page 982
- [DISPlay:BARGraph<n2>:B:REFerence](#) on page 983
- [DISPlay:BARGraph<n2>:B:REFerence:FILE](#) on page 983
- [DISPlay:BARGraph<n2>:B:REFerence:VALue](#) on page 983
- [DISPlay:BARGraph<n2>:B:SPACing](#) on page 983
- [DISPlay:BARGraph<n2>:B:TOP](#) on page 984
- [DISPlay:BARGraph<n2>:B:UNIT](#) on page 984
- [DISPlay:BARGraph<n2>:B:UNIT:AUTO](#) on page 984
- [DISPlay:BARGraph<n2>:B:UNIT:TRACk](#) on page 985
- [DISPlay:BARGraph<n2>:B:UNIT:USER](#) on page 985
- [DISPlay:BARGraph<n2>:B:UPDate](#) on page 985
- [DISPlay:BARGraph<n2>:B:YSource](#) on page 985
- [DISPlay:BARGraph<n2>:B:YSource:FILE](#) on page 986
- [DISPlay:BARGraph<n2>:DLISt:FILTer](#) on page 986
- [DISPlay:BARGraph<n2>:MINMax](#) on page 987
- [DISPlay:BARGraph<n2>:MCHMode](#) on page 988
- [DISPlay:BARGraph<n2>:SCANoffset](#) on page 917
- [DISPlay:BARGraph<n2>:TITLe:DESCRiption](#) on page 988
- [DISPlay:BARGraph<n2>:TITLe:SHOW](#) on page 988
- [DISPlay:BARGraph<n2>:TRACk:LIMit](#) on page 988
- [DISPlay:BARGraph<n2>:TRACk:REFerence](#) on page 989
- [DISPlay:BARGraph<n2>:TRACk:SCALing](#) on page 989
- [DISPlay:FFT<n2>:A:BOTTom](#) on page 977
- [DISPlay:FFT<n2>:A:CHANnel](#) on page 977
- [DISPlay:FFT<n2>:A:LABEL:AUTO](#) on page 977
- [DISPlay:FFT<n2>:A:LABEL:USER](#) on page 978
- [DISPlay:FFT<n2>:A:LEGend:DESCRiption](#) on page 978
- [DISPlay:FFT<n2>:A:LEGend:SHOW](#) on page 978

- [DISPlay:FFT<n2>:A:LIMLower](#) on page 979
- [DISPlay:FFT<n2>:A:LIMLower:SOURce](#) on page 979
- [DISPlay:FFT<n2>:A:LIMLower:SOURce:FILE](#) on page 979
- [DISPlay:FFT<n2>:A:LIMLower:SOURce:VALue](#) on page 980
- [DISPlay:FFT<n2>:A:LIMShift](#) on page 980
- [DISPlay:FFT<n2>:A:LIMShift:PARAllel](#) on page 980
- [DISPlay:FFT<n2>:A:LIMShift:SYMMetrical](#) on page 981
- [DISPlay:FFT<n2>:A:LIMUpper](#) on page 981
- [DISPlay:FFT<n2>:A:LIMUpper:SOURce](#) on page 981
- [DISPlay:FFT<n2>:A:LIMUpper:SOURce:FILE](#) on page 981
- [DISPlay:FFT<n2>:A:LIMUpper:SOURce:VALue](#) on page 982
- [DISPlay:FFT<n2>:A:NORMAlize](#) on page 982
- [DISPlay:FFT<n2>:A:NORMAlize:VALue](#) on page 982
- [DISPlay:FFT<n2>:A:REFerence](#) on page 983
- [DISPlay:FFT<n2>:A:REFerence:FILE](#) on page 983
- [DISPlay:FFT<n2>:A:REFerence:VALue](#) on page 983
- [DISPlay:FFT<n2>:A:SPACing](#) on page 983
- [DISPlay:FFT<n2>:A:TOP](#) on page 984
- [DISPlay:FFT<n2>:A:UNIT](#) on page 984
- [DISPlay:FFT<n2>:A:UNIT:AUTO](#) on page 984
- [DISPlay:FFT<n2>:A:UNIT:TRACk](#) on page 985
- [DISPlay:FFT<n2>:A:UNIT:USER](#) on page 985
- [DISPlay:FFT<n2>:A:UPDate](#) on page 985
- [DISPlay:FFT<n2>:A:YSource](#) on page 985
- [DISPlay:FFT<n2>:A:YSource:FILE](#) on page 986
- [DISPlay:FFT<n2>:B:BOTTom](#) on page 977
- [DISPlay:FFT<n2>:B:CHANnel](#) on page 977
- [DISPlay:FFT<n2>:B:LABel:AUTO](#) on page 977
- [DISPlay:FFT<n2>:B:LABel:USER](#) on page 978
- [DISPlay:FFT<n2>:B:LEGend:DESCRiption](#) on page 978
- [DISPlay:FFT<n2>:B:LEGend:SHOW](#) on page 978
- [DISPlay:FFT<n2>:B:LIMLower](#) on page 979
- [DISPlay:FFT<n2>:B:LIMLower:SOURce](#) on page 979
- [DISPlay:FFT<n2>:B:LIMLower:SOURce:FILE](#) on page 979
- [DISPlay:FFT<n2>:B:LIMLower:SOURce:VALue](#) on page 980
- [DISPlay:FFT<n2>:B:LIMShift](#) on page 980
- [DISPlay:FFT<n2>:B:LIMShift:PARAllel](#) on page 980
- [DISPlay:FFT<n2>:B:LIMShift:SYMMetrical](#) on page 981

- [DISPlay:FFT<n2>:B:LIMUpper](#) on page 981
- [DISPlay:FFT<n2>:B:LIMUpper:SOURce](#) on page 981
- [DISPlay:FFT<n2>:B:LIMUpper:SOURce:FILE](#) on page 981
- [DISPlay:FFT<n2>:B:LIMUpper:SOURce:VALue](#) on page 982
- [DISPlay:FFT<n2>:B:NORMAlize](#) on page 982
- [DISPlay:FFT<n2>:B:NORMAlize:VALue](#) on page 982
- [DISPlay:FFT<n2>:B:REFerence](#) on page 983
- [DISPlay:FFT<n2>:B:REFerence:FILE](#) on page 983
- [DISPlay:FFT<n2>:B:REFerence:VALue](#) on page 983
- [DISPlay:FFT<n2>:B:SPACing](#) on page 983
- [DISPlay:FFT<n2>:B:TOP](#) on page 984
- [DISPlay:FFT<n2>:B:UNIT](#) on page 984
- [DISPlay:FFT<n2>:B:UNIT:AUTO](#) on page 984
- [DISPlay:FFT<n2>:B:UNIT:TRACk](#) on page 985
- [DISPlay:FFT<n2>:B:UNIT:USER](#) on page 985
- [DISPlay:FFT<n2>:B:UPDate](#) on page 985
- [DISPlay:FFT<n2>:B:YSource](#) on page 985
- [DISPlay:FFT<n2>:B:YSource:FILE](#) on page 986
- [DISPlay:FFT<n2>:DLISt:FILTer](#) on page 986
- [DISPlay:FFT<n2>:MINMax](#) on page 987
- [DISPlay:FFT<n2>:MCHMode](#) on page 988
- [DISPlay:FFT<n2>:SCANoffset](#) on page 917
- [DISPlay:FFT<n2>:TITLe:DESCRiption](#) on page 988
- [DISPlay:FFT<n2>:TITLe:SHOW](#) on page 988
- [DISPlay:FFT<n2>:TRACk:LIMit](#) on page 988
- [DISPlay:FFT<n2>:TRACk:REFerence](#) on page 988
- [DISPlay:FFT<n2>:TRACk:SCALing](#) on page 989
- [DISPlay:FFT<n2>:X:LABel:AUTO](#) on page 989
- [DISPlay:FFT<n2>:X:LABel:USER](#) on page 989
- [DISPlay:FFT<n2>:X:LEFT](#) on page 989
- [DISPlay:FFT<n2>:X:REFerence:VALue](#) on page 990
- [DISPlay:FFT<n2>:X:RIGHT](#) on page 990
- [DISPlay:FFT<n2>:X:SCALing](#) on page 990
- [DISPlay:FFT<n2>:X:SPACing](#) on page 990
- [DISPlay:FFT<n2>:X:UNIT](#) on page 991
- [DISPlay:FFT<n2>:X:UNIT:AUTO](#) on page 991
- [DISPlay:FFT<n2>:X:UNIT:USER](#) on page 991
- [DISPlay:PESQ<n2>:A:BOTTom](#) on page 977

- [DISPlay:PESQ<n2>:A:LABel:AUTO](#) on page 977
- [DISPlay:PESQ<n2>:A:LABel:USER](#) on page 978
- [DISPlay:PESQ<n2>:A:LEGend:DESCRiption](#) on page 978
- [DISPlay:PESQ<n2>:A:LEGend:SHOW](#) on page 978
- [DISPlay:PESQ<n2>:A:LIMLower](#) on page 979
- [DISPlay:PESQ<n2>:A:LIMLower:SOURce](#) on page 979
- [DISPlay:PESQ<n2>:A:LIMLower:SOURce:FILE](#) on page 979
- [DISPlay:PESQ<n2>:A:LIMLower:SOURce:VALue](#) on page 980
- [DISPlay:PESQ<n2>:A:LIMUpper](#) on page 981
- [DISPlay:PESQ<n2>:A:LIMUpper:SOURce](#) on page 981
- [DISPlay:PESQ<n2>:A:LIMUpper:SOURce:FILE](#) on page 982
- [DISPlay:PESQ<n2>:A:LIMUpper:SOURce:VALue](#) on page 982
- [DISPlay:PESQ<n2>:A:SPACing](#) on page 983
- [DISPlay:PESQ<n2>:A:TOP](#) on page 984
- [DISPlay:PESQ<n2>:A:UPDate](#) on page 985
- [DISPlay:PESQ<n2>:A:YSource](#) on page 986
- [DISPlay:PESQ<n2>:A:YSource:FILE](#) on page 986
- [DISPlay:PESQ<n2>:B:BOTTom](#) on page 977
- [DISPlay:PESQ<n2>:B:LABel:AUTO](#) on page 977
- [DISPlay:PESQ<n2>:B:LABel:USER](#) on page 978
- [DISPlay:PESQ<n2>:B:LEGend:DESCRiption](#) on page 978
- [DISPlay:PESQ<n2>:B:LEGend:SHOW](#) on page 978
- [DISPlay:PESQ<n2>:B:LIMLower](#) on page 979
- [DISPlay:PESQ<n2>:B:LIMLower:SOURce](#) on page 979
- [DISPlay:PESQ<n2>:B:LIMLower:SOURce:FILE](#) on page 979
- [DISPlay:PESQ<n2>:B:LIMLower:SOURce:VALue](#) on page 980
- [DISPlay:PESQ<n2>:B:LIMUpper](#) on page 981
- [DISPlay:PESQ<n2>:B:LIMUpper:SOURce](#) on page 981
- [DISPlay:PESQ<n2>:B:LIMUpper:SOURce:FILE](#) on page 982
- [DISPlay:PESQ<n2>:B:LIMUpper:SOURce:VALue](#) on page 982
- [DISPlay:PESQ<n2>:B:SPACing](#) on page 983
- [DISPlay:PESQ<n2>:B:TOP](#) on page 984
- [DISPlay:PESQ<n2>:B:UPDate](#) on page 985
- [DISPlay:PESQ<n2>:B:YSource](#) on page 986
- [DISPlay:PESQ<n2>:B:YSource:FILE](#) on page 986
- [DISPlay:PESQ<n2>:DLISt:FILTer](#) on page 986
- [DISPlay:PESQ<n2>:MINMax](#) on page 987
- [DISPlay:PESQ<n2>:SCANoffset](#) on page 917

- [DISPlay:PESQ<n2>:TITLE:DESCRiption](#) on page 988
- [DISPlay:PESQ<n2>:TITLE:SHOW](#) on page 988
- [DISPlay:PESQ<n2>:TRACk:LIMit](#) on page 988
- [DISPlay:PESQ<n2>:TRACk:SCALing](#) on page 989
- [DISPlay:PESQ<n2>:X:LABel:AUTO](#) on page 989
- [DISPlay:PESQ<n2>:X:LABel:USER](#) on page 989
- [DISPlay:PESQ<n2>:X:LEFT](#) on page 990
- [DISPlay:PESQ<n2>:X:RIGHT](#) on page 990
- [DISPlay:PESQ<n2>:X:SCALing](#) on page 990
- [DISPlay:PESQ<n2>:X:SPACing](#) on page 990
- [DISPlay:PESQ<n2>:X:UNIT](#) on page 991
- [DISPlay:PESQ<n2>:X:UNIT:AUTO](#) on page 991
- [DISPlay:PESQ<n2>:X:UNIT:USER](#) on page 991
- [DISPlay:SWEep<n2>:A:BOTTom](#) on page 977
- [DISPlay:SWEep<n2>:A:CHANnel](#) on page 977
- [DISPlay:SWEep<n2>:A:LABel:AUTO](#) on page 978
- [DISPlay:SWEep<n2>:A:LABel:USER](#) on page 978
- [DISPlay:SWEep<n2>:A:LEGend:DESCRiption](#) on page 978
- [DISPlay:SWEep<n2>:A:LEGend:SHOW](#) on page 979
- [DISPlay:SWEep<n2>:A:LIMLower](#) on page 979
- [DISPlay:SWEep<n2>:A:LIMLower:SOURce](#) on page 979
- [DISPlay:SWEep<n2>:A:LIMLower:SOURce:FILE](#) on page 980
- [DISPlay:SWEep<n2>:A:LIMLower:SOURce:VALue](#) on page 980
- [DISPlay:SWEep<n2>:A:LIMShift](#) on page 980
- [DISPlay:SWEep<n2>:A:LIMShift:PARAllel](#) on page 980
- [DISPlay:SWEep<n2>:A:LIMShift:SYMMetrical](#) on page 981
- [DISPlay:SWEep<n2>:A:LIMUpper](#) on page 981
- [DISPlay:SWEep<n2>:A:LIMUpper:SOURce](#) on page 981
- [DISPlay:SWEep<n2>:A:LIMUpper:SOURce:FILE](#) on page 982
- [DISPlay:SWEep<n2>:A:LIMUpper:SOURce:VALue](#) on page 982
- [DISPlay:SWEep<n2>:A:NORMAlize](#) on page 982
- [DISPlay:SWEep<n2>:A:NORMAlize:VALue](#) on page 982
- [DISPlay:SWEep<n2>:A:REFerence](#) on page 983
- [DISPlay:SWEep<n2>:A:REFerence:FILE](#) on page 983
- [DISPlay:SWEep<n2>:A:REFerence:VALue](#) on page 983
- [DISPlay:SWEep<n2>:A:SPACing](#) on page 984
- [DISPlay:SWEep<n2>:A:TOP](#) on page 984
- [DISPlay:SWEep<n2>:A:UNIT](#) on page 984

- [DISPlay:SWEEp<n2>:A:UNIT:AUTO](#) on page 984
- [DISPlay:SWEEp<n2>:A:UNIT:TRACk](#) on page 985
- [DISPlay:SWEEp<n2>:A:UNIT:USER](#) on page 985
- [DISPlay:SWEEp<n2>:A:UPDate](#) on page 985
- [DISPlay:SWEEp<n2>:A:YSource](#) on page 986
- [DISPlay:SWEEp<n2>:A:YSource:FILE](#) on page 986
- [DISPlay:SWEEp<n2>:B:BOTTom](#) on page 977
- [DISPlay:SWEEp<n2>:B:CHANnel](#) on page 977
- [DISPlay:SWEEp<n2>:B:LABel:AUTO](#) on page 978
- [DISPlay:SWEEp<n2>:B:LABel:USER](#) on page 978
- [DISPlay:SWEEp<n2>:B:LEGend:DESCRiption](#) on page 978
- [DISPlay:SWEEp<n2>:B:LEGend:SHOW](#) on page 979
- [DISPlay:SWEEp<n2>:B:LIMLower](#) on page 979
- [DISPlay:SWEEp<n2>:B:LIMLower:SOURce](#) on page 979
- [DISPlay:SWEEp<n2>:B:LIMLower:SOURce:FILE](#) on page 980
- [DISPlay:SWEEp<n2>:B:LIMLower:SOURce:VALue](#) on page 980
- [DISPlay:SWEEp<n2>:B:LIMShift](#) on page 980
- [DISPlay:SWEEp<n2>:B:LIMShift:PARAllel](#) on page 980
- [DISPlay:SWEEp<n2>:B:LIMShift:SYMMetrical](#) on page 981
- [DISPlay:SWEEp<n2>:B:LIMUpper](#) on page 981
- [DISPlay:SWEEp<n2>:B:LIMUpper:SOURce](#) on page 981
- [DISPlay:SWEEp<n2>:B:LIMUpper:SOURce:FILE](#) on page 982
- [DISPlay:SWEEp<n2>:B:LIMUpper:SOURce:VALue](#) on page 982
- [DISPlay:SWEEp<n2>:B:NORMALize](#) on page 982
- [DISPlay:SWEEp<n2>:B:NORMALize:VALue](#) on page 982
- [DISPlay:SWEEp<n2>:B:REFerence](#) on page 983
- [DISPlay:SWEEp<n2>:B:REFerence:FILE](#) on page 983
- [DISPlay:SWEEp<n2>:B:REFerence:VALue](#) on page 983
- [DISPlay:SWEEp<n2>:B:SPACing](#) on page 984
- [DISPlay:SWEEp<n2>:B:TOP](#) on page 984
- [DISPlay:SWEEp<n2>:B:UNIT](#) on page 984
- [DISPlay:SWEEp<n2>:B:UNIT:AUTO](#) on page 984
- [DISPlay:SWEEp<n2>:B:UNIT:TRACk](#) on page 985
- [DISPlay:SWEEp<n2>:B:UNIT:USER](#) on page 985
- [DISPlay:SWEEp<n2>:B:UPDate](#) on page 985
- [DISPlay:SWEEp<n2>:B:YSource](#) on page 986
- [DISPlay:SWEEp<n2>:B:YSource:FILE](#) on page 986
- [DISPlay:SWEEp<n2>:DLISt:FILTer](#) on page 986

- [DISPlay:SWEEp<n2>:HISTory](#) on page 987
- [DISPlay:SWEEp<n2>:MINMax](#) on page 987
- [DISPlay:SWEEp<n2>:SCANoffset](#) on page 917
- [DISPlay:SWEEp<n2>:SMODE](#) on page 988
- [DISPlay:SWEEp<n2>:TITLE:DESCRiption](#) on page 988
- [DISPlay:SWEEp<n2>:TITLE:SHOW](#) on page 988
- [DISPlay:SWEEp<n2>:TRACk:LIMit](#) on page 988
- [DISPlay:SWEEp<n2>:TRACk:REFerence](#) on page 989
- [DISPlay:SWEEp<n2>:TRACk:SCALing](#) on page 989
- [DISPlay:SWEEp<n2>:X:AXIS](#) on page 989
- [DISPlay:SWEEp<n2>:X:LABel:AUTO](#) on page 989
- [DISPlay:SWEEp<n2>:X:LABel:USER](#) on page 989
- [DISPlay:SWEEp<n2>:X:LEFT](#) on page 990
- [DISPlay:SWEEp<n2>:X:REFerence:VALue](#) on page 990
- [DISPlay:SWEEp<n2>:X:RIGHT](#) on page 990
- [DISPlay:SWEEp<n2>:X:SCALing](#) on page 990
- [DISPlay:SWEEp<n2>:X:SPACing](#) on page 990
- [DISPlay:SWEEp<n2>:X:SOURce](#) on page 990
- [DISPlay:SWEEp<n2>:X:UNIT](#) on page 991
- [DISPlay:SWEEp<n2>:X:UNIT:AUTO](#) on page 991
- [DISPlay:SWEEp<n2>:X:UNIT:USER](#) on page 991
- [DISPlay:WAVEform<n2>:A:BOTTOm](#) on page 977
- [DISPlay:WAVEform<n2>:A:CHANnel](#) on page 977
- [DISPlay:WAVEform<n2>:A:LABel:AUTO](#) on page 977
- [DISPlay:WAVEform<n2>:A:LABel:USER](#) on page 978
- [DISPlay:WAVEform<n2>:A:LEGend:DESCRiption](#) on page 978
- [DISPlay:WAVEform<n2>:A:LEGend:SHOW](#) on page 978
- [DISPlay:WAVEform<n2>:A:LIMLower](#) on page 979
- [DISPlay:WAVEform<n2>:A:LIMLower:SOURce](#) on page 979
- [DISPlay:WAVEform<n2>:A:LIMLower:SOURce:FILE](#) on page 979
- [DISPlay:WAVEform<n2>:A:LIMLower:SOURce:VALue](#) on page 980
- [DISPlay:WAVEform<n2>:A:LIMShift](#) on page 980
- [DISPlay:WAVEform<n2>:A:LIMShift:PARallel](#) on page 980
- [DISPlay:WAVEform<n2>:A:LIMShift:SYMMetrical](#) on page 981
- [DISPlay:WAVEform<n2>:A:LIMUpper](#) on page 981
- [DISPlay:WAVEform<n2>:A:LIMUpper:SOURce](#) on page 981
- [DISPlay:WAVEform<n2>:A:LIMUpper:SOURce:FILE](#) on page 981
- [DISPlay:WAVEform<n2>:A:LIMUpper:SOURce:VALue](#) on page 982

- [DISPlay:WAVeform<n2>:A:REFerence](#) on page 983
- [DISPlay:WAVeform<n2>:A:REFerence:VALue](#) on page 983
- [DISPlay:WAVeform<n2>:A:SPACing](#) on page 983
- [DISPlay:WAVeform<n2>:A:TOP](#) on page 984
- [DISPlay:WAVeform<n2>:A:UNIT](#) on page 984
- [DISPlay:WAVeform<n2>:A:UNIT:AUTO](#) on page 984
- [DISPlay:WAVeform<n2>:A:UNIT:USER](#) on page 985
- [DISPlay:WAVeform<n2>:A:UPDate](#) on page 985
- [DISPlay:WAVeform<n2>:A:YSource](#) on page 985
- [DISPlay:WAVeform<n2>:A:YSource:FILE](#) on page 986
- [DISPlay:WAVeform<n2>:B:BOTTom](#) on page 977
- [DISPlay:WAVeform<n2>:B:CHANnel](#) on page 977
- [DISPlay:WAVeform<n2>:B:LABel:AUTO](#) on page 977
- [DISPlay:WAVeform<n2>:B:LABel:USER](#) on page 978
- [DISPlay:WAVeform<n2>:B:LEGend:DESCRiption](#) on page 978
- [DISPlay:WAVeform<n2>:B:LEGend:SHOW](#) on page 978
- [DISPlay:WAVeform<n2>:B:LIMLower](#) on page 979
- [DISPlay:WAVeform<n2>:B:LIMLower:SOURce](#) on page 979
- [DISPlay:WAVeform<n2>:B:LIMLower:SOURce:FILE](#) on page 979
- [DISPlay:WAVeform<n2>:B:LIMLower:SOURce:VALue](#) on page 980
- [DISPlay:WAVeform<n2>:B:LIMShift](#) on page 980
- [DISPlay:WAVeform<n2>:B:LIMShift:PARAllel](#) on page 980
- [DISPlay:WAVeform<n2>:B:LIMShift:SYMMetrical](#) on page 981
- [DISPlay:WAVeform<n2>:B:LIMUpper](#) on page 981
- [DISPlay:WAVeform<n2>:B:LIMUpper:SOURce](#) on page 981
- [DISPlay:WAVeform<n2>:B:LIMUpper:SOURce:FILE](#) on page 981
- [DISPlay:WAVeform<n2>:B:LIMUpper:SOURce:VALue](#) on page 982
- [DISPlay:WAVeform<n2>:B:REFerence](#) on page 983
- [DISPlay:WAVeform<n2>:B:REFerence:VALue](#) on page 983
- [DISPlay:WAVeform<n2>:B:SPACing](#) on page 983
- [DISPlay:WAVeform<n2>:B:TOP](#) on page 984
- [DISPlay:WAVeform<n2>:B:UNIT](#) on page 984
- [DISPlay:WAVeform<n2>:B:UNIT:AUTO](#) on page 984
- [DISPlay:WAVeform<n2>:B:UNIT:USER](#) on page 985
- [DISPlay:WAVeform<n2>:B:UPDate](#) on page 985
- [DISPlay:WAVeform<n2>:B:YSource](#) on page 985
- [DISPlay:WAVeform<n2>:B:YSource:FILE](#) on page 986
- [DISPlay:WAVeform<n2>:DLISt:FILTer](#) on page 986

- [DISPlay:WAVeform<n2>:SCANOffset](#) on page 917
- [DISPlay:WAVeform<n2>:TITLe:DESCRiption](#) on page 988
- [DISPlay:WAVeform<n2>:TITLe:SHOw](#) on page 988
- [DISPlay:WAVeform<n2>:TRACk:LIMit](#) on page 988
- [DISPlay:WAVeform<n2>:TRACk:REFerence](#) on page 988
- [DISPlay:WAVeform<n2>:TRACk:SCALing](#) on page 989
- [DISPlay:WAVeform<n2>:X:LABel:AUTO](#) on page 989
- [DISPlay:WAVeform<n2>:X:LABel:USER](#) on page 989
- [DISPlay:WAVeform<n2>:X:LEFT](#) on page 989
- [DISPlay:WAVeform<n2>:X:REFerence:VALue](#) on page 990
- [DISPlay:WAVeform<n2>:X:RIGHT](#) on page 990
- [DISPlay:WAVeform<n2>:X:SCALing](#) on page 990
- [DISPlay:WAVeform<n2>:X:SPACing](#) on page 990
- [DISPlay:WAVeform<n2>:X:UNIT](#) on page 991
- [DISPlay:WAVeform<n2>:X:UNIT:AUTO](#) on page 991
- [DISPlay:WAVeform<n2>:X:UNIT:USER](#) on page 991
- [MMEMorY:BARGraph<n2>:LIMit:OFFSet](#) on page 992
- [MMEMorY:BARGraph<n2>:LIMit:OFFSet:VALue](#) on page 992
- [MMEMorY:BARGraph<n2>:STAS](#) on page 992
- [MMEMorY:BARGraph<n2>:STORe](#) on page 992
- [MMEMorY:BARGraph<n2>:TRACe](#) on page 992
- [MMEMorY:FFT<n2>:EQUalization:INVert](#) on page 991
- [MMEMorY:FFT<n2>:EQUalization:MODify](#) on page 991
- [MMEMorY:FFT<n2>:EQUalization:NORMfrequency](#) on page 992
- [MMEMorY:FFT<n2>:LIMit:OFFSet](#) on page 992
- [MMEMorY:FFT<n2>:LIMit:OFFSet:VALue](#) on page 992
- [MMEMorY:FFT<n2>:STAS](#) on page 992
- [MMEMorY:FFT<n2>:STORe](#) on page 992
- [MMEMorY:FFT<n2>:TRACe](#) on page 992
- [MMEMorY:PESQ<n2>:LIMit:OFFSet](#) on page 992
- [MMEMorY:PESQ<n2>:LIMit:OFFSet:VALue](#) on page 992
- [MMEMorY:PESQ<n2>:STAS](#) on page 992
- [MMEMorY:PESQ<n2>:STORe](#) on page 992
- [MMEMorY:PESQ<n2>:TRACe](#) on page 993
- [MMEMorY:SWEep<n2>:EQUalization:INVert](#) on page 991
- [MMEMorY:SWEep<n2>:EQUalization:MODify](#) on page 991
- [MMEMorY:SWEep<n2>:EQUalization:NORMfrequency](#) on page 992
- [MMEMorY:SWEep<n2>:LIMit:OFFSet](#) on page 992

- [MMEMory:SWEEp<n2>:LIMit:OFFSet:VALue](#) on page 992
- [MMEMory:SWEEp<n2>:STAS](#) on page 992
- [MMEMory:SWEEp<n2>:STORe](#) on page 992
- [MMEMory:SWEEp<n2>:TRACe](#) on page 993
- [MMEMory:WAVEform<n2>:STAS](#) on page 992
- [MMEMory:WAVEform<n2>:STORe](#) on page 992
- [SENSe<n1>:CONFig:COPIOther](#) on page 993

DISPlay:FFT<n2>:A:BOTTom <bottom>
DISPlay:FFT<n2>:B:BOTTom <bottom>
DISPlay:WAVEform<n2>:A:BOTTom <bottom>
DISPlay:WAVEform<n2>:B:BOTTom <bottom>
DISPlay:BARGraph<n2>:A:BOTTom <bottom>
DISPlay:BARGraph<n2>:B:BOTTom <bottom>
DISPlay:PESQ<n2>:A:BOTTom <bottom>
DISPlay:PESQ<n2>:B:BOTTom <bottom>
DISPlay:SWEEp<n2>:A:BOTTom <bottom>
DISPlay:SWEEp<n2>:B:BOTTom <bottom>

Parameters:

<bottom> float

Manual operation: See "[Bottom](#)" on page 700

DISPlay:FFT<n2>:A:CHANnel <channel>
DISPlay:FFT<n2>:B:CHANnel <channel>
DISPlay:WAVEform<n2>:A:CHANnel <channel>
DISPlay:WAVEform<n2>:B:CHANnel <channel>
DISPlay:BARGraph<n2>:A:CHANnel <channel>
DISPlay:BARGraph<n2>:B:CHANnel <channel>
DISPlay:SWEEp<n2>:A:CHANnel <channel>
DISPlay:SWEEp<n2>:B:CHANnel <channel>

Parameters:

<channel> OFF | CH1 | CH2 | CH3 | CH4 | CH5 | CH6 | CH7 | CH8 | | CH9 |
 CH10 | CH11 | CH12 | CH13 | CH14 | CH15 | CH16

Manual operation: See "[Channel](#)" on page 687

DISPlay:FFT<n2>:A:LAbel:AUTO <state>
DISPlay:FFT<n2>:B:LAbel:AUTO <state>
DISPlay:WAVEform<n2>:A:LAbel:AUTO <state>
DISPlay:WAVEform<n2>:B:LAbel:AUTO <state>
DISPlay:BARGraph<n2>:A:LAbel:AUTO <state>
DISPlay:BARGraph<n2>:B:LAbel:AUTO <state>
DISPlay:PESQ<n2>:A:LAbel:AUTO <state>
DISPlay:PESQ<n2>:B:LAbel:AUTO <state>

DISPlay:SWEEp<n2>:A:LABel:AUTO <state>

DISPlay:SWEEp<n2>:B:LABel:AUTO <state>

Parameters:

<state> ON | OFF

Manual operation: See "[Label Auto](#)" on page 688

DISPlay:FFT<n2>:A:LABel:USER <user>

DISPlay:FFT<n2>:B:LABel:USER <user>

DISPlay:WAVEform<n2>:A:LABel:USER <user>

DISPlay:WAVEform<n2>:B:LABel:USER <user>

DISPlay:BARGraph<n2>:A:LABel:USER <user>

DISPlay:BARGraph<n2>:B:LABel:USER <user>

DISPlay:PESQ<n2>:A:LABel:USER <user>

DISPlay:PESQ<n2>:B:LABel:USER <user>

DISPlay:SWEEp<n2>:A:LABel:USER <user>

DISPlay:SWEEp<n2>:B:LABel:USER <user>

Parameters:

<user> string

Manual operation: See "[Label Auto](#)" on page 688

DISPlay:FFT<n2>:A:LEGend:DESCRiption <description>

DISPlay:FFT<n2>:B:LEGend:DESCRiption <description>

DISPlay:WAVEform<n2>:A:LEGend:DESCRiption <description>

DISPlay:WAVEform<n2>:B:LEGend:DESCRiption <description>

DISPlay:BARGraph<n2>:A:LEGend:DESCRiption <description>

DISPlay:BARGraph<n2>:B:LEGend:DESCRiption <description>

DISPlay:PESQ<n2>:A:LEGend:DESCRiption <description>

DISPlay:PESQ<n2>:B:LEGend:DESCRiption <description>

DISPlay:SWEEp<n2>:A:LEGend:DESCRiption <description>

DISPlay:SWEEp<n2>:B:LEGend:DESCRiption <description>

Parameters:

<description> string

Manual operation: See "[Title Descript, Leg A Descript, Leg B Descript](#)" on page 720

DISPlay:FFT<n2>:A:LEGend:SHOW <state>

DISPlay:FFT<n2>:B:LEGend:SHOW <state>

DISPlay:WAVEform<n2>:A:LEGend:SHOW <state>

DISPlay:WAVEform<n2>:B:LEGend:SHOW <state>

DISPlay:BARGraph<n2>:A:LEGend:SHOW <state>

DISPlay:BARGraph<n2>:B:LEGend:SHOW <state>

DISPlay:PESQ<n2>:A:LEGend:SHOW <state>

DISPlay:PESQ<n2>:B:LEGend:SHOW <state>

DISPlay:SWEEp<n2>:A:LEGend:SHOW <state>

DISPlay:SWEEp<n2>:B:LEGend:SHOW <state>

Parameters:

<state> ON | OFF

Manual operation: See ["Show Title Show Leg A , Show Leg B"](#) on page 720

DISPlay:FFT<n2>:A:LIMLower <state>

DISPlay:FFT<n2>:B:LIMLower <state>

DISPlay:WAVEform<n2>:A:LIMLower <state>

DISPlay:WAVEform<n2>:B:LIMLower <state>

DISPlay:BARGraph<n2>:A:LIMLower <state>

DISPlay:BARGraph<n2>:B:LIMLower <state>

DISPlay:PESQ<n2>:A:LIMLower <state>

DISPlay:PESQ<n2>:B:LIMLower <state>

DISPlay:SWEEp<n2>:A:LIMLower <state>

DISPlay:SWEEp<n2>:B:LIMLower <state>

Parameters:

<state> ON | OFF

Manual operation: See ["Limit Lower"](#) on page 705

DISPlay:FFT<n2>:A:LIMLower:SOURce <source>

DISPlay:FFT<n2>:B:LIMLower:SOURce <source>

DISPlay:WAVEform<n2>:A:LIMLower:SOURce <source>

DISPlay:WAVEform<n2>:B:LIMLower:SOURce <source>

DISPlay:BARGraph<n2>:A:LIMLower:SOURce <source>

DISPlay:BARGraph<n2>:B:LIMLower:SOURce <source>

DISPlay:PESQ<n2>:A:LIMLower:SOURce <source>

DISPlay:PESQ<n2>:B:LIMLower:SOURce <source>

DISPlay:SWEEp<n2>:A:LIMLower:SOURce <source>

DISPlay:SWEEp<n2>:B:LIMLower:SOURce <source>

Parameters:

<source> VALue | FILE | HOLD | IFILE

Manual operation: See ["Source"](#) on page 706

DISPlay:FFT<n2>:A:LIMLower:SOURce:FILE <file>

DISPlay:FFT<n2>:B:LIMLower:SOURce:FILE <file>

DISPlay:WAVEform<n2>:A:LIMLower:SOURce:FILE <file>

DISPlay:WAVEform<n2>:B:LIMLower:SOURce:FILE <file>

DISPlay:BARGraph<n2>:A:LIMLower:SOURce:FILE <file>

DISPlay:BARGraph<n2>:B:LIMLower:SOURce:FILE <file>

DISPlay:PESQ<n2>:A:LIMLower:SOURce:FILE <file>

DISPlay:PESQ<n2>:B:LIMLower:SOURce:FILE <file>

DISPlay:SWEEp<n2>:A:LIMLower:SOURce:FILE <file>

DISPlay:SWEEp<n2>:B:LIMLower:SOURce:FILE <file>

Parameters:

<file> string

Manual operation: See "[Source Filename](#)" on page 707

DISPlay:FFT<n2>:A:LIMLower:SOURce:VALue <value>

DISPlay:FFT<n2>:B:LIMLower:SOURce:VALue <value>

DISPlay:WAVEform<n2>:A:LIMLower:SOURce:VALue <value>

DISPlay:WAVEform<n2>:B:LIMLower:SOURce:VALue <value>

DISPlay:BARGraph<n2>:A:LIMLower:SOURce:VALue <value>

DISPlay:BARGraph<n2>:B:LIMLower:SOURce:VALue <value>

DISPlay:PESQ<n2>:A:LIMLower:SOURce:VALue <value>

DISPlay:PESQ<n2>:B:LIMLower:SOURce:VALue <value>

DISPlay:SWEEp<n2>:A:LIMLower:SOURce:VALue <value>

DISPlay:SWEEp<n2>:B:LIMLower:SOURce:VALue <value>

Parameters:

<value> float

Manual operation: See "[Source Value](#)" on page 707

DISPlay:FFT<n2>:A:LIMShift <state>

DISPlay:FFT<n2>:B:LIMShift <state>

DISPlay:WAVEform<n2>:A:LIMShift <state>

DISPlay:WAVEform<n2>:B:LIMShift <state>

DISPlay:BARGraph<n2>:A:LIMShift <state>

DISPlay:BARGraph<n2>:B:LIMShift <state>

DISPlay:SWEEp<n2>:A:LIMShift <state>

DISPlay:SWEEp<n2>:B:LIMShift <state>

Parameters:

<state> ON | OFF

Manual operation: See "[Limit Shift](#)" on page 708

DISPlay:FFT<n2>:A:LIMShift:PARAllel <parallel>

DISPlay:FFT<n2>:B:LIMShift:PARAllel <parallel>

DISPlay:WAVEform<n2>:A:LIMShift:PARAllel <parallel>

DISPlay:WAVEform<n2>:B:LIMShift:PARAllel <parallel>

DISPlay:BARGraph<n2>:A:LIMShift:PARAllel <parallel>

DISPlay:BARGraph<n2>:B:LIMShift:PARAllel <parallel>

DISPlay:SWEEp<n2>:A:LIMShift:PARAllel <parallel>

DISPlay:SWEEp<n2>:B:LIMShift:PARAllel <parallel>

Parameters:

<parallel> float

Manual operation: See "[Parallel](#)" on page 708

DISPlay:FFT<n2>:A:LIMShift:SYMMetrical <symmetrical>
DISPlay:FFT<n2>:B:LIMShift:SYMMetrical <symmetrical>
DISPlay:WAVeform<n2>:A:LIMShift:SYMMetrical <symmetrical>
DISPlay:WAVeform<n2>:B:LIMShift:SYMMetrical <symmetrical>
DISPlay:BARGraph<n2>:A:LIMShift:SYMMetrical <symmetrical>
DISPlay:BARGraph<n2>:B:LIMShift:SYMMetrical <symmetrical>
DISPlay:SWEEp<n2>:A:LIMShift:SYMMetrical <symmetrical>
DISPlay:SWEEp<n2>:B:LIMShift:SYMMetrical <symmetrical>

Parameters:

<symmetrical> float

Manual operation: See "[Symmetrical](#)" on page 709

DISPlay:FFT<n2>:A:LIMUpper <state>
DISPlay:FFT<n2>:B:LIMUpper <state>
DISPlay:WAVeform<n2>:A:LIMUpper <state>
DISPlay:WAVeform<n2>:B:LIMUpper <state>
DISPlay:BARGraph<n2>:A:LIMUpper <state>
DISPlay:BARGraph<n2>:B:LIMUpper <state>
DISPlay:PESQ<n2>:A:LIMUpper <state>
DISPlay:PESQ<n2>:B:LIMUpper <state>
DISPlay:SWEEp<n2>:A:LIMUpper <state>
DISPlay:SWEEp<n2>:B:LIMUpper <state>

Parameters:

<state> ON | OFF

Manual operation: See "[Limit Upper](#)" on page 702

DISPlay:FFT<n2>:A:LIMUpper:SOURce <source>
DISPlay:FFT<n2>:B:LIMUpper:SOURce <source>
DISPlay:WAVeform<n2>:A:LIMUpper:SOURce <source>
DISPlay:WAVeform<n2>:B:LIMUpper:SOURce <source>
DISPlay:BARGraph<n2>:A:LIMUpper:SOURce <source>
DISPlay:BARGraph<n2>:B:LIMUpper:SOURce <source>
DISPlay:PESQ<n2>:A:LIMUpper:SOURce <source>
DISPlay:PESQ<n2>:B:LIMUpper:SOURce <source>
DISPlay:SWEEp<n2>:A:LIMUpper:SOURce <source>
DISPlay:SWEEp<n2>:B:LIMUpper:SOURce <source>

Parameters:

<source> VALue | FILE | HOLD | IFILE

Manual operation: See "[Source](#)" on page 703

DISPlay:FFT<n2>:A:LIMUpper:SOURce:FILE <file>
DISPlay:FFT<n2>:B:LIMUpper:SOURce:FILE <file>
DISPlay:WAVeform<n2>:A:LIMUpper:SOURce:FILE <file>
DISPlay:WAVeform<n2>:B:LIMUpper:SOURce:FILE <file>
DISPlay:BARGraph<n2>:A:LIMUpper:SOURce:FILE <file>

DISPlay:BARGraph<n2>:B:LIMUpper:SOURce:FILE <file>
DISPlay:PESQ<n2>:A:LIMUpper:SOURce:FILE <file>
DISPlay:PESQ<n2>:B:LIMUpper:SOURce:FILE <file>
DISPlay:SWEep<n2>:A:LIMUpper:SOURce:FILE <file>
DISPlay:SWEep<n2>:B:LIMUpper:SOURce:FILE <file>
Parameters:
 <file> string

Manual operation: See "[Source Filename](#)" on page 705

DISPlay:FFT<n2>:A:LIMUpper:SOURce:VALue <value>
DISPlay:FFT<n2>:B:LIMUpper:SOURce:VALue <value>
DISPlay:WAVEform<n2>:A:LIMUpper:SOURce:VALue <value>
DISPlay:WAVEform<n2>:B:LIMUpper:SOURce:VALue <value>
DISPlay:BARGraph<n2>:A:LIMUpper:SOURce:VALue <value>
DISPlay:BARGraph<n2>:B:LIMUpper:SOURce:VALue <value>
DISPlay:PESQ<n2>:A:LIMUpper:SOURce:VALue <value>
DISPlay:PESQ<n2>:B:LIMUpper:SOURce:VALue <value>
DISPlay:SWEep<n2>:A:LIMUpper:SOURce:VALue <value>
DISPlay:SWEep<n2>:B:LIMUpper:SOURce:VALue <value>
Parameters:
 <value> float

Manual operation: See "[Source Value](#)" on page 704

DISPlay:FFT<n2>:A:NORMalize <normalize>
DISPlay:FFT<n2>:B:NORMalize <normalize>
DISPlay:BARGraph<n2>:A:NORMalize <normalize>
DISPlay:BARGraph<n2>:B:NORMalize <normalize>
DISPlay:SWEep<n2>:A:NORMalize <normalize>
DISPlay:SWEep<n2>:B:NORMalize <normalize>
Parameters:
 <normalize> OFF | VALue | OCURsor | XCURsor

Manual operation: See "[Normalize](#)" on page 693

DISPlay:FFT<n2>:A:NORMalize:VALue <value>
DISPlay:FFT<n2>:B:NORMalize:VALue <value>
DISPlay:BARGraph<n2>:A:NORMalize:VALue <value>
DISPlay:BARGraph<n2>:B:NORMalize:VALue <value>
DISPlay:SWEep<n2>:A:NORMalize:VALue <value>
DISPlay:SWEep<n2>:B:NORMalize:VALue <value>
Parameters:
 <value> float

Manual operation: See "[Normalize Value](#)" on page 694

DISPlay:FFT<n2>:A:REFerence <reference>
DISPlay:FFT<n2>:B:REFerence <reference>
DISPlay:WAVeform<n2>:A:REFerence <reference>
DISPlay:WAVeform<n2>:B:REFerence <reference>
DISPlay:BARGraph<n2>:A:REFerence <reference>
DISPlay:BARGraph<n2>:B:REFerence <reference>
DISPlay:SWEEp<n2>:A:REFerence <reference>
DISPlay:SWEEp<n2>:B:REFerence <reference>

Parameters:

<reference> VALue | FILE | HOLD | IFILE | MEASpanel | MAXimum |
 XCURsor | OCURsor | REF997 | REF1000 | CH1Meas |
 CH2Meas | GENTrack | NOISedensity | DBNOisedensity |
 MREFchannel

Manual operation: See ["Reference"](#) on page 689

DISPlay:FFT<n2>:A:REFerence:FILE <file>
DISPlay:FFT<n2>:B:REFerence:FILE <file>
DISPlay:BARGraph<n2>:A:REFerence:FILE <file>
DISPlay:BARGraph<n2>:B:REFerence:FILE <file>
DISPlay:SWEEp<n2>:A:REFerence:FILE <file>
DISPlay:SWEEp<n2>:B:REFerence:FILE <file>

Parameters:

<file> string

Manual operation: See ["Reference File"](#) on page 693

DISPlay:FFT<n2>:A:REFerence:VALue <value>
DISPlay:FFT<n2>:B:REFerence:VALue <value>
DISPlay:WAVeform<n2>:A:REFerence:VALue <value>
DISPlay:WAVeform<n2>:B:REFerence:VALue <value>
DISPlay:BARGraph<n2>:A:REFerence:VALue <value>
DISPlay:BARGraph<n2>:B:REFerence:VALue <value>
DISPlay:SWEEp<n2>:A:REFerence:VALue <value>
DISPlay:SWEEp<n2>:B:REFerence:VALue <value>

Parameters:

<value> float

Manual operation: See ["Reference Value"](#) on page 692

DISPlay:FFT<n2>:A:SPACing <spacing>
DISPlay:FFT<n2>:B:SPACing <spacing>
DISPlay:WAVeform<n2>:A:SPACing <spacing>
DISPlay:WAVeform<n2>:B:SPACing <spacing>
DISPlay:BARGraph<n2>:A:SPACing <spacing>
DISPlay:BARGraph<n2>:B:SPACing <spacing>
DISPlay:PESQ<n2>:A:SPACing <spacing>
DISPlay:PESQ<n2>:B:SPACing <spacing>

DISPlay:SWEEp<n2>:A:SPACing <spacing>

DISPlay:SWEEp<n2>:B:SPACing <spacing>

Parameters:

<spacing> LINear | LOGarithmic | | LINSteps | LOGSteps | LINPoints | LOGPoints

Manual operation: See "[Spacing](#)" on page 699

DISPlay:FFT<n2>:A:TOP <top>

DISPlay:FFT<n2>:B:TOP <top>

DISPlay:WAVEform<n2>:A:TOP <top>

DISPlay:WAVEform<n2>:B:TOP <top>

DISPlay:BARGraph<n2>:A:TOP <top>

DISPlay:BARGraph<n2>:B:TOP <top>

DISPlay:PESQ<n2>:A:TOP <top>

DISPlay:PESQ<n2>:B:TOP <top>

DISPlay:SWEEp<n2>:A:TOP <top>

DISPlay:SWEEp<n2>:B:TOP <top>

Parameters:

<top> float

Manual operation: See "[Top](#)" on page 700

DISPlay:FFT<n2>:A:UNIT <unit>

DISPlay:FFT<n2>:B:UNIT <unit>

DISPlay:WAVEform<n2>:A:UNIT <unit>

DISPlay:WAVEform<n2>:B:UNIT <unit>

DISPlay:BARGraph<n2>:A:UNIT <unit>

DISPlay:BARGraph<n2>:B:UNIT <unit>

DISPlay:SWEEp<n2>:A:UNIT <unit>

DISPlay:SWEEp<n2>:B:UNIT <unit>

It is recommended to use the command recording in order to find the correct unit parameter, see [chapter 6.7, "Command Recording"](#), on page 826 .

Parameters:

<unit> string

Manual operation: See "[Unit](#)" on page 696

DISPlay:FFT<n2>:A:UNIT:AUTO <state>

DISPlay:FFT<n2>:B:UNIT:AUTO <state>

DISPlay:WAVEform<n2>:A:UNIT:AUTO <state>

DISPlay:WAVEform<n2>:B:UNIT:AUTO <state>

DISPlay:BARGraph<n2>:A:UNIT:AUTO <state>

DISPlay:BARGraph<n2>:B:UNIT:AUTO <state>

DISPlay:SWEEp<n2>:A:UNIT:AUTO <state>

DISPlay:SWEEp<n2>:B:UNIT:AUTO <state>

Parameters:

<state> ON | OFF

Manual operation: See ["Unit Auto"](#) on page 697

DISPlay:FFT<n2>:A:UNIT:TRACk <state>
DISPlay:FFT<n2>:B:UNIT:TRACk <state>
DISPlay:BARGraph<n2>:A:UNIT:TRACk <state>
DISPlay:BARGraph<n2>:B:UNIT:TRACk <state>
DISPlay:SWEep<n2>:A:UNIT:TRACk <state>
DISPlay:SWEep<n2>:B:UNIT:TRACk <state>
Parameters:
 <state> ON | OFF

Manual operation: See ["Unit Fnct Track"](#) on page 694

DISPlay:FFT<n2>:A:UNIT:USER <user>
DISPlay:FFT<n2>:B:UNIT:USER <user>
DISPlay:WAVEform<n2>:A:UNIT:USER <user>
DISPlay:WAVEform<n2>:B:UNIT:USER <user>
DISPlay:BARGraph<n2>:A:UNIT:USER <user>
DISPlay:BARGraph<n2>:B:UNIT:USER <user>
DISPlay:SWEep<n2>:A:UNIT:USER <user>
DISPlay:SWEep<n2>:B:UNIT:USER <user>
Parameters:
 <user> string

Manual operation: See ["Unit User String"](#) on page 698

DISPlay:FFT<n2>:A:UPDate <update>
DISPlay:FFT<n2>:B:UPDate <update>
DISPlay:WAVEform<n2>:A:UPDate <update>
DISPlay:WAVEform<n2>:B:UPDate <update>
DISPlay:BARGraph<n2>:A:UPDate <update>
DISPlay:BARGraph<n2>:B:UPDate <update>
DISPlay:PESQ<n2>:A:UPDate <update>
DISPlay:PESQ<n2>:B:UPDate <update>
DISPlay:SWEep<n2>:A:UPDate <update>
DISPlay:SWEep<n2>:B:UPDate <update>
Parameters:
 <update> ALIVE | HOLD

Manual operation: See ["Alive / Hold"](#) on page 689

DISPlay:FFT<n2>:A:YSource <ysource>
DISPlay:FFT<n2>:B:YSource <ysource>
DISPlay:WAVEform<n2>:A:YSource <ysource>
DISPlay:WAVEform<n2>:B:YSource <ysource>
DISPlay:BARGraph<n2>:A:YSource <ysource>
DISPlay:BARGraph<n2>:B:YSource <ysource>

DISPlay:PESQ<n2>:A:YSource <ySource>
DISPlay:PESQ<n2>:B:YSource <ySource>
DISPlay:SWEep<n2>:A:YSource <ySource>
DISPlay:SWEep<n2>:B:YSource <ySource>

Parameters:

<ySource> available parameters depend on subsystem.

Parameters for Sweep subsystem:

OFF | FUNC1 | FUNC2 | FREQ1 | FREQ2 | PHASE | GROUpde-
lay | LMRM1 | LMRM2 | LMDC1 | LMDC2 | LMPK1 | LMPK2 |
INPP1 | INPP2 | FILEA | FILEB | FUNCtion | FREQuency |
LMRMs | LMPK | INPPeak

Parameters for FFT subsystem:

OFF | FFTL1 | FFTL2 | FFTP1 | FFTP2 | FFTP21 | FILEA |
FILEB | FFTLevel | FFTPhase | FFTRefchphase

Parameters for Waveform subsystem:

OFF | LEV1 | LEV2 | FILEA | FILEB | LEVel

Parameters for Bargraph subsystem:

OFF | FUNC1 | FUNC2 | FILEA | FILEB | FUNCtion

Parameters for PESQ subsystem:

OFF | PEMO | DELay | FILEA | FILEB | REFSignal | DEGSignal
| DROPOuts

Manual operation: See "[Y-Source](#)" on page 677

DISPlay:FFT<n2>:A:YSource:FILE <file>
DISPlay:FFT<n2>:B:YSource:FILE <file>
DISPlay:WAVEform<n2>:A:YSource:FILE <file>
DISPlay:WAVEform<n2>:B:YSource:FILE <file>
DISPlay:BARGraph<n2>:A:YSource:FILE <file>
DISPlay:BARGraph<n2>:B:YSource:FILE <file>
DISPlay:PESQ<n2>:A:YSource:FILE <file>
DISPlay:PESQ<n2>:B:YSource:FILE <file>
DISPlay:SWEep<n2>:A:YSource:FILE <file>
DISPlay:SWEep<n2>:B:YSource:FILE <file>

Parameters:

<file> string

Manual operation: See "[Trace File](#)" on page 686

DISPlay:FFT<n2>:DLISt:FILTer <filter>
DISPlay:WAVEform<n2>:DLISt:FILTer <filter>
DISPlay:PESQ<n2>:DLISt:FILTer <filter>
DISPlay:BARGraph<n2>:DLISt:FILTer <filter>
DISPlay:SWEep<n2>:DLISt:FILTer <filter>

Corresponds to the softkey operation in the list editor:

Selection

All | Lim Upper | Lim Lower | Lim upp&low | Harmonics | Peaks

When saving a trace by setting "Store Trace as" to "DataList Select" (MMEMory:Subsys<i><n2>:STAS DSElect) or when trace data is read in with the following IEC/IEEE bus commands:

- TRACe:Subsys<n2>:LDList:AX?
- TRACe:Subsys<n2>:LDList:AY?
- TRACe:Subsys<n2>:LDList:BX?
- TRACe:Subsys<n2>:LDList:BY?

The IEC/IEEE bus command specifies which data is saved/read.

Parameters:

<filter> ALL | LIMUpper | LIMLower | LIMBoth | HARMonics | PEAKs

ALL
all

LIMUpper
Only those values that exceed the upper limit.

LIMLower
Only the values which are below the lower limit value.

LIMBoth
Only those values that exceed the upper limit and fall below the lower limit.

HARMonics
Only harmonics

PEAKs
Partial curve peaks

Example: DISPlay:FFT:DLISt:FILTer HARMonics

DISPlay:SWEep<n2>:HISTory <history>

Parameters:

<history> integer

Manual operation: See "[History](#)" on page 675

DISPlay:FFT<n2>:MINMax <state>
DISPlay:BARGraph<n2>:MINMax <state>
DISPlay:PESQ<n2>:MINMax <state>
DISPlay:SWEep<n2>:MINMax <state>

Parameters:

<state> ON | OFF

Manual operation: See "[Show Min Max](#)" on page 676

DISPlay:FFT<n2>:MCHMode <state>

DISPlay:BARGraph<n2>:MCHMode <state>

Parameters:

<state> ON | OFF

Manual operation: See ["Multi Ch Mode"](#) on page 676

DISPlay:SWEep<n2>:SMODE <smode>

Parameters:

<smode> SINGlescan | MULTiscan

Manual operation: See ["Scan"](#) on page 674

DISPlay:FFT<n2>:TITLE:DESCRiption <description>

DISPlay:WAVEform<n2>:TITLE:DESCRiption <description>

DISPlay:PESQ<n2>:TITLE:DESCRiption <description>

DISPlay:BARGraph<n2>:TITLE:DESCRiption <description>

DISPlay:SWEep<n2>:TITLE:DESCRiption <description>

Parameters:

<description> string

Manual operation: See ["Title Descript, Leg A Descript, Leg B Descript"](#) on page 720

DISPlay:FFT<n2>:TITLE:SHOW <state>

DISPlay:WAVEform<n2>:TITLE:SHOW <state>

DISPlay:PESQ<n2>:TITLE:SHOW <state>

DISPlay:BARGraph<n2>:TITLE:SHOW <state>

DISPlay:SWEep<n2>:TITLE:SHOW <state>

Parameters:

<state> ON | OFF

Manual operation: See ["Show Title Show Leg A , Show Leg B"](#) on page 720

DISPlay:FFT<n2>:TRACk:LIMit <state>

DISPlay:WAVEform<n2>:TRACk:LIMit <state>

DISPlay:BARGraph<n2>:TRACk:LIMit <state>

DISPlay:PESQ<n2>:TRACk:LIMit <state>

DISPlay:SWEep<n2>:TRACk:LIMit <state>

Parameters:

<state> ON | OFF

Manual operation: See ["Track"](#) on page 687

DISPlay:FFT<n2>:TRACk:REFerence <state>

DISPlay:WAVEform<n2>:TRACk:REFerence <state>

DISPlay:BARGraph<n2>:TRACk:REFerence <state>

DISPlay:SWEep<n2>:TRACk:REFerence <state>

Parameters:

<state> ON | OFF

Manual operation: See ["Track"](#) on page 687

DISPlay:FFT<n2>:TRACk:SCALing <state>

DISPlay:WAVeform<n2>:TRACk:SCALing <state>

DISPlay:BARGraph<n2>:TRACk:SCALing <state>

DISPlay:PESQ<n2>:TRACk:SCALing <state>

DISPlay:SWEep<n2>:TRACk:SCALing <state>

Parameters:

<state> ON | OFF

Manual operation: See ["Track"](#) on page 687

DISPlay:SWEep<n2>:X:AXIS <axis>

Parameters:

<axis> TIME | VOLTage | FREQuency | PHASe | VDIGital |
JPKamplitude | TIME | VOLTage | FREQuency | PHASe |
VDIGital

Manual operation: See ["X-axis "](#) on page 712

DISPlay:FFT<n2>:X:LABel:AUTO <state>

DISPlay:WAVeform<n2>:X:LABel:AUTO <state>

DISPlay:PESQ<n2>:X:LABel:AUTO <state>

DISPlay:SWEep<n2>:X:LABel:AUTO <state>

Parameters:

<state> ON | OFF

Manual operation: See ["Label Auto"](#) on page 715

DISPlay:FFT<n2>:X:LABel:USER <user>

DISPlay:WAVeform<n2>:X:LABel:USER <user>

DISPlay:PESQ<n2>:X:LABel:USER <user>

DISPlay:SWEep<n2>:X:LABel:USER <user>

Parameters:

<user> string

Manual operation: See ["Label Auto"](#) on page 715

DISPlay:FFT<n2>:X:LEFT <left>

DISPlay:WAVeform<n2>:X:LEFT <left>

DISPlay:PESQ<n2>:X:LEFT <left>
DISPlay:SWEep<n2>:X:LEFT <left>

Parameters:

<left> float

Manual operation: See "[Left](#)" on page 717

DISPlay:FFT<n2>:X:REFerence:VALue <value>
DISPlay:WAVeform<n2>:X:REFerence:VALue <value>
DISPlay:SWEep<n2>:X:REFerence:VALue <value>

Parameters:

<value> float

Manual operation: See "[Ref Value](#)" on page 716

DISPlay:FFT<n2>:X:RIGHT <right>
DISPlay:WAVeform<n2>:X:RIGHT <right>
DISPlay:PESQ<n2>:X:RIGHT <right>
DISPlay:SWEep<n2>:X:RIGHT <right>

Parameters:

<right> float

Manual operation: See "[Right](#)" on page 718

DISPlay:FFT<n2>:X:SCALing <scaling>
DISPlay:WAVeform<n2>:X:SCALing <scaling>
DISPlay:PESQ<n2>:X:SCALing <scaling>
DISPlay:SWEep<n2>:X:SCALing <scaling>

Parameters:

<scaling> AUTO | MANual

Manual operation: See "[Scaling](#)" on page 717

DISPlay:SWEep<n2>:X:SOURce <source>

Parameters:

<source> SWEep | HOLD | MANual | LRMS | LDC | LPEak | FREQuency

Manual operation: See "[X-Source](#)" on page 710

DISPlay:FFT<n2>:X:SPACing <spacing>
DISPlay:WAVeform<n2>:X:SPACing <spacing>
DISPlay:PESQ<n2>:X:SPACing <spacing>
DISPlay:SWEep<n2>:X:SPACing <spacing>

Parameters:

<spacing> LINear | LOGarithmic

Manual operation: See "[Spacing](#)" on page 717

DISPlay:FFT<n2>:X:UNIT <unit>
DISPlay:WAVeform<n2>:X:UNIT <unit>
DISPlay:PESQ<n2>:X:UNIT <unit>
DISPlay:SWEep<n2>:X:UNIT <unit>

It is recommended to use the command recording in order to find the correct unit parameter, see [chapter 6.7, "Command Recording"](#), on page 826 .

Parameters:

<unit> string

Manual operation: See "[Unit](#)" on page 714

DISPlay:FFT<n2>:X:UNIT:AUTO <state>
DISPlay:WAVeform<n2>:X:UNIT:AUTO <state>
DISPlay:PESQ<n2>:X:UNIT:AUTO <state>
DISPlay:SWEep<n2>:X:UNIT:AUTO <state>

Parameters:

<state> ON | OFF

Manual operation: See "[Unit Auto](#)" on page 716

DISPlay:FFT<n2>:X:UNIT:USER <user>
DISPlay:WAVeform<n2>:X:UNIT:USER <user>
DISPlay:PESQ<n2>:X:UNIT:USER <user>
DISPlay:SWEep<n2>:X:UNIT:USER <user>

Parameters:

<user> string

Manual operation: See "[Unit User String](#)" on page 716

MMEMory:FFT<n2>:EQUalization:INVert <state>
MMEMory:SWEep<n2>:EQUalization:INVert <state>

Parameters:

<state> ON | OFF

Manual operation: See "[Invert](#)" on page 723

MMEMory:FFT<n2>:EQUalization:MODify <state>
MMEMory:SWEep<n2>:EQUalization:MODify <state>

Parameters:

<state> ON | OFF

Manual operation: See "[Modify Equ.](#)" on page 723

MMEMory:FFT<n2>:EQUalization:NORMfrequency <normfrequency>
MMEMory:SWEep<n2>:EQUalization:NORMfrequency <normfrequency>

Parameters:

<normfrequency> float

Manual operation: See "[Norm Freq](#)" on page 722

MMEMory:FFT<n2>:LIMit:OFFSet <state>
MMEMory:BARGraph<n2>:LIMit:OFFSet <state>
MMEMory:PESQ<n2>:LIMit:OFFSet <state>
MMEMory:SWEep<n2>:LIMit:OFFSet <state>

Parameters:

<state> ON | OFF

Manual operation: See "[Offset](#)" on page 724

MMEMory:FFT<n2>:LIMit:OFFSet:VALue <value>
MMEMory:BARGraph<n2>:LIMit:OFFSet:VALue <value>
MMEMory:PESQ<n2>:LIMit:OFFSet:VALue <value>
MMEMory:SWEep<n2>:LIMit:OFFSet:VALue <value>

Parameters:

<value> float

Manual operation: See "[Offset Value](#)" on page 724

MMEMory:FFT<n2>:STAS <stas>
MMEMory:WAVEform<n2>:STAS <stas>
MMEMory:BARGraph<n2>:STAS <stas>
MMEMory:PESQ<n2>:STAS <stas>
MMEMory:SWEep<n2>:STAS <stas>

Parameters:

<stas> TRCList | EQUList | SWPList | LLISList | DSElect

Manual operation: See "[Store Trace as](#)" on page 721

MMEMory:FFT<n2>:STORE <store>
MMEMory:WAVEform<n2>:STORE <store>
MMEMory:BARGraph<n2>:STORE <store>
MMEMory:PESQ<n2>:STORE <store>
MMEMory:SWEep<n2>:STORE <store>

Parameters:

<store> 'filename'

Manual operation: See "[Store Trace to](#)" on page 725

MMEMory:FFT<n2>:TRACe <trace>
MMEMory:BARGraph<n2>:TRACe <trace>

MMEMory:PESQ<n2>:TRACe <trace>

MMEMory:SWEep<n2>:TRACe <trace>

Parameters:

<trace> A | B

Manual operation: See "[Trace](#)" on page 722

SENSe<n1>:CONFig:COPYother <state>

Suffix:

<n1> 1 | 2 | 6

Parameters:

<state> ONCE | EXEC

Manual operation: See "[Copy to other Windows](#)" on page 674

See "[Copy to Ch2](#)" on page 751

7.28 Combi Display

7.28.1 Measurement Result Configuration

- [SENSe3:FREQuency:LEFT](#) on page 994
- [SENSe3:FREQuency:LIMLower](#) on page 994
- [SENSe3:FREQuency:LIMLower:VALue](#) on page 994
- [SENSe3:FREQuency:LIMUpper](#) on page 995
- [SENSe3:FREQuency:LIMUpper:VALue](#) on page 995
- [SENSe3:FREQuency:REFerence](#) on page 995
- [SENSe3:FREQuency:REFerence:MODE](#) on page 995
- [SENSe3:FREQuency:RIGHT](#) on page 995
- [SENSe3:FREQuency:UNAuto](#) on page 996
- [SENSe3:FREQuency:UNIT](#) on page 996
- [SENSe3:FREQuency:USERunit](#) on page 996
- [SENSe3:GROUpdelay:REFerence](#) on page 996
- [SENSe<n1>:LEFT<n2>](#) on page 996
- [SENSe<n1>:LIMLower<n2>](#) on page 997
- [SENSe<n1>:LIMLower<n2>:VALue](#) on page 997
- [SENSe<n1>:LIMUpper<n2>](#) on page 997
- [SENSe<n1>:LIMUpper<n2>:VALue](#) on page 997
- [SENSe3:PHASe:LEFT](#) on page 997

- [SENSe3:PHASe:LIMLower](#) on page 997
- [SENSe3:PHASe:LIMLower:VALue](#) on page 998
- [SENSe3:PHASe:LIMUpper](#) on page 998
- [SENSe3:PHASe:LIMUpper:VALue](#) on page 998
- [SENSe3:PHASe:REFerence](#) on page 998
- [SENSe3:PHASe:REFerence:MODE](#) on page 998
- [SENSe3:PHASe:RIGHT](#) on page 999
- [SENSe3:PHASe:UNAuto](#) on page 999
- [SENSe3:PHASe:UNIT](#) on page 999
- [SENSe3:PHASe:UNAuto](#) on page 999
- [SENSe<n1>:REFerence<n2>](#) on page 999
- [SENSe<n1>:REFerence<n2>:MODE<n3>](#) on page 1000
- [SENSe<n1>:RIGHT<n2>](#) on page 1000
- [SENSe<n1>:UNAuto<n2>](#) on page 1000
- [SENSe<n1>:UNIT<n2>](#) on page 1000
- [SENSe<n1>:USERunit<n2>](#) on page 1001

SENSe3:FREQUency:LEFT <left>

Suffix:

3 3 = frequency, phase, or group delay measurement

Parameters:

<left> float

Manual operation: See "[Left](#)" on page 757

SENSe3:FREQUency:LIMLower <limlower>

Suffix:

3 3 = frequency, phase, and group delay-measurement

Parameters:

<limlower> ON | OFF

Manual operation: See "[Limit Lower](#)" on page 759

SENSe3:FREQUency:LIMLower:VALue <value>

Suffix:

3 3 = frequency, phase, and group delay-measurement

Parameters:

<value> float

Manual operation: See "[Limit Lower](#)" on page 759

SENSe3:FREQuency:LIMUpper <limupper>**Suffix:**

3 3 = frequency, phase, and group delay-measurement

Parameters:

<limupper> ON | OFF

Manual operation: See "[Limit Upper](#)" on page 761

SENSe3:FREQuency:LIMUpper:VALue <value>**Suffix:**

3 3 = frequency, phase and group delay measurement

Parameters:

<value> float

Manual operation: See "[Limit Upper](#)" on page 761

SENSe3:FREQuency:REFerence <reference>**Suffix:**

3 3 = frequency, phase, or group delay measurement

Parameters:

<reference> float

Manual operation: See "[Reference](#)" on page 754

SENSe3:FREQuency:REFerence:MODE <mode>**Suffix:**

3 3 = frequency, phase, or group delay measurement

Parameters:<mode> CH1Meas | CH2Meas | VALue | STORe | SOURce | GENTrack |
DIGoutampl | MREFchannel | CH1Store | CH2Store |
CH3Store | CH4Store | CH5Store | CH6Store | CH7Store |
CH8Store | CH9Store | CH10Store | CH11Store | CH12Store |
CH13Store | CH14Store | CH15Store | CH16Store**Manual operation:** See "[Reference](#)" on page 754

SENSe3:FREQuency:RIGHT <right>**Suffix:**

3 3 = frequency, phase, or group delay measurement

Parameters:

<right> float

Manual operation: See "[Right](#)" on page 757

SENSe3:FREQuency:UNAuto <unauto>**Suffix:**

3 3 = frequency, phase, or group delay measurement

Parameters:

<state> ON | OFF

Manual operation: See "[Unit Auto](#)" on page 752

SENSe3:FREQuency:UNIT <unit>It is recommended to use the command recording in order to find the correct unit parameter, see [chapter 6.7, "Command Recording"](#), on page 826 .**Suffix:**

3 3 = frequency, phase, or group delay measurement

Parameters:

<unit> selection

Manual operation: See "[Unit](#)" on page 751

SENSe3:FREQuency:USERunit <userunit>**Suffix:**

3 3 = frequency, phase, or group delay measurement

Parameters:

<userunit> string

Manual operation: See "[Unit Auto](#)" on page 752

SENSe3:GROUpdelay:REFerence <reference>**Parameters:**

<reference> float

Manual operation: See "[Reference](#)" on page 754

SENSe<n1>:LEFT<n2> <left>**Suffix:**

<n1> 1 | 2 | 6

<n2> 1 | 2

Parameters:

<left> float

Manual operation: See "[Left](#)" on page 757

SENSe<n1>:LIMLower<n2> <limlower>

Suffix:

<n1> 1 | 2 | 6

<n2> 1 | 2

Parameters:

<limlower> ON | OFF

Manual operation: See "[Limit Lower](#)" on page 759

SENSe<n1>:LIMLower<n2>:VALue <value>

Suffix:

<n1> 1 | 2 | 6

<n2> 1 | 2

Parameters:

<value> float

Manual operation: See "[Limit Lower](#)" on page 759

SENSe<n1>:LIMUpper<n2> <limupper>

Parameters:

<limupper> ON | OFF

Manual operation: See "[Limit Upper](#)" on page 761

SENSe<n1>:LIMUpper<n2>:VALue <value>

Parameters:

<value> float

Manual operation: See "[Limit Upper](#)" on page 761

SENSe3:PHASe:LEFT <left>

Suffix:

3 3 = frequency, phase, or group delay measurement

Parameters:

<left> float

Manual operation: See "[Left](#)" on page 757

SENSe3:PHASe:LIMLower <limlower>

Suffix:

3 3 = frequency, phase, or group delay measurement

Parameters:

<limlower> ON | OFF

Manual operation: See "[Limit Lower](#)" on page 759

SENSe3:PHASe:LIMLower:VALue <value>**Suffix:**

3 3 = frequency, phase, or group delay measurement

Parameters:

<value> float

Manual operation: See "[Limit Lower](#)" on page 759

SENSe3:PHASe:LIMUpper <limupper>**Suffix:**

3 3 = frequency, phase, or group delay measurement

Parameters:

<limupper> ON | OFF

Manual operation: See "[Limit Upper](#)" on page 761

SENSe3:PHASe:LIMUpper:VALue <value>**Suffix:**

3 3 = frequency, phase, or group delay measurement

Parameters:

<value> float

Manual operation: See "[Limit Upper](#)" on page 761

SENSe3:PHASe:REFerence <reference>**Suffix:**

3 3 = frequency, phase, or group delay measurement

Parameters:

<reference> float

Manual operation: See "[Reference](#)" on page 754

SENSe3:PHASe:REFerence:MODE <mode>**Suffix:**

3 3 = frequency, phase, or group delay measurement

Parameters:

<mode> STORe | VALue | GENTrack

Manual operation: See ["Reference"](#) on page 754

SENSe3:PHASe:RIGHT <right>

Suffix:

3 3 = frequency, phase, or group delay measurement

Parameters:

<right> float

Manual operation: See ["Right"](#) on page 757

SENSe3:PHASe:UNAuto <unauto>

Suffix:

3 3 = frequency, phase, or group delay measurement

Parameters:

<unauto> ON | OFF

Manual operation: See ["Unit Auto"](#) on page 752

SENSe3:PHASe:UNIT <unit>

Suffix:

3 3 = frequency, phase, or group delay measurement

Parameters:

<unit> selection

Manual operation: See ["Unit"](#) on page 751

SENSe3:PHASe:USERunit <userunit>

Suffix:

3 3 = frequency, phase, or group delay measurement

Parameters:

<userunit> string

Manual operation: See ["Unit Auto"](#) on page 752

SENSe<n1>:REFerence<n2> <reference>

Suffix:

<n1> specifies the type of measurement.
 1 = function measurement (level / signal to noise / distortion, ...)
 2 = input monitor measurement
 6 = level monitor measurement

Parameters:

<reference> float

Manual operation: See ["Reference"](#) on page 754

SENSe<n1>:REFerence<n2>:MODE<n3> <mode>

Suffix:

<n1> specifies the type of measurement.
 1 = function measurement (level / signal to noise / distortion, ...)
 2 = input monitor measurement
 6 = level monitor measurement

Parameters:

<mode> CH1Meas | CH2Meas | VALue | STORe | SOURce | GENTrack |
 MREFchannel | CH1Store | CH2Store | CH3Store | CH4Store |
 CH5Store | CH6Store | CH7Store | CH8Store | | CH9Store |
 CH10Store | CH11Store | CH12Store | CH13Store | CH14Store |
 CH15Store | CH16Store | DIGoutampl

Manual operation: See ["Reference"](#) on page 754

SENSe<n1>:RIGHt<n2> <right>

Suffix:

<n1> 1 | 2 | 6
 <n2> 1 | 2

Parameters:

<right> float

Manual operation: See ["Right"](#) on page 757

SENSe<n1>:UNAuto<n2> <unauto>

Suffix:

<n1> specifies the type of measurement.
 1 = function measurement (level / signal to noise / distortion, ...)
 2 = input monitor measurement
 6 = level monitor measurement

Parameters:

<unauto> ON | OFF

Manual operation: See ["Unit Auto"](#) on page 752

SENSe<n1>:UNIT<n2> <unit>

This command cannot be recorded, see [chapter 6.7, "Command Recording"](#), on page 826 .

Suffix:
 <n1> specifies the type of measurement.
 1 = function measurement (level / signal to noise / distortion, ...)
 2 = input monitor measurement
 6 = level monitor measurement

Parameters:
 <unit> selection

Manual operation: See "Unit" on page 751

SENSe<n1>:USERunit<n2> <userunit>

Suffix:
 <n1> specifies the type of measurement.
 1 = function measurement (level / signal to noise / distortion, ...)
 2 = input monitor measurement
 6 = level monitor measurement

<n2> 1 | 2

Parameters:
 <userunit> string

Manual operation: See "Unit Auto" on page 752

7.29 Generation of Protocol Data

SOURce:PROTocol:CH<n3>:BYTE<n4> <byte>

This command combines the following three commands in one :

- [SOURce:PROTocol:NUMerical:BYTE](#) on page 886
- [SOURce:PROTocol:NUMerical:CH](#) on page 886
- [SOURce:PROTocol:NUMerical:VALue](#) on page 886

Suffix:
 <n3> channel 1 or 2
 <n4> byte 0 to 3

Parameters:
 <byte> 0 to 255
 decimal bit equivalent

Example: `SOUR:PROT:CH:BYTE2 31`
 Sets the protocol data of byte 2 (the third byte) of channel 1 to 31 = 1Fh = 00011111b .

Manual operation: See "Channel" on page 343
 See "Byte Number" on page 343
 See "Value " on page 343

7.30 Softkey Commands of the Graphical Display

This section includes all commands of the softkey menu of the graphical and list displays. These commands cannot be recorded.

Only a few commands are allowed in all subsystems. Commands that are not allowed in a subsystem are not listed here.

In the `BARGraph` subsystem, for example, there are no markers.

The `DISPlay:BARGraph<n2>:A|B:MARKer:HARMonics ON | OFF` command is thus not allowed, and is not listed in the following command description.

The value range for suffix `<n2>` depends on the subsystem:

| | |
|--|-----------------------------------|
| For the Subsystem Sweep: | <code><n2> = 1 ... 4</code> |
| For the Subsystem FFT: | <code><n2> = 1 2</code> |
| For the Subsystem <code>BARGraph</code> : | <code><n2> = 1 2</code> |
| For the Subsystems <code>WAVEform</code> : | <code><n2> = 1</code> |
| For the Subsystems <code>PESQ</code> : | <code><n2> = 1 2</code> |

- [DISPlay:BARGraph<n2>:DLISt:FILTer](#) on page 986
- [DISPlay:BARGraph<n2>:OCURsor:MODE](#) on page 1008
- [DISPlay:BARGraph<n2>:OCURsor:POSMode](#) on page 1009
- [DISPlay:BARGraph<n2>:OCURsor:SETTo:MAX](#) on page 1009
- [DISPlay:BARGraph<n2>:OCURsor:SETTo:MIN](#) on page 1010
- [DISPlay:BARGraph<n2>:OCURsor:SETTo:XPOS](#) on page 1011
- [DISPlay:BARGraph<n2>:OCURsor:SETTo:YPOS](#) on page 1012
- [DISPlay:BARGraph<n2>:OCURsor:STATe](#) on page 1013
- [DISPlay:BARGraph<n2>:OCURsor:Y?](#) on page 1013
- [DISPlay:BARGraph<n2>:XCURsor:MODE](#) on page 1008
- [DISPlay:BARGraph<n2>:XCURsor:POSMode](#) on page 1009
- [DISPlay:BARGraph<n2>:XCURsor:SETTo:MAX](#) on page 1009
- [DISPlay:BARGraph<n2>:XCURsor:SETTo:MIN](#) on page 1010
- [DISPlay:BARGraph<n2>:XCURsor:SETTo:XPOS](#) on page 1011
- [DISPlay:BARGraph<n2>:XCURsor:SETTo:YPOS](#) on page 1012
- [DISPlay:BARGraph<n2>:XCURsor:STATe](#) on page 1013
- [DISPlay:BARGraph<n2>:XCURsor:Y?](#) on page 1013
- [DISPlay:FFT<n2>:A:MARKer:HARMonics](#) on page 1006
- [DISPlay:FFT<n2>:A:MARKer:MODE](#) on page 1006
- [DISPlay:FFT<n2>:A:MARKer:SETTo:OCURsor](#) on page 1006
- [DISPlay:FFT<n2>:A:MARKer:SETTo:XCURsor](#) on page 1006
- [DISPlay:FFT<n2>:A:MARKer:SETTo:XPOS](#) on page 1007

- [DISPlay:FFT<n2>:B:MARKer:HARMonics](#) on page 1006
- [DISPlay:FFT<n2>:B:MARKer:MODE](#) on page 1006
- [DISPlay:FFT<n2>:B:MARKer:SETTo:OCURsor](#) on page 1006
- [DISPlay:FFT<n2>:B:MARKer:SETTo:XCURsor](#) on page 1007
- [DISPlay:FFT<n2>:B:MARKer:SETTo:XPOS](#) on page 1007
- [DISPlay:FFT<n2>:DLISt:FILTer](#) on page 986
- [DISPlay:FFT<n2>:OCURsor:MODE](#) on page 1008
- [DISPlay:FFT<n2>:OCURsor:POSMode](#) on page 1008
- [DISPlay:FFT<n2>:OCURsor:SETTo:MAX](#) on page 1009
- [DISPlay:FFT<n2>:OCURsor:SETTo:MIN](#) on page 1010
- [DISPlay:FFT<n2>:OCURsor:SETTo:MRKA](#) on page 1010
- [DISPlay:FFT<n2>:OCURsor:SETTo:MRKB](#) on page 1011
- [DISPlay:FFT<n2>:OCURsor:SETTo:XPOS](#) on page 1011
- [DISPlay:FFT<n2>:OCURsor:SETTo:YPOS](#) on page 1012
- [DISPlay:FFT<n2>:OCURsor:STATe](#) on page 1012
- [DISPlay:FFT<n2>:OCURsor:Y?](#) on page 1013
- [DISPlay:FFT<n2>:XCURsor:MODE](#) on page 1008
- [DISPlay:FFT<n2>:XCURsor:POSMode](#) on page 1008
- [DISPlay:FFT<n2>:XCURsor:SETTo:MAX](#) on page 1009
- [DISPlay:FFT<n2>:XCURsor:SETTo:MIN](#) on page 1010
- [DISPlay:FFT<n2>:XCURsor:SETTo:MRKA](#) on page 1010
- [DISPlay:FFT<n2>:XCURsor:SETTo:MRKB](#) on page 1011
- [DISPlay:FFT<n2>:XCURsor:SETTo:XPOS](#) on page 1011
- [DISPlay:FFT<n2>:XCURsor:SETTo:YPOS](#) on page 1012
- [DISPlay:FFT<n2>:XCURsor:STATe](#) on page 1012
- [DISPlay:FFT<n2>:XCURsor:Y?](#) on page 1013
- [DISPlay:PESQ<n2>:A:MARKer:MODE](#) on page 1006
- [DISPlay:PESQ<n2>:A:MARKer:SETTo:OCURsor](#) on page 1007
- [DISPlay:PESQ<n2>:A:MARKer:SETTo:XCURsor](#) on page 1007
- [DISPlay:PESQ<n2>:A:MARKer:SETTo:XPOS](#) on page 1007
- [DISPlay:PESQ<n2>:B:MARKer:MODE](#) on page 1006
- [DISPlay:PESQ<n2>:B:MARKer:SETTo:OCURsor](#) on page 1007
- [DISPlay:PESQ<n2>:B:MARKer:SETTo:XCURsor](#) on page 1007
- [DISPlay:PESQ<n2>:B:MARKer:SETTo:XPOS](#) on page 1007
- [DISPlay:PESQ<n2>:DLISt:FILTer](#) on page 986
- [DISPlay:PESQ<n2>:OCURsor:MODE](#) on page 1008
- [DISPlay:PESQ<n2>:OCURsor:POSMode](#) on page 1009
- [DISPlay:PESQ<n2>:OCURsor:SETTo:MAX](#) on page 1009

- [DISPlay:PESQ<n2>:OCURsor:SETTo:MIN](#) on page 1010
- [DISPlay:PESQ<n2>:OCURsor:SETTo:MRKA](#) on page 1010
- [DISPlay:PESQ<n2>:OCURsor:SETTo:MRKB](#) on page 1011
- [DISPlay:PESQ<n2>:OCURsor:SETTo:XPOS](#) on page 1011
- [DISPlay:PESQ<n2>:OCURsor:SETTo:YPOS](#) on page 1012
- [DISPlay:PESQ<n2>:OCURsor:STATe](#) on page 1012
- [DISPlay:PESQ<n2>:OCURsor:Y?](#) on page 1013
- [DISPlay:PESQ<n2>:XCURsor:MODE](#) on page 1008
- [DISPlay:PESQ<n2>:XCURsor:POSMode](#) on page 1009
- [DISPlay:PESQ<n2>:XCURsor:SETTo:MAX](#) on page 1009
- [DISPlay:PESQ<n2>:XCURsor:SETTo:MIN](#) on page 1010
- [DISPlay:PESQ<n2>:XCURsor:SETTo:MRKA](#) on page 1011
- [DISPlay:PESQ<n2>:XCURsor:SETTo:MRKB](#) on page 1011
- [DISPlay:PESQ<n2>:XCURsor:SETTo:XPOS](#) on page 1011
- [DISPlay:PESQ<n2>:XCURsor:SETTo:YPOS](#) on page 1012
- [DISPlay:PESQ<n2>:XCURsor:STATe](#) on page 1012
- [DISPlay:PESQ<n2>:XCURsor:Y?](#) on page 1013
- [DISPlay:SWEep<n2>:A:MARKer:MODE](#) on page 1006
- [DISPlay:SWEep<n2>:A:MARKer:SETTo:OCURsor](#) on page 1007
- [DISPlay:SWEep<n2>:A:MARKer:SETTo:XCURsor](#) on page 1007
- [DISPlay:SWEep<n2>:A:MARKer:SETTo:XPOS](#) on page 1007
- [DISPlay:SWEep<n2>:B:MARKer:MODE](#) on page 1006
- [DISPlay:SWEep<n2>:B:MARKer:SETTo:OCURsor](#) on page 1007
- [DISPlay:SWEep<n2>:B:MARKer:SETTo:XCURsor](#) on page 1007
- [DISPlay:SWEep<n2>:B:MARKer:SETTo:XPOS](#) on page 1007
- [DISPlay:SWEep<n2>:DLISt:FILTer](#) on page 986
- [DISPlay:SWEep<n2>:OCURsor:MODE](#) on page 1008
- [DISPlay:SWEep<n2>:OCURsor:POSMode](#) on page 1009
- [DISPlay:SWEep<n2>:OCURsor:SETTo:MAX](#) on page 1009
- [DISPlay:SWEep<n2>:OCURsor:SETTo:MIN](#) on page 1010
- [DISPlay:SWEep<n2>:OCURsor:SETTo:MRKA](#) on page 1011
- [DISPlay:SWEep<n2>:OCURsor:SETTo:MRKB](#) on page 1011
- [DISPlay:SWEep<n2>:OCURsor:SETTo:XPOS](#) on page 1012
- [DISPlay:SWEep<n2>:OCURsor:SETTo:YPOS](#) on page 1012
- [DISPlay:SWEep<n2>:OCURsor:STATe](#) on page 1013
- [DISPlay:SWEep<n2>:OCURsor:Y?](#) on page 1013
- [DISPlay:SWEep<n2>:XCURsor:MODE](#) on page 1008
- [DISPlay:SWEep<n2>:XCURsor:POSMode](#) on page 1009

- [DISPlay:SWEEp<n2>:XCURsor:SETTo:MAX](#) on page 1009
- [DISPlay:SWEEp<n2>:XCURsor:SETTo:MIN](#) on page 1010
- [DISPlay:SWEEp<n2>:XCURsor:SETTo:MRKA](#) on page 1011
- [DISPlay:SWEEp<n2>:XCURsor:SETTo:MRKB](#) on page 1011
- [DISPlay:SWEEp<n2>:XCURsor:SETTo:XPOS](#) on page 1012
- [DISPlay:SWEEp<n2>:XCURsor:SETTo:YPOS](#) on page 1012
- [DISPlay:SWEEp<n2>:XCURsor:STAtE](#) on page 1013
- [DISPlay:SWEEp<n2>:XCURsor:Y?](#) on page 1013
- [DISPlay:WAVeform<n2>:A:MARKer:MODE](#) on page 1006
- [DISPlay:WAVeform<n2>:A:MARKer:SETTo:OCURsor](#) on page 1007
- [DISPlay:WAVeform<n2>:A:MARKer:SETTo:XCURsor](#) on page 1007
- [DISPlay:WAVeform<n2>:A:MARKer:SETTo:XPOS](#) on page 1007
- [DISPlay:WAVeform<n2>:B:MARKer:MODE](#) on page 1006
- [DISPlay:WAVeform<n2>:B:MARKer:SETTo:OCURsor](#) on page 1007
- [DISPlay:WAVeform<n2>:B:MARKer:SETTo:XCURsor](#) on page 1007
- [DISPlay:WAVeform<n2>:B:MARKer:SETTo:XPOS](#) on page 1007
- [DISPlay:WAVeform<n2>:DLISt:FILTer](#) on page 986
- [DISPlay:WAVeform<n2>:OCURsor:MODE](#) on page 1008
- [DISPlay:WAVeform<n2>:OCURsor:POSMode](#) on page 1008
- [DISPlay:WAVeform<n2>:OCURsor:SETTo:MAX](#) on page 1009
- [DISPlay:WAVeform<n2>:OCURsor:SETTo:MIN](#) on page 1010
- [DISPlay:WAVeform<n2>:OCURsor:SETTo:MRKA](#) on page 1010
- [DISPlay:WAVeform<n2>:OCURsor:SETTo:MRKB](#) on page 1011
- [DISPlay:WAVeform<n2>:OCURsor:SETTo:XPOS](#) on page 1011
- [DISPlay:WAVeform<n2>:OCURsor:SETTo:YPOS](#) on page 1012
- [DISPlay:WAVeform<n2>:OCURsor:STAtE](#) on page 1012
- [DISPlay:WAVeform<n2>:OCURsor:Y?](#) on page 1013
- [DISPlay:WAVeform<n2>:XCURsor:MODE](#) on page 1008
- [DISPlay:WAVeform<n2>:XCURsor:POSMode](#) on page 1008
- [DISPlay:WAVeform<n2>:XCURsor:SETTo:MAX](#) on page 1009
- [DISPlay:WAVeform<n2>:XCURsor:SETTo:MIN](#) on page 1010
- [DISPlay:WAVeform<n2>:XCURsor:SETTo:MRKA](#) on page 1010
- [DISPlay:WAVeform<n2>:XCURsor:SETTo:MRKB](#) on page 1011
- [DISPlay:WAVeform<n2>:XCURsor:SETTo:XPOS](#) on page 1011
- [DISPlay:WAVeform<n2>:XCURsor:SETTo:YPOS](#) on page 1012
- [DISPlay:WAVeform<n2>:XCURsor:STAtE](#) on page 1012
- [DISPlay:WAVeform<n2>:XCURsor:Y?](#) on page 1013

DISPlay:FFT<n2>:A:MARKer:HARMonics <state>

DISPlay:FFT<n2>:B:MARKer:HARMonics <state>

Corresponds to softkey operation:

Marker,

Trace A | Trace B,

Harm

Parameters:

<state> ON | OFF

ON

The harmonics are calculated and displayed, starting from the X position of the marker.

OFF

Display of the harmonics is switched off.

Example: `DISPlay:FFT2:A:MARKer:HARMonics ON`

DISPlay:FFT<n2>:A:MARKer:MODE <mode>

DISPlay:FFT<n2>:B:MARKer:MODE <mode>

DISPlay:WAVeform<n2>:A:MARKer:MODE <mode>

DISPlay:WAVeform<n2>:B:MARKer:MODE <mode>

DISPlay:PESQ<n2>:A:MARKer:MODE <mode>

DISPlay:PESQ<n2>:B:MARKer:MODE <mode>

DISPlay:SWEep<n2>:A:MARKer:MODE <mode>

DISPlay:SWEep<n2>:B:MARKer:MODE <mode>

Corresponds to softkey operation:

Marker,

Trace A | Trace B,

Off | Track to Max

Parameters:

<mode> OFF | FIXed | TRKMax

OFF

Marker off

FIXed

Fix marker on the current X position

TRKMax

Set marker to maximum of trace A. Marker changes with maximum.

Example: `DISPlay:FFT:B:MARKer:MODE TRKMax`

DISPlay:FFT<n2>:A:MARKer:SETTo:OCURsor <state>

DISPlay:FFT<n2>:A:MARKer:SETTo:XCURsor <state>

DISPlay:FFT<n2>:B:MARKer:SETTo:OCURsor <state>

DISPlay:FFT<n2>:B:MARKer:SETTo:XCURsor <state>
DISPlay:WAVEform<n2>:A:MARKer:SETTo:OCURsor <state>
DISPlay:WAVEform<n2>:A:MARKer:SETTo:XCURsor <state>
DISPlay:WAVEform<n2>:B:MARKer:SETTo:OCURsor <state>
DISPlay:WAVEform<n2>:B:MARKer:SETTo:XCURsor <state>
DISPlay:PESQ<n2>:A:MARKer:SETTo:OCURsor <state>
DISPlay:PESQ<n2>:A:MARKer:SETTo:XCURsor <state>
DISPlay:PESQ<n2>:B:MARKer:SETTo:OCURsor <state>
DISPlay:PESQ<n2>:B:MARKer:SETTo:XCURsor <state>
DISPlay:SWEep<n2>:A:MARKer:SETTo:OCURsor <state>
DISPlay:SWEep<n2>:A:MARKer:SETTo:XCURsor <state>
DISPlay:SWEep<n2>:B:MARKer:SETTo:OCURsor <state>
DISPlay:SWEep<n2>:B:MARKer:SETTo:XCURsor <state>

Corresponds to softkey operation:

Marker,

Trace A | Trace B,

O Cursor | X Cursor

Parameters:

<state>

ONCE | EXEC

ONCE or EXEC can also be omitted.

ONCE

Set marker to position of O cursor | X cursor

EXEC

Alias to ONCE.

Example:

DISPlay:SWEep:A:MARKer:SETTo:XCURsor

DISPlay:SWEep:A:MARKer:SETTo:XCURsor ONCE

DISPlay:SWEep:A:MARKer:SETTo:XCURsor EXEC

the three commands are equivalent.

DISPlay:FFT<n2>:A:MARKer:SETTo:XPOS <xpos>
DISPlay:FFT<n2>:B:MARKer:SETTo:XPOS <xpos>
DISPlay:WAVEform<n2>:A:MARKer:SETTo:XPOS <xpos>
DISPlay:WAVEform<n2>:B:MARKer:SETTo:XPOS <xpos>
DISPlay:PESQ<n2>:A:MARKer:SETTo:XPOS <xpos>
DISPlay:PESQ<n2>:B:MARKer:SETTo:XPOS <xpos>
DISPlay:SWEep<n2>:A:MARKer:SETTo:XPOS <xpos>
DISPlay:SWEep<n2>:B:MARKer:SETTo:XPOS <xpos>

Corresponds to the softkey operation:

Marker,

Trace A | Trace B,

Set to Value

Parameters:**<xpos>** float

Set marker to a position on the X-axis. The unit for entering the value depends on the unit of the X-axis.

Example:

DISPlay:FFT2:B:MARKer:SETTo:XPOS 12.345 Hz

DISPlay:FFT<n2>:OCURsor:MODE <mode>
DISPlay:FFT<n2>:XCURsor:MODE <mode>
DISPlay:WAVEform<n2>:OCURsor:MODE <mode>
DISPlay:WAVEform<n2>:XCURsor:MODE <mode>
DISPlay:PESQ<n2>:OCURsor:MODE <mode>
DISPlay:PESQ<n2>:XCURsor:MODE <mode>
DISPlay:BARGraph<n2>:OCURsor:MODE <mode>
DISPlay:BARGraph<n2>:XCURsor:MODE <mode>
DISPlay:SWEep<n2>:OCURsor:MODE <mode>
DISPlay:SWEep<n2>:XCURsor:MODE <mode>

Corresponds to softkey operation:

Cursor

O Cursor

O Vert A | O Vert B | O Vert A-B, O Hor A | O Hor B

Cursor

X cursor,

X Vert A | X Vert B | X Vert A-B, X Hor A | X Hor B

Parameters:**<mode>** VA | VB | VAB | HA | HB**VA**

O cursor becomes vertical cursor on trace A

VB

Same on trace B

VAB

Same on trace A and trace B and shows difference between Y values.

HA

O cursor becomes horizontal cursor on trace A

HB

Same on trace B

Example:

DISPlay:BARGraph:XCURsor:MODE VA

DISPlay:FFT<n2>:OCURsor:POSMode <posmode>
DISPlay:FFT<n2>:XCURsor:POSMode <posmode>
DISPlay:WAVEform<n2>:OCURsor:POSMode <posmode>
DISPlay:WAVEform<n2>:XCURsor:POSMode <posmode>

DISPlay:PESQ<n2>:OCURsor:POSMoDe <posmode>
DISPlay:PESQ<n2>:XCURsor:POSMoDe <posmode>
DISPlay:BARGraph<n2>:OCURsor:POSMoDe <posmode>
DISPlay:BARGraph<n2>:XCURsor:POSMoDe <posmode>
DISPlay:SWEep<n2>:OCURsor:POSMoDe <posmode>
DISPlay:SWEep<n2>:XCURsor:POSMoDe <posmode>

Corresponds to softkey operation:

Cursor

O cursor | X cursor

Movement

Next Pixel | Next Bin | Next Sample | Next Value | Next Step | Next Peak | Next Harmonic

Parameters:

<posmode> PIXel | POINT | PEAK | HARMonic

PIXel

Pixel-by-pixel cursor movement

POINT

Same between reference points. An easy-to-remember term is offered for each subsystem in the softkey menu, such as "Next Bin" for FFT, "Next Sample" for waveform, "Next Value" for bar-graph and "Next Step" for sweep; the generic term `POINT` is used for IEC/IEEE bus control to simplify matters.

PEAK

Same between partial curve peaks

HARMonic

Same in the FFT display between harmonics

Example: DISPlay:WAVeform:OCURsor:POSMoDe POINT

DISPlay:FFT<n2>:OCURsor:SETTo:MAX <state>
DISPlay:FFT<n2>:XCURsor:SETTo:MAX <state>
DISPlay:WAVeform<n2>:OCURsor:SETTo:MAX <state>
DISPlay:WAVeform<n2>:XCURsor:SETTo:MAX <state>
DISPlay:PESQ<n2>:OCURsor:SETTo:MAX <state>
DISPlay:PESQ<n2>:XCURsor:SETTo:MAX <state>
DISPlay:BARGraph<n2>:OCURsor:SETTo:MAX <state>
DISPlay:BARGraph<n2>:XCURsor:SETTo:MAX <state>
DISPlay:SWEep<n2>:OCURsor:SETTo:MAX <state>
DISPlay:SWEep<n2>:XCURsor:SETTo:MAX <state>

Corresponds to softkey operation:

Cursor

Set O-Cursor | Set X-Cursor,

Max

Parameters:

<state> ONCE | EXEC
 ONCE or EXEC can also be omitted.

ONCE

Sets O cursor | X Cursor to the curve peak.

EXEC

Alias to ONCE.

Example:

```
DISPlay:SWEEp4:OCURsor:SETTo:MAX
DISPlay:SWEEp4:OCURsor:SETTo:MAX ONCE
DISPlay:SWEEp4:OCURsor:SETTo:MAX EXEC
the three commands are equivalent.
```

```
DISPlay:FFT<n2>:OCURsor:SETTo:MIN <state>
DISPlay:FFT<n2>:XCURsor:SETTo:MIN <state>
DISPlay:WAVEform<n2>:OCURsor:SETTo:MIN <state>
DISPlay:WAVEform<n2>:XCURsor:SETTo:MIN <state>
DISPlay:PESQ<n2>:OCURsor:SETTo:MIN <state>
DISPlay:PESQ<n2>:XCURsor:SETTo:MIN <state>
DISPlay:BARGraph<n2>:OCURsor:SETTo:MIN <state>
DISPlay:BARGraph<n2>:XCURsor:SETTo:MIN <state>
DISPlay:SWEEp<n2>:OCURsor:SETTo:MIN <state>
DISPlay:SWEEp<n2>:XCURsor:SETTo:MIN <state>
```

Corresponds to softkey operation:

Cursor

Set O-Cursor | Set X-Cursor,

Min

Parameters:

<state> ONCE | EXEC
 ONCE or EXEC can also be omitted.

ONCE

Sets O cursor | X Cursor to trace minimum.

EXEC

Alias to ONCE.

Example:

```
DISPlay:SWEEp4:XCURsor:SETTo:MIN
DISPlay:SWEEp4:XCURsor:SETTo:MIN ONCE
DISPlay:SWEEp4:XCURsor:SETTo:MIN EXEC
the three commands are equivalent.
```

```
DISPlay:FFT<n2>:OCURsor:SETTo:MRKA <state>
DISPlay:FFT<n2>:XCURsor:SETTo:MRKA <state>
DISPlay:WAVEform<n2>:OCURsor:SETTo:MRKA <state>
DISPlay:WAVEform<n2>:XCURsor:SETTo:MRKA <state>
DISPlay:PESQ<n2>:OCURsor:SETTo:MRKA <state>
```

DISPlay:PESQ<n2>:XCURsor:SETTo:MRKA <state>
DISPlay:SWEep<n2>:OCURsor:SETTo:MRKA <state>
DISPlay:SWEep<n2>:XCURsor:SETTo:MRKA <state>

Corresponds to softkey operation:

Cursor

Set O cursor | Set X cursor,

Marker A

Parameters:

<state>

ONCE | EXEC

ONCE or EXEC can also be omitted.

ONCE

Sets O cursor | X cursor to the position of marker A

EXEC

Alias to ONCE.

Example:

DISPlay:SWEep4:XCURsor:SETTo:MRKA

DISPlay:SWEep4:XCURsor:SETTo:MRKA ONCE

DISPlay:SWEep4:XCURsor:SETTo:MRKA EXEC

the three commands are equivalent.

DISPlay:FFT<n2>:OCURsor:SETTo:MRKB <state>
DISPlay:FFT<n2>:XCURsor:SETTo:MRKB <state>
DISPlay:WAVeform<n2>:OCURsor:SETTo:MRKB <state>
DISPlay:WAVeform<n2>:XCURsor:SETTo:MRKB <state>
DISPlay:PESQ<n2>:OCURsor:SETTo:MRKB <state>
DISPlay:PESQ<n2>:XCURsor:SETTo:MRKB <state>
DISPlay:SWEep<n2>:OCURsor:SETTo:MRKB <state>
DISPlay:SWEep<n2>:XCURsor:SETTo:MRKB <state>

Corresponds to softkey operation:

Cursor

Set O cursor | Set X cursor,

Marker B

Parameters:

<state>

ONCE | EXEC | OFF

DISPlay:FFT<n2>:OCURsor:SETTo:XPOS <xpos>
DISPlay:FFT<n2>:XCURsor:SETTo:XPOS <xpos>
DISPlay:WAVeform<n2>:OCURsor:SETTo:XPOS <xpos>
DISPlay:WAVeform<n2>:XCURsor:SETTo:XPOS <xpos>
DISPlay:PESQ<n2>:OCURsor:SETTo:XPOS <xpos>
DISPlay:PESQ<n2>:XCURsor:SETTo:XPOS <xpos>
DISPlay:BARGraph<n2>:OCURsor:SETTo:XPOS <xpos>
DISPlay:BARGraph<n2>:XCURsor:SETTo:XPOS <xpos>

DISPlay:SWEep<n2>:OCURsor:SETTo:XPOS <xpos>

DISPlay:SWEep<n2>:XCURsor:SETTo:XPOS <xpos>

Corresponds to softkey operation:

Cursor

Set O cursor | Set X cursor,

Value

Parameters:

<xpos> float
Sets O cursor | X cursor to the defined value if a vertical cursor is involved.
The unit in which the value is entered depends on the unit of the X-axis.

Example: DISPlay:WAVeform:OCURsor:SETTo:XPOS 12.345 Hz

DISPlay:FFT<n2>:OCURsor:SETTo:YPOS <ypos>

DISPlay:FFT<n2>:XCURsor:SETTo:YPOS <ypos>

DISPlay:WAVeform<n2>:OCURsor:SETTo:YPOS <ypos>

DISPlay:WAVeform<n2>:XCURsor:SETTo:YPOS <ypos>

DISPlay:PESQ<n2>:OCURsor:SETTo:YPOS <ypos>

DISPlay:PESQ<n2>:XCURsor:SETTo:YPOS <ypos>

DISPlay:BARGraph<n2>:OCURsor:SETTo:YPOS <ypos>

DISPlay:BARGraph<n2>:XCURsor:SETTo:YPOS <ypos>

DISPlay:SWEep<n2>:OCURsor:SETTo:YPOS <ypos>

DISPlay:SWEep<n2>:XCURsor:SETTo:YPOS <ypos>

Corresponds to the softkey operation:

Cursor

Set O cursor | Set X cursor,

Value

Parameters:

<ypos> float
Sets O cursor | X Cursor to the defined value, if a horizontal cursor is involved.
The unit in which the value is entered depends on the unit of the Y-axis.

Example: DISPlay:WAVeform:XCURsor:SETTo:YPOS -110 DBV

DISPlay:FFT<n2>:OCURsor:STATe <state>

DISPlay:FFT<n2>:XCURsor:STATe <state>

DISPlay:WAVeform<n2>:OCURsor:STATe <state>

DISPlay:WAVeform<n2>:XCURsor:STATe <state>

DISPlay:PESQ<n2>:OCURsor:STATe <state>

DISPlay:PESQ<n2>:XCURsor:STATe <state>

DISPlay:BARGraph<n2>:OCURsor:STATe <state>

DISPlay:BARGraph<n2>:XCURsor:STATe <state>

DISPlay:SWEep<n2>:OCURsor:STATe <state>

DISPlay:SWEep<n2>:XCURsor:STATe <state>

Corresponds to softkey operation:

Cursor

O cursor | X cursor,

O active | X active

Parameters:

<state> OFF | ACTive | INACTive

OFF

O cursor | X cursor off

ACTive

O cursor | X cursor is visible and is controlled from the ROTARY KNOB

INACTive

O cursor | X cursor is visible as a dotted line and can not be controlled.

Example:

DISPlay:BARGraph:OCURsor:STATe OFF

DISPlay:BARGraph2:XCURsor:STATe ACTive

DISPlay:FFT<n2>:OCURsor:Y?

DISPlay:FFT<n2>:XCURsor:Y?

DISPlay:WAVEform<n2>:OCURsor:Y?

DISPlay:WAVEform<n2>:XCURsor:Y?

DISPlay:PESQ<n2>:OCURsor:Y?

DISPlay:PESQ<n2>:XCURsor:Y?

DISPlay:BARGraph<n2>:OCURsor:Y?

DISPlay:BARGraph<n2>:XCURsor:Y?

DISPlay:SWEep<n2>:OCURsor:Y?

DISPlay:SWEep<n2>:XCURsor:Y?

No corresponding function in the softkey menu.

Return values:

<argument> float

Return value:

Reads the current value of the O cursor or X cursor. The return value is a pure numeric value without unit. The numeric value is returned in the unit in which the Y-axis is displayed.

Example:

DISPlay:SWEep:OCURsor:Y

DISPlay:SWEep:XCURsor:Y

Response:-19.4783

Usage:

Query only

7.31 Transferring trace data

Transferring trace data from a controller via the IEC/IEEE bus to the Audio Analyzer allows you to display externally generated or manipulated trace data with the graphical display capabilities of the Audio Analyzer.

Example:

Assume that a fast frequency response measurement using a multisine signal and an FFT has been programmed in a K1 macro. The FFT shows different high lines in the multisine frequencies, with a noise floor between.

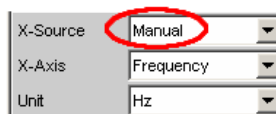
This is not the usual display mode of a frequency response curve.

The K1 macro now generates a sweep trace data set from the levels of the individual bins and their frequency values. This data set is transferred to the Audio Analyzer and is shown in the graphical display as a sweep trace, and thus as a frequency response curve.

When transferring trace data, pure numeric values without units are transferred. Thus, the presetting of the graph must precede the data transfer, and it determines the unit in which the values are interpreted. The number of the transferred X values should also comply with the currently set X-axis of the graphical display.

The transfer of data for the X-axis (...:AX and ...:BX) is reserved exclusively for the sweep subsystem!

"X-Source" must be set to "Manual".



The Y-axes (...:AY and ...:BY) can be transferred for all subsystems without exception.



The output of trace data with the according `TRACe:<subsystem>:LOAD` commands is described in [chapter 7.5.5, "Output of Trace Data Sets"](#), on page 913

- [TRACe:BARGraph<n2>:STORe:AY](#) on page 1015
- [TRACe:BARGraph<n2>:STORe:BY](#) on page 1015
- [TRACe:FFT<n2>:STORe:AY](#) on page 1015
- [TRACe:FFT<n2>:STORe:BY](#) on page 1015
- [TRACe:PESQ<n2>:STORe:AY](#) on page 1016
- [TRACe:PESQ<n2>:STORe:BY](#) on page 1016
- [TRACe:SWEep<n2>:STORe:AX](#) on page 1015
- [TRACe:SWEep<n2>:STORe:AY](#) on page 1015
- [TRACe:SWEep<n2>:STORe:BX](#) on page 1015
- [TRACe:SWEep<n2>:STORe:BY](#) on page 1015
- [TRACe:WAVeform<n2>:STORe:AY](#) on page 1016

- [TRACe:WAVeform<n2>:STORe:BY](#) on page 1016

```
TRACe:SWEep<n2>:STORe:AX <ax>
TRACe:SWEep<n2>:STORe:AY <ay>
TRACe:SWEep<n2>:STORe:BX <bx>
TRACe:SWEep<n2>:STORe:BY <by>
```

Command for saving sweep graph trace data sets.

AX designates the X-axis of trace A

AY designates the Y-axis of trace A

BX designates the X-axis of trace B

BY designates the Y-axis of trace B

In the case of a multiscan display or single display with "MIN/MAX" traces, the command [DISPlay:SWEep<n2>:SCANoffset](#) on page 917 selects the desired scan.

Suffix:

<n2> subsystem number 1 to 4

Parameters:

<by> float

Example:

```
TRAC:SWEep1:STORe:AY <n, n, n, n>
```

Saves the data of the Y-axis for channel A in the first sweep system.

```
TRACe:BARGraph<n2>:STORe:AY <ay>
TRACe:BARGraph<n2>:STORe:BY <by>
```

Commands for saving bargraph trace data sets.

Commands . . . :AX and . . . :BX are not allowed, because they are only available for sweeps.

Suffix:

<n2> subsystem number 1 and 2

Parameters:

<by> float

```
TRACe:FFT<n2>:STORe:AY <ay>
TRACe:FFT<n2>:STORe:BY <by>
```

Commands for saving FFT graph trace data sets.

Commands . . . :AX and . . . :BX are not allowed.

Suffix:

<n2> subsystem number 1 and 2

Parameters:

<by> float

TRACe:PESQ<n2>:STORE:AY <ay>

TRACe:PESQ<n2>:STORE:BY <by>

Commands for saving PESQ trace data records.

Commands . . . :AX and . . . :BX are not allowed.

Suffix:

n2 subsystem number 1 and 2

Parameters:

<by> float

TRACe:WAVEform<n2>:STORE:AY <ay>

TRACe:WAVEform<n2>:STORE:BY <by>

Commands for saving waveform trace data sets.

Commands . . . :AX and . . . :BX are not allowed.

Suffix:

<n2> subsystem number 1

Parameters:

<by> float

7.32 User-definable data buffers

The available data buffers are mainly used for communicating between K1 macros and IEC/IEEE bus control programs.

The K1 macro or the IEC/IEEE bus control program saves data in the form of strings or binary data in the available data buffers, from where it can be collected and further processed by the other program. However, these buffers can also be used as data buffers within one of the programs.

- [SYSTem:MEMory:DATA<n3>](#) on page 1016
 - [SYSTem:MEMory:FREE](#) on page 1018
 - [SYSTem:MEMory:STRing<n3>](#) on page 1018
-

SYSTem:MEMory:DATA<n3> <data>

Stores up to 1024 data sets with a length limited only by the storage capacity made available by the operating system. The available storage capacity cannot be determined exactly but is usually in the range of 128 Mbytes. Preference should be given to this memory when saving trace data.

Table 7-1: Comparison of commands SYSTem:MEMory:DATA and TRACe:SWEep<i>:LOAD

| A query of the data buffer returns the data using the basic unit | A query returns the trace data using the selected unit and number. |
|--|--|
| Raw data: SYSTem:MEMory:DATA1? | TRACe:SWEep<i>:LOAD:AX?
TRACe:SWEep<i>:LOAD:COUNT:AX?
< >i = 1 ... 4 |
| Trace data: SYSTem:MEMory:DATA2? | TRACe:SWEep1:LOAD:AY?
TRACe:SWEep1:LOAD:COUNT:AY? |
| Trace data: SYSTem:MEMory:DATA3? | TRACe:SWEep1:LOAD:BY?
TRACe:SWEep1:LOAD:COUNT:BY? |
| Trace data: SYSTem:MEMory:DATA4? | TRACe:SWEep2:LOAD:AY?
TRACe:SWEep2:LOAD:COUNT:AY? |
| Trace data: SYSTem:MEMory:DATA5? | TRACe:SWEep2:LOAD:BY?
TRACe:SWEep2:LOAD:COUNT:BY? |
| Trace data: SYSTem:MEMory:DATA6? | TRACe:SWEep3:LOAD:AY?
TRACe:SWEep3:LOAD:COUNT:AY? |
| Trace data: SYSTem:MEMory:DATA7? | TRACe:SWEep3:LOAD:BY?
TRACe:SWEep3:LOAD:COUNT:BY? |
| Trace data: SYSTem:MEMory:DATA8? | TRACe:SWEep4:LOAD:AY?
TRACe:SWEep4:LOAD:COUNT:AY? |
| Trace data: SYSTem:MEMory:DATA9? | TRACe:SWEep4:LOAD:BY?
TRACe:SWEep4:LOAD:COUNT:BY? |

Suffix:

<n3> 1 to 1024
1024 data sets
Note that only data sets 1 to 89 are used for Chirp based measurements.

Parameters:

<data> float
Numeric strings consisting of floating-point values without a unit in ASCII format
or
Binary data set of the form
#<LengthOfLength><Length><Binary data>
If the contents of the data buffer are deleted with command SYSTem:MMEMory:FREE DATA, the query SYSTem:MMEMory:DATA<n3>? returns <3.40282E+38> (NAN = Not a Number) .

Example:

SYST:MEM:DATA11 1.2345,2.3456,3.4567,4.5678
or
SYST:MEM:DATA11 #212<Binary data set consisting of 12 bytes>

SYSTem:MEMory:FREE <free>

The command deletes the contents of the string or data buffer.

Parameters:

| | |
|--------|--|
| <free> | STRing DATA |
| | STRing
deletes the contents of all string buffers.
After deletion, the query <code>SYSTem:MMEMory:STRing<n3>?</code> returns the string <empty> . |
| | DATA
deletes the contents of all data buffers.
After deletion, the query <code>SYSTem:MMEMory:DATA<n3>?</code> returns <3.40282E+38> (NaN = Not a Number). |

Usage: Setting only

SYSTem:MEMory:STRing<n3> <string>

Enters a string in the string buffer. Any strings up to a length of 540 bytes can be cached in up to 1024 memory locations.

Suffix:

| | |
|------|------------------------------------|
| <n3> | 1 to 1024
1024 memory locations |
|------|------------------------------------|

Parameters:

| | |
|----------|--|
| <string> | string

The maximum string length is 540 bytes.
If the contents of the string buffer are deleted with command <code>SYSTem:MMEMory:FREE STRing</code> , the query <code>SYSTem:MMEMory:STRing<n3>?</code> returns the string <empty>. |
|----------|--|

Example: `SYSTem:MEMory:STRing10 "Store this string in the buffer!"`
Query: `SYSTem:MEMory:STRing10?`
Response: `"Store this string in the buffer!"`

7.33 Hardcopy

The `HARDcopy` commands are used for printing and saving of screenshots.

- [HCOpy:DESTination](#) on page 1019
- [HCOpy:FILE](#) on page 1019
- [HCOpy:FILE:MODE](#) on page 1019
- [HCOpy\[:IMMEDIATE\]](#) on page 1019

- [HCOPY:GSIze](#) on page 1019
- [HCOPY:PRINter:ADDition](#) on page 1020
- [HCOPY:PRINter:FOOTer](#) on page 1020
- [HCOPY:PRINter:HEADer](#) on page 1020
- [HCOPY:PRINter:ORientation](#) on page 1020
- [HCOPY:SOURce](#) on page 1019

HCOPY:DESTination <destination>**Parameters:**

<destination> PRINter | FILE | CLIPboard

Manual operation: See "[Destination](#)" on page 660

HCOPY:FILE <file>**Parameters:**

<file> <file name>

Manual operation: See "[Filename](#) " on page 662

HCOPY:FILE:MODE <mode>**Parameters:**

<mode> NEW | OVERwrite | INCRement

Manual operation: See "[Store Mode](#)" on page 661

HCOPY[:IMMEDIATE]

Usage: Event

HCOPY:SOURce <source>**Parameters:**

<source> WINDow | GRAPhics

Manual operation: See "[Source](#)" on page 659

HCOPY:GSIze <gsize>**Parameters:**

<gsize> string

Example: HCOpy:GSIze '800x600'

Manual operation: See "[Graph Size](#)" on page 660

HCOPY:PRINter:ORientation <orientation>**Parameters:**

<orientation> selection

Manual operation: See "[Orientation](#)" on page 661

HCOPY:PRINter:ADDition <addition>**Parameters:**

<addition> integer | ON | OFF

Manual operation: See "[Header/Footer](#) " on page 661

HCOPY:PRINter:HEADer <header>**Parameters:**

<header> string

Manual operation: See "[Define Header](#)" on page 661

HCOPY:PRINter:FOOTer <footer>**Parameters:**

<footer> string

Manual operation: See "[Define Footer](#)" on page 661

7.34 MMEMory Subsystem

The MMEMory subsystem (**Mass Memory**) contains the commands for managing files and directories as well as for loading and storing complete instrument settings in files.

The various drives can be selected using the "mass storage unit specifier " <msus>. The internal hard disk is selected with `D:\`, the CD drive with `E:\`, and a memory stick plugged in at the USB interface with `F:\`. The resources of a network can also be selected with <msus> in the syntax of the respective network, e.g. using the UNC format (Universal Naming Convention): `\\server\share`.

The default drive is determined using the command `MMEMory:MSIS <msus>`.



The `C:` drive is a protected system drive. This drive should not be accessed. Reconstruction of the system partition will not be possible without loss of data.

Further MMEMory commands are described together with the commands of the associated function, e.g. loading of specific instrument configurations.

7.34.1 File Naming Conventions

To enable files in different file systems to be used, the following file naming conventions should be observed.

The file name can be of any length and no distinction is made between uppercase and lowercase letters. The file and the optional file extension are separated by a dot. All letters and numbers are permitted (numbers are, however, not permitted at the beginning of the file name). Where possible, special characters should not be used. Use of the slashes "\" and "/" should be avoided since they are used in file paths. A number of names are reserved by the operating system, e.g. CLOCK\$, CON, AUX, COM1...COM4, LPT1...LPT3, NUL and PRN.

In the R&S UPV all files in which lists and settings are stored are given a characteristic extension. The extension is separated from the actual file name by a dot.

The two characters "*" and "?" function as "wildcards", i.e. they are used for selecting several files. The "?" character represents exactly one character, while the "*" character represents all characters up to the end of the file name. "*.*" therefore stands for all the files in a directory.

When used in conjunction with the commands, the parameter <file_name> is specified as a string parameter with quotation marks. It can contain either the complete path including the drive, only the path and file name, or only the file name. The file name must include the file extension. The same applies for the parameters <directory_name> and <path>. Depending on how much information is provided, either the values specified in the parameter or the values specified with the commands `MMEM:MSIS` (default drive) and `MMEM:CDIR` (default directory) are used for the path and drive setting in the commands.

In the example below, the current instrument setting is always stored in the file 'test1.set' in the directory 'user' on the internal hard disk.

Example:

```
MMEM:STOR:STAT "d:\user\test1.set"
```

If the complete path including the drive letter is specified, the file is stored in the specified path.

```
MMEM:MSIS 'D:'
```

```
MMEM:STOR:STAT "\user\test1.set"
```

If the parameter only contains the path and file name, the default drive set with the `MMEM:MSIS` command is effective.

If the parameter contains only the path and file name, the default drive defined with the command `MMEM:MSIS` is used.

```
MMEM:MSIS 'D:'
```

```
MMEM:CDIR 'user'
```

```
MMEM:STOR:STAT 'test1.set'
```

If the parameter contains only the file name, the file is stored on the default drive

```
MMEM:MSIS
```

and in the default directory that was selected with the command

```
MMEM:CDIR.
```

In all commands for data transmission, the data for both paths is always transmitted simultaneously.

7.34.2 Load and store setups

In all commands for data transmission, the data for both paths is always transmitted simultaneously.

- [MMEMory:LOAD:STATe](#) on page 1022
- [MMEMory:STORe:STATe](#) on page 1022

MMEMory:LOAD:STATe <file>

This command loads the specified instrument setting

Loading a setup overwrites the settings of the instrument with the settings that were active when setup was saved. Depending on the type of setup to be loaded, only the current settings are overwritten ("current" setup) or the entire settings, including the position and size of all windows in all screens ("complete" setup). Windows that were open when the setup was saved are opened, and windows that were closed when the setup was saved are closed again. This is also done for the screens that are not visible.

Parameters:

| | |
|--------|--|
| <file> | string |
| | file name where the setup was stored by
MMEMory:STORe:STATe |

MMEMory:STORe:STATe <file name>

Saving a setup in a 'setupfile'.

Parameters:

| | |
|-------------|---|
| <file name> | string |
| | Specifies the file name in which the setup is stored. The file extension defines the type of setup that is stored:
Complete setups are stored if file extension <code>.set</code> is used. With complete setups, the entire instrument settings, plus the position and size of all windows in all screens is stored.
Current setups are stored if file extension <code>.sac</code> is used. With current setups only the instrument settings are saved. Therefore, current setups can be loaded much faster, since the panels do not have to be restored. |

| | |
|--------|-------|
| Usage: | Event |
|--------|-------|

7.34.3 Common MMEMory commands

- [MMEMory:COPY](#) on page 1023

- [MMEMory:DATA](#) on page 1023
- [MMEMory:MDIRectory](#) on page 1024
- [MMEMory:MOVE](#) on page 1024

MMEMory:COPY <source>,[<destination>]

This command copies the first specified file to the second specified file. You can also use this command to copy a complete directory, including all of its files, rather than a single file.

If you do not specify <destination>, <source> will be copied to the `MMEM:MSIS` drive and to the `MMEM:CDIR` directory. Any files in the destination directory that have the same name will be overwritten without an error message being generated.

You can also enter the path specification by using an additional parameter. The command will then read as follows: `MMEMory:COPY`

```
<file_source><msus_source>[,<file_destination>,  
<msus_destination>]
```

The command triggers an event and therefore has no query form and no *RST value.

Example: `MMEM:COPY 'D:/user/test1.set', 'F:/'`
Copies the file 'test1.set' located in the `USER` directory of the internal hard disk to the memory stick using the same name

MMEMory:DATA <file_name>,[<binary block data>]

This command copies the block data <binary block data> to the file designated with <file_name>.

The R&S UPV accepts the line message EOI and/or the ASCII character NL (0Ah) as an indication that data transmission has been completed.

The binary data stream must be concluded with EOI or NL or EOI followed by NL. If the data stream is not concluded with either EOI or NL, the R&S UPV will wait for additional data. In the case of a binary data transmission, the R&S UPV ignores the bit combination NL (0Ah) within the data stream.

The associated query command transmits the specified file from the R&S UPV to the controller via the IEC/IEEE bus. Make sure that the buffer on the controller is large enough to hold the file.

You can use this command to read stored instrument settings, trace files, waveform files, filter coefficient files, etc, directly from the R&S UPV or to transmit them directly to the R&S UPV.

The binary data block has the following structure: `#<Length>fLength><Length><block_data>`.

Example: `#234<block_data>#` always introduces the binary block

<Length>fLength> specifies how many positions the subsequent length specification occupies (two in the example)

<Length> specifies the number of subsequent bytes (34 in the example)<binary block data> binary block data of the specified length

Example: MMEM:DATA 'TEST1.WV',#3767<binary data>
Writes the block data to file 'test1.wv'.
MMEM:DATA? 'TEST1.WV'
transmits the data of file'Test1.wv' as binary block from the R&S UPV to the controller.

MMEMory:DELeTe <file_name>

This command deletes the specified file.

Example: MMEM:DEL 'D:\UPV\USER\TEST1.set'
Deletes file 'Test1.set' from directory USER on the internal hard disk.

Usage: Event

MMEMory:MDIRectory <directory_name>

This command creates a new subdirectory for the specified directory. If no directory is specified, a subdirectory of the default directory is created. A directory tree can also be created by using this command

Example: MMEM:MDIR 'carrier'
Creates subdirectory 'carrier' in the current directory.

Usage: Event

MMEMory:MOVE

<file_source><msus_source>[,<file_destination>,<msus_destination>]

This command renames an existing file if <file_destination> does not contain a path specification. Otherwise, the file is moved to the specified path and stored under the original file name or under a new file name if one is specified.

You can also enter the path specification by means of an additional parameter; the command then reads as follows: MMEMory:MOVE

<file_source><msus_source>[,<file_destination>,<msus_destination>]

Example: MMEM:MOVE 'test.set','keep.set'
Renames file 'test.set' to 'keep.set'.
MMEM:MOVE 'test.set','\user\keep.set'
Moves file 'test.set' to subdirectory 'user' and stores it there under the name 'keep.set'

Usage: Event

7.35 STATus Subsystem

This system contains the commands for the status reporting system. *RST has no effect on the status registers.

Queries return the current value of the respective register, which permits a check of the device status. A decimal value between 0 and 32767 (=2¹⁵-1) is returned.

The configuration commands set the respective register thus determining which status changes of the R&S UPV causes the status registers to be changed.

| | |
|--|---|
| STATus:OPERation
STATus:QUEStionable
STATus:XQUEStionable | Returns and sets a decimal value between 0 and 32767 (= 2 ¹⁵ - 1).

The most significant bit is set to zero in all registers. The register content can thus always be interpreted as a positive integer. |
| STATus:QUEStionable:UNDERrange
STATus:QUEStionable:OVERrange
STATus:QUEStionable:MEASuring | Returns and sets a decimal value between 0 and 65535 (= 2 ¹⁶ - 1).

For future applications, the most significant bit d15 may also be set. |

- [STATus:PRESet](#) on page 1026
- [STATus:OPERation:CONDition?](#) on page 1026
- [STATus:OPERation:ENABLE](#) on page 1026
- [STATus:OPERation:EVENT?](#) on page 1027
- [STATus:OPERation:NTRansition](#) on page 1027
- [STATus:OPERation:PTRansition](#) on page 1027
- [STATus:QUEStionable:CONDition?](#) on page 1027
- [STATus:QUEStionable:ENABLE](#) on page 1028
- [STATus:QUEStionable:EVENT?](#) on page 1028
- [STATus:QUEStionable:NTRansition](#) on page 1028
- [STATus:QUEStionable:PTRansition](#) on page 1028
- [STATus:QUEStionable:MEASuring:CONDition?](#) on page 1031
- [STATus:QUEStionable:MEASuring:ENABLE](#) on page 1031
- [STATus:QUEStionable:MEASuring:EVENT?](#) on page 1032
- [STATus:QUEStionable:MEASuring:NTRansition](#) on page 1032
- [STATus:QUEStionable:MEASuring:PTRansition](#) on page 1032
- [STATus:QUEStionable:OVERrange:CONDition?](#) on page 1030
- [STATus:QUEStionable:OVERrange:ENABLE](#) on page 1030
- [STATus:QUEStionable:OVERrange:EVENT?](#) on page 1030
- [STATus:QUEStionable:OVERrange:NTRansition](#) on page 1031
- [STATus:QUEStionable:OVERrange:PTRansition](#) on page 1031
- [STATus:QUEStionable:UNDerrange:CONDition?](#) on page 1029
- [STATus:QUEStionable:UNDerrange:ENABLE](#) on page 1029

- [STATus:QUEStionable:UNDerrange:EVENT?](#) on page 1029
- [STATus:QUEStionable:UNDerrange:NTRansition](#) on page 1029
- [STATus:QUEStionable:UNDerrange:PTRansition](#) on page 1030
- [STATus:QUEue:NEXT?](#) on page 1034
- [STATus:XQUEstionabl:CONDition?](#) on page 1032
- [STATus:XQUEstionabl:ENABLE](#) on page 1033
- [STATus:XQUEstionabl:EVENT?](#) on page 1033
- [STATus:XQUEstionabl:NTRansition](#) on page 1033
- [STATus:XQUEstionabl:PTRansition](#) on page 1033

STATus:PRESet

The command resets the status registers.

| | |
|--|--|
| STATus:OPERation
STATus:QUEStionable
STATus:XQUEstionable | All PTRansition parts are set to 7FFFh (32767), i.e. all transitions from 0 to 1 are detected. |
| STATus:QUEStionable:UNDerrange
STATus:QUEStionable:OVERrange
STATus:QUEStionable:MEASuring | All PTRansition parts are set to FFFFh (65535), i.e. all transitions from 0 to 1 are detected. |

The NTRansition parts of all status registers are set to 0, i.e. a transition from 1 to 0 of a CONDition bit is not detected. The ENABLE parts of all status registers are set to 0, i.e. none of the events in these registers is passed on.

The command triggers an event and therefore has no query form and no *RST value.

STATus:OPERation:CONDition?

The command queries the content of the CONDition part of the STATus:OPERation register.

This part contains the information about the current instrument state.

Reading the information does not clear the register.

Return values:

<argument> integer

Usage: Query only

STATus:OPERation:ENABLE <integer>

The command sets the bits of the ENABLE part of the STATus:OPERation register. This setting determines which events of the EVENT part of the STATus:OPERation register are to be passed on to the summary bit of the status byte. These events can be used to trigger a service request.

Parameters:

<integer> 0...32767

STATus:OPERation:EVENT?

The command queries the content of the `EVENTt` part of the `STATus:OPERation` register. This part contains the information about the current instrument state since the last readout.

A bit set in the `EVENTt` register indicates a change of the corresponding bit in the `CONDition` register. Whether bits in the `EVENTt` register are set due to a bit transition from 0 to 1 or from 1 to 0 depends on the bits set in the `PTRansition` and the `NTRansition` registers.

Reading the information clears the register.

Return values:

<argument> integer

Usage: Query only

STATus:OPERation:NTRansition <integer>

The command sets the bits of the `NTRansition` part of the `STATus:OPERation` register. A bit set in the `NTRansition` register causes a bit transition from 1 to 0 in the `CONDition` register to produce an entry in the `EVENTt` register.

Reading the information does not clear the register.

Parameters:

<integer> 0...32767

STATus:OPERation:PTRansition <integer>

The command sets the bits of the `PTRansition` part of the `STATus:OPERation` register. A bit set in the `PTRansition` register causes a bit transition from 0 to 1 in the `CONDition` register to produce an entry in the `EVENTt` register. Reading the information does not clear the register.

Parameters:

<integer> 0...32767

STATus:QUESTionable:CONDition?

The command queries the content of the `CONDition` part of the `STATus:QUESTionable` register. This part contains the information about the current instrument state.

Reading the information does not clear the register.

Return values:

<argument> integer

Usage: Query only

STATus:QUESTionable:ENABLE <integer>

The command sets the bits of the **ENABLE** part of the **STATus:QUESTionable** register. This setting determines which events of the **EVENT** part of the **STATus:QUESTionable** register are to be passed on to the summary bit of the status byte. These events can be used to trigger a service request.

Parameters:

<integer> 0...32767

STATus:QUESTionable:EVENT?

The command queries the content of the **EVENT** part of the **STATus:QUESTionable** register. This part contains the information about the current instrument state since the last readout.

A bit set in the **EVENT** register indicates a change of the corresponding bit in the **CONDition** register. Whether bits in the **EVENT** register are set due to a bit transition from 0 to 1 or from 1 to 0 depends on the bits set in the **PTRansition** and the **NTRansition** registers.

Reading the information clears the register.

Return values:

<argument> integer

Usage: Query only

STATus:QUESTionable:NTRansition <integer>

The command sets the bits of the **NTRansition** part of the **STATus:QUESTionable** register. A bit set in the **NTRansition** register causes a bit transition from 1 to 0 in the **CONDition** register to produce an entry in the **EVENT** register.

Reading the information does not clear the register.

Parameters:

<integer> 0...32767

STATus:QUESTionable:PTRansition <integer>

The command sets the bits of the **PTRansition** part of the **STATus:QUESTionable** register. A bit set in the **PTRansition** register causes a bit transition from 0 to 1 in the **CONDition** register to produce an entry in the **EVENT** register.

Reading the information does not clear the register.

Parameters:

<integer> 0...32767

STATus:QUESTionable:UNDerrange:CONDition?

The command queries the content of the `CONDition` part of the `STATus:QUESTionable:UNDerrange` register. This part contains the information about which channel of a multichannel instrument is underranged.

Reading the information does not clear the register.

Return values:

<argument> integer

Usage: Query only

STATus:QUESTionable:UNDerrange:ENABLE <integer>

The command sets the bits of the `ENABLE` part of the `STATus:QUESTionable:UNDerrange` register. This setting determines which events of the status-event part are to be passed on to summary bit 2 of the `STATus:QUESTionable` register. These events can be used to trigger a service request.

Parameters:

<integer> 0...65535

STATus:QUESTionable:UNDerrange:EVENT?

The command queries the content of the `EVENT` part of the `STATus:QUESTionable:UNDerrange` register. This part contains the information about the current instrument state since the last readout.

A bit set in the `EVENT` register indicates a change of the corresponding bit in the `CONDition` register. Whether bits in the `EVENT` register are set due to a bit transition from 0 to 1 or from 1 to 0 depends on the bits set in the `PTRansition` and the `NTRansition` registers.

Reading the information clears the register.

Return values:

<argument> integer

Usage: Query only

STATus:QUESTionable:UNDerrange:NTRansition <integer>

The command sets the bits of the `NTRansition` part of the `STATus:QUESTionable:UNDerrange` register. A bit set in the `NTRansition` part causes a bit transition from 1 to 0 in the `CONDition` part to produce an entry in the `EVENT` part of the register.

Reading the information does not clear the register.

Parameters:

<integer> 0...65535

STATus:QUESTionable:UNDerrange:PTRansition <integer>

The command sets the bits of the PTRansition part of the STATus:QUESTionable:UNDerrange register. A bit set in the PTRansition part causes a bit transition from 1 to 0 in the CONDition part to produce an entry in the EVENT part of the register.

Reading the information does not clear the register.

Parameters:

<integer> 0...65535

STATus:QUESTionable:OVERrange:CONDition?

The command queries the content of the CONDition part of the STATus:QUESTionable:OVERrange register. This part contains the information about which channel of a multichannel instrument is overranged.

Reading the information does not clear the register.

Return values:

<argument> integer

Usage: Query only

STATus:QUESTionable:OVERrange:ENABLE <integer>

The command sets the bits of the ENABLE part of the STATus:QUESTionable:OVERrange register. This setting determines which events of the status-event part are to be passed on to summary bit 1 of the STATus:QUESTionable register. These events can be used to trigger a service request.

Parameters:

<integer> 0...65535

STATus:QUESTionable:OVERrange:EVENT?

The command queries the content of the EVENT part of the STATus:QUESTionable:OVERrange register. This part contains the information about the current instrument state since the last readout.

A bit set in the EVENT register indicates a change of the corresponding bit in the CONDition register. Whether bits in the EVENT register are set due to a bit transition from 0 to 1 or from 1 to 0 depends on the bits set in the PTRansition and the NTRansition registers.

Reading the information clears the register.

Return values:

<argument> integer

Usage: Query only

STATus:QUESTionable:OVERrange:NTRansition <integer>

The command sets the bits of the `NTRansition` part of the `STATus:QUESTionable:OVERrange` register. A bit set in the `NTRansition` part causes a bit transition from 1 to 0 in the `CONDition` part to produce an entry in the `EVENT` part of the register.

Reading the information does not clear the register.

Parameters:

<integer> 0...65535

STATus:QUESTionable:OVERrange:PTRansition <integer>

The command sets the bits of the `PTRansition` part of the `STATus:QUESTionable:OVERrange` register. A bit set in the `PTRansition` part causes a bit transition from 1 to 0 in the `CONDition` part to produce an entry in the `EVENT` part of the register.

Reading the information does not clear the register.

Parameters:

<integer> 0...65535

STATus:QUESTionable:MEASuring:CONDition?

The command queries the content of the `CONDition` part of the `STATus:QUESTionable:MEASuring` register. This part contains the information about which channel of a multichannel instrument is activated or deactivated.

Reading the information does not clear the register.

Return values:

<argument> integer

Usage: Query only

STATus:QUESTionable:MEASuring:ENABLE <integer>

The command queries the content of the `ENABLE` part of the `STATus:QUESTionable:MEASuring` register. This setting determines which events of the status-event part are to be passed on to summary bit 0 of the `STATus:QUESTionable` register. These events can be used to trigger a service request.

Parameters:

<integer> 0...65535

STATus:QUESTionable:MEASuring:EVENT?

The command queries the content of the `EVENT` part of the `STATus:QUESTionable:MEASuring` register. This part contains the information about the current instrument state since the last readout.

A bit set in the `EVENT` register indicates a change of the corresponding bit in the `CONDition` register. Whether bits in the `EVENT` register are set due to a bit transition from 0 to 1 or from 1 to 0 depends on the bits set in the `PTRansition` and the `NTRansition` registers.

Reading the information clears the register.

Return values:

<argument> integer

Usage: Query only

STATus:QUESTionable:MEASuring:NTRansition <integer>

The command sets the bits of the `NTRansition` part of the `STATus:QUESTionable:MEASuring` register. A bit set in the `NTRansition` part causes a bit transition from 1 to 0 in the `CONDition` part to produce an entry in the `EVENT` part of the register.

Reading the information does not clear the register.

Parameters:

<integer> 0...65535

STATus:QUESTionable:MEASuring:PTRansition <integer>

The command sets the bits of the `PTRansition` part of the `STATus:QUESTionable:MEASuring` register. A bit set in the `PTRansition` part causes a bit transition from 1 to 0 in the `CONDition` part to produce an entry in the `EVENT` part of the register.

Reading the information does not clear the register.

Parameters:

<integer> 0...65535

STATus:XQUESTionabl:CONDition?

The command queries the content of the `CONDition` part of the `STATus:XQUESTionable` register. This part contains the information about the current instrument state.

Reading the information does not clear the register.

Return values:

<argument> integer

Usage: Query only

STATus:XQUEstionabl:ENABLE <integer>

The command sets the bits of the `ENABLE` part of the `STATus:XQUEstionable` register. This setting determines which events of the `EVENT` part of the `STATus:XQUEstionable` register are to be passed on to the summary bit of the status byte. These events can be used to trigger a service request.

Parameters:

<integer> 0...32767

STATus:XQUEstionabl:EVENT?

The command queries the content of the `EVENT` part of the `STATus:XQUEstionable` register. This part contains the information about the current instrument state since the last readout.

A bit set in the `EVENT` register indicates a change of the corresponding bit in the `CONDition` register. Whether bits in the `EVENT` register are set due to a bit transition from 0 to 1 or from 1 to 0 depends on the bits set in the `PTRansition` and the `NTRansition` registers.

Reading the information clears the register.

Return values:

<argument> integer

Usage: Query only

STATus:XQUEstionabl:NTRansition <integer>

The command sets the bits of the `NTRansition` part of the `STATus:XQUEstionable` register. A bit set in the `NTRansition` register causes a bit transition from 1 to 0 in the `CONDition` register to produce an entry in the `EVENT` register.

Reading the information does not clear the register.

Parameters:

<integer> 0...32767

STATus:XQUEstionabl:PTRansition <integer>

The command sets the bits of the `PTRansition` part of the `STATus:XQUEstionable` register. A bit set in the `PTRansition` register causes a bit transition from 0 to 1 in the `CONDition` register to produce an entry in the `EVENT` register.

Reading the information does not clear the register.

Parameters:

<integer> 0...32767

STATus:QUEue:NEXT?

This command is identical to the `SYSTEM:ERRor` command

Return values:

<argument> integer

Usage: Query only

7.36 SYSTEM Subsystem

The SYSTEM subsystem contains a series of commands for general functions.

- [SYSTEM:CHNString](#) on page 1034
- [SYSTEM:COMMunicate:GTL](#) on page 1035
- [SYSTEM:COMMunicate:GPIB:ADDRESS](#) on page 1035
- [SYSTEM:DISPlay:EXPLanation<n3>:SHOW](#) on page 1035
- [SYSTEM:DISPlay:EXPLanation<n3>:TEXT](#) on page 1035
- [SYSTEM:DISPlay:SCPiupdate](#) on page 1035
- [SYSTEM:ERRor?](#) on page 1035
- [SYSTEM:HELP:LANGuage](#) on page 1036
- [SYSTEM:MAXChdisp](#) on page 1036
- [SYSTEM:PRESet](#) on page 1036
- [SYSTEM:PROGramm:EXECute](#) on page 1036
- [SYSTEM:PROFile:CLIPboard](#) on page 1036
- [SYSTEM:PROFile:FILE](#) on page 1036
- [SYSTEM:PROFile:PRINter](#) on page 1036
- [SYSTEM:PROFile:SCReen](#) on page 1036
- [SYSTEM:QLONG](#) on page 1037
- [SYSTEM:SHTDown](#) on page 1037
- [SYSTEM:VERSion?](#) on page 1038
- [SYSTEM:WINStyle](#) on page 1038

SYSTEM:CHNString <chnstring>**Parameters:**

<chnstring> string

Manual operation: See "[Channel Descr.](#)" on page 664

SYSTem:COMMunicate:GTL

This command switches the instrument to local operation.

SYSTem:COMMunicate:GPIB:ADDRess <address>

This command sets the IEC/IEEE bus address.

Parameters:

<address> integer
Range: 1 to 30

Example:

```
SYST:COMM:GPIB:ADDR 14
'Sets IEC/IEEE bus address to 14
```

Manual operation: See "[GPIB Address](#)" on page 659

SYSTem:DISPlay:EXPLanation<n3>:SHOW <show>**Parameters:**

<show> string

SYSTem:DISPlay:EXPLanation<n3>:TEXT <text>**Parameters:**

<text> string

SYSTem:DISPlay:SCPiupdate <scpiupdate>**Parameters:**

<scpiupdate> ON | OFF

Manual operation: See "[SCPI update](#)" on page 659

SYSTem:ERRor?

The command queries the oldest entry in the error queue and deletes this entry. Positive error numbers denote device-specific errors, negative error numbers denote error messages defined by SCPI. If the error queue is empty, 0, "no error" is returned. The command has the same effect as the command `STATus:QUEue:NEXT?`

Return values:

<argument> integer

Example:

```
SYST:ERR?
Queries the oldest entry in the error queue.
Response:
0, "No error"
No error has occurred since the error queue was last output.
```

Usage: Query only

SYSTem:HELP:LANGuage <language>**Parameters:**

<language> ENGLISH | GERMAN

Manual operation: See "[Help Language](#)" on page 663

SYSTem:MAXChdisp <maxchdisp>**Parameters:**

<maxchdisp> integer

Manual operation: See "[Max Ch Disp](#)" on page 664

SYSTem:PRESet

This command triggers an instrument reset. The command has the same effect as "Menu, File, Preset (Load Default)", as the *RST command, or pressing the PRESET key on the instrument front panel.

SYSTem:PROFile:CLIPboard <clipboard>**Parameters:**

<clipboard> string

SYSTem:PROFile:FILE <file>**Parameters:**

<file> string

SYSTem:PROFile:PRINter <printer>**Parameters:**

<printer> string

SYSTem:PROFile:SCREen <screen>**Parameters:**

<screen> string

SYSTem:PROGramm:EXECute <execute>

The command starts the specified Windows program and passes on additional call parameters. The command is normally used to remotely start Visual Basic programs in the R&S UPV-K1 software option (see also the description for the R&S UPV-K9x).

Parameters:

<execute> command line
 Console command line for Windows

Example:

```
:SYST:PROG:EXEC
'C:\Program Files\test.exe' arg1 arg2 arg3 arg4
```

starts the "test.exe" Windows program with the "arg1", "arg2", "arg3", and "arg4" arguments and maintains execution until the program is ended.

SYSTem:QLONG <qlong>**Parameters:**

<qlong> ON | OFF

Manual operation: See ["Query Longform"](#) on page 663

SYSTem:SHUtdown <shutdown>**SYSTem:SHTDown** <shtdown>

This command shuts down the R&S UPV by remote control.

The alias command is `SYSTem:SHUtdown`.

Parameters:

<shtdown> float
 time until shutdown in seconds. No entry corresponds to a time of 0 seconds, i.e. immediate shutdown.

Example:

```
SYSTem:SHTDown
or
SYSTem:SHUtdown
```

Shuts down the R&S UPV immediately.

Usage:

Event

SYSTem:SINFO <sinfo>

Input of comment for current setup. The comment is stored together with the setup. After a reload of the setup, the comment can be retrieved using command `SYSTem:INFO?`.

Comments that were entered manually using the Comments Panel ([chapter 4.9, "Settings in the Menu Bar"](#), on page 203) are retrieved as an HTML string.

Parameters:

<sinfo> string

SYSTem:SIINFo:MAC <mac>**Parameters:**

<mac>

String

The MAC address (Media Access Control Address) is the hardware address of the network adapter. It identifies the instrument in the network. The address is returned as string in hexa decimal format '00:1E:C9:48:6E:60'.

SYSTem:VERSIon?

This command queries the SCPI version with which the instrument is compliant. The SCPI version is returned in the form of a calendar year.

Return values:

<argument> integer

Example:

:SYST:VERS?

Queries the SCPI version.

Response:

1999.0

The instrument is compliant with the 1999.0 SCPI version.

Usage:Query only

SYSTem:WINStYle <winstyle>**Parameters:**

<winstyle> ON | OFF

Manual operation: See "[File Selector Win Style](#)" on page 663

8 Maintenance and Instrument Interfaces

8.1 Introduction - Maintenance and Interfaces

The following chapter contains information on maintaining the audio analyzer and also describes the instrument interfaces.

How to change a module and order spare parts is described in the service manual. The service manual also contains all the ID numbers required for ordering spare parts. The service manual is available as PDF file on the user documentation CD ROM (included in delivery).

The address of our Support Center and a list of Rohde & Schwarz Service Centers are given at the beginning of this manual.

More detailed information (especially on troubleshooting, repairing the instrument, changing the modules and calibration) can also be found in the service manual.

8.2 Maintenance

The audio analyzer does not require regular maintenance. Maintenance is essentially restricted to cleaning the instrument. It is, however, advisable to check the nominal data from time to time.

NOTICE

Instrument damage caused by cleaning agents

Cleaning agents contain substances that may damage the instrument. Never use solvents such as thinners, acetone, as these substances will damage plastic components and the labeling on the front panel.

The outside of the instrument is suitably cleaned using a soft, line-free dust cloth.

The storage temperature range for the audio analyzer is specified in the data sheet. The instrument must be protected against dust if it is to be stored for a long period.

When transporting or shipping the instrument, it is advisable to use the original packing material (especially the two protective covers for the front and rear panel).

8.3 Changing the AC Supply Fuse

Only fuses of the type IEC 127T4.0H/250V should be used. Those fuses are used for all of the specified nominal AC supply voltages.

NOTICE**Damage of instrument when using wrong fuses**

Using wrong fuses may cause damage of the instrument.

Changing the AC supply fuses:

1. Disconnect the power cable.
2. Open the flap covering the voltage selector using a small screwdriver (or similar).
3. Pull out the two fuse holders and replace the defective fuses with new ones.
4. Reinsert the fuse holders.
5. Close the flap.

8.4 Instrument Interfaces

The following section describes the remote-control interfaces of the audio analyzer and the pin assignment of the monitor socket. The other interfaces are described in [chapter 2, "Startup"](#), on page 23.

8.4.1 IEC/IEEE-Bus Interface (IEC 625 / IEEE 488)

As standard, the instrument is equipped with an IEC/IEEE-bus connector. The connector socket (conforming to IEEE 488) is at the rear of the instrument. The interface can be used to connect a controller to allow remote control of the instrument. A shielded cable is used for connection.

8.4.1.1 Features of the IEC/IEEE-bus interface

- 8-bit parallel data transfer
- Bidirectional data transfer
- Three-wire handshake
- High data transfer rate
- Up to 15 instruments can be connected
- Max. length of connecting cables: 15 m (individual connection 2 m)
- Wired-Or operation with parallel connection of several instruments

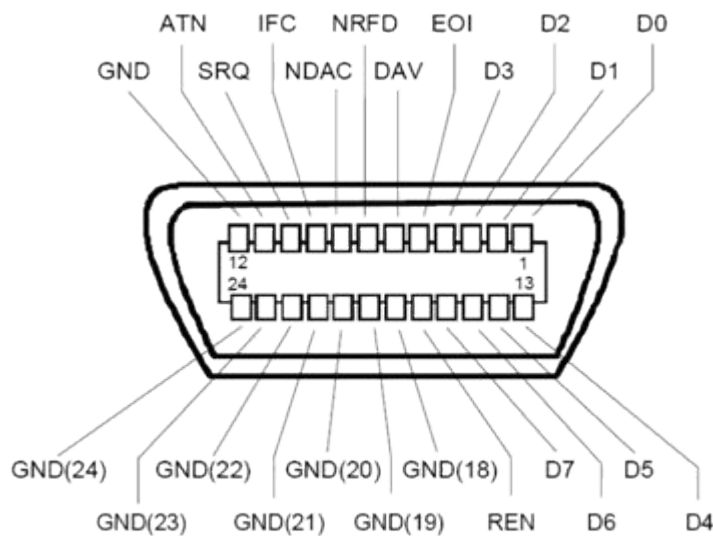


Fig. 8-1: Pin assignment of IEC/IEEE-bus interface

8.4.1.2 IEC/IEEE-bus lines

- **Data bus with 8 lines DIO 1...DIO 8**
Data is transferred parallel by bit and serial by byte in ASCII/ISO code. DIO1 is the bit with the lowest value and DIO8 the bit with the highest value.
- **Control bus with 5 lines:**
 - **IFC** (Interface Clear):
Active LOW resets the interfaces of the connected instruments to their initial setting.
 - **ATN** (Attention):
Active LOW signals the transmission of interface messages
non-active HIGH indicates the transmission of device messages
 - **SRQ** (Service Request):
Active LOW allows the connected instrument to send a service request to the controller.
 - **REN** (Remote Enable):
Active LOW allows switchover to remote-control mode.
 - **EOI** (End or Identify):
This has two functions in conjunction with ATN:
ATN = HIGH Active LOW indicates the end of data transfer.
ATN = LOW Active LOW triggers a parallel poll.
- **3. Handshake bus with three lines:**
 - **DAV** (Data Valid):
Active LOW signals a valid data byte on the data bus.
 - **NRFD** (Not Ready For Data):
Active LOW signals that one of the connected instruments is not ready to receive data.

- **NDAC** (Not Data Accepted):
Active LOW while the connected instrument is receiving the data on the data bus.

8.4.1.3 IEC/IEEE-bus interface functions

Instruments which can be remote-controlled via the IEC/IEEE bus can be provided with various interface functions. The table below lists the interface functions which apply to the audio analyzer.

Table 8-1: Interface functions

| Control character | Interface functions |
|-------------------|---|
| SH1 | Source handshake, full capability |
| AH1 | Acceptor handshake, full capability |
| L4 | Listener function, full capability, unaddressing by MTA |
| T6 | Talker function, full capability, capability of responding to serial query, unaddressing by MLA |
| SR1 | Service request function, full capability |
| PP1 | Parallel poll function, full capability |
| RL1 | Remote/local switchover function, full capability |
| DC1 | Reset function (Device Clear), full capability |
| DT1 | Trigger function (Device Trigger), full capability |
| C0 | No controller function |

8.4.1.4 IEC/IEEE-bus interface messages

Interface messages are transferred to the instrument on the data lines, whereby the "attention" control line ("ATN") is active (LOW). They are used for communication between the controller and the instrument and can only be sent by a controller which has controller functionality on the IEC/IEEE bus.

Universal commands

The universal commands are in the code range 0x10 to 0x1F. They act on all instruments connected to the bus without previous addressing.

Table 8-2: Universal commands

| Command | VISUAL BASIC command | Effect on instrument |
|-----------------------|--------------------------------|--|
| DCL (Device Clear) | IBCMD (controller%, CHR\$(20)) | Terminates processing of the commands that have just been received, and sets the command-processing software to a defined initial state. Does not modify the instrument configuration. |
| IFC (Interface Clear) | IBSIC (controller%) | Resets the interfaces to their initial setting. |

| Command | VISUAL BASIC command | Effect on instrument |
|-----------------------------|--------------------------------|---|
| LLO (Local Lockout) | IBCMD (controller%, CHR\$(17)) | The manual LOCAL switchover function is disabled. |
| SPE (Serial Poll Enable) | IBCMD (controller%, CHR\$(24)) | Ready for serial polling. |
| SPD (Serial Poll Disable) | IBCMD (controller%, CHR\$(25)) | End of serial polling. |
| PPU (Par. Poll Unconfigure) | IBCMD (controller%, CHR\$(21)) | End of parallel polling query status. |

Addressed commands

The addressed commands are in the code range 0x00 to 0x0F. They only act on instruments which are addressed as listeners.

Table 8-3: Addressed commands

| Command | VISUAL BASIC command | Effect on instrument |
|-------------------------------|------------------------|--|
| SDC (Selected Device Clear) | IBCLR (device%) | Terminates processing of the commands that have just been received, and sets the command-processing software to a defined initial state. Does not modify the instrument configuration. |
| GET (Group Execute Trigger) | IBTRG (device%) | Triggers a measurement or a sweep. |
| GTL (Go to Local) | IBLOC (device%) | Transition to the "Local" state (manual operation). |
| PPC (Parallel Poll Configure) | IBPPC (device%, data%) | Configure instrument for parallel poll. The VISUAL BASIC command also executes PPE/PPD. |

8.4.2 Ethernet Interface (LAN)

As standard, the instrument is equipped with an Ethernet interface. The connector socket is at the rear of the instrument. Network administrators with the appropriate rights can transfer files across the network and use network resources such as network directories or printers. The instrument can also be remote-controlled and manually operated in the network. A commercially available shielded RJ-45 cable is used for connection.

The network card operates with 100-MHz-Ethernet IEEE 802.3u. The TCP/IP network protocol and the associated network services are preconfigured. TCP/IP provides connection-mode communication where the sequence of the exchanged messages is retained and interrupted connections are detected. Furthermore, messages cannot be lost if this protocol is used.

Connection of the R&S UPV is described in [chapter 2.10.1, "Connection to the Network"](#), on page 68, and remote control via Ethernet is described in [chapter 6.3.2, "Remote Control via LAN Interface"](#), on page 805. The architecture of a LAN remote-control connection is described in greater detail below.

Remote control of the instrument via a network is based on these standardized protocols which comply with the OSI reference model (see the figure below).

| | |
|--------------|------------------|
| Application | Test Application |
| | VXI-11 Protocol |
| Presentation | XDR |
| Session | ONC/RPC |
| Transport | TCP/UDP |
| Network | IP |
| Data Link | 802.3 (Ethernet) |
| Physical | 802.3 (10BASE-T) |

Fig. 8-2: Example of LAN remote control in compliance with OSI reference model (VXI-11)

Based on TCP/UDP, the messages are exchanged between the controller and the instrument by means of Open Network Computing (ONC) Remote Procedure Calls (RPC). With XDR, the permitted RPC messages are known as the VXI-11 standard. Messages are exchanged between the controller and the instrument based on this standard. The messages are identical to the SCPI commands. They can be divided into four groups: program messages (control commands to the instrument), response messages (values returned by the instrument), service request (spontaneous requests by the instrument) and low-level control messages (interface messages).

A VXI-11 connection between a controller and an instrument is based on three channels: core, abort and interrupt channel. The instrument is controlled mainly via the core channel (program, response and low-level control messages). The abort channel is used for immediate termination of the core channel, and the interrupt channel transports spontaneous service requests from the instrument. The actual connection setup is complex. Further details can be found in the VXI-11 specification ('TCP/IP Instrument Protocol Specification VXI-11, Revision 1.0 VMEbus Extensions for Instrumentation, VXIbus' and 'TCP/IP-IEEE 488.2 Instrument Interface Specification VXI-11.3, Draft 0.3 VMEbus Extensions for Instrumentation, VXIbus').

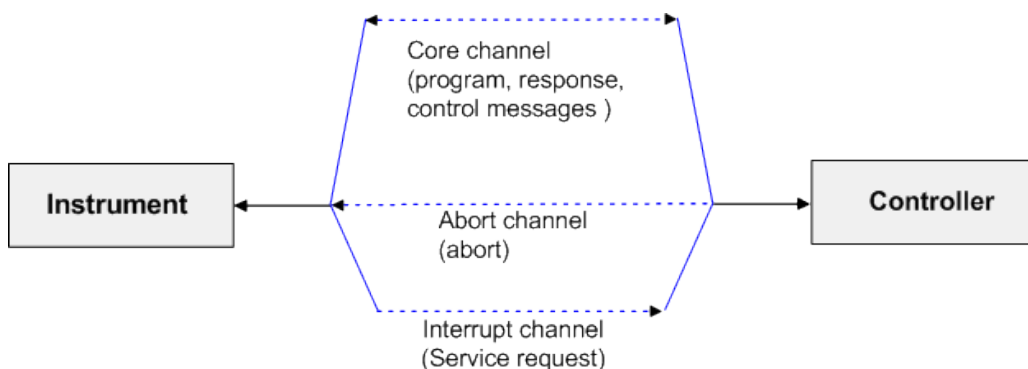


Fig. 8-3: Channels between instrument and controller with VXI-11

The number of controllers which can access an instrument is virtually unlimited in the network. In the instrument, a clear distinction is made between the individual controllers. This distinction is continued down to one controller at application level, i.e. two applications on a PC are regarded as two different controllers by an instrument.

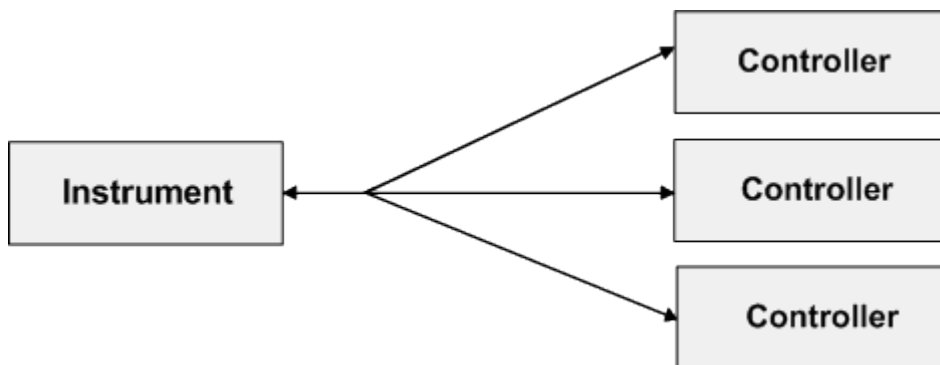
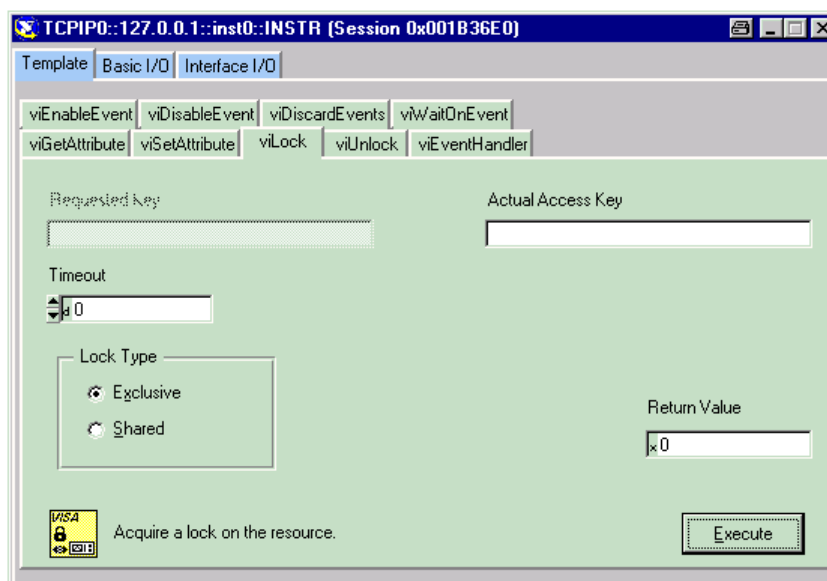


Fig. 8-4: Remote control via LAN with several controllers

The controllers can lock and unlock the instrument to permit exclusive access. As a result, it is possible to control access from several controllers.

In the program 'Measurement and Automation Control', this setting is made in the Template panel.



8.4.2.1 VXI-11 interface messages

With Ethernet connections, the interface messages are referred to as low-level control messages. They can be used to emulate the interface messages of the IEC/IEEE bus.

Table 8-4: VXI-11 interface messages

| Command | | Effect on instrument |
|---------|-------------------------|--|
| &ABO | (Abort) | Terminates processing of commands that have just been received. |
| &DCL | (Device Clear) | Terminates processing of the commands that have just been received, and sets the command-processing software to a defined initial state. Does not modify the instrument configuration. |
| >L | (Go to Local) | Transition to the "Local" state (manual operation). |
| >R | (Go to Remote) | Transition to the "Remote" state (remote control). |
| &GET | (Group Execute Trigger) | Triggers a measurement or a sweep. |
| &LLO | (Local Lockout) | The manual LOCAL switchover function is disabled. |
| &POL | (Serial Poll) | A serial poll is executed. |
| &NREN | (Not Remote Enable) | Manual switching to LOCAL mode is enabled. |

8.4.3 RS-232-C Interface (COM)

As standard, the instrument has an RS-232 interface (not with FMR9 or FMR11, see [chapter 2.6.1, "Retrieving Computer Hardware Information and Windows Operating System"](#), on page 50). The connector socket is at the rear of the instrument. The interface can be used to connect a controller to allow remote control of the instrument. A shielded cable is used for connection.

8.4.3.1 Features of the interface

- Serial data transfer in asynchronous mode
- Bidirectional data transfer via two separate lines
- Selectable transfer speed from 110 to 19200 baud
- Logic signal level '0' from +3 V to +15 V
- Logic signal level '1' from -15 V to -3 V
- External device (controller) can be connected

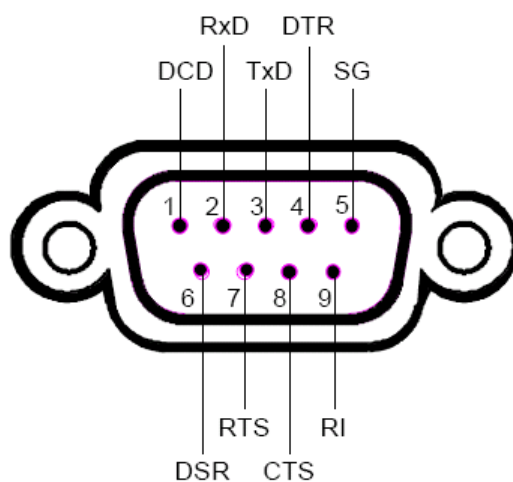


Fig. 8-5: Pin assignment of RS-232 interface

8.4.3.2 Signal lines

- **DCD** (Data Carrier Detector),
Not used in the instrument.
Input (log. '0' = active); this signal tells the data terminal that the modem is receiving valid signals with adequate level from the remote station. DCD is used to disable the receiver in the data terminal and thus prevent incorrect data from being read in if the modem cannot interpret the signals from the remote station.
- **RxD** (Receive Data),
Data line; transfer direction: remote station to instrument.
- **TxD** (Transmit Data),
Data line; transfer direction: instrument to remote station.
- **DTR** (Data terminal ready),
Output (log. '0' = active); the instrument uses DTR to announce that it is ready to receive data.
- **GND**
Interface ground, connected to the instrument ground.
- **DSR** (Data set ready),
Input (log. '0' = active); DSR tells the instrument that the remote station is ready to receive data.

- **RTS** (Request to send),
Output (log. '0' = active); RTS tells the remote station that the instrument is ready for data transfer. The RTS line remains active for as long as the serial interface is active.
- **CTS** (Clear to send),
Input (log. '0' = active); CTS tells the instrument that the remote station is ready to receive data.
- **RI** (Ring indicator),
Not used by the instrument.
Input; a modem uses RI to announce that a remote station wants to set up a connection with the modem.

8.4.3.3 Transfer parameters

To ensure error-free and correct data transfer, the set transfer parameters must be identical for both the instrument and the controller. The audio analyzer is factory-configured with the default settings identified in the list. These values cannot be changed by the user.

| | | | | | | | | | | | | | | | | | | | | | | | | | | | | | | | | | | | | | |
|-------------------------------|---|----|----|----|----|----|-------------|-------------|----|----|----|----|--|--------|-------------|--|--|--|--|--|--------|-------------|--|--|--|----------|-----------|--|--|--|--|--|-------------|----------|--|--|--|
| Transfer speed
(baud rate) | 8 different baud rates can be set in the instrument:
110, 300, 600, 1200, 2400, 4800, 9600, 19200. The default value is 19200. | | | | | | | | | | | | | | | | | | | | | | | | | | | | | | | | | | | | |
| Data bits | Data is transferred in 7 or 8 bit ASCII code. The LSB (Least Significant Bit) is the first bit to be transferred. The default value is 8. | | | | | | | | | | | | | | | | | | | | | | | | | | | | | | | | | | | | |
| Start bit | Each data byte begins with a start bit. The falling edge of the start bit signals the beginning of the data byte. | | | | | | | | | | | | | | | | | | | | | | | | | | | | | | | | | | | | |
| Parity bit | A parity bit can also be transferred to provide error protection. There are three parity settings: none, even and odd. Additionally, the parity bit can be set to logic '0' or logic '1'. The default value is no parity. | | | | | | | | | | | | | | | | | | | | | | | | | | | | | | | | | | | | |
| Stop bits | Transfer of a data byte can be ended with 1, 1.5 or 2 stop bits. The default value is 1 stop bit.

Example:
Transfer of the letter 'A' (41 Hex) in 7-bit ASCII code, with even parity and two stop bits:

<table border="1" style="margin-left: auto; margin-right: auto;"> <tr> <td>01</td><td>02</td><td>03</td><td>04</td><td>05</td><td>06</td><td>07</td><td>08</td><td>09</td><td>10</td><td>11</td><td></td> </tr> <tr> <td>Bit 01</td><td colspan="6">Bit 02...08</td><td>Bit 09</td><td colspan="3">Bit 10...11</td><td></td> </tr> <tr> <td>Startbit</td><td colspan="6">Datenbits</td><td>Paritätsbit</td><td colspan="3">Stopbits</td><td></td> </tr> </table> | 01 | 02 | 03 | 04 | 05 | 06 | 07 | 08 | 09 | 10 | 11 | | Bit 01 | Bit 02...08 | | | | | | Bit 09 | Bit 10...11 | | | | Startbit | Datenbits | | | | | | Paritätsbit | Stopbits | | | |
| 01 | 02 | 03 | 04 | 05 | 06 | 07 | 08 | 09 | 10 | 11 | | | | | | | | | | | | | | | | | | | | | | | | | | | |
| Bit 01 | Bit 02...08 | | | | | | Bit 09 | Bit 10...11 | | | | | | | | | | | | | | | | | | | | | | | | | | | | | |
| Startbit | Datenbits | | | | | | Paritätsbit | Stopbits | | | | | | | | | | | | | | | | | | | | | | | | | | | | | |

8.4.3.4 Handshake

Software handshake

With the software handshake, data transfer is controlled by the two control characters XON / XOFF: The instrument signals that it is ready to receive data using the control character XON. If the input buffer is full, it sends the character XOFF to the controller via the interface. The controller then stops data output until it receives XON again from

the instrument. In the same way, the controller informs the instrument that it is ready to receive data.

Cable for local computer link for software handshake

With the software handshake, the instrument is connected to a controller by crossing the data lines. The wiring diagram below applies to a controller with 9-pin or 25-pin connection.

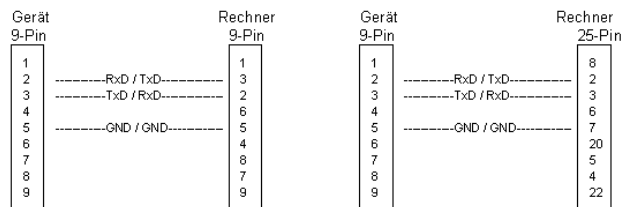


Fig. 8-6: Wiring of data lines for software handshake

Hardware handshake

With the hardware handshake, the instrument signals that it is ready to receive data via the lines DTR and RTS. A logic '0' on both lines means 'ready' and a logic '1' means 'not ready'. The RTS line is always active (logic '0') provided that the serial interface is switched on. The DTR line thus controls the readiness of the audio analyzer to receive data.

The instrument is informed of the remote station's readiness to receive data via the lines CTS and DSR. A logic '0' on both lines activates the output of data and a logic '1' on both lines stops the output of data by the instrument. Data is output via the TxD line. This is the default configuration of the audio analyzer.

Cable for local computer link for hardware handshake

The instrument is connected to a controller using a "null modem" cable. With this cable, the data, control and signaling lines must be crossed. The wiring diagram below applies to a controller with 9-pin or 25-pin connection.

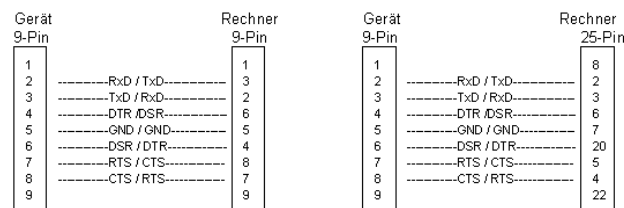


Fig. 8-7: Wiring of data, control and signaling lines for hardware handshake

8.4.4 USB Connectors (USB)

As standard, the instrument has four USB interfaces (Universal Serial Bus) of type A (Master USB); they form a link with the internal processor. They can be used to connect peripherals such as a mouse and keyboard or to connect a USB stick for transfer-

ring files. Two of the USB interfaces are on the front of the instrument and two are on the rear of the instrument.

8.4.5 USB Device Port

Instruments of the new generation have a Type B USB device connector on the rear panel in addition to the normal USB connector. The Type B connector is commonly used for hubs and external hard disk drives. The RS UPV can also be controlled via this port if the controller has the necessary drivers.

Remote control via USB is described in [chapter 6.3.3, "Remote Control via the USB Device Interface"](#), on page 810.

8.4.5.1 USB device interface messages

In the case of a USB device link, the interface messages are called "Low-Level Control Messages". They can be used to emulate the interface messages of the IEC/IEEE bus.

Table 8-5: USB device interface messages

| Command | | Effect on instrument |
|---------|-------------------------|--|
| &ABO | (Abort) | Terminates processing of commands that have just been received. |
| &DCL | (Device Clear) | Ends processing of the commands that were just received and sets the command processing software to a defined initial state. Does not modify the instrument configuration. |
| >L | (Go to Local) | Transition to the "Local" state (manual operation). |
| >R | (Go to Remote) | Transition to the "Remote" state (remote control). |
| &GET | (Group Execute Trigger) | Triggers a measurement or a sweep. |
| &LLO | (Local Lockout) | The manual LOCAL switchover function is disabled. |
| &POL | (Serial Poll) | A serial poll is executed. |
| &NREN | (Not Remote Enable) | Manual switching to LOCAL mode is enabled. |

8.4.6 Printer Connector (LPT)

The 25-pin connector LPT on the rear panel of the R&S UPV allows a printer to be connected (not with FMR9 or FMR11, see [chapter 2.6.1, "Retrieving Computer Hardware Information and Windows Operating System"](#), on page 50).

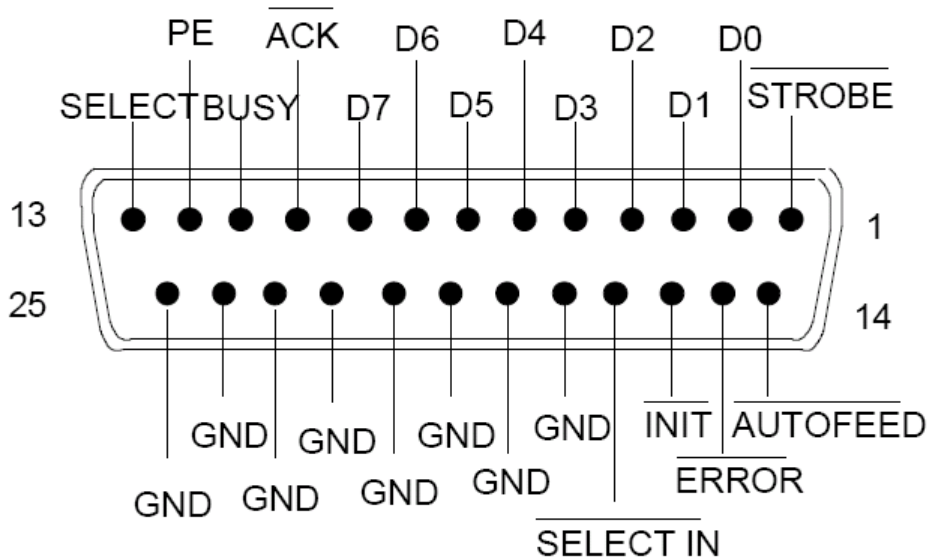


Table 8-6: Pin assignment of LPT connector

| Connection | Signal | Input (I)
Output (O) | Meaning |
|------------|----------|-------------------------|--|
| 1 | STROBE | A | Pulse for transferring a data byte; min. 1 μs pulse width (active LOW). |
| 2 | D0 | A | Data line 0 |
| 3 | D1 | A | Data line 1 |
| 4 | D2 | A | Data line 2 |
| 5 | D3 | A | Data line 3 |
| 6 | D4 | A | Data line 4 |
| 7 | D5 | A | Data line 5 |
| 8 | D6 | A | Data line 6 |
| 9 | D7 | A | Data line 7 |
| 10 | ACK | E | Indicates the printer's readiness to receive the next byte (active LOW). |
| 11 | BUSY | E | Signal active if the printer cannot receive any data. |
| 12 | PE | E | The signal becomes active if there is no paper in the printer (active HIGH). |
| 13 | SELECT | E | The signal becomes active if the printer has been selected (active HIGH). |
| 14 | AUTOFEED | A | If the signal is active, the printer automatically performs a line feed after each line (active LOW). |
| 15 | ERROR | E | This signal becomes active if there is no paper in the printer, the printer is not selected or the printer has an error status (active LOW). |
| 16 | INIT | A | Initialization of the printer (active LOW). |

| Connection | Signal | Input (I)
Output (O) | Meaning |
|------------|-----------|-------------------------|---|
| 17 | SELECT IN | A | If the signal is active, the codes DC1/DC3 are ignored by the printer (active LOW). |
| 18 - 25 | GND | | Ground connections. |

8.4.7 Monitor Connector (MONITOR)

The 15-pin connector MONITOR on the rear of the instrument allows a VGA monitor to be connected.

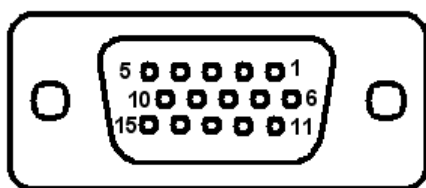


Table 8-7: Pin assignment of the MONITOR connector

| Pin | Signal | Pin | Signal | Pin | Signal |
|-----|----------------|-----|--------|-----|----------------|
| 1 | Red (output) | 6 | GND | 11 | (NC) |
| 2 | Green (output) | 7 | GND | 12 | (NC) |
| 3 | Blue (output) | 8 | GND | 13 | HSYNC (output) |
| 4 | (NC) | 9 | GND | 14 | VSYNC (output) |
| 5 | GND | 10 | GND | 15 | (NC) |

8.4.8 Monitor connection (DVI-D)

If the R&S UPV is equipped with an FMR9 or FMR11 (see [chapter 2.6.1, "Retrieving Computer Hardware Information and Windows Operating System"](#), on page 50) it is also equipped with a DVI connection in addition to the analog VGA monitor output. This permits the connection of a more modern digital monitor.

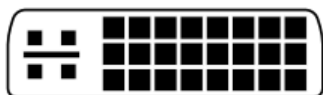


Table 8-8: Pin assignment of the DVI-D socket

| Pin | Signal | Pin | Signal | Pin | Signal |
|-----|-------------|-----|-----------|-----|-----------|
| 1 | Data 2- red | 11 | Shielding | 21 | - |
| 2 | Data 2+ red | 12 | - | 22 | Shielding |
| 3 | Shielding | 13 | - | 23 | Clock+ |

| Pin | Signal | Pin | Signal | Pin | Signal |
|-----|---------------|-----|----------------|-----|------------|
| 4 | - | 14 | +5 V / 0.2 A | 24 | Clock- |
| 5 | - | 15 | Shielding | | |
| 6 | DDC-clock | 16 | Hotplug detect | C1 | CRT red |
| 7 | DDC-data | 17 | Data 0- blue | C2 | CRT green |
| 8 | - | 18 | Data 0+ blue | C3 | CRT blue |
| 9 | Data 1- green | 19 | Shielding | C4 | CRT HSync |
| 10 | Data 1+ green | 20 | - | C5 | CRT-ground |

List of Commands

| | |
|---|-----|
| *CLS..... | 852 |
| *ESE..... | 852 |
| *ESR?..... | 852 |
| *GTL..... | 852 |
| *IDN?..... | 852 |
| *IST?..... | 853 |
| *OPC..... | 853 |
| *OPC?..... | 853 |
| *OPT?..... | 853 |
| *PRE..... | 853 |
| *PSC..... | 854 |
| *RST..... | 854 |
| *SRE..... | 854 |
| *STB?..... | 854 |
| *TRG..... | 854 |
| *WAI..... | 855 |
| ABORT..... | 909 |
| ARM:FREQUency:START..... | 911 |
| ARM:FREQUency:STOP..... | 911 |
| ARM:LEVEl:MIN..... | 911 |
| ARM:VOLTage:START..... | 911 |
| ARM:VOLTage:STOP..... | 911 |
| AUXiliaries:AAUXout..... | 962 |
| AUXiliaries:AUDMonitor..... | 962 |
| AUXiliaries:DCValue..... | 962 |
| AUXiliaries:PHONE..... | 962 |
| AUXiliaries:PHPermanent..... | 963 |
| AUXiliaries:SPEaker:CHANnel..... | 963 |
| AUXiliaries:SPEaker:SOURce..... | 963 |
| AUXiliaries:SPEaker:STATe..... | 963 |
| AUXiliaries:SPEaker:VOLume..... | 963 |
| AUXiliaries:TRIGger:INPut:EDGE..... | 963 |
| AUXiliaries:TRIGger:INPut:ENABLE..... | 963 |
| AUXiliaries:TRIGger:INPut:MODE..... | 964 |
| AUXiliaries:TRIGger:OUTPut:EDGE..... | 964 |
| AUXiliaries:TRIGger:OUTPut:ENABLE..... | 964 |
| AUXiliaries:TRIGger:OUTPut:FREQUency..... | 964 |
| AUXiliaries:TRIGger:OUTPut:MODE..... | 964 |
| DATA:BARGraph:COUNT:X<n4>?..... | 925 |
| DATA:BARGraph:COUNT:Y<n4>?..... | 925 |
| DATA:BARGraph:X<n3>?..... | 926 |
| DATA:BARGraph:Y<n3>?..... | 926 |
| DATA:FFT:COUNT:X<n4>?..... | 925 |
| DATA:FFT:COUNT:Y<n4>?..... | 925 |
| DATA:FFT:X<n3>?..... | 926 |
| DATA:FFT:Y<n3>?..... | 926 |
| DATA:SWEep:COUNT:X<n4>?..... | 925 |

| | |
|---|-----|
| DATA:SWEep:COUNT:Y<n4>?..... | 925 |
| DATA:SWEep:X<n3>?..... | 926 |
| DATA:SWEep:Y<n3>?..... | 926 |
| DISPlay:BARGraph<n2>:A:BOTTom..... | 977 |
| DISPlay:BARGraph<n2>:A:CHANnel..... | 977 |
| DISPlay:BARGraph<n2>:A:LABel:AUTO..... | 977 |
| DISPlay:BARGraph<n2>:A:LABel:USER..... | 978 |
| DISPlay:BARGraph<n2>:A:LEGend:DESCRiption..... | 978 |
| DISPlay:BARGraph<n2>:A:LEGend:SHOW..... | 978 |
| DISPlay:BARGraph<n2>:A:LIMLower..... | 979 |
| DISPlay:BARGraph<n2>:A:LIMLower:SOURce..... | 979 |
| DISPlay:BARGraph<n2>:A:LIMLower:SOURce:FILE..... | 979 |
| DISPlay:BARGraph<n2>:A:LIMLower:SOURce:VALue..... | 980 |
| DISPlay:BARGraph<n2>:A:LIMShift..... | 980 |
| DISPlay:BARGraph<n2>:A:LIMShift:PARAllel..... | 980 |
| DISPlay:BARGraph<n2>:A:LIMShift:SYMMetrical..... | 981 |
| DISPlay:BARGraph<n2>:A:LIMUpper..... | 981 |
| DISPlay:BARGraph<n2>:A:LIMUpper:SOURce..... | 981 |
| DISPlay:BARGraph<n2>:A:LIMUpper:SOURce:FILE..... | 981 |
| DISPlay:BARGraph<n2>:A:LIMUpper:SOURce:VALue..... | 982 |
| DISPlay:BARGraph<n2>:A:NORMalize..... | 982 |
| DISPlay:BARGraph<n2>:A:NORMalize:VALue..... | 982 |
| DISPlay:BARGraph<n2>:A:REFerence..... | 983 |
| DISPlay:BARGraph<n2>:A:REFerence:FILE..... | 983 |
| DISPlay:BARGraph<n2>:A:REFerence:VALue..... | 983 |
| DISPlay:BARGraph<n2>:A:SPACing..... | 983 |
| DISPlay:BARGraph<n2>:A:TOP..... | 984 |
| DISPlay:BARGraph<n2>:A:UNIT..... | 984 |
| DISPlay:BARGraph<n2>:A:UNIT:AUTO..... | 984 |
| DISPlay:BARGraph<n2>:A:UNIT:TRACK..... | 985 |
| DISPlay:BARGraph<n2>:A:UNIT:USER..... | 985 |
| DISPlay:BARGraph<n2>:A:UPDate..... | 985 |
| DISPlay:BARGraph<n2>:A:YSource..... | 985 |
| DISPlay:BARGraph<n2>:A:YSource:FILE..... | 986 |
| DISPlay:BARGraph<n2>:B:BOTTom..... | 977 |
| DISPlay:BARGraph<n2>:B:CHANnel..... | 977 |
| DISPlay:BARGraph<n2>:B:LABel:AUTO..... | 977 |
| DISPlay:BARGraph<n2>:B:LABel:USER..... | 978 |
| DISPlay:BARGraph<n2>:B:LEGend:DESCRiption..... | 978 |
| DISPlay:BARGraph<n2>:B:LEGend:SHOW..... | 978 |
| DISPlay:BARGraph<n2>:B:LIMLower..... | 979 |
| DISPlay:BARGraph<n2>:B:LIMLower:SOURce..... | 979 |
| DISPlay:BARGraph<n2>:B:LIMLower:SOURce:FILE..... | 979 |
| DISPlay:BARGraph<n2>:B:LIMLower:SOURce:VALue..... | 980 |
| DISPlay:BARGraph<n2>:B:LIMShift..... | 980 |
| DISPlay:BARGraph<n2>:B:LIMShift:PARAllel..... | 980 |
| DISPlay:BARGraph<n2>:B:LIMShift:SYMMetrical..... | 981 |
| DISPlay:BARGraph<n2>:B:LIMUpper..... | 981 |
| DISPlay:BARGraph<n2>:B:LIMUpper:SOURce..... | 981 |
| DISPlay:BARGraph<n2>:B:LIMUpper:SOURce:FILE..... | 982 |

| | |
|---|------|
| DISPlay:BARGraph<n2>:B:LIMUpper:SOURce:VALue..... | 982 |
| DISPlay:BARGraph<n2>:B:NORMalize..... | 982 |
| DISPlay:BARGraph<n2>:B:NORMalize:VALue..... | 982 |
| DISPlay:BARGraph<n2>:B:REFerence..... | 983 |
| DISPlay:BARGraph<n2>:B:REFerence:FILE..... | 983 |
| DISPlay:BARGraph<n2>:B:REFerence:VALue..... | 983 |
| DISPlay:BARGraph<n2>:B:SPACing..... | 983 |
| DISPlay:BARGraph<n2>:B:TOP..... | 984 |
| DISPlay:BARGraph<n2>:B:UNIT..... | 984 |
| DISPlay:BARGraph<n2>:B:UNIT:AUTO..... | 984 |
| DISPlay:BARGraph<n2>:B:UNIT:TRACK..... | 985 |
| DISPlay:BARGraph<n2>:B:UNIT:USER..... | 985 |
| DISPlay:BARGraph<n2>:B:UPDate..... | 985 |
| DISPlay:BARGraph<n2>:B:YSource..... | 985 |
| DISPlay:BARGraph<n2>:B:YSource:FILE..... | 986 |
| DISPlay:BARGraph<n2>:DLISt:FILTer..... | 986 |
| DISPlay:BARGraph<n2>:MCHMode..... | 988 |
| DISPlay:BARGraph<n2>:MINMax..... | 987 |
| DISPlay:BARGraph<n2>:OCURsor:MODE..... | 1008 |
| DISPlay:BARGraph<n2>:OCURsor:POSMode..... | 1009 |
| DISPlay:BARGraph<n2>:OCURsor:SETTo:MAX..... | 1009 |
| DISPlay:BARGraph<n2>:OCURsor:SETTo:MIN..... | 1010 |
| DISPlay:BARGraph<n2>:OCURsor:SETTo:XPOS..... | 1011 |
| DISPlay:BARGraph<n2>:OCURsor:SETTo:YPOS..... | 1012 |
| DISPlay:BARGraph<n2>:OCURsor:STATe..... | 1013 |
| DISPlay:BARGraph<n2>:OCURsor:Y?..... | 1013 |
| DISPlay:BARGraph<n2>:SCANoffset..... | 917 |
| DISPlay:BARGraph<n2>:TITLe:DESCRiption..... | 988 |
| DISPlay:BARGraph<n2>:TITLe:SHOW..... | 988 |
| DISPlay:BARGraph<n2>:TRACk:LIMit..... | 988 |
| DISPlay:BARGraph<n2>:TRACk:REFerence..... | 989 |
| DISPlay:BARGraph<n2>:TRACk:SCALing..... | 989 |
| DISPlay:BARGraph<n2>:XCURsor:MODE..... | 1008 |
| DISPlay:BARGraph<n2>:XCURsor:POSMode..... | 1009 |
| DISPlay:BARGraph<n2>:XCURsor:SETTo:MAX..... | 1009 |
| DISPlay:BARGraph<n2>:XCURsor:SETTo:MIN..... | 1010 |
| DISPlay:BARGraph<n2>:XCURsor:SETTo:XPOS..... | 1011 |
| DISPlay:BARGraph<n2>:XCURsor:SETTo:YPOS..... | 1012 |
| DISPlay:BARGraph<n2>:XCURsor:STATe..... | 1013 |
| DISPlay:BARGraph<n2>:XCURsor:Y?..... | 1013 |
| DISPlay:FFT<n2>:A:BOTTom..... | 977 |
| DISPlay:FFT<n2>:A:CHANnel..... | 977 |
| DISPlay:FFT<n2>:A:LAbel:AUTO..... | 977 |
| DISPlay:FFT<n2>:A:LAbel:USER..... | 978 |
| DISPlay:FFT<n2>:A:LEGend:DESCRiption..... | 978 |
| DISPlay:FFT<n2>:A:LEGend:SHOW..... | 978 |
| DISPlay:FFT<n2>:A:LIMLower..... | 979 |
| DISPlay:FFT<n2>:A:LIMLower:SOURce..... | 979 |
| DISPlay:FFT<n2>:A:LIMLower:SOURce:FILE..... | 979 |
| DISPlay:FFT<n2>:A:LIMLower:SOURce:VALue..... | 980 |

| | |
|--|------|
| DISPlay:FFT<n2>:A:LIMShift..... | 980 |
| DISPlay:FFT<n2>:A:LIMShift:PARAllel..... | 980 |
| DISPlay:FFT<n2>:A:LIMShift:SYMMetrical..... | 981 |
| DISPlay:FFT<n2>:A:LIMUpper..... | 981 |
| DISPlay:FFT<n2>:A:LIMUpper:SOURce..... | 981 |
| DISPlay:FFT<n2>:A:LIMUpper:SOURce:FILE..... | 981 |
| DISPlay:FFT<n2>:A:LIMUpper:SOURce:VALue..... | 982 |
| DISPlay:FFT<n2>:A:MARKer:HARMonics..... | 1006 |
| DISPlay:FFT<n2>:A:MARKer:MODE..... | 1006 |
| DISPlay:FFT<n2>:A:MARKer:SETTo:OCURsor..... | 1006 |
| DISPlay:FFT<n2>:A:MARKer:SETTo:XCURsor..... | 1006 |
| DISPlay:FFT<n2>:A:MARKer:SETTo:XPOS..... | 1007 |
| DISPlay:FFT<n2>:A:NORMalize..... | 982 |
| DISPlay:FFT<n2>:A:NORMalize:VALue..... | 982 |
| DISPlay:FFT<n2>:A:REFerence..... | 983 |
| DISPlay:FFT<n2>:A:REFerence:FILE..... | 983 |
| DISPlay:FFT<n2>:A:REFerence:VALue..... | 983 |
| DISPlay:FFT<n2>:A:SPACing..... | 983 |
| DISPlay:FFT<n2>:A:TOP..... | 984 |
| DISPlay:FFT<n2>:A:UNIT..... | 984 |
| DISPlay:FFT<n2>:A:UNIT:AUTO..... | 984 |
| DISPlay:FFT<n2>:A:UNIT:TRACK..... | 985 |
| DISPlay:FFT<n2>:A:UNIT:USER..... | 985 |
| DISPlay:FFT<n2>:A:UPDate..... | 985 |
| DISPlay:FFT<n2>:A:YSOURce..... | 985 |
| DISPlay:FFT<n2>:A:YSOURce:FILE..... | 986 |
| DISPlay:FFT<n2>:B:BOTTom..... | 977 |
| DISPlay:FFT<n2>:B:CHANnel..... | 977 |
| DISPlay:FFT<n2>:B:LABel:AUTO..... | 977 |
| DISPlay:FFT<n2>:B:LABel:USER..... | 978 |
| DISPlay:FFT<n2>:B:LEGend:DESCRiption..... | 978 |
| DISPlay:FFT<n2>:B:LEGend:SHOW..... | 978 |
| DISPlay:FFT<n2>:B:LIMLower..... | 979 |
| DISPlay:FFT<n2>:B:LIMLower:SOURce..... | 979 |
| DISPlay:FFT<n2>:B:LIMLower:SOURce:FILE..... | 979 |
| DISPlay:FFT<n2>:B:LIMLower:SOURce:VALue..... | 980 |
| DISPlay:FFT<n2>:B:LIMShift..... | 980 |
| DISPlay:FFT<n2>:B:LIMShift:PARAllel..... | 980 |
| DISPlay:FFT<n2>:B:LIMShift:SYMMetrical..... | 981 |
| DISPlay:FFT<n2>:B:LIMUpper..... | 981 |
| DISPlay:FFT<n2>:B:LIMUpper:SOURce..... | 981 |
| DISPlay:FFT<n2>:B:LIMUpper:SOURce:FILE..... | 981 |
| DISPlay:FFT<n2>:B:LIMUpper:SOURce:VALue..... | 982 |
| DISPlay:FFT<n2>:B:MARKer:HARMonics..... | 1006 |
| DISPlay:FFT<n2>:B:MARKer:MODE..... | 1006 |
| DISPlay:FFT<n2>:B:MARKer:SETTo:OCURsor..... | 1006 |
| DISPlay:FFT<n2>:B:MARKer:SETTo:XCURsor..... | 1007 |
| DISPlay:FFT<n2>:B:MARKer:SETTo:XPOS..... | 1007 |
| DISPlay:FFT<n2>:B:NORMalize..... | 982 |
| DISPlay:FFT<n2>:B:NORMalize:VALue..... | 982 |

| | |
|---|------|
| DISPlay:FFT<n2>:B:REFerence..... | 983 |
| DISPlay:FFT<n2>:B:REFerence:FILE..... | 983 |
| DISPlay:FFT<n2>:B:REFerence:VALue..... | 983 |
| DISPlay:FFT<n2>:B:SPACing..... | 983 |
| DISPlay:FFT<n2>:B:TOP..... | 984 |
| DISPlay:FFT<n2>:B:UNIT..... | 984 |
| DISPlay:FFT<n2>:B:UNIT:AUTO..... | 984 |
| DISPlay:FFT<n2>:B:UNIT:TRACk..... | 985 |
| DISPlay:FFT<n2>:B:UNIT:USER..... | 985 |
| DISPlay:FFT<n2>:B:UPDate..... | 985 |
| DISPlay:FFT<n2>:B:YSource..... | 985 |
| DISPlay:FFT<n2>:B:YSource:FILE..... | 986 |
| DISPlay:FFT<n2>:DLISt:FILTer..... | 986 |
| DISPlay:FFT<n2>:MCHMode..... | 988 |
| DISPlay:FFT<n2>:MINMax..... | 987 |
| DISPlay:FFT<n2>:OCURsor:MODE..... | 1008 |
| DISPlay:FFT<n2>:OCURsor:POSMode..... | 1008 |
| DISPlay:FFT<n2>:OCURsor:SETTo:MAX..... | 1009 |
| DISPlay:FFT<n2>:OCURsor:SETTo:MIN..... | 1010 |
| DISPlay:FFT<n2>:OCURsor:SETTo:MRKA..... | 1010 |
| DISPlay:FFT<n2>:OCURsor:SETTo:MRKB..... | 1011 |
| DISPlay:FFT<n2>:OCURsor:SETTo:XPOS..... | 1011 |
| DISPlay:FFT<n2>:OCURsor:SETTo:YPOS..... | 1012 |
| DISPlay:FFT<n2>:OCURsor:STATe..... | 1012 |
| DISPlay:FFT<n2>:OCURsor:Y?..... | 1013 |
| DISPlay:FFT<n2>:SCANoffset..... | 917 |
| DISPlay:FFT<n2>:TITLe:DESCRiption..... | 988 |
| DISPlay:FFT<n2>:TITLe:SHOW..... | 988 |
| DISPlay:FFT<n2>:TRACk:LIMit..... | 988 |
| DISPlay:FFT<n2>:TRACk:REFerence..... | 988 |
| DISPlay:FFT<n2>:TRACk:SCALing..... | 989 |
| DISPlay:FFT<n2>:X:LABel:AUTO..... | 989 |
| DISPlay:FFT<n2>:X:LABel:USER..... | 989 |
| DISPlay:FFT<n2>:X:LEFT..... | 989 |
| DISPlay:FFT<n2>:X:REFerence:VALue..... | 990 |
| DISPlay:FFT<n2>:X:RIGHT..... | 990 |
| DISPlay:FFT<n2>:X:SCALing..... | 990 |
| DISPlay:FFT<n2>:X:SPACing..... | 990 |
| DISPlay:FFT<n2>:X:UNIT..... | 991 |
| DISPlay:FFT<n2>:X:UNIT:AUTO..... | 991 |
| DISPlay:FFT<n2>:X:UNIT:USER..... | 991 |
| DISPlay:FFT<n2>:XCURsor:MODE..... | 1008 |
| DISPlay:FFT<n2>:XCURsor:POSMode..... | 1008 |
| DISPlay:FFT<n2>:XCURsor:SETTo:MAX..... | 1009 |
| DISPlay:FFT<n2>:XCURsor:SETTo:MIN..... | 1010 |
| DISPlay:FFT<n2>:XCURsor:SETTo:MRKA..... | 1010 |
| DISPlay:FFT<n2>:XCURsor:SETTo:MRKB..... | 1011 |
| DISPlay:FFT<n2>:XCURsor:SETTo:XPOS..... | 1011 |
| DISPlay:FFT<n2>:XCURsor:SETTo:YPOS..... | 1012 |
| DISPlay:FFT<n2>:XCURsor:STATe..... | 1012 |

| | |
|---|------|
| DISPlay:FFT<n2>:XCURsor:Y?..... | 1013 |
| DISPlay:PESQ<n2>:A:BOTTom..... | 977 |
| DISPlay:PESQ<n2>:A:LABel:AUTO..... | 977 |
| DISPlay:PESQ<n2>:A:LABel:USER..... | 978 |
| DISPlay:PESQ<n2>:A:LEGend:DESCRiption..... | 978 |
| DISPlay:PESQ<n2>:A:LEGend:SHOW..... | 978 |
| DISPlay:PESQ<n2>:A:LIMLower..... | 979 |
| DISPlay:PESQ<n2>:A:LIMLower:SOURce..... | 979 |
| DISPlay:PESQ<n2>:A:LIMLower:SOURce:FILE..... | 979 |
| DISPlay:PESQ<n2>:A:LIMLower:SOURce:VALue..... | 980 |
| DISPlay:PESQ<n2>:A:LIMUpper..... | 981 |
| DISPlay:PESQ<n2>:A:LIMUpper:SOURce..... | 981 |
| DISPlay:PESQ<n2>:A:LIMUpper:SOURce:FILE..... | 982 |
| DISPlay:PESQ<n2>:A:LIMUpper:SOURce:VALue..... | 982 |
| DISPlay:PESQ<n2>:A:MARKer:MODE..... | 1006 |
| DISPlay:PESQ<n2>:A:MARKer:SETTo:OCURsor..... | 1007 |
| DISPlay:PESQ<n2>:A:MARKer:SETTo:XCURsor..... | 1007 |
| DISPlay:PESQ<n2>:A:MARKer:SETTo:XPOS..... | 1007 |
| DISPlay:PESQ<n2>:A:SPACing..... | 983 |
| DISPlay:PESQ<n2>:A:TOP..... | 984 |
| DISPlay:PESQ<n2>:A:UPDate..... | 985 |
| DISPlay:PESQ<n2>:A:YSource..... | 986 |
| DISPlay:PESQ<n2>:A:YSource:FILE..... | 986 |
| DISPlay:PESQ<n2>:B:BOTTom..... | 977 |
| DISPlay:PESQ<n2>:B:LABel:AUTO..... | 977 |
| DISPlay:PESQ<n2>:B:LABel:USER..... | 978 |
| DISPlay:PESQ<n2>:B:LEGend:DESCRiption..... | 978 |
| DISPlay:PESQ<n2>:B:LEGend:SHOW..... | 978 |
| DISPlay:PESQ<n2>:B:LIMLower..... | 979 |
| DISPlay:PESQ<n2>:B:LIMLower:SOURce..... | 979 |
| DISPlay:PESQ<n2>:B:LIMLower:SOURce:FILE..... | 979 |
| DISPlay:PESQ<n2>:B:LIMLower:SOURce:VALue..... | 980 |
| DISPlay:PESQ<n2>:B:LIMUpper..... | 981 |
| DISPlay:PESQ<n2>:B:LIMUpper:SOURce..... | 981 |
| DISPlay:PESQ<n2>:B:LIMUpper:SOURce:FILE..... | 982 |
| DISPlay:PESQ<n2>:B:LIMUpper:SOURce:VALue..... | 982 |
| DISPlay:PESQ<n2>:B:MARKer:MODE..... | 1006 |
| DISPlay:PESQ<n2>:B:MARKer:SETTo:OCURsor..... | 1007 |
| DISPlay:PESQ<n2>:B:MARKer:SETTo:XCURsor..... | 1007 |
| DISPlay:PESQ<n2>:B:MARKer:SETTo:XPOS..... | 1007 |
| DISPlay:PESQ<n2>:B:SPACing..... | 983 |
| DISPlay:PESQ<n2>:B:TOP..... | 984 |
| DISPlay:PESQ<n2>:B:UPDate..... | 985 |
| DISPlay:PESQ<n2>:B:YSource..... | 986 |
| DISPlay:PESQ<n2>:B:YSource:FILE..... | 986 |
| DISPlay:PESQ<n2>:DLISt:FILTer..... | 986 |
| DISPlay:PESQ<n2>:MINMax..... | 987 |
| DISPlay:PESQ<n2>:OCURsor:MODE..... | 1008 |
| DISPlay:PESQ<n2>:OCURsor:POSMode..... | 1009 |
| DISPlay:PESQ<n2>:OCURsor:SETTo:MAX..... | 1009 |

| | |
|--|------|
| DISPlay:PESQ<n2>:OCURsor:SETTo:MIN..... | 1010 |
| DISPlay:PESQ<n2>:OCURsor:SETTo:MRKA..... | 1010 |
| DISPlay:PESQ<n2>:OCURsor:SETTo:MRKB..... | 1011 |
| DISPlay:PESQ<n2>:OCURsor:SETTo:XPOS..... | 1011 |
| DISPlay:PESQ<n2>:OCURsor:SETTo:YPOS..... | 1012 |
| DISPlay:PESQ<n2>:OCURsor:STATe..... | 1012 |
| DISPlay:PESQ<n2>:OCURsor:Y?..... | 1013 |
| DISPlay:PESQ<n2>:SCANoffset..... | 917 |
| DISPlay:PESQ<n2>:TITLe:DESCRiption..... | 988 |
| DISPlay:PESQ<n2>:TITLe:SHOw..... | 988 |
| DISPlay:PESQ<n2>:TRACk:LIMit..... | 988 |
| DISPlay:PESQ<n2>:TRACk:SCALing..... | 989 |
| DISPlay:PESQ<n2>:X:LABel:AUTO..... | 989 |
| DISPlay:PESQ<n2>:X:LABel:USER..... | 989 |
| DISPlay:PESQ<n2>:X:LEFT..... | 990 |
| DISPlay:PESQ<n2>:X:RIGHT..... | 990 |
| DISPlay:PESQ<n2>:X:SCALing..... | 990 |
| DISPlay:PESQ<n2>:X:SPACing..... | 990 |
| DISPlay:PESQ<n2>:X:UNIT..... | 991 |
| DISPlay:PESQ<n2>:X:UNIT:AUTO..... | 991 |
| DISPlay:PESQ<n2>:X:UNIT:USER..... | 991 |
| DISPlay:PESQ<n2>:XCURsor:MODE..... | 1008 |
| DISPlay:PESQ<n2>:XCURsor:POSMode..... | 1009 |
| DISPlay:PESQ<n2>:XCURsor:SETTo:MAX..... | 1009 |
| DISPlay:PESQ<n2>:XCURsor:SETTo:MIN..... | 1010 |
| DISPlay:PESQ<n2>:XCURsor:SETTo:MRKA..... | 1011 |
| DISPlay:PESQ<n2>:XCURsor:SETTo:MRKB..... | 1011 |
| DISPlay:PESQ<n2>:XCURsor:SETTo:XPOS..... | 1011 |
| DISPlay:PESQ<n2>:XCURsor:SETTo:YPOS..... | 1012 |
| DISPlay:PESQ<n2>:XCURsor:STATe..... | 1012 |
| DISPlay:PESQ<n2>:XCURsor:Y?..... | 1013 |
| DISPlay:SWEep<n2>:A:BOTTom..... | 977 |
| DISPlay:SWEep<n2>:A:CHANnel..... | 977 |
| DISPlay:SWEep<n2>:A:LABel:AUTO..... | 978 |
| DISPlay:SWEep<n2>:A:LABel:USER..... | 978 |
| DISPlay:SWEep<n2>:A:LEGenD:DESCRiption..... | 978 |
| DISPlay:SWEep<n2>:A:LEGenD:SHOw..... | 979 |
| DISPlay:SWEep<n2>:A:LIMLower..... | 979 |
| DISPlay:SWEep<n2>:A:LIMLower:SOURce..... | 979 |
| DISPlay:SWEep<n2>:A:LIMLower:SOURce:FILE..... | 980 |
| DISPlay:SWEep<n2>:A:LIMLower:SOURce:VALue..... | 980 |
| DISPlay:SWEep<n2>:A:LIMShift..... | 980 |
| DISPlay:SWEep<n2>:A:LIMShift:PARAllel..... | 980 |
| DISPlay:SWEep<n2>:A:LIMShift:SYMMetrical..... | 981 |
| DISPlay:SWEep<n2>:A:LIMUpper..... | 981 |
| DISPlay:SWEep<n2>:A:LIMUpper:SOURce..... | 981 |
| DISPlay:SWEep<n2>:A:LIMUpper:SOURce:FILE..... | 982 |
| DISPlay:SWEep<n2>:A:LIMUpper:SOURce:VALue..... | 982 |
| DISPlay:SWEep<n2>:A:MARKer:MODE..... | 1006 |
| DISPlay:SWEep<n2>:A:MARKer:SETTo:OCURsor..... | 1007 |

| | |
|--|------|
| DISPlay:SWEEp<n2>:A:MARKer:SETTo:XCURsor..... | 1007 |
| DISPlay:SWEEp<n2>:A:MARKer:SETTo:XPOS..... | 1007 |
| DISPlay:SWEEp<n2>:A:NORMalize..... | 982 |
| DISPlay:SWEEp<n2>:A:NORMalize:VALue..... | 982 |
| DISPlay:SWEEp<n2>:A:REFerence..... | 983 |
| DISPlay:SWEEp<n2>:A:REFerence:FILE..... | 983 |
| DISPlay:SWEEp<n2>:A:REFerence:VALue..... | 983 |
| DISPlay:SWEEp<n2>:A:SPACing..... | 984 |
| DISPlay:SWEEp<n2>:A:TOP..... | 984 |
| DISPlay:SWEEp<n2>:A:UNIT..... | 984 |
| DISPlay:SWEEp<n2>:A:UNIT:AUTO..... | 984 |
| DISPlay:SWEEp<n2>:A:UNIT:TRACK..... | 985 |
| DISPlay:SWEEp<n2>:A:UNIT:USER..... | 985 |
| DISPlay:SWEEp<n2>:A:UPDate..... | 985 |
| DISPlay:SWEEp<n2>:A:YSource..... | 986 |
| DISPlay:SWEEp<n2>:A:YSource:FILE..... | 986 |
| DISPlay:SWEEp<n2>:B:BOTTom..... | 977 |
| DISPlay:SWEEp<n2>:B:CHANnel..... | 977 |
| DISPlay:SWEEp<n2>:B:LABel:AUTO..... | 978 |
| DISPlay:SWEEp<n2>:B:LABel:USER..... | 978 |
| DISPlay:SWEEp<n2>:B:LEGend:DESCRiption..... | 978 |
| DISPlay:SWEEp<n2>:B:LEGend:SHOW..... | 979 |
| DISPlay:SWEEp<n2>:B:LIMLower..... | 979 |
| DISPlay:SWEEp<n2>:B:LIMLower:SOURce..... | 979 |
| DISPlay:SWEEp<n2>:B:LIMLower:SOURce:FILE..... | 980 |
| DISPlay:SWEEp<n2>:B:LIMLower:SOURce:VALue..... | 980 |
| DISPlay:SWEEp<n2>:B:LIMShift..... | 980 |
| DISPlay:SWEEp<n2>:B:LIMShift:PARAllel..... | 980 |
| DISPlay:SWEEp<n2>:B:LIMShift:SYMMetrical..... | 981 |
| DISPlay:SWEEp<n2>:B:LIMUpper..... | 981 |
| DISPlay:SWEEp<n2>:B:LIMUpper:SOURce..... | 981 |
| DISPlay:SWEEp<n2>:B:LIMUpper:SOURce:FILE..... | 982 |
| DISPlay:SWEEp<n2>:B:LIMUpper:SOURce:VALue..... | 982 |
| DISPlay:SWEEp<n2>:B:MARKer:MODE..... | 1006 |
| DISPlay:SWEEp<n2>:B:MARKer:SETTo:OCURsor..... | 1007 |
| DISPlay:SWEEp<n2>:B:MARKer:SETTo:XCURsor..... | 1007 |
| DISPlay:SWEEp<n2>:B:MARKer:SETTo:XPOS..... | 1007 |
| DISPlay:SWEEp<n2>:B:NORMalize..... | 982 |
| DISPlay:SWEEp<n2>:B:NORMalize:VALue..... | 982 |
| DISPlay:SWEEp<n2>:B:REFerence..... | 983 |
| DISPlay:SWEEp<n2>:B:REFerence:FILE..... | 983 |
| DISPlay:SWEEp<n2>:B:REFerence:VALue..... | 983 |
| DISPlay:SWEEp<n2>:B:SPACing..... | 984 |
| DISPlay:SWEEp<n2>:B:TOP..... | 984 |
| DISPlay:SWEEp<n2>:B:UNIT..... | 984 |
| DISPlay:SWEEp<n2>:B:UNIT:AUTO..... | 984 |
| DISPlay:SWEEp<n2>:B:UNIT:TRACK..... | 985 |
| DISPlay:SWEEp<n2>:B:UNIT:USER..... | 985 |
| DISPlay:SWEEp<n2>:B:UPDate..... | 985 |
| DISPlay:SWEEp<n2>:B:YSource..... | 986 |

| | |
|--|------|
| DISPlay:SWEEp<n2>:B:YSource:FILE..... | 986 |
| DISPlay:SWEEp<n2>:DLISt:FILTer..... | 986 |
| DISPlay:SWEEp<n2>:HISTory..... | 987 |
| DISPlay:SWEEp<n2>:MINMax..... | 987 |
| DISPlay:SWEEp<n2>:OCURsor:MODE..... | 1008 |
| DISPlay:SWEEp<n2>:OCURsor:POSMode..... | 1009 |
| DISPlay:SWEEp<n2>:OCURsor:SETTo:MAX..... | 1009 |
| DISPlay:SWEEp<n2>:OCURsor:SETTo:MIN..... | 1010 |
| DISPlay:SWEEp<n2>:OCURsor:SETTo:MRKA..... | 1011 |
| DISPlay:SWEEp<n2>:OCURsor:SETTo:MRKB..... | 1011 |
| DISPlay:SWEEp<n2>:OCURsor:SETTo:XPOS..... | 1012 |
| DISPlay:SWEEp<n2>:OCURsor:SETTo:YPOS..... | 1012 |
| DISPlay:SWEEp<n2>:OCURsor:STATe..... | 1013 |
| DISPlay:SWEEp<n2>:OCURsor:Y?..... | 1013 |
| DISPlay:SWEEp<n2>:SCANoffset..... | 917 |
| DISPlay:SWEEp<n2>:SMODE..... | 988 |
| DISPlay:SWEEp<n2>:TITLe:DESCRiption..... | 988 |
| DISPlay:SWEEp<n2>:TITLe:SHOW..... | 988 |
| DISPlay:SWEEp<n2>:TRACk:LIMit..... | 988 |
| DISPlay:SWEEp<n2>:TRACk:REFerence..... | 989 |
| DISPlay:SWEEp<n2>:TRACk:SCALing..... | 989 |
| DISPlay:SWEEp<n2>:X:AXIS..... | 989 |
| DISPlay:SWEEp<n2>:X:LAbel:AUTO..... | 989 |
| DISPlay:SWEEp<n2>:X:LAbel:USER..... | 989 |
| DISPlay:SWEEp<n2>:X:LEFT..... | 990 |
| DISPlay:SWEEp<n2>:X:REFerence:VALue..... | 990 |
| DISPlay:SWEEp<n2>:X:RIGHT..... | 990 |
| DISPlay:SWEEp<n2>:X:SCALing..... | 990 |
| DISPlay:SWEEp<n2>:X:SOURce..... | 990 |
| DISPlay:SWEEp<n2>:X:SPACing..... | 990 |
| DISPlay:SWEEp<n2>:X:UNIT..... | 991 |
| DISPlay:SWEEp<n2>:X:UNIT:AUTO..... | 991 |
| DISPlay:SWEEp<n2>:X:UNIT:USER..... | 991 |
| DISPlay:SWEEp<n2>:XCURsor:MODE..... | 1008 |
| DISPlay:SWEEp<n2>:XCURsor:POSMode..... | 1009 |
| DISPlay:SWEEp<n2>:XCURsor:SETTo:MAX..... | 1009 |
| DISPlay:SWEEp<n2>:XCURsor:SETTo:MIN..... | 1010 |
| DISPlay:SWEEp<n2>:XCURsor:SETTo:MRKA..... | 1011 |
| DISPlay:SWEEp<n2>:XCURsor:SETTo:MRKB..... | 1011 |
| DISPlay:SWEEp<n2>:XCURsor:SETTo:XPOS..... | 1012 |
| DISPlay:SWEEp<n2>:XCURsor:SETTo:YPOS..... | 1012 |
| DISPlay:SWEEp<n2>:XCURsor:STATe..... | 1013 |
| DISPlay:SWEEp<n2>:XCURsor:Y?..... | 1013 |
| DISPlay:WAVeform<n2>:A:BOTTom..... | 977 |
| DISPlay:WAVeform<n2>:A:CHANnel..... | 977 |
| DISPlay:WAVeform<n2>:A:LAbel:AUTO..... | 977 |
| DISPlay:WAVeform<n2>:A:LAbel:USER..... | 978 |
| DISPlay:WAVeform<n2>:A:LEGend:DESCRiption..... | 978 |
| DISPlay:WAVeform<n2>:A:LEGend:SHOW..... | 978 |
| DISPlay:WAVeform<n2>:A:LIMLower..... | 979 |

| | |
|---|------|
| DISPlay:WAVeform<n2>:A:LIMLower:SOURce..... | 979 |
| DISPlay:WAVeform<n2>:A:LIMLower:SOURce:FILE..... | 979 |
| DISPlay:WAVeform<n2>:A:LIMLower:SOURce:VALue..... | 980 |
| DISPlay:WAVeform<n2>:A:LIMShift..... | 980 |
| DISPlay:WAVeform<n2>:A:LIMShift:PARAllel..... | 980 |
| DISPlay:WAVeform<n2>:A:LIMShift:SYMMetrical..... | 981 |
| DISPlay:WAVeform<n2>:A:LIMUpper..... | 981 |
| DISPlay:WAVeform<n2>:A:LIMUpper:SOURce..... | 981 |
| DISPlay:WAVeform<n2>:A:LIMUpper:SOURce:FILE..... | 981 |
| DISPlay:WAVeform<n2>:A:LIMUpper:SOURce:VALue..... | 982 |
| DISPlay:WAVeform<n2>:A:MARKer:MODE..... | 1006 |
| DISPlay:WAVeform<n2>:A:MARKer:SETTo:OCURsor..... | 1007 |
| DISPlay:WAVeform<n2>:A:MARKer:SETTo:XCURsor..... | 1007 |
| DISPlay:WAVeform<n2>:A:MARKer:SETTo:XPOS..... | 1007 |
| DISPlay:WAVeform<n2>:A:REFerence..... | 983 |
| DISPlay:WAVeform<n2>:A:REFerence:VALue..... | 983 |
| DISPlay:WAVeform<n2>:A:SPACing..... | 983 |
| DISPlay:WAVeform<n2>:A:TOP..... | 984 |
| DISPlay:WAVeform<n2>:A:UNIT..... | 984 |
| DISPlay:WAVeform<n2>:A:UNIT:AUTO..... | 984 |
| DISPlay:WAVeform<n2>:A:UNIT:USER..... | 985 |
| DISPlay:WAVeform<n2>:A:UPDate..... | 985 |
| DISPlay:WAVeform<n2>:A:YSORce..... | 985 |
| DISPlay:WAVeform<n2>:A:YSORce:FILE..... | 986 |
| DISPlay:WAVeform<n2>:B:BOTTom..... | 977 |
| DISPlay:WAVeform<n2>:B:CHANnel..... | 977 |
| DISPlay:WAVeform<n2>:B:LABel:AUTO..... | 977 |
| DISPlay:WAVeform<n2>:B:LABel:USER..... | 978 |
| DISPlay:WAVeform<n2>:B:LEGend:DESCRiption..... | 978 |
| DISPlay:WAVeform<n2>:B:LEGend:SHOW..... | 978 |
| DISPlay:WAVeform<n2>:B:LIMLower..... | 979 |
| DISPlay:WAVeform<n2>:B:LIMLower:SOURce..... | 979 |
| DISPlay:WAVeform<n2>:B:LIMLower:SOURce:FILE..... | 979 |
| DISPlay:WAVeform<n2>:B:LIMLower:SOURce:VALue..... | 980 |
| DISPlay:WAVeform<n2>:B:LIMShift..... | 980 |
| DISPlay:WAVeform<n2>:B:LIMShift:PARAllel..... | 980 |
| DISPlay:WAVeform<n2>:B:LIMShift:SYMMetrical..... | 981 |
| DISPlay:WAVeform<n2>:B:LIMUpper..... | 981 |
| DISPlay:WAVeform<n2>:B:LIMUpper:SOURce..... | 981 |
| DISPlay:WAVeform<n2>:B:LIMUpper:SOURce:FILE..... | 981 |
| DISPlay:WAVeform<n2>:B:LIMUpper:SOURce:VALue..... | 982 |
| DISPlay:WAVeform<n2>:B:MARKer:MODE..... | 1006 |
| DISPlay:WAVeform<n2>:B:MARKer:SETTo:OCURsor..... | 1007 |
| DISPlay:WAVeform<n2>:B:MARKer:SETTo:XCURsor..... | 1007 |
| DISPlay:WAVeform<n2>:B:MARKer:SETTo:XPOS..... | 1007 |
| DISPlay:WAVeform<n2>:B:REFerence..... | 983 |
| DISPlay:WAVeform<n2>:B:REFerence:VALue..... | 983 |
| DISPlay:WAVeform<n2>:B:SPACing..... | 983 |
| DISPlay:WAVeform<n2>:B:TOP..... | 984 |
| DISPlay:WAVeform<n2>:B:UNIT..... | 984 |

| | |
|--|------|
| DISPlay:WAVeform<n2>:B:UNIT:AUTO..... | 984 |
| DISPlay:WAVeform<n2>:B:UNIT:USER..... | 985 |
| DISPlay:WAVeform<n2>:B:UPDate..... | 985 |
| DISPlay:WAVeform<n2>:B:YSource..... | 985 |
| DISPlay:WAVeform<n2>:B:YSource:FILE..... | 986 |
| DISPlay:WAVeform<n2>:DLISt:FILTer..... | 986 |
| DISPlay:WAVeform<n2>:OCURsor:MODE..... | 1008 |
| DISPlay:WAVeform<n2>:OCURsor:POSMode..... | 1008 |
| DISPlay:WAVeform<n2>:OCURsor:SETTo:MAX..... | 1009 |
| DISPlay:WAVeform<n2>:OCURsor:SETTo:MIN..... | 1010 |
| DISPlay:WAVeform<n2>:OCURsor:SETTo:MRKA..... | 1010 |
| DISPlay:WAVeform<n2>:OCURsor:SETTo:MRKB..... | 1011 |
| DISPlay:WAVeform<n2>:OCURsor:SETTo:XPOS..... | 1011 |
| DISPlay:WAVeform<n2>:OCURsor:SETTo:YPOS..... | 1012 |
| DISPlay:WAVeform<n2>:OCURsor:STATe..... | 1012 |
| DISPlay:WAVeform<n2>:OCURsor:Y?..... | 1013 |
| DISPlay:WAVeform<n2>:SCANoffset..... | 917 |
| DISPlay:WAVeform<n2>:TITLe:DESCRiption..... | 988 |
| DISPlay:WAVeform<n2>:TITLe:SHOW..... | 988 |
| DISPlay:WAVeform<n2>:TRACk:LIMit..... | 988 |
| DISPlay:WAVeform<n2>:TRACk:REFerence..... | 988 |
| DISPlay:WAVeform<n2>:TRACk:SCALing..... | 989 |
| DISPlay:WAVeform<n2>:X:LABel:AUTO..... | 989 |
| DISPlay:WAVeform<n2>:X:LABel:USER..... | 989 |
| DISPlay:WAVeform<n2>:X:LEFT..... | 989 |
| DISPlay:WAVeform<n2>:X:REFerence:VALue..... | 990 |
| DISPlay:WAVeform<n2>:X:RIGHT..... | 990 |
| DISPlay:WAVeform<n2>:X:SCALing..... | 990 |
| DISPlay:WAVeform<n2>:X:SPACing..... | 990 |
| DISPlay:WAVeform<n2>:X:UNIT..... | 991 |
| DISPlay:WAVeform<n2>:X:UNIT:AUTO..... | 991 |
| DISPlay:WAVeform<n2>:X:UNIT:USER..... | 991 |
| DISPlay:WAVeform<n2>:XCURsor:MODE..... | 1008 |
| DISPlay:WAVeform<n2>:XCURsor:POSMode..... | 1008 |
| DISPlay:WAVeform<n2>:XCURsor:SETTo:MAX..... | 1009 |
| DISPlay:WAVeform<n2>:XCURsor:SETTo:MIN..... | 1010 |
| DISPlay:WAVeform<n2>:XCURsor:SETTo:MRKA..... | 1010 |
| DISPlay:WAVeform<n2>:XCURsor:SETTo:MRKB..... | 1011 |
| DISPlay:WAVeform<n2>:XCURsor:SETTo:XPOS..... | 1011 |
| DISPlay:WAVeform<n2>:XCURsor:SETTo:YPOS..... | 1012 |
| DISPlay:WAVeform<n2>:XCURsor:STATe..... | 1012 |
| DISPlay:WAVeform<n2>:XCURsor:Y?..... | 1013 |
| FORMat..... | 916 |
| HCOPY:DESTination..... | 1019 |
| HCOPY:FILE..... | 1019 |
| HCOPY:FILE:MODE..... | 1019 |
| HCOPY:GSIZe..... | 1019 |
| HCOPY:PRINter:ADDition..... | 1020 |
| HCOPY:PRINter:FOOTer..... | 1020 |
| HCOPY:PRINter:HEADer..... | 1020 |

| | |
|--------------------------------------|------|
| HCOPY:PRINter:ORientation..... | 1020 |
| HCOPY:SOURce..... | 1019 |
| HCOPY[:IMMediate]..... | 1019 |
| INITiate..... | 908 |
| INITiate:CONTInuous..... | 906 |
| INITiate:CONTInuous:TIMEout..... | 907 |
| INITiate:FORCe..... | 908 |
| INPut<n1>:ALIGnment..... | 903 |
| INPut<n1>:AUDIobits..... | 895 |
| INPut<n1>:BANDwidth:MODE..... | 893 |
| INPut<n1>:BCLK:FREQuency?..... | 897 |
| INPut<n1>:BSLope..... | 899 |
| INPut<n1>:CHANnel..... | 895 |
| INPut<n1>:CHMode..... | 903 |
| INPut<n1>:CLKFrequency..... | 903 |
| INPut<n1>:CLKSource..... | 904 |
| INPut<n1>:CLOCK..... | 899 |
| INPut<n1>:CODing..... | 899 |
| INPut<n1>:COMMon..... | 892 |
| INPut<n1>:COUPling..... | 893 |
| INPut<n1>:COUPling:CHANnels..... | 893 |
| INPut<n1>:DTYCycle..... | 904 |
| INPut<n1>:DWNFactor..... | 904 |
| INPut<n1>:FBIT..... | 899 |
| INPut<n1>:FILTer..... | 958 |
| INPut<n1>:FOFFset..... | 900 |
| INPut<n1>:FORMat..... | 897 |
| INPut<n1>:FSLope..... | 897 |
| INPut<n1>:FSYNc:FREQuency?..... | 900 |
| INPut<n1>:FWIDth..... | 900 |
| INPut<n1>:FWIDth:VALue..... | 900 |
| INPut<n1>:IMPedance..... | 892 |
| INPut<n1>:INPut..... | 897 |
| INPut<n1>:LBITs..... | 900 |
| INPut<n1>:LOGVoltage..... | 900 |
| INPut<n1>:MCHannels<n2>..... | 893 |
| INPut<n1>:MCHSource<n2>..... | 901 |
| INPut<n1>:MRATio..... | 901 |
| INPut<n1>:MSAMplefrequency..... | 901 |
| INPut<n1>:NOSLots..... | 901 |
| INPut<n1>:RANGe:CHANnels..... | 893 |
| INPut<n1>:RATio..... | 901 |
| INPut<n1>:RESYNc..... | 901 |
| INPut<n1>:SAMPle:FREQuency..... | 896 |
| INPut<n1>:SAMPle:FREQuency:MODE..... | 896 |
| INPut<n1>:SDELay..... | 902 |
| INPut<n1>:SLOTs<n2>..... | 902 |
| INPut<n1>:SLTLength..... | 902 |
| INPut<n1>:SPFRame..... | 902 |
| INPut<n1>:SYNCto..... | 902 |

| | |
|---|------|
| INPut<n1>:TIMeout..... | 902 |
| INPut<n1>:TYPE..... | 896 |
| INPut<n1>:WLENgth..... | 898 |
| INPut<n1>:WOffset..... | 898 |
| INSTRument<n1>..... | 855 |
| INSTRument<n1>..... | 891 |
| MMEMory:BARGraph<n2>:LIMit:OFFSet..... | 992 |
| MMEMory:BARGraph<n2>:LIMit:OFFSet:VALue..... | 992 |
| MMEMory:BARGraph<n2>:STAS..... | 992 |
| MMEMory:BARGraph<n2>:STORe..... | 992 |
| MMEMory:BARGraph<n2>:TRACe..... | 992 |
| MMEMory:COpy..... | 1023 |
| MMEMory:DATA..... | 1023 |
| MMEMory:DELeTe..... | 1024 |
| MMEMory:FFT<n2>:EQUalization:INVert..... | 991 |
| MMEMory:FFT<n2>:EQUalization:MODIfy..... | 991 |
| MMEMory:FFT<n2>:EQUalization:NORMfrequency..... | 992 |
| MMEMory:FFT<n2>:LIMit:OFFSet..... | 992 |
| MMEMory:FFT<n2>:LIMit:OFFSet:VALue..... | 992 |
| MMEMory:FFT<n2>:STAS..... | 992 |
| MMEMory:FFT<n2>:STORe..... | 992 |
| MMEMory:FFT<n2>:TRACe..... | 992 |
| MMEMory:LOAD:ARBITrary..... | 880 |
| MMEMory:LOAD:DWELl..... | 888 |
| MMEMory:LOAD:FREQuency..... | 888 |
| MMEMory:LOAD:FREQuency:SLCFrequency..... | 932 |
| MMEMory:LOAD:IEQUalize..... | 936 |
| MMEMory:LOAD:INTerval..... | 888 |
| MMEMory:LOAD:OEQUalize..... | 868 |
| MMEMory:LOAD:ONTime..... | 888 |
| MMEMory:LOAD:PHASe..... | 888 |
| MMEMory:LOAD:PWAVeform..... | 943 |
| MMEMory:LOAD:STATe..... | 1022 |
| MMEMory:LOAD:STEReo<n3>:OEQUalize..... | 872 |
| MMEMory:LOAD:VOLTagE..... | 888 |
| MMEMory:MDIRectory..... | 1024 |
| MMEMory:MOVE..... | 1024 |
| MMEMory:PESQ<n2>:LIMit:OFFSet..... | 992 |
| MMEMory:PESQ<n2>:LIMit:OFFSet:VALue..... | 992 |
| MMEMory:PESQ<n2>:STAS..... | 992 |
| MMEMory:PESQ<n2>:STORe..... | 992 |
| MMEMory:PESQ<n2>:TRACe..... | 993 |
| MMEMory:STORe:PWAVeform..... | 944 |
| MMEMory:STORe:STATe..... | 1022 |
| MMEMory:SWEep<n2>:EQUalization:INVert..... | 991 |
| MMEMory:SWEep<n2>:EQUalization:MODIfy..... | 991 |
| MMEMory:SWEep<n2>:EQUalization:NORMfrequency..... | 992 |
| MMEMory:SWEep<n2>:LIMit:OFFSet..... | 992 |
| MMEMory:SWEep<n2>:LIMit:OFFSet:VALue..... | 992 |
| MMEMory:SWEep<n2>:STAS..... | 992 |

| | |
|-----------------------------------|-----|
| MMEMory:SWEep<n2>:STORe..... | 992 |
| MMEMory:SWEep<n2>:TRACe..... | 993 |
| MMEMory:WAVEform<n2>:STAS..... | 992 |
| MMEMory:WAVEform<n2>:STORe..... | 992 |
| OUTPut..... | 890 |
| OUTPut:AUDIobits..... | 859 |
| OUTPut:AUXiliary:OUTPut..... | 859 |
| OUTPut:BANDwidth:MODE..... | 857 |
| OUTPut:BCLK:FREQuency?..... | 862 |
| OUTPut:BCLock:JITAmplitude..... | 864 |
| OUTPut:BCLock:JITFrequency..... | 864 |
| OUTPut:BSLope..... | 864 |
| OUTPut:CHANnel..... | 857 |
| OUTPut:CLOCK..... | 864 |
| OUTPut:CODing..... | 864 |
| OUTPut:CSIMulator..... | 859 |
| OUTPut:FBIT..... | 862 |
| OUTPut:FOFFset..... | 865 |
| OUTPut:FORMat..... | 862 |
| OUTPut:FSHape..... | 862 |
| OUTPut:FSLope..... | 865 |
| OUTPut:FSYnc:FREQuency?..... | 865 |
| OUTPut:FWIDth..... | 865 |
| OUTPut:FWIDth:VALue..... | 865 |
| OUTPut:IMPedance..... | 857 |
| OUTPut:IMPedance:UNBalanced?..... | 859 |
| OUTPut:INTClockfreq..... | 859 |
| OUTPut:LBITs..... | 865 |
| OUTPut:LOGVoltage..... | 865 |
| OUTPut:LOW..... | 857 |
| OUTPut:MCLKratio..... | 862 |
| OUTPut:MCLock:JITAmplitude..... | 866 |
| OUTPut:MCLock:JITFrequency..... | 866 |
| OUTPut:MRATio..... | 866 |
| OUTPut:MSAMplefrequency..... | 866 |
| OUTPut:NOSLots..... | 866 |
| OUTPut:POLarity..... | 862 |
| OUTPut:RATio..... | 866 |
| OUTPut:RESYnc..... | 866 |
| OUTPut:SAMPlE:FREQuency..... | 863 |
| OUTPut:SAMPlE:MODE..... | 859 |
| OUTPut:SIGNal:BALanced:LEVel..... | 860 |
| OUTPut:SIGNal:LEVel..... | 860 |
| OUTPut:SLCOffset..... | 867 |
| OUTPut:SLCSlope..... | 867 |
| OUTPut:SLCWidth..... | 867 |
| OUTPut:SLCWidth:VALue..... | 867 |
| OUTPut:SLTLength..... | 867 |
| OUTPut:SPFRame..... | 867 |
| OUTPut:SYnc:OUTPut..... | 860 |

| | |
|---|-----|
| OUTPut:SYNC:TYPE..... | 860 |
| OUTPut:TXData<n2>..... | 867 |
| OUTPut:TYPE..... | 858 |
| OUTPut:UNBalanced:OUTPut..... | 860 |
| OUTPut:WLENGth..... | 863 |
| OUTPut:WOFFset..... | 863 |
| SENSe:VOLTagE:RANGe<n3>:VALue..... | 895 |
| SENSe<1>CHIRPbased:DISToRtion<di>:SWEep<n>:A..... | 949 |
| SENSe<1>CHIRPbased:DISToRtion<di>:SWEep<n>:B..... | 949 |
| SENSe<1>CHIRPbased:MMODE:SWEep<n>:A..... | 949 |
| SENSe<1>CHIRPbased:MMODE:SWEep<n>:B..... | 949 |
| SENSe<1>CHIRPbased:POINts?..... | 950 |
| SENSe<1>CHIRPbased:RESolution?..... | 950 |
| SENSe<n1>:BANDwidth..... | 932 |
| SENSe<n1>:BANDwidth:MODE..... | 932 |
| SENSe<n1>:CHANnel:DELay..... | 940 |
| SENSe<n1>:CONFig:COpyOther..... | 993 |
| SENSe<n1>:DATA<n2>:ALL?..... | 913 |
| SENSe<n1>:DATA<n2>?..... | 911 |
| SENSe<n1>:DMODE..... | 896 |
| SENSe<n1>:FILTer<n2>..... | 958 |
| SENSe<n1>:FREQuency..... | 933 |
| SENSe<n1>:FREQuency:FACTor..... | 933 |
| SENSe<n1>:FREQuency:LIMit..... | 940 |
| SENSe<n1>:FREQuency:LIMit:LOWer..... | 938 |
| SENSe<n1>:FREQuency:LIMit:UPPer..... | 938 |
| SENSe<n1>:FREQuency:SElect..... | 933 |
| SENSe<n1>:FREQuency:SETTling:COUnT..... | 956 |
| SENSe<n1>:FREQuency:SETTling:MODE..... | 956 |
| SENSe<n1>:FREQuency:SETTling:RESolution..... | 956 |
| SENSe<n1>:FREQuency:SETTling:TOLerance..... | 956 |
| SENSe<n1>:FREQuency:SETTling:TOUT..... | 957 |
| SENSe<n1>:FUNCTion..... | 929 |
| SENSe<n1>:FUNCTion:APERture:MODE..... | 930 |
| SENSe<n1>:FUNCTion:BARGraph..... | 936 |
| SENSe<n1>:FUNCTion:DCSuppression..... | 935 |
| SENSe<n1>:FUNCTion:DISToRtion<n3>..... | 937 |
| SENSe<n1>:FUNCTion:DMODE..... | 931 |
| SENSe<n1>:FUNCTion:FFT:AVERage..... | 941 |
| SENSe<n1>:FUNCTion:FFT:AVERage:MODE..... | 941 |
| SENSe<n1>:FUNCTion:FFT:CMpFactor..... | 941 |
| SENSe<n1>:FUNCTion:FFT:MTIME?..... | 941 |
| SENSe<n1>:FUNCTion:FFT:RESolution?..... | 941 |
| SENSe<n1>:FUNCTion:FFT:SIZE..... | 941 |
| SENSe<n1>:FUNCTion:FFT:SPAN..... | 942 |
| SENSe<n1>:FUNCTion:FFT:STARt?..... | 942 |
| SENSe<n1>:FUNCTion:FFT:STATe..... | 937 |
| SENSe<n1>:FUNCTion:FFT:STOP?..... | 942 |
| SENSe<n1>:FUNCTion:FFT:TRIGgered..... | 942 |
| SENSe<n1>:FUNCTion:FFT:USAMple..... | 942 |

| | |
|---|-----|
| SENSe<n1>:FUNCTION:FFT:WINDow..... | 942 |
| SENSe<n1>:FUNCTION:MMODE..... | 931 |
| SENSe<n1>:FUNCTION:PEAQ:AVGDelay?..... | 945 |
| SENSe<n1>:FUNCTION:PEAQ:DEGLLevel?..... | 945 |
| SENSe<n1>:FUNCTION:PEAQ:DELDetect..... | 945 |
| SENSe<n1>:FUNCTION:PEAQ:REFLevel?..... | 945 |
| SENSe<n1>:FUNCTION:PEAQ:VERSion..... | 946 |
| SENSe<n1>:FUNCTION:PESQ:ACCording..... | 944 |
| SENSe<n1>:FUNCTION:PESQ:AVGDelay?..... | 944 |
| SENSe<n1>:FUNCTION:PESQ:DEGLLevel?..... | 944 |
| SENSe<n1>:FUNCTION:PESQ:REFLevel?..... | 944 |
| SENSe<n1>:FUNCTION:POLQa:ATTenuation?..... | 946 |
| SENSe<n1>:FUNCTION:POLQa:AUTogain..... | 946 |
| SENSe<n1>:FUNCTION:POLQa:AVGDelay?..... | 947 |
| SENSe<n1>:FUNCTION:POLQa:BAND..... | 947 |
| SENSe<n1>:FUNCTION:POLQa:DEGLLevel?..... | 947 |
| SENSe<n1>:FUNCTION:POLQa:DEGSpratio?..... | 947 |
| SENSe<n1>:FUNCTION:POLQa:GAIN..... | 947 |
| SENSe<n1>:FUNCTION:POLQa:MAXDelay?..... | 947 |
| SENSe<n1>:FUNCTION:POLQa:MINDelay?..... | 948 |
| SENSe<n1>:FUNCTION:POLQa:REFLevel?..... | 948 |
| SENSe<n1>:FUNCTION:POLQa:REFSpratio?..... | 948 |
| SENSe<n1>:FUNCTION:POLQa:SNRDeg?..... | 948 |
| SENSe<n1>:FUNCTION:POLQa:SNRRRef?..... | 948 |
| SENSe<n1>:FUNCTION:RECORD:BPS..... | 952 |
| SENSe<n1>:FUNCTION:RECORD:FILE..... | 952 |
| SENSe<n1>:FUNCTION:RECORD:FLENGth?..... | 952 |
| SENSe<n1>:FUNCTION:RECORD:LENGth..... | 952 |
| SENSe<n1>:FUNCTION:RECORD:TRIGger:LEVel..... | 953 |
| SENSe<n1>:FUNCTION:RECORD:TRIGger:PRE..... | 953 |
| SENSe<n1>:FUNCTION:RECORD:TRIGger:SLOPe..... | 953 |
| SENSe<n1>:FUNCTION:RECORD:TRIGger:SOURce..... | 953 |
| SENSe<n1>:FUNCTION:REFNment..... | 937 |
| SENSe<n1>:FUNCTION:SETTLing:COUNT..... | 956 |
| SENSe<n1>:FUNCTION:SETTLing:MODE..... | 956 |
| SENSe<n1>:FUNCTION:SETTLing:RESolution..... | 956 |
| SENSe<n1>:FUNCTION:SETTLing:TOLerance..... | 956 |
| SENSe<n1>:FUNCTION:SETTLing:TOUT..... | 957 |
| SENSe<n1>:FUNCTION:SNSequence..... | 936 |
| SENSe<n1>:JITTER:REFERENCE..... | 896 |
| SENSe<n1>:LEFT<n2>..... | 996 |
| SENSe<n1>:LIMLower<n2>..... | 997 |
| SENSe<n1>:LIMLower<n2>:VALue..... | 997 |
| SENSe<n1>:LIMUpper<n2>..... | 997 |
| SENSe<n1>:LIMUpper<n2>:VALue..... | 997 |
| SENSe<n1>:MAX:FFT:SIZE..... | 894 |
| SENSe<n1>:NOTCh..... | 942 |
| SENSe<n1>:NOTCh:FREQuency..... | 943 |
| SENSe<n1>:NOTCh:FREQuency:MODE..... | 943 |
| SENSe<n1>:PHASe:SETTLing:COUNT..... | 956 |

| | |
|--|------|
| SENSe<n1>:PHASe:SETTling:MODE..... | 956 |
| SENSe<n1>:PHASe:SETTling:RESolution..... | 956 |
| SENSe<n1>:PHASe:SETTling:TOUT..... | 957 |
| SENSe<n1>:POWer:REFerence:RESistance..... | 894 |
| SENSe<n1>:REFerence<n2>..... | 999 |
| SENSe<n1>:REFerence<n2>:CHANnel..... | 894 |
| SENSe<n1>:REFerence<n2>:MODE<n3>..... | 1000 |
| SENSe<n1>:RIGHt<n2>..... | 1000 |
| SENSe<n1>:SWEep:CONTRol..... | 933 |
| SENSe<n1>:SWEep:POINts..... | 933 |
| SENSe<n1>:SWEep:SPACing..... | 933 |
| SENSe<n1>:SWEep:STARt..... | 934 |
| SENSe<n1>:SWEep:STEP..... | 934 |
| SENSe<n1>:SWEep:STOP..... | 934 |
| SENSe<n1>:THDN:REJection..... | 938 |
| SENSe<n1>:TRIGger:SETTling:COUNT..... | 956 |
| SENSe<n1>:TRIGger:SETTling:MODE..... | 956 |
| SENSe<n1>:TRIGger:SETTling:RESolution..... | 956 |
| SENSe<n1>:TRIGger:SETTling:TOLerance..... | 956 |
| SENSe<n1>:UFILter<n2>..... | 958 |
| SENSe<n1>:UFILter<n2>:ATTenuation..... | 959 |
| SENSe<n1>:UFILter<n2>:CENTer..... | 959 |
| SENSe<n1>:UFILter<n2>:DELay..... | 959 |
| SENSe<n1>:UFILter<n2>:FNAMe..... | 959 |
| SENSe<n1>:UFILter<n2>:ORDer..... | 959 |
| SENSe<n1>:UFILter<n2>:PASSb..... | 959 |
| SENSe<n1>:UFILter<n2>:PASSb:LOWer..... | 959 |
| SENSe<n1>:UFILter<n2>:PASSb:UPPer..... | 960 |
| SENSe<n1>:UFILter<n2>:STOPb..... | 960 |
| SENSe<n1>:UFILter<n2>:STOPb:LOWer..... | 960 |
| SENSe<n1>:UFILter<n2>:STOPb:UPPer..... | 960 |
| SENSe<n1>:UFILter<n2>:WIDTh..... | 960 |
| SENSe<n1>:UNAuto<n2>..... | 1000 |
| SENSe<n1>:UNIT<n2>..... | 1000 |
| SENSe<n1>:USERunit<n2>..... | 1001 |
| SENSe<n1>:VOLTagE:APERture..... | 931 |
| SENSe<n1>:VOLTagE:EQUalize..... | 937 |
| SENSe<n1>:VOLTagE:FUNDamental..... | 937 |
| SENSe<n1>:VOLTagE:FUNDamental:MODE..... | 938 |
| SENSe<n1>:VOLTagE:INTVtime..... | 934 |
| SENSe<n1>:VOLTagE:INTVtime:MODE..... | 934 |
| SENSe<n1>:VOLTagE:RANGe<n3>:MODE..... | 894 |
| SENSe3:FREQUency:APERture:MODE..... | 955 |
| SENSe3:FREQUency:LEFT..... | 994 |
| SENSe3:FREQUency:LIMLower..... | 994 |
| SENSe3:FREQUency:LIMLower:VALue..... | 994 |
| SENSe3:FREQUency:LIMUpper..... | 995 |
| SENSe3:FREQUency:LIMUpper:VALue..... | 995 |
| SENSe3:FREQUency:REFerence..... | 995 |
| SENSe3:FREQUency:REFerence:MODE..... | 995 |

| | |
|---------------------------------------|-----|
| SENSe3:FREQuency:RIGHT..... | 995 |
| SENSe3:FREQuency:UNAuto..... | 996 |
| SENSe3:FREQuency:UNIT..... | 996 |
| SENSe3:FREQuency:USERunit..... | 996 |
| SENSe3:GROupdelay:REFerence..... | 996 |
| SENSe3:PHASe:FORMat..... | 955 |
| SENSe3:PHASe:LEFT..... | 997 |
| SENSe3:PHASe:LIMLower..... | 997 |
| SENSe3:PHASe:LIMLower:VALue..... | 998 |
| SENSe3:PHASe:LIMUpper..... | 998 |
| SENSe3:PHASe:LIMUpper:VALue..... | 998 |
| SENSe3:PHASe:REFerence..... | 998 |
| SENSe3:PHASe:REFerence:MODE..... | 998 |
| SENSe3:PHASe:RIGHT..... | 999 |
| SENSe3:PHASe:UNAuto..... | 999 |
| SENSe3:PHASe:UNIT..... | 999 |
| SENSe3:PHASe:USERunit..... | 999 |
| SENSe7:CMPIFactor..... | 951 |
| SENSe7:MMODE..... | 951 |
| SENSe7:TRIGger:AUTO..... | 951 |
| SENSe7:TRIGger:LEVel..... | 951 |
| SENSe7:TRIGger:PRE..... | 951 |
| SENSe7:TRIGger:SLOPe..... | 951 |
| SENSe7:TRIGger:SOURce..... | 951 |
| SENSe7:TRIGger:TRCLength..... | 952 |
| SENSe8:PROTOcol:CH<n3>:BYTE<n4>?..... | 927 |
| SENSe8:PROTOcol:DISPlay..... | 954 |
| SENSe8:PROTOcol:ERRor:CRC<n4>?..... | 928 |
| SENSe8:PROTOcol:ERRor:INV<n4>?..... | 928 |
| SENSe8:PROTOcol:ERRor:LOC<n4>?..... | 928 |
| SENSe8:PROTOcol:ERRor:PAR<n4>?..... | 928 |
| SENSe8:PROTOcol:ERRor:PCM<n4>?..... | 928 |
| SENSe8:PROTOcol:ERRor?..... | 928 |
| SENSe8:PROTOcol:HIGHlight..... | 954 |
| SENSe8:PROTOcol:MODE..... | 954 |
| SENSe8:PROTOcol:PERSiStence..... | 954 |
| SENSe8:PROTOcol:VIEW..... | 954 |
| SOURce:AM:MODE..... | 884 |
| SOURce:BANDwidth..... | 879 |
| SOURce:DIM..... | 879 |
| SOURce:FILTer..... | 960 |
| SOURce:FILTer:CHANnels..... | 872 |
| SOURce:FRAMePhase..... | 860 |
| SOURce:FREQuency:AM..... | 884 |
| SOURce:FREQuency:CH2Stereo..... | 873 |
| SOURce:FREQuency:DIFFerence..... | 878 |
| SOURce:FREQuency:MEAN..... | 878 |
| SOURce:FREQuency:REFerence..... | 856 |
| SOURce:FREQuency:SELect..... | 873 |
| SOURce:FREQuency<n2>..... | 868 |

| | |
|--|------|
| SOURce:FUNCTION..... | 869 |
| SOURce:FUNCTION:MODE..... | 875 |
| SOURce:IMPairment..... | 860 |
| SOURce:INTerval..... | 877 |
| SOURce:LOOP:CHANnel..... | 883 |
| SOURce:LOOP:GAIN..... | 883 |
| SOURce:LOWDistortion..... | 869 |
| SOURce:MCHannel<n2>:FILTer..... | 961 |
| SOURce:MULTisine:COUNT..... | 875 |
| SOURce:ONTime..... | 877 |
| SOURce:ONTime:DELay..... | 877 |
| SOURce:PHASe<n2>..... | 873 |
| SOURce:PLAY:CHANnel..... | 881 |
| SOURce:PLAY:DELay<n3>..... | 881 |
| SOURce:PLAY:MODE..... | 881 |
| SOURce:PLAY:MUTing..... | 882 |
| SOURce:PLAY:REStart..... | 882 |
| SOURce:PLAY:SCALepktofs..... | 882 |
| SOURce:PLAY:TIME..... | 882 |
| SOURce:PROTocol:AZERo..... | 885 |
| SOURce:PROTocol:CH<n3>:BYTE<n4>..... | 885 |
| SOURce:PROTocol:CH<n3>:BYTE<n4>..... | 1001 |
| SOURce:PROTocol:CHANnels..... | 885 |
| SOURce:PROTocol:CRC..... | 885 |
| SOURce:PROTocol:FILE..... | 885 |
| SOURce:PROTocol:MODE..... | 886 |
| SOURce:PROTocol:NUMerical:BYTE..... | 886 |
| SOURce:PROTocol:NUMerical:CH..... | 886 |
| SOURce:PROTocol:NUMerical:VALue..... | 886 |
| SOURce:PROTocol:VALidity..... | 886 |
| SOURce:PTORef..... | 861 |
| SOURce:RANDom:DOMain..... | 880 |
| SOURce:RANDom:FREQuency:LOWer..... | 880 |
| SOURce:RANDom:FREQuency:UPPer..... | 880 |
| SOURce:RANDom:PDF..... | 869 |
| SOURce:RANDom:SHAPE..... | 880 |
| SOURce:RANDom:SPACing:FREQuency..... | 875 |
| SOURce:RANDom:SPACing:MODE..... | 875 |
| SOURce:REFerence..... | 861 |
| SOURce:SINusoid:DITHer..... | 869 |
| SOURce:SINusoid:DITHer:STATe..... | 870 |
| SOURce:SRCMode..... | 861 |
| SOURce:STEReo<n2>:FILTer..... | 961 |
| SOURce:SWEep:CONTRol..... | 888 |
| SOURce:SWEep:DWELI..... | 888 |
| SOURce:SWEep:FREQuency:HALT..... | 888 |
| SOURce:SWEep:FREQuency:HALT:VALue..... | 889 |
| SOURce:SWEep:FREQuency:POINts..... | 889 |
| SOURce:SWEep:FREQuency:SPACing..... | 889 |
| SOURce:SWEep:FREQuency:STARt..... | 889 |

| | |
|--|-----|
| SOURce:SWEEp:FREQuency:STEP..... | 890 |
| SOURce:SWEEp:FREQuency:STOP..... | 890 |
| SOURce:SWEEp:INTerval:HALT..... | 888 |
| SOURce:SWEEp:INTerval:HALT:VALue..... | 889 |
| SOURce:SWEEp:INTerval:POINts..... | 889 |
| SOURce:SWEEp:INTerval:SPACing..... | 889 |
| SOURce:SWEEp:INTerval:STARt..... | 889 |
| SOURce:SWEEp:INTerval:STEP..... | 890 |
| SOURce:SWEEp:INTerval:STOP..... | 890 |
| SOURce:SWEEp:NEXtstep..... | 888 |
| SOURce:SWEEp:ONTime:HALT..... | 889 |
| SOURce:SWEEp:ONTime:HALT:VALue..... | 889 |
| SOURce:SWEEp:ONTime:POINts..... | 889 |
| SOURce:SWEEp:ONTime:SPACing..... | 889 |
| SOURce:SWEEp:ONTime:STARt..... | 889 |
| SOURce:SWEEp:ONTime:STEP..... | 890 |
| SOURce:SWEEp:ONTime:STOP..... | 890 |
| SOURce:SWEEp:PHASe:HALT..... | 889 |
| SOURce:SWEEp:PHASe:HALT:VALue..... | 889 |
| SOURce:SWEEp:PHASe:POINts..... | 889 |
| SOURce:SWEEp:PHASe:SPACing..... | 889 |
| SOURce:SWEEp:PHASe:STARt..... | 889 |
| SOURce:SWEEp:PHASe:STEP..... | 890 |
| SOURce:SWEEp:PHASe:STOP..... | 890 |
| SOURce:SWEEp:VOLTag:e:HALT..... | 889 |
| SOURce:SWEEp:VOLTag:e:HALT:VALue..... | 889 |
| SOURce:SWEEp:VOLTag:e:POINts..... | 889 |
| SOURce:SWEEp:VOLTag:e:SPACing..... | 889 |
| SOURce:SWEEp:VOLTag:e:STARt..... | 889 |
| SOURce:SWEEp:VOLTag:e:STEP..... | 890 |
| SOURce:SWEEp:VOLTag:e:STOP..... | 890 |
| SOURce:SWEEp:XAXis..... | 890 |
| SOURce:SWEEp:ZAXis..... | 890 |
| SOURce:SYNC:TO..... | 861 |
| SOURce:VOLTag:e:AM..... | 884 |
| SOURce:VOLTag:e:CH2Stereo..... | 873 |
| SOURce:VOLTag:e:CREStfactor:MODE..... | 875 |
| SOURce:VOLTag:e:EQUalize..... | 870 |
| SOURce:VOLTag:e:EQUalize:CHANnels..... | 873 |
| SOURce:VOLTag:e:LOWLevel..... | 877 |
| SOURce:VOLTag:e:MAXimum..... | 858 |
| SOURce:VOLTag:e:OFFSet<n3>..... | 871 |
| SOURce:VOLTag:e:OFFSet<n3>:CHANnels..... | 874 |
| SOURce:VOLTag:e:OFFSet<n3>:STATe..... | 871 |
| SOURce:VOLTag:e:RANGe..... | 858 |
| SOURce:VOLTag:e:RATio..... | 874 |
| SOURce:VOLTag:e:REFerence..... | 856 |
| SOURce:VOLTag:e:RMS..... | 876 |
| SOURce:VOLTag:e:SElect..... | 874 |
| SOURce:VOLTag:e:STEReo<n3>:EQUalize..... | 874 |

| | |
|---|------|
| SOURce:VOLTage:TOTal..... | 876 |
| SOURce:VOLTage:TOTal:GAIN..... | 876 |
| SOURce:VOLTage<n2>..... | 870 |
| STATus:OPERation:CONDition?..... | 1026 |
| STATus:OPERation:ENABLE..... | 1026 |
| STATus:OPERation:EVENT?..... | 1027 |
| STATus:OPERation:NTRansition..... | 1027 |
| STATus:OPERation:PTRansition..... | 1027 |
| STATus:PRESet..... | 1026 |
| STATus:QUEStionable:CONDition?..... | 1027 |
| STATus:QUEStionable:ENABLE..... | 1028 |
| STATus:QUEStionable:EVENT?..... | 1028 |
| STATus:QUEStionable:MEASuring:CONDition?..... | 1031 |
| STATus:QUEStionable:MEASuring:ENABLE..... | 1031 |
| STATus:QUEStionable:MEASuring:EVENT?..... | 1032 |
| STATus:QUEStionable:MEASuring:NTRansition..... | 1032 |
| STATus:QUEStionable:MEASuring:PTRansition..... | 1032 |
| STATus:QUEStionable:NTRansition..... | 1028 |
| STATus:QUEStionable:OVERrange:CONDition?..... | 1030 |
| STATus:QUEStionable:OVERrange:ENABLE..... | 1030 |
| STATus:QUEStionable:OVERrange:EVENT?..... | 1030 |
| STATus:QUEStionable:OVERrange:NTRansition..... | 1031 |
| STATus:QUEStionable:OVERrange:PTRansition..... | 1031 |
| STATus:QUEStionable:PTRansition..... | 1028 |
| STATus:QUEStionable:UNDerrange:CONDition?..... | 1029 |
| STATus:QUEStionable:UNDerrange:ENABLE..... | 1029 |
| STATus:QUEStionable:UNDerrange:EVENT?..... | 1029 |
| STATus:QUEStionable:UNDerrange:NTRansition..... | 1029 |
| STATus:QUEStionable:UNDerrange:PTRansition..... | 1030 |
| STATus:QUEue:NEXT?..... | 1034 |
| STATus:XQUEStionabl:CONDition?..... | 1032 |
| STATus:XQUEStionabl:ENABLE..... | 1033 |
| STATus:XQUEStionabl:EVENT?..... | 1033 |
| STATus:XQUEStionabl:NTRansition..... | 1033 |
| STATus:XQUEStionabl:PTRansition..... | 1033 |
| SWITcher:COMPort..... | 965 |
| SWITcher:CONNection..... | 965 |
| SWITcher:INPA..... | 965 |
| SWITcher:INPB..... | 965 |
| SWITcher:OFFSet:BVSA..... | 965 |
| SWITcher:OFFSet:OVSI..... | 965 |
| SWITcher:OUTA..... | 966 |
| SWITcher:OUTB..... | 966 |
| SWITcher:STATe..... | 966 |
| SWITcher:TRACking..... | 966 |
| SYSTem:CHNString..... | 1034 |
| SYSTem:COMMunicate:GPIB:ADDResS..... | 1035 |
| SYSTem:COMMunicate:GTL..... | 1035 |
| SYSTem:DISPlay:EXPLAnation<n3>:SHOW..... | 1035 |
| SYSTem:DISPlay:EXPLAnation<n3>:TEXT..... | 1035 |

| | |
|--|------|
| SYSTem:DISPlay:SCPiupdate..... | 1035 |
| SYSTem:ERRor?..... | 1035 |
| SYSTem:HELP:LANGUage..... | 1036 |
| SYSTem:MAXChdisp..... | 1036 |
| SYSTem:MEMory:DATA<n3>..... | 1016 |
| SYSTem:MEMory:FREE..... | 1018 |
| SYSTem:MEMory:STRing<n3>..... | 1018 |
| SYSTem:PRESet..... | 1036 |
| SYSTem:PROFile:CLIPboard..... | 1036 |
| SYSTem:PROFile:FILE..... | 1036 |
| SYSTem:PROFile:PRINter..... | 1036 |
| SYSTem:PROFile:SCReen..... | 1036 |
| SYSTem:PROGramm:EXECute..... | 1036 |
| SYSTem:QLONG..... | 1037 |
| SYSTem:SHTDown..... | 1037 |
| SYSTem:SHUtdown..... | 1037 |
| SYSTem:SINFo..... | 1037 |
| SYSTem:SINFo:MAC..... | 1038 |
| SYSTem:VERsion?..... | 1038 |
| SYSTem:WInStyle..... | 1038 |
| TRACe:BARGraph<n2>:LDList:AX?..... | 923 |
| TRACe:BARGraph<n2>:LDList:AY?..... | 923 |
| TRACe:BARGraph<n2>:LDList:BX?..... | 923 |
| TRACe:BARGraph<n2>:LDList:BY?..... | 923 |
| TRACe:BARGraph<n2>:LDList:COUnT:AX?..... | 924 |
| TRACe:BARGraph<n2>:LDList:COUnT:AY?..... | 924 |
| TRACe:BARGraph<n2>:LDList:COUnT:BX?..... | 924 |
| TRACe:BARGraph<n2>:LDList:COUnT:BY?..... | 924 |
| TRACe:BARGraph<n2>:LOAD:AX?..... | 920 |
| TRACe:BARGraph<n2>:LOAD:AY?..... | 920 |
| TRACe:BARGraph<n2>:LOAD:BX?..... | 920 |
| TRACe:BARGraph<n2>:LOAD:BY?..... | 920 |
| TRACe:BARGraph<n2>:LOAD:COUnT:AX?..... | 920 |
| TRACe:BARGraph<n2>:LOAD:COUnT:AY?..... | 920 |
| TRACe:BARGraph<n2>:LOAD:COUnT:BX?..... | 920 |
| TRACe:BARGraph<n2>:LOAD:COUnT:BY?..... | 920 |
| TRACe:BARGraph<n2>:STORe:AY..... | 1015 |
| TRACe:BARGraph<n2>:STORe:BY..... | 1015 |
| TRACe:FFT<n2>:LDList:AX?..... | 922 |
| TRACe:FFT<n2>:LDList:AY?..... | 922 |
| TRACe:FFT<n2>:LDList:BX?..... | 922 |
| TRACe:FFT<n2>:LDList:BY?..... | 922 |
| TRACe:FFT<n2>:LDList:COUnT:AX?..... | 922 |
| TRACe:FFT<n2>:LDList:COUnT:AY?..... | 922 |
| TRACe:FFT<n2>:LDList:COUnT:BX?..... | 922 |
| TRACe:FFT<n2>:LDList:COUnT:BY?..... | 922 |
| TRACe:FFT<n2>:LOAD:AX?..... | 919 |
| TRACe:FFT<n2>:LOAD:AY?..... | 919 |
| TRACe:FFT<n2>:LOAD:BX?..... | 919 |
| TRACe:FFT<n2>:LOAD:BY?..... | 919 |

| | |
|--|------|
| TRACe:FFT<n2>:LOAD:COUNT:AX?..... | 919 |
| TRACe:FFT<n2>:LOAD:COUNT:AY?..... | 919 |
| TRACe:FFT<n2>:LOAD:COUNT:BX?..... | 919 |
| TRACe:FFT<n2>:LOAD:COUNT:BY?..... | 919 |
| TRACe:FFT<n2>:STORe:AY..... | 1015 |
| TRACe:FFT<n2>:STORe:BY..... | 1015 |
| TRACe:PESQ<n2>:LDList:AX?..... | 923 |
| TRACe:PESQ<n2>:LDList:AY?..... | 923 |
| TRACe:PESQ<n2>:LDList:BX?..... | 923 |
| TRACe:PESQ<n2>:LDList:BY?..... | 923 |
| TRACe:PESQ<n2>:LDList:COUNT:AX?..... | 923 |
| TRACe:PESQ<n2>:LDList:COUNT:AY?..... | 923 |
| TRACe:PESQ<n2>:LDList:COUNT:BX?..... | 923 |
| TRACe:PESQ<n2>:LDList:COUNT:BY?..... | 923 |
| TRACe:PESQ<n2>:LOAD:AX?..... | 920 |
| TRACe:PESQ<n2>:LOAD:AY?..... | 920 |
| TRACe:PESQ<n2>:LOAD:BX?..... | 920 |
| TRACe:PESQ<n2>:LOAD:BY?..... | 920 |
| TRACe:PESQ<n2>:LOAD:COUNT:AX?..... | 920 |
| TRACe:PESQ<n2>:LOAD:COUNT:AY?..... | 921 |
| TRACe:PESQ<n2>:LOAD:COUNT:BX?..... | 921 |
| TRACe:PESQ<n2>:LOAD:COUNT:BY?..... | 921 |
| TRACe:PESQ<n2>:STORe:AY..... | 1016 |
| TRACe:PESQ<n2>:STORe:BY..... | 1016 |
| TRACe:SWEep<n2>:LDList:AX?..... | 921 |
| TRACe:SWEep<n2>:LDList:AY?..... | 921 |
| TRACe:SWEep<n2>:LDList:BX?..... | 921 |
| TRACe:SWEep<n2>:LDList:BY?..... | 921 |
| TRACe:SWEep<n2>:LDList:COUNT:AX?..... | 921 |
| TRACe:SWEep<n2>:LDList:COUNT:AY?..... | 921 |
| TRACe:SWEep<n2>:LDList:COUNT:BX?..... | 921 |
| TRACe:SWEep<n2>:LDList:COUNT:BY?..... | 921 |
| TRACe:SWEep<n2>:LOAD:AX?..... | 918 |
| TRACe:SWEep<n2>:LOAD:AY?..... | 918 |
| TRACe:SWEep<n2>:LOAD:BX?..... | 918 |
| TRACe:SWEep<n2>:LOAD:BY?..... | 918 |
| TRACe:SWEep<n2>:LOAD:COUNT:AX?..... | 918 |
| TRACe:SWEep<n2>:LOAD:COUNT:AY?..... | 918 |
| TRACe:SWEep<n2>:LOAD:COUNT:BX?..... | 918 |
| TRACe:SWEep<n2>:LOAD:COUNT:BY?..... | 918 |
| TRACe:SWEep<n2>:STORe:AX..... | 1015 |
| TRACe:SWEep<n2>:STORe:AY..... | 1015 |
| TRACe:SWEep<n2>:STORe:BX..... | 1015 |
| TRACe:SWEep<n2>:STORe:BY..... | 1015 |
| TRACe:WAVeform<n2>:LDList:AX?..... | 922 |
| TRACe:WAVeform<n2>:LDList:AY?..... | 922 |
| TRACe:WAVeform<n2>:LDList:BX?..... | 922 |
| TRACe:WAVeform<n2>:LDList:BY?..... | 922 |
| TRACe:WAVeform<n2>:LDList:COUNT:AX?..... | 922 |
| TRACe:WAVeform<n2>:LDList:COUNT:AY?..... | 922 |

| | |
|-------------------------------------|------|
| TRACe:WAVeform<n2>:LDList:COUNT:BX? | 922 |
| TRACe:WAVeform<n2>:LDList:COUNT:BY? | 922 |
| TRACe:WAVeform<n2>:LOAD:AX? | 919 |
| TRACe:WAVeform<n2>:LOAD:AY? | 919 |
| TRACe:WAVeform<n2>:LOAD:BX? | 919 |
| TRACe:WAVeform<n2>:LOAD:BY? | 919 |
| TRACe:WAVeform<n2>:LOAD:COUNT:AX? | 919 |
| TRACe:WAVeform<n2>:LOAD:COUNT:AY? | 919 |
| TRACe:WAVeform<n2>:LOAD:COUNT:BX? | 920 |
| TRACe:WAVeform<n2>:LOAD:COUNT:BY? | 920 |
| TRACe:WAVeform<n2>:STORe:AY | 1016 |
| TRACe:WAVeform<n2>:STORe:BY | 1016 |
| TRIGger:CHANnel | 909 |
| TRIGger:COUNT | 909 |
| TRIGger:DELAy | 909 |
| TRIGger:FREQuency:VARiatiOn | 910 |
| TRIGger:PLAYbefmeas | 892 |
| TRIGger:SOURce | 910 |
| TRIGger:TIMer | 910 |
| TRIGger:VOLTagE:VARiatiOn | 910 |

Index

Symbols

| | |
|--|---|
| -2π..0 | 610 |
| -180° to 180° | 610 |
| -360° to 0° | 610 |
| -π.. +π | 610 |
| *.npz | 635 |
| *.xpz | 635 |
| *.zpz | 635 |
| *CLS | 852 |
| *ESE | 852 |
| *ESR | 852 |
| *GTL | 852 |
| *IDN | 852 |
| *IST | 853 |
| *OPC | 853 |
| *OPT | 853 |
| *PRE | 853 |
| *PSC | 854 |
| *RST | 854 |
| *SRE | 854 |
| *STB | 854 |
| *TRG | 854 |
| *WAI | 855 |
| >L | 804 |
| >R | 804 |
| &LLO | 804 |
| 0 dB | 533 |
| 0° to 360° | 610 |
| 0n to 2π | 610 |
| 1 kHz max | 508 |
| 1/3 Octave | 521 |
| 1/6 Octave | 521 |
| 1/12 Octave | 521 |
| 1/24 Octave | 521 |
| 12 dB Auto | 533 |
| 19" rack | 43 |
| 30 dB Auto | 533 |
| 60 Hz max | 508 |
| 240 Hz max | 508 |
| A | |
| A-axis | 712 |
| Abs Peak | 486, 490 |
| AC coupling | 464, 491, 532 |
| AC supply | 44 |
| AC supply fuse | 45 |
| According to | 548 |
| Acoustic coupling | 544, 562 |
| Activate monitor | 65 |
| Activate panel | 154 |
| Additional cursor values | 666 |
| Additional measurement functions | 671 |
| Addressed commands | 1043 |
| Admissibility of commands (IEC/IEEE) | 823 |
| Alignment | 429 |
| Alive / Hold | 689 |
| All di | 500 |
| All even di | 500 |
| All odd di | 500 |
| Amp Var | 338 |
| Amplitude | 551, 558, 566 |
| Amplitude variation | |
| Multisine | 296 |
| Play | 323 |
| Random | 315 |
| Amplitude Variation | 338, 884 |
| Analog 8-channel generator | 237 |
| Analog analyzer | 364 |
| Analog Auxiliaries Out | 649 |
| Analog generator | 237 |
| Analysis | |
| with cursors | 193 |
| with markers | 193 |
| Analysis in the Time Domain | 950 |
| Analyzer amplitude | 551, 558, 566 |
| Analyzer filter .. 466, 491, 509, 522, 551, 559, 568, 573, 596 | |
| Analyzer Function Filters | 627 |
| Analyzer ground | 371 |
| Analyzer Prefilter | 627 |
| Analyzer status | 236 |
| Analyzer sweep system | 475 |
| Analyzer, select | 891 |
| Anlr Sync | 353 |
| Append/Replace | 709 |
| Arbitrary | 316, 880 |
| Artificial ear | 544, 562 |
| Artificial mouth | 544, 562 |
| Asterisk | 820 |
| ATN | 1041 |
| Attention | 1041 |
| Attenuation | 567 |
| Filter | 636 |
| Audio bits | 264, 394, 431 |
| USI 8 Channel Analyzer | 419 |
| USI Dual Channel Analyzer | 405 |
| Audio Monitor | 211 |
| Audio Monitoring | 961 |
| Audio monitoring channel | 648 |
| Audio monitoring tap | 647 |
| Audio Protocol Generator | 884 |
| Audio quality measurements | 552, 555 |
| Audio signal measurement | 552 |
| Audio switcher | 653 |
| Auto | 389, 446, 468, 471, 482, 492, 502, 509, 521 |
| Auto Each | 478 |
| Auto Fast | 468, 471, 482, 492 |
| Auto List | 348, 475 |
| Auto Scale | 699, 756 |
| Auto Sweep | 348, 352, 475 |
| Autom. Gain | 565 |
| Automatic | 602 |
| Automatic Sweep | 352 |
| automatic sweeps | 888 |
| Autorange | 372, 380, 381 |
| Autotrigger | 583 |
| Auxiliaries panel | 211 |
| Auxiliaries Panel | 650, 652 |
| Auxiliary analog output | 213 |
| Average | 616, 619, 621 |
| Average count | 537 |
| Average mode | 536 |
| Averaging | 536, 537 |
| Avg Count | 537 |
| Avg Delay | 551, 558, 567 |

- Avg Mode 536
- B**
- B vs A 657
- Backup 84, 89
- Bandpass Filters 631
- Bandpass sweep 475
- Bandstop Filters 631
- Bandstop sweep 475
- Bandwidth 367, 932
- DIM 308
- Bar Graph 186, 498, 524, 664, 666, 671
- Bargraph 746, 966
- Basic unit 774
- BClk Freq 264, 395
- USI 8 Channel Analyzer 421
- USI Dual Channel Analyzer 407
- BClk Slope
- USI 8 Channel Analyzer 422
- USI Dual Channel Analyzer 408
- Between Channels 603
- Binary 604
- Binary+Text 604
- Bins 526
- BIOS version 46
- Bit clock frequency 264
- Bits per Sample 593
- Blackman Harris window 528
- Boolean parameters 850
- Bootling 46
- Bottom 700
- Bottom limit for y-axis 700
- BP 1 % 473
- BP 1/3 Oct 473
- BP 1/3 Oct Fast 473
- BP 1/12 Oct 473
- BP 3 % 473
- BP Fix 473
- Brief introduction, operation 96
- BS 1 % 473
- BS 1/3 Oct 473
- BS 1/3 Oct Fast 473
- BS 1/12 Oct 473
- BS 3 % 473
- BS Fix 473
- Burst on Delay 339
- Sine Burst 299
- Sine² Burst 302
- Burst-duration sweep 350, 351
- Burst-duration sweep list 359
- Burst-interval sweep 350, 351
- Burst-interval sweep list 359
- Button Sequence 203, 206
- C**
- Carrier Freq
- Modulation 332
- Carrier Volt
- Modulation 333
- Case-sensitivity
- SCPI 848
- Center Freq
- Filter 633
- Ch1 MeasSour
- USI Dual Channel Analyzer 402
- Chan Status 389
- Change language option 793
- Changes 603
- Changing unit 167
- Channel 393, 687
- Play 319
- Play+Anlr 326
- Channel 1 580, 594
- Channel 2 580, 594
- Channel Descr. 664, 744
- Channel Mode 429
- Chirp 336
- Chirp Mode 571
- Chirp Points 571
- Chirp Resolution 571
- Chirp-based measurement 569
- Chx MeasSour
- USI 8 Channel Analyzer 417
- Clipboard 671
- Clipping level 167
- Clock
- USI 8 Channel Analyzer 416
- USI Dual Channel Analyzer 401
- Clock Freq 430
- Clock frequency 240
- Clock Source 428
- Close All button 150
- Close panel 154
- Coding
- USI 8 Channel Analyzer 423
- USI Dual Channel Analyzer 410
- Collecting measured values 689
- Colon 820
- COM Interface
- Used for 659
- COM Port 654
- Combi Display 993
- Combo display 176, 745
- Combo fields setting 178
- Comma 820
- Command
- Asterisk 820
- Colon 820
- Comma 820
- Compatibility 823
- Crosshatch 820
- Header 814
- Identification 822
- Long form 814
- Parameter 819
- Query 818
- Question mark 818
- Quotation marks 820
- Semicolon 820
- Short form 814
- Structure 814
- Suffix 814
- Syntax elements 820
- White space 820
- Command (IEC/IEEE)
- Admissibility 823
- Command Description 847
- Command sequence (IEC/IEEE) 823
- Common 371
- Comp Factor 540, 579
- Complete setup 798
- Compressed 578

- Compression factor 540
 - Compression factors 579
 - Computer keyboard 146
 - Computer name 80
 - CONDition 829
 - Config 671, 747
 - Configuring the USI Dual Channel Generator 237
 - Connection:
 - IEC/IEEE bus 1040
 - LAN 1043
 - Monitor 1052
 - Printer 1050
 - RS-232-C Interface (COM) 1046
 - USB 1049
 - USB device 1050
 - Constant signal 558
 - Consumer 602
 - Cont 236
 - Continuous measurement 440
 - Continuous sweep 458
 - Control bus 1041
 - Conversion formulas 223
 - Conversion formulas for analog level measurement results 223
 - Converting units 223
 - Copy 671, 747, 1023
 - Copy to Ch2 751
 - Copy to other Windows 674
 - Copying of files 1023
 - Create new directory 1024
 - Create New Directory 1024
 - Crest factor
 - Multisine 295
 - Crest Factor 875
 - Critical Bands 521
 - Crossed 329
 - Crosshatch 820
 - Current setup 798
 - Cursor intersection points 665, 670
 - Cursor markers 736
 - Cursor X-value 667
 - Cursor Y value 666
- D**
- d2 (IEC 118) 514
 - d2 (IEC 268) 514
 - d3 (IEC 118) 514
 - d3 (IEC 268) 514
 - Data buffers 1016
 - Data List 674, 735
 - Data loss 47
 - Data Valid 1041
 - Data Window 674
 - DAV 1041
 - DC 613
 - DC (Direct Current Voltage) 883
 - DC (Direct-Current Voltage) 333
 - DC Adjusting 236
 - DC coupling 464, 491, 532
 - DC measurement function 488
 - DC Offset
 - Arbitrary 317
 - Chirp 338
 - DFD 307
 - Mod Dist 304
 - Multisine 297
 - Play 324
 - Play+Anlr 330
 - Random 315
 - Sine 289
 - Sine Burst 300
 - Square 335
 - DC Offset Mode
 - Stereo Sine 294
 - DC Offset State
 - Stereo Sine 294
 - DC Suppress 464, 491, 532
 - DC suppression 532
 - DC Suppression 464, 491
 - DC voltage 488, 650
 - DC Voltage Measurement 935
 - DCL 822
 - Deactivation of Outputs 890
 - Default setting:Status-Reporting-System 845
 - Define Footer 661
 - Define Header 661
 - Deg Level 551, 558, 566
 - Deg Sp. Ratio 568
 - Delay 396, 434
 - Filter 636
 - Short Name 637
 - Start Cond. 451
 - USI 8 Channel Analyzer 426
 - USI Dual Channel Analyzer 411
 - Delay Ch1 532
 - Delay Chx
 - Play 320
 - Play+Anlr 326
 - Delay compensation 532
 - Delay Detect 558
 - Delay measurement 954
 - Delay Measurement 584
 - Delay versus time 545
 - Delayed triggering 374, 384, 396, 411, 426, 434, 451
 - Delete 1024
 - Deletion of files 1024
 - Destination 660
 - Deviation
 - Modulation 332
 - Device indicator 75
 - DFD 305, 513, 878, 939
 - DHCP networks 68
 - DI value 553, 556
 - Diff Freq
 - DFD 306
 - Dig Bitstream Analyzer 903
 - Dig Inp Amp 612
 - Digital Analyzer 895
 - Digital Audio Generator 237
 - Digital Audio Protocol Generator 884
 - Digital filter 466, 491, 509, 522, 551, 559, 568, 573, 596
 - Digital filters 957
 - Digital Generator 858
 - Digital Impairment Generator 237
 - DIM 307, 516, 879
 - DIM (dynamic intermodulation distortion analysis) 939
 - Directories in the network 72
 - DispConfig button 205
 - Display 147, 673, 751
 - Display configuration panels 671, 673
 - Display filter 737
 - Display Mode 602
 - Display window 154

- Displays button 203, 206
- Distortion 500
- Distortion measurement 504
- Distortion Measurements 494, 936
- Distortion voltage 500
- Dither
- DFD 305
 - Mod Dist 303
 - Sine 288
 - Stereo Sine 290
- Division 701, 719, 758
- Y-axis 701, 702
- Domain
- Random 309
 - Square 334
- Downward sweep 356, 358, 477
- Dropouts versus time 545
- DUT 549, 557, 564
- Duty Cycle 430
- Dwell File 353
- dwell sweep 352
- Dwell time 353
- Dwell Value 353
- Dwell-time list 353
- Dwnsmpl Fact 431
- dynamic intermodulation distortion analysis 516
- Dynamic Mode 496
- Dynamic range 496
- E**
- Edge Trig 446
- Edge Trig Ch1 446
- Edge Trig Ch2 446
- Edit button 204
- Editing trace files 788
- Electrical discharges 42
- EMC protective measures 42
- EN61010-1 44
- ENABLE 829
- Engineering 698, 715, 738, 752
- Entering the IP Address 69
- EOI 1041
- Equalization 339
- Invert. frequency response 723
 - Multistage preemphasis 723
 - Norm frequency 722
 - Offset 724
 - Offset value 724
- Equalizer 497, 523, 534
- DFD 307
 - Multisine 297
 - Random 315
 - Sine 289
 - Sine Burst 300
 - Stereo Sine 293
- Equalizer / Equalizer Ch1
- Stereo Sine 293
- Equalizer Ch2
- Stereo Sine 293
- Error queue query 1035
- Error Queue Query 845
- ESE (event status enable) 833
- ESR (event status register) 833
- Ethernet 67
- Ethernet Interface (LAN) 1043
- Even Harmonics 502
- Even Harmonics, Odd Harmonics 572
- EVENT 829
- Example
- Measuring frequency response 114
 - Measuring total harmonic distortion 126
- Example setups 134
- Excel 793
- Exponential 536, 616, 619, 621, 623
- Exponential averaging 536, 537
- Export 793
- External frequency sweep 446
- External keyboard 51
- External level sweep 446
- External software 49
- External sweep 444, 453
- External Sweep 453
- External sweeps 910
- Externally controlled measured value recording 444
- F**
- Factor 480, 484
- Factory default setting 91
- Factory Default setting 87
- Falling 582, 595
- Fast 609
- Fast Fourier Transformation 526
- Fast measurement 496
- FFT
- Phase 681
 - Phase difference 681
- FFT analysis 526
- FFT Analysis 940
- FFT as measurement function 526, 530
- FFT bandwidth 540, 541
- FFT Graph 184, 671
- FFT size 525, 527
- FFT Size 525, 526, 527
- FFT size limit 374, 384, 392, 396, 411, 426, 434
- FFT span 540, 541
- FFT start 540
- FFT stop 541
- File
- Arbitrary 316
 - Play+Anlr 325
- File button 203
- File Def Filter 634
- File Extensions 220
- File Length 594
- File Management 217
- File Name 478, 550, 557, 565
- File Select window 218
- File Selector Win Style 663
- Filter 466, 491, 509, 522, 534, 551, 559, 568, 573, 596, 626, 643
- A Weighting 637, 643
 - Analyzer Function 627
 - Analyzer Prefilter 627
 - Arbitrary 317
 - Attenuation 636
 - Bandpass 631
 - Bandstop Filters 631
 - C Message 637, 643
 - C Weighting 637, 643
 - CCIR 1k wtd 637, 643
 - CCIR 2k wtd 637, 643
 - CCIR unwdt 637, 643

- CCITT 637, 643
- Center Freq 633
- Chirp 338
- DC Noise HP 637, 643
- Deemph 50 637, 643
- Deemph 50/15 637, 643
- Deemph 75 637, 643
- Deemph J.17 637, 643
- definable 628
- Delay 636
- DFD 306
- digital 958
- file-defined 634
- Generator 627
- Highpass 630
- IEC Tuner 637, 643
- Jitter wtd 637, 643
- Lowpass 630
- Mod Dist 304
- Modulation 333
- Multisine 296
- Notch 632
- Octave 632
- Order 630
- Passb Low 632
- Passb Upp 632
- Passband 631
- Play 323
- Play+Anlr 330
- Preemph 50 637, 643
- Preemph 50/15 637, 643
- Preemph 75 637, 643
- Random 315
- Rumble unwtd 637, 643
- Rumble wtd 637, 643
- Settling time 637
- Sine 289
- Sine Burst 299
- Sine² Burst 302
- Stereo Sine 292
- Stopb Low 632, 634
- Stopb Upp 632, 634
- Stopband 631
- Third-octave 632
- Transfer function – Coefficients 635
- Transfer function – Poles 635
- Transfer function – Zeros 635
- Weighting Filters 637
- Width 634
- Filter / Filter Ch1
 - Play 323
 - Stereo Sine 293
- Filter Ch2
 - Play 323
 - Stereo Sine 293
- Filter characteristic 473
- Filter Table 628
- Filters 957
- Filters 01 to 09 629
- Find Cursor 737
- Firewall 67
- Firmware Update 83
- Firmware version 852
- First Bit 265
 - USI 8 Channel Analyzer 418
 - USI Dual Channel Analyzer 404
- Fix 478, 483
 - Fix 3 s 487, 492
 - Fix 50 ms 486, 492
 - Fix 200 ms 486, 492
 - Fix 1000 ms 486, 492
 - Fix All Sizes button 150
 - Fix Size Auto Size button 150
 - Fixed range 372, 380, 381
 - Flat 616, 619, 621, 623
 - Flat Top window 528
 - Fnct Settling 616
 - Forever 603
 - Format 264, 395
 - Format Phase 610
 - Free Text 720
 - Freezing graphic 689
 - Freq 446
 - Freq & Grp Del 606
 - Freq & Phase 606
 - Freq & Sample Freq 606
 - Freq Ch1 446, 478
 - Stereo Sine 292
 - Freq Ch2 446, 478
 - Stereo Sine 292
 - Freq Fast 446
 - Freq Fast Ch1 446
 - Freq Fast Ch2 446
 - Freq File 358
 - Freq Lim Low 536
 - Freq Lim Upp 536
 - Freq Limit 535
 - Freq Mode 478, 483, 873
 - Stereo Sine 290
 - Freq No i
 - Multisine 295
 - Freq Phase 606
 - Freq RefCh 478
 - Freq Settling 619
 - Frequency 350, 351, 606
 - Polarity 331
 - Sine 289
 - Sine Burst 298
 - Sine² Burst 301
 - Square 335
 - Stereo Sine 291
 - Frequency Band Analysis 519, 939
 - Frequency delay measurement 954
 - Frequency measurement 606
 - Settling 619
 - Frequency range 526
 - Frequency resolution 541
 - Frequency response 167
 - Frequency sweep 350, 351
 - Frequency sweep list 358, 478
 - From Output 603
 - Frq Lim Low 484, 510, 523, 573
 - Frq Lim Upp 485, 511, 524, 573
 - Fsync Freq
 - USI 8 Channel Analyzer 421
 - USI Dual Channel Analyzer 407
 - Fsync Offset
 - USI 8 Channel Analyzer 422
 - USI Dual Channel Analyzer 408
 - Fsync Polarity 265
 - FSYNC polarity 265
 - Fsync Shape 265
 - FSYNC signal form 265

| | |
|---|--|
| Fsync Slope | 395 |
| USI 8 Channel Analyzer | 422 |
| USI Dual Channel Analyzer | 408 |
| Fsync Width | 900 |
| USI 8 Channel Analyzer | 421 |
| USI Dual Channel Analyzer | 407 |
| Full Screen button | 150 |
| Function | 518, 520, 531, 547, 556, 563, 592 |
| Function FFT | 526, 530 |
| Function level | 140 |
| Functional testing | 48 |
| Fundamental | 502, 509 |
| Fundamental rejection | 507 |
| G | |
| Gain | 566 |
| Gen Burst | 580 |
| Gen Off | 236 |
| Gen Overload | 236 |
| Gen Running | 236 |
| Gen Track | 465, 468, 471, 478, 482, 483, 492, 502, 509, 533 |
| General Configuration | |
| File Selector Win Style | 663 |
| Help Language | 663 |
| Menu bar always visible | 662 |
| SCPI Logging/Query Longform | 663 |
| Tool bar always visible | 662 |
| Generation of protocol data | 1001 |
| Generator (low-distortion) | 138 |
| Generator Filters | 627 |
| Generator Function | 287 |
| Generator ground | 240 |
| Generator level control | 241 |
| Generator output | 239 |
| Generator Signals | 287 |
| Generator status | 236 |
| Generator sweep system | 348 |
| Generator sweeps | 346 |
| GET (Group Execute Trigger) | 822 |
| Getting started | 94 |
| GPIO address | 659 |
| Graph Size | 660 |
| Graphic Freezing | 689 |
| Graphic system | |
| FFT Graph | 681 |
| Histogram | 685 |
| Sweep graph | 677 |
| Waveform | 684 |
| Graphical window | 182, 670, 673 |
| Group delay measurement | 954 |
| H | |
| Halt | 359 |
| Halt value | 360 |
| Halt value input | 360 |
| Hamming window | 528 |
| Hann window | 528 |
| Hardware Info (remote control) | 853 |
| Harmonic markers | 669 |
| Header | 814 |
| Header/footer | 661 |
| Help button | 203, 209 |
| Help Language | 663 |
| Help System | 214 |
| Help Text Language | 215 |
| Help Texts | |
| Language | 215 |
| Hide panel | 154 |
| Highlight | 603, 954 |
| Highpass filter | 630 |
| History | 675 |
| Horiz Size button | 150 |
| Hum loops, avoiding | 95 |
| I | |
| I2S Analyzer | 897 |
| I2S format | 264 |
| I2S Generator | 237 |
| I2S interface assignment | 268, 398 |
| I2S timing diagrams | 266, 397 |
| I2S-Generator | 861 |
| IEC/IEEE bus | |
| Interface functions | 1042 |
| IEC/IEEE bus address | 1035 |
| IEC/IEEE bus commands | |
| Preset | 823 |
| IEC/IEEE-Bus Interface (IEC 625 / IEEE 488) | 1040 |
| IFC | 1041 |
| Import from | 710 |
| Import scan | 710 |
| Infinite | 610 |
| Infrasound | 537, 598 |
| Infrasound Analysis | 598 |
| Infrasound Signals | 598 |
| INIT command (IEC) | 825 |
| Initialize:Status-Reporting-System | 845 |
| Input | 395 |
| USI 8 Channel Analyzer | 421 |
| USI Dual Channel Analyzer | 407 |
| INPut | |
| SYNCto | 403, 417 |
| Input A | 657 |
| Input buffer | 822 |
| Input channel | 366 |
| Input configuration | 368 |
| Input coupling | 367, 379 |
| Input Help | 110, 171 |
| Input impedance | 370 |
| Input level | 140, 611 |
| Input Monitor | 612, 955 |
| Input Type | 896 |
| Input voltage, permissible | 44 |
| Input voltages | 32 |
| Installed options (remote control) | 853 |
| Instrument | 237, 364 |
| Instrument Concept | 137 |
| Instrument feet | 43 |
| Instrument settings | |
| /saving/loading | 220 |
| Instruments button | 205 |
| Integration time | 527, 541 |
| Interface assignment of I2S | 268 |
| Interface Clear | 1041 |
| Interface functions | |
| IEC/IEEE bus | 1042 |
| Interface Messages | 812 |
| Internal Display Not Activated | 65 |
| Internal impedance | 239 |
| International Telecommunication Union | 541, 552 |
| Interpolation | 735 |

- Interrupt 842
 - Interval 339, 350, 351
 - Chirp 338
 - Sine Burst 299
 - Sine² Burst 301
 - Interval File 359
 - Intv Time 486, 487
 - Invert 723
 - Inverted frequency response 723
 - IP address 80
 - IST flag 833, 853
 - ITU 541, 552
 - ITU P.862 542
 - ITU P.862.1 542
 - ITU P.862.2 542
- J**
- Jack, activating 647
- K**
- Key
 - LAN RESET 47
 - SHUTDOWN 47
 - SINGLE 441
 - Single (Single Measurement) 442
 - SINGLE (Terminated Measurement) 444
 - START (continuous measurement) 441
 - START (Single Measurement) 442
 - START (Terminated Measurement) 443
 - STOP/CONT 441
 - STOP/CONT (Single Measurement) 443
 - STOP/CONT (Terminated Measurement) 444
 - Keyboard 51
- L**
- Label Auto 688
 - Label of x-axis 668
 - Label-Auto 715
 - Labeling of y-axis 666
 - Labeling the x-axis 715
 - LAN configuration
 - Password 76
 - LAN connection 67
 - LAN interface 1043
 - LAN LED 75
 - Lead Bits
 - USI 8 Channel Analyzer 419
 - USI Dual Channel Analyzer 405
 - Leakage 527
 - LED
 - LAN 75
 - SWITCH OFF 47
 - Left 717, 757
 - Leg A Descript 720
 - Leg B Descript 720
 - Lev Trig 446
 - Lev Trig Ch1 446
 - Lev Trig Ch2 446
 - Level all di 500
 - Level controlled measurement value triggering 910
 - Level even di 500
 - Level Measurements 463, 931
 - Level meter 611, 612
 - Level Monitor 613, 955
 - Level Noise 506
 - Level odd di 500
 - Level Select di 500
 - Level sweep 350, 351
 - Level sweep list 358
 - Level THD+N 506
 - Limit 764
 - Lower 705
 - Parallel shifting 708
 - Source 703, 706
 - Symmetr. Shift 709
 - Upper 702
 - Limit curve 764
 - Limit display 668
 - Limit line 669
 - Limit Lower 705, 739, 759
 - Limit marker 746, 767
 - Limit Monitoring 764
 - Limit Shift 708
 - Limit to the FFT size 374, 384, 392, 396, 411, 426, 434
 - Limit Upper 702, 738, 761
 - Limit value curve 764
 - Limit violation 736
 - Limit violation display 743
 - Limit violations 666, 736, 764, 767
 - Lin Points 355, 476
 - Lin Steps 355, 476
 - Linear step size 357, 477
 - Linear sweep 354, 355, 476
 - List display 735
 - List sweep 358
 - List-controlled sweep 358
 - Load
 - Instrument settings 220
 - Traces 193
 - Loading Predefined Instrument Setups 134
 - LOCAL key 804, 805
 - Log Points 355, 476
 - Log Steps 355, 476
 - Logarithmic step size 357, 477
 - Logarithmic sweep 354, 355, 476
 - Logic Voltage 432
 - USI 8 Channel Analyzer 423
 - USI Dual Channel Analyzer 409
 - Long 603
 - Loop Channel
 - Play+Anlr 329
 - Loop Gain
 - Play+Anlr 329
 - Loudspeaker 646
 - Loudspeaker, activating 647
 - Low Dist
 - Sine 287
 - Low Level
 - Sine Burst 299
 - Low-distortion generator 138, 287
 - Lower Freq
 - Mod Dist 304
 - Random 314
 - Lower limit 705, 746
 - Lower limit x-axis 717
 - Lowpass filter 630
 - LXI (LAN eXtensions) 73
 - LXI browser interface 76
 - LXI website 75

M

- Main grid 666
- Main grid for y-axis 701
- Main gridlines 747
- Main gridlines x-axis 718
- Maintenance 1039
- Manual 580, 594
- Manual operation 136
 - Changing to 804
- Manual Remote Operation 80, 221
- Marker 670
- MAX 850
- Max Ch Disp 664, 744
- Max Delay 568, 571
- Max FFT size 374, 384, 392, 396, 434
 - USI 8 Channel Analyzer 426
 - USI Dual Channel Analyzer 411
- Maximum output voltage 94
- Maximum value 745
- MClk Ratio 264
 - USI 8 Channel Analyzer 423
 - USI Dual Channel Analyzer 409
- Mean Freq
 - DFD 306
 - Random 314
- Meas Channels 429
 - USI 8 Channel Analyzer 415
 - USI Dual Channel Analyzer 400
- Meas Mode 486, 490, 500, 506, 514, 521, 549, 557, 564, 578
- Meas Time 468, 471, 482, 492, 521, 541, 609
- Measured value Display in Lists 200
- Measured value Recording
 - Time-Controlled 452
- Measured value sequences 732, 768
- Measured value trigger .. 374, 383, 384, 396, 410, 425, 433, 434, 446, 580
- Measurement
 - Triggering (IEC/IEEE) 825
- Measurement channels 378
- Measurement delay 374, 384, 396, 411, 426, 434, 451
- Measurement display 745
- Measurement result display in numeric display field 175
- Measurement scans: Append 777
- Measurement scans: Replace 777
- Measurement signal versus time 545
- Measurement speed 508, 609
- Measurement value triggering 910
- Measuring function
 - Settling 616
- Memory depth 579
- Menu bar always visible 662
- Microsoft Excel 793
- MIN 850
- Min Delay 568
- Min Volt
 - Trigger 454
- Min/Max bargraph 746
- Min/Max curve 669
- Min/Max curve display 676
- Minimum value 745
- Mixed Sampfrq
 - USI Dual Channel Analyzer 401
- Mnemonics
 - optional 848
- Mod Depth
 - Modulation 332
- Mod Dist 302, 878
- MOD DIST 511, 939
- Mod Freq
 - Modulation 332
- Mode
 - DFD 305
 - Modulation 332
- Modify Equ. 723
- Modulation 332, 883
- Modulation Frequency 339
- Monitor
 - Connecting 51
- Monitor connection (DVI-D) 1052
- Monitor Connector (MONITOR) 1052
- Monitor level 140
- Mono Left 319, 326
- Mono Right 319, 326
- MOS 542, 685
- MOS LQO 542
- MOS P.862.1 548
- MOS P.862.1 Silence 548
- MOS P.862.1 Speech 548
- MOS P.862.2 548
- MOS P.862.2 Silence 548
- MOS P.862.2 Speech 548
- MOS value 542, 548
- MOS versus time 545
- Mouse 51
- Moving graphical windows 150
- Moving panels 150
- Moving reference value 689
- Multi Ch Mode 676
- Multi Channel Mode 676
- Multi scan 674, 732
- Multi-channel records output 924
- Multiscan 674
- Multisine 294
- Multistage preemphasis 723
- Mute after Measurement 313, 320, 327
- Muting
 - Play 320
 - Play+Anlr 327
 - Random 313

N

- Narrow 507
- Narrow band 564
- Navigating in lists 202
- NB 564
- NDAC 1041
- Neg Peak 486, 490
- Negotiation 78
- Network connector 67
- Network directories 72
- New Scan 709
- Next Bin 197
- Next Peak 196
- Next Pixel 196
- Next Sample 197
- Next Step 196, 353, 888
- Next Value 198
- No of Sine
 - Multisine 295

| | |
|--|--|
| No of Slots | |
| USI 8 Channel Analyzer | 416 |
| USI Dual Channel Analyzer | 402 |
| Noise | 506 |
| Noise component | 288 |
| Noise Density | 689 |
| Noise factor | 506 |
| Nominal range value | 372, 380, 381 |
| Norm Freq | 722 |
| Norm frequency | 722 |
| Normal averaging | 536, 537 |
| Normalization | 693 |
| Normalization value | 693, 694 |
| Normalize | 693 |
| Normalize Value | 694 |
| Normalizing trace | 693 |
| Notch characteristic | 465 |
| Notch filter | 464, 465, 496, 533, 632 |
| Notch Freq | 465, 533 |
| Notch frequency | 465, 533 |
| Notch gain | 464 |
| Notch-filter center frequency | 465 |
| Notch(Gain) | 464, 533 |
| Nothing | 603 |
| NRF | 1041 |
| Nth Octave Analysis | 519, 939 |
| NTRansition | 829 |
| Numeric display | 741 |
| Numeric Display Configuration | |
| Channel Descr. | 664 |
| Max Ch Disp | 664 |
| Numeric value (commands) | 819 |
| Numeric values | |
| special | 850 |
| O | |
| Octave | 521 |
| Octave filter | 632 |
| Odd Harmonics | 502 |
| ODG value | 553, 556 |
| Off | 329, 606, 612, 613, 616, 619, 621, 623 |
| Offline | 549, 557, 564 |
| Offline Analysis | 952 |
| Offline measurement | 549, 557, 564 |
| Offset | 724 |
| Offset Ch1 | |
| Stereo Sine | 294 |
| Offset Ch2 | |
| Stereo Sine | 294 |
| Offset Value | 724 |
| On Time | 339, 350, 351 |
| Sine Burst | 299 |
| Sine ² Burst | 301 |
| On Time File | 359 |
| One-dimensional sweep | 351 |
| One-Dimensional Sweep | 349 |
| Open panel | 154 |
| Operating concept | 136 |
| Operating examples | 114 |
| Operation Complete | 853 |
| Operation with mouse | 145 |
| Option | |
| Installation | 67 |
| R&S UPV B42 (universal serial interface) | 400, 415 |
| Option info | 853 |
| Order | |
| Filter | 630 |
| Order number | 852 |
| Orientation | 661 |
| Out vs Inp | 657 |
| Out-of-band signals | 464, 496 |
| Output A | 657 |
| Output channel | 238 |
| Output impedance | 239 |
| Output level | 648 |
| Output level limitation | 241 |
| Output of protocol data | 927 |
| Output of protocol errors | 927 |
| Output of trace data sets | 913 |
| Output Off | 236 |
| Output power of the universal generator | 249 |
| Output voltage, limiting | 94 |
| Outputs of the universal generator | 242 |
| Over | 236 |
| Overload | 236 |
| Overload protection | 370 |
| Overview of Keys | 229 |
| P | |
| Panel | |
| Overview | 232 |
| Panels | 153 |
| Parallel | 708 |
| Parallel Poll | 844 |
| Parallel shifting | 708 |
| Parameter | |
| Character string | 819 |
| Numeric value | 819 |
| Text | 819 |
| Parameter fields | 155 |
| Parameters | |
| boolean | 850 |
| SCPI | 849 |
| special numeric values | 850 |
| string | 851 |
| text | 851 |
| units | 850 |
| Passb Low | 632 |
| Passb Up | 632 |
| Passband | 631 |
| Password | 69 |
| LAN configuration | 76 |
| PDF | |
| Random | 312 |
| Peak | 485, 612, 613 |
| Peak Measurement | 935 |
| Peak to Peak | 486 |
| PEAQ Advanced | 556 |
| PEAQ analogue | 555 |
| PEAQ Basic | 556 |
| PEAQ Device Under Test | 554 |
| PEAQ digital | 555 |
| PEAQ DUT | 554 |
| PEAQ electrical | 554 |
| PEAQ graphics | 555 |
| PEAQ offline | 557 |
| PEAQ waveform | 555 |
| Persistence | 603 |
| PESQ acoustic | 544, 562 |
| PESQ Device Under Test | 543 |
| PESQ DUT | 543 |

- PESQ electrical 543
 - PESQ Graphs 545
 - PESQ measurement signal 541
 - PESQ MOS 542
 - PESQ Offline 549
 - PESQ P.862 548
 - PESQ reference signal 541
 - PESQ score 542
 - PESQ Silence 548
 - PESQ Speech 548
 - PESQ value 542, 548
 - PESQ versus time 545
 - PESQ waveform 545
 - PESQ_MOS measurement 685
 - PESQ/POLQA
 - Evaluation 685
 - PESQ/POLQA Graph 187
 - PESQ/POLQA measurement function 685
 - Phase 350, 351
 - Phase Ch2/1
 - Stereo Sine 292
 - Phase delay measurement 954
 - Phase display format 610
 - Phase File 359
 - Phase measurement, rapid 681
 - Phase No i
 - Multisine 296
 - Phase Settling 621
 - Phase sweep list 359
 - Phase To Ref 612
 - Phase-Sweep 350, 351
 - Phone Aux permanent 647
 - Phone enable 647
 - Ping Client 79
 - Pk to Pk 490
 - Play 317, 550, 551, 557, 558, 565, 566, 881
 - Play and Anlr 882
 - Play bef. Meas 374
 - Play before measurement 374
 - Play Mode
 - Play 321, 337
 - Play+Anlr 328
 - Play Peak
 - Play+Anlr 330
 - Play+Anlr 324
 - Point-to-point connections 69
 - Points 356, 477
 - Start Cond Time Tick/Chart 452
 - Polarity 331, 883
 - Polarity Measurement 518, 939
 - Poles 635
 - POLQA Device Under Test 561
 - POLQA DUT 561
 - POLQA electrical 561
 - POLQA Offline 564
 - Pos Peak 486, 490
 - Post FFT 498, 524, 526, 529
 - Power supply connection 44
 - PPE (parallel poll enable) 833
 - Pre Filter 396, 433
 - USI 8 Channel Analyzer 424
 - USI Dual Channel Analyzer 410
 - Prec 609
 - Precision 609
 - Precision measurement 496
 - Preemphasis
 - inverted 723
 - multistage 723
 - Offset 724
 - Offset value 724
 - Prefiltering 368, 380
 - PRESET 854
 - Presets 48
 - Presets (IEC/IEEE) 823
 - Pretrigger 583, 596
 - Preview 671
 - Print preview 671
 - Printer
 - Define Footer 661
 - Define Header 661
 - Destination 660
 - Filename 662
 - Graph Size 660
 - Header/footer 661
 - Orientation 661
 - Source 659
 - Store Mode 661
 - Printer Connector (LPT) 1050
 - Professional 602
 - Program
 - Message 817
 - Prot Analysis 602
 - Protocol Analysis 953
 - Protocol Analyzer 602
 - Protocol data 1001
 - Protocol data output 927
 - Protocol errors output 927
 - psychoacoustic coding 541, 552
 - psychoacoustic compression 541, 552
 - PTRansition 829
- ## Q
- Quasi Peak 487, 490
 - Query 818, 844
 - Querying the computer name 72
 - Question mark 818
 - Quotation marks 820
- ## R
- R&S CM 562
 - R&S CMU 544
 - R&S UPV B42 (universal serial interface) 400, 415
 - R&S UPZ 653
 - Rack adapter 43
 - Rack installation 42
 - Random 309, 879
 - Random sweep 358
 - Range 372, 380, 381
 - Rapid deactivation 95
 - Rapid deactivation of outputs 370
 - Rapid Deactivation of Outputs 213, 890
 - Rapid phase measurement 681
 - Rated voltages 44
 - Ratio
 - USI Dual Channel Analyzer 401
 - Ratio of voice to noise 567, 568
 - Ratio of voice to silence 567, 568
 - Reading measurement results 911
 - Reading out multi-channel records 924
 - Reading Results 904

| | |
|---|-------------------------|
| Rear audio monitoring output | 649 |
| Record File | 592 |
| Record Length | 550, 558, 566, 593 |
| Recording length | 579 |
| Recovery | 84, 89 |
| Rectangular window | 527, 528 |
| Ref Channel | 433, 445 |
| USI 8 Channel Analyzer | 424 |
| Ref Level | 551, 558, 566 |
| Ref Sp. Ratio | 567 |
| Ref Value | 716 |
| Reference | 689, 754 |
| Reference channel | 445, 478, 606 |
| Reference File | 693 |
| Reference frequency | 242, 258, 259, 266, 279 |
| Reference impedance | 373, 382 |
| Reference level | 241, 258, 259, 266, 279 |
| Reference signal versus time | 545 |
| Reference value | 689, 692, 716, 754 |
| Reference Value | 692, 716 |
| Reference values | 167 |
| Reference voltage | 241, 258, 259, 266, 279 |
| Refinement | 503 |
| Reject Bandw | 508 |
| Rejection | 507 |
| Rejection bandwidth | 508 |
| Remote | |
| GPIB address | 659 |
| SCPI update | 659 |
| Remote control | |
| Manual | 80 |
| Remote Control - Changing to | 804 |
| Remote Control - Command Description | 847 |
| Remote Control - Ethernet/LAN | 805 |
| Remote control - IEC/IEEE bus | 804 |
| Remote desktop | 80 |
| REN | 1041 |
| Rename | 1024 |
| Renaming of files | 1024 |
| Replace/Append | 709 |
| Reset | 854 |
| Resetting Min/Max curves | 676 |
| Resetting the Status Reporting System | 845 |
| Resistance | 382 |
| Resizing graphical windows | 150 |
| Resizing panels | 150 |
| Resolution | 541, 725, 739, 753 |
| Settling for Frequency Measurements | 620 |
| Settling for Measurement Functions | 618 |
| Settling for Phase Measurements | 622 |
| Settling Start Conditions | 625 |
| Restart | |
| Play | 321 |
| Play+Anlr | 327 |
| Result lists | 735 |
| Resync | |
| USI 8 Channel Analyzer | 426 |
| USI Dual Channel Analyzer | 411 |
| Rife Vincent 1 | 528 |
| Rife Vincent 2 | 528 |
| Rife Vincent 3 | 528 |
| Right | 718, 757 |
| Rising | 582, 595 |
| Risk of overheating | 43 |
| RMS | 467, 490, 613 |
| RMS measurement | 467 |
| RMS Measurement | 932 |
| RMS measurement selective | 470 |
| RMS selective | 470 |
| RMS Selective | 470 |
| RMS Selective Measurement | 932 |
| Rotary knob | 144 |
| RS-232-C Interface (COM) | 1046 |
| RST:IEC/IEEE bus address:28 | 1035 |
| Rub & Buzz Measurement | 481, 934 |
| S | |
| S/N measurements | 488 |
| S/N Sequence | 494 |
| Safety precautions | 41 |
| Sample Freq | 263, 394, 431, 606 |
| USI 8 Channel Analyzer | 420 |
| USI Dual Channel Analyzer | 406 |
| Sample frequency | 263 |
| Samples | |
| Settling for Frequency Measurements | 619 |
| Settling for Measurement Functions | 617 |
| Settling for Phase Measurements | 622 |
| Settling Start Conditions | 624 |
| Samples/Frame | |
| USI 8 Channel Analyzer | 416 |
| USI Dual Channel Analyzer | 402 |
| Sampling Del | 431 |
| USI 8 Channel Analyzer | 423 |
| USI Dual Channel Analyzer | 409 |
| Sampling rate | 263 |
| USI 8 Channel Analyzer | 420 |
| USI Dual Channel Analyzer | 406 |
| Save | |
| Instrument settings | 220 |
| Traces | 193 |
| Saving Instrument Settings | 798 |
| Saving open panels | 798 |
| Scale for audio quality | 552 |
| Scale Pk to FS | 551, 558, 566 |
| Play | 319 |
| Scaling | 717, 746 |
| Scaling graph | 195 |
| Scaling of x-axis | 668 |
| Scaling of y-axis | 667 |
| Scan | 674, 726, 740 |
| Memory depth | 675 |
| Multi | 674 |
| Single | 674 |
| Scan append | 709 |
| Scan count | 667 |
| Scan Index | 740 |
| Scan number | 667, 726, 736 |
| Scan replace | 709 |
| Scan: Index | 732 |
| Scans: Append | 776 |
| Scans: Import | 776, 777 |
| Scans: Replace | 776 |
| SCPI | |
| parameters | 849 |
| Version | 802 |
| SCPI Logging/Query Longform | 663 |
| SCPI update | 659 |
| Screen resolution | 52 |
| Screens | 147 |
| Screens button | 205 |
| SDG value | 552 |
| Select di | 500 |

- Selecting the Analyzer 891
- Selecting the generator 855
- Selection frame 737
- Semicolon 820
- Serial number 852
- Serial Poll 842
- Service request (SRQ) 854
- Service Request (SRQ) 832, 842
- Setting the required generator signal 856, 857, 858
- Setting the Supply Voltage 45
- Settings in the Menu Bar 203
- Settings in the Operating System 210
- Settings on the Toolbar 209
- Settling
 - Start Conditions 623
- Settling Algorithms 615
- Settling Applications 614
- Settling examples of start conditions 626
- Settling for Frequency Measurements 619
- Settling for Measurement Functions 616
- Settling for Phase Measurements 621
- Settling for Start Conditions (Event-Triggered Measurements) 623
- Settling Methods 614
- Settling time 637
- Setup
 - load and store 1022
- Shape
 - Random 311
- Shape File
 - Play 318
 - Random 312
- Shift, Limit 708
- Short 603
- Short Name
 - Filter 637
- Shortcut
 - CTRL + ALT + F1 65
 - CTRL + ALT + F3 65
 - CTRL + ALT + F4 65
 - Ctrl+Alt+Del 46
- Show 577, 602
- Show A 720
- Show B 720
- Show Min/Max 676, 763
- Show Title 720
- Signal attenuation 566, 567
- Signal delay constant 558
- Signal delay time axis 551, 558, 567, 568
- Signal gain 566, 567
- Signal source 647
- Signal to noise measurements 488
- Signal-to-noise measurement signal 567
- Signal-to-Noise Measurements 488, 935
- Signal-to-noise reference signal 567
- SINAD 504, 506
- Sine 287
- Sine Burst 297, 876
- Sine generator signal 868
- Sine² Burst 300
- Single 236
- SINGLE
 - Sweep 458
- Single measurement 442
- Single scan 674, 731
- Single Scan 731
- Sinus2 Burst 877
- Slope of bell-shaped curve 528
- Slot Length
 - USI 8 Channel Analyzer 419
 - USI Dual Channel Analyzer 405
- Slots
 - USI 8 Channel Analyzer 417
 - USI Dual Channel Analyzer 403
- SNR Degraded 567
- SNR Ref 567
- Softkey bar 668
- Softkey menu: Combo display 763
- Softkey menu: Graphical window 726
- Softkeys 148
- Software lockup 46
- Source 659, 703, 706
- Source Filename 705, 707
- Source Value 704, 707
- Spacing 355, 476, 699, 717, 756
 - Multisine 295
 - Random 313
- Span 540
- Speaker 646
- Speaker enable 647
- Special characters
 - SCPI 849
- Spectral display 526
- Spectral range 526
- Spectrum 526
- Spectrum display 966
- Speech quality measurements 541, 546
- Speech quality scale 541
- Speech signal measurement 541
- Splash screen 46
- Square 334, 883
- Square Sine
 - DIM 308
- SRE (service request enable) 832
- SRQ 1041
- SRQ (service request) 854
- Standard 578
- Standard operating mode 440
- Start 356, 477, 540
 - Trigger 454
- START
 - Sweep 458
- Start Cond 396, 434, 446
 - USI 8 Channel Analyzer 425
 - USI Dual Channel Analyzer 410
- Start conditions 909
- Start Conditions 445
- Start Freq
 - Chirp 337
- Start of measurement 374, 383, 384, 396, 410, 425, 433, 434, 446, 580
- Starting measurements 904
- Starting Measurements 438
- States of the Measurement System 440
- Status Displays 152
- Status messages 235
- Status register:ESE 833
- Status register:ESR 833
- Status register:PPE 833
- Status registers
 - CONDITION 829
 - ENABLE 829
 - EVENT 829
 - NTRansition 829

- PTRansition 829
 - Structure 829
- Status registers:Overview 832
- Status registers:SRE 832
- Status registers:STATus-OPERation 834
- Status registers:STATus-QUESTionable 836, 837, 838
- Status registers:STB 832
- Status reporting system 1025
- Status-Reporting-System:Initialize 845
- STATus\\:OPERation-Register 834
- STATus\\:QUESTionable-Register ... 836, 837, 838, 839, 840
- STB (status byte) 832
- Step 357, 477, 719, 758
- Step size 357, 477
- Steps 702
- Stereo 319, 326
 - Play+Anlr 329
- Stereo Sine 290
- Stop 356, 477, 541
 - Trigger 455
- Stop Freq
 - Chirp 337
- STOP/CONT
 - Sweep 459
- Stopb Low 632
 - Notch filter 634
- Stopb Upp 632
 - Notch filter 634
- Stopband 631
- Stopped 236
- Stopped measurement 444
- Store
 - Trace 725
- Store Mode 661
- Store trace as 721, 725
- Store Trace as 721
- Store Trace to 725
- Store WAV 550, 557, 565
- Store Wav to 570
- Strings 819
- Structure
 - Command 814
 - Program message 817
- Subgrid 666
- Subgridlines 702, 747
- Suffix 814
- Suffixes 848
- Super wide band 564
- Suppression of far-off interference 528
- SWB 564
- Sweep 671
 - Activate and deactivate 457
 - Consecutive numbering 458
 - Options 456
 - States 457
- Sweep (IEC/IEEE)
 - Triggering 825
- Sweep Ctrl 348, 475
 - DC (Direct-Current Voltage) 333
 - DFD 306
 - DIM 308
 - Mod Dist 303
 - Sine 288
 - Sine Burst 298
 - Sine² Burst 301
 - Square 335
 - Stereo Sine 291
 - Sweep direction 354, 356, 477
 - Sweep graph 183
 - Sweep Off 236
 - Sweep operating mode 288
 - Sweep Options 929
 - Sweep Run Cont 236
 - Sweep Run Manual 236
 - Sweep Run Single 236
 - Sweep Speed 360
 - Sweep status 236
 - Sweep stepping 353
 - Sweep Stopped 236
 - Sweep system 348
 - Sweep Terminated 236
 - Sweep Time
 - Chirp 337
 - Sweep Waiting 236
 - Sweeps 346, 886
 - Switcher 656
 - Switcher Panel 653, 964
 - Switching Off 47
 - Switching on the instrument 45
 - Symmetr. Shift 709
 - Symmetrical 709
 - Sync To 263
 - USI 8 Channel Analyzer 417
 - USI Dual Channel Analyzer 403
 - Synchronization (IEC/IEEE) 825
 - Synchronization source 263
 - Synchronous sweep 352
 - Syntax elements
 - Command 820
 - System directory 1020
 - System partition 86, 91

T

 - Terminated 236
 - Terminated measurement 443
 - Termination event 442, 456
 - Sweep 459
 - Text parameter 819
 - THD 499, 937
 - THD and N 499, 504
 - THD measured value 500
 - THD+N 506
 - THD+N / SINAD 938
 - THD+N measurement method 506
 - Third-octave filter 632
 - Time
 - Play 322
 - Play+Anlr 328
 - Start Cond Time Tick/Chart 452
 - Time Chart 446
 - Time Cont 321, 328
 - Time delays of signals 551, 558, 567, 568
 - Time Single 321, 328
 - Time Tick 446
 - Time-controlled measured value recording 444
 - Time-Controlled Measured value Recording 452
 - Time-triggered sweep 352
 - Timeout
 - Settling for Frequency Measurements 620
 - Settling for Measurement Functions 618
 - Settling for Phase Measurements 622
 - USI 8 Channel Analyzer 419
 - USI Dual Channel Analyzer 405

- Timing Diagrams
 - USI Dual Channel Analyzer 412
 - Timing diagrams of I2S 266
 - Title bar 156
 - Title Descript 720
 - Tolerance
 - Settling for Frequency Measurements 620
 - Settling for Measurement Functions 617
 - Settling Start Conditions 625
 - Tool bar always visible 662
 - Top 700
 - Tot Volt File 358
 - Total Cont 321, 328, 337
 - Total distortion factor 506
 - Total distortion voltage 506
 - Total Gain
 - Multisine 296
 - total harmonic distortion + noise 504
 - Total load 43
 - Total Peak
 - Multisine 296
 - Polarity 331
 - Total RMS
 - Multisine 296
 - Polarity 331
 - Total Single 321, 328, 337
 - Total Voltage
 - DFD 306
 - DIM 308
 - Mod Dist 304
 - Trace 664, 666, 722
 - Trace data sets output 913
 - Trace data transferring 1014
 - Trace display 966
 - Trace File 686
 - Trace Group 732
 - Trace Length 579
 - Trace: Equalization list: Format 784
 - Trace: Equalization list: Store 769
 - Trace: Format 780
 - Trace: Limit list Format 786
 - Trace: Limit list Load 779
 - Trace: Limit list Store 771
 - Trace: Load 771
 - Trace: Store 769
 - Trace: Sweep list Format 785
 - Trace: Sweep list Load 779
 - Trace: Sweep list Store 770
 - Traces
 - Saving 193
 - showing and hiding 194
 - Track 687
 - Track box 171
 - Tracking 656, 687
 - Transfer function
 - Filter 635
 - Transferring settings 687
 - Transferring trace data 1014
 - Trig In Out 213
 - Trigger
 - measurement value 910
 - Trigger Chan 446
 - Trigger channel 446, 580
 - Trigger Channel 433, 580
 - USI 8 Channel Analyzer 425
 - Trigger command (IEC/IEEE) 825
 - Trigger input 213
 - Trigger Input 652
 - Trigger input edge 652
 - Trigger Input Edge 652
 - Trigger Input Mode 652
 - Trigger Input operating mode 652
 - Trigger level 582, 595
 - Trigger output 213
 - Trigger Output 650
 - Trigger output edge 651
 - Trigger Output Edge 651
 - Trigger Output Enable 650
 - Trigger Output Mode 651
 - Trigger output operating mode 651
 - Trigger output, activating 650
 - Trigger slope 582, 595
 - Trigger source 580, 594
 - Trigger time 583
 - triggered 537
 - Triggering measurements 904
 - Triggering Measurements 904
 - Two-Dimensional Sweep 350
- ## U
- Under 236
 - Undersample 578, 598
 - Undersample FFT 537
 - Undersampling 598
 - Unit 696, 714, 738, 746, 751
 - Unit Auto 697, 716, 738, 752
 - Unit for digital phase measurement results (Phase to Ref) 226
 - Unit for S/N measurement results 225
 - Unit Funct Track 694, 738
 - Unit of measurement result 179
 - Unit User String 698, 716
 - Units 223, 850
 - Units for digital jitter measurement results 226
 - Units for digital level measurement results 224
 - Units for distortion measurement results 224
 - Units for frequency measurement results 225
 - Units for group delay measurement results 225
 - Units for phase measurement results 225
 - Units for Value Entries 226
 - Universal commands 1042
 - Universal generator 137
 - Universal serial interface 400, 415
 - Upper Freq
 - DFD 306
 - Mod Dist 304
 - Upper limit 702, 746
 - Upper limit x-axis 718
 - Upward sweep 356, 358, 477
 - UPZ 653
 - USB
 - Connection 1049
 - Device-Connection 1050
 - Used for 659
 - User ID 69
 - User-definable data buffers 1016
 - User-defined unit designation 698
 - USI 8 Channel Analyzer 415
 - USI Dual Channel Analyzer 400, 898
 - USI Dual-Generator 863
 - Utilities button 203, 207
 - Utilities Config panel, General Configuration settings 208

V

| | |
|---|----------|
| Valid Value Range | 152 |
| Value 465, 468, 471, 482, 486, 487, 492, 502, 509, 521, 533 | |
| Value range, permissible | 152 |
| Variation | 339 |
| Trigger | 455 |
| Version | 556 |
| Versions+Options (remote control) | 852 |
| Vert Move button | 150 |
| Vert Size button | 150 |
| View Mode | 604 |
| Volt | 446 |
| Volt Ch1 | 446 |
| Stereo Sine | 292 |
| Volt Ch2 | 446 |
| Stereo Sine | 292 |
| Volt Ch2/1 | |
| Play | 323 |
| Stereo Sine | 292 |
| Volt LF:UF | |
| Mod Dist | 304 |
| Volt Mode | 874 |
| Play | 322 |
| Stereo Sine | 291 |
| Volt No i | |
| Multisine | 296 |
| Volt Peak | |
| Arbitrary | 317 |
| Chirp | 337 |
| Random | 314 |
| Volt Peak Ch1 | |
| Play | 322 |
| Volt Peak Ch2 | |
| Play | 323 |
| Volt RMS | |
| Arbitrary | 317 |
| Chirp | 337 |
| Random | 315 |
| Voltage | 350, 351 |
| DC (Direct-Current Voltage) | 334 |
| Sine | 289 |
| Sine Burst | 298 |
| Sine ² Burst | 301 |
| Square | 335 |
| Voltage Mode | |
| Multisine | 295 |
| Volume | 211, 648 |
| Volume key | 211 |
| VXI-11 Discovery | 78 |

W

| | |
|--|---------------|
| Wait for DC Adj | 236 |
| Wait for Trigger | 236 |
| Warm start | 46 |
| Warnings | 153 |
| Waveform | 185, 577, 671 |
| Waveform monitor | 577 |
| Waveform Monitor | 446 |
| WB | 564 |
| Weighting filters | 573, 596 |
| Weighting Filters 466, 491, 509, 522, 551, 559, 568, 637 | |
| White space | 820 |
| Wide band | 564 |
| Wideband RMS | 467 |

Width

| | |
|--------------------------------------|----------|
| Filter | 634 |
| Win Style | 663 |
| Window | 525, 528 |
| Window function | 525, 528 |
| Windows | 49 |
| Windows 7 Recovery and Backup | 89 |
| Windows button | 203, 209 |
| Windows XP Recovery and Backup | 84 |
| Word Length | 263, 393 |
| Word length of audio data | 264 |
| Word Offset | 266, 396 |
| Word width | 263 |
| Digital analyzer | 388 |

X

| | |
|--------------------------|---------------|
| X-axis | 193, 350, 712 |
| labeling | 715 |
| Lower limit | 717 |
| Main grid | 718 |
| Scaling | 717 |
| Spacing | 717 |
| Top limit | 718 |
| Unit | 714 |
| Unit Auto | 716 |
| X-Source | 710 |
| XE "Noise density" | 689 |

Y

| | |
|-------------------------------|----------|
| Y-axis | 190 |
| Division | 701, 702 |
| Main grid | 701 |
| Spacing | 699 |
| Top limit | 700 |
| Unit | 696 |
| Y-axis for bottom limit | 700 |
| Y-axis for top limit | 700 |
| Y-Source | 684, 685 |
| Bar Graph | 685 |
| FFT Graph | 681 |
| Sweep graph | 677 |
| Waveform | 684 |

Z

| | |
|--------------------|-----|
| Z stop value | 459 |
| Z-axis | 351 |
| Z-Sweep | 732 |
| Zeros | 635 |