



ROHDE & SCHWARZ

Test and Measurement
Division

Operating Manual

Handheld Spectrum Analyzer

R&S[®] FSH

1145.5850.03

1145.5850.13

1145.5850.23

1145.5850.06

1145.5850.26

Dear Customer,

R&S® is a registered trademark of Rohde & Schwarz GmbH & Co. KG.
Trade names are trademarks of the owners.

1145.5973.12-12-

2

Contents

Specifications
Safety Instructions
Certificate of Quality
EC-Certificate of Conformity
Support Center Address
List of R&S Representatives

| | |
|---|------|
| 1 Putting into Operation | 1.1 |
| Front view | 1.1 |
| Putting into Operation | 1.2 |
| Unpacking the Instrument..... | 1.2 |
| Setting up the Instrument..... | 1.3 |
| Switching on the Spectrum Analyzer | 1.4 |
| Spectrum Analyzer Connectors | 1.5 |
| Screen Settings..... | 1.7 |
| Country-Specific Settings..... | 1.9 |
| Setting the Date and Time | 1.10 |
| Setting the date | 1.10 |
| Setting the time | 1.10 |
| Charging the Battery | 1.11 |
| Selecting the Instrument Default Setup | 1.12 |
| External Reference / External Trigger Switchover | 1.13 |
| Controlling the RF Attenuator | 1.14 |
| Using a Preamplifier | 1.14 |
| PIN Entry | 1.16 |
| Connecting Printers | 1.18 |
| Setting the Baud Rate for Remote Control | 1.20 |
| Enabling Options | 1.20 |
| Checking the Installed Options | 1.21 |

| | |
|--|------|
| 2 Getting Started | 2.1 |
| Measurements on CW Signals | 2.1 |
| Level measurement | 2.1 |
| Setting the Reference Level..... | 2.2 |
| Frequency Measurements | 2.3 |
| Harmonic Measurements of a Sinewave Signal | 2.4 |
| Power Measurements Using the Power Sensor | 2.5 |
| Power and Return Loss Measurements with the R&S FSH-Z14 or the R&S FSH-Z44 | 2.7 |
| Two-Port Transmission Measurements | 2.9 |
| Measurement of Return Loss | 2.11 |
| Performing Distance-To-Fault Measurements..... | 2.14 |
| Operation in Receiver Mode | 2.20 |
| Measuring the Carrier-to-Noise Ratio | 2.25 |
| Reference power/reference level | 2.26 |
| Measuring the noise power | 2.27 |
| Saving and Recalling Settings and Test Results | 2.28 |
| Saving Measurement Results | 2.28 |
| Saving Calibration Data | 2.29 |
| Recalling Measurement Results | 2.30 |
| Printing Out Measurement Results | 2.31 |

| | |
|---|------|
| 3 Operation | 3.1 |
| Screen Layout | 3.1 |
| Screen layout for spectrum-mode measurements without markers | 3.1 |
| Screen layout when the marker mode is selected | 3.2 |
| Entering Measurement Parameters | 3.3 |
| Entering values and texts | 3.3 |
| Entering units | 3.4 |
| Menu Overview | 3.5 |
| Frequency entry | 3.5 |
| Frequency span | 3.5 |
| Level setting | 3.5 |
| Bandwidth setting | 3.5 |
| Sweep | 3.6 |
| Trace setting | 3.6 |
| Measurement functions | 3.7 |
| Markers | 3.10 |
| Save and print menu | 3.11 |
| Instrument setup | 3.11 |
| Status display | 3.11 |
| Menus in the Receiver Mode (Option R&S FSH-K3) | 3.12 |
| Menu for 3GPP BTS Code Domain Power Measurement (Option R&S FSH-K4) | 3.15 |

| | |
|---|------|
| 4 Instrument Functions | 4.1 |
| Instrument Default Setup | 4.1 |
| Status Display | 4.1 |
| Setting the Frequency | 4.2 |
| Entering the center frequency | 4.2 |
| Setting a frequency offset | 4.2 |
| Entering the center-frequency step size | 4.3 |
| Entering the start and stop frequency | 4.4 |
| Working with channel tables | 4.4 |
| Setting the Span | 4.6 |
| Setting the Amplitude Parameters | 4.7 |
| Setting the reference level | 4.8 |
| Entering the display range | 4.8 |
| Entering the display unit | 4.9 |
| Entering the reference offset | 4.9 |
| Entering the input impedance | 4.9 |
| Setting the Bandwidths | 4.10 |
| Resolution bandwidth | 4.10 |
| Video bandwidth | 4.12 |
| Setting the Sweep | 4.14 |
| Sweep time | 4.14 |
| Sweep mode | 4.15 |
| Trigger | 4.15 |
| Trace Settings | 4.18 |
| Trace mode | 4.18 |
| Detector | 4.19 |
| Trace memory | 4.21 |
| Trace mathematics | 4.22 |
| Using the Markers | 4.23 |
| Automatic marker positioning | 4.24 |
| Using more than one marker at a time (multimarker mode) | 4.26 |
| Marker functions | 4.29 |
| Measuring the noise power density | 4.29 |
| Measuring the frequency | 4.30 |
| AF demodulation | 4.31 |

| | |
|---|------|
| Using the Display Line | 4.32 |
| Setting and Using the Measurement Functions | 4.33 |
| Measuring the channel power of continuously modulated signals | 4.33 |
| Selecting the standard | 4.34 |
| Setting the reference level | 4.36 |
| Setting the channel bandwidth | 4.36 |
| Changing the span | 4.37 |
| Power display | 4.38 |
| Power measurements on TDMA signals | 4.40 |
| Selecting a standard | 4.40 |
| Setting the measurement time | 4.42 |
| Optimizing the reference level | 4.42 |
| Power readout | 4.43 |
| Setting the trigger | 4.43 |
| Measuring the occupied bandwidth | 4.44 |
| Selecting a standard | 4.45 |
| Setting the reference level | 4.46 |
| Setting the channel bandwidth | 4.47 |
| Displaying the occupied bandwidth | 4.47 |
| Changing the span | 4.48 |
| Measuring the Carrier-to-Noise Ratio | 4.49 |
| Determining the reference | 4.50 |
| DIGITAL Tx mode | 4.50 |
| ANALOG TV mode | 4.51 |
| CW Tx mode | 4.51 |
| Manual reference mode | 4.52 |
| Setting the reference channel | 4.52 |
| Setting the reference channel bandwidth | 4.53 |
| Setting the analyzer reference level for the reference channel measurement | 4.54 |
| Inserting the C/N reference | 4.54 |
| Units of the C/N reference | 4.55 |
| Measuring the noise channel power and calculating the carrier power/noise power | 4.55 |
| Setting the noise channel | 4.56 |
| Setting the noise channel bandwidth | 4.57 |
| Setting the R&S FSH reference level during noise channel measurement | 4.57 |
| Selecting the C/N result display | 4.58 |
| C/N measurement result display | 4.58 |
| Changing the span | 4.59 |

| | |
|---|-------|
| Using the R&S FSH in receiver mode | 4.60 |
| Setting the frequency | 4.61 |
| Setting the reference level | 4.63 |
| Setting the bandwidth..... | 4.64 |
| Setting the detector..... | 4.65 |
| Setting the measurement time..... | 4.65 |
| Measurement on multiple frequencies or channels (scan)..... | 4.66 |
| | |
| Measurements using the power sensor | 4.68 |
| Connecting the power sensor | 4.68 |
| Zeroing the power sensor | 4.70 |
| Selecting the unit for the power readout | 4.71 |
| Setting the averaging time | 4.72 |
| Taking additional loss or gain into account..... | 4.72 |
| | |
| Measuring forward and reflected power | 4.74 |
| Zeroing the power sensor | 4.76 |
| Setting the power measurement weighting..... | 4.77 |
| Selecting the unit for the power readout | 4.78 |
| Taking additional attenuation into account..... | 4.79 |
| | |
| Two-port measurements with the tracking generator | 4.81 |
| Measuring the transmission of two-ports | 4.83 |
| Vector transmission measurement..... | 4.86 |
| Transmission measurement using the connected VSWR Bridge R&S FSH-Z3..... | 4.88 |
| Spectrum measurements with the VSWR Bridge R&S FSH-Z3 or R&S FSH-Z2 connected..... | 4.89 |
| Settings for detection of the R&S FSH-Z3 in transmission and spectrum meas. | 4.90 |
| Supplying DC voltage to active DUTs | 4.90 |
| Reflection measurements | 4.90 |
| Scalar measurement of reflection | 4.91 |
| Vector measurement of reflection..... | 4.93 |
| Display of reflection in vector measurement..... | 4.95 |
| Spectrum meas. with the VSWR Bridge R&S FSH-Z3 or R&S FSH-Z2 connected ... | 4.99 |
| Settings for detection of the R&S FSH-Z2 and R&S FSH-Z3 | 4.100 |
| | |
| One-Port Measurement of Cable Loss | 4.101 |

| | |
|---|-------|
| Cable Measurements | 4.102 |
| Cable selection | 4.103 |
| Selecting the frequency range | 4.106 |
| Calibrating the test setup | 4.107 |
| Locating cable faults by means of the marker function | 4.110 |
| Measuring spectrum and reflection..... | 4.113 |
| Further information | 4.114 |
| Setting the span | 4.114 |
| Selecting the center frequency..... | 4.115 |
| Measurement | 4.116 |
| Length measurement accuracy..... | 4.116 |
| Using Limit Lines | 4.117 |
| Measurements with limit lines | 4.119 |
| Definition range of limit lines | 4.120 |
| Data sets containing limit lines..... | 4.120 |
| Measuring with Transducer Factors | 4.121 |
| Unit for measurements with transducers | 4.123 |
| Reference level settings for measurements with transducers | 4.123 |
| Frequency range of transducer | 4.124 |
| Data sets containing transducer factors | 4.124 |
| Field-Strength Measurement with Isotropic Antenna | 4.125 |
| Connecting the antenna to the R&S FSH | 4.125 |
| Measurement of the resultant field strength in a transm. channel with large bandwidth | 4.127 |
| Code Domain Power Measurement on 3GPP FDD Signals | 4.134 |
| Saving and Loading Instrument Settings and Measurement Results | 4.138 |
| Saving results | 4.139 |
| Entering a data set name..... | 4.140 |
| Loading measurement results | 4.140 |
| Deleting saved data sets..... | 4.141 |
| Deleting all data sets..... | 4.142 |
| Printing out Measurement Results | 4.143 |
| Measurements | 4.144 |
| How a spectrum analyzer operates | 4.144 |

Specifications

Specifications are valid under the following conditions: 15 minutes warm-up time at ambient temperature, specified environmental conditions met and calibration cycle adhered to. Data without tolerances: typical values. Data designated as "nominal": design parameters, i.e. not tested.

| Specification | Condition | R&S® FSH3 | R&S® FSH6 |
|--|--|--|-----------------------|
| Frequency | | | |
| Frequency range | | 100 kHz to 3 GHz | 100 kHz to 6 GHz |
| Reference frequency | | | |
| Aging | | 1 ppm/year | |
| Temperature drift | 0 °C to 30 °C 30 °C to 50 °C | 2 ppm in addition 2 ppm/10 °C | |
| Frequency counter | | | |
| Resolution | | 1 Hz | |
| Frequency span | | 0 Hz, 100 Hz to 3 GHz | 0 Hz, 100 Hz to 6 GHz |
| Spectral purity | | | |
| SSB phase noise | f = 500 MHz, 20 °C to 30 °C | | |
| 30 kHz from carrier | | <85 dBc (1 Hz) | |
| 100 kHz from carrier | | <100 dBc (1 Hz) | |
| 1 MHz from carrier | | <120 dBc (1 Hz) | |
| Sweep time | span = 0 Hz span > 0 Hz | 1 ms to 100 s 20 ms to 1000 s, min. 20 ms/600 MHz | |
| Bandwidths | | | |
| Resolution bandwidths (-3 dB) | 1145.5850.13 | 1, 3, 10, 30, 100, 200, 300 kHz, 1 MHz | |
| | 1145.5850.03, .23, 1145.5850.06, .26 | in addition 100 Hz, 300 Hz | |
| Tolerance | ≤300 kHz 1 MHz | ±5 %, nominal ±10 %, nominal | |
| Resolution bandwidths (-6 dB) | with option R&S® FSH-K3 installed | in addition 200 Hz, 9 kHz, 120 kHz | |
| Video bandwidths | | 10 Hz to 1 MHz in 1, 3 steps | |
| Amplitude | | | |
| Display range | | average noise level displayed to +20 dBm | |
| Maximum permissible DC voltage at RF input | | 50 V/ 80 V ¹⁾ | |
| Maximum power | | 20 dBm, 30 dBm (1 W) for max. 3 minutes | |
| Intermodulation-free dynamic range | third-order IM products, 2 x -20 dBm, reference level = -10 dBm | | |
| Carrier offset ≤ 2 MHz | | 60 dB (+10 dBm third-order intercept) | |
| Carrier offset > 2 MHz | | 66 dB (+13 dBm third-order intercept) | |

¹ 80 V valid as of serial number 100900 (model 1145.5850.03) or 101600 (model 1145.5850.13); models 1145.5850.23, 1145.5850.06 and .26 all serial numbers.

| Specification | Condition | R&S® FSH3 | R&S® FSH6 |
|--------------------------------------|---|--|--|
| Displayed average noise level | average value, resolution bandwidth 1 kHz, video bandwidth 10 Hz, reference level ≤ -30 dBm | | |
| 10 MHz to 3 GHz | | <-105 dBm, typ. -114 dBm | <-105 dBm, typ. -112 dBm |
| 3 GHz to 5 GHz | | | <-103 dBm, typ. -108 dBm |
| 5 GHz to 6 GHz | | | <-96 dBm, typ. -102 dBm |
| With preamplifier | only models | | |
| 10 MHz to 2.5 GHz | 1145.5850.03 ²), 1145.5850.23, 1145.5850.06 and 1145.5850.26 | <-120 dBm, typ. -125 dBm | <-120 dBm, typ. -125 dBm |
| 2.5 GHz to 3 GHz | | <-115 dBm, typ. -120 dBm | <-115 dBm, typ. -120 dBm |
| 3 GHz to 5 GHz | | | <-115 dBm, typ. -120 dBm |
| 5 GHz to 6 GHz | | | <-105 dBm, typ. -110 dBm |
| Inherent spurious | reference level ≤ -20 dBm, $f > 30$ MHz, RBW ≤ 100 kHz | <-80 dBm | <-80 dBm |
| Input related spurious | mixer level -40 dBm, up to 3 GHz | | |
| Carrier offset > 1 MHz | 3 GHz to 6 GHz | <-70 dBc (nominal) | <-70 dBc (nominal) <-64 dBc (nominal) |
| Signal frequency minus 2.0156 GHz | for signal frequencies 2 GHz to 3.2 GHz | typ. <-55 dBc | typ. <-55 dBc |
| 2nd harmonic | | typ. <-60 dBc | typ. <-60 dBc |
| Level display | | | |
| Reference level | | -80 dBm to +20 dBm in steps of 1 dB | |
| Display range | | 100 dB, 50 dB, 20 dB, 10 dB, linear | |
| Display units | | dBm, dB μ V, dBmV with transducer also dB μ V/m and dB μ A/m | |
| Logarithmic | | μ V, mV, V, nW, μ W, mW, W with transducer also V/m, mV/m, μ V/m and W/m ² | |
| Linear | | 1 trace and 1 memory trace | |
| Traces | | A-B and B-A (trace – memory trace and memory trace – trace) | |
| Trace mathematics | | auto peak, maximum peak, minimum peak, sample, RMS | |
| Detectors | with option R&S® FSH-K3 installed | in addition average and quasi-peak | |
| Level measurement error | frequency > 1 MHz, at reference level down to -50 dB, 20 °C to 30 °C | <1.5 dB, typ. 0.5 dB | |

² As of serial number 100900 and firmware version 6.0 or higher.

| Specification | Condition | R&S® FSH3 | R&S® FSH6 |
|------------------------------------|--|--|--|
| Markers | | | |
| Number of markers or delta markers | | max. 6 | |
| Marker functions | | peak, next peak, minimum, center = marker frequency, reference level = marker level, all markers to peak | |
| Marker displays | | normal (level), noise marker, frequency counter (count) | |
| Trigger | | | |
| Audio demodulation | | free-running, video, external AM (video voltage without AGC) and FM | |
| Inputs | | | |
| RF input | | N female | |
| Input impedance | | 50 Ω | |
| VSWR | 10 MHz to 3 GHz | typ. 1.5 | typ. 1.5 |
| | 10 MHz to 6 GHz | | |
| Trigger/external reference input | | BNC female, selectable | |
| Trigger voltage | | TTL | |
| Reference frequency | | 10 MHz | |
| Required level | from 50 Ω | 10 dBm | |
| Outputs | | | |
| AF output | | 3.5 mm mini jack | |
| Output impedance | | 100 Ω | |
| Open-circuit voltage | | adjustable up to 1.5 V | |
| Tracking generator | only models 145.5850.13, 1145.5850.23 and 1145.5850.26 | | |
| Frequency range | | 5 MHz to 3 GHz | 5 MHz to 6 GHz |
| Output level | model 1145.5850.13 model 1145.5850.23 | -20 dBm (nominal) 0 dBm/-20 dBm, selectable | |
| | model 1145.5850.26 f < 3 GHz f > 3 GHz | | -10 dBm (nominal) -20 dBm (nominal) |
| Output impedance | | 50 Ω, nominal | |
| Interfaces | | | |
| RS-232-C optical interface | | | |
| Baud rate | | 1200, 2400, 9600, 19200, 38400, 57600, 115200 baud | |
| Power sensor | | 7-contact female connector (type Binder 712) | |

Accessories**Power Sensors R&S® FSH-Z1 and R&S® FSH-Z18**

| | | |
|--|---|--|
| Frequency range R&S® FSH-Z1 R&S® FSH-Z18 | | 10 MHz to 8 GHz 10 MHz to 18 GHz |
| VSWR 10 MHz to 30 MHz 30 MHz to 2.4 GHz 2.4 GHz to 8 GHz 8 GHz to 18 GHz | | <1.15 <1.13 <1.20 <1.25 |
| Maximum input power | average power peak power (<10 μ s, 1% duty cycle) | 400 mW (+26 dBm) 1 W (+30 dBm) |
| Measurement range | | 200 pW to 200 mW (-67 dBm to +23 dBm) |
| Signal weighting Effect of harmonics Effect of modulation | | average power <0.5 % (0.02 dB) at harmonic ratio of 20 dB <1.5 % (0.07 dB) for continuous digital modulation |
| Absolute measurement uncertainty 10 MHz to 8 GHz 8 GHz to 18 GHz | sine signals, no zero offset 15 °C to 35 °C 0 °C to 50 °C 15 °C to 35 °C 0 °C to 50 °C | <2.3 % (0.10 dB) <4.2 % (0.18 dB) <3.5 % (0.15 dB) <5.0 % (0.21 dB) |
| Zero offset after zeroing | | <110 pW |
| Dimensions | | 48 mm x 31 mm x 170 mm, connecting cable 1.5 m |
| Weight | | <0.3 kg |
| Directional Power Sensor R&S® FSH-Z14 | | |
| Frequency range | | 25 MHz to 1 GHz |
| Power measurement range | | 30 mW to 300 W |
| VSWR referenced to 50 Ω | | <1.06 |
| Power-handling capacity | depending on temperature and matching (see diagram below) | 100 W to 1000 W |
| Insertion loss | | <0.06 dB |
| Directivity | | >30 dB |
| Average power | | |
| Power measurement range CW, FM, PM, FSK, GMSK Modulated signals | | 30 mW to 300 W 30 mW to 300 W/CF |
| Measurement uncertainty 25 MHz to 40 MHz 40 MHz to 1 GHz | CF: ratio of peak envelope power to average power sine signal, 18 °C to 28 °C, no zero offset | 4.0 % of measured value (0.17 dB) 3.2 % of measured value (0.14 dB) |
| Zero offset | after zeroing | \pm 4 mW |

| | | |
|---|--|--|
| <p>Range of typical measurement error with modulation FM, PM, FSK, GMSK AM (80 %) 2 CW carriers with identical power EDGE, TETRA Temperature coefficient 25 MHz to 40 MHz 40 MHz to 1 GHz</p> | <p>*) if standard is selected on the R&S®FSH</p> | <p>0 % of measured value (0 dB) ±3 % of measured value (±0.13 dB) ±2 % of measured value (±0.09 dB) ±0.5 % of measured value (±0.02 dB) *) 0.40 %/K (0.017 dB/K) 0.25 %/K (0.011 dB/K)</p> |
| <p>Max. peak envelope power</p> | | |
| <p>Power measurement range Video bandwidth 4 kHz 200 kHz 600 kHz Measurement uncertainty Error limits of peak hold circuit for burst signals Duty cycle ≥ 0.1 and repetition rate ≥ 100/s 20/s ≤ repetition rate < 100/s 0.001 ≤ duty cycle < 0.1 Temperature coefficient 25 MHz to 40 MHz 40 MHz to 1 GHz</p> | <p>18 °C to 28 °C video bandwidth 4 kHz 200 kHz 600 kHz</p> | <p>0.4 W to 300 W 1 W to 300 W 2 W to 300 W same as for average power plus effect of peak hold circuit ±(3 % of measured value + 0.05 W) starting from a burst width of 200 µs ±(3 % of measured value + 0.20 W) starting from a burst width of 4 µs ±(7 % of measured value + 0.40 W) starting from a burst width of 2 µs plus ±(1.6 % of measured value + 0.15 W) plus ±0.10 W 0.50 %/K (0.022 dB/K) 0.35 %/K (0.015 dB/K)</p> |
| <p>Load matching</p> | | |
| <p>Matching measurement range Return loss VSWR Minimum forward power Error limits for matching measurements</p> | <p>specs met from 0.4 W</p> | <p>0 dB to 23 dB >1.15 0.06 W</p> |

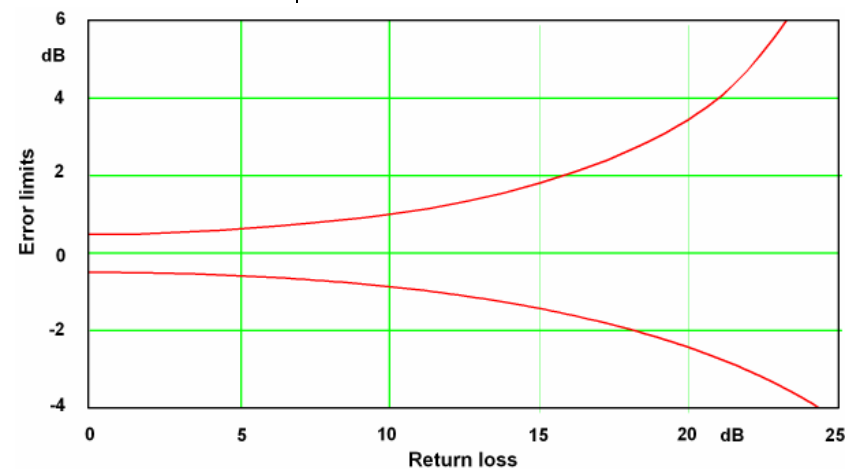

Power-handling capacity

Dimensions

Weight

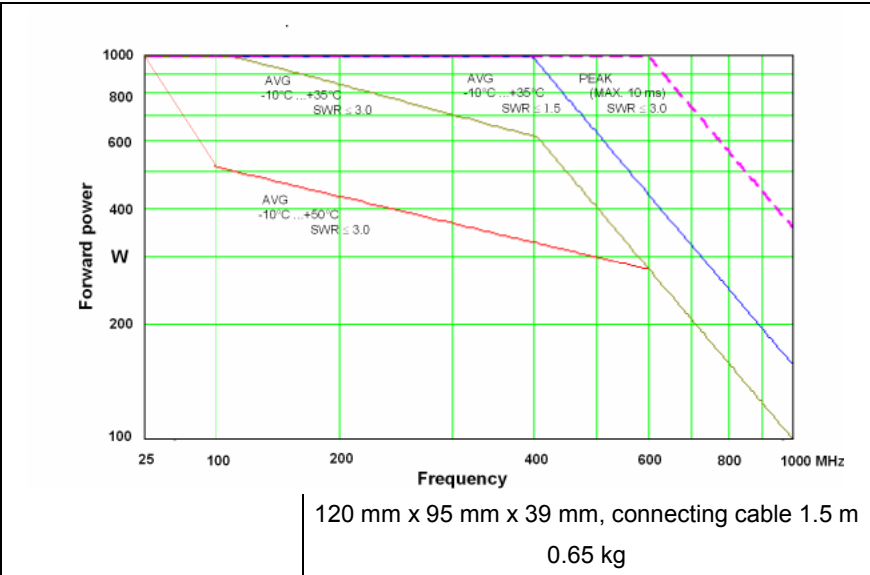

120 mm x 95 mm x 39 mm, connecting cable 1.5 m
0.65 kg

| Directional Power Sensor R&S® FSH-Z44 | | |
|--|---|--|
| Frequency range | | 200 MHz to 4 GHz |
| Power measurement range | | 30 mW to 300 W |
| VSWR referenced to 50 Ω | | |
| 200 MHz to 3 GHz | | <1.07 |
| 3 GHz to 4 GHz | | <1.12 |
| Power-handling capacity | depending on temperature and matching (see diagram below) | 120 W to 1000 W |
| Insertion loss | | |
| 200 MHz to 1.5 GHz | | <0.06 dB |
| 1.5 GHz to 4 GHz | | <0.09 dB |
| Directivity | | |
| 200 MHz to 3 GHz | | >30 dB |
| 3 GHz to 4 GHz | | >26 dB |
| Average power | | |
| Power measurement range | | 30 mW to 300 W |
| CW, FM, PM, FSK, GMSK | | 30 mW to 120 W |
| 3GPP WCDMA, cdmaOne, CDMA2000, DAB, DVB-T | | |
| Other modulated signals | CF: ratio of peak envelope power to average power | 30 mW to 300 W/CF |
| Measurement uncertainty | sine signal, 18 °C to 28 °C, no zero offset | |
| 200 MHz to 300 MHz | | 4.0 % of measured value (0.17 dB) |
| 300 MHz to 4 GHz | | 3.2 % of measured value (0.14 dB) |
| Zero offset | after zeroing | ±4 mW |
| Range of typical measurement error with modulation | | |
| FM, PM, FSK, GMSK | | 0 % of measured value (0 dB) |
| AM (80 %) | | ±3 % of measured value (±0.13 dB) |
| 2 CW carriers with identical power | | ±2 % of measured value (±0.09 dB) |
| π/4-DQPSK | | ±2 % of measured value (±0.09 dB) |
| EDGE | | ±0.5 % of measured value (±0.02 dB) *) |
| cdmaOne, DAB | | ±1 % of measured value (±0.04 dB) *) |
| 3GPP WCDMA, CDMA2000 | *) if standard is selected on the R&S®FSH | ±2 % of measured value (±0.09 dB) *) |
| DVB-T | | ±2 % of measured value (±0.09 dB) *) |
| Temperature coefficient | | |
| 200 MHz to 300 MHz | | 0.40 %/K (0.017 dB/K) |
| 300 MHz to 4 GHz | | 0.25 %/K (0.011 dB/K) |
| Max. peak envelope power | | |
| Power measurement range | | 4 W to 300 W |
| DAB, DVB-T, cdmaOne, CDMA2000, 3GPP WCDMA | | |
| Other signals at video bandwidth | | |
| 4 kHz | | 0.4 W to 300 W |
| 200 kHz | | 1 W to 300 W |
| 4 MHz | | 2 W to 300 W |

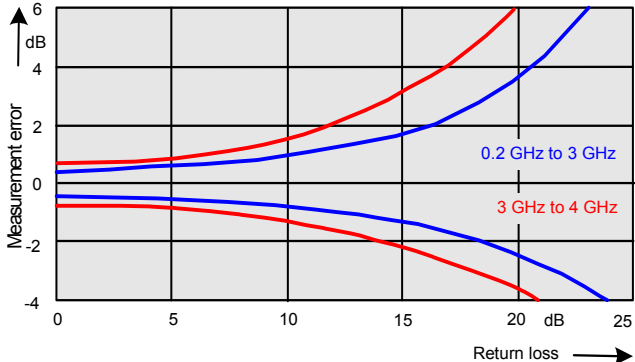
| | | |
|--|---|---|
| <p>Measurement uncertainty</p> <p>Error limits of peak hold circuit for burst signals Duty cycle ≥ 0.1 and repetition rate $\geq 100/s$</p> <p>$20/s \leq$ repetition rate $< 100/s$ $0.001 \leq$ duty cycle < 0.1 Burst width $\geq 0.5 \mu s$ Burst width $\geq 0.2 \mu s$</p> <p>Range of typical measurement error of peak hold circuit for cdmaOne, DAB DVB-T, CDMA2000, 3GPP WCDMA</p> <p>Temperature coefficient 200 MHz to 300 MHz 300 MHz to 4 GHz</p> | <p>18 °C to 28 °C</p> <p>video bandwidth 4 kHz 200 kHz 4 MHz</p> <p>video bandwidth 4 MHz and standard selected on the R&S®FSH</p> | <p>same as for average power plus effect of peak hold circuit</p> <p>$\pm(3\%$ of measured value + 0.05 W) starting from a burst width of 100 μs $\pm(3\%$ of measured value + 0.20 W) starting from a burst width of 4 μs $\pm(7\%$ of measured value + 0.40 W) starting from a burst width of 1 μs</p> <p>plus $\pm(1.6\%$ of measured value + 0.15 W) plus ± 0.10 W plus $\pm 5\%$ of measured value plus $\pm 10\%$ of measured value</p> <p>$\pm(5\%$ of measured value + 0.4 W) $\pm(15\%$ of measured value + 0.4 W)</p> <p>0.50 %/K (0.022 dB/K) 0.35 %/K (0.015 dB/K)</p> |
| <p>Load matching</p> | | |
| <p>Matching measurement range</p> <p>Return loss 200 MHz to 3 GHz 3 GHz to 4 GHz</p> <p>VSWR 200 MHz to 3 GHz 3 GHz to 4 GHz</p> <p>Minimum forward power</p> | <p>specs met from 0.2 W</p> | <p>0 dB to 23 dB 0 dB to 20 dB</p> <p>>1.15 >1.22</p> <p>0.03 W</p> |
| <p>Error limits for matching measurements</p> |  <p>The graph plots Measurement error in dB on the y-axis (ranging from -4 to 6) against Return loss in dB on the x-axis (ranging from 0 to 25). Two sets of curves are shown: blue for 0.2 GHz to 3 GHz and red for 3 GHz to 4 GHz. For both ranges, the error is near 0 dB at 0 dB return loss and increases as return loss increases. The 3 GHz to 4 GHz range (red) shows a much steeper increase in error compared to the 0.2 GHz to 3 GHz range (blue).</p> | |

Power-handling capacity

Dimensions

Weight

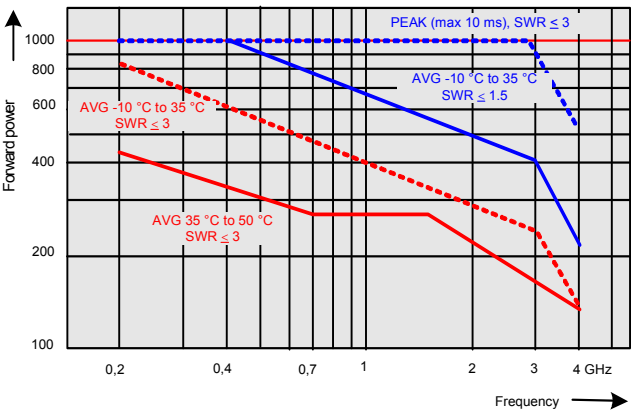

120 mm x 95 mm x 39 mm, connecting cable 1.5 m
0.65 kg

| VSWR Bridge R&S®FSH-Z2 / R&S®FSH-Z3 | | R&S®FSH-Z2 | R&S®FSH-Z3 |
|-------------------------------------|-------------------|-----------------------------------|--------------------------|
| Frequency range | | 10 MHz bis 3 GHz | 10 MHz bis 3 GHz |
| Impedance | | 50 Ω | |
| VSWR bridge | | | |
| Directivity | | | |
| 10 MHz to 30 MHz | | typ. 30 dB | typ. 16 dB |
| 30 MHz to 1 GHz | | typ. 30 dB | >20 dB, typ. 28 dB |
| 1 GHz to 3 GHz | | typ. 25 dB | >20 dB, typ. 28 dB |
| 3 GHz to 6 GHz | | - | >18 dB, typ. 25 dB |
| Directivity, corrected | option R&S®FSH-K2 | | |
| 2 MHz to 10 MHz | | typ. 40 dB | typ. 40 dB |
| 10 MHz to 3 GHz | | typ. 43 dB | typ. 40 dB |
| 3 GHz to 6 GHz | | - | typ. 37 dB |
| Return loss at test port | | | |
| 10 MHz to 50 MHz | | typ. 20 dB | >12 dB, typ. 18 dB |
| 50 MHz to 3 GHz | | typ. 20 dB | >16 dB, typ. 22 dB |
| 3 GHz to 6 GHz | | - | >16 dB, typ. 22 dB |
| Return loss at test port, corrected | option R&S®FSH-K2 | | |
| 2 MHz to 3 GHz | | typ. 35 dB | typ. 40 dB |
| 3 GHz to 6 GHz | | - | typ. 37 dB |
| Insertion loss | | | |
| Test port | | typ. 9 dB | typ. 9 dB |
| Bypass | | - | typ. 4 dB |
| DC bias | | | |
| Max. input voltage | | - | 50 V |
| Max. input current | | - | 300 mA |
| Type of connector | | - | BNC female |
| Connectors | | | |
| Generator input/RF output | | N male | |
| Test port | | N female | |
| Control interface | | 7-contact connector (type Binder) | |
| General data | | | |
| Power consumption | | - | 3 mW (nominal) |
| Dimensions (W x H x D) | | 169 mm x 116 mm x 30 mm | 149 mm x 144 mm x 45 mm |
| Weight | | 485 g | 620 g |
| Calibration standards | | | |
| Short/open | | R&S®FSH-Z29 | R&S®FSH-Z28 |
| 50 Ω load | | R&S®FSH-Z30/-Z31 | |
| Impedance | | | N male N male 50 Ω |

| | | | |
|---|-------------------------|--------------|---|
| Return loss DC to 3 GHz 3 GHz to 6 GHz | | > 43 dB - | > 40 dB, typ. 46 dB > 37 dB, typ. 43 dB |
| Power-handling capacity | | 1 W | 1W |
| Distance-to-Fault Measurement R&S® FSH-B1 (only with R&S® FSH3 models 1145.5850.13, 1145.5850.23 and R&S® FSH6 model 1145.5850.26) | | | |
| Display Maximum resolution, distance to fault Display range Return loss VSWR | maximum zoom | | 301 pixels cable length/1023 pixels 10, 5, 2, 1 dB/div, linear 1 to 2 and 1 to 6, with option R&S® FSH-K2 in addition 1 to 1.2 and 1 to 1.5 |
| Cable length Maximum permissible spurious signal | depending on cable loss | | 3 m to max. 1000 m 1st mixer 1 dB compression point typ. +10 dBm IF overload at reference level typ. + 8 dB |

| Specification | Condition | R&S® FSH3 | R&S® FSH6 |
|---|------------------------------------|--|-----------------|
| Transmission measurements (only with R&S® FSH3 models 1145.5850.13, 1145.5850.23 and R&S® FSH6 model 1145.5850.26) | | | |
| Frequency range | | 10 MHz to 3 GHz | 10 MHz to 6 GHz |
| Dynamic range 10 MHz to 2.2 GHz | scalar mode | typ. 60 dB | typ. 80 dB |
| | vector mode, option R&S® FSH-K2 | typ. 80 dB | typ. 90 dB |
| 2.2 GHz to 3 GHz | scalar mode | typ. 50 dB | typ. 70 dB |
| | vector mode, option R&S® FSH-K2 | typ. 65 dB | typ. 85 dB |
| 3 GHz to 5 GHz | scalar mode | | typ. 40 dB |
| | vector mode, option R&S® FSH-K2 | | typ. 55 dB |
| 5 GHz to 6 GHz | scalar mode | | typ. 35 dB |
| | vector mode, option R&S® FSH-K2 | | typ. 50 dB |
| Reflection measurements (only with R&S® FSH3 model 1145.5850.13 or 1145.5850.23, R&S® FSH6 model 1145.5850.26 and R&S® FSH-Z2) | | | |
| Frequency range | | 10 MHz to 3 GHz | 10 MHz to 3 GHz |
| Display range of return loss | | 10, 20, 50, 100 dB, selectable | |
| VSWR display range | | 1 to 2 and 1 to 6, selectable, with option R&S® FSH-K2 also 1 to 1.2 and 1 to 1.5 | |
| Measurement uncertainty | | see diagrams | |

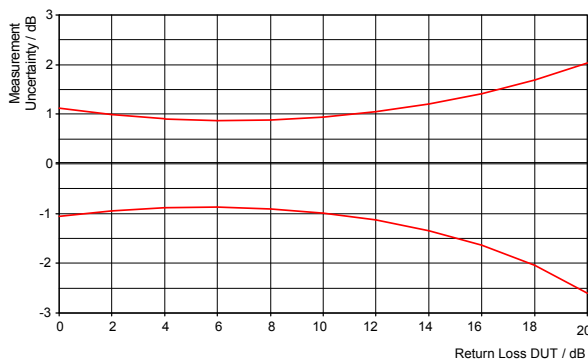

Measurement uncertainty with scalar measurements

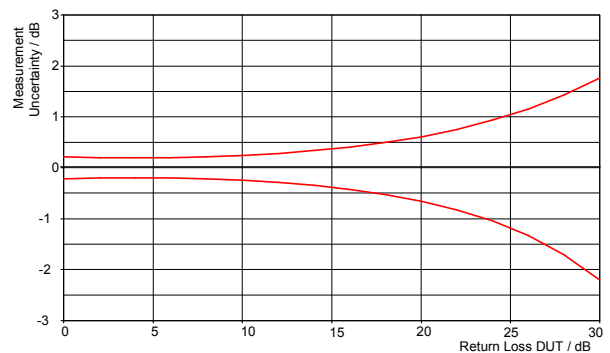

Measurement uncertainty with vector measurements (option R&S® FSH-K2)

| 3GPP FDD code domain power BTS/Node B measurement (only with R&S® FSH-K4 1300.7633.02) | | | |
|---|--|---|---|
| Frequency range | | 10 MHz to 3 GHz | - |
| Carrier frequency error | | (test case 6.3 in accordance with 3GPP 25.141) | - |
| Measurement range | | ±1 kHz | - |
| Measurement uncertainty | S/N > 30 dB | <50 Hz + $\Delta f_{ref}^{1)}$ ($\sigma = 20$ Hz) | - |
| Total power | S/N > 30 dB | (test case 6.2.1 in accordance with 3GPP 25.141) | - |
| Measurement range | frequency > 1 MHz 20 °C to 30 °C | -60 dBm < P_{total} < 20 dBm | - |
| Measurement uncertainty | -40 dBm < P_{total} < 20 dBm $P_{REF_LEV} - 30\text{dB} < P_{total} < P_{REF_LEV} + 3\text{dB}$ | ±1.5 dB, typ. 0.5 dB | - |
| CPICH power | S/N > 30 dB | (test case 6.2.2 in accordance with 3GPP 25.141) | - |
| Measurement range | -40 dBm < P_{total} < 20 dBm | $P_{total} - 20\text{ dB} < P_{CPICH} < P_{total}$ | - |
| Measurement uncertainty | - $P_{total} - 20\text{ dBm} < P_{CPICH} < P_{total}$ | ±1.5 dB, typ. 0.5 dB | - |
| P-CCPCH power | S/N > 30 dB | | - |
| Measurement range | -40 dBm < P_{total} < 20 dBm | $P_{total} - 40\text{ dB} < P_{PCCPCH} < P_{total}$ | - |
| Measurement uncertainty | $P_{total} - 20\text{ dBm} < P_{PCCPCH} < P_{total}$ | ±1.5 dB, typ. 0.5 dB | - |
| PSCH/SSCH power | S/N > 30 dB | | - |
| Measurement range | -40 dBm < P_{total} < 20 dBm | $P_{total} - 30\text{ dB} < P_{SCH} < P_{total}$ | - |
| Measurement uncertainty | $P_{total} - 20\text{ dBm} < P_{PSCH} < P_{total}$ | ±2.5 dB, typ. 1.5 dB | - |
| Symbol EVM | | | - |
| Measurement range | | 3% < EVM_{symbol} < 25% | - |
| Measurement uncertainty | 3% < EVM_{symbol} < 10% 10% < EVM_{symbol} < 20% | ±2.5% typ. ±3.0% typ. | - |
| Residual EVM_{symbol} | | 3% typ. | - |

¹⁾ Δf_{ref} = uncertainty of reference frequency.

General data

| | |
|---|---|
| Display | 14 cm (5.7") LC color display |
| Resolution | 320 x 240 pixels |
| Memory | CMOS RAM |
| Settings and traces | 100 |
| Environmental conditions | |
| Temperature | |
| Operating temperature range | |
| R&S® FSH powered from internal battery | 0 °C to 50 °C |
| R&S® FSH powered from AC power supply | 0 °C to 40 °C |
| Storage temperature range | -20 °C to +60 °C |
| Battery charging mode | 0 °C to 40 °C |
| Climatic conditions | |
| Relative humidity | 95 % at 40 °C (EN 60068) |
| IP class of protection | 51 |
| Mechanical resistance | |
| Vibration, sinusoidal | complies with EN 60068-2-1, EN61010-1 5 Hz to 55 Hz: max. 2 g, 55 Hz to 150 Hz: 0.5 g constant, 12 minutes per axis |
| Vibration, random | complies with EN60068-2-64 10 Hz to 500 Hz, 1.9 g, 30 minutes per axis |
| Shock | complies with EN 60068-2-27 40 g shock spectrum |
| RFI suppression | complies with EMC directive of EU (89/336/EEC) and German EMC legislation |
| Immunity to radiated interference | 10 V/m |
| Level display at 10 V/m (reference level ≤ -10 dBm) | |
| Input frequency | <-75 dBm (nominal) |
| IF | <-85 dBm (nominal) |
| Other frequencies | < displayed noise level |

Power supply

| | |
|---|--|
| AC supply | plug-in AC power supply (R&S® FSH-Z33) 100 V AC to 240 V AC, 50 Hz to 60 Hz, 400 mA |
| External DC voltage | 15 V to 20 V |
| Internal battery | NiMH battery (type Fluke BP190, R&S® FSH-Z32) |
| Battery voltage | 6 V to 9 V |
| Operating time with fully charged battery | 4 h with tracking generator off, 3 h with tracking generator on |
| Battery charging time | 4 h with instrument off |
| Lifetime | 300 to 500 charging cycles |
| Power consumption | typ. 7 W |
| Safety | complies with EN 61010-1, UL 3111-1, CSA C22.2 No. 1010-1 |
| Test mark | VDE, GS, CSA, CSA-NRTL |
| Dimensions (W x H x D) | 170 mm x 120 mm x 270 mm |
| Weight | 2.5 kg |

Order No.

| | |
|--|--------------|
| Handheld Spectrum Analyzer R&S®FSH3 100 kHz to 3 GHz, with preamplifier | 1145.5850.03 |
| Handheld Spectrum Analyzer R&S®FSH3 100 kHz to 3 GHz, with tracking generator | 1145.5850.13 |
| Handheld Spectrum Analyzer R&S®FSH3 100 kHz to 3 GHz, with tracking generator and preamplifier | 1145.5850.23 |
| Handheld Spectrum Analyzer R&S®FSH6 100 kHz to 6 GHz, with preamplifier | 1145.5850.06 |
| Handheld Spectrum Analyzer R&S®FSH6 100 kHz to 6 GHz, with tracking generator and preamplifier | 1145.5850.26 |

Accessories supplied

external power supply, battery pack (built-in),
RS-232-C optical cable, headphones, Quick Start manual,
CD-ROM with Control Software R&S®FSH View and
documentation

Options

| | Designation | Order No. |
|--|-------------|--------------|
| Distance-to-Fault Measurement for the R&S®FSH (includes 1 m cable, R&S®FSH-Z2 required) | R&S®FSH-B1 | 1145.5750.02 |
| Remote Control via RS-232-C for the R&S®FSH | R&S®FSH-K1 | 1157.3458.02 |
| Vector Transmission and Reflection Measurements for the R&S®FSH | R&S®FSH-K2 | 1157.3387.02 |
| Receiver Mode for the R&S®FSH | R&S®FSH-K3 | 1157.3429.02 |
| 3GPP FDD Code Domain Power BTS/Node B Measurement for the R&S®FSH3 model 23 | R&S®FSH-K4 | 1300.7633.02 |

Optional accessories

| | Designation | Order No. |
|---|-------------|--------------|
| Power Sensor for the R&S®FSH, 10 MHz to 8 GHz | R&S®FSH-Z1 | 1155.4505.02 |
| VSWR Bridge and Power Divider for the R&S®FSH, 10 MHz to 3 GHz (incl. calibration standards open, short, 50 Ω load) | R&S®FSH-Z2 | 1145.5767.02 |
| VSWR Bridge with DC Bias and Bypass Connector for the R&S®FSH, 10 MHz to 6 GHz (incl. calibration standards open, short, 50 Ω load) | R&S®FSH-Z3 | 1300.7756.02 |
| Directional Power Sensor for the R&S®FSH, 25 MHz to 1 GHz | R&S®FSH-Z14 | 1120.6001.02 |
| Power Sensor for the R&S®FSH, 10 MHz to 18 GHz | R&S®FSH-Z18 | 1165.1909.02 |
| Directional Power Sensor for the R&S®FSH, 200 MHz to 4 GHz | R&S®FSH-Z44 | 1165.2305.02 |
| Matching Pad, 50/75 Ω, 0 Hz to 2700 MHz | R&S®RAZ | 0358.5714.02 |
| Spare RF Cable (1 m), connectors N male/N female for R&S®FSH-B1 | R&S®FSH-Z20 | 1145.5867.02 |

| | | |
|--|-------------|--------------|
| 12 V Car Adapter for the R&S®FSH | R&S®FSH-Z21 | 1145.5873.02 |
| Serial/Parallel Converter for the R&S®FSH | R&S®FSH-Z22 | 1145.5880.02 |
| Carrying Bag for the R&S®FSH | R&S®FSH-Z25 | 1145.5896.02 |
| Transit Case for the R&S®FSH | R&S®FSH-Z26 | 1300.7627.00 |
| Spare Combined Short/Open and 50 Ω Load for VSWR and DTF calibration, DC to 6 GHz | R&S®FSH-Z28 | 1300.7804.02 |
| Combined Short/Open and 50 Ω Load for VSWR and DTF calibration, DC to 3 GHz | R&S®FSH-Z29 | 1300.7504.02 |
| Spare Short/Open Calibration Standard for R&S®FSH-Z2 for VSWR calibration, DC to 3 GHz | R&S®FSH-Z30 | 1145.5773.02 |
| Spare 50 Ω Load Standard for R&S®FSH-Z2 for VSWR and DTF calibration, DC to 3 GHz | R&S®FSH-Z31 | 1145.5780.02 |
| Spare Battery Pack for the R&S®FSH | R&S®FSH-Z32 | 1145.5796.02 |
| Spare AC Power Supply for the R&S®FSH | R&S®FSH-Z33 | 1145.5809.02 |
| Spare RS-232-C Optical Cable | R&S®FSH-Z34 | 1145.5815.02 |
| Spare CD-ROM with Control Software R&S®FSH View and documentation | R&S®FSH-Z35 | 1145.5821.02 |
| Spare Headphones | R&S®FSH-Z36 | 1145.5838.02 |
| Active Directional Antenna | R&S®HE-200 | 4050.3509.02 |
| Spare USB Optical Cable | R&S®FSH-Z37 | 1300.7733.02 |
| Portable EMF Measurement System, 30 MHz to 3 GHz, for the Handheld Spectrum Analyzer R&S®FSH | R&S®TS-EMF | 1158.9295.13 |
| Near-Field Probe Set | R&S®HZ-15 | 1147.2736.02 |
| Preamplifier for the R&S®HZ-15 | R&S®HZ-16 | 1147.2720.02 |



Before putting the product into operation for the first time, make sure to read the following



Safety Instructions

Rohde & Schwarz makes every effort to keep the safety standard of its products up to date and to offer its customers the highest possible degree of safety. Our products and the auxiliary equipment required for them are designed and tested in accordance with the relevant safety standards. Compliance with these standards is continuously monitored by our quality assurance system. This product has been designed and tested in accordance with the EC Certificate of Conformity and has left the manufacturer's plant in a condition fully complying with safety standards. To maintain this condition and to ensure safe operation, observe all instructions and warnings provided in this manual. If you have any questions regarding these safety instructions, Rohde & Schwarz will be happy to answer them.

Furthermore, it is your responsibility to use the product in an appropriate manner. This product is designed for use solely in industrial and laboratory environments or in the field and must not be used in any way that may cause personal injury or property damage. You are responsible if the product is used for an intention other than its designated purpose or in disregard of the manufacturer's instructions. The manufacturer shall assume no responsibility for such use of the product.

The product is used for its designated purpose if it is used in accordance with its operating manual and within its performance limits (see data sheet, documentation, the following safety instructions). Using the products requires technical skills and knowledge of English. It is therefore essential that the products be used exclusively by skilled and specialized staff or thoroughly trained personnel with the required skills. If personal safety gear is required for using Rohde & Schwarz products, this will be indicated at the appropriate place in the product documentation.

Symbols and safety labels

| | | | | | | | |
|--------------------------------|------------------------------------|--------------------------|----------------------|-------------|--------|-----------------|--|
| | | | | | | | |
| Observe operating instructions | Weight indication for units >18 kg | Danger of electric shock | Warning! Hot surface | PE terminal | Ground | Ground terminal | Attention! Electrostatic sensitive devices |

| | | | | | |
|-----------------------|--------------------|---------------------|--------------------------|------------------------------------|--|
| | | | | | |
| Supply voltage ON/OFF | Standby indication | Direct current (DC) | Alternating current (AC) | Direct/alternating current (DC/AC) | Device fully protected by double/reinforced insulation |

Safety Instructions

Observing the safety instructions will help prevent personal injury or damage of any kind caused by dangerous situations. Therefore, carefully read through and adhere to the following safety instructions before putting the product into operation. It is also absolutely essential to observe the additional safety instructions on personal safety that appear in other parts of the documentation. In these safety instructions, the word "product" refers to all merchandise sold and distributed by Rohde & Schwarz, including instruments, systems and all accessories.

Tags and their meaning

| | |
|-----------|--|
| DANGER | This tag indicates a safety hazard with a high potential of risk for the user that can result in death or serious injuries. |
| WARNING | This tag indicates a safety hazard with a medium potential of risk for the user that can result in death or serious injuries. |
| CAUTION | This tag indicates a safety hazard with a low potential of risk for the user that can result in slight or minor injuries. |
| ATTENTION | This tag indicates the possibility of incorrect use that can cause damage to the product. |
| NOTE | This tag indicates a situation where the user should pay special attention to operating the product but which does not lead to damage. |

These tags are in accordance with the standard definition for civil applications in the European Economic Area. Definitions that deviate from the standard definition may also exist. It is therefore essential to make sure that the tags described here are always used only in connection with the associated documentation and the associated product. The use of tags in connection with unassociated products or unassociated documentation can result in misinterpretations and thus contribute to personal injury or material damage.

Basic safety instructions

1. The product may be operated only under the operating conditions and in the positions specified by the manufacturer. Its ventilation must not be obstructed during operation. Unless otherwise specified, the following requirements apply to Rohde & Schwarz products:
prescribed operating position is always with the housing floor facing down, IP protection 2X, pollution severity 2, overvoltage category 2, use only in enclosed spaces, max. operation altitude max. 2000 m. Unless specified otherwise in the data sheet, a tolerance of $\pm 10\%$ shall apply to the nominal voltage and of $\pm 5\%$ to the nominal frequency.
2. Applicable local or national safety regulations and rules for the prevention of accidents must be observed in all work performed. The product may be opened only by authorized, specially trained personnel. Prior to performing any work on the product or opening the product, the product must be disconnected from the supply network. Any adjustments, replacements of parts, maintenance or repair must be carried out only by technical personnel authorized by Rohde & Schwarz. Only original parts may be used for replacing parts relevant to safety (e.g. power switches, power transformers, fuses). A safety test must always be performed after parts relevant to safety have been replaced (visual inspection, PE conductor test, insulation resistance measurement, leakage current measurement, functional test).
3. As with all industrially manufactured goods, the use of substances that induce an allergic reaction (allergens, e.g. nickel) such as aluminum cannot be generally excluded. If you develop an allergic reaction (such as a skin rash, frequent sneezing, red eyes or respiratory difficulties), consult a physician immediately to determine the cause.

Safety Instructions

4. If products/components are mechanically and/or thermally processed in a manner that goes beyond their intended use, hazardous substances (heavy-metal dust such as lead, beryllium, nickel) may be released. For this reason, the product may only be disassembled, e.g. for disposal purposes, by specially trained personnel. Improper disassembly may be hazardous to your health. National waste disposal regulations must be observed.
5. If handling the product yields hazardous substances or fuels that must be disposed of in a special way, e.g. coolants or engine oils that must be replenished regularly, the safety instructions of the manufacturer of the hazardous substances or fuels and the applicable regional waste disposal regulations must be observed. Also observe the relevant safety instructions in the product documentation.
6. Depending on the function, certain products such as RF radio equipment can produce an elevated level of electromagnetic radiation. Considering that unborn life requires increased protection, pregnant women should be protected by appropriate measures. Persons with pacemakers may also be endangered by electromagnetic radiation. The employer is required to assess workplaces where there is a special risk of exposure to radiation and, if necessary, take measures to avert the danger.
7. Operating the products requires special training and intense concentration. Make certain that persons who use the products are physically, mentally and emotionally fit enough to handle operating the products; otherwise injuries or material damage may occur. It is the responsibility of the employer to select suitable personnel for operating the products.
8. Prior to switching on the product, it must be ensured that the nominal voltage setting on the product matches the nominal voltage of the AC supply network. If a different voltage is to be set, the power fuse of the product may have to be changed accordingly.
9. In the case of products of safety class I with movable power cord and connector, operation is permitted only on sockets with earthing contact and protective earth connection.
10. Intentionally breaking the protective earth connection either in the feed line or in the product itself is not permitted. Doing so can result in the danger of an electric shock from the product. If extension cords or connector strips are implemented, they must be checked on a regular basis to ensure that they are safe to use.
11. If the product has no power switch for disconnection from the AC supply, the plug of the connecting cable is regarded as the disconnecting device. In such cases, it must be ensured that the power plug is easily reachable and accessible at all times (length of connecting cable approx. 2 m). Functional or electronic switches are not suitable for providing disconnection from the AC supply. If products without power switches are integrated in racks or systems, a disconnecting device must be provided at the system level.
12. Never use the product if the power cable is damaged. By taking appropriate safety measures and carefully laying the power cable, ensure that the cable cannot be damaged and that no one can be hurt by e.g. tripping over the cable or suffering an electric shock.
13. The product may be operated only from TN/TT supply networks fused with max. 16 A.
14. Do not insert the plug into sockets that are dusty or dirty. Insert the plug firmly and all the way into the socket. Otherwise this can result in sparks, fire and/or injuries.
15. Do not overload any sockets, extension cords or connector strips; doing so can cause fire or electric shocks.
16. For measurements in circuits with voltages $V_{rms} > 30 V$, suitable measures (e.g. appropriate measuring equipment, fusing, current limiting, electrical separation, insulation) should be taken to avoid any hazards.
17. Ensure that the connections with information technology equipment comply with IEC 950/EN 60950.
18. Never remove the cover or part of the housing while you are operating the product. This will expose circuits and components and can lead to injuries, fire or damage to the product.

Safety Instructions

19. If a product is to be permanently installed, the connection between the PE terminal on site and the product's PE conductor must be made first before any other connection is made. The product may be installed and connected only by a skilled electrician.
20. For permanently installed equipment without built-in fuses, circuit breakers or similar protective devices, the supply circuit must be fused in such a way that suitable protection is provided for users and products.
21. Do not insert any objects into the openings in the housing that are not designed for this purpose. Never pour any liquids onto or into the housing. This can cause short circuits inside the product and/or electric shocks, fire or injuries.
22. Use suitable overvoltage protection to ensure that no overvoltage (such as that caused by a thunderstorm) can reach the product. Otherwise the operating personnel will be endangered by electric shocks.
23. Rohde & Schwarz products are not protected against penetration of water, unless otherwise specified (see also safety instruction 1.). If this is not taken into account, there exists the danger of electric shock or damage to the product, which can also lead to personal injury.
24. Never use the product under conditions in which condensation has formed or can form in or on the product, e.g. if the product was moved from a cold to a warm environment.
25. Do not close any slots or openings on the product, since they are necessary for ventilation and prevent the product from overheating. Do not place the product on soft surfaces such as sofas or rugs or inside a closed housing, unless this is well ventilated.
26. Do not place the product on heat-generating devices such as radiators or fan heaters. The temperature of the environment must not exceed the maximum temperature specified in the data sheet.
27. Batteries and storage batteries must not be exposed to high temperatures or fire. Keep batteries and storage batteries away from children. If batteries or storage batteries are improperly replaced, this can cause an explosion (warning: lithium cells). Replace the battery or storage battery only with the matching Rohde & Schwarz type (see spare parts list). Batteries and storage batteries are hazardous waste. Dispose of them only in specially marked containers. Observe local regulations regarding waste disposal. Do not short-circuit batteries or storage batteries.
28. Please be aware that in the event of a fire, toxic substances (gases, liquids etc.) that may be hazardous to your health may escape from the product.
29. Please be aware of the weight of the product. Be careful when moving it; otherwise you may injure your back or other parts of your body.
30. Do not place the product on surfaces, vehicles, cabinets or tables that for reasons of weight or stability are unsuitable for this purpose. Always follow the manufacturer's installation instructions when installing the product and fastening it to objects or structures (e.g. walls and shelves).
31. Handles on the products are designed exclusively for personnel to hold or carry the product. It is therefore not permissible to use handles for fastening the product to or on means of transport such as cranes, fork lifts, wagons, etc. The user is responsible for securely fastening the products to or on the means of transport and for observing the safety regulations of the manufacturer of the means of transport. Noncompliance can result in personal injury or material damage.
32. If you use the product in a vehicle, it is the sole responsibility of the driver to drive the vehicle safely. Adequately secure the product in the vehicle to prevent injuries or other damage in the event of an accident. Never use the product in a moving vehicle if doing so could distract the driver of the vehicle. The driver is always responsible for the safety of the vehicle; the manufacturer assumes no responsibility for accidents or collisions.
33. If a laser product (e.g. a CD/DVD drive) is integrated in a Rohde & Schwarz product, do not use any other settings or functions than those described in the documentation. Otherwise this may be hazardous to your health, since the laser beam can cause irreversible damage to your eyes. Never try to take such products apart, and never look into the laser beam.



Por favor lea imprescindiblemente antes de la primera puesta en funcionamiento las siguientes informaciones de seguridad



Informaciones de seguridad

Es el principio de Rohde & Schwarz de tener a sus productos siempre al día con los estándares de seguridad y de ofrecer a sus clientes el máximo grado de seguridad. Nuestros productos y todos los equipos adicionales son siempre fabricados y examinados según las normas de seguridad vigentes. Nuestra sección de gestión de la seguridad de calidad controla constantemente que sean cumplidas estas normas. Este producto ha sido fabricado y examinado según el comprobante de conformidad adjunto según las normas de la CE y ha salido de nuestra planta en estado impecable según los estándares técnicos de seguridad. Para poder preservar este estado y garantizar un funcionamiento libre de peligros, deberá el usuario atenerse a todas las informaciones, informaciones de seguridad y notas de alerta. Rohde&Schwarz está siempre a su disposición en caso de que tengan preguntas referentes a estas informaciones de seguridad.

Además queda en la responsabilidad del usuario utilizar el producto en la forma debida. Este producto solamente fue elaborado para ser utilizado en la industria y el laboratorio o para fines de campo y de ninguna manera deberá ser utilizado de modo que alguna persona/cosa pueda ser dañada. El uso del producto fuera de sus fines definidos o despreciando las informaciones de seguridad del fabricante queda en la responsabilidad del usuario. El fabricante no se hace en ninguna forma responsable de consecuencias a causa del maluso del producto.

Se parte del uso correcto del producto para los fines definidos si el producto es utilizado dentro de las instrucciones del correspondiente manual del uso y dentro del margen de rendimiento definido (ver hoja de datos, documentación, informaciones de seguridad que siguen). El uso de los productos hace necesarios conocimientos profundos y el conocimiento del idioma inglés. Por eso se deberá tener en cuenta de exclusivamente autorizar para el uso de los productos a personas peritas o debidamente minuciosamente instruidas con los conocimientos citados. Si fuera necesaria indumentaria de seguridad para el uso de productos de R&S, encontrará la información debida en la documentación del producto en el capítulo correspondiente.

Símbolos y definiciones de seguridad

| | | | | | | | |
|-------------------------------------|---|-------------------------------|-----------------------------------|--------------------------------|-------------------|----------------------------|---|
| | | | | | | | |
| Ver manual de instrucciones del uso | Informaciones para maquinaria con un peso de > 18kg | Peligro de golpe de corriente | ¡Advertencia! Superficie caliente | Conexión a conductor protector | Conexión a tierra | Conexión a masa conductora | ¡Cuidado! Elementos de construcción con peligro de carga electrostática |

| | | | | | |
|---------------------------|---------------------|-----------------------|----------------------|----------------------------------|--|
| | | | | | |
| potencia EN MARCHA/PARADA | Indicación Stand-by | Corriente continua DC | Corriente alterna AC | Corriente continua/alterna DC/AC | El aparato está protegido en su totalidad por un aislamiento de doble refuerzo |

Informaciones de seguridad

Tener en cuenta las informaciones de seguridad sirve para tratar de evitar daños y peligros de toda clase. Es necesario de que se lean las siguientes informaciones de seguridad concienzudamente y se tengan en cuenta debidamente antes de la puesta en funcionamiento del producto. También deberán ser tenidas en cuenta las informaciones para la protección de personas que encontrarán en otro capítulo de esta documentación y que también son obligatorias de seguir. En las informaciones de seguridad actuales hemos juntado todos los objetos vendidos por Rohde&Schwarz bajo la denominación de „producto“, entre ellos también aparatos, instalaciones así como toda clase de accesorios.

Palabras de señal y su significado

| | |
|-------------|--|
| PELIGRO | Indica un punto de peligro con gran potencial de riesgo para el usuario. Punto de peligro que puede llevar hasta la muerte o graves heridas. |
| ADVERTENCIA | Indica un punto de peligro con un potencial de riesgo mediano para el usuario. Punto de peligro que puede llevar hasta la muerte o graves heridas . |
| ATENCIÓN | Indica un punto de peligro con un potencial de riesgo pequeño para el usuario. Punto de peligro que puede llevar hasta heridas leves o pequeñas |
| CUIDADO | Indica la posibilidad de utilizar mal el producto y a consecuencia dañarlo. |
| INFORMACIÓN | Indica una situación en la que deberían seguirse las instrucciones en el uso del producto, pero que no consecuentemente deben de llevar a un daño del mismo. |

Las palabras de señal corresponden a la definición habitual para aplicaciones civiles en el ámbito de la comunidad económica europea. Pueden existir definiciones diferentes a esta definición. Por eso se debiera tener en cuenta que las palabras de señal aquí descritas sean utilizadas siempre solamente en combinación con la correspondiente documentación y solamente en combinación con el producto correspondiente. La utilización de las palabras de señal en combinación con productos o documentaciones que no les correspondan puede llevar a malinterpretaciones y tener por consecuencia daños en personas u objetos.

Informaciones de seguridad elementales

1. El producto solamente debe ser utilizado según lo indicado por el fabricante referente a la situación y posición de funcionamiento sin que se obstruya la ventilación. Si no se convino de otra manera, es para los productos R&S válido lo que sigue: como posición de funcionamiento se define principalmente la posición con el suelo de la caja para abajo , modo de protección IP 2X, grado de suciedad 2, categoría de sobrecarga eléctrica 2, utilizar solamente en estancias interiores, utilización hasta 2000 m sobre el nivel del mar.
A menos que se especifique otra cosa en la hoja de datos, se aplicará una tolerancia de $\pm 10\%$ sobre el voltaje nominal y de $\pm 5\%$ sobre la frecuencia nominal.
2. En todos los trabajos deberán ser tenidas en cuenta las normas locales de seguridad de trabajo y de prevención de accidentes. El producto solamente debe de ser abierto por personal périto autorizado. Antes de efectuar trabajos en el producto o abrirlo deberá este ser desconectado de la corriente. El ajuste, el cambio de partes, la manutención y la reparación deberán ser solamente efectuadas por electricistas autorizados por R&S. Si se reponen partes con importancia para los aspectos de seguridad (por ejemplo el enchufe, los transformadores o los fusibles), solamente podrán ser sustituidos por partes originales. Despues de cada recambio de partes elementales para la seguridad deberá ser efectuado un control de

Informaciones de seguridad

- seguridad (control a primera vista, control de conductor protector, medición de resistencia de aislamiento, medición de medición de la corriente conductora, control de funcionamiento).
3. Como en todo producto de fabricación industrial no puede ser excluido en general de que se produzcan al usarlo elementos que puedan generar alergias, los llamados elementos alergénicos (por ejemplo el níquel). Si se produjeran en el trato con productos R&S reacciones alérgicas, como por ejemplo urticaria, estornudos frecuentes, irritación de la conjuntiva o dificultades al respirar, se deberá consultar inmediatamente a un médico para averiguar los motivos de estas reacciones.
 4. Si productos / elementos de construcción son tratados fuera del funcionamiento definido de forma mecánica o térmica, pueden generarse elementos peligrosos (polvos de sustancia de metales pesados como por ejemplo plomo, berilio, níquel). La partición elemental del producto, como por ejemplo sucede en el tratamiento de materias residuales, debe de ser efectuada solamente por personal especializado para estos tratamientos. La partición elemental efectuada inadecuadamente puede generar daños para la salud. Se deben tener en cuenta las directivas nacionales referentes al tratamiento de materias residuales.
 5. En el caso de que se produjeran agentes de peligro o combustibles en la aplicación del producto que debieran de ser transferidos a un tratamiento de materias residuales, como por ejemplo agentes refrigerantes que deben ser repuestos en periodos definidos, o aceites para motores, deberán ser tenidas en cuenta las prescripciones de seguridad del fabricante de estos agentes de peligro o combustibles y las regulaciones regionales para el tratamiento de materias residuales. Cuiden también de tener en cuenta en caso dado las prescripciones de seguridad especiales en la descripción del producto.
 6. Ciertos productos, como por ejemplo las instalaciones de radiación HF, pueden a causa de su función natural, emitir una radiación electromagnética aumentada. En vista a la protección de la vida en desarrollo deberían ser protegidas personas embarazadas debidamente. También las personas con un bypass pueden correr peligro a causa de la radiación electromagnética. El empresario está comprometido a valorar y señalar áreas de trabajo en las que se corra un riesgo de exposición a radiaciones aumentadas de riesgo aumentado para evitar riesgos.
 7. La utilización de los productos requiere instrucciones especiales y una alta concentración en el manejo. Debe de ponerse por seguro de que las personas que manejen los productos estén a la altura de los requerimientos necesarios referente a sus aptitudes físicas, psíquicas y emocionales, ya que de otra manera no se pueden excluir lesiones o daños de objetos. El empresario lleva la responsabilidad de seleccionar el personal usuario apto para el manejo de los productos.
 8. Antes de la puesta en marcha del producto se deberá tener por seguro de que la tensión preseleccionada en el producto equivalga a la del la red de distribución. Si es necesario cambiar la preselección de la tensión también se deberán en caso dabo cambiar los fusibles correspondientes del producto.
 9. Productos de la clase de seguridad I con alimentación móvil y enchufe individual de producto solamente deberán ser conectados para el funcionamiento a tomas de corriente de contacto de seguridad y con conductor protector conectado.
 10. Queda prohibida toda clase de interrupción intencionada del conductor protector, tanto en la toma de corriente como en el mismo producto ya que puede tener como consecuencia el peligro de golpe de corriente por el producto. Si se utilizaran cables o enchufes de extensión se deberá poner al seguro, que es controlado su estado técnico de seguridad.
 11. Si el producto no está equipado con un interruptor para desconectarlo de la red, se deberá considerar el enchufe del cable de distribución como interruptor. En estos casos deberá asegurar de que el enchufe sea de fácil acceso y nabejo (medida del cable de distribución aproximadamente 2 m). Los interruptores de función o electrónicos no son aptos para el corte de la red eléctrica. Si los productos sin interruptor están integrados en construcciones o instalaciones, se deberá instalar el interruptor al nivel de la instalación.

Informaciones de seguridad

12. No utilice nunca el producto si está dañado el cable eléctrico. Asegure a través de las medidas de protección y de instalación adecuadas de que el cable de eléctrico no pueda ser dañado o de que nadie pueda ser dañado por él, por ejemplo al tropezar o por un golpe de corriente.
13. Solamente está permitido el funcionamiento en redes de distribución TN/TT aseguradas con fusibles de como máximo 16 A.
14. Nunca conecte el enchufe en tomas de corriente sucias o llenas de polvo. Introduzca el enchufe por completo y fuertemente en la toma de corriente. Si no tiene en consideración estas indicaciones se arriesga a que se originen chispas, fuego y/o heridas.
15. No sobrecargue las tomas de corriente, los cables de extensión o los enchufes de extensión ya que esto pudiera causar fuego o golpes de corriente.
16. En las mediciones en circuitos de corriente con una tensión de entrada de $U_{eff} > 30 \text{ V}$ se deberá tomar las precauciones debidas para impedir cualquier peligro (por ejemplo medios de medición adecuados, seguros, limitación de tensión, corte protector, aislamiento etc.).
17. En caso de conexión con aparatos de la técnica informática se deberá tener en cuenta que estos cumplan los requisitos de la EC950/EN60950.
18. Nunca abra la tapa o parte de ella si el producto está en funcionamiento. Esto pone a descubierto los cables y componentes eléctricos y puede causar heridas, fuego o daños en el producto.
19. Si un producto es instalado fijamente en un lugar, se deberá primero conectar el conductor protector fijo con el conductor protector del aparato antes de hacer cualquier otra conexión. La instalación y la conexión deberán ser efectuadas por un electricista especializado.
20. En caso de que los productos que son instalados fijamente en un lugar sean sin protector implementado, autointerruptor o similares objetos de protección, deberá la toma de corriente estar protegida de manera que los productos o los usuarios estén suficientemente protegidos.
21. Por favor, no introduzca ningún objeto que no esté destinado a ello en los orificios de la caja del aparato. No vierta nunca ninguna clase de líquidos sobre o en la caja. Esto puede producir corto circuitos en el producto y/o puede causar golpes de corriente, fuego o heridas.
22. Asegúrese con la protección adecuada de que no pueda originarse en el producto una sobrecarga por ejemplo a causa de una tormenta. Si no se verá el personal que lo utilice expuesto al peligro de un golpe de corriente.
23. Los productos R&S no están protegidos contra el agua si no es que exista otra indicación, ver también punto 1. Si no se tiene en cuenta esto se arriesga el peligro de golpe de corriente o de daños en el producto lo cual también puede llevar al peligro de personas.
24. No utilice el producto bajo condiciones en las que pueda producirse y se hayan producido líquidos de condensación en o dentro del producto como por ejemplo cuando se desplaza el producto de un lugar frío a un lugar caliente.
25. Por favor no cierre ninguna ranura u orificio del producto, ya que estas son necesarias para la ventilación e impiden que el producto se caliente demasiado. No pongan el producto encima de materiales blandos como por ejemplo sofás o alfombras o dentro de una caja cerrada, si esta no está suficientemente ventilada.
26. No ponga el producto sobre aparatos que produzcan calor, como por ejemplo radiadores o calentadores. La temperatura ambiental no debe superar la temperatura máxima especificada en la hoja de datos.

Informaciones de seguridad

27. Baterías y acumuladores no deben de ser expuestos a temperaturas altas o al fuego. Guardar baterías y acumuladores fuera del alcance de los niños. Si las baterías o los acumuladores no son cambiados con la debida atención existirá peligro de explosión (atención celulas de Litio). Cambiar las baterías o los acumuladores solamente por los del tipo R&S correspondiente (ver lista de piezas de recambio). Baterías y acumuladores son deshechos problemáticos. Por favor tirenlos en los recipientes especiales para este fin. Por favor tengan en cuenta las prescripciones nacionales de cada país referente al tratamiento de deshechos. Nunca sometan las baterías o acumuladores a un corto circuito.
28. Tengan en consideración de que en caso de un incendio pueden escaparse gases tóxicos del producto, que pueden causar daños a la salud.
29. Por favor tengan en cuenta que en caso de un incendio pueden desprenderse del producto agentes venenosos (gases, líquidos etc.) que pueden generar daños a la salud.
30. No sitúe el producto encima de superficies, vehículos, estantes o mesas, que por sus características de peso o de estabilidad no sean aptas para él. Siga siempre las instrucciones de instalación del fabricante cuando instale y asegure el producto en objetos o estructuras (por ejemplo paredes y estantes).
31. Las asas instaladas en los productos sirven solamente de ayuda para el manejo que solamente está previsto para personas. Por eso no está permitido utilizar las asas para la sujecion en o sobre medios de transporte como por ejemplo grúas, carretillas elevadoras de horquilla, carros etc. El usuario es responsable de que los productos sean sujetados de forma segura a los medios de transporte y de que las prescripciones de seguridad del fabricante de los medios de transporte sean tenidas en cuenta. En caso de que no se tengan en cuenta pueden causarse daños en personas y objetos.
32. Si llega a utilizar el producto dentro de un vehículo, queda en la responsabilidad absoluta del conductor que conducir el vehículo de manera segura. Asegure el producto dentro del vehículo debidamente para evitar en caso de un accidente las lesiones u otra clase de daños. No utilice nunca el producto dentro de un vehículo en movimiento si esto pudiera distraer al conductor. Siempre queda en la responsabilidad absoluta del conductor la seguridad del vehículo y el fabricante no asumirá ninguna clase de responsabilidad por accidentes o colisiones.
33. Dado el caso de que esté integrado un producto de laser en un producto R&S (por ejemplo CD/DVD-ROM) no utilice otras instalaciones o funciones que las descritas en la documentación. De otra manera pondrá en peligro su salud, ya que el rayo laser puede dañar irreversiblemente sus ojos. Nunca trate de descomponer estos productos. Nunca mire dentro del rayo laser.

Certificate of quality

Dear Customer,

You have decided to buy a Rohde & Schwarz product.

You are thus assured of receiving a product that is manufactured using the most modern methods available. This product was developed, manufactured and tested in compliance with our quality management system standards. The Rohde & Schwarz quality management system is certified according to ISO 9001.

Certified Quality System
ISO 9001
DQS REG. NO 1954-04



Certificate No.: 2002-41

This is to certify that:

| Equipment type | Stock No. | Designation |
|----------------|----------------------|------------------------------|
| FSH3 | 1145.5850.03/.13/.23 | Handheld Spectrum Analyzer |
| FSH6 | 1145.5850.06/.26 | |
| FSH-Z1 | 1155.4505.02 | Average Power Sensor |
| FSH-Z18 | 1165.1909.02 | Average Power Sensor |
| FSH-Z2 | 1145.5767.02 | VSWR Bridge and Power Driver |
| FSH-Z32 | 1145.5796.02 | Spare Batterie Pack |
| FSH-Z33 | 1145.5809.02 | Spare Power Supply |
| FSH-Z44 | 1165.2305.02 | Directional Power Sensor |

complies with the provisions of the Directive of the Council of the European Union on the approximation of the laws of the Member States

- relating to electrical equipment for use within defined voltage limits
(73/23/EEC revised by 93/68/EEC)
- relating to electromagnetic compatibility
(89/336/EEC revised by 91/263/EEC, 92/31/EEC, 93/68/EEC)

Conformity is proven by compliance with the following standards:

EN61010-1 : 2001-12
EN55011 : 1998 + A1 : 1999, Klasse B
EN61326 : 1997 + A1 : 1998 + A2 : 2001

For the assessment of electromagnetic compatibility, the limits of radio interference for Class B equipment as well as the immunity to interference for operation in industry have been used as a basis.

Affixing the EC conformity mark as from 2002

ROHDE & SCHWARZ GmbH & Co. KG
Mühldorfstr. 15, D-81671 München

Munich, 2004-05-04

Central Quality Management FS-QZ / Becker

Support Center

Should you have any technical questions concerning this Rohde & Schwarz product, please contact the hotline of Rohde & Schwarz Vertriebs-GmbH, Support Center.

Our hotline team will answer your questions and find solutions to your problems.

You can reach the hotline Monday through Friday from 8:00 until 17:00.

If you need assistance outside office hours, please leave a message or send us a fax or e-mail. We will contact you as soon as possible.



If you wish to receive the latest news about and updates for a specific instrument, please send us a short e-mail indicating the instrument. We will then send you up-to-date information on a regular basis.

Support Center

Telefon / Telephone: +49 180 512 42 42

Fax: +49 89 41 29 - 137 77

e-mail: CustomerSupport@rsd.rohde-schwarz.com

Adressen/Addresses

FIRMENSITZ/HEADQUARTERS

(Tel) Phone
(Fax) Fax
E-mail

Rohde & Schwarz GmbH & Co. KG
Mühlendorfstraße 15 · D-81671 München
Postfach 80 14 69 · D-81614 München

(Tel) +49 (89) 41 29-0
(Fax) +49 89 4129-121 64
info@rohde-schwarz.com

WERKE/PLANTS

Rohde & Schwarz Messgerätebau GmbH
Riedbachstraße 58 · D-87700 Memmingen
Postfach 1652 · D-87686 Memmingen

(Tel) +49 (8331) 108-0
(Fax) +49 (8331) 108-11 24
info.rsdbm@rohde-schwarz.com

Rohde & Schwarz GmbH & Co. KG
Werk Teisnach
Kaikenrieder Straße 27 · D-94244 Teisnach
Postfach 1149 · D-94240 Teisnach

(Tel) +49 (9923) 857-0
(Fax) +49 (9923) 857-11 74
info.rsdt@rohde-schwarz.com

Rohde & Schwarz GmbH & Co. KG
Dienstleistungszentrum Köln
Graf-Zeppelin-Straße 18 · D-51147 Köln
Postfach 98 02 60 · D-51130 Köln

(Tel) +49 (2203) 49-0
(Fax) +49 (2203) 49 51-229
info.rsd@rohde-schwarz.com
schwarz.com-service.rsd@rohde-schwarz.com

TOCHTERUNTERNEHMEN/SUBSIDIARIES

Rohde & Schwarz Vertriebs-GmbH
Mühlendorfstraße 15 · D-81671 München
Postfach 80 14 69 · D-81614 München

(Tel) +49 (89) 41 29-137 74
(Fax) +49 (89) 41 29-137 77
customersupport@rohde-schwarz.com

Rohde & Schwarz International GmbH
Mühlendorfstraße 15 · D-81671 München
Postfach 80 14 60 · D-81614 München

(Tel) +49 (89) 41 29-129 84
(Fax) +49 (89) 41 29-120 50
info.rusis@rohde-schwarz.com

Rohde & Schwarz Engineering and Sales GmbH
Mühlendorfstraße 15 · D-81671 München
Postfach 80 14 29 · D-81614 München

(Tel) +49 (89) 41 29-137 11
(Fax) +49 (89) 41 29-137 23
info.rse@rohde-schwarz.com

R&S BICK Mobilfunk GmbH
Fritz-Hahne-Str. 7 · D-31848 Bad Münder
Postfach 2062 · D-31844 Bad Münder

(Tel) +49 (5042) 998-0
(Fax) +49 (5042) 998-105
info.rsbeck@rohde-schwarz.com

Rohde & Schwarz FTK GmbH
Wendenschlossstraße 168, Haus 28
D-12557 Berlin

(Tel) +49 (30) 658 91-122
(Fax) +49 (30) 655 50-221
info.ftk@rohde-schwarz.com

Rohde & Schwarz SIT GmbH
Agastraße 3
D-12489 Berlin

(Tel) +49 (30) 658 84-0
(Fax) +49 (30) 658 84-183
info.sit@rohde-schwarz.com

R&S Systems GmbH
Graf-Zeppelin-Straße 18 · D-51147 Köln
Postfach 98 02 60 · D-51130 Köln

(Tel) +49 (2203) 49-5 23 25
(Fax) +49 (2203) 49-5 23 36
info.rssys@rohde-schwarz.com

ADRESSEN WELTWEIT/ADDRESSES WORLDWIDE

Albania siehe/see Austria

Algeria Rohde & Schwarz
Bureau d'Alger
5B Place de Laperrine
16035 Hydra-Alger

(Tel) +213 (21) 48 20 18
(Fax) +213 (21) 69 46 08

Antilles (Neth.) siehe / see Mexico

Argentina Precision Electronica S.R.L.
Av. Pde Julio A. Roca 710 - 6° Piso
1067 Buenos Aires

(Tel) +541 (14) 331 10 67
(Fax) +541 (14) 334 51 11
alberto.lombardi@prec-elec.com.ar

Australia Rohde & Schwarz (Australia) Pty. Ltd.
Sales Support
Unit 6
2-8 South Street
Rydalmere, N.S.W. 2116

(Tel) +61 (2) 88 45 41 00
(Fax) +61 (2) 96 38 39 88
sales@rsa.us.rohde-schwarz.com

Austria Rohde & Schwarz-Österreich Ges.m.b.H.
Am Europlatz 3
Gebäude B
1120 Wien

(Tel) +43 (1) 602 61 41-0
(Fax) +43 (1) 602 61 41-14
rs-austria@rsoe.rohde-schwarz.com

Azerbaijan Rohde & Schwarz Azerbaijan
Liaison Office Baku
ISR Plaza, 5th floor
340 Nizami Str.
370000 Baku

(Tel) +994 (12) 93 31 38
(Fax) +994 (12) 93 03 14
rs-azerbaijan@rsd.rohde-schwarz.com

Bangladesh BIL Consortium Ltd.
Corporate Office
House-33, Road-4, Block-F
Banani, Dhaka-1213

(Tel) +880 (2) 881 06 53
(Fax) +880 (2) 882 82 91

Barbados siehe / see Mexico

Belarus siehe/see Ukraine

Belgium Rohde & Schwarz Belgium N.V.
Excelsiorlaan 31 Bus 1
1930 Zaventem

(Tel) +32 (2) 721 50 02
(Fax) +32 (2) 725 09 36
info@rsb.rohde-schwarz.com

Belize siehe / see Mexico

Bermuda siehe/see Mexico

Bosnia-Herzegovina siehe/see Slovenia

Brazil Rohde & Schwarz Do Brasil Ltda.
Av. Alfredo Egidio de Souza Aranha (Bd. Aranha)
1° andar - Santo Amaro
04726-170 Sao Paulo - SP

(Tel) +55 (11) 56 44 86 11
(Fax) +55 (11) 56 44 86 25 (sales)
(Fax) +55 (11) 56 44 86 36
sales-brazil@rsdb.rohde-schwarz.com

Brunei George Keen Lee Equipment Pte Ltd.
#11-01 BP Tower
396 Alexandra Road
Singapore 119954

(Tel) +656 276 06 26
(Fax) +656 276 06 29
gkleqpt@singnet.com.sg

Bulgaria Rohde & Schwarz
Representation Office Bulgaria
39, Fridtjof Nansen Blvd.
1000 Sofia

(Tel) +359 (2) 96 343 34
(Fax) +359 (2) 963 21 97
rs-bulgaria@rsbg.rohde-schwarz

Canada Rohde & Schwarz Canada Inc.
555 March Rd.
Kanata, Ontario K2K 2M5

(Tel) +1 (613) 592 80 00
(Fax) +1 (613) 592 80 09
sales@rscanada.ca

Chile Dymeq Ltda.
Av. Larrain 6666
Santiago

(Tel) +56 (2) 339 20 00
(Fax) +56 (2) 339 20 10
dymeq@dymeq.com

China Rohde & Schwarz China Ltd.
Representative Office Beijing
6F, Parkview Center
2 Jiangtai Road
Chao Yang District
Beijing 100016

(Tel) +86 (10) 64 31 28 28
(Fax) +86 (10) 64 37 98 88
info.rschina@rsbp.rohde-schwarz.com

Rohde & Schwarz China Ltd.
Representative Office Shanghai
Room 807-809, Central Plaza
227 Huangpi North Road
Shanghai 200003

(Tel) +86 (21) 63 75 00 18
(Fax) +86 (21) 63 75 91 70
May.Zhu@rsbp.rohde-schwarz.com

Rohde & Schwarz China Ltd.
Representative Office Guangzhou
Room 2903, Metro Plaza
183 Tian He North Road
Guangzhou 510075

(Tel) +86 (20) 87 55 47 58
(Fax) +86 (20) 87 55 47 59
Winnie.Lin@rsbp.rohde-schwarz.com

Adressen/Addresses

| | | | | | |
|------------------|--|--|----------------------|---|---|
| India | Rohde & Schwarz India Pvt. Ltd. Mumbai Office B-603, Remi Bizcourt, Shah Industrial Estate, Off Veera Desai Road Andheri West Mumbai - 400 058 | (Tel) +91 (22) 26 30 18 10 (Fax) +91 (22) 26 73 20 81 rsindiam@rsnl.net | Kazakhstan | Rohde & Schwarz Kazakhstan Representative Office Almaty Pl. Respubliki 15 480013 Almaty | (Tel) +7 (32) 72 67 23 54 (Fax) +7 (32) 72 67 23 46 rs-kazakhstan@rsd-rohde-schwarz.com |
| Indonesia | PT Rohde & Schwarz Indonesia Graha Paramita 5th Floor Jln. Denpasar Raya Blok D-2 Jakarta 12940 | (Tel) +62 (21) 252 36 08 (Fax) +62 (21) 252 36 07 sales@rsbj.rohde-schwarz.com-services@rsbj.rohde-schwarz.com | Kenya | Excel Enterprises Ltd Dunga Road P.O.Box 42 788 Nairobi | (Tel) +254 (2) 55 80 88 (Fax) +254 (2) 54 46 79 |
| Iran | Rohde & Schwarz Iran Liaison Office Tehran Groundfloor No. 1, 14th Street Khaled Eslamboli (Vozara) Ave. 15117 Tehran | (Tel) +98 (21) 872 42 96 (Fax) +98 (21) 871 90 12 alfred.korff@rsd.rohde-schwarz.com | Korea | Rohde & Schwarz Korea Ltd. 83-29 Nonhyun-Dong, Kangnam-Ku Seoul 135-010 | (Tel) +82 (2) 34 85 19 00 (Fax) +82 (2) 547 43 00 sales@rskor.rohde-schwarz.com-service@rskor.rohde-schwarz.com |
| Ireland | siehe/see United Kingdom | | Kuwait | Group Five Trading & Contracting Co. Mezzanine Floor Al-Bana Towers Ahmad Al Jaber Street Sharq | (Tel) +965 (244) 91 72/73/74 (Fax) +965 (244) 95 28 jk_agarwal@yahoo.com |
| Israel | Eastronics Ltd. Measurement Products 11 Rozanis St. P.O.Box 39300 Tel Aviv 61392 | (Tel) +972 (3) 645 87 77 (Fax) +972 (3) 645 86 66 david_hasky@easx.co.il | Latvia | Rohde & Schwarz Danmark A/S Latvian Branch Office Merkela iela 21-301 1050 Riga | (Tel) +371 (7) 50 23 55 (Fax) +371 (7) 50 23 60 latvia@rsdk.rohde-schwarz.com |
| | J.M. Moss (Engineering) Ltd. Communications Products 9 Oded Street P.O.Box 967 52109 Ramat Gan | (Tel) +972 (3) 631 20 57 (Fax) +972 (3) 631 40 58 jmoss@zahav.net.il | Lebanon | Rohde & Schwarz Liaison Office Riyadh P.O.Box 361 Riyadh 11411 | (Tel) +966 (1) 465 64 28 Ext. 303 (Fax) +966 (1) 465 64 28 Ext. 229 chris.porzky@rsd.rohde-schwarz.com |
| Italy | Rohde & Schwarz Italia S.p.a. Centro Direzionale Lombardo Via Roma 108 20060 Cassina de Pecchi (MI) | (Tel) +39 (02) 95 70 41 (Fax) +39 (02) 95 30 27 72 rsi.info@rsi.rohde-schwarz.com | | Netcom P.O.Box 55199 Op. Ex-Presidential Palace Horch Tabet Beirut | (Tel) +961 (1) 48 69 99 (Fax) +961 (1) 49 05 11 tohme.sayar@netcomm.tv |
| | Rohde & Schwarz Italia S.p.a. Via Tiburtina 1182 00156 Roma | (Tel) +39 (06) 41 59 81 (Fax) +39 (06) 41 59 82 70 rsi.info@rsi.rohde-schwarz.com | Liechtenstein | siehe/see Switzerland | |
| Jamaica | siehe / see Mexico | | Lithuania | Rohde & Schwarz Danmark A/S Lithuanian Branch Office Lukiskiu 5-228 2600 Vilnius | (Tel) +370 (5) 239 50 10 (Fax) +370 (5) 239 50 11 lithuania@rsdk.rohde-schwarz.com |
| Japan | Rohde & Schwarz Japan K.K. Tokyo Office 711 Bldg., Room 501 (5th floor) 7-11-18 Nishi-Shinjuku Shinjuku-ku Tokyo 160-0023 | (Tel) +81 (3) 59 25 12 88 (Fax) +81 (3) 59 25 12 90 scj.support@rsjp.rohde-schwarz.com | Luxembourg | siehe/see Belgium | |
| | Rohde & Schwarz Japan K.K. Shin-Yokohama Office KM Daiichi Bldg., 8F 2-13-13 Kouhoku-ku Yokohama-shi Kanagawa 222-0033 | (Tel) +81 (4) 54 77 35 70 | Macedonia | NETRA Sarski odred 7 1000 Skopje | (Tel) +389 (2) 329 82 30 (Fax) +389 (2) 317 74 88 netra@netra.com.sk |
| | Rohde & Schwarz Japan K.K. Osaka Office TEK Dai 2 Bldg., 8F 1-13-20 Esaka-shi Suita-shi Osaka-fu 564-0063 | (Tel) +81 (6) 63 10 96 51 | Malaysia | Rohde & Schwarz Malaysia Sdn Bhd Suite 10.04, Level 10, Wisma E&C No. 2 Lorong Dungun Kiri Damansara Heights 50490 Kuala-Lumpur | (Tel) +60 (3) 20 94 00 33 (Fax) +60 (3) 20 94 24 33 sales.malaysia@rohde-schwarz.com |
| Jordan | Jordan Crown Engineering & Trading Co. Jabal Amman, Second Circle Youssef Ezzideen Street P.O.Box 830414 Amman, 11183 | (Tel) +962 (6) 462 17 29 (Fax) +962 (6) 465 96 72 jocrown@go.com.jo | Malta | Tektraco International Technology Ltd. 121, B'Kara Road San Gwann SGN 08 | (Tel) +356 (21) 37 43 00 or 37 80 88 (Fax) +356 (21) 37 66 67 sales@tektraco.com |
| | | | Mexico | Rohde & Schwarz de Mexico S. de R.L. de C.V. German Centre Oficina 4-2-2 Av. Santa Fé 170 Col. Lomas de Santa Fé 01210 Mexico D.F. | (Tel) +52 (55) 85 03 99 13 (Fax) +52 (55) 85 03 99 16 latinoamerica@rsd-rohde-schwarz.com |
| | | | Moldava | siehe/see Austria | |
| | | | Nepal | ICTC Pvt. Ltd. Hattisar, Post Box No. 660 Kathmandu | (Tel) +977 (1) 443 48 95 (Fax) +977 (1) 443 49 37 ictc@mos.com.np |

Adressen/Addresses

| | | | | | |
|---------------------------|---|--|--------------------------|---|--|
| Netherlands | Rohde & Schwarz Nederland B.V. Perkinsbaan 1 3439 ND Nieuwegein | (Tel) +31 (30) 600 17 00 (Fax) +31 (30) 600 17 99 info@rsn.rohde-schwarz.com | Saudi Arabia | Gentec Haji Abdullah Alireza & Co. Ltd. P.O.Box 43054 Riyadh | (Tel) +966 (1) 293 20 35 (Fax) +966 (1) 466 16 57 akanbar@gentec.com.sa |
| New Zealand | Nichecom 1 Lincoln Ave. Tawa, Wellington | (Tel) +64 (4) 232 32 33 (Fax) +64 (4) 232 32 30 rob@nichecom.co.nz | Serbia-Montenegro | Rohde & Schwarz Representative Office Belgrade Tose Jovanovica 7 11030 Beograd | (Tel) +381 (11) 305 50 25 (Fax) +381 (11) 305 50 24 rs-scg@rscs.rohde-schwarz.com |
| Nicaragua | siehe/see Mexico | | Singapore | Rohde & Schwarz Regional Headquarters Singapore Pte. Ltd. 1 Kaki Bukit View #05-01/02 Techview Singapore 415 941 | (Tel) +65 68 46 18 72 (Fax) +65 68 46 12 52 |
| Nigeria | Ferrostaal Abuja Plot 3323, Barada Close P.O.Box 8513, Wuse Off Amazon Street Maitama, Abuja | (Tel) +234 (9) 413 52 51 (Fax) +234 (9) 413 52 50 fsabuja@rosecom.net | | | |
| Norway | Rohde & Schwarz Norge AS Enebakkeveien 302 B 1188 Oslo | (Tel) +47 (23) 38 66 00 (Fax) +47 (23) 38 66 01 firmapost@rsnor.rohde-schwarz.com | | Rohde & Schwarz Systems & Communications Asia Pte Ltd Service 1 Kaki Bukit View #04-01/07 Techview Singapore 415 941 | (Tel) +65 68 46 37 10 (Fax) +65 68 46 00 29 info@rssg.rohde-schwarz.com |
| Oman | Mustafa Sultan Science & Industry Co.LLC. Test & Measurement Products Way No. 3503 Building No. 241 Postal Code 112 Al Khuwair, Muscat | (Tel) +968 63 60 00 (Fax) +968 60 70 66 m-aziz@mustafasultan.com | Slovak Republic | Specialne systémy a software, a.s. Svrčia ul. 3 841 04 Bratislava 4 | (Tel) +421 (2) 65 42 24 88 (Fax) +421 (2) 65 42 07 68 3s@special.sk |
| Pakistan | Siemens Pakistan 23, West Jinnah Avenue Islamabad | (Tel) +92 (51) 227 22 00 (Fax) +92 (51) 227 54 98 reza.bokhary@siemens.com.pk | Slovenia | Rohde & Schwarz Representative Office Ljubljana Tbilisjska 89 1000 Ljubljana | (Tel) +386 (1) 423 46 51 (Fax) +386 (1) 423 46 11 rs-slovenia@rssi.rohde-schwarz.com |
| Panama | siehe/see Mexico | | South Africa | Protea Data Systems (Pty.) Ltd. Communications and Measurement Division Private Bag X19 Bramley 2018 | (Tel) +27 (11) 719 57 00 (Fax) +27 (11) 786 58 91 unicm@protea.co.za |
| Papua New Guinea | siehe/see Australia | | | Protea Data Systems (Pty.) Ltd. Cape Town Branch Unit G9, Centurion Business Park Bosmandam Road Milnerton Cape Town, 7441 | (Tel) +27 (21) 555 36 32 (Fax) +27 (21) 555 42 67 unicm@protea.co.za |
| Paraguay | siehe/see Argentina | | Spain | Rohde & Schwarz Espana S.A. Salcedo, 11 28034 Madrid | (Tel) +34 (91) 334 10 70 (Fax) +34 (91) 729 05 06 rses@rses.rohde-schwarz.com |
| Philippines | Rohde & Schwarz (Philippines) Inc. Unit 2301, PBCOM Tower 6795, Ayala Ave. cor. Herrera St. Makati City | (Tel) +63 (2) 753 14 44 (Fax) +63 (2) 753 14 56 | | Rohde & Schwarz Espana S.A. Av. Príncipe d'Astúries, 66 08012 Barcelona | (Tel) +34 (93) 415 15 68 (Fax) +34 (93) 237 49 95 bcn@rses.rohde-schwarz.com |
| Poland | Rohde & Schwarz SP.z o.o. Przedstawicielstwo w Polsce ul. Stawki 2, Pietro 28 00-193 Warszawa | (Tel) +48 (22) 860 64 94 (Fax) +48 (22) 860 64 99 rs-poland@rspl.rohde-schwarz.com | Sri Lanka | Dynatel Communications (PTE) Ltd. 451/A Kandy Road Kelaniya | (Tel) +94 (112) 90 80 01 (Fax) +94 (112) 91 04 69 69 dynatel@dynanet.lk |
| Portugal | Rohde & Schwarz Portugal, Lda. Alameda Antonio Sergio 7-R/C - Sala A 2795-023 Linda-a-Velha | (Tel) +351 (21) 415 57 00 (Fax) +351 (21) 415 57 10 info@rspt.rohde-schwarz.com | Sudan | SolarMan Co. Ltd. P.O.Box 11 545 North of Fraouq Cementry 6/7/9 Bldg. 16 Karthoum | (Tel) +249 (183) 47 31 08 (Fax) +249 (183) 47 31 38 solarman29@hotmail.com |
| Republic Dominican | siehe/see Mexico | | Sweden | Rohde & Schwarz Sverige AB Flygfältsgatan 15 128 30 Skarpnäck | (Tel) +46 (8) 605 19 00 (Fax) +46 (8) 605 19 80 info@rss.rohde-schwarz.com |
| Romania | Rohde & Schwarz Representation Office Bucharest 89 Eroii Sanitari Blvd., sector 5 050472 Bucuresti | (Tel) +40 (21) 411 20 13 (Fax) +40 (21) 410 68 46 rs-romania@rsro.rohde-schwarz.com | Switzerland | Roschi Rohde & Schwarz AG Mühlestr. 7 3063 Ittigen | (Tel) +41 (31) 922 15 22 (Fax) +41 (31) 921 81 01 support@roschi.rohde-schwarz.com |
| Russian Federation | Rohde & Schwarz International GmbH 119180, Yakimanskaya nab., 2 Moscow | (Tel) +7 (095) 745 88 50 to 53 (Fax) +7 (095) 745 88 54 rs-russia@rsru.rohde-schwarz.com | Syria | Electro Scientific Office Baghdad Street Dawara Clinical Lab. Bldg P.O.Box 8162 Damascus | (Tel) +963 (11) 231 59 74 (Fax) +963 (11) 231 88 75 memo@hamshointl.com |
| Saudi Arabia | Rohde & Schwarz International GmbH - Liaison Office Riyadh c/o Haji Abdullah Alireza Co. Ltd. P.O.Box 361 Riyadh 11411 | (Tel) +966 (1) 293 2035 (Fax) +966 (1) 466 1657 chris.porzky@rsd.rohde-schwarz.com | | | |

Adressen/Addresses

| | | | | | |
|------------------------------|---|--|-----------------------|--|---|
| Taiwan | Rohde & Schwarz Taiwan (Pvt.) Ltd. Floor 14, No. 13, Sec. 2, Pei-Tou Road Taipei 112 | (Tel) +886 (2) 28 93 10 88 (Fax) +886 (2) 28 91 72 60 celine.tu@rstw.rohde-schwarz.com | United Kingdom | Rohde & Schwarz UK Ltd. 3000 Manchester Business Park Aviator Way Manchester M22 5TG | (Tel) +44 (870) 735 16 42 (Fax) +44 (1252) 81 14 77 sales@rsuk.rohde-schwarz.com |
| Tanzania | SSTL Group P.O. Box 7512 Dunga Street Plot 343/345 Dar Es Salaam | (Tel) +255 (22) 276 00 37 (Fax) +255 (22) 276 02 93 sstl@ud.co.tz | Uruguay | Aeromarine S.A. Cerro Largo 1497 11200 Montevideo | (Tel) +598 (2) 400 39 62 (Fax) +598 (2) 401 85 97 cs@aeromarine.com.uy |
| Thailand | Rohde & Schwarz International Thailand 2nd floor Gems Tower Bangrak, Suriyawong Bangkok 10600 | (Tel) +66 (2) 200 07 29 (Fax) +66 (2) 267 00 79 | USA | Rohde & Schwarz, Inc. Eastern Regional Office (US Headquarters) 8661A Robert Fulton Drive Columbia, MD 21046-2265 | (Tel) +1 (410) 910 78 00 (Fax) +1 (410) 910 78 01 info@rsa.rohde-schwarz.com |
| | Schmidt Electronics (Thailand) Ltd. Messtechnik 202 Le Concorede Tower, 23rd Fl. Ratchadaphisek Rd. Huay kwang Bangkok 10320 | (Tel) +66 (2) 69 41 47 05 (Fax) +66 (2) 69 41 47 06 salestm@schmidtelectronics.com | | Rohde & Schwarz, Inc. Central Regional Office / Systems & EMI Products 8080 Tristar Drive Suite 120 Irving, TX 75063 | (Tel) +1 (469) 713 53 00 (Fax) +1 (469) 713 53 01 info@rsa.rohde-schwarz.com |
| | TPP Operation Co. Ltd. Kommunikationstechnik 41/5 Mooban Tarinee Boromrajchonnee Road Talingchan Bangkok 10170 | (Tel) +66 (2) 880 93 47 (Fax) +66 (2) 880 93 47 | | Rohde & Schwarz, Inc. R&D and Application Support 8905 SW Nimbus Ave Suite 240 Beaverton, OR 97008 | (Tel) +1 (503) 403 47 00 (Fax) +1 (503) 403 47 01 info@rsa.rohde-schwarz.com |
| Trinidad & Tobago | siehe/see Mexico | (Tel) (Fax) | | Rohde & Schwarz, Inc. Western Regional Office 7700 Irvine Center Drive Suite 100 Irvine, CA 92618 | (Tel) +1 (949) 885 70 00 (Fax) +1 (949) 885 70 01 info@rsa.rohde-schwarz.com |
| Tunisia | Teletek 71, Rue Alain Savary Residence Alain Savary (C64) Cit  el Khadra 1003 Tunis | (Tel) +216 (71) 77 33 88 (Fax) +216 (71) 77 05 53 teletek@gnet.tn | | Rohde & Schwarz, Inc. Service & Calibration Center 8661A Robert Fulton Drive Columbia, MD 21046-2265 | (Tel) +1 (410) 910 50 02 (Fax) +1 (410) 910 79 31 service.rsa@rsa.rohde-schwarz.com |
| Turkey | Rohde & Schwarz International GmbH Liaison Office Istanbul Bagdat Cad. 191/3, Arda Apt. B-Blok 81030 Selamicesme-Istanbul | (Tel) +90 (216) 385 19 17 (Fax) +90 (216) 385 19 18 nadir.guerelman@rsd.rohde-schwarz.com | Vietnam | Rohde & Schwarz Representative Office Vietnam Unit 807, 8/F, Schmidt Tower 239 Xuan Thuy Road Cau Giay District Hanoi | (Tel) +84 (4) 834 20 46 |
| Ukraine | Rohde & Schwarz Representative Office Kiev 4, Patris Loumoumba ul. 01042 Kiev | (Tel) +38 (044) 268 60 55 (Fax) +38 (044) 268 83 64 rsbkiev@public.ua.net | West Indies | siehe/see Mexico | |
| United Arab Emirates | Rohde & Schwarz International GmbH Liaison Office Middle East Vertrieb P.O. Box 31156 Abu Dhabi | (Tel) +971 (2) 6335 670 (Fax) +971 (2) 6335 671 Dario Barisoni@rsd.rohde-schwarz.com | | | |
| | Rohde & Schwarz Bick Mobile Communication P.O.Box 17466 JAFZ, PPU ZG-07 Dubai | (Tel) +971 (4) 883 71 35 (Fax) +971 (4) 883 71 36 | | | |
| | Rohde & Schwarz Emirates L.L.C. ESNAAD Premisses at Mussafah, P.O.Box 31156 Abu Dhabi | (Tel) +971 (2) 55 49 411 (Fax) +971 (2) 55 49 433 rsuaeam@emirates.net.ae | | | |
| United Kingdom | Rohde & Schwarz UK Ltd. Ancells Business Park Fleet Hampshire GU51 2UZ | (Tel) +44 (1252) 81 88 88 (sales)+44 (1252) 81 88 18 (service) (Fax) +44 (1252) 81 14 47 sales@rsuk.rohde-schwarz.com | | | |

1 Putting into Operation

Front view

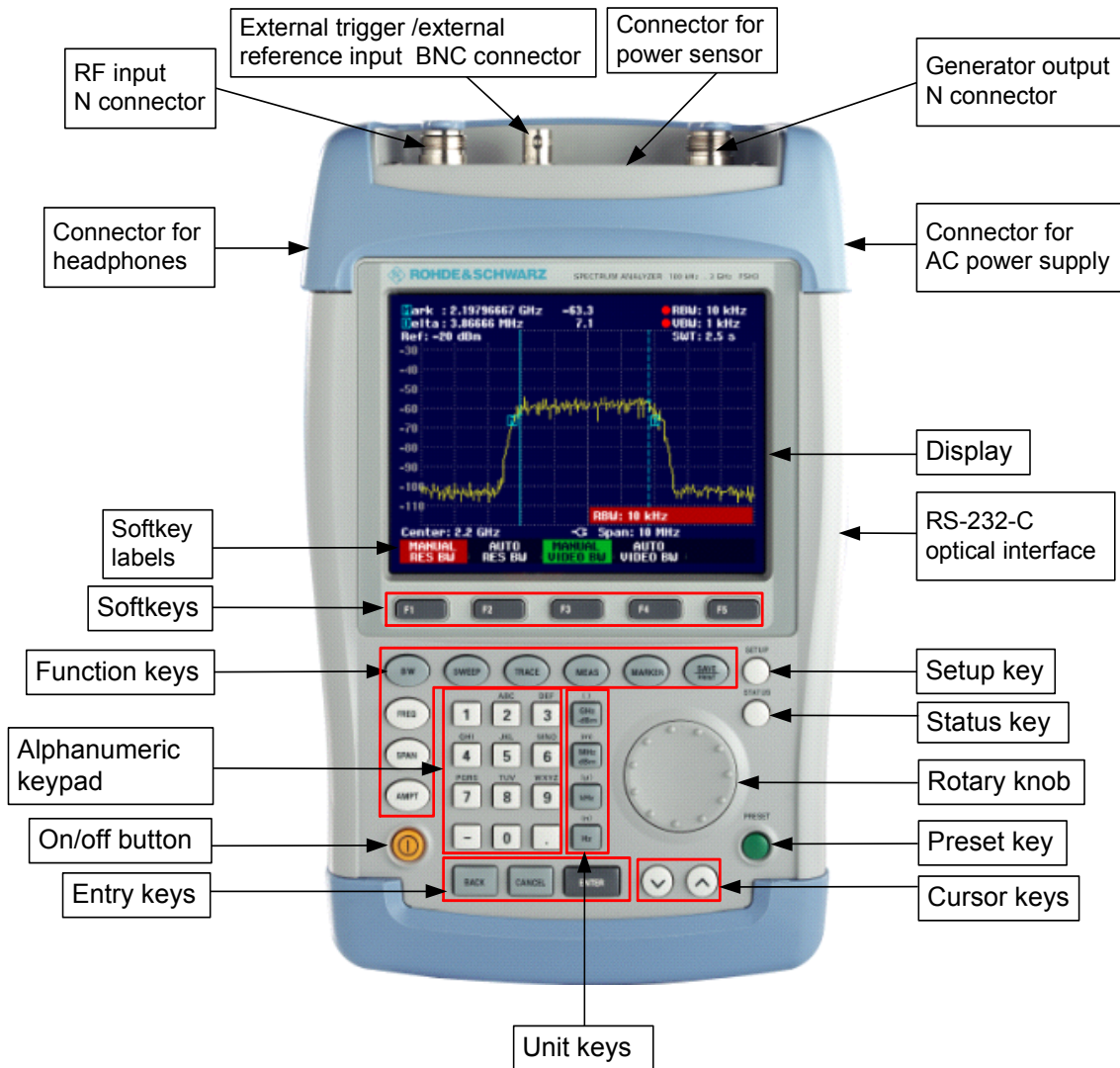

Putting into Operation

The following section describes how to put the handheld spectrum analyzer into operation and how to connect external devices, e.g. printers.

Section 2 describes the operation of the spectrum analyzer using simple measurements as examples.

Unpacking the Instrument

The R&S FSH comes in formfitting packaging that consists of upper and lower shells. The two shells are held together by tape.

The packaging contains all accessories supplied.

- Undo the tape to unpack the analyzer.

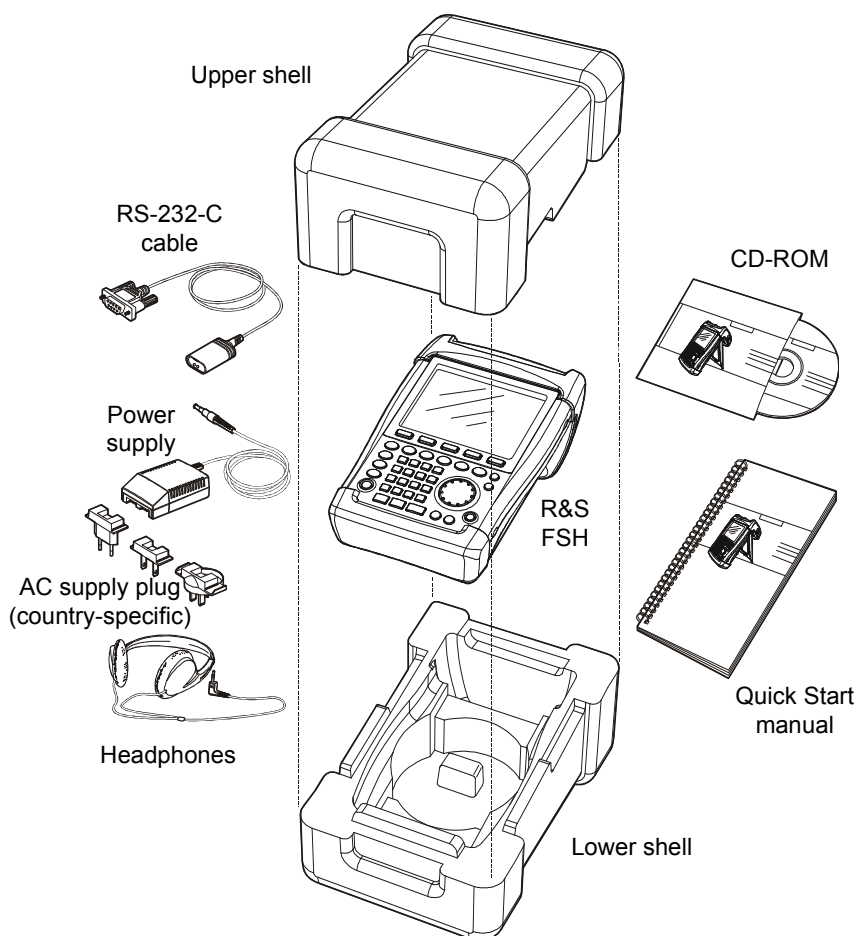

- Remove the R&S FSH and the accessories.
- Remove the protective foil from the screen.

Note: Each R&S FSH comes with a unique master PIN. Keep the master PIN in a secure place away from the R&S FSH. If someone enters an incorrect PIN three times in succession, the R&S FSH cannot be used again until the master PIN is entered.

Setting up the Instrument

The Handheld Spectrum Analyzer R&S FSH has been designed for operation in labs as well as for on-site use for service and maintenance applications.

For any application, the R&S FSH can be set up to optimize ease of operation and the viewing angle of the display.

When used as a desktop instrument, the R&S FSH can either be laid flat or it can be propped up using the fold-out support at the back.

The R&S FSH can be laid flat for operation from above. Because the grip is slightly raised at the back, the R&S FSH is tilted forward to give the optimum viewing angle for the display.

For use as a desktop, fold out the support at the rear so that the instrument can easily be operated from the front and the display can be read easily (see Fig.).

For on-site installation and service measurements, it is best to hold the instrument with both hands. All the controls are easy to reach (e.g. with your thumbs). Use the R&S FSH-Z25 carrying bag so that you have both hands free to adjust the DUT. The R&S FSH can be placed in the hanger provided on the open bag for this purpose.

To secure the instrument in place, affix its carrying handle to the front of the carrying bag with the Velcro tape.

The carrying handle at the top of the R&S FSH can also be used to hang it from cabinet doors, for example. The shape of the grip ensures that the instrument does not fall off.



Switching on the Spectrum Analyzer

The R&S FSH can be powered using either the included power supply unit or internal battery. When fully charged, the built-in nickel metal hydride battery provides an operating time of about four hours. On delivery, the battery in the R&S FSH may be flat. Therefore, it must be charged before the R&S FSH can be used. If the instrument is switched off, the charging time is four hours. When the adapter is used, the R&S FSH's battery is charged simultaneously.

Insert the jack plug of the power supply unit into the POWER ADAPTER connector on the right-hand side of the carrying handle so that it locks into position. Then connect the power supply unit to an AC outlet. The voltage range of the power supply unit is 100 V to 240 V.

Caution! Only the supplied power supply unit – the R&S FSH-Z33 – may be used to power the R&S FSH or charge the battery from the AC supply.



Prior to use, make sure that the AC supply voltage is compatible with the voltage specified on the power supply unit. Before inserting the power supply unit into the AC power outlet, attach the appropriate adapter.

In vehicles, the battery can be charged from the cigarette lighter socket using the R&S FSH-Z21 cable.

Caution! It is strictly forbidden to operate the R&S FSH via the cigarette lighter socket while the vehicle is in motion or the engine is running. In these cases, the R&S FSH must be off.



While the battery of the R&S FSH is being charged via the 12 V Car Adapter R&S FSH-Z21, the car adapter must not be connected to the vehicle's ground (for example, via the RF connector) under any circumstances.

To switch on the R&S FSH, press the yellow button  at the bottom left of the front panel.

To indicate that it is connected to the AC supply, the R&S FSH displays a connector symbol in the middle of the display above the softkey labels.

| | | | | |
|-----------------|-----------|---------------|------|--------|
| Center: 1.5 GHz | | ← Span: 3 GHz | | |
| CENTER | CF | START | STOP | FREQ |
| FREQ | STEP SIZE | FREQ | FREQ | OFFSET |

When the R&S FSH is switched on, it recalls the settings that it was using when it was last switched off.

Note: If the internal battery is completely flat, the R&S FSH cannot be switched on even though it is connected to the AC supply via the power supply unit. In this case, the internal battery must be charged for a while with the instrument switched off. Only then can the instrument be switched on.

Spectrum Analyzer Connectors

The R&S FSH has the following connectors:

RF input

Connect the RF input via a cable with an N connector to the DUT. Make sure that it is not overloaded.

The maximum permissible continuous power at the RF input is 20 dBm (100 mW). It can be loaded with up to 30 dBm (1 W) for a maximum of three minutes. If the instrument is loaded with 1 W for longer, it heats up to such an extent that it may be destroyed.

Caution! *The RF input is AC-coupled. However, the DC input voltage must never exceed the value specified on the housing; otherwise the coupling capacitor at the input may be destroyed and, thus, the input attenuator or mixer as well. The RF input is protected from static discharges and voltage pulses by a combination of limiting circuits and high-voltage arresters.*



Input for external trigger or external reference (EXT TRIG/EXT REF)

Via the EXT TRIG/EXT REF BNC connector, either an external trigger signal is applied to start a measurement, or a 10 MHz reference signal is applied for frequency synchronization. The trigger threshold is similar to that of TTL signals. The level for the reference signal must be greater than 10 dBm. Switchover between external trigger input and reference input is via the SETUP key.

DC connector for external power supply (on the right-hand side of the carrying handle).

The DC connector is used to supply the R&S FSH with power from the AC/DC adapter and to charge the R&S FSH internal battery. The input voltage for the instrument must be between 15 V and 20 V. Power consumption is approx. 7 W.

The battery can also be charged from a cigarette lighter socket in a vehicle. The adapter is available as an R&S FSH accessory (R&S FSH-Z21, order no. 1145.5873.02).

Caution! *While the battery of the R&S FSH is being charged via the 12 V Car Adapter R&S FSH-Z21, the car adapter must not be connected to the vehicle's ground (for example, via the R&S FSH's RF connector or the power sensor) under any circumstances.*



Headphones connector (on the left-hand side of the carrying handle)

A 3.5 mm jack is provided for headphones. The internal impedance of the connector is approx. 10 Ω .

RS-232-C optical interface

(on the right-hand side of the R&S FSH; can be accessed by folding out the stand)

The RS-232-C optical interface is for connecting a printer or PC. The R&S FSH-Z34 RS-232-C optical cable or the FSH-Z37 USB optical cable R&S is used to make the connection. Starting with the R&S FSH serial numbers listed below, the R&S FSH-Z37 USB optical cable will replace the R&S FSH-Z34:

| Model | Ser. No. |
|--------------------------|----------|
| R&S FSH 3 (1145.5850.03) | 103001 |
| R&S FSH 3 (1145.5850.13) | 103501 |
| R&S FSH 3 (1145.5850.23) | 102501 |
| R&S FSH 6 (1145.5850.06) | 101001 |
| R&S FSH 6 (1145.5850.26) | 101501 |

If you use the R&S FSH-Z37 USB optical cable, you need to install a software driver on your PC. The CD-ROM, which is supplied with the R&S FSH, includes both the driver and the installation instruction.

The optical connection prevents spurious measurements due to interference from these devices.

Use the Serial/Parallel Converter R&S FSH-Z22 for printers with a parallel interface. Printers with a USB interface cannot be connected directly to the R&S FSH.

Connector for power sensor

The connector has been especially configured for Rohde & Schwarz power sensors. The connector is used to power the sensor and to transfer data via the power sensor's interface. If the R&S FSH-Z2 (VSWR bridge and power divider) is used, it is controlled by the connector.

Tracking generator output (models 1145.5850.13, 1145.5850.23 and 1145.5850.26 only)

Connect the tracking generator output to the DUT via an N connector. The nominal output level is -20 dBm (100 µW). With the R&S FSH3 model 1145.5850.23, the level can be switched between -20 dBm and 0 dBm (1 mW). Up to 3 GHz, the R&S FSH6 model 1145.5850.26 supplies an output level of -10 dBm; above 3 GHz, the level is -20 dBm. Starting with serial number 100500, the output level of the R&S FSH6, model 1145.5850.26, can be reduced in 1 dB steps by maximally 20 dB by means of a step attenuator.

Caution! *The output is AC-coupled and a voltage that does not exceed the voltage stated on the housing can be fed into the output; if this voltage is exceeded, the output may be destroyed.*



Screen Settings

The R&S FSH's screen is a transfective, passive color LCD. Indoors, its brightness depends on the intensity of the backlighting. If light irradiation is strong, the ambient light supports readability. The viewing angle can be optimized by adjusting the contrast. To achieve maximum contrast, the screen can be switched from color display to black-and-white display.

To strike a balance between battery operating time and screen display quality, set backlighting to the minimum brightness needed.

Setting brightness

- Press the SETUP key.
- Press the DISPLAY softkey.

The submenu with the contrast, lighting and color settings opens.



- Using the rotary knob or cursor keys, select LIGHT... and confirm by pressing the DISPLAY softkey or the ENTER key again.

The BACKLIGHT submenu for the lighting level opens. The level can be set to HIGH, NORMAL and LOW.

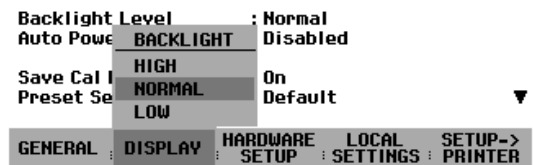

- Using the rotary knob or cursor keys, select the setting you want and confirm by pressing the DISPLAY softkey or the ENTER key.

Setting the contrast

- Press the SETUP key.
- Press the DISPLAY softkey.

The submenu with the contrast, lighting and color settings opens.



- Using the rotary knob or the cursor keys, select CONTRAST... and confirm by pressing the DISPLAY softkey or the ENTER key again.

The contrast value entry box opens.



- Using the rotary knob, adjust the contrast until screen legibility is optimal.

When setting the contrast, view the display at the same angle that will be used for the application.

- Confirm the entry with the ENTER key or by pressing the DISPLAY softkey again.

The R&S FSH displays the setting in the Display Contrast line in the overview of the setup settings.

Setting the screen color

- Press the SETUP key.
- Press the DISPLAY softkey.

The submenu with the contrast, lighting and color settings opens.



- Using the rotary knob or cursor keys, select TYPE... and confirm with the ENTER key or by pressing the DISPLAY softkey again.
- In the submenu that opens, select COLOR or BLACK/WHITE.
- Confirm with the ENTER key or by pressing the DISPLAY softkey again.

The R&S FSH switches to the selected color settings.



Country-Specific Settings

The R&S FSH is “multilingual” and can display text in the language of your choice. The softkey lettering is always in English. The default setting (factory-setting) is also English.

Selection

- Press the SETUP key.

The R&S FSH displays all default settings. The last two lines indicate the current language and the date format.

```

Display Contrast      : 62 %
Backlight Level      : Normal
Auto Power Down      : 5 minutes
    
```

- Press the LOCAL SETTINGS softkey.

```

Language              : Engli
Date Format            : dd/mm
Length Unit           : Meter
LANGUAGE...
DATE FORMAT...
UNIT OF LENGTH...
    
```

A submenu with the LANGUAGE..., DATE FORMAT... and UNIT OF LENGTH... entries opens. This menu allows the entry of a country-specific language, date format or the unit of length used by the R&S FSH.

```

GENERAL : DISPLAY : HARDWARE : LOCAL : SETUP->
          :          : SETUP    : SETTINGS : PRINTER
    
```

- Using the rotary knob or cursor keys, select the LANGUAGE... you want from the menu and confirm with the ENTER key or by pressing the LOCAL SETTINGS softkey again.

The languages available are displayed in a submenu. The selected language is highlighted in red.

```

Printer Baudrate      : 19200
Printer Type          : Laser
Pincode Protection    : Off
Display Contrast      : 62 %
Backlight Level      : Norma
Auto Power Down      : 5 minu
Language              : Engli
Date Format            : dd/mm
Length Unit           : Meter
LANGUAGE
ENGLISH
FRENCH
GERMAN
SPANISH
ITALIAN
PORTUGUESE
JAPANESE
CHINESE
KOREAN
    
```

- Using the rotary knob or cursor keys, select the language you want.

The originally selected language is highlighted in green. The red bar indicates the new selection.

```

GENERAL : DISPLAY : HARDWARE : LOCAL : SETUP->
          :          : SETUP    : SETTINGS : PRINTER
    
```

- Confirm the new selection with the ENTER key or by pressing the LOCAL SETTINGS softkey.

- Using the rotary knob or cursor keys, select DATE FORMAT... from the menu and confirm with the ENTER key or by pressing the LOCAL SETTINGS softkey again.

- Using the rotary knob or cursor keys, select the date format (dd/mm/yyyy or mm/dd/yyyy) and confirm with the ENTER key.

- Using the rotary knob or cursor keys, select UNIT OF LENGTH... from the menu and confirm with the ENTER key or by pressing the LOCAL SETTINGS softkey again.

- Using the rotary knob or cursor keys, select the required unit of length (METER or FEET) and confirm with the ENTER key.

Note: The unit of length is relevant only with distance-to-fault cable measurements in order to display the fault distance from the measurement plane.

Setting the Date and Time

The R&S FSH has an internal clock that can apply a date and time stamp, e.g. for output to a printer or stored data records. The user can reset the date and time.

Setting the date

- Press the SETUP key.
- Press the GENERAL softkey.
- Using the rotary knob or cursor keys, select DATE... from the menu and confirm with the ENTER key.

The value entry box above the row of softkey labels is highlighted in red and displays the currently set date in the selected format (dd/mm/yyyy or mm/dd/yyyy). The active value entry field is highlighted in white.

| | |
|--------------------|------------|
| SAVE CAL DATA... | : D6.207 |
| POWER DOWN... | : 115200 |
| DATE... | : 19200 |
| TIME... | : Laserjet |
| SERIAL BAUD... | : Off |
| PRINTER BAUD... | : 70 % |
| PRINTER TYPE... | : Normal |
| PINCODE... | : Disabled |
| OPTIONS... | : On |
| PRESET SETTINGS... | : Default |
| FACTORY | |

GENERAL : DISPLAY : **HARDWARE** : LOCAL : SETUP->
SETUP : SETTINGS : PRINTER

- Depending on the date format, change the day (dd) or month (mm) by using the rotary knob, cursor keys or a numeric entry and confirm with the ENTER key.

After the entry, the cursor automatically moves to the second field in the date (day or month, depending on the date format). Proceed with the next two fields as with the first.

| | |
|------------------|--------------|
| Display Contrast | : 62 % |
| Backlight Level | : Normal |
| Auto Power Down | : 5 minutes |
| Language | : English |
| Date Format | : dd/mm/yyyy |
| Length Unit | : Meter |

Date: 02/02/2003

GENERAL : DISPLAY : **HARDWARE** : LOCAL : SETUP->
SETUP : SETTINGS : PRINTER

After the last data block has been entered, the R&S FSH verifies the validity of the entered date. If the date is not valid, the R&S FSH sets the next valid date.

Setting the time

- Press the SETUP key.
- Press the GENERAL softkey.
- Using the rotary knob or cursor keys, select TIME... from the menu and confirm with the ENTER key.

The value entry box above the row of softkey labels is highlighted in red and displays the currently set time in hours:minutes format. The hours display is highlighted in white to enter a new value.

| | |
|--------------------|------------|
| SAVE CAL DATA... | : D6.207 |
| POWER DOWN... | : 115200 |
| DATE... | : 19200 |
| TIME... | : Laserjet |
| SERIAL BAUD... | : Off |
| PRINTER BAUD... | : 70 % |
| PRINTER TYPE... | : Normal |
| PINCODE... | : Disabled |
| OPTIONS... | : On |
| PRESET SETTINGS... | : Default |
| FACTORY | |

GENERAL : DISPLAY : **HARDWARE** : LOCAL : SETUP->
SETUP : SETTINGS : PRINTER

- Change the hours with the rotary knob, cursor keys or numeric entry and confirm with the ENTER key.

After entry, the cursor automatically goes to the minutes display. The entry is the same as for the hours display.

| | |
|-------------|--------------|
| Language | : English |
| Date Format | : dd/mm/yyyy |
| Length Unit | : Meter |

Time: 02:01

GENERAL : DISPLAY : **HARDWARE** : LOCAL : SETUP->
SETUP : SETTINGS : PRINTER

After the minutes have been entered, the R&S FSH verifies the validity of the entered time. If the time is not valid, the R&S FSH sets the next valid time.

Charging the Battery

The R&S FSH is fitted with a nickel metal hydride battery. The operating time is approx. four hours at room temperature if the battery is fully charged.

Note: The battery in the R&S FSH is not charged when it leaves the factory. It must therefore be charged after delivery.

When stored over an extended period, self-discharging reduces the battery charge. The battery should therefore be charged before use if it is going to be the sole power source for a long period of operation.

The charging status of the battery is displayed by a symbol that looks like a battery in the middle of the screen above the row of softkey labels. If the battery is fully charged, the entire battery symbol is white. As the battery discharges, the white coloring disappears in five steps until just the battery outline indicates that the battery is flat.



Battery charge-level symbol

The battery is charged via the included power supply unit, which is connected to the jack on the right-hand side of the carrying handle.

If required, equip the power supply unit with the country-specific plug. Remove the plug from the power supply unit toward the front and firmly connect the appropriate plug to the power supply unit.

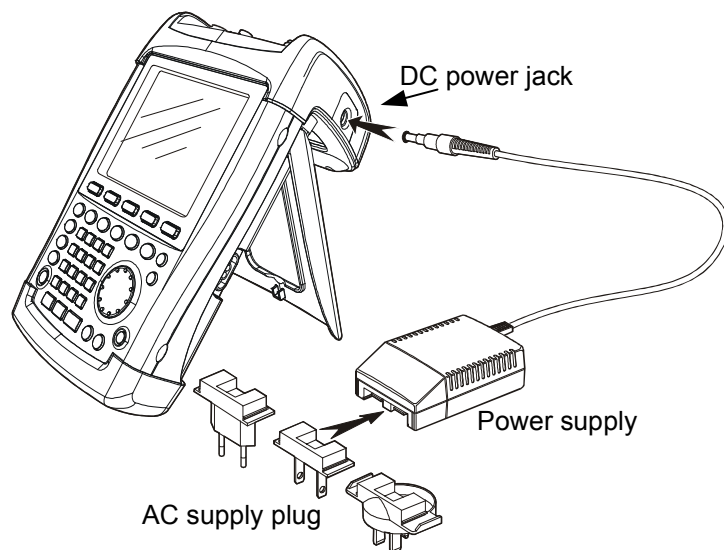

For rapid charging, be sure to switch off the R&S FSH during charging. The charging time is approx. four hours.

If the R&S FSH is switched on, the charging current for the battery is reduced by the current drain of the R&S FSH, which means the battery might not be charged.

To prevent the battery from discharging unnecessarily, the R&S FSH has an automatic cut-off or auto power down mode that is activated if no entry is made for a definable period of time (5 minutes or 30 minutes).

The auto power down mode is deactivated in the default setting.

The auto power down mode is set as follows:

- Press the GENERAL key.

The R&S FSH opens the submenu with the general settings. The cursor is positioned to POWER DOWN in the menu.

- Confirm the POWER DOWN selection by pressing the ENTER key.

The R&S FSH opens a selection window with the settings: 5 minutes, 30 minutes and DISABLE.

- Using the rotary knob or cursor keys, select the setting you want and confirm by pressing the ENTER key or the GENERAL softkey.

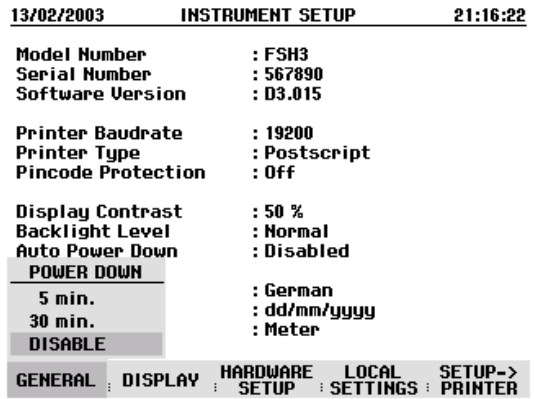

Selecting the Instrument Default Setup

The PRESET key sets the R&S FSH to the default setup. This allows a new configuration based on defined measurement parameters to be entered, without parameters from a previous setting unintentionally still being active.

- Press the PRESET key.

The R&S FSH is set to the default setup. The span depends on the model. With the R&S FSH3, it is 3 GHz; with the R&S FSH6, 6 GHz.

If certain parameters are always to deviate from the default setup for a specific application, it is also possible to select a user-defined default setup, which is then automatically set with the PRESET key. This is useful, for example, if the measurement is always made with a 75 Ω matching pad. When the PRESET key is pressed, the R&S FSH always selects 75 Ω as the input impedance for the user-specific default setup. The user-defined default setup is generated by manually entering the desired parameters and saving the setting as a data set. This data set can subsequently be declared the preset settings with the aid of the R&S FSH View software.

The data set designated as the preset settings becomes the default setup of the R&S FSH as follows:

- Press the SETUP key.
- Press the GENERAL softkey.
- Select PRESET SETTINGS from the menu using the cursor keys or the rotary knob.
- Confirm your choice with the ENTER key or the GENERAL softkey.

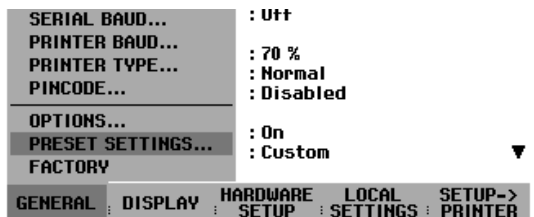

The submenu for selecting the default setup opens. Either DEFAULT or CUSTOM can be selected.

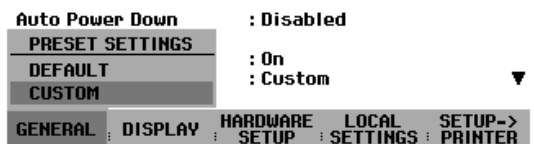

- Select CUSTOM from the menu using the cursor keys or the rotary knob.
- Confirm your choice with the ENTER key or the GENERAL softkey.



The parameters defined in the data set for the default setup are now used as the preset settings. If no user-specific default setup is defined, CUSTOM is inactive and cannot be selected. The data set defined as the user default setup can be viewed using the R&S FSH's recall function.

- Press the SAVE/PRINT key.
- Press the RECALL softkey.

All stored data sets are displayed. The status of the data set is indicated in the status field:

- : Preset setting
- : Data set disabled

If no data sets are stored in the R&S FSH, the message "No datasets available" is output instead of the list of data sets.

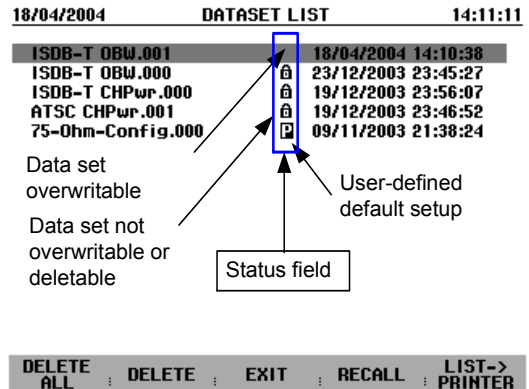

The screenshot shows the 'DATASET LIST' screen with the following data:

| Dataset Name | Status | Date | Time |
|-------------------|--------|------------|----------|
| ISDB-T OBW.001 | | 18/04/2004 | 14:10:38 |
| ISDB-T OBW.000 | | 23/12/2003 | 23:45:27 |
| ISDB-T CHPwr.000 | | 19/12/2003 | 23:56:07 |
| ATSC CHPwr.001 | | 19/12/2003 | 23:46:52 |
| 75-Ohm-Config.000 | | 09/11/2003 | 21:38:24 |

Annotations in the image:

- A box labeled 'Status field' points to the status column.
- An arrow points from the legend 'Data set overwritable' to the status field of the first row.
- An arrow points from the legend 'Data set not overwritable or deletable' to the status field of the second row.
- An arrow points from the legend 'User-defined default setup' to the status field of the last row.

Bottom navigation bar: DELETE ALL : DELETE : EXIT : RECALL : LIST-> PRINTER

External Reference / External Trigger Switchover

The Ext Trig/Ext Ref BNC connector on top of the R&S FSH can be used either as an input for an external trigger or an external reference. Switchover is via the SETUP menu.

- Press the SETUP key.
- Press the HARDWARE SETUP softkey.
- Using the rotary knob or the cursor keys, select the menu item and confirm your choice with the ENTER key or the BNC I/O MODE softkey.

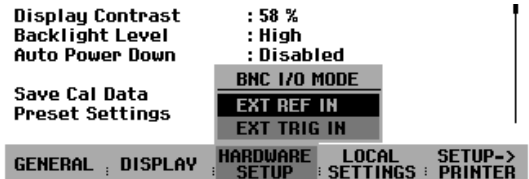

The screenshot shows the 'HARDWARE SETUP' menu with the following options:

- Display Contrast : 58 %
- Backlight Level : High
- Auto Power Down : Disabled
- BNC I/O MODE (highlighted)
- EXT REF IN
- EXT TRIG IN

Bottom navigation bar: GENERAL : DISPLAY : HARDWARE SETUP : LOCAL SETTINGS : SETUP-> PRINTER

The active input setting (EXT TRIG or EXT REF) is highlighted in green.

- Using the rotary knob or cursor keys, select EXT REF IN or EXT TRIG IN.
- Confirm with the ENTER key or the HARDWARE SETUP softkey.

The EXT TRIG IN setting is only for input configuration. The use of the external trigger must be set in the SWEEP menu (SWEEP key, TRIGGER softkey).

The input setting can be queried via the status display (press the STATUS key).

Controlling the RF Attenuator

Depending on the selected reference level, the R&S FSH sets the attenuator on the RF input to a suitable value. It offers two modes: one for the highest possible sensitivity (LOW NOISE) and one for the lowest possible intermodulation products (LOW DISTORTION). The difference between the two modes is that the attenuation that the R&S FSH sets for the RF attenuator is 10 dB higher for LOW DISTORTION than for LOW NOISE.

- Press the SETUP key.
- Press the HARDWARE SETUP softkey.
- Using the rotary knob or cursor keys, select DYNAMIC RANGE... from the menu.
- Confirm with the ENTER key or the HARDWARE SETUP softkey.
- Using the rotary knob or cursor keys, select LOW NOISE or LOW DISTORTION.



Confirm with the ENTER key or the HARDWARE SETUP softkey.

Using a Preamp

(Only models 1145.5850.03, 1145.5850.23, 1145.5850.06 and 1145.5850.26.)

The R&S FSH models 1145.5850.03, 1145.5850.23, 1145.5850.06 and 1145.5850.26 come with an internal preamplifier for increasing sensitivity. Depending on the frequency, this amplifier has 15 dB to 18 dB gain and increases sensitivity by 10 to 15 dB. It is fitted behind the RF attenuator and in front of the input mixer.

- Press the SETUP key.
- Press the HARDWARE SETUP softkey.
- Using the rotary knob or cursor keys, select PREAMP... .
- Confirm with the ENTER key or the HARDWARE SETUP softkey.

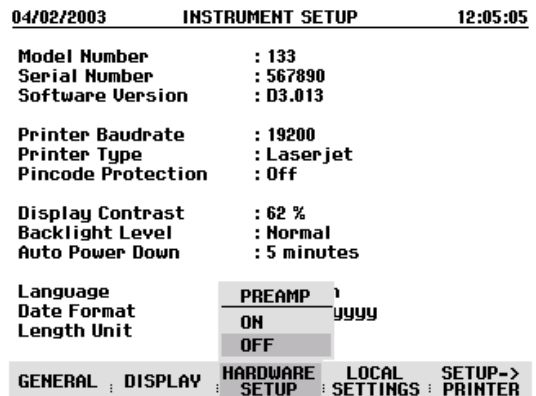

The R&S FSH changes to the submenu for preamplifier configuration. The selection bar indicates the active setting.

- Using the rotary knob or cursor keys, select the setting you want (ON or OFF) and confirm by pressing the ENTER key.

If the preamplifier is switched on, its use is coupled to the reference level, thus ensuring the optimum dynamic range of the R&S FSH at all times. The table below shows the positions of the RF attenuator and the preamplifier as a function of the reference level.

| Reference level | Preamplifier OFF | | Preamplifier ON | | |
|--------------------|------------------|----------------|-----------------|----------------|--------------|
| | RF attenuation | | RF attenuation | | Preamplifier |
| | Low Noise | Low Distortion | Low Noise | Low Distortion | |
| ≤-25 dBm | 0 dB | 0 dB | 0 dB | 0 dB | On |
| -24 dBm to -20 dBm | 0 dB | 0 dB | 10 dB | 10 dB | On |
| -19 dBm to -15 dBm | 0 dB | 10 dB | 10 dB | 10 dB | On |
| -14 dBm to -10 dBm | 0 dB | 10 dB | 0 dB | 10 dB | Off |
| -9 dBm to 0 dBm | 10 dB | 20 dB | 10 dB | 20 dB | Off |
| 1 dBm to 10 dBm | 20 dB | 30 dB | 20 dB | 30 dB | Off |
| 11 dBm to 20 dBm | 30 dB | 30 dB | 30 dB | 30 dB | Off |

The attenuator position can be queried at any time via the status display.

PIN Entry

To prevent unauthorized use, the R&S FSH can be protected with a personal identification number (PIN).

When the R&S FSH is delivered, the PIN is set to 0000 and PIN entry is disabled when the R&S FSH is switched on. A PIN, i.e. a four-digit number, can be re-entered whenever you wish. But it is not activated until the PIN mode has been enabled.

A new PIN is entered as follows:

- Press the SETUP key to call up the SETUP menu and the instrument settings.
- Press the GENERAL softkey.

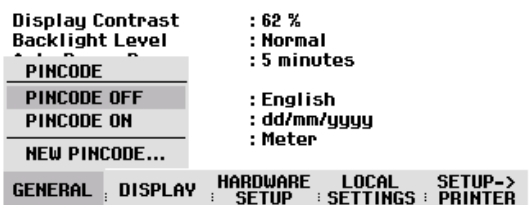

Using the rotary knob or cursor keys, select PINCODE... from the menu and press the ENTER key. The selection box with the PIN settings is opened.

The current PIN must be entered before it can be modified. This prevents unauthorized PIN modification.

- Enter your valid PIN.

When the R&S FSH is delivered, the valid PIN is 0000.

After you enter your valid PIN, the PIN functions can be selected from the selection box. When the R&S FSH is delivered, a new PIN can be activated only if it differs from the factory-set PIN.

Note: Before you activate the PIN mode, enter a user-defined PIN. Keep your PIN in a secure place away from the R&S FSH. If the active PIN is not available, the instrument can be reset to the default PIN ('0000') with the master PIN supplied with each instrument. If the master PIN is not available, please contact an authorized Rohde & Schwarz service center.

Entering a new PIN

- Using the rotary knob or cursor keys, select New Pincod... from the menu in the selection box and enter a new four-digit PIN. Confirm with ENTER.

The R&S FSH will prompt you to re-enter the PIN in order to prevent incorrect entries.

- Re-enter the PIN.

Activating the PIN mode

- Using the rotary knob or cursor keys, select PINCODE ON from the menu and press the ENTER key.

The R&S FSH now prompts you to enter the PIN prior to its activation.

- Enter the PIN and confirm with the ENTER key.

The selected PIN is now activated. The next time you switch on the R&S FSH, you must enter the PIN before you can operate the instrument. If you enter an incorrect PIN, the R&S FSH again prompts you for the PIN code. After three attempts with an incorrect PIN, the R&S FSH prompts you for the master PIN.

Note: The R&S FSH comes with labels reading 'PIN Code protected'. If the instrument is protected with a PIN, affix one of these labels to the instrument. This warns unauthorized users that they cannot operate the R&S FSH.

Deactivating PIN protection

➤ Using the rotary knob or cursor keys, select PINCODE OFF from the menu and press the ENTER key.

Prior to deactivation, the R&S FSH prompts you to enter your PIN. This prevents unauthorized deactivation of PIN protection.

➤ Enter your PIN number and confirm with the ENTER key.

The R&S FSH can now be operated without PIN protection.

Connecting Printers

The R&S FSH can output a screenshot to a printer equipped with an RS-232-C interface. The Serial/Parallel Converter R&S FSH-Z22 is available as an accessory for printers with a parallel interface.

A printer with an RS-232-C interface can be directly connected using the R&S FSH-Z34 RS-232-C optical cable.

- Fold out the stand at the rear of the R&S FSH.
- Connect the optical connector of the R&S FSH-Z34 RS-232-C cable to the optical interface on the right-hand side of the R&S FSH.
- Connect the 9-pin D-Sub connector of the cable to the RS-232-C input of the printer.

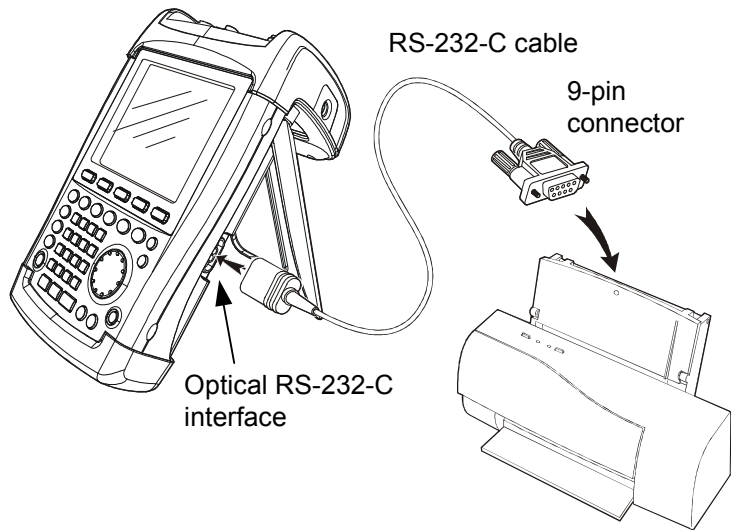

Connect printers with a parallel interface to the R&S FSH using the Serial/Parallel Converter R&S FSH-Z22, thus freeing up the Centronics parallel interface to connect a printer. The R&S FSH-Z22 is powered by a 9 V alkaline battery (NEDA, IEC6LR61).

- Fold out the stand at the rear of the R&S FSH.
- Connect the optical connector of the R&S FSH-Z22 to the optical interface on the right-hand side of the R&S FSH.
- Connect the printer cable to the 25-pin interface of the R&S FSH-Z22.
- Switch on the serial/parallel converter using the slide switch on its top.

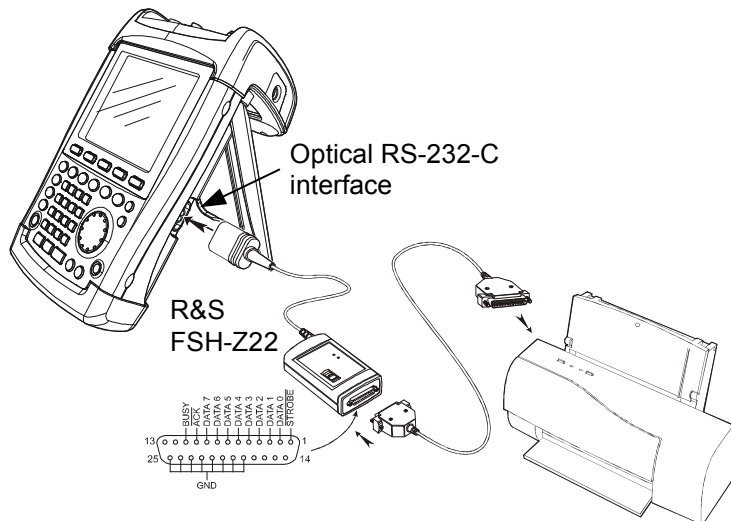

Slide switch positions:

- OFF The R&S FSH-Z22 is off.
- ON The R&S FSH-Z22 is on, and the Battery OK LED flashes.
- AUTO OFF The R&S FSH-Z22 is on, and the Battery OK LED flashes. If data transmission is interrupted for more than 5 minutes, the R&S FSH-Z22 is switched off automatically.

While data is being transmitted to the printer, the "Busy" LED remains lit.

Note: The R&S FSH-Z22 is designed for a data transmission rate of max. 38 400 baud (= default setting). Therefore, set the baud rate (PRINTER BAUD RATE) in the SETUP menu to 38 400 baud. The baud rates 9600 baud and 19 200 baud can also be set on the R&S FSH-Z22 by opening its housing.

Selecting a printer

- Press the SETUP key on the R&S FSH.

The R&S FSH displays the selected printer and its baud rate in the setup settings.

To select another printer, proceed as follows:

- Press the GENERAL softkey.
- Using the rotary knob or cursor keys, select PRINTER TYPE... from the menu and confirm with the ENTER key or by pressing the GENERAL softkey again.
- Using the rotary knob or cursor keys, select the printer you want and confirm with the ENTER key or by pressing the GENERAL softkey again.

The R&S FSH displays the selected printer under "Printer Type".

| | |
|------------------|--------------|
| Printer Baudrate | : 19200 |
| POWER DOWN... | : Laserjet |
| | : Off |
| DATE... | : 62 % |
| TIME... | : Normal |
| PRINTER BAUD... | : 5 minutes |
| PRINTER TYPE... | |
| PINCODE... | : English |
| OPTIONS... | : dd/mm/yyyy |
| FACTORY | : Meter |
| GENERAL | DISPLAY |
| HARDWARE | LOCAL |
| SETUP | SETTINGS |
| SETUP-> | PRINTER |

| | |
|------------------|--------------|
| Display Contrast | : 62 % |
| Backlight Level | : Normal |
| PRINTER TYPE | : 5 minutes |
| DESKJET | |
| LASERJET | : English |
| EPSON FX | : dd/mm/yyyy |
| POSTSCRIPT | : Meter |
| GENERAL | DISPLAY |
| HARDWARE | LOCAL |
| SETUP | SETTINGS |
| SETUP-> | PRINTER |

Next, set the baud rate for the selected printer.

- Press the GENERAL softkey.
- Using the rotary knob or cursor keys, select PRINTER BAUD... from the menu and confirm with the ENTER key.

| | |
|------------------|--------------|
| Printer Baudrate | : 19200 |
| POWER DOWN... | : Laserjet |
| | : Off |
| DATE... | : 62 % |
| TIME... | : Normal |
| PRINTER BAUD... | : 5 minutes |
| PRINTER TYPE... | |
| PINCODE... | : English |
| OPTIONS... | : dd/mm/yyyy |
| FACTORY | : Meter |
| GENERAL | DISPLAY |
| HARDWARE | LOCAL |
| SETUP | SETTINGS |
| SETUP-> | PRINTER |

The selection box for the available baud rates (1200 baud to 115 200 baud) opens.

- Using the rotary knob or cursor keys, select the baud rate you want and confirm with the ENTER key or by pressing the GENERAL softkey a second time.

The R&S FSH displays the selected baud rate under "RS232 Baudrate" in the setup display.

| | |
|------------------|--------------|
| PRINTER BAUDRATE | : Off |
| 1200 Baud | : 62 % |
| 2400 Baud | : Normal |
| 9600 Baud | : 5 minutes |
| 19200 Baud | |
| 38400 Baud | : English |
| 57600 Baud | : dd/mm/yyyy |
| 115200 Baud | : Meter |
| GENERAL | DISPLAY |
| HARDWARE | LOCAL |
| SETUP | SETTINGS |
| SETUP-> | PRINTER |

Note: If the serial/parallel converter (R&S FSH-Z22) is used to control a printer with a parallel interface, set the RS-232-C interface to 38 400 baud.

The contents of the setup display can be output to the printer by pressing the SETUP -> PRINTER softkey.

Setting the Baud Rate for Remote Control

The R&S FSH offers different baud rates for remote control. The desired baud rate is set via the setup menu.

- Press the SETUP key.
- Press the GENERAL softkey.
- Use the rotary knob or the cursor keys to select SERIAL BAUD... from the menu and confirm the selection with the ENTER key.

| | | | | |
|--------------------|------------|----------|----------|---------|
| SAVE CAL DATA... | : 07.001 | | | |
| POWER DOWN... | | | | |
| DATE... | : 115200 | | | |
| TIME... | : 19200 | | | |
| SERIAL BAUD... | : Laserjet | | | |
| PRINTER BAUD... | : Off | | | |
| PRINTER TYPE... | : 50 % | | | |
| PINCODE... | : Normal | | | |
| | : Disabled | | | |
| OPTIONS... | | | | |
| PRESET SETTINGS... | : Off | | | |
| FACTORY | : Default | | | |
| GENERAL | DISPLAY | HARDWARE | LOCAL | SETUP-> |
| | | SETUP | SETTINGS | PRINTER |

The selection box for the available baud rates (9600 baud to 115200 baud) opens.

- Use the rotary knob or the cursor keys to select the baud rate you want and confirm the entry with the ENTER key or by pressing the GENERAL softkey again.

| | | | | |
|-----------------|------------|----------|----------|---------|
| SERIAL BAUDRATE | : 50 % | | | |
| 9600 Baud | : Normal | | | |
| 19200 Baud | : Disabled | | | |
| 38400 Baud | | | | |
| 57600 Baud | : Off | | | |
| 115200 Baud | : Default | | | |
| GENERAL | DISPLAY | HARDWARE | LOCAL | SETUP-> |
| | | SETUP | SETTINGS | PRINTER |

The R&S FSH displays the selected baud rate under SERIAL BAUDRATE in the setup display.

Enabling Options

The R&S FSH can be fitted with options (e.g. distance-to-fault measurements on cables) which are enabled by entering a key code. The key code is based on the unique serial number of the instrument. To add an option, enable it with a key code.

Operation

- Press the SETUP key.
- Press the GENERAL key.
- Using the rotary knob or cursor keys, select OPTIONS... from the menu and confirm with the ENTER key.

Enter the key code (ten-digit number) for the option with the numeric keys and confirm with the ENTER key.

If the correct key code is entered, the R&S FSH displays "<...> Option enabled".

If an invalid key code is entered, the R&S FSH displays "Option key error".

The correct key code can then be entered.

Checking the Installed Options

The R&S FSH displays the installed options in the Setup menu so you can check them:

- Press the SETUP key.
- Using the rotary knob or the cursor keys, scroll the status display downwards.

The R&S FSH displays all available options together with their current status.

| 24/09/2004 | INSTRUMENT SETUP | 10:27:35 |
|-------------------------|------------------|----------|
| Display Contrast | : 75 % | ▲ |
| Backlight Level | : High | |
| Auto Power Down | : Disabled | |
| Save Cal Data | : On | |
| Preset Settings | : Custom | |
| Language | : English | |
| Date Format | : dd/mm/yyyy | |
| Length Unit | : Meter | |
| Distance to Fault (B1) | : Installed | |
| Vector Calibration (K2) | : Installed | |
| Remote Control (K1) | : Installed | |
| Receiver Mode (K3) | : Installed | |

| | | | | |
|---------|---------|----------|----------|---------|
| GENERAL | DISPLAY | HARDWARE | LOCAL | SETUP-> |
| : | : | SETUP | SETTINGS | PRINTER |

2 Getting Started

This section explains the basic operation of the Handheld Spectrum Analyzer R&S FSH using some simple measurements as examples. A more detailed description of operation and functions, such as selecting menus and setting measurement parameters, is provided in section 3 of this manual.

Measurements on CW Signals

A basic task performed by spectrum analyzers is measuring the level and frequency of sinewave signals. The following examples illustrate the most effective way of performing these measurements with the R&S FSH.

A signal generator is used as a signal source, e.g. the Signal Generator R&S SML.

Measurement setup:

Connect the RF output of the signal generator to the RF input of the R&S FSH.

Signal generator settings:

Frequency 100 MHz
Level -30 dBm

Level measurement

First, set the R&S FSH to its default settings to show all the operating steps that are required.

➤ Press the PRESET key.

The analyzer displays the frequency spectrum from 100 kHz to 3 GHz or 100 kHz to 6 GHz (dependent on the model) – the R&S FSH's maximum frequency span. At 100 MHz, the generator signal is displayed as a vertical line. Generator harmonics can also be seen as lines at frequencies that are multiples of 100 MHz.

To analyze the generator signal at 100 MHz in more detail, reduce the frequency span. Set the R&S FSH's center frequency to 100 MHz and reduce the span to 10 MHz.

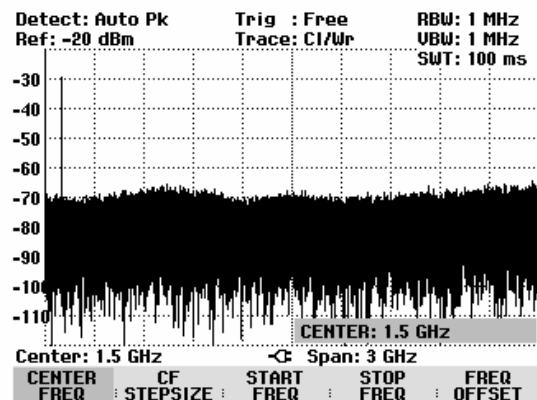

Using markers is also an effective way to shift the trace maximum so that it coincides with the top of the measurement diagram. If the marker is positioned on the trace maximum (as in the example), the reference level can be set to the marker level by entering the following keystrokes:

- Press the MARKER key.
- Press the SET MARKER softkey.
- Select REF LVL = MRK LVL in the submenu by using the rotary knob or the cursor keys.
- Press the ENTER key.

The reference level is then set to the measured level indicated by the marker. Only a few keystrokes are needed to set the optimal reference level.

Frequency Measurements

The R&S FSH's trace displays 301 measurement points (associated with 301 frequency or time points along the x axis). The marker is always positioned on one of these measurement points. The R&S FSH calculates the marker frequency from the measurement-point frequency, and the center frequency and frequency span that have been set. The measurement point resolution and, consequently, the accuracy of the marker-frequency readout therefore depend on the frequency span that has been selected.

The R&S FSH has a frequency counter to increase the accuracy of the marker frequency readout. It stops the sweep at the marker position, counts the frequency and then continues the sweep.

The following measurement example is based on the previous example.

- Press the MARKER MODE softkey in the marker menu.

The marker mode selection box opens.

- Select FREQ COUNT from the selection box using the rotary knob or the cursor keys.
- Press the ENTER key.

The label 'M:' at the upper left-hand corner of the measurement diagram changes to 'Ct:' to tell you that the frequency counter has been switched on. The resolution of the frequency readout is now 1 Hz no matter what span has been set. The accuracy is determined by the R&S FSH's internal reference frequency. It is far higher than that of pixel-oriented, marker-frequency readout.

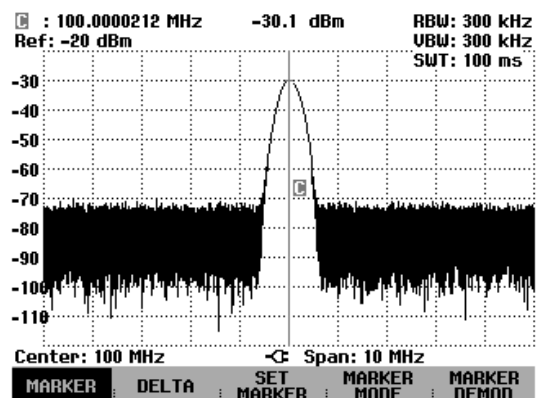

Harmonic Measurements of a Sinewave Signal

Since a spectrum analyzer can resolve different signals in the frequency domain, it is ideal for measuring harmonic levels or harmonic ratios. To speed up these operations, the R&S FSH has marker functions that deliver fast results with only a few keystrokes.

As above, a signal generator with a 100 MHz output frequency and an output level of -20 dBm is used in the following measurement example.

First, the R&S FSH is set to its default settings to show all measurement steps that are needed.

- Press the PRESET key.
The analyzer displays the frequency spectrum from 100 kHz to 3 GHz, the largest available span. At 100 MHz, the generator signal is displayed as a line. The generator harmonics are displayed as lines at frequencies that are multiples of 100 MHz.

To measure the second harmonic ratio, set the start and stop frequency as follows:

- Press the FREQ key.
The softkey menu opens entering the frequency.
- Press the START softkey.
- Enter '50' using the numeric keypad and confirm the entry with the MHz key.
- Press the STOP softkey.
- Enter '250' using the numeric keypad and confirm the entry with the MHz key.

The R&S FSH now displays the spectrum from 50 MHz to 250 MHz and thus the signal at 100 MHz and its second harmonic at 200 MHz.

To measure the harmonic ratio, set the marker on the fundamental and the delta marker on the second harmonic.

- Press the MARKER key.
The softkey menu opens for marker entry and automatically positions the main marker on the trace maximum.
- Press the DELTA softkey.
The delta marker is activated (vertical dotted line) and is automatically placed on the next trace maximum (= second harmonic).

The harmonic ratio in dB can be read directly from the numeric delta-marker display.

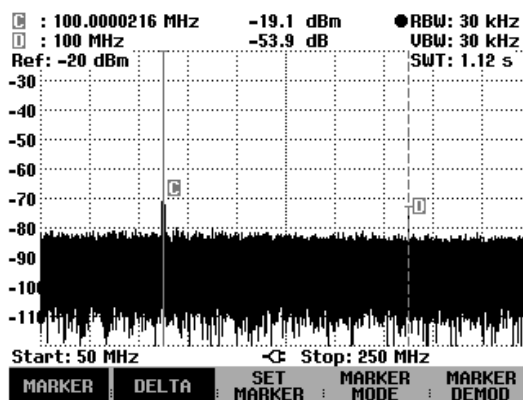

Power Measurements Using the Power Sensor

For highly accurate power measurements, the R&S FSH provides the Power Sensor R&S FSH-Z1 or R&S FSH-Z18 as options. They measure power in the span 10 MHz to 8 GHz or 10 MHz to 18 GHz, respectively.

The Power Sensor R&S FSH-Z1 or R&S FSH-Z18 is controlled and powered via a special RS-232-C interface at the top of the instrument.

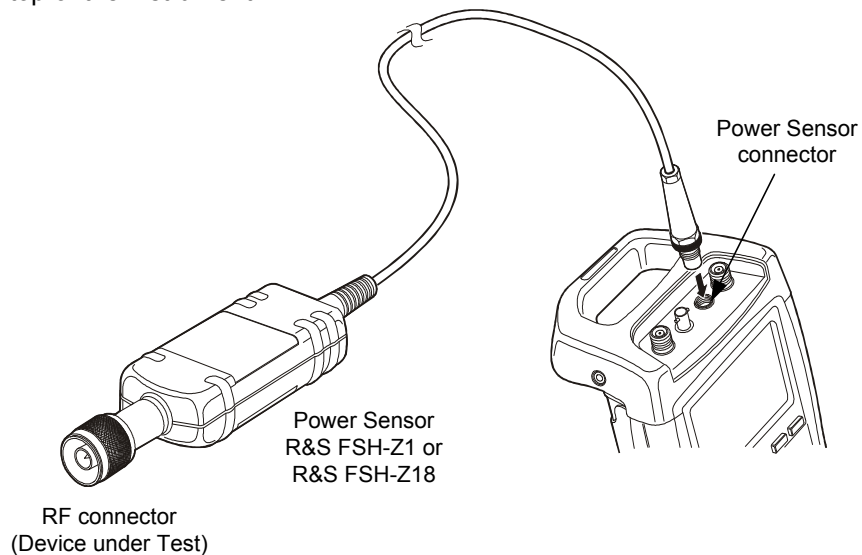

The continuous power applied to the power sensor's input must not exceed 400 mW (26 dBm). However, brief ($\leq 10 \mu\text{s}$) power peaks up to 1 W (30 dBm) are permissible. Higher input powers can destroy the sensor. An attenuator pad must be used to ensure that the maximum permissible power for the sensor is never exceeded when measurements are made on high-power transmitters.

- Connect the power sensor cable to the R&S FSH's power sensor connector and screw it into position.
- Press the MEAS key.
- Press the MEASURE softkey.
- Using the cursor keys or the rotary knob, select the POWER SENSOR menu item and confirm your selection with the ENTER key or the MEASURE softkey.

The R&S FSH opens the screen for power measurements. If a power sensor has not been connected, no measured value is displayed. If a power sensor has been connected, the R&S FSH sets up a connection via the RS-232-C interface and, after a few seconds, displays the measured power.

If there are any communication problems with the power sensor, the R&S FSH outputs error messages (sensor error: error number) indicating the possible causes (see main manual).

To compensate for internal offset of the power meter, it needs to be compensated before starting the measurement.

Power and Return Loss Measurements with the R&S FSH-Z14 or the R&S FSH-Z44

The Directional Power Sensors R&S FSH-Z14 and R&S FSH-Z44 are connected between the source and the load and measure the power flux in both directions, i.e. from the source to the load (forward power) and from the load to the source (reverse power). The ratio between reverse power and forward power is a measure of the load matching and is displayed as the return loss or standing wave ratio.

The R&S FSH-Z14 and the R&S FSH-Z44 have an asymmetrical design and must therefore be inserted into the test setup in such a way that the FORWARD arrow on the sensor points toward the load (= in the direction of the power flux).

They are driven and powered via a special serial interface.

The cable on the power sensor must be connected and screw-fastened to the power sensor connector on the R&S FSH. The directional power sensor itself has to be inserted between the source and the load.

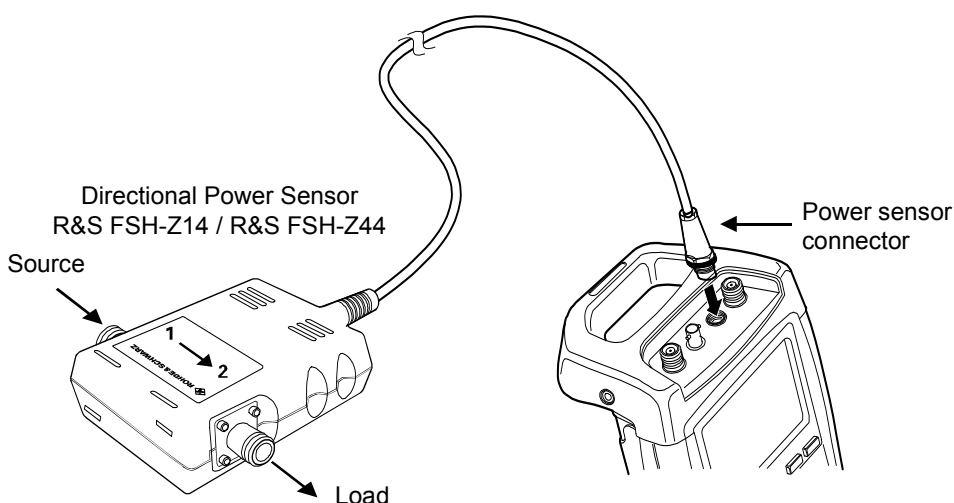

When measuring high powers, pay strict attention to the following instructions to avoid personal injury and to prevent the power sensor from being destroyed:



- *Never exceed the permissible continuous power (see diagram on the rear of the sensor).*
- *Connect the sensor only when the RF power is off.*
- *The RF connectors must be screwed tight.*

Failure to follow these rules can lead to injuries such as skin burns or cause the destruction of the measurement instruments in use.

Operation:

- Press the MEAS key.
- Press the MEASURE softkey.

The R&S FSH opens the menu for the measurement functions.

Using the cursor keys or the rotary knob, select POWER SENSOR and confirm with the ENTER key or by pressing the MEASURE softkey.

The R&S FSH opens the screen and the menu for the power measurement. If no power sensor is connected, no measured value is displayed. If a power sensor is connected, the R&S FSH establishes a connection to the power sensor via the interface and, after a few seconds, displays the connected power sensor type (R&S FSH-Z14 or R&S FSH-Z44) as well as the measured forward power and return loss of the load.

Before performing the power measurement, zero the power sensor.

- Press the ZERO softkey.

The R&S FSH informs you not to apply any signals while the power sensor is being zeroed.

- Disconnect the power sensor from any signal sources.
- Start zeroing with the first or second softkey (CONTINUE).

Softkey 4 or 5 (CANCEL) can be used to cancel zeroing before it begins, e.g. if the signal source cannot be disconnected.

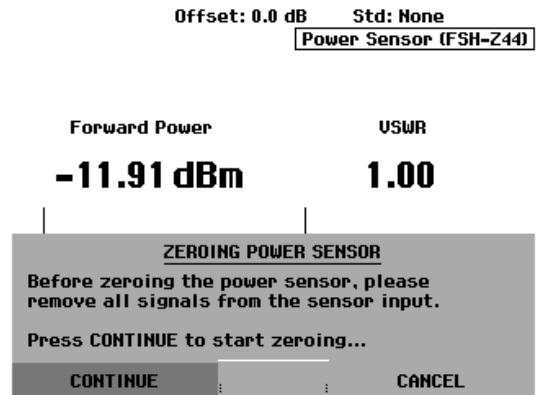

The R&S FSH immediately starts power sensor zeroing. While this is being done, the R&S FSH outputs the message "Zeroing power sensor, please wait...".

When zeroing is over, the R&S FSH outputs the message "Power Sensor Zero OK" and switches back to the softkey menu for the power sensor.

- Now connect the R&S FSH-Z14 or R&S FSH-Z44 between the source and the load.
- The R&S FSH displays the measured forward power level in dBm and the VSWR of the load.

To achieve maximum measurement accuracy, enter the frequency of the signal under test.

- Press the FREQ softkey.

The R&S FSH opens the entry box for the frequency.

- Using the numeric keys, enter the desired frequency and terminate the input with the ENTER key or by pressing the FREQ softkey again.

The R&S FSH transfers the new frequency to the power sensor which then corrects the measured power readings.

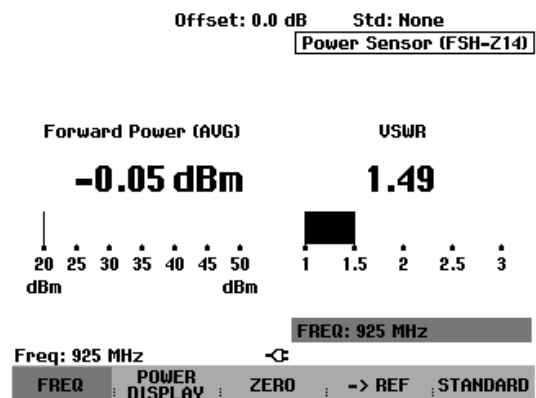

Two-Port Transmission Measurements

(Only for R&S FSH with tracking generator: order no. 1145.5850.13, 1145.5850.23 or 1145.5850.26.)

For measurements of the gain or attenuation of two-port devices, the R&S FSH provides a tracking generator which generates a sinewave signal exactly at the receive frequency of the R&S FSH.

- Press the MEAS key.
- Press the MEASURE softkey.

The measurement function menu opens.

- Using the cursor keys or the rotary knob, select the TRACKING GEN menu item and confirm your selection with the ENTER key or the MEAS softkey.

The R&S FSH switches on the tracking generator and calls up its softkey menu.

When the tracking generator is switched on, the R&S FSH displays Track Gen Uncal. This indicates that tracking generator measurements are uncalibrated.

Before calibration, the span you want should be set because calibration is valid only for the calibrated span. Changing the frequency settings after calibration invalidates calibration.

- Press the FREQ key.
- Using the numeric keys, enter the center frequency.
- Press the SPAN key.
- Using the numeric keys, enter the span.

Alternately, the start and stop frequencies can be entered using the START and STOP softkeys in the frequency menu.

Calibrate the R&S FSH for the transfer function measurement.

The following example shows a scalar measurement of the transmission function. If the option R&S FSH-K2 is installed, the measurement must first be switched to scalar.

- Press the MEAS key.
- Press the MEAS MODE softkey.
- Using the rotary knob or cursor keys, select SCALAR.
- Confirm with the ENTER key or the MEAS MODE softkey.

- In the main menu for the tracking generator, press the MEAS key.
- Press the TRANSM CAL softkey.

The R&S FSH now prompts you to connect the RF input to the tracking generator's output so that calibration can be carried out.

- Connect the RF output to the generator's input without the DUT.
- Press the CONTINUE softkey to start calibration.

During calibration, the R&S FSH outputs the message "Calibrating THROUGH, please wait...".

When calibration has been completed, the R&S FSH outputs the message "Transm. calibrated" for 3 seconds.

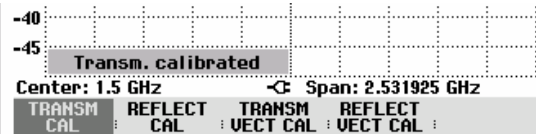
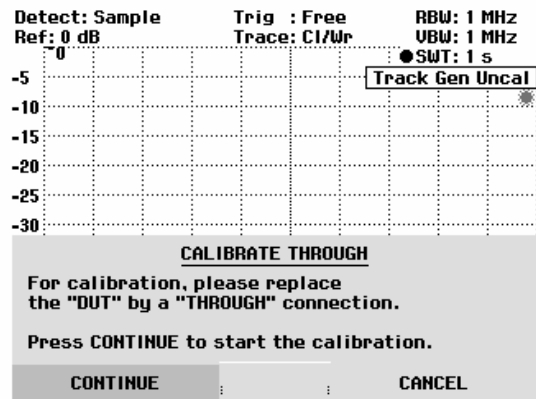

The R&S FSH now displays **Transmission** in the upper right-hand corner of the measurement diagram. This tells you that the R&S FSH has been calibrated for transfer function measurements. In addition, the TRANSM CAL softkey label is highlighted in green.

- Connect the DUT between the RF input and the generator's output.

The R&S FSH displays the magnitude of the transfer function. You can read out values with the markers, for example.

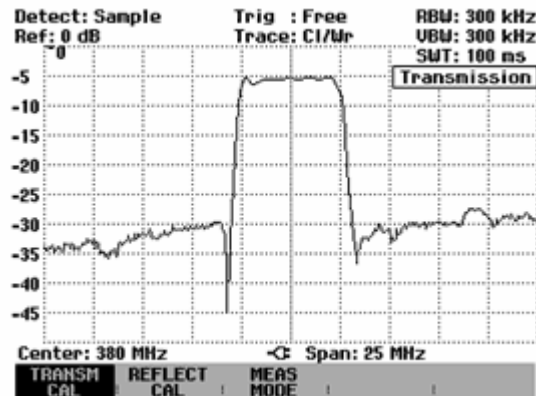
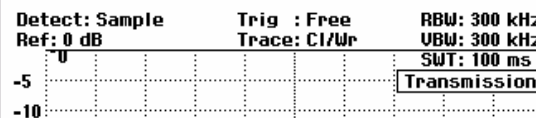

The transmission calibration remains valid until the center frequency or the span is changed on the R&S FSH. **Track Gen Uncal** is displayed in the upper right-hand corner of the screen if the calibration is no longer valid.

If the reference is changed after calibration, greater measurement uncertainty must be anticipated (up to 1 dB). The R&S FSH retains the calibration data but displays a red dot in front of **•Transmission**.

When saving a data set for a scalar transmission measurement in a calibrated state, the R&S FSH can store the calibration data along with the other settings (see section "Saving Calibration Data"). Thus, after the setting is recalled, a measurement can be performed without prior calibration, provided that the instrument's temperature does not deviate more than 5 °C from its temperature when the data set was stored.

If the temperature deviation is greater, the R&S FSH outputs a (red) dot in front of **• Transmission**. A precise measurement can then be made only after a calibration.

Measurement of Return Loss

(Only for R&S FSH with tracking generator: order no. 1145.5850.13, 1145.5850.23 or 1145.5850.26.)

For reflection measurements, the VSWR Bridge and Power Divider R&S FSH-Z2 or R&S FSH-Z3 and a short standard (supplied with the R&S FSH-Z2) are needed. The R&S FSH-Z2 or R&S FSH-Z3 is screw-connected to the RF input connector and the generator's output.

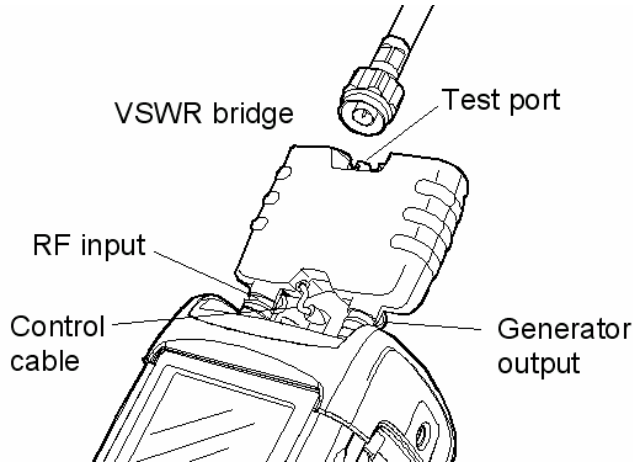

R&S FSH with VSWR Bridge R&S FSH-Z3

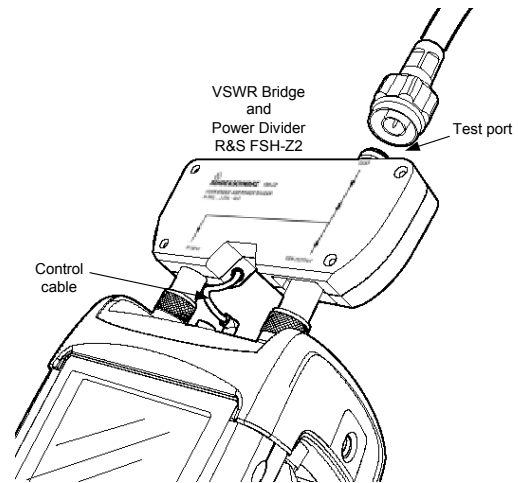

R&S FSH with VSWR Bridge
R&S FSH-Z2

- Connect the control cable of the R&S FSH-Z2/-Z3 to the power sensor connector of the R&S FSH.
- Connect the RF and generator port of the R&S FSH-Z2/-Z3 to the RF input and generator output of the R&S FSH.

The test setup must be calibrated before any measurements are made. This is done with a short and an open at the point where the reflection measurement is to be made. If a cable is to be inserted between the DUT and the bridge, perform the calibration at the measurement end of the cable.

- Press the MEAS key.
- Press the MEASURE softkey.
- Using the cursor keys or the rotary knob, select TRACKING GEN from the menu and confirm with the ENTER key or the MEAS softkey.

The R&S FSH switches on the tracking generator and calls up its softkey menu. Since no calibration has been performed, Track Gen Uncal appears in the upper right-hand corner of the measurement diagram.

Before performing calibration, set the required span because calibration is valid only for the calibrated span. Changing the frequency settings after calibration invalidates calibration.

- Press the FREQ key.
- Using the numeric keys, enter the center frequency.
- Press the SPAN key.
- Using the numeric keys, enter the span.

Alternately, the start and stop frequency can be input using the START and STOP softkeys in the frequency menu.

Calibrate the R&S FSH for the return loss measurement.

The following example shows a scalar measurement of return loss. If the option R&S FSH-K2 is installed, measurement must first be switched to scalar.

- Press the MEAS key.
- Press the MEAS MODE softkey.
- Using the rotary knob or cursor keys, select SCALAR.
- Confirm with the ENTER key or the MEAS MODE softkey.

- In the main menu for the tracking generator, press the REFLECT CAL softkey.

The R&S FSH prompts you to leave the measurement port open.

- Leave the test port of the R&S FSH-Z2 open.
- Using the CONTINUE softkey, start the OPEN calibration.

While calibration is in progress, the R&S FSH outputs the message "Calibrating OPEN, please wait...".

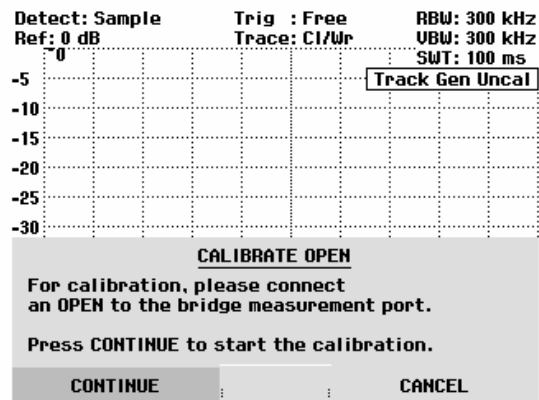

When OPEN calibration is over, the R&S FSH prompts you to perform SHORT calibration.

- Connect a short to the test port of the R&S FSH-Z2.
- Using CONTINUE, start the SHORT calibration.

While calibration is in progress, the R&S FSH outputs the message "Calibrating SHORT, please wait...".

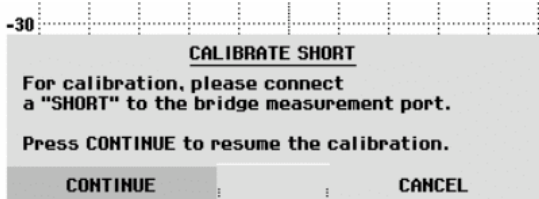

When calibration is over, the R&S FSH outputs the message "Reflect. calibrated" for 3 seconds.

Reflection is displayed in the upper right-hand corner of the measurement diagram to indicate that the R&S FSH is calibrated for reflection measurements.

- Connect the DUT to the measurement port of the R&S FSH-Z2 or R&S FSH-Z3.

The R&S FSH displays the return loss of the DUT.

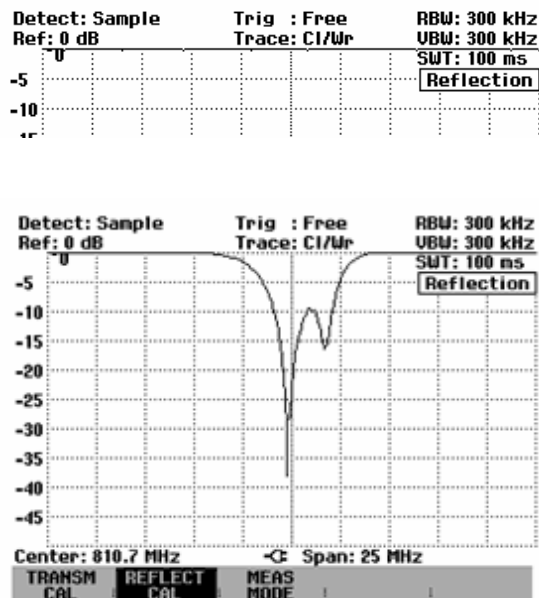

The transmission calibration remains valid until the R&S FSH's center frequency or span is changed. If calibration becomes invalid, the R&S FSH displays **Track Gen Uncal** in the upper right-hand corner of the screen.

If the reference is changed after calibration, a larger measurement uncertainty must be anticipated. The R&S FSH retains the calibration data but places a red dot in front of the **• Reflection** display to indicate possible increase in measurement uncertainty.

When saving a data set for a scalar reflection measurement in a calibrated state, the R&S FSH can store the calibration data along with the other settings (see section "Saving Calibration Data"). Thus, after the setting is recalled, a measurement can be performed without prior calibration, provided that the instrument's temperature does not deviate more than 5 °C from its temperature when the data set was stored.

If the temperature deviation is greater, the R&S FSH outputs a (red) dot in front of **• Reflection**. A precise measurement can then be made only after a calibration.

Performing Distance-To-Fault Measurements

(Only for the R&S FSH with the tracking generator (order no. 1145.5850.13, 1145.5850.23 or 1145.5850.26), installed option R&S FSH-B1 (distance-to-fault measurement) and VSWR Bridge and Power Divider R&S FSH-Z2 or R&S FSH-Z3).

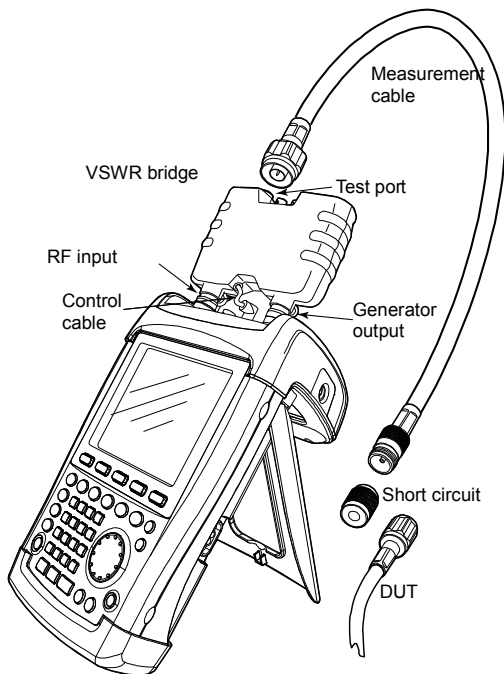

R&S FSH with VSWR Bridge R&S FSH-Z3

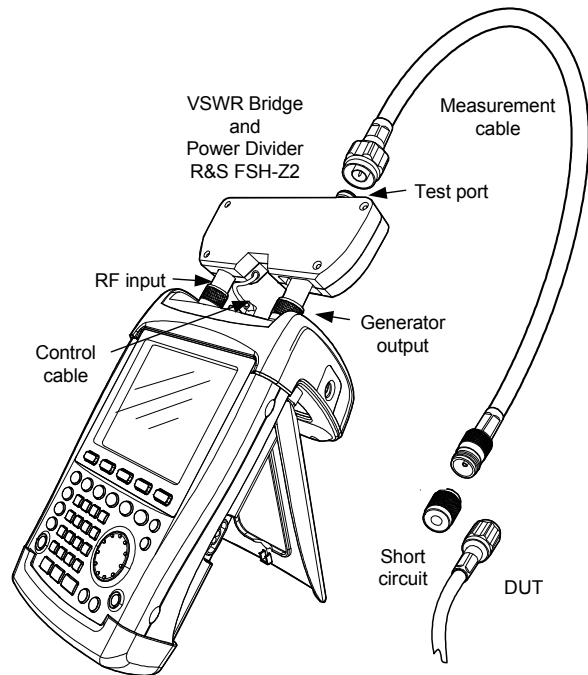

R&S FSH with VSWR Bridge
R&S FSH-Z2

- Connect the control cable of the R&S FSH-Z2 or R&S FSH-Z3 to the power sensor connector of the R&S FSH.
- Connect the RF and generator port of the R&S FSH-Z2/R&S FSH-Z3 to the RF input and generator output of the R&S FSH.
- Connect the 1 m test cable supplied with option R&S FSH-B1 to the bridge test port.

Note: *The 1 m cable must be used. Results are invalid without this cable.*

- Press the MEAS key.
- Press the MEASURE softkey.
- Using the cursor keys or rotary knob, select DISTANCE TO FAULT from the menu and confirm with the ENTER key or the MEAS softkey.

The R&S FSH switches on the distance-to-fault measurement function.

The R&S FSH delivers optimum results if the center frequency is set to the frequency at which the device under test is operated.

- Press the FREQ key.
- Input the center frequency, e.g. frequency of the antenna at the end of the cable under test.

To perform distance-to-fault cable measurements, the R&S FSH needs to be informed about the type of cable and its approximate length. Frequency-dependent cable models can be generated with the supplied R&S FSH View software for Windows and loaded onto the R&S FSH. The procedure is described in the R&S FSH View manual. The cable parameters for a frequency can also be entered directly.

Selecting a cable model from the list:

➤ Press the MEAS key.

➤ Press the CABLE MODEL softkey.

The R&S FSH displays the list of loaded cable models.

➤ Using the rotary knob or the cursor keys, select the appropriate cable model.

➤ Using the SELECT softkey, activate the cable model you have selected.

| 10/06/2003 | CABLE LIST | 10:53:28 |
|---------------|----------------------------|----------|
| RTK161SG | 18/12/2002 18:27:24 | |
| RG8U | 18/12/2002 18:27:24 | |
| RG58C | 18/12/2002 18:27:24 | |
| RG223U | 18/12/2002 18:27:24 | |
| RG214 | 18/12/2002 18:27:24 | |
| RG213U | 18/12/2002 18:27:24 | |
| RG142 | 18/12/2002 18:27:24 | |
| RG141A | 18/12/2002 18:27:24 | |
| LMR900 | 18/12/2002 18:27:24 | |
| LMR600 | 18/12/2002 18:27:24 | |
| LMR1200 | 18/12/2002 18:27:24 | |

The analyzer returns to the DTF measurement menu and displays the cable used for the measurement in the upper right-hand corner of the screen.

| | | | | |
|--------|-----------------|------|-----------------|----------------|
| SELECT | SELECT USER MOD | EXIT | DEFINE USER MOD | LIST-> PRINTER |
|--------|-----------------|------|-----------------|----------------|

Entering the cable parameters at a specific frequency:

If cables are used that are not listed in cable models stored in the R&S FSH, it is possible to enter the cable parameters at a specific frequency. It is advisable to use the center frequency of the DTF measurement.

➤ Press the MEAS key.

➤ Press the CABLE MODEL softkey.

The R&S FSH displays the list of loaded cable models (if available).

➤ Press the SELECT USER MOD softkey.

The softkey is highlighted in green to indicate that a user-specific cable model has been chosen.

The cable model is defined with the DEFINE USER MOD softkey.

| 10/06/2003 | CABLE LIST | 11:02:34 |
|-----------------|----------------------------|----------|
| RTK161SG | 18/12/2002 18:27:24 | |
| RG8U | 18/12/2002 18:27:24 | |
| RG58C | 18/12/2002 18:27:24 | |
| RG223U | 18/12/2002 18:27:24 | |
| RG214 | 18/12/2002 18:27:24 | |
| RG213U | 18/12/2002 18:27:24 | |
| RG142 | 18/12/2002 18:27:24 | |
| RG141A | 18/12/2002 18:27:24 | |
| LMR900 | 18/12/2002 18:27:24 | |
| LMR600 | 18/12/2002 18:27:24 | |
| LMR1200 | 18/12/2002 18:27:24 | |

| | | | | |
|--------|------------------------|------|-----------------|----------------|
| SELECT | SELECT USER MOD | EXIT | DEFINE USER MOD | LIST-> PRINTER |
|--------|------------------------|------|-----------------|----------------|

➤ Press the DEFINE USER MOD softkey.

The R&S FSH opens a submenu for defining the FREQUENCY, the VELOCITY FACTOR and the ATTENUATION.

| |
|--------------------|
| FREQUENCY... |
| VELOCITY FACTOR... |
| ATTENUATION... |

| | | | | |
|--------|-----------------|------|-----------------|----------------|
| SELECT | SELECT USER MOD | EXIT | DEFINE USER MOD | LIST-> PRINTER |
|--------|-----------------|------|-----------------|----------------|

➤ Using the rotary knob or the cursor keys, select the appropriate parameter from the submenu and press the ENTER key.

➤ Enter the value (e. g. velocity factor) for the cable used.

➤ Confirm with the ENTER key.

| |
|----------------------|
| VELOCITY FACT: 1.000 |
|----------------------|

| | | | | |
|--------|-----------------|------|-----------------|----------------|
| SELECT | SELECT USER MOD | EXIT | DEFINE USER MOD | LIST-> PRINTER |
|--------|-----------------|------|-----------------|----------------|

Please refer to the cable manufacturer's data sheet for the velocity factor (= speed of the wave in the cable relative to the speed of light) and the attenuation of the cable per meter or per foot at the specified frequency.

- Use the EXIT softkey to exit the menu for defining the cable model.

The analyzer returns to the DTF measurement menu and displays the cable used for the measurement in the upper right-hand corner of the screen.

The R&S FSH uses the cable length to determine the optimal span for the measurement and for scaling the x axis in DTF mode. For best results, the cable should be specified 20% to 50% longer than the actual cable length.

- Press the CABLE LENGTH softkey.

The R&S FSH opens the cable length (CABLE LEN) value entry box and displays the current length setting.

- Using the numeric keys, enter the cable length in meters and terminate the entry with the ENTER key or one of the unit keys, or
- Using the rotary knob (1 m steps) or the cursor keys (10 m steps), adjust the cable length.

If the unit of length is set to Feet (via SETUP: LOCAL SETTINGS), the entry is in feet.

The minimum cable length is 3 m. The maximum cable length that can be set is 1000 m.

Note: Always enter the cable length before the test setup is calibrated. If it is entered afterwards, measurement accuracy is reduced.

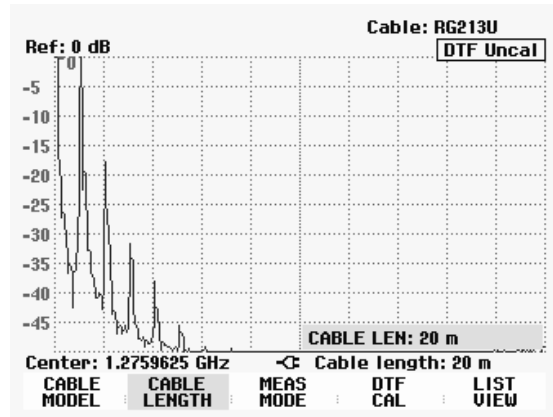

Calibrating the test setup:

The test setup must be calibrated before any measurements are performed.

- Press the DTF CAL softkey.

The R&S FSH opens a text window that prompts you to terminate the measurement cable with a SHORT.

- Firmly screw the SHORT to the output end of the measurement cable.
- Press the CONTINUE softkey to start the SHORT calibration.

While the SHORT calibration is in progress, the R&S FSH outputs the message "Calibrating SHORT, please wait...".

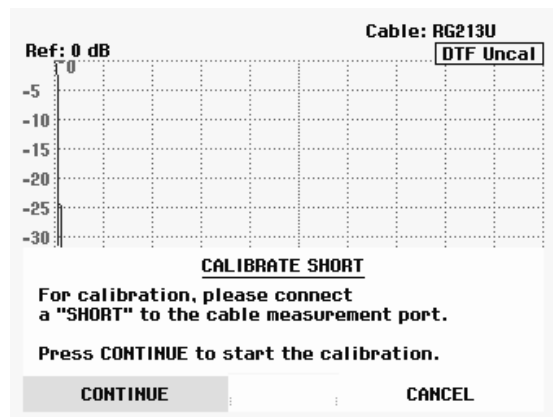

When calibration is over, the R&S FSH displays **DTF CAL** in the upper right-hand corner of the screen.

Calibration tip:

The R&S FSH performs calibration over its entire span. Therefore, recalibration is not necessary after the cable length is changed. The calibration data is stored in the R&S FSH memory. Thus, the calibration is valid after the operating mode is changed or after the instrument is switched off. For a calibration to remain valid, the instrument temperature must not deviate more than 5°C. If the temperature deviates more than this amount, the R&S FSH shows a red dot in front of the DTF display. A new calibration is then necessary.

- Unscrew the short from the measurement cable.
- Screw the cable under test to the measurement cable.

The R&S FSH displays the return loss produced in the cable under test versus the distance.

The R&S FSH can also list any cable faults. It displays the return loss and distance from the measurement plane of all reflections that exceed a definable threshold.

- Press the LIST VIEW softkey.

The R&S FSH opens the threshold value entry box and also displays the threshold as a horizontal line across the measurement diagram.

- Set the threshold using the cursor keys (5 dB steps), the rotary knob (1 dB steps) or the numeric keys.

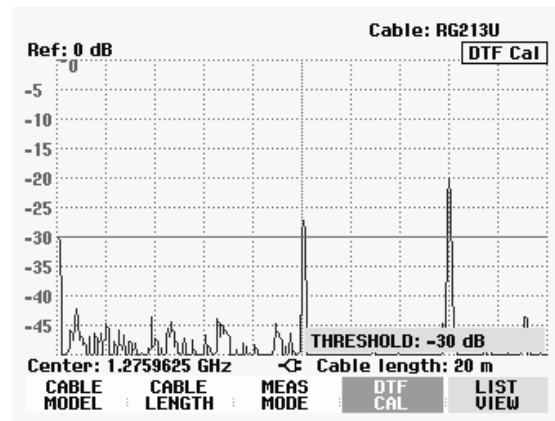

- Press the ENTER key or the LIST VIEW softkey again.

The R&S FSH displays a table listing all the return losses that are above the threshold, sorted according to distance from the measurement plane.

- To close the list and to return to the graphical display mode, press the EXIT softkey.

| Threshold: -30 dB | | Cable: RG213U | |
|-------------------|----------|----------------|--|
| | | Mode : DTF cal | |
| PEAK | DISTANCE | VALUE | |
| 1 | 10.07 m | -27.3 dB | |
| 2 | 16.00 m | -20.0 dB | |

| | | | |
|-----------------------|---|--------------------|------|
| Center: 1.2759625 GHz | | Cable length: 20 m | |
| THRES | : | LIST-> | : |
| HOLD | : | PRINTER | : |
| : | : | : | EXIT |

The distance to the cable faults or the distance between any two faults can also be read out with the marker.

- Press the MARKER key.

The R&S FSH opens the marker menu and places the distance marker on the largest return loss. The marker readout provides the distance of the reflection from the measurement plane in meters and its return loss.

- Change the distance marker by entering a number, adjusting the rotary knob (pixel by pixel) or by using the cursor keys (step = 10 % of the span).

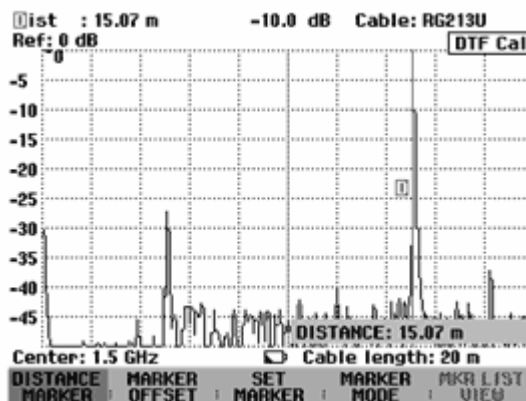

For higher fault resolution, the R&S FSH offers a zoom function in the position of the marker. The x axis of the display can be extended up to a span of 3 m.

- Press the MARKER MODE softkey.
- Using the rotary knob or the cursor keys, select ZOOM ON from the menu.
- Confirm with the ENTER key.

The entry field for the zoom factor is displayed while the R&S FSH simultaneously expands the x axis by a factor of 2.

- Using the rotary knob or the cursor keys, set the zoom factor to the value you want.

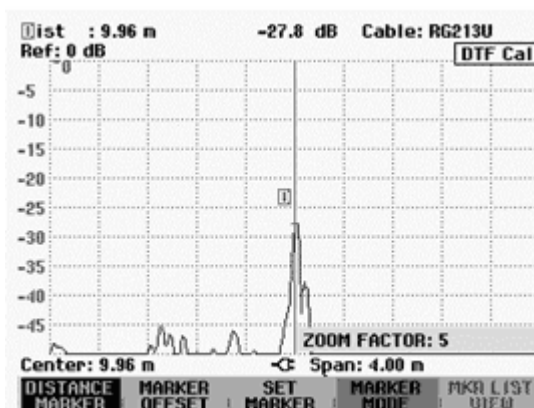

The screenshot on the right shows that the fault of the measured cable consists of two transitions. A coupling of approx. 7 cm in length was used to connect two cables.

Disable the zoom function as follows:

- Press the MARKER MODE softkey in the MARKER menu.
- Using the rotary knob or the cursor keys, select ZOOM OFF from the menu.
- Confirm by pressing the ENTER key or by pressing the MARKER MODE softkey again.

Checking the return loss of the cable under test:

- Press the MEAS MODE softkey.
- Select REFLECTION using the rotary knob or the cursor keys.
- Confirm by pressing the MEAS MODE softkey again or by pressing the ENTER key.

The R&S FSH measures the return loss over the span that has been selected for the distance-to-fault cable measurement.

To indicate that the R&S FSH is measuring return loss, **DTF refl. cal** is displayed in the upper right-hand corner of the screen.

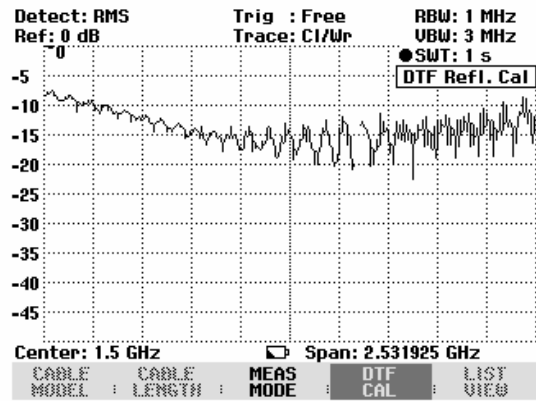

Checking the spectrum in the span for detecting external interferers:

- Press the MEAS MODE softkey.
- Using the rotary knob or cursor keys, select SPECTRUM.
- Confirm by pressing the MEAS MODE softkey again or by pressing the ENTER key.

The R&S FSH turns off the tracking generator and displays the spectrum over the span of the DTF measurement.

To indicate that the R&S FSH is in the spectrum mode, **DTF Spectrum** is displayed in the upper right-hand corner of the screen. Otherwise, the R&S FSH uses exactly the same settings as it did for DTF measurements.

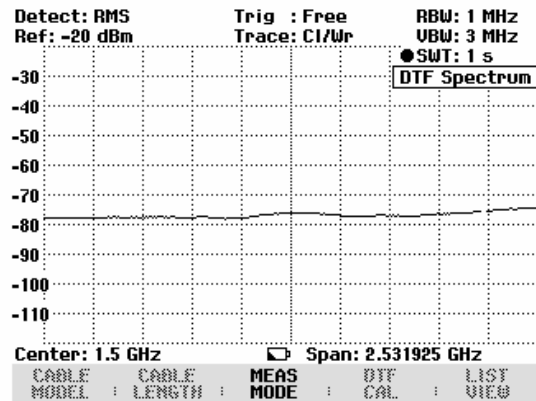

Operation in Receiver Mode

(Available only if the option R&S FSH-K3 is installed.)

To provide a means of measuring levels at a specific frequency, the R&S FSH offers the receiver mode as an option (option R&S FSH-K3). With this option, the R&S FSH functions like a receiver that measures the level at a predefined frequency.

Switching on the receiver mode:

- Press the MEAS key.
- Press the MEASURE softkey.

The menu for measurement functions opens.

- Using the rotary knob or the cursor keys, select RECEIVER from the menu and confirm with the ENTER key or the MEASURE softkey.

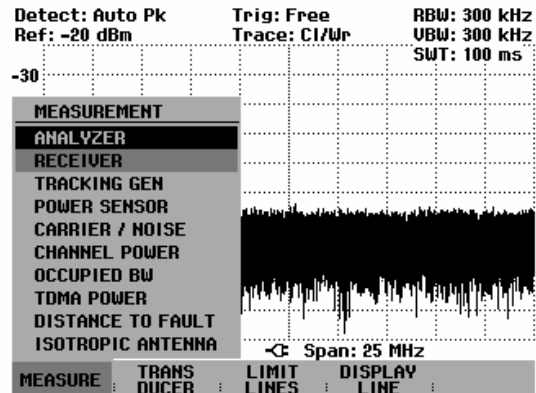

The R&S FSH activates the receiver mode and measures the level at the specified frequency.

The most important settings for the measurement parameters are provided directly in the main menu of the receiver mode, or they can be entered using the corresponding keys.

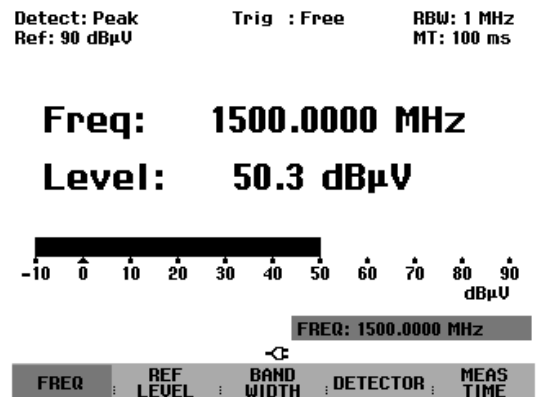

Setting the frequency:

- Press the FREQ softkey in the main menu of the receiver mode.
- Using the rotary knob or the cursor keys, adjust the frequency, or, using the numeric keys, enter a new frequency and confirm the entry with the ENTER key.

You can also enter the frequency by using the FREQ key.

Selecting the frequency step size:

The frequency resolution in the receiver mode is 100 Hz. The tuned step size can be changed as required for the application

- Press the **FREQ** key.
- Press the **FREQ STEPSIZE** softkey.
- Set the required step size in the selection table.
- Confirm with the **ENTER** key.

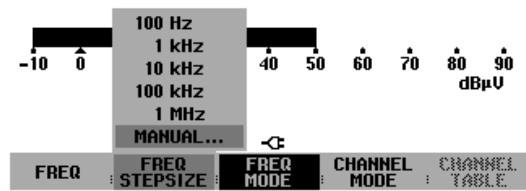

- You can set any step size you want by using **MANUAL....**
- To do so, select **MANUAL...** for the step size in the selection table.
- Using the rotary knob or cursor keys, change the tuned step size and confirm with the **ENTER** key, or, using the numeric keypad, manually enter a step size and confirm by pressing the units key.

Tuning the frequency in channel grids:

As an alternative to entering the frequency, the R&S FSH can also be tuned in channels. The channel tables that the R&S FSH uses to set channel frequencies are defined either by using the R&S FSH View software or by directly entering the first channel number, the associated frequency, the number of channels and the channel spacing.

- Press the **FREQ** key.
- Press the **CHANNEL MODE** softkey.

The R&S FSH now uses the active channel table. The **FREQ** softkey for frequency entry is renamed to **CHANNEL** for channel entry, and the R&S FSH displays the channel number rather than the frequency. The channel numbers are now used to tune the frequency.

Selecting a channel table that was predefined using R&S FSH View:

- If the channel display is active (**CHANNEL MODE** softkey active in the **FREQ** menu), press the **CHANNEL TABLE** softkey.

The R&S FSH will display the stored channel tables.

- Using the rotary knob or cursor keys, select the channel table you want.
- To activate the channel table, press the **SELECT** softkey.

| 01/04/2004 | BAND TABLE LIST | 22:40:09 |
|-----------------|---------------------|----------|
| TU France | 01/03/2004 15:59:02 | |
| TU Japan | 01/03/2004 14:58:52 | |
| TU DK_DIRT | 01/03/2004 14:40:20 | |
| TU Australia | 01/03/2004 14:40:08 | |
| TU Europe | 01/03/2004 14:39:56 | |
| TU China | 01/03/2004 14:34:40 | |
| TU Italy | 01/03/2004 14:30:40 | |
| TU Ireland | 01/03/2004 14:30:26 | |
| TU French Overs | 01/03/2004 14:30:16 | |
| PCS UL | 01/01/1995 02:00:00 | |
| PCS DL | 01/01/1995 02:00:00 | |
| GSM UL | 01/01/1995 02:00:00 | |
| GSM DL | 01/01/1995 02:00:00 | |



Direct entry of a channel table:

- If the channel display is active (CHANNEL MODE softkey active in the FREQ menu), press the CHANNEL TABLE softkey.
- Press the SELECT USER TAB softkey.

The R&S FSH will use the last channel table that was entered directly.

- Press the DEFINE USER TAB softkey.

The R&S FSH will open the submenu for defining the channel table.

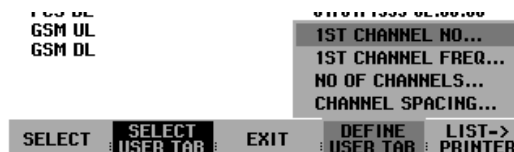

- Press the DEFINE USER TAB softkey again.
- Enter the number of the first channel and confirm with the ENTER key.
- Press the DEFINE USER TAB softkey.
- Using the rotary knob or the cursor keys, select 1ST CHANNEL FREQ... from the menu and confirm with the ENTER key.
- Enter the frequency for the first channel number.
- Press the DEFINE USER TAB softkey.
- Using the rotary knob or the cursor keys, select NO OF CHANNELS... from the menu and confirm with the ENTER key.
- Enter the number of channels and confirm with the ENTER key.
- Press the DEFINE USER TAB softkey.
- Using the rotary knob or the cursor keys, select CHANNEL SPACING... from the menu and confirm with the ENTER key.
- Enter the frequency spacing for the channels and confirm with the ENTER key.
- Press the EXIT key to exit the menu for defining channel tables.

The R&S FSH will now show channel numbers rather than the frequency. It also shows the associated frequency above Channel.

Selecting the reference level:

The reference level is the maximum level of the analog bar-graph display. It must be set such that the level display is located within the bar-graph scale.

- Press the REF LEVEL softkey in the main menu of the receiver mode (MEAS key). Or press the AMPT key.
- Using the rotary knob or cursor keys, change the reference level or, using the numeric keys, enter a new reference level.
- Confirm with the ENTER key.

Selecting the bandwidth:

The receiver mode provides the same bandwidths as in analyzer operation. In addition, the three bandwidths 200 Hz, 9 kHz and 120 kHz are available for EMI measurements in accordance with CISPR16.

- Press the BW key
- Using the rotary knob or cursor keys, change the bandwidth and confirm with the ENTER key, or, using the numeric keypad, manually enter bandwidth and confirm by pressing the units key.
- For input of a CISPR bandwidth press the softkey CISPR BW.
- Using the rotary knob or cursor keys, change the bandwidth and confirm with the ENTER key, or, using the numeric keypad, manually enter bandwidth and confirm by pressing the units key.

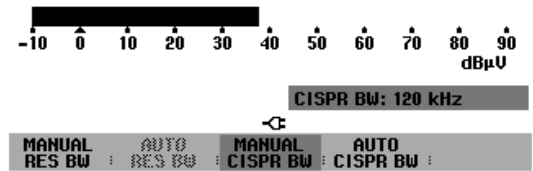

According to CISPR16 the bandwidth is connected to the frequency. The R&S FSH allows to couple the bandwidth to the set frequency automatically:

- Press the softkey AUTO CISPR BW.

The R&S FSH uses the suitable bandwidth dependent on the set frequency.

Setting the detector:

The receiver mode of the R&S FSH offers a peak detector, average detector, RMS detector and quasi-peak detector.

Set the detector either from the main menu of the receiver mode or by using the TRACE key.

- Press the DETECTOR softkey in the main menu of the receiver mode, or press first the TRACE key and then the DETECTOR softkey
- Using the rotary knob or cursor keys, select a detector from the selection list.
- Press the ENTER softkey.

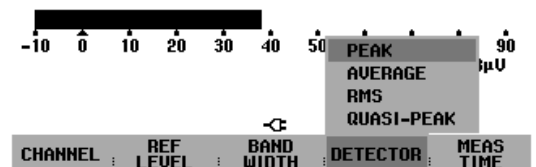

Setting the measurement time:

The measurement time is the amount of time during which the R&S FSH collects measured values and compiles them into a display result for the selected detector.

- Press the MEAS TIME softkey in the main menu of the receiver mode, or press the SWEEP key.
- Using the rotary knob or cursor keys, adjust the measurement time, or, using the numeric keys, enter a new measurement time and confirm with the unit.

Note: *If the quasi-peak detector is selected, the selected measurement time must be larger than 100 ms in order to ensure that fluctuating or pulse-like signals are measured correctly.*

Scanning in the receiver mode:

In the receiver mode, the R&S FSH can scan across a defined number of frequencies and graphically display the results. It performs a measurement at each frequency for the defined measurement time.

- Press the SPAN softkey.
- Press the FREQ SCAN softkey.

The R&S FSH switches to the scan mode and displays the measurement levels at the individual frequencies as vertical lines.

- Press the SCAN START softkey.
- Enter the start frequency for the scan.
- Press the SCAN STOP softkey.
- Enter the stop frequency for the scan.
- Press the SCAN STEP softkey.
- Enter the step size for the scan.

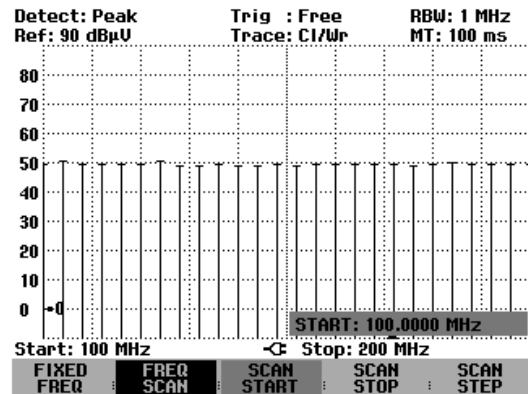

It is also possible to scan the frequencies of a channel table. This requires activating a channel table as follows:

- Press the FREQ softkey.
- Press the CHANNEL MODE softkey.

The R&S FSH now performs a measurement at the frequencies of the channel table.

Measuring the Carrier-to-Noise Ratio

(Available as of firmware version 8.0 or higher.)

The R&S FSH offers a carrier/noise measurement for measuring the ratio of carrier power to noise power. It performs the measurement in two steps. First, the carrier power of a transmission channel is measured or a reference power determined which is then used for C/N calculation. In the second step, the R&S FSH measures the noise power of an unoccupied transmission channel and calculates the ratio of carrier power to noise power.

Determining the carrier power (reference power or reference level)

The R&S FSH offers the carrier power measurement for three different types of modulation.

- Digital Tx
In the Digital Tx operating mode, the channel power of a reference channel is measured. This is common with digitally modulated carriers where power is equally distributed, i.e. the carrier power is independent of the modulation signal.
- Analog TV
In the Analog TV operating mode, the peak power of the vision carrier is measured. This is common with amplitude-modulated TV signals.
- CW Tx
In the CW Tx operating mode, the power of an unmodulated carrier is measured.
- Manual entry of a reference power or a reference level
You can also enter a reference power or reference level manually. The R&S FSH then uses this value for C/N calculation.

Noise power and C/N power ratio

For noise power measurements, the R&S FSH is set to an unoccupied transmission channel where it measures the noise power in accordance with the selected channel bandwidth. If required, the R&S FSH also displays the power ratio with reference to the noise power density of the transmission channel (C/N_0). $C/N_0 = C/N + 10 \lg(\text{channel bandwidth}/\text{Hz})$

Activating the C/N measurement:

- Press the MEAS key.
- Press the MEASURE softkey.

The menu for measurement functions opens.

- Using the rotary knob or the cursor keys, select CARRIER / NOISE from the menu and confirm your choice with the ENTER key or the MEASURE softkey.

The R&S FSH activates the carrier/noise mode and starts the carrier power measurement that was selected last.

The major measurement parameter settings are available directly in the main menu of the carrier/noise measurement or can be entered using the appropriate keys.

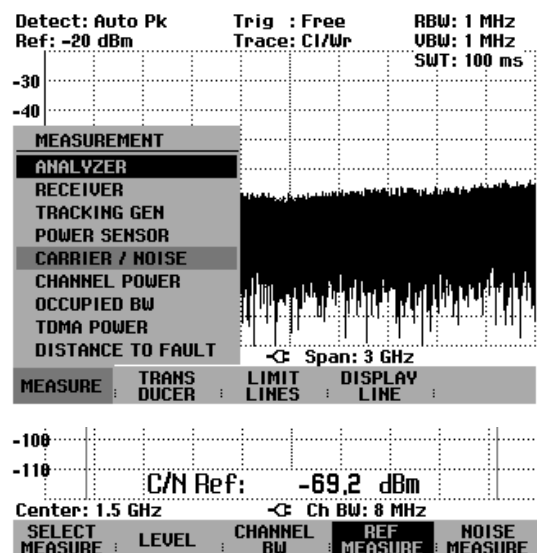

Reference power/reference level

To determine the reference, you need to enter the type of reference measurement, the reference channel and the channel bandwidth of the reference channel.

Selecting the reference measurement:

- Press the SELECT MEASURE softkey.
- Using the rotary knob or the cursor keys, select the desired measurement method to determine the reference carrier power (Digital Tx, Analog TV or CW Tx) and confirm your choice with the ENTER key or the F1 softkey.

The R&S FSH measures the reference in accordance with the selected modulation method.

Selecting the reference channel:

- Press the REF MEASURE softkey.
- Using the rotary knob or the cursor keys, select the desired entry (Channel, Vision Carrier Freq, Center Freq or 8VSB Pilot Freq) and confirm your choice with the ENTER key or the F4 softkey.

You can alternatively also enter the channel center frequency after pressing the FREQ function key.

The R&S FSH measures the reference in the selected transmission channel.

Entering the channel bandwidth of the reference channel:

- If the reference measurement is active, press the CHANNEL BW softkey.
- Enter the desired value and terminate the entry with the appropriate unit key.

The R&S FSH sets the span in accordance with the selected bandwidth.

The channel center frequency is calculated when the vision carrier frequency is entered.

Selecting the reference unit:

- Press the LEVEL softkey.
- Using the rotary knob or the cursor keys, select the desired entry (dBm, dBmV or dB μ V) and confirm your choice with the ENTER key or the F2 softkey.

The measurement result of the reference measurement is displayed in the selected unit.

Manual reference entry:

- Press the REF MEASURE softkey.
- Using the rotary knob or the cursor keys, select MAN REF POWER/LEVEL and confirm with the ENTER key or the REF MEASURE softkey.
- Enter the desired reference value in the selected reference unit by means of the numeric keypad and terminate the entry with one of the unit keys.

Automatic levelling:

- If the reference measurement is active, press the LEVEL softkey.
- Using the rotary knob or the cursor keys, select LEVEL ADJUST and confirm your choice with the ENTER key or the F2 softkey.

Depending on the input signal, the R&S FSH is optimally levelled.

Measuring the noise power

Enter an unoccupied transmission channel and its channel bandwidth to determine the noise power.

Selecting the result display:

- Press the SELECT MEASURE softkey.
- Using the rotary knob or the cursor keys, select the desired result display (C/N or C/N₀) and confirm your choice with the ENTER key or the F1 softkey.

The R&S FSH outputs the power ratio according to the selected result display.

Selecting the unoccupied transmission channel:

- Press the NOISE MEASURE softkey.
- Using the rotary knob or the cursor keys, select the desired entry (Channel, Vision Carrier Freq, Center Freq or 8VSB Pilot Freq) and confirm your choice with the ENTER key or the F5 softkey.

You can alternatively also enter the channel center frequency after pressing the FREQ function key.

The R&S FSH measures the noise power in the selected transmission channel.

Entering the channel bandwidth of the noise channel:

- If the noise power measurement is active, press the CHANNEL BW softkey.
- Enter the desired value and terminate the entry with the appropriate unit key.

The R&S FSH sets the span in accordance with the selected bandwidth.

The channel center frequency is calculated when the vision carrier frequency is entered.

Automatic levelling:

- If the noise power measurement is active, press the LEVEL softkey.
- Using the rotary knob or the cursor keys, select LEVEL ADJUST and confirm your choice with the ENTER key or the F2 softkey.

Depending on the input signal, the R&S FSH is optimally levelled.

Blanking out the result display:

The C/N ratio or the reference is indicated at the bottom of the display. This insertion can be deactivated.

- Press the NOISE MEASURE or REF MEASURE softkey.
- Using the rotary knob or the cursor keys, select DISPLAY OFF and confirm your choice with the ENTER key or the F4 or F5 softkey.

The R&S FSH blanks out the result display.

Inserting the result display:

- Press the NOISE MEASURE or REF MEASURE softkey.
- Using the rotary knob or the cursor keys, select DISPLAY ON and confirm your choice with the ENTER key or the F4 or F5 softkey.

The R&S FSH inserts the result display at the bottom of the display.

Saving and Recalling Settings and Test Results

Instrument settings and results can be saved to the R&S FSH's internal CMOS RAM. Results and settings are always stored together, allowing them to be interpreted in context when recalled. The R&S FSH can store a maximum of 100 data sets, each with a unique name.

Saving Measurement Results

- Press the SAVE / PRINT key.
- Press the SAVE softkey.

An input box opens and you will be prompted to enter a name for the data set to be saved.

The name for the most recently stored data set is suggested in the 'Name:' entry box, which is highlighted in red. When you press the ENTER key or the SAVE softkey a second time, the data set is saved under the suggested name.

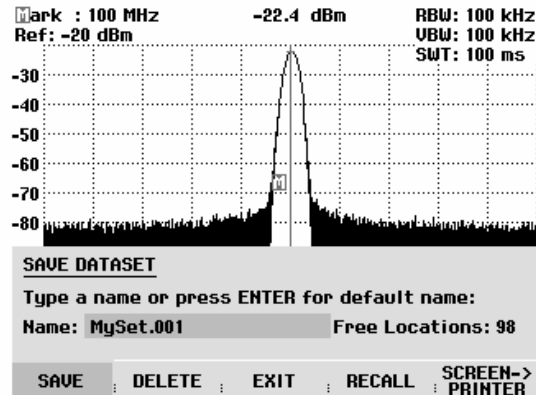

By pressing the BACK key, you can instruct the R&S FSH to browse through the list of names of the data sets already stored and display them with the first available free extension. Thus, the name of the data set recalled for a specific measurement can be selected for storing the measurement data.

A new name can be entered via the numeric keypad. The numeric keypad has the same letter assignment as mobile phone keypads. Enter the letter above the key by pressing the key the appropriate number of times.

The number of free memory locations is also displayed.

- Enter a name for the data set using the numeric keypad.
- Confirm with ENTER.

The data set is saved to the R&S FSH's internal memory under the specified name.

The name of an existing data set can be edited with the cursor keys. It is therefore not necessary to fully enter the name of a new data set.

- Press the SAVE key.

The R&S FSH suggests a name for the data set to be saved.

- Press a cursor key (^ or v).

A vertical cursor is positioned at the end of the name for the data set.

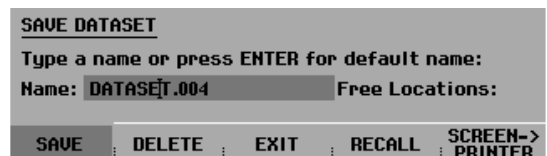

- Use the \vee key to move the cursor to the left.
- Use the \wedge key to move the cursor to the right.
- Insert a new letter or number at the cursor position using the alphanumeric keypad.
- Press the BACK key to delete the letter or digit to the left of the cursor.

Saving Calibration Data

When performing scalar transmission or return loss measurements, the R&S FSH can store the calibration data along with the settings and results. Saving the settings and results with calibration data requires twice as much memory space as without it. This, of course, reduces the maximum number of data sets that can be saved. With the R&S FSH6 and R&S FSH3 model 23 (from serial number 102314), you can now also save the calibration data for the vector measurement of the transmission or of the reflection.

In the default state, calibration data storage is disabled.

- Press the SETUP key.
- Press the GENERAL softkey.
- Select SAVE CAL DATA... and confirm by pressing the ENTER key or the GENERAL softkey.
- Using the rotary knob or the cursor keys, select ON or OFF.
- Confirm with ENTER.

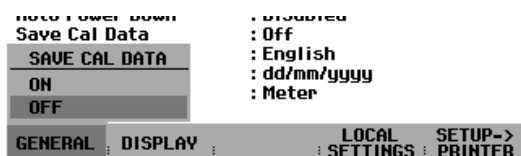

The state for calibration data saving is entered in the SETUP menu.

When recalling data sets with stored calibration data, the R&S FSH checks whether the current instrument temperature corresponds to the instrument temperature at the time the data was stored. If it deviates more than 5°C, the R&S FSH displays a red dot in front of the • Transmission or • Reflection display. Recalibration is then necessary.

Recalling Measurement Results

Use the R&S FSH's recall function to review previously saved measurement results and settings.

- Press the SAVE / PRINT key.
- Press the RECALL softkey.

A list of all saved data sets opens. The red selection bar marks the last data set to be saved.

| 09/12/2002 | DATASET LIST | 17:08:48 |
|------------|---------------------|----------|
| MySet.000 | 09/12/2002 17:04:54 | |
| rs.001 | 06/03/2002 10:43:24 | |
| rs.000 | 01/03/2002 12:10:43 | |

- Select a data set from the list using the rotary knob.
- Confirm your selection by pressing the RECALL softkey.

The selected data set is displayed on the screen, but the R&S FSH is not set to the settings in the data set. You can now check the data set before its settings are activated.

| | | | | |
|------------|--------|------|--------|----------------|
| DELETE ALL | DELETE | EXIT | RECALL | LIST-> PRINTER |
|------------|--------|------|--------|----------------|

The name of the selected data set is displayed at the lower left-hand corner of the screen. Using the rotary knob or the cursor keys, you can scroll through all the available data sets. The settings and results for each data set are displayed.

You now have the following options:

- Press the STATUS key to see all the instrument settings in the selected data set. When you press the STATUS key again, the R&S FSH returns to the graphical display.
- Press the ACTIVATE softkey to load the data set.
- Press the EXIT softkey to display the list of data sets again. Press EXIT a second time and the R&S FSH returns to its previous settings without loading a data set.
- Press SCREEN->PRINTER to send the displayed data set to a printer.

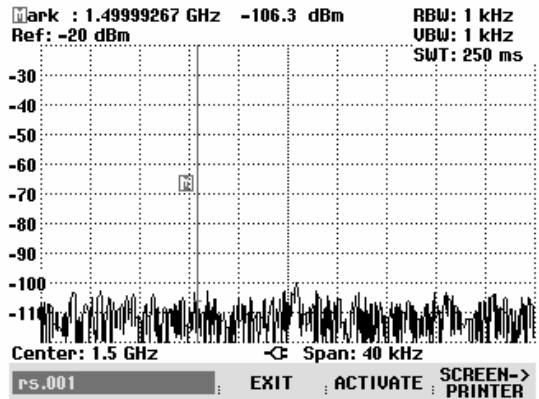

Pressing the ACTIVATE softkey transfers the stored trace to the R&S FSH's trace memory. The current trace can be compared with the stored one by switching on the trace memory.

- Press the TRACE key.
- Press the SHOW MEMORY softkey.

The R&S FSH displays the stored trace in white and the current trace in yellow.

Note: The trace is in the R&S FSH's trace memory. The level and frequency values are displayed correctly only if neither the instrument's frequency setting nor its level setting have been changed.

Printing Out Measurement Results

The R&S FSH can send screenshots to a printer equipped with a serial interface. The type of printer and the baud rate of the serial interface can be defined in the setup menu (SETUP key) by using the GENERAL softkey and selecting 'PRINTER BAUD...' and 'PRINTER TYPE...' from the menu. For printers with a parallel interface, a serial/parallel converter (R&S FSH-Z22) is available.

Printer with serial interface:

- Connect the printer to the optical interface using the RS-232-C optical interface cable R&S FSH-Z34.

Printer with parallel interface:

- Connect the RS-232-C optical interface cable to the Serial/Parallel Converter R&S FSH-Z22.
- Connect the R&S FSH-Z22 parallel interface to the printer.
- Switch on the Serial/Parallel Converter R&S FSH-Z22

Operating the R&S FSH:

- Press the SAVE / PRINT key.

The SAVE/PRINT menu with the option for printing out a screenshot to a printer opens.

- Press the SCREEN->PRINTER softkey.

The R&S FSH starts printing out the screenshot to a printer.

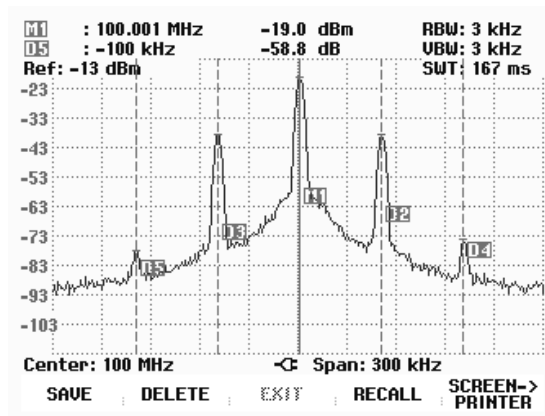

3 Operation

Screen Layout

Screen layout for spectrum-mode measurements without markers

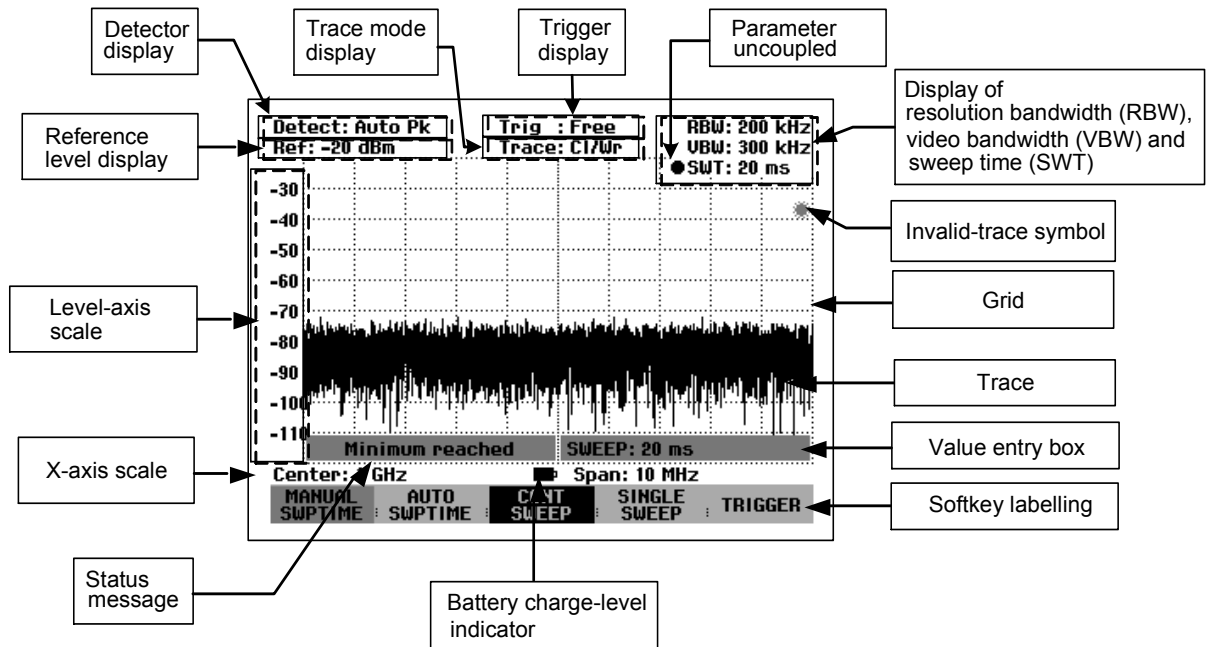

Screen layout when the marker mode is selected

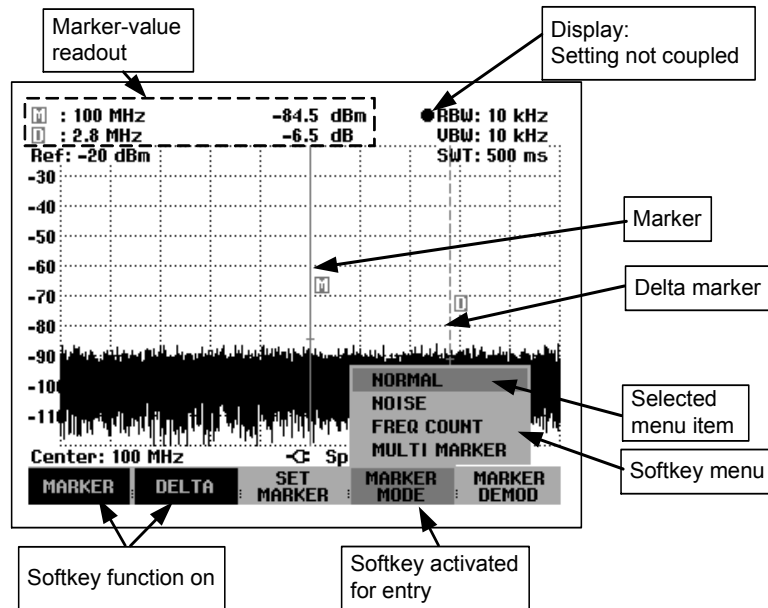

The colour of the softkey labelling and its background indicate the status of the softkey function in question:

| Softkey colour | Meaning |
|----------------------------------|--|
| Blue background, white labelling | Softkey function is turned off |
| Blue background, grey labelling | In the current setting, this softkey function is not available |
| Green background | Softkey function is turned on |
| Red background | Softkey function has been activated for value entry or selecting a menu function |

Entering Measurement Parameters

Settings and texts are entered either by directly calling the functions or by entering values, units or texts separately. The R&S FSH has a variety of operating modes.

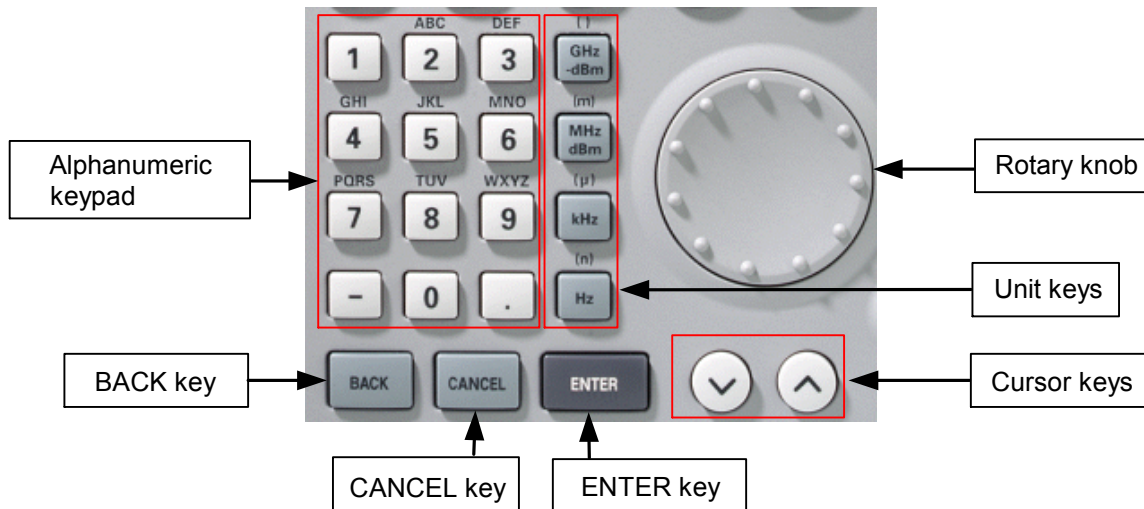

Entering values and texts

Values are entered using the number keys (0 to 9), the decimal point key (.) and the minus key (-) in the alphanumeric keypad. The alphanumeric keypad is also used to enter letters, e.g. file names for data sets. If the R&S FSH is expecting a letter entry, it automatically assigns the letters above the keys to the keys in the alphanumeric keypad. The keys have multiple assignments. The letter you want is obtained by pressing the key the appropriate number of times. The key assignments are listed below:

| Key | x1 | x2 | x3 | x4 | x5 | x6 | x7 | x8 | x9 |
|-----|----|-----|----|----|----|----|----|----|----|
| 1 | 1 | | | | | | | | |
| 2 | a | b | c | 2 | A | B | C | | |
| 3 | d | e | f | 3 | D | E | F | | |
| 4 | g | h | i | 4 | G | H | I | | |
| 5 | j | k | l | 5 | J | K | L | | |
| 6 | m | n | o | 6 | M | N | O | | |
| 7 | p | q | r | s | 7 | P | Q | R | S |
| 8 | t | u | v | 8 | T | U | V | | |
| 9 | w | x | y | z | 9 | W | X | Y | Z |
| - | - | | | | | | | | |
| 0 | 0 | SPC | _ | | | | | | |
| . | . | | | | | | | | |

You can delete any letter or digit you have entered with the BACK key. Pressing the BACK key deletes the last keystroke that has been entered. Complete entries can be cancelled with the CANCEL key.

Values can also be entered with the rotary knob or the cursor keys. The entry is changed in steps and the R&S FSH immediately sets the appropriate entry parameter.

Entering units

To enter a unit for a value entry, terminate the entry with a unit key. Use the unit keys down the right-hand side of the alphanumeric keypad. These keys have multiple assignments which depend on the unit entry expected by the R&S FSH.



GHz, -dBm, V, s



MHz, dBm, dBmV, mV, ms



kHz, dBμV, μV, μs



kHz, nV, ns

The relative unit dB can be entered with any of the unit keys.

Sweep

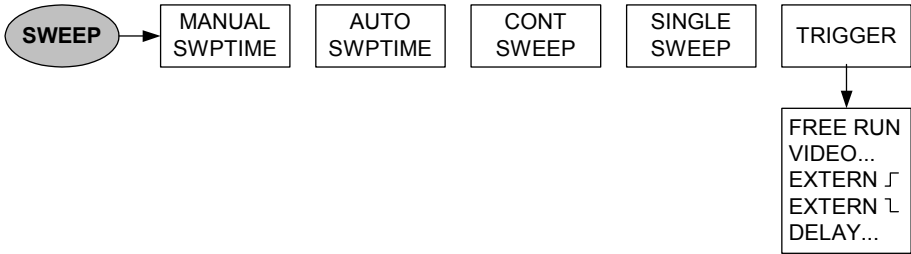

Trace setting

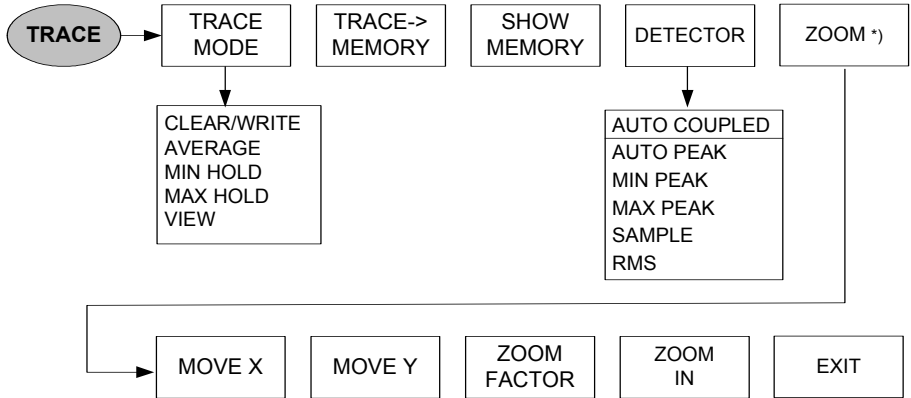

*) only with R&S FSH-K2 and selected Smith- Chart

Measurement functions

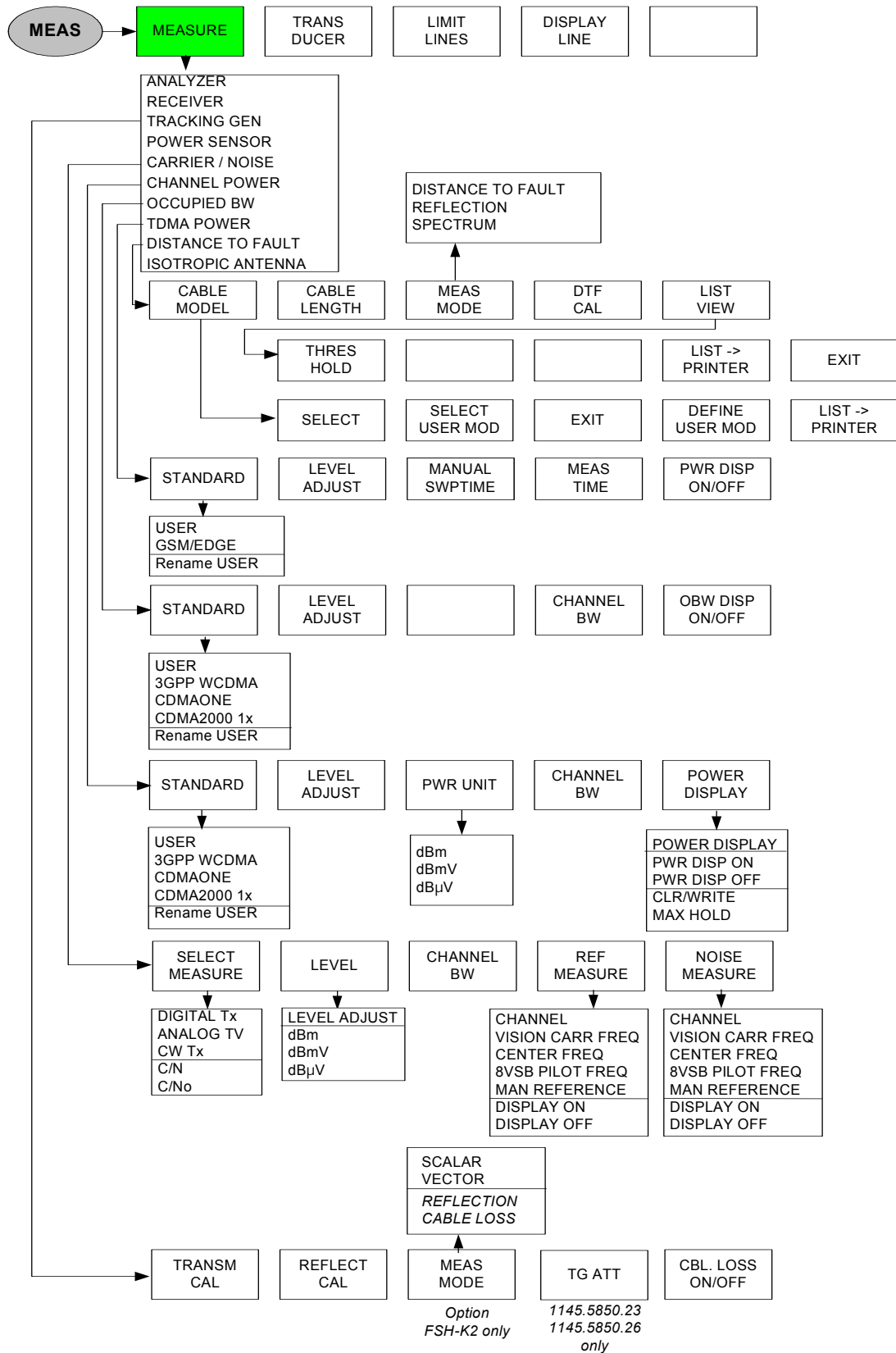

Power meter menus

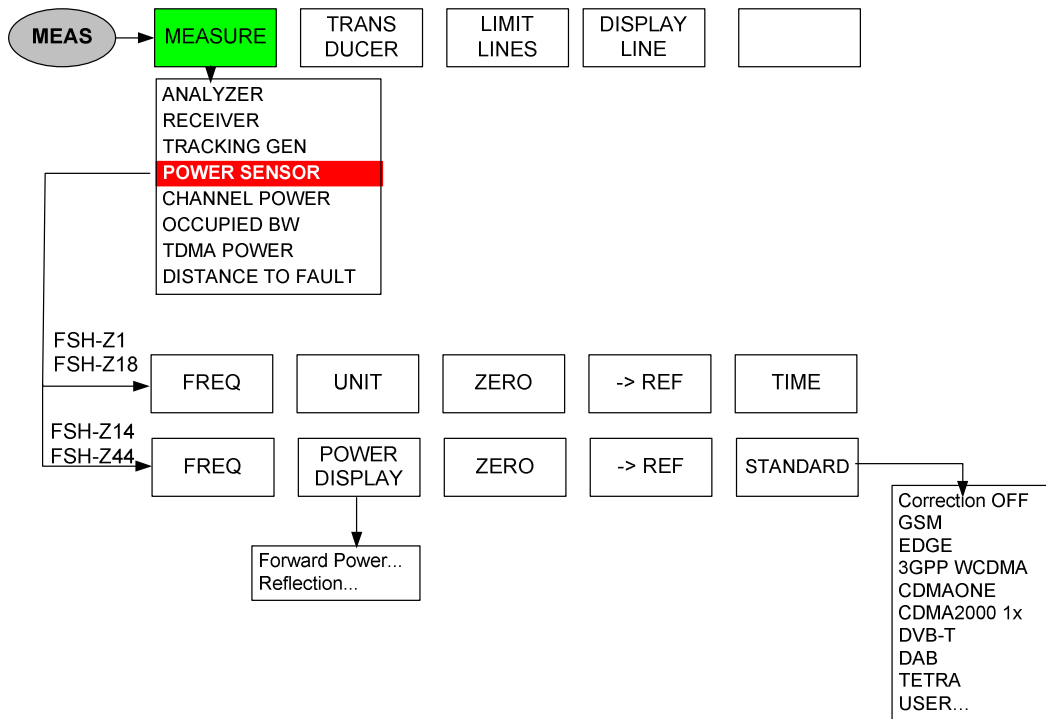

Transducer menus

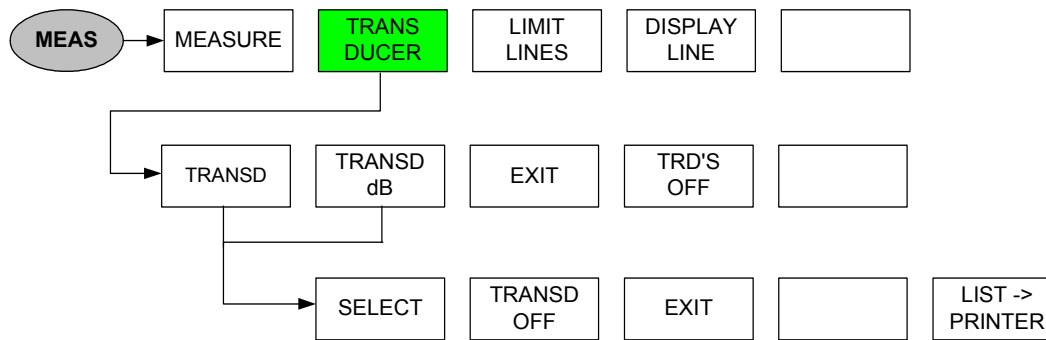

Limit line menus

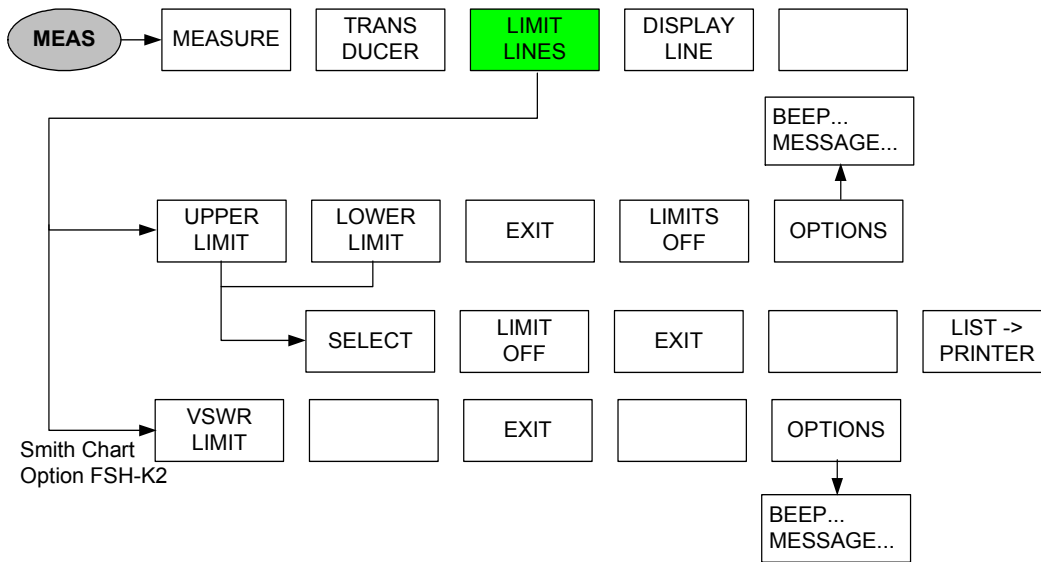

Menus for measurements with isotropic sensor

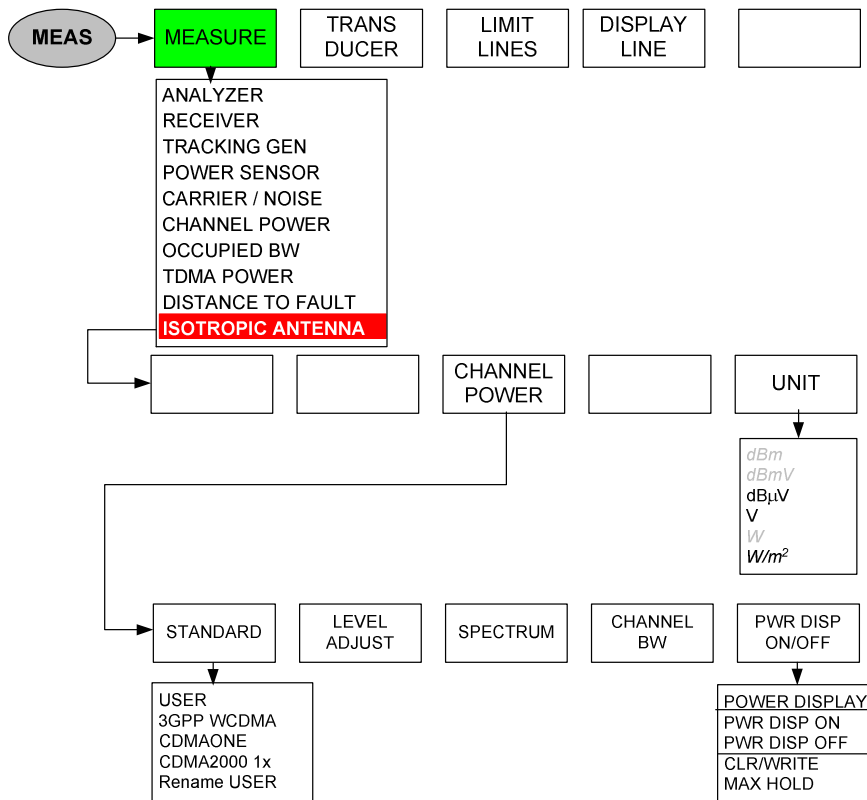

Markers

Analyzer mode:

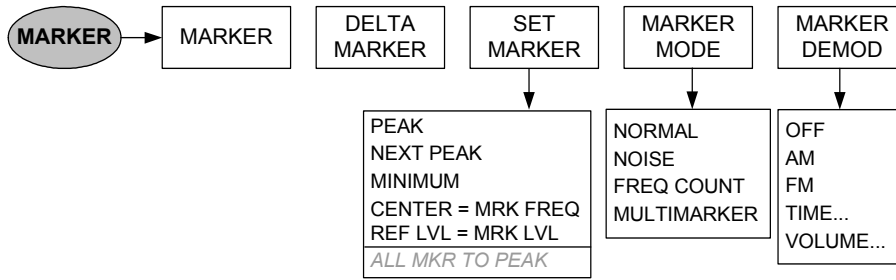

Analyzer mode, multimarker switched on:

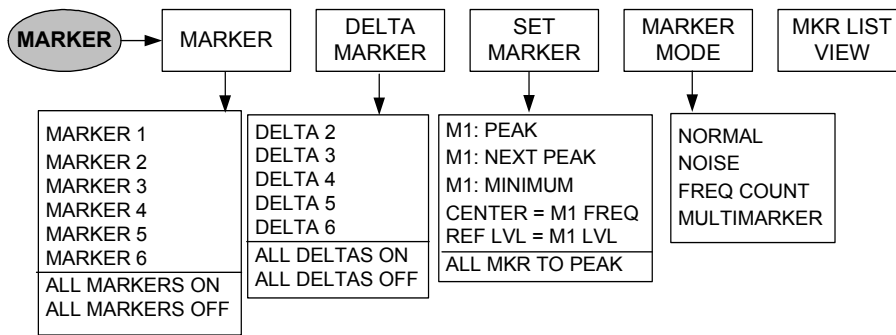

Distance-to-fault mode (option R&S FSH-B1):

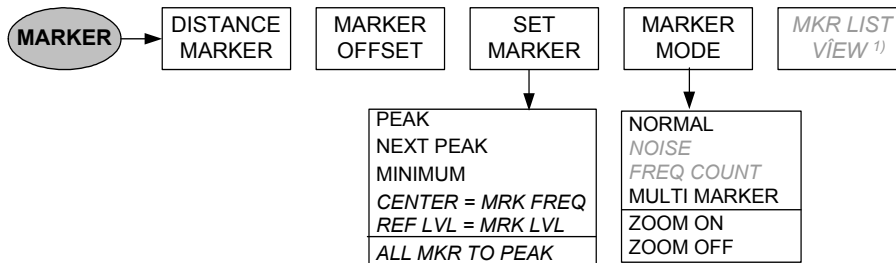

¹⁾ Only with multimarker switched on.

Distance-to-fault mode (option R&S FSH-B1), multimarker switched on:

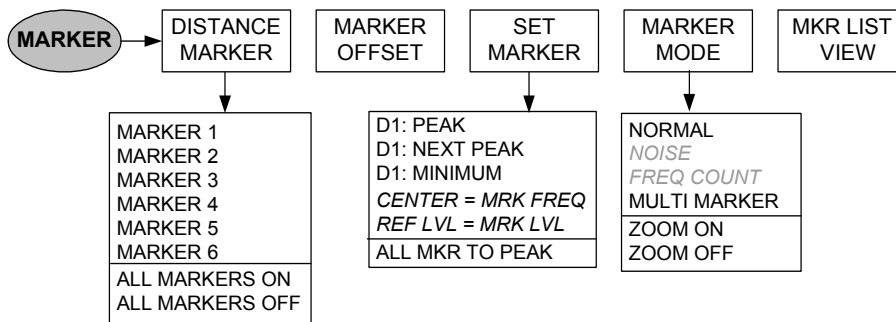

Save and print menu

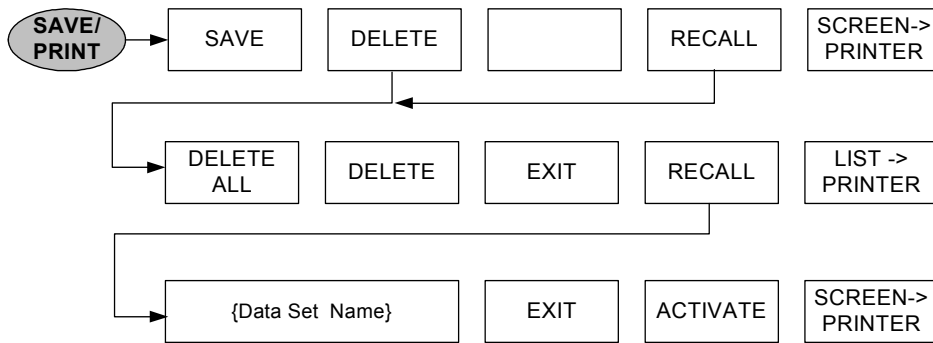

Instrument setup

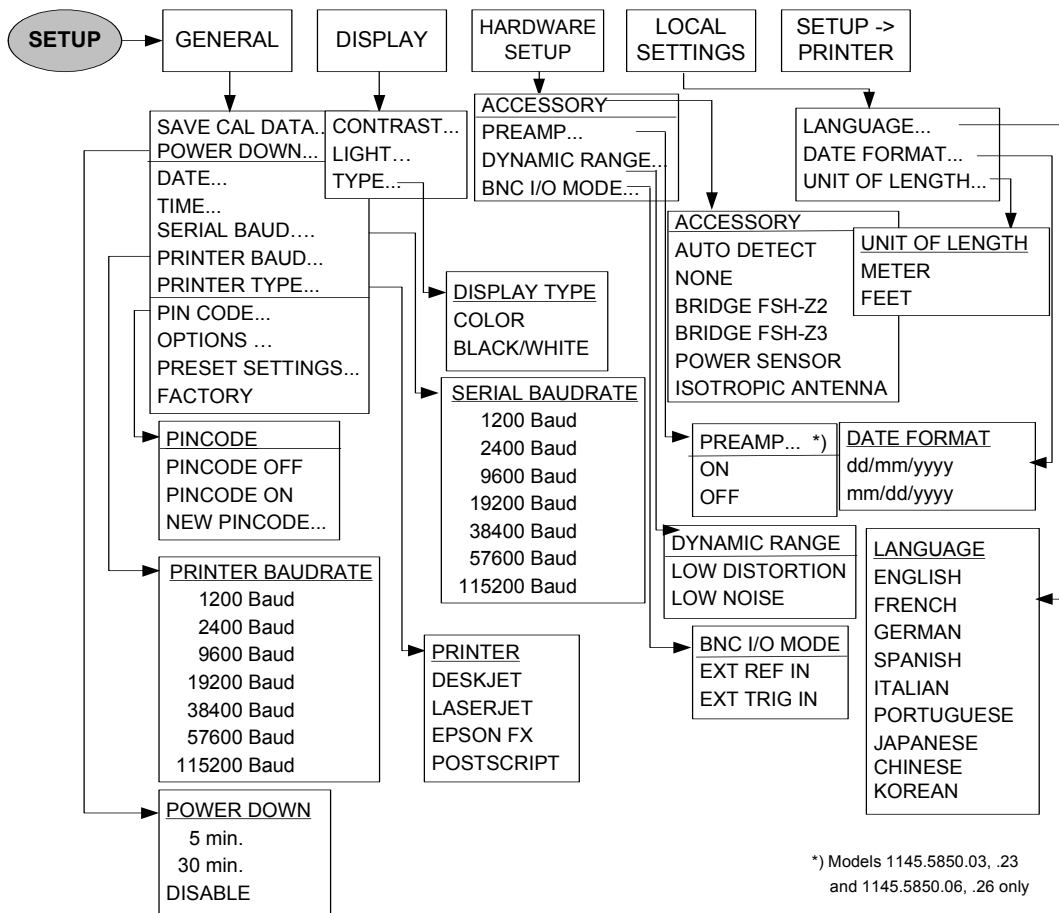

*) Models 1145.5850.03, .23 and 1145.5850.06, .26 only

Status display



Menus in the Receiver Mode (Option R&S FSH-K3)

Main menu:

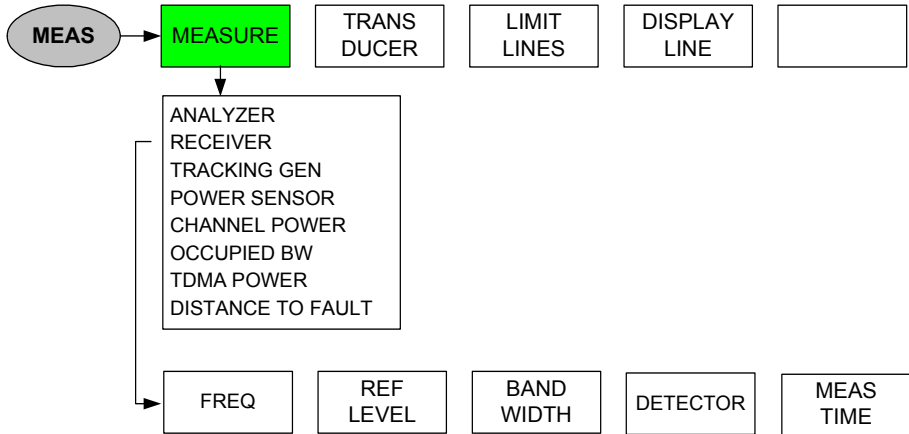

FREQ key

Frequency entry:

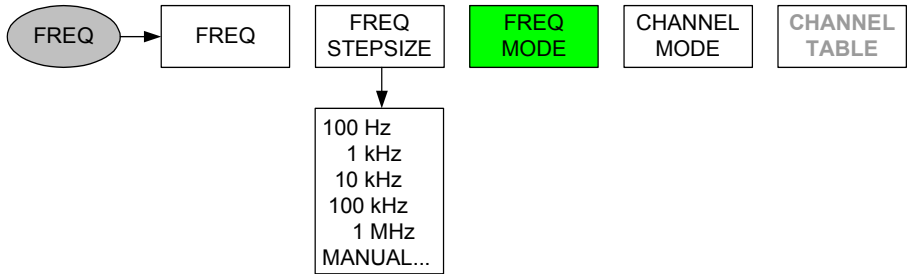

Channel entry:



SPAN key

Frequency entry:

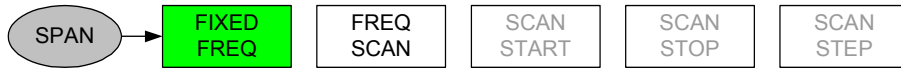

Frequency scan:

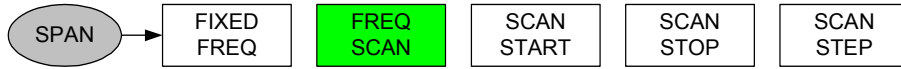

Channel entry:

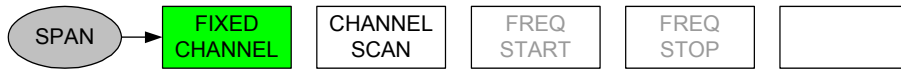

Channel scan:



AMPT key

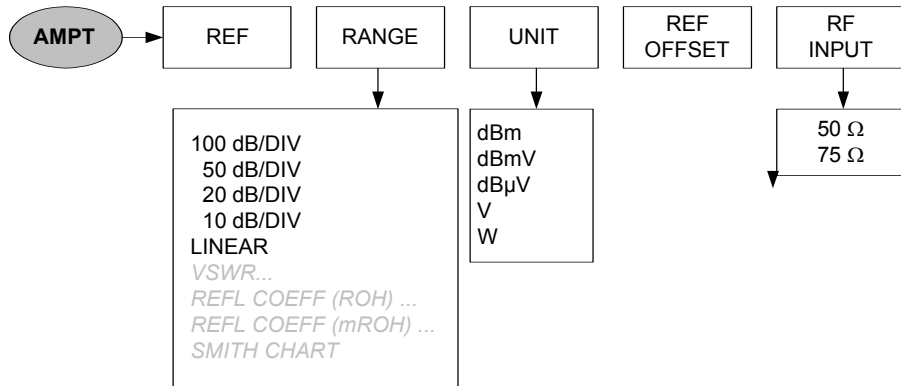

Bandwidth entry:



Sweep key

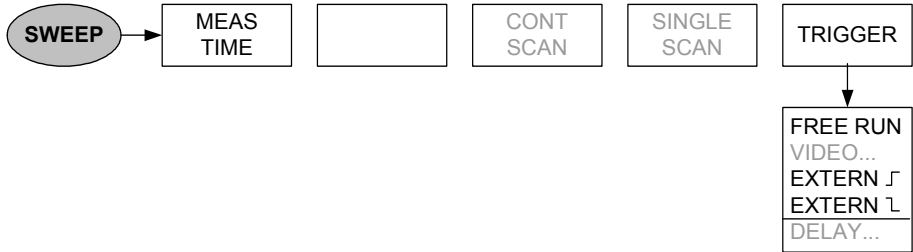

Trace key

Measurement at a fixed frequency:

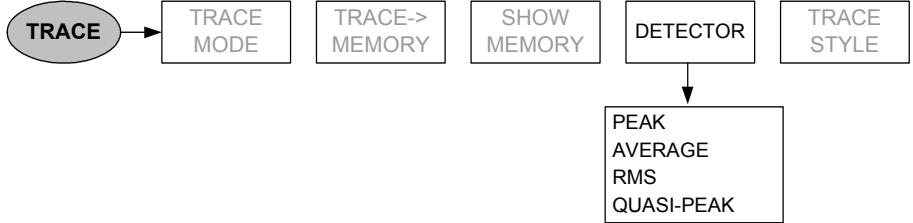

Scan mode:

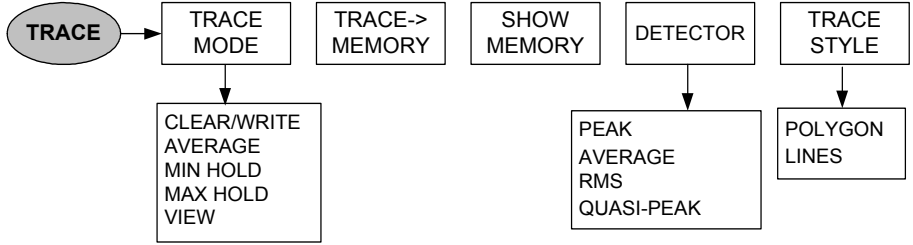

Menu for 3GPP BTS Code Domain Power Measurement (Option R&S FSH-K4)

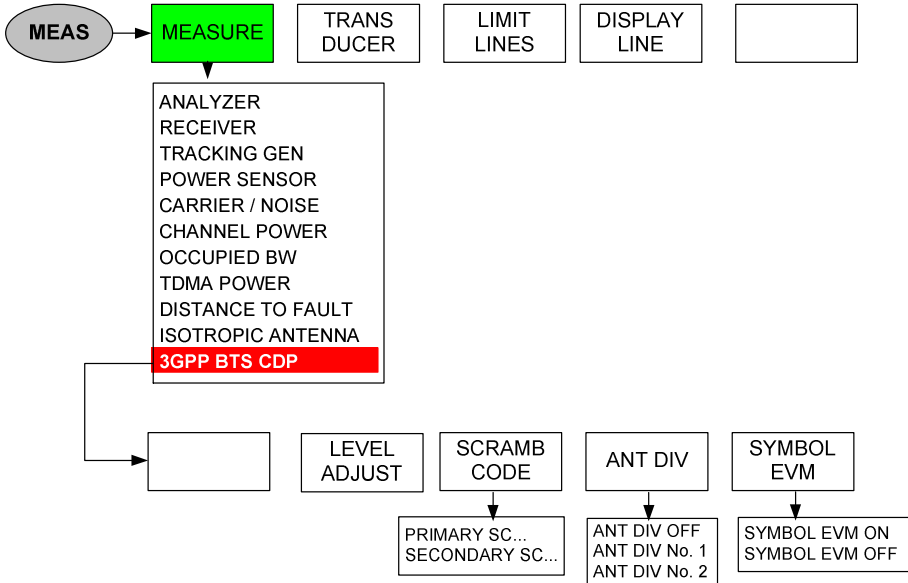

4 Instrument Functions

Instrument Default Setup

When you press the PRESET key, the R&S FSH is set to its default setup or presets. It is best to select the PRESET when you are going to perform a new measurement task. The new settings can then be made on the basis of the more familiar default setup without the old settings affecting the measurement.

Operating sequence:

- Press the PRESET key (green key below and to the right of the rotary knob).

The R&S FSH is immediately set to the default setup.

Status Display

The R&S FSH has a status display. On the screen, the status display provides an overview of all the measurement parameters that have just been set. This means that all the measurement settings can be checked easily at a glance. The status display can be output directly to a printer as measurement documentation. At a later date, every detail of a measurement can, therefore, be accurately reproduced.

Operating sequence:

- Press the STATUS key (above and to the right of the rotary knob).

The R&S FSH displays the current measurement parameter settings on the screen. To view all settings, the screen content can be scrolled through with the aid of the cursor keys or the rotary knob. An up or down arrow at the right screen edge indicates that additional information is available before or after the displayed window. The display can be used as a way of checking the settings. Settings can be changed by using the appropriate key and menu.

Printing out the status display:

- Press the STATUS -> PRINTER softkey.

The R&S FSH immediately prints out a screenshot to the connected printer. The softkey remains active for about 1/2 second (red highlighting).

Exiting the status display:

- Press the EXIT softkey or the STATUS key.

The R&S FSH returns to the original setting.

| 01/12/2002 | INSTRUMENT STATUS | 10:21:38 |
|-----------------------|-------------------|------------------|
| Measurement | : GSM / EDGE | |
| Center Frequency | : 920.2 MHz | |
| Frequency Offset | : 0 Hz | |
| Measurement Time | : 470 μs | |
| Reference Level | : 143 dBμV/m | |
| Reference Offset | : 0.0 dB | |
| RF Attenuator Setting | : 30 dB | |
| RF Input Reference | : 50 Ω | |
| Resolution Bandwidth | : 300 kHz | |
| Video Bandwidth | : 1 MHz | |
| SweepTime | : 1 ms | |
| Trace Mode | : Clear / Write | ▼ |
| : | EXIT | STATUS-> PRINTER |

| 01/12/2002 | INSTRUMENT STATUS | 10:22:26 |
|----------------------|-------------------|------------------|
| RF Input Reference | : 50 Ω | ▲ |
| Resolution Bandwidth | : 300 kHz | |
| Video Bandwidth | : 1 MHz | |
| SweepTime | : 1 ms | |
| Trace Mode | : Clear / Write | |
| Detector | : Sample | |
| Trigger Mode | : Video Trigger | |
| Trigger Level | : 50 % | |
| Trigger Delay | : 0 s | |
| Transducer | : HL223 | |
| Transducer (dB) | : - - - | |
| : | EXIT | STATUS-> PRINTER |

Setting the Frequency

The R&S FSH's frequency is set with the **FREQ** key. The frequency can be specified in terms of the center frequency (center freq. = frequency at the center of the frequency axis in the measurement diagram) or the start and stop frequency for a particular span.

It is best to enter the center frequency when a signal is to be measured at a known frequency. When you are investigating signals, e.g. harmonics, that are within a particular frequency range, the best option is entering a start and stop frequency to define the span.

Entering the center frequency

- Press the **FREQ** key.

The R&S FSH opens the frequency menu. Center frequency entry is always activated, so that the frequency settings can be made with the minimum number of keystrokes. The current center frequency is displayed in the value entry box. A new center frequency can be entered directly from the numeric keypad. You can also use the rotary knob or the cursor keys.

- Enter the frequency you want from the numeric keypad and terminate the frequency entry with the appropriate unit (GHz, MHz, kHz or Hz).

The frequency you have entered now becomes the new center frequency. The value entry box remains open for any further entries.

- As an alternative, you can change the center frequency with the rotary knob or the cursor keys and terminate the entry with the **ENTER** key.
- You can clear the value entry box from the screen by pressing the **CANCEL** key.

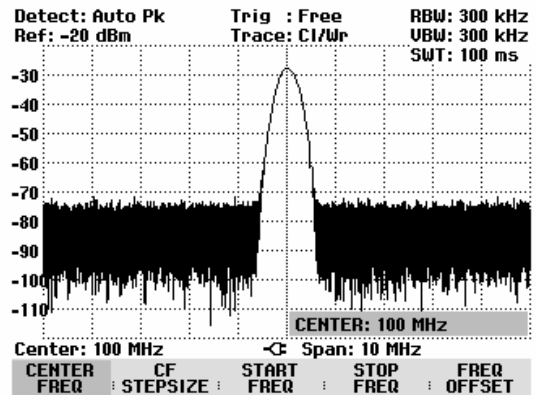

The smallest step for adjusting the center frequency with the rotary knob is a pixel, in other words, as the trace comprises about 300 pixels, each step is equal to about 1/300 of the span. When you use the cursor keys, a frequency step is equal to 10 % of the span (= 1 grid division). If you want to use a different step size, you can define it with the **CF STEPSIZE** function (CF = center frequency).

When you are adjusting the center frequency, you may obtain a value that is outside the R&S FSH's maximum span. If this happens, the R&S FSH automatically reduces the span. It also outputs the message "Span changed" to inform the user what has happened.

Setting a frequency offset

For measurements on frequency converters such as satellite downconverters, it is often convenient to reference the results to the frequency prior to conversion. For this purpose, the R&S FSH offers a frequency offset, which arithmetically shifts the center frequency to higher or lower frequencies; thus, the R&S FSH displays the input frequency of the DUT.

Positive frequency offset is possible in the 10 Hz to 100 GHz range, in 10 Hz steps. The size of the negative frequency offset permitted depends on the start frequency setting; the start frequency, taking into account the frequency offset, is always ≥ 0 Hz.

- Press the FREQ key.
- Press the FREQ OFFSET softkey.

The R&S FSH opens the frequency offset entry field.

- Enter the required frequency offset and terminate with the corresponding unit.

The R&S FSH adds the frequency offset to the set center frequency. The center frequency display is marked by a red dot to indicate that a frequency offset has been set.

The frequency offset can be reversed if an offset of 0 Hz is entered.

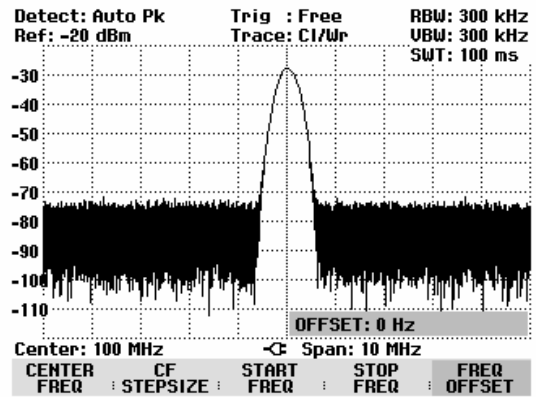

Entering the center-frequency step size

- Press the CF STEPSIZE key.

A submenu above the softkey label opens. The box contains various step size setting options.

With 0.1 x SPAN (default setting), the step size is equal to 10 % of the span (= 1 division on the vertical scale).

With = CENTER, the step size is equal to center frequency. This setting is ideal for measurements on harmonics. On each frequency increment, the center frequency moves to the next harmonic.

With MANUAL... you can select any step size. This makes it easy to investigate spectra with frequencies at constant intervals.

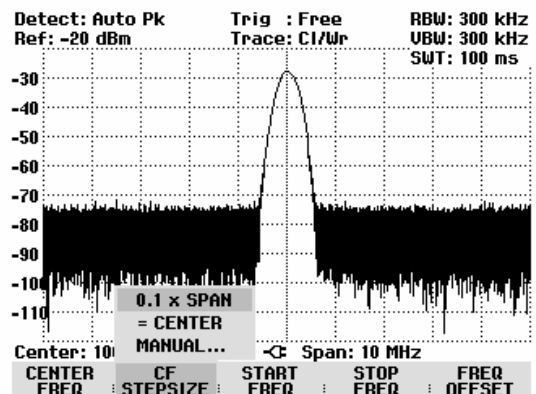

- Make the selection you want with the rotary knob or the cursor keys and terminate with the ENTER key.

If you select "0.1 x SPAN" or "= CENTER", the R&S FSH makes the setting directly itself. If you select "MANUAL...", the value entry box opens and indicates the current step size.

- Using the rotary knob, the cursor keys or numeric entry, change the step size.
- When you have entered the step size you want, confirm by pressing the ENTER key or by pressing the CF STEPSIZE softkey.

Entering the start and stop frequency

- Press the START FREQ softkey.

The value entry box for the start frequency opens. The box displays the current frequency.

- Enter a new start frequency with the number keys and terminate the entry with one of the unit keys or
- Adjust the start frequency with the rotary knob or the cursor keys and terminate the entry with the ENTER key.

The R&S FSH sets the new start frequency. The x axis labelling changes from CENTER and SPAN to START and STOP.

- Press the STOP FREQ softkey.

The R&S FSH opens the value entry box for the stop frequency. The box indicates the current frequency.

- Enter a new stop frequency using the number keys and terminate the entry with one of the unit keys, or
- Adjust the stop frequency with the rotary knob or the cursor keys and terminate the entry with the ENTER key.

The new stop frequency is now set on the R&S FSH.

If you enter a stop frequency on the R&S FSH3 which is greater than 3 GHz, or you reach the 3 GHz limit with the rotary knob or the cursor keys, the R&S FSH3 outputs the message "Maximum reached". The limit on the R&S FSH6 is 6 GHz.

Working with channel tables

Almost all transmission systems divide their assigned frequency ranges into channels, with a specific frequency assigned to each channel. The R&S FSH therefore allows users to define channel assignments using familiar terms to keep operation simple.

Channel tables are defined with the R&S FSH View software and loaded into the spectrum analyzer. The R&S FSH can store up to 100 different channel tables which can be activated from the front panel as required. The maximum number of channel tables may be reduced if transducer factors, cable models, limit values or data sets are stored simultaneously (see "Saving and Loading Instrument Settings and Measurement Results" in this chapter)

The R&S FSH View software operating manual describes how to generate channel tables.

Switching to channel entry:

- Press the FREQ key.
- Press the CF STEPSIZE softkey.
- Select CHANNEL... from the menu with the rotary knob or the cursor keys and confirm with the ENTER key.

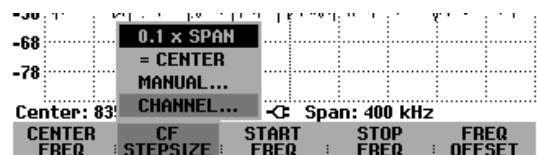

The R&S FSH opens the list of channel tables loaded via R&S FSH View.

- Select the desired channel table with the rotary knob or the cursor keys and switch it on with the SELECT softkey.

| 18/02/2004 | BAND TABLE LIST | 21:19:17 |
|---------------|----------------------------|----------|
| CATV | 18/02/2004 21:19:08 | |
| PCS UL | 01/01/1995 01:00:00 | |
| PCS DL | 01/01/1995 01:00:00 | |
| GSM DL | 01/01/1995 01:00:00 | |
| GSM UL | 01/01/1995 01:00:00 | |

| | | |
|--------|------|-------------------|
| SELECT | EXIT | LIST-> PRINTER |
|--------|------|-------------------|

The channel number together with the name of the selected channel table (e.g. GSM UL Ch: 1) is now displayed instead of the center frequency. The FREQUENCY softkey is now called CHANNEL.

| | | | | |
|--------------|---------------|-------|------|--------|
| -100 | CHANNEL: 1 | | | |
| GSM UL Ch: 1 | Span: 400 kHz | | | |
| CHANNEL | CF | START | STOP | FREQ |
| | STEP | FREQ | FREQ | OFFSET |

The R&S FSH center frequency is the frequency corresponding to the displayed channel number from the channel table. The R&S FSH accepts only channel numbers when entering the center frequency. Tuning the frequency with the rotary knob or the cursor keys is also done using channel numbers. If you exceed the definition of the channel table used, either "Minimum reached" is displayed on the screen when the lowest channel number is reached or "Maximum reached" is displayed when the highest channel number is reached. All other measurement parameters such as SPAN or RBW (resolution bandwidth) are user-selectable as with the entry of frequencies. The entries for the start frequency (START FREQ) and the stop frequency (STOP FREQ) are inactive when defining channels.

Channel numbers are assigned to frequencies as follows:

- The first channel is assigned a channel number and a frequency.
- All subsequent channels have ascending numbers.
- The frequency spacing between channels is fixed. It can also be negative, i.e. the center frequency of the R&S FSH decreases with ascending channel number.
- In transmission systems containing gaps in the frequency range (as in the case of television, for example), a channel table can comprise multiple ranges.

Setting the Span

The span is the frequency range centered on the center frequency which a spectrum analyzer displays on the screen. What span should be selected for a particular measurement depends on the signal to be investigated. A rule of thumb is that it should be at least twice the bandwidth occupied by the signal.

For frequency domain measurement the R&S FSH3 has a minimum span of 10 kHz and a maximum span of 3 GHz. Using the span 0 Hz measurement is performed in time domain. The maximum span on the R&S FSH6 is 6 GHz.

Operating sequence:

- Press the SPAN key.

When the SPAN key is pressed, the R&S FSH automatically activates the MANUAL SPAN softkey and indicates the current value so that a new span can be entered immediately. If another function in the SPAN menu has been used beforehand, press the MANUAL SPAN softkey to enter the span.

- Enter a new span with the number keys and terminate the entry with the appropriate unit (GHz, MHz, kHz or Hz), or
- Change the span with the rotary knob or the cursor keys. The span is set immediately after the change is made.
- The value entry box can be cleared from the screen with the CANCEL key.

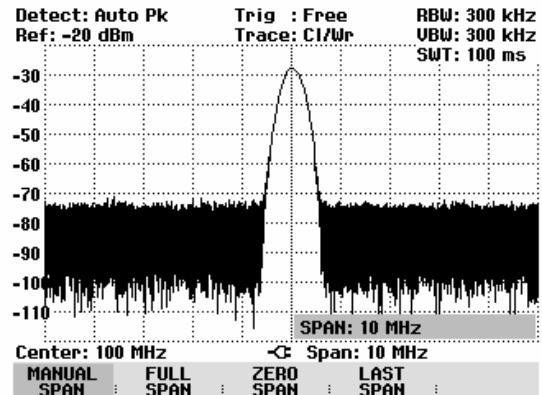

Use the FULL SPAN softkey to select the full span from 0 Hz to 3 GHz (R&S FSH3) or from 0 Hz to 6 GHz (R&S FSH6) with a single keystroke.

- Press the FULL SPAN key.

The R&S FSH displays the spectrum over the full span which extends to 3 GHz or to 6 GHz (CENTER = 1.5 GHz, SPAN = 3 GHz or CENTER = 3 GHz, SPAN = 6 GHz).

The R&S FSH has a LAST SPAN softkey so that you can toggle between span settings with just one keystroke.

- Press the LAST SPAN key.

The span that was set immediately before the current span is restored.

The ZERO SPAN softkey sets the span to 0 Hz. The R&S FSH measures the signal level only at the center frequency that has been set. As a spectrum cannot be displayed when measurements are made at a single frequency, the display mode switches to the time domain. The x axis of the measurement diagram becomes the time axis and level is plotted against time. The display always starts at 0 s and stops after the sweep time that has been set (set with the SWEEP key, see also "Setting the Sweep").

Setting the Amplitude Parameters

All R&S FSH settings referred to the level display are made with the AMPT key.

The reference level (REF) is the level represented by the uppermost grid line in the measurement diagram. The input signal gain up to the display stage is set with the reference level. If the reference level is low, the gain is high, which means that even weak signals are clearly displayed. If the input signals are strong, a high reference level must be set to prevent the analyzer signal path from being overdriven and to keep the signal display within the display range. When displaying the spectrum of a composite signal, the reference level should be at least high enough to ensure that all the signals are within the measurement diagram.

The RF attenuation setting at the input of the R&S FSH is directly coupled to the reference level. If the reference level is high, RF attenuation is switched on in steps of 10 dB according to the following table so that the input mixer always remains in the linear range.

The R&S FSH has two different modes for the attenuation setting. The modes are selected using the SETUP key and the GENERAL softkey (see chapter 1). In Low Distortion mode, the R&S FSH sets the RF attenuation 10 dB higher in line with the table, making the stress of the input mixer 10 dB less at the specified reference level. If the spectrum is densely occupied with signals, as occurs in a television cable network, the input mixer reduces the R&S FSH's inherent spurious products. However, the inherent noise display of the R&S FSH increases due to the increased attenuation before the input mixer.

In the R&S FSH3 models 1145.5850.03 and 1145.5850.23 and in the R&S FSH6, not only the RF attenuation, but also the preamplifier, if switched on, is coupled to the reference level setting.

| Reference level | Preamplifier OFF | | Preamplifier ON | | |
|--------------------|------------------|----------------|-----------------|----------------|--------------|
| | RF attenuation | | RF attenuation | | Preamplifier |
| | Low Noise | Low Distortion | Low Noise | Low Distortion | |
| ≤-25 dBm | 0 dB | 0 dB | 0 dB | 0 dB | On |
| -24 dBm to -20 dBm | 0 dB | 0 dB | 10 dB | 10 dB | On |
| -19 dBm to -15 dBm | 0 dB | 10 dB | 10 dB | 10 dB | On |
| -14 dBm to -10 dBm | 0 dB | 10 dB | 0 dB | 10 dB | Off |
| -9 dBm to 0 dBm | 10 dB | 20 dB | 10 dB | 20 dB | Off |
| 1 dBm to 10 dBm | 20 dB | 30 dB | 20 dB | 30 dB | Off |
| 11 dBm to 20 dBm | 30 dB | 30 dB | 30 dB | 30 dB | Off |

The status of the RF attenuation and the preamplifier can be queried in the Status menu (press the STATUS key).

The reference level is in dBm for the default setting. However, the units dBmV, dBμV, Watt and Volt can also be selected. Unit selection is of most relevance to the marker level display as the marker level is displayed in the unit of the reference level.

A reference offset (REF OFFSET) can be defined for the reference level. The reference offset is a way of increasing the reference level by a certain amount. This is useful if, for example, an attenuator or amplifier has been inserted before the RF input. The R&S FSH automatically takes the loss or gain into account when the level is displayed and no manual calculations are necessary. A loss introduced at the RF input must be entered as a positive number and a gain as a negative number.

The measurement range (RANGE) determines the resolution along the level axis in the measurement diagram. When the PRESET or default setting has been selected, the level axis is scaled in dB. The measurement range is 100 dB or 10 dB per division (10 dB/DIV). The R&S FSH also provides the level ranges 50 dB (5 dB/DIV), 20 dB (2 dB/DIV) and 10 dB (1 dB/DIV) which enhance resolution along the level axis. However, increasing resolution does not increase the accuracy of, for example, the marker level readout, but only makes it easier to read values off the trace. You can also select a linear level

scale with LIN 0-100 %. The level is expressed as a percentage (0 % to 100 %) of the reference level. This mode is useful if you want to display, for example, a carrier being amplitude modulated in the time domain (SPAN = 0 Hz).

The R&S FSH can also handle measurements on 75 Ω systems. The R&S FSH does not select a 75 Ω RF input per se, but instead only a 75 Ω matching pad connected at the RF input. The 50/75 Ω Matching Pad R&S RAZ is recommended for 75 Ω matching (see recommended accessories). The R&S FSH automatically considers the conversion factor when a value of 75 Ω is set. Other matching pads such as the R&S RAM or R&S FSH-Z38 can be taken into account by using a transducer factor (included with the R&S FSH View control software).

Setting the reference level

- Press the AMPT key.

The reference level entry is activated immediately. The REF LEVEL softkey label is highlighted in red.

- Enter a reference level with the number keys and either terminate the entry with one of the unit keys (-dBm or dBm for relative measurements or (), m, μ, n for absolute measurements) or press the ENTER key, or
- Adjust the reference level with the rotary knob or the cursor keys.

Any changes you make to the reference level with the rotary knob or the cursor keys are immediate. The trace moves as changes to the reference level are made.

- When the reference level you want has been set, you can remove the value entry box from the screen by pressing the CANCEL key.

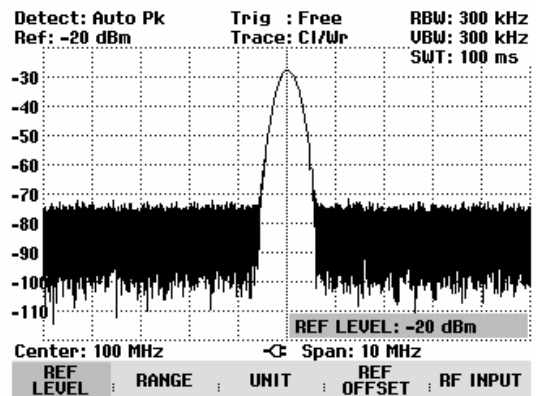

Entering the display range

- Press the AMPT key.
- Press the RANGE softkey.

A submenu opens. The various options for scaling the level axis are displayed.

- Using the rotary knob or the cursor keys, select the scaling option you want and confirm your selection by pressing the ENTER key.

The scaling option you have chosen is immediately set on the R&S FSH.

The menu items VSWR REFL COEFF (ROH) and REFL COEFF (mROH) are valid scaling options only if the R&S FSH is fitted with a tracking generator which is configured for reflection measurements. The SMITH CHART menu option is available only if option

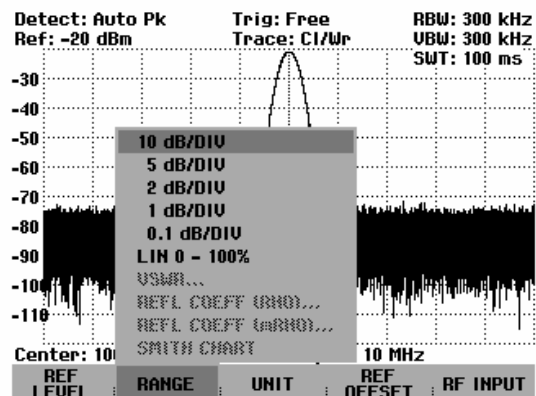

Setting the Bandwidths

A key feature of a spectrum analyzer is that it can display the frequency spectrum of a signal. The resolution bandwidth determines how well a spectrum analyzer can separate adjacent frequencies. Spectrum analyzers usually also have switchable video bandwidths. The video bandwidth is determined by the cutoff frequency of the lowpass used to filter the video voltage before it is displayed. The video voltage is the spectrum analyzer term for the voltage produced when the IF signal which has been band-limited by the resolution filter is envelope detected. The video voltage is smoothed by video filtering to, say, reduce noise on the trace. Unlike the resolution bandwidth, the video bandwidth has no effect on the resolving power of the spectrum analyzer.

Resolution bandwidth

The resolution bandwidth (RES BW) of a spectrum analyzer determines the frequency resolution of spectrum measurements. A sine signal is displayed on the screen "through" the passband of the selected resolution filter. Therefore, a suitably small resolution bandwidth is required if two or more signals whose frequencies are close together are to be displayed separately. The frequency difference between two sinusoidal carriers, for example, cannot be less than the selected resolution bandwidth if the carriers are to be resolved. Which resolution bandwidth is selected also has an effect on the noise displayed by the spectrum analyzer. If the bandwidth is small, the noise displayed drops. If the bandwidth is reduced or increased by a factor of 3, the noise displayed drops or goes up by 5 dB. If the bandwidth is changed by a factor of 10, the displayed noise changes by 10 dB. Which resolution bandwidth is selected also has an effect on the sweep speed. If the true spectrum is to be displayed, the bandfilters that determine the resolution bandwidth must settle at all frequencies of interest. Narrow bandfilters take longer to settle than wide filters. This is why a longer sweep time must be selected for narrow resolution bandwidths. If the bandwidth is reduced by a factor of 3 (e.g. from 10 kHz to 3 kHz), the sweep time must be increased by a factor of 9. If the reduction factor is 10 (e.g. from 10 kHz to 1 kHz) the sweep time must be increased by a factor of 100.

The R&S FSH has resolution bandwidths from 1 kHz to 1 MHz in a 1, 3, 10 sequence. The R&S FSH3 models 1145.5850.03 and 1145.5850.23 and the R&S FSH6 provide in addition the resolution bandwidths 100 Hz and 300 Hz. When the default setting is selected, they are coupled to the span, i.e. if the span is reduced, a smaller resolution bandwidth is automatically set. This means that in many cases the resolution bandwidth does not have to be set separately – a higher frequency resolution is automatically set when the span is reduced.

All models offer a 200 kHz resolution bandwidth in addition. This bandwidth has to be selected manually, i.e. it will not be activated automatically in the AUTO RES BW mode (resolution bandwidth coupled to span).

Operating sequence:

- Press the BW key.

The menu for setting the bandwidth opens. If the default setting is activated, the softkey label for automatically setting the bandwidth is highlighted in green.

- Press the MANUAL RES BW softkey

The softkey label is highlighted in red and the value entry box for the resolution bandwidth (RBW) indicates the current bandwidth. To indicate that the resolution bandwidth is not coupled to the span, a small red circle is placed before the resolution bandwidth display in the top right-hand corner of the screen.

- Enter the resolution bandwidth you want using the number keys and terminate the entry with the appropriate unit (MHz, kHz or Hz), or
- Change the resolution bandwidth to the value you want using the rotary knob or the cursor keys.

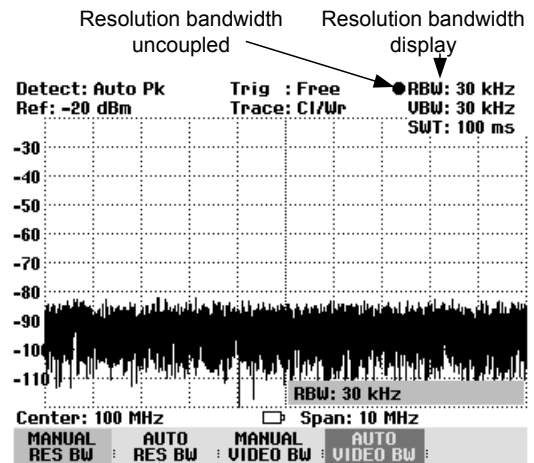

Note: The 200 kHz resolution bandwidth has to be entered by means of the number keys. When using the rotary knob or the cursor keys, the 200 kHz bandwidth will be skipped.

The box for entering the resolution bandwidth can be closed by pressing the CANCEL key.

- Press the AUTO RES BW softkey.

The resolution bandwidth is coupled to the span that has been set. The AUTO RES BW softkey label is highlighted in green to show that the coupled mode has been selected. The red circle in front of the RBW readout disappears.

Video bandwidth

The video bandwidth smoothes the trace by reducing noise. When the filtered IF signal is envelope-detected, an IF sine signal becomes a DC voltage in the video signal. If the sine signal is amplitude-modulated, a signal whose frequency is the same as the AM frequency is produced in the video signal apart from the DC voltage from the carrier. The Fig. below shows an RF signal modulated with a sine signal and the corresponding video signal in the time domain.

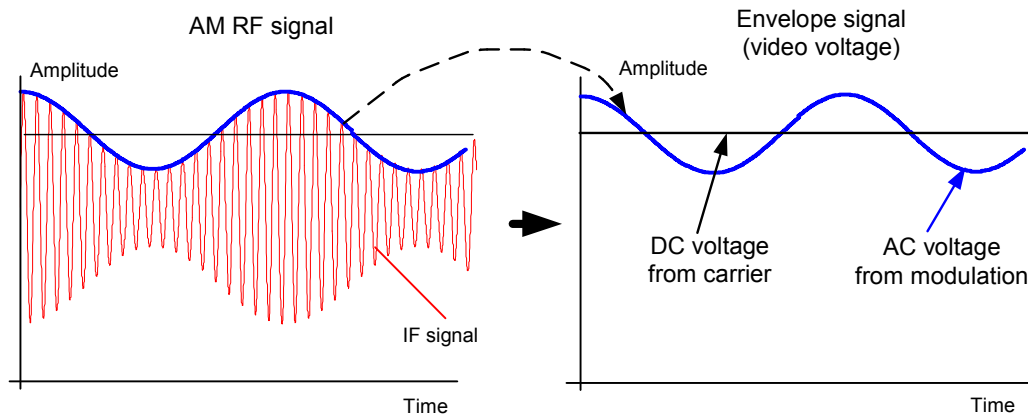

The envelope signal contains a DC component corresponding to the carrier level and an AC component whose frequency is the same as the AM frequency. If the bandwidth of the video filter is less than the frequency of the AC component, the latter will be suppressed depending on its maximum frequency. If the AM component is to be displayed faithfully, the cutoff frequency must be greater than the modulation frequency.

If there is noise on the sine signal, the modulation signal can be thought of as noise. If the video bandwidth is reduced, the high-frequency noise components above the cutoff frequency of the video filter will be rejected. The smaller the video bandwidth, the smaller the noise amplitude at the video filter output.

Therefore, the following rules of thumb can be applied to setting the video bandwidth:

- If you are performing measurements on modulated signals, the video bandwidth must be sufficiently large so that wanted modulation components are not rejected (\geq RBW).
- If signals are to be kept free of noise, the smallest video bandwidth possible should be selected ($\leq 0.1 \times$ RBW).
- If measurements are being performed on pulsed signals, the video bandwidth should be at least three times greater than the resolution bandwidth so that the pulse edges are not distorted.

Like the resolution bandwidth, the video bandwidth has an effect on sweep speed. The spectrum analyzer must pause before each measurement to allow the video filter to settle.

The R&S FSH has video bandwidths from 10 Hz to 3 MHz in a 1, 3, 10 sequence. When the default settings are selected, they are coupled to the resolution bandwidth. The video bandwidth equals the resolution bandwidth. When the resolution bandwidth is changed, the R&S FSH automatically sets the appropriate video bandwidth. This means that, in many cases, the video bandwidth does not need to be set separately. When the resolution bandwidth is changed, the video bandwidth is changed automatically.

Operating sequence:

- Press the BW key.

The menu for setting bandwidths opens. When the default setting has been selected, the softkey label for setting the bandwidth automatically is highlighted in green.

- Press the MANUAL VIDEO BW softkey.

The softkey label is highlighted in red and the video bandwidth value entry box (VBW) indicates the current bandwidth. To indicate that the video bandwidth is not coupled to the resolution bandwidth (RBW), a small, red circle is placed before the video bandwidth readout in the top right-hand corner of the screen.

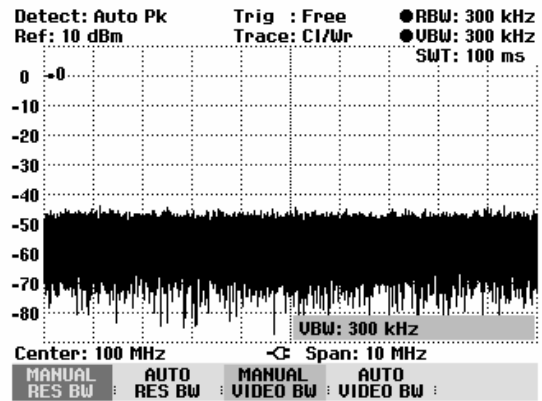

- Enter the video bandwidth you want with the number keys and terminate the entry with the appropriate unit (MHz, kHz or Hz), or
- Change the video bandwidth to the value you want using the rotary knob or the cursor keys.

The video bandwidth value entry box is closed by pressing the ENTER key.

- Press the AUTO VIDEO BW softkey.

The video bandwidth is coupled to the resolution bandwidth that has been set. The AUTO VIDEO BW softkey label is highlighted in green to indicate coupling and the red circle marking the VBW readout disappears.

Setting the Sweep

If the span is > 0 , the sweep time is the time the spectrum analyzer takes to traverse the displayed span to measure the spectrum. Certain boundary conditions must be met if a spurious spectrum is not to be displayed.

One boundary condition is the resolution bandwidth. If the resolution filter is to settle, the dwell time within the filter bandwidth must have the right value. If the sweep time is too short, the resolution filter does not settle and the displayed level is too low (see also “Setting the Bandwidth”).

The second boundary condition is the selected span. If the span is increased, the sweep time must be increased proportionally.

The R&S FSH provides automatic sweep time coupling to help users set the sweep time by coupling it to the resolution bandwidth and span that have been set. When automatic coupling (AUTO SWEEP TIME) is selected, it always sets the shortest sweep time possible to ensure that sine signals in the spectrum are displayed correctly. When you quit the auto sweep time mode (MANUAL SWPTIME is activated instead), a small, red circle is placed in front of the SWT readout to indicate that the uncoupled mode has been selected. If the sweep time is so short that level errors occur, the R&S FSH informs the user by displaying a red circle on the right-hand side of the measurement diagram.

The R&S FSH requires a minimum sweep time of 20 ms per 600 MHz of span. If a larger span is set, the R&S FSH automatically adapts the minimum sweep time in the coupled mode. For the maximum span of 3 GHz in the R&S FSH3, a minimum sweep time of 100 ms is required. Analogously, for the maximum span of 6 GHz in the R&S FSH6, a minimum sweep time of 200 ms is required.

If the span = 0 Hz, the R&S FSH displays video voltage versus time instead of a spectrum. The x axis of the measurement diagram becomes the time axis, starting at 0 s and ending at the sweep time you have selected.

The minimum sweep time when the span = 0 Hz is 1 ms, the maximum 1000 s.

Sweep time

- Press the SWEEP key.

The softkey menu for entering sweep parameters opens. If the default settings have been selected, automatic coupling (AUTO SWPTIME) is set. In this mode, the sweep time is coupled to the resolution bandwidth, the video bandwidth and the span.

- To enter the sweep time, press the MANUAL SWPTIME softkey.

The SWEEP value entry box opens and indicates the current sweep time setting.

- Enter a new sweep time with the number keys and terminate the entry with one of the unit keys, or
- Change the sweep time with the rotary knob or the cursor keys.

Whenever a change is made, the sweep time is immediately set to its new value. The value entry box is closed by pressing the ENTER key. The sweep time that has been set is displayed in the top right-hand corner of the screen in the SWT readout box.

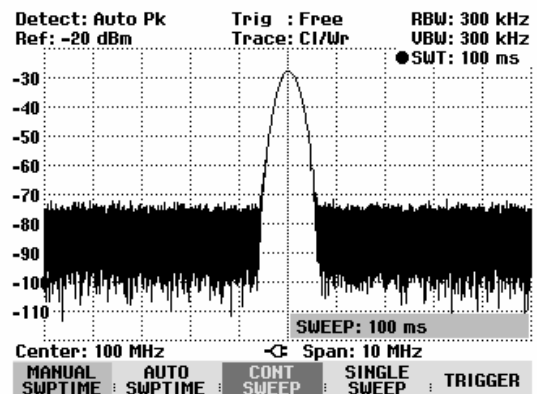

Sweep mode

When the default settings are activated, the R&S FSH is in the continuous sweep mode, i.e. when one sweep of the span has been completed, the sweep is automatically repeated from the start of the span. The trace is refreshed after each sweep.

The continuous mode may not be needed for some applications, e.g. when a single event is to be recorded on certain trigger conditions being met. The R&S FSH, therefore, has a SINGLE SWEEP mode. When the single sweep mode is selected, the R&S FSH sweeps once over the span or displays the time-domain video signal once in the zero-span mode. The measurement will only be repeated if you press the SINGLE SWEEP softkey.

- Press the SWEEP key.

If the default setting is selected, the CONT SWEEP softkey label is highlighted in green to indicate that the continuous sweep mode has been set.

- Press the SINGLE SWEEP softkey.

The SINGLE SWEEP softkey label is highlighted in green. The R&S FSH performs a single sweep and waits for further entries.

- Press the CONT SWEEP softkey.

The R&S FSH now sweeps continuously again.

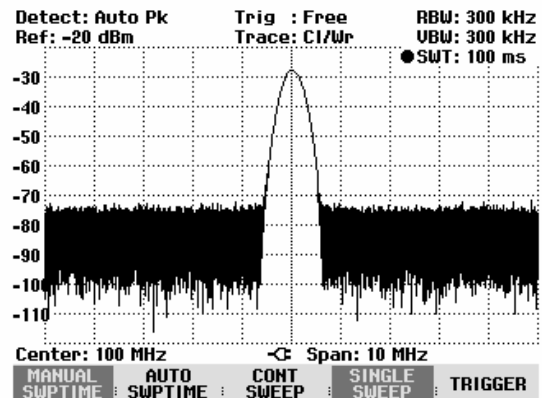

Trigger

To respond to events, the R&S FSH has a variety of trigger functions. The trigger can either be external or generated internally.

- FREE RUN A new sweep starts on completion of the previous sweep. This is the default setting for the R&S FSH.
- VIDEO A sweep starts when the video voltage exceeds a settable value. Video triggering is only available when span = 0 Hz. When a frequency spectrum is being displayed, (span ≥ 10 kHz), there is no guarantee that a signal to generate a video voltage is present at the start frequency. Under these circumstances, the R&S FSH would never perform a sweep.
- EXTERN \lceil and EXTERN \rfloor The sweep is started on the rising edge (\lceil) or on the falling edge (\rfloor) of an external trigger signal. The external trigger signal is fed in via the BNC connector EXT TRIGGER. The switching threshold is 1.4 V, i.e. a TTL signal level.

When a video trigger or an external trigger is selected, the start of measurement can be delayed with respect to the trigger event by entering a delay (DELAY). In this way, time differences between the trigger event and the measurement can be allowed for.

The current trigger setting is displayed centrally at the top of the screen (e.g. Trig: Free).

Operating sequence:

- Press the SWEEP key.
- Press the TRIGGER softkey.

The submenu for setting the trigger opens. If the default setting is selected, FREE RUN is highlighted in red. If span = 0 Hz, any setting can be selected; otherwise the settings VIDEO... and DELAY... are in darker labelling to show that they are not available.

- Select the setting you want with the cursor keys or the rotary knob and terminate the entry with the ENTER key or with the TRIGGER softkey.

The "Trig:" box at the center of the top of the screen indicates the setting that has been selected.

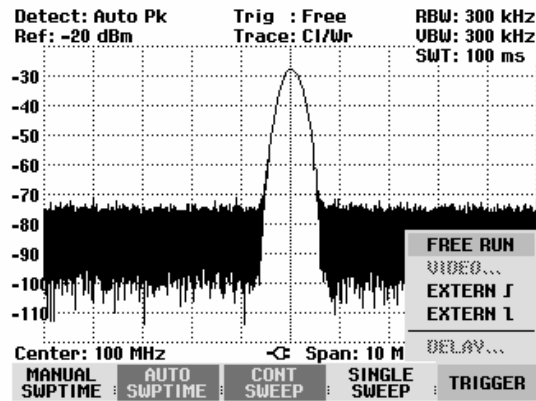

If the VIDEO... trigger setting has been selected, the trigger level and any trigger delay (DELAY...) must be entered. The trigger level is expressed as a percentage (%) of the reference level. 100 % means that the trigger level equals the reference level, 50 % that the trigger level is in the middle of the y axis on the measurement diagram (default setting). The position of the video trigger on the level axis is shown by a ">".

- Change the video-trigger threshold with the cursor keys or the rotary knob (0 to 100 %).

The trigger threshold is set immediately after entry.

- Terminate the trigger threshold entry with the ENTER key or the TRIGGER softkey.

The value entry box is then closed.

- If a trigger delay is required, press the TRIGGER softkey.
- Using the cursor keys or the rotary knob, select DELAY... and confirm with the ENTER key or the DELAY... softkey.

The delay value entry box is then opened.

- Using the number keys, the cursor keys or the rotary knob, enter the delay and terminate the entry with the ENTER key or the TRIGGER softkey.

The trigger delay range is 0 μ s to 100 s. The resolution is 10 μ s up to 1 ms and 100 μ s from 1 ms to 10 ms.

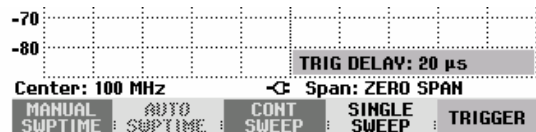
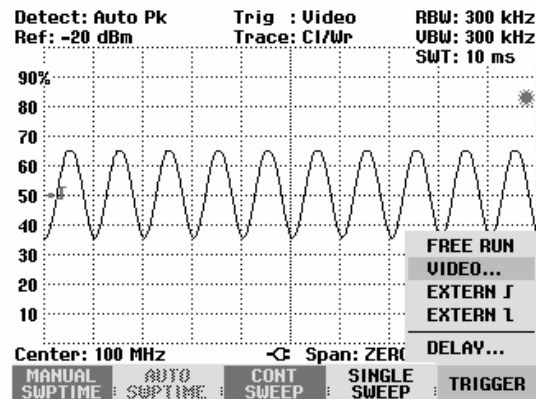

The trigger delay resolution depends on the delay selected. The table below lists the values:

| Trigger delay (DELAY) | Resolution |
|------------------------------|-------------------|
| 0 to 1 ms | 10 μ s |
| 1 ms to 10 ms | 100 μ s |
| 10 ms to 100 ms | 1 ms |
| 100 ms to 1 s | 10 ms |
| 1 s to 10 s | 100 ms |
| 10 s to 100 s | 1 s |

Trace Settings

The R&S FSH provides one measurement trace and a reference trace in memory.

Trace mode

A variety of display modes can be selected for the trace:

- CLEAR/WRITE The R&S FSH clears the old trace during a new sweep. This is the default setting.
- AVERAGE The R&S FSH takes the level average over consecutive traces. In the default setting, averaging is on a pixel-by-pixel basis, sliding over the ten previous traces. Alternatively, you can set the number of averagings between 2 and 999. This reduces the effects of noise, for example, but has no effect on sine signals. The average mode, therefore, makes it easy to display sine signals in the vicinity of noise.
- MAX HOLD The trace indicates the maximum value that has been measured up to that point in time. The Max Hold mode is only cancelled if another setting is selected and the trace pixels from the new setting cannot be compared with the trace pixels from the previous setting – for example if the span is changed. Intermittent signals in the spectrum or the maximum of fluctuating signals are easy to find with MAX HOLD.
- MIN HOLD The trace indicates the minimum value that has been measured up to that point in time. The Min Hold mode is only cancelled if another setting is selected and the trace pixels from the new setting cannot be compared with the trace pixels from the previous setting – for example if the span or the center frequency is changed. With MIN HOLD, sine signals within the noise can be highlighted or intermittent signals suppressed.
- VIEW The R&S FSH freezes the presently displayed trace. The measurement is aborted. This, for instance, allows subsequent evaluation of spectra with the aid of the marker.

Operating sequence:

- Press the TRACE key.
- Press the TRACE MODE softkey.

The submenu for setting the trace mode opens.

- Using the cursor keys or the rotary knob, select the trace mode you want and confirm with the ENTER key or the TRACE MODE softkey.

The "Trace:" display at the center of the top of the display shows the trace mode that has been selected.

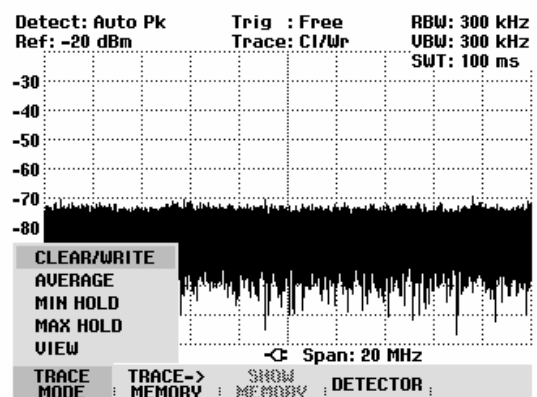

If TRACE MODE AVERAGE is selected, the AVG COUNT entry field opens, which displays the set number of averagings.

The following actions can be performed:

- Confirm the displayed number of averagings with the TRACE softkey or the ENTER key.
- Using the numeric keypad, enter a new figure between 2 and 999 for specifying the number of averagings and confirm your entry with the TRACE softkey or the ENTER key.
- Change the number of averagings by using the rotary knob and confirm your entry with the TRACE softkey or the ENTER key.

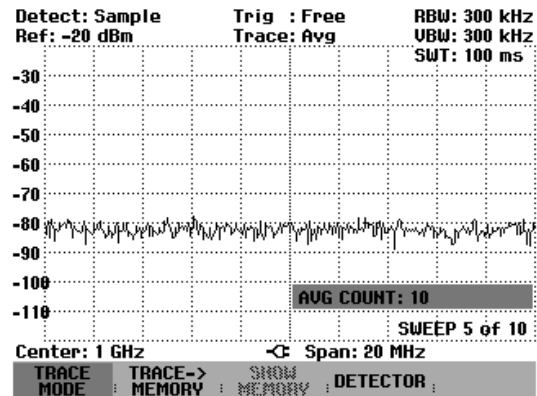

The R&S FSH averages the pixels of the trace across the set number of averagings.

If the sweep is continuous, the R&S FSH then performs a sliding averaging. In the SINGLE SWEEP mode, it performs exactly those sweeps defined with AVG COUNT and averages the traces. It then stops the sweep and displays the averaged trace.

In the trace mode VIEW, the settings used for measuring the trace are displayed. This ensures that the measurement conditions can be clearly specified in result documentation. In the status display (STATUS key) it is indicated in brackets that the view mode is currently selected, e.g. Trace Mode: Maximum Hold (View).

Detector

The detector processes a spectrum analyzer's video voltage before it is displayed. The detector is pixel-oriented, i.e. it determines how the level at each pixel will be displayed. The R&S FSH always measures the whole spectrum. However, the trace only has 301 pixels in the x direction for displaying results. If a large span is selected, all the spectrum information must somehow be represented using only 301 points. Each pixel represents a frequency range equal to $\text{span}/301$. Four different detectors are available:

- **AUTO PEAK**

When the Auto Peak detector is selected, the R&S FSH displays the maximum and minimum level at each pixel for the frequency range in question. This means that when Auto Peak detection is selected no signals are lost. If the signal level fluctuates, as is the case with noise, the width of the trace is a measure of signal fluctuation. Auto-peak detection is the default setting.
- **MAX PEAK**

Unlike the Auto Peak detector, the Max Peak detector only finds the maximum value within the frequency range associated with one trace pixel. Its use is recommended for measurements on pulse-like signals or FM signals.
- **MIN PEAK**

The Min Peak detector yields the minimum value of the spectrum within a pixel of the trace. Sine signals are displayed with correct level but noise-like signals are suppressed. The Min Peak detector can be used to highlight sine signals in the noise spectrum.
- **SAMPLE**

The Sample detector does not “summarize” any aspect of the spectrum which is available in its complete form in the R&S FSH, but instead shows only one arbitrary measurement point within a

pixel. The Sample detector should always be used for measurements with span = 0 Hz, as this is the only way of correctly representing the timing of the video signal. The Sample detector can also be used to measure noise power as noise usually has a uniform spectrum with a normal amplitude distribution. If the Sample detector is used for signal spectrum measurements with a span that is greater than (resolution bandwidth x 301), signals may be lost.

- RMS

The RMS detector measures spectral power over a pixel. No matter what the signal shape, power measurements with the RMS detector always give the true power. RMS detection is recommended for power measurements on digitally modulated signals in particular. This is because the RMS detector is the only R&S FSH detector that can give stable, true power readings. Display stability can easily be obtained by increasing the sweep time, as the measurement time for the power/pixel increases the greater the sweep time. If you are making noise measurements, for example, the trace will be highly stable if a long sweep time is selected.

However, the bandwidth occupied by the signal to be measured should at least equal the frequency covered by a trace pixel or the selected resolution bandwidth (whichever is larger). Otherwise, the power shown by the R&S FSH is too low because there are spectral components within the frequency range covered by the pixel which do not come from the signal under measurement (e.g. noise).

To obtain the true power, the video bandwidth (VBW) too should be selected to be greater than the resolution bandwidth (RBW). Otherwise, an averaging effect caused by video bandlimiting comes into play before the RMS value is calculated.

Both automatic operation and manual operation are available for setting the detector. In automatic operation, the R&S FSH selects the detector that is suitable for the trace mode that is set. In manual operation, the selected detector is always maintained regardless of the trace mode.

Setting of the detector in automatic operation:

| Trace mode | Detector |
|-------------|-----------|
| Clear/Write | Auto Peak |
| Average | Sample |
| Max Hold | Max Peak |
| Min Hold | Min Peak |

Operating sequence:

- Press the TRACE key.
- Press the DETECTOR softkey.

The submenu for selecting the detector opens.

If automatic operation has been selected, the AUTO COUPLED menu item is highlighted in green and the R&S FSH displays the detector that is set to match the trace mode that is set.

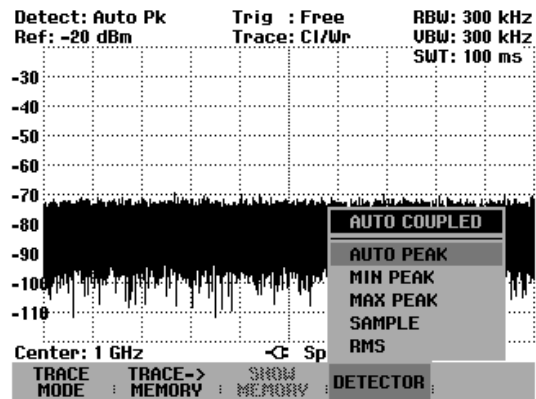

To switch automatic operation on or off:

- Using the cursor keys or rotary knob, select AUTO COUPLED from the menu.
- Using the ENTER key or the DETECTOR softkey, switch automatic operation on or off.

When automatic operation is switched on, the R&S FSH also sets the detector that matches the trace mode that is set.

To set the detector manually:

- Using the cursor keys or the rotary knob, select the detector you want and confirm by pressing the ENTER key or the DETECTOR softkey.

The R&S FSH indicates the detector that has been selected in the top left-hand corner of the screen (Detect: Auto Pk in Fig. above). If AUTO COUPLED is switched on and a detector that does not accommodate automatic operation is set, the R&S FSH will switch automatic operation off.

Trace memory

The R&S FSH can transfer a trace to the trace memory and also display the current trace and the trace in the trace memory for comparison. The saved trace is always displayed in white to distinguish it from the current trace.

Operating sequence:

- Press the TRACE key.
- Press the TRACE -> MEMORY softkey.

The R&S FSH transfers the currently displayed trace to the trace memory.

- Press the SHOW MEMORY softkey.

The R&S FSH displays the saved trace in white. The SHOW MEMORY softkey label is highlighted in green to indicate that the trace in the trace memory is being displayed.

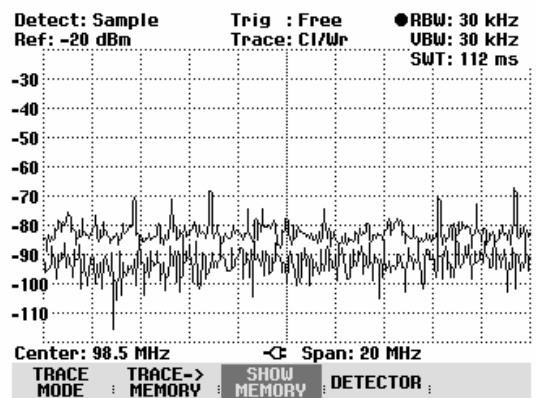

- To remove the saved trace from the screen, press the SHOW MEMORY softkey again.

Note: The memory trace is bit-mapped into the picture memory. Therefore, when the memory trace is recalled, it will not be adapted to any modifications of the reference level or span that may have been made in the meantime.

When a stored data set is called, the R&S FSH stores the associated trace in the trace memory. The stored trace can be displayed with SHOW MEMORY.

Trace mathematics

The R&S FSH can subtract a saved trace from the active trace and display the difference.

Operation:

- Press the TRACE key.
- Press the TRACE -> MEMORY softkey.

The R&S FSH transfers the currently displayed trace to the trace memory.

- Press the SHOW MEMORY softkey.

The R&S FSH displays the saved trace in white. The SHOW MEMORY softkey label is highlighted in green to indicate that the trace in the trace memory is being displayed.

- To remove the saved trace from the screen, press the SHOW MEMORY softkey again.
- Press the TRACE MATH key and select TRACE - MEM or MEM - TRACE.

The R&S FSH displays the difference between the saved trace and the active trace.

- To remove the saved trace from the screen, press the TRACE MATH softkey again and select OFF.

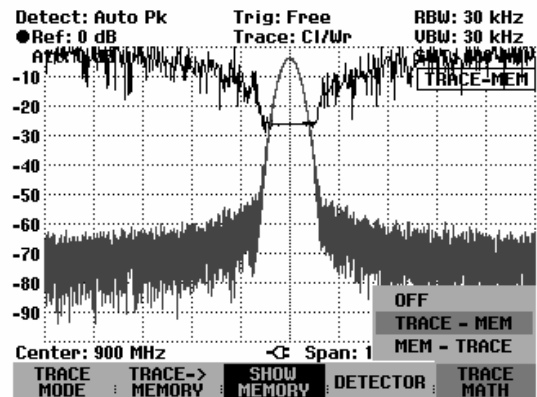

Using the Markers

The R&S FSH has a marker and a delta marker to make it easier to read off trace values. The markers cannot leave the trace and indicate the frequency and level of the point they are positioned on. The frequency indicated by a marker is shown by a vertical line which extends from the top to the bottom of the measurement diagram. The numeric frequency and level readouts are displayed in the top left-hand corner of the screen. The unit is the same as the unit of the reference level.

The position of the delta marker is indicated by a dashed line to distinguish it from the other marker. The delta marker level is always a level relative to the main marker level and so the delta marker level unit is always dB. The delta marker frequency is always relative to the main marker – in other words, the delta marker frequency is the frequency difference between the frequency at the point marked by the main marker and the frequency at the point marked by the delta marker.

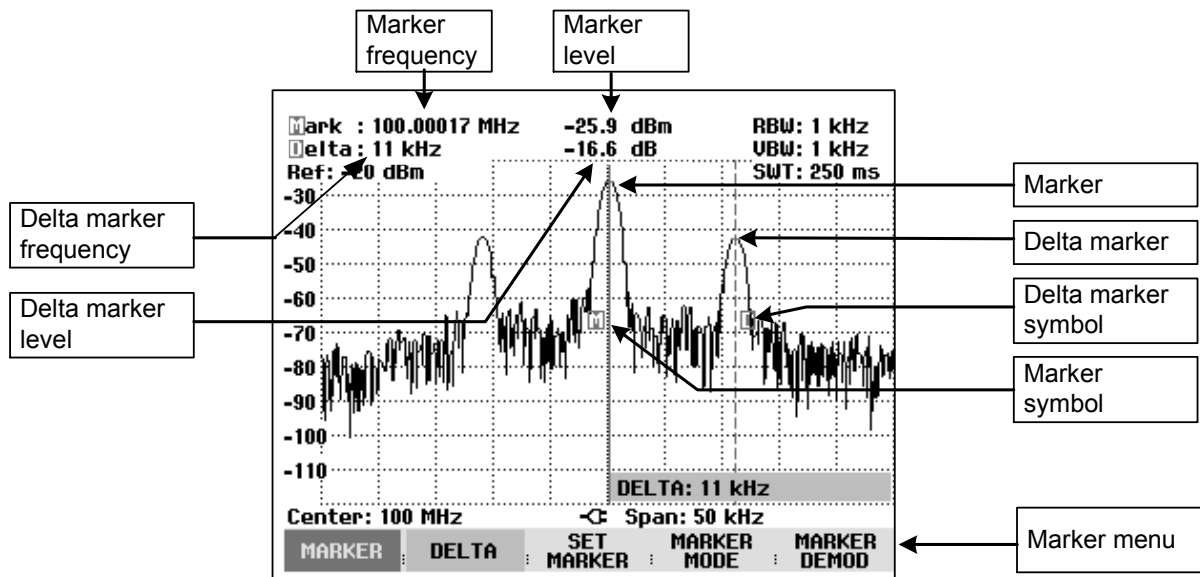

Controlling the marker:

- Press the MARKER key.

The marker menu opens. If, as yet, no marker has been activated, the main marker (MARKER) is turned on automatically and placed on the maximum level in the spectrum. The frequency and level at the point indicated by the marker are displayed at the top of the screen in the selected unit (= reference level unit). The value entry box for the marker frequency opens.

The following actions can now be performed:

- Change the marker position using the rotary knob or the cursor keys.
- Enter a marker position with the number keys and terminate the entry with one of the unit keys.
- Confirm the marker position by pressing the ENTER key or the MARKER softkey.

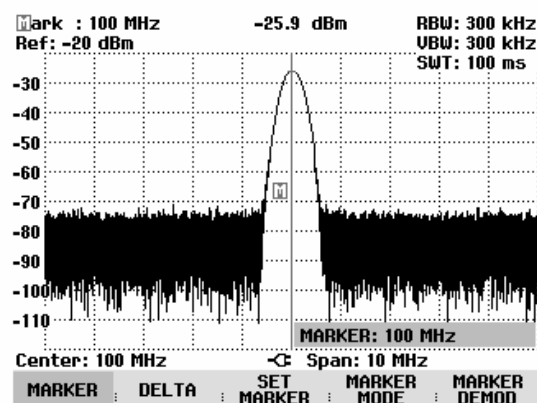

Controlling the delta marker:

- Press the MARKER key.
- Press the DELTA softkey.

The R&S FSH turns on the delta marker and places it on the second largest signal on the trace. The frequency and level displayed at the top of the screen are relative to the main marker, i.e. the R&S FSH always outputs the frequency difference and the level difference between the points marked by the main marker and the delta marker. Simultaneously, the value entry box for the delta marker frequency difference is opened.

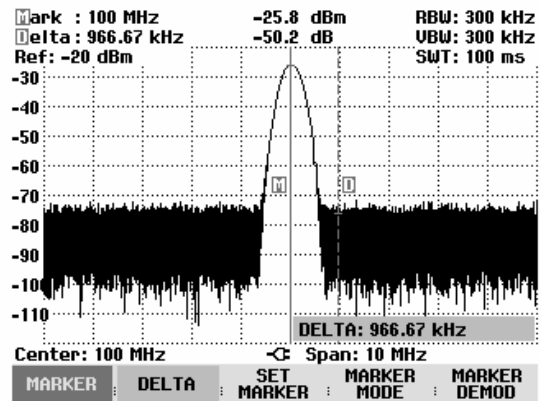

The following actions can now be performed:

- Change the delta marker position with the rotary knob or the cursor keys.
- Enter a delta marker position with the number keys and confirm with a unit key.
- Confirm the delta marker position by pressing the ENTER key or the DELTA MARKER softkey.

Automatic marker positioning

The R&S FSH has functions that make setting markers easier or allow instrument settings to be made on the basis of the current marker position:

- **PEAK** This function places the marker or the delta marker on the highest value of the trace. The function acts on the active marker, whose associated softkey labelling is highlighted in red.
- **NEXT PEAK** Relative to their current positions, this function places the marker or the delta marker on the next highest peak of the trace.
- **MINIMUM** The marker or delta marker is placed on the lowest value of the trace. The function acts on the active marker. When the trace is displayed in the CLEAR/WRITE mode, the marker is placed on the lowest maximum of the trace.
- **CENTER = MRK FREQ** When this function is called, the center frequency (CENTER) is made equal to the current marker frequency or the delta marker frequency, depending on which marker is activated (softkey label highlighted in red). This function is particularly useful if you want to investigate a signal more closely using a smaller span. This is accomplished by first placing the signal in the center of the span and then reducing the span.
- **REF LVL = MRK LVL** This function makes the level indicated by the marker the reference level. This makes it easy to optimize the R&S FSH's level display range if the levels being investigated are low.

Operating sequence:

- Press the MARKER key.
- Press the SET MARKER softkey.
- Using the cursor keys or the rotary knob, select the function you want.
- Confirm your selection with the ENTER key or the SET MARKER softkey.

The R&S FSH then performs the action you have selected.

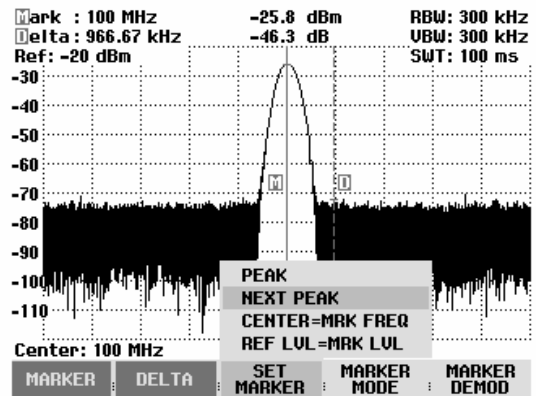

The R&S FSH allows you to use only a limited section of the trace for the PEAK, NEXT PEAK and MINIMUM functions. This is beneficial, for example, if you want to sample only spurious emissions with the marker search functions and want to omit useful signals.

- Press the SET MARKER softkey.
- Using the rotary knob or the cursor keys, select SEARCH RANGE LIMITS.
- Confirm your choice with the SET MARKER softkey or the ENTER key.

The R&S FSH opens a submenu for setting the start and stop frequencies for the marker search range.

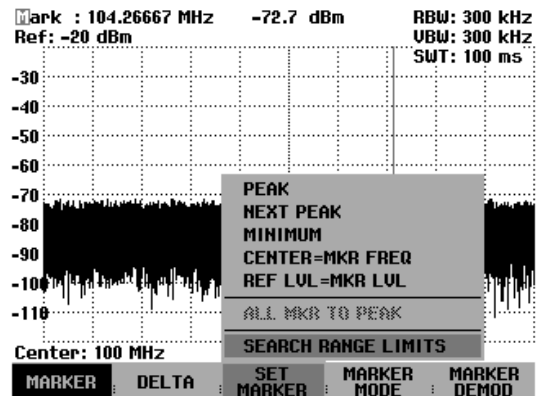

- For entering the start of the search range, select the START SEARCH menu item with the rotary knob or the cursor keys and confirm your choice by pressing the SET MARKER softkey or the ENTER key.

The R&S FSH opens the entry field for the start frequency of the search range.

- Enter a start frequency with the numeric keys and terminate the entry with the desired unit or change the start frequency with the rotary knob or the cursor keys and terminate the entry with the ENTER key.

The R&S FSH indicates the start of the search range by means of a dashed vertical line in the diagram.

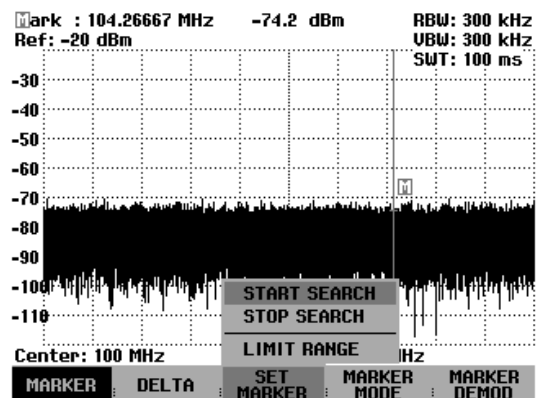

The procedure for entering the stop frequency for the search range is analogous to that for entering the start frequency.

Deactivating the marker search range:

If a marker search range is activated, the LIMIT RANGE menu item in the SEARCH RANGE LIMITS menu is highlighted in green.

- Press the SET MARKER softkey to deactivate the marker search range.
- Using the rotary knob or the cursor keys, select SEARCH RANGE LIMITS.
- Confirm your entry with the SET MARKER softkey or the ENTER key.
- Select the LIMIT RANGE menu item using the cursor keys or the rotary knob.
- Deactivate the search in the limited range using the SET MARKER softkey or the ENTER key.

If you call up the SEARCH RANGE LIMITS menu again, the LIMIT RANGE menu item is no longer highlighted.

Using more than one marker at a time (multimarker mode)

To measure different signals in a trace, the R&S FSH has the multimarker function. Up to six different markers are available in the multimarker mode. Marker 1 measures in absolute units. Markers 2 to 6 can measure in absolute units (marker) as well as relative units (delta). The reference for delta markers is always marker 1.

Operating sequence:

- Press the MARKER key.
- Press the MARKER MODE softkey.
- Using the cursor keys or the rotary knob, select MULTI MARKER... from the submenu.
- Confirm your selection with the ENTER key or the MULTI MARKER softkey.

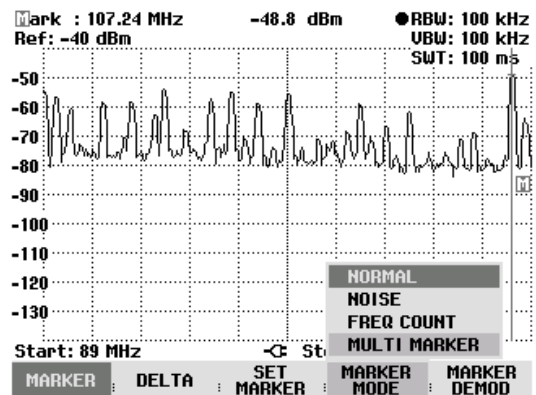

The R&S FSH is now in multimarker mode.

Except for the MARKER DEMOD softkey that is replaced by the MKR LIST VIEW softkey in multimarker mode, this menu is identical to the standard marker menu. The marker designation contains the number of the marker in question (M becomes M1, D becomes D2). The active marker or delta marker is displayed with its number (e.g. M1: or D2:) and the frequency and level at the upper-right hand corner of the screen.

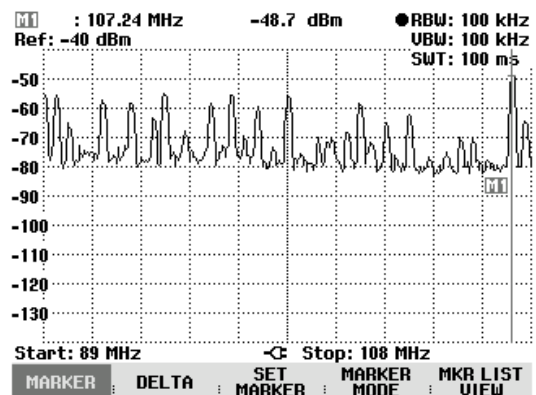

- Press the MARKER or DELTA softkey.

The R&S FSH opens a list for selecting the marker or delta marker to be edited. The markers that are already switched on are highlighted in green. The (delta) marker numbers already allocated to a (delta) marker are deactivated, i.e. greyed out.

- Using the rotary knob or the cursor keys, select the marker or delta marker you want and confirm your selection with the ENTER key or the MARKER or DELTA softkey.

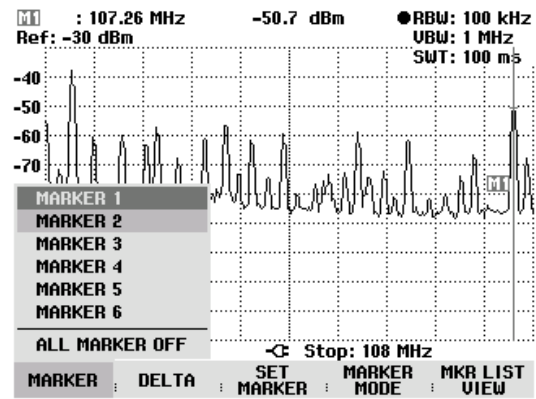

The R&S FSH opens the entry box for the frequency of the selected marker or the spacing between the delta marker and the reference marker M1.

- Using the cursor keys, place the marker or delta marker near the position you want. The step width here is 10 % of the X axis.
- Then use the rotary knob to fine-tune the marker or delta marker to the signal. The step width corresponds to the pixel spacing of the trace.
- Alternatively, enter the desired position of the marker or delta marker using the number keys and terminate the entry with one of the unit keys.

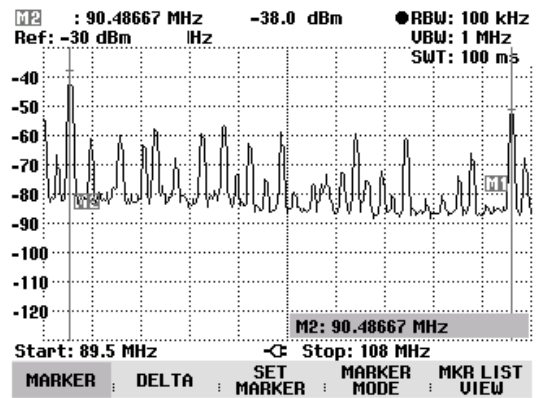

The R&S FSH displays the marker or delta marker last edited in the marker readout box at the upper left-hand corner of the screen. All marker functions in the SET MARKER menu apply to the displayed markers.

Automatic marker positioning:

Automatic positioning of markers in multimarker mode is similar to that of the normal marker. The different functions always apply to the active marker, which is also indicated for the various functions in the SET MARKER menu (example: "M2; PEAK").

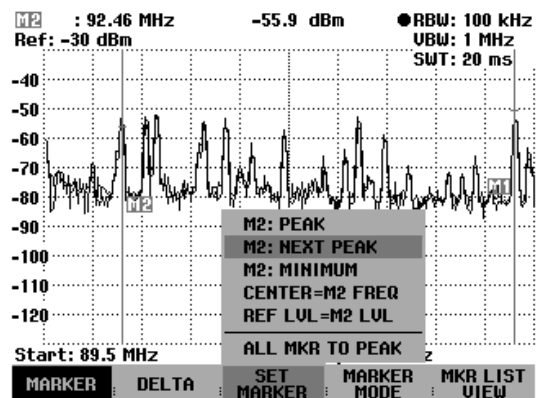

In addition, it is possible to position all activated markers (M1 to M6) at the peak of a trace.

- In the SET MARKER menu, select ALL MKR TO PEAK and confirm this with the ENTER key or the SET MARKER softkey.

The R&S FSH sets all activated markers to the maxima of the trace. The delta markers remain unaffected by this function.

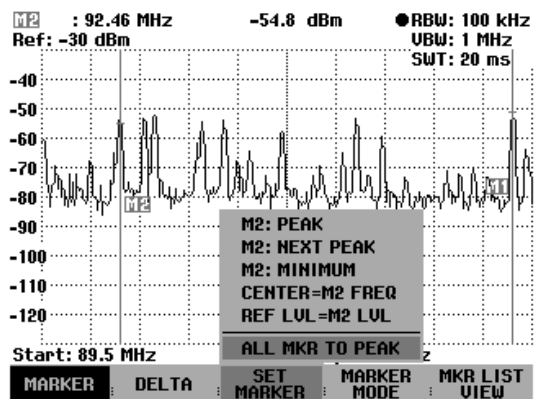

Displaying all multimarker values:

The R&S FSH can display a list of all activated markers and their values.

- Press the MKR LIST VIEW softkey.

The R&S FSH displays a list of all activated markers and delta markers.

If you press the MKR LIST VIEW softkey again or any other softkey in the marker menu, the R&S FSH closes the marker table.

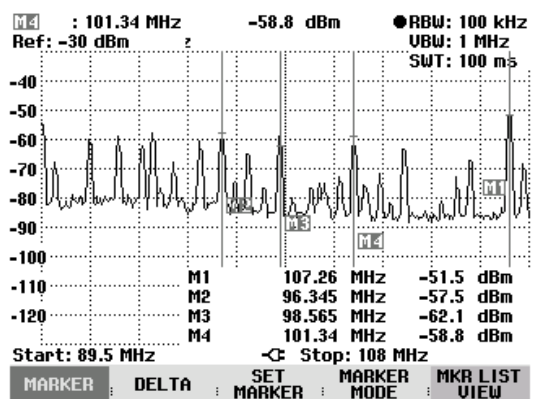

Deactivating markers:

In multimarker mode, markers can be deactivated one at a time or all at once.

Deactivating markers or delta markers one at a time:

- Press the MARKER or DELTA softkey.

The activated markers or delta markers are highlighted in green.

- Using the rotary knob or the cursor keys, select an activated marker or delta marker, i.e. place the red cursor on the appropriate item.

The value entry box for the selected marker appears.

- Press the MARKER or DELTA softkey to deactivate the selected marker or delta marker.

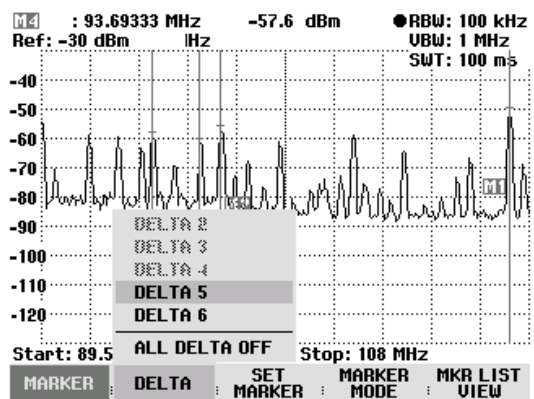

Note: If marker 1 (M1) is deactivated, the R&S FSH also deactivates all delta markers, because they use marker 1 as a reference.

Deactivating all markers or delta markers:

- Press the MARKER or DELTA softkey.
- Using the rotary knob or the cursor keys, select ALL MARKERS OFF or DELTA OFF.
- Press the ENTER key or the MARKER or DELTA softkey to deactivate all markers or delta markers.

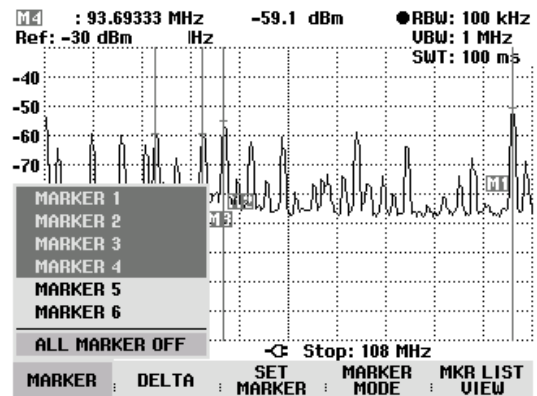

Note: When the markers are deactivated, the R&S FSH also deactivates all delta markers, because they use marker 1 as a reference.

Exiting the multimarker mode:

- Press the MARKER key.
- Press the MARKER MODE softkey.
- Using the cursor keys or the rotary knob, select NORMAL, NOISE or FREQ COUNT from the submenu.
- Confirm your selection with the ENTER key or the MARKER MODE softkey.

The R&S FSH returns to the normal marker mode.

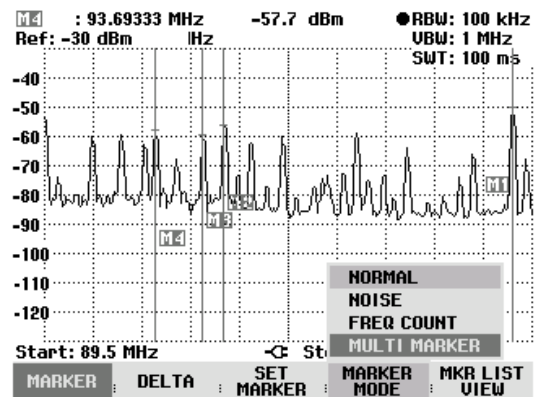

The R&S FSH transfers the settings of the multimarker and multi delta marker with the lowest numbers to the normal marker mode.

Alternatively, you can exit the multimarker mode by deactivating all markers (MARKER key: MARKER softkey: ALL MARKERS OFF menu item) or with PRESET.

Marker functions

Apart from displaying the level and frequency at the marker position (NORMAL setting), the R&S FSH can also perform other forms of analysis at the marker position. For example, the R&S FSH can calculate the noise power density referred to 1 Hz bandwidth (NOISE function) or measure the frequency of a signal at the marker position (FREQ COUNT function).

Measuring the noise power density

The NOISE function is used to calculate the noise power density at the marker position. The R&S FSH calculates the noise power density in dBm/(1 Hz) from the trace pixel values, the selected resolution bandwidth, the detector and the level display mode (absolute or relative). To stabilize the noise power display, the R&S FSH uses the pixel on which the marker is positioned and the four pixels to the right and the four pixels to the left of the marker pixel. Noise power density can provide useful information

when measurements are made on noise or digitally modulated signals. However, valid results are obtained only if the spectrum in the vicinity of the marker has a flat frequency response. The function gives incorrect results if measurements are made on discrete signals.

Operating sequence:

- Press the MARKER key.
- Press the MARKER MODE softkey.
- Using the cursor keys or the rotary knob, select the NOISE menu item.
- Confirm the selection with the ENTER key or by pressing the MARKER MODE softkey again.

The R&S FSH now indicates the marker level in dBm/Hz. If the delta marker is the active marker, it displays the result in dBc/Hz. The reading is referred to the main marker.

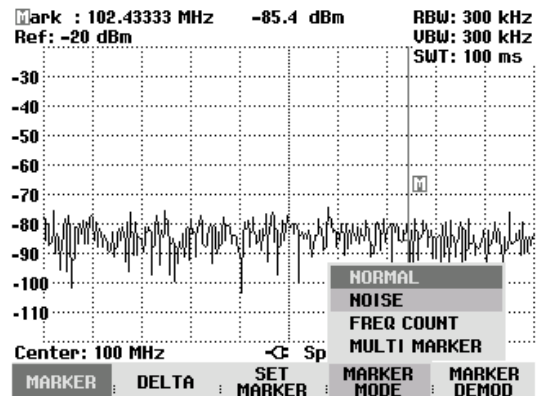

Measuring the frequency

The FREQ COUNT function is used to measure the frequency at the marker position. The accuracy of the marker frequency readout is then no longer dependent on the pixel resolution of the trace, but only on the accuracy of the internal reference frequency.

The R&S FSH calculates the marker frequency from the center frequency, the span and the frequency of the trace pixel on which the marker is positioned. The trace has 301 pixels corresponding to 301 frequency coordinates. The frequency resolution is therefore relatively coarse – especially if a large span is set. To circumvent this problem, the R&S FSH's internal frequency counter can be used. When frequency measurements are being made, the R&S FSH briefly stops the sweep at the marker position and measures the frequency using the frequency counter. The resolution of the frequency counter is 0.1 Hz and so is considerably higher than the resolution that is obtained without the FREQ COUNT function. Even though the resolution is high, frequency counting is extremely fast due to a special algorithm for the IQ baseband signal (approx. 30 ms at a resolution of 1 Hz). Basically, the accuracy of the frequency readout depends only on the accuracy of the internal reference frequency (TCXO).

The frequency counter only gives completely accurate readings for sine signals that are at least 20 dB above the noise floor. If the S/N ratio is less, noise affects the results.

Operating sequence:

- Press the MARKER key.
- Press the MARKER MODE softkey.
- Using the cursor keys or the rotary knob, select the FREQ COUNT menu item.
- Confirm the selection with the ENTER key or by pressing the MARKER MODE softkey again.

The R&S FSH now displays the counted marker frequency with a resolution of 1 Hz. To indicate that the FREQ COUNT function is on, Mark in the top left corner of the screen changes to 'Count'.

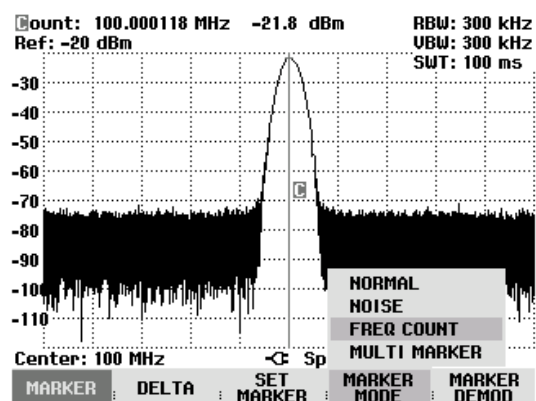

AF demodulation

The R&S FSH has an AM and FM demodulator for audiomonitoring signals. The demodulated AF signal can be listened to with headphones (supplied accessories). The headphones are connected to the 3.5 mm jack on the left-hand side of the carrying handle. As the R&S FSH makes the uncontrolled video voltage audible in the case of AM demodulation, it is advisable to set the reference level so that the level of the signal to be demodulated is near the reference level.

When spectrum measurements are being made, the R&S FSH demodulates the signal at the marker frequency for a settable period of time. The sweep stops at the marker frequency for the demodulation period and then continues. If time-domain measurements are being made (span = 0 Hz), the R&S FSH performs continuous demodulation.

Operating sequence:

- Press the MARKER key.
- Press the MARKER DEMOD softkey.

The submenu for setting demodulation parameters opens. If no markers have been activated, the R&S FSH automatically turns on the marker and positions it on the trace maximum.

- Using the cursor keys or the rotary knob, select the demodulation mode (AM or FM) you want and confirm your selection with the ENTER key.

Note: When the AF demodulation mode is selected, the R&S FSH automatically turns off the noise marker or the frequency counter.

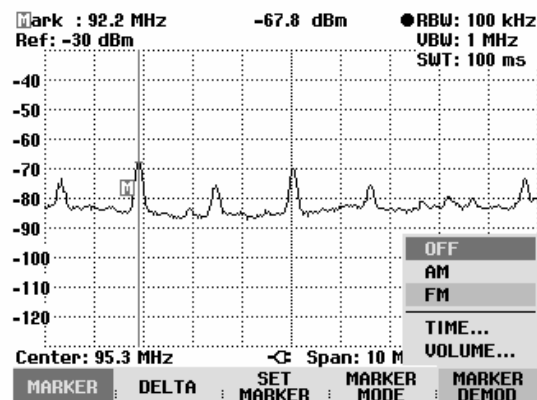

- To enter the demodulation time, select the TIME... item in the menu.

The currently set demodulation time is displayed in the value entry box. The demodulation time range is 100 ms to 500 s. If the R&S FSH is set to span = 0 Hz, the demodulation time setting is irrelevant as continuous demodulation is always performed.

- Change the time with the cursor keys or the rotary knob or enter a time using the number keys and confirm with the ENTER key.
- To adjust the volume, select the VOLUME... menu item and confirm your selection with the ENTER key.

The R&S FSH displays the volume in % in the value entry box. The volume range is 0 % (very low) to 100 % (full volume).

- Using the cursor keys or the rotary knob, adjust the volume or enter the volume in % using the number keys and confirm with the ENTER key.

To indicate that AF demodulation is on, the softkey label MARKER DEMOD is highlighted in green when you quit the submenu.

Using the Display Line

In addition to the markers, the R&S FSH provides a horizontal line for determining the signal level in the display.

- Press the MEAS key.
- Press the DISPLAY LINE softkey.

The R&S FSH displays a horizontal line across the entire diagram. To distinguish it from other lines, it is labelled 'L'. The Y position of the line is indicated at the top left of the diagram (Line: -53 dBm in the diagram shown at the right).

- The line can be moved in the Y direction with the cursor keys or the rotary knob, or a level position can be entered with the numeric keys.

Terminate the entry with the ENTER key.

The softkey label DISPLAY LINE is printed on a green background and the entry box is cleared.

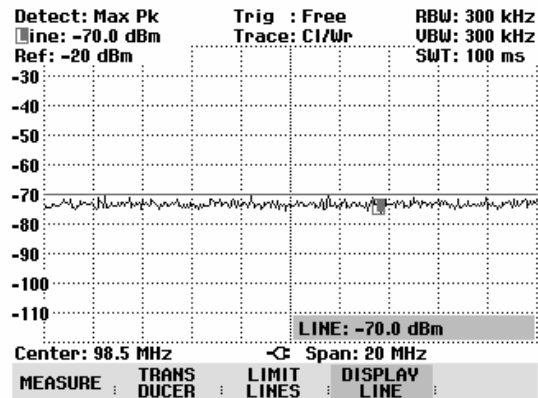

In contrast to the markers, the position of the displayed line is pixel-oriented. The line resolution in the Y direction therefore depends on the measurement range set in the Y direction. For a display range of 100 dB, it is 0.5 dB. When the line is set with the rotary knob, the R&S FSH always uses the step width of the display resolution in the Y direction, e.g. 0.5 dB for a 100 dB level measurement range. The cursor keys, on the other hand, always move the line by 10 % of the display range in the Y direction. For fast setting of the display line, we therefore recommend to set the line near the desired position with the cursor keys and then to use the rotary knob for fine adjustment.

Setting and Using the Measurement Functions

If you want to perform complex measurements, the R&S FSH provides measurement functions which perform certain measurement tasks with a minimum of keystrokes or, in conjunction with various accessories, will allow you to perform advanced measurements.

Measuring the channel power of continuously modulated signals

Due to the channel power measurement function, the power of modulated signals can be measured selectively. Unlike a power meter which measures power over its whole frequency range, the channel power mode allows the power in a specific transmission channel to be measured. Other signals in the frequency spectrum have no effect on the result.

When the channel power mode is selected, the R&S FSH determines the spectrum within the channel using a resolution bandwidth that is small in comparison with the channel bandwidth. The measured values on the trace are then integrated to give the total power. The R&S FSH takes into account the selected display mode (absolute or relative), the selected detector and the resolution bandwidth, which means that the result is comparable to the result that would have been obtained from a thermal power meter. The small resolution bandwidth acts like a narrow channel filter and so prevents out-of-channel emissions from affecting the result.

The R&S FSH has presettings for the 3GPP WCDMA, cdmaOne and CDMA2000 1x systems and so the user does not have to enter any settings himself. However, user-defined channel settings can also be entered to set up the R&S FSH for other communications systems.

Operating sequence:

- Press the MEAS key.
- Press the MEASURE softkey.

The submenu for selecting the measurement functions opens.

- Using the rotary knob or the cursor keys, select the CHANNEL POWER menu item. (CHANNEL POWER highlighted in red)
- Confirm your selection with the ENTER key or the MEASURE softkey.

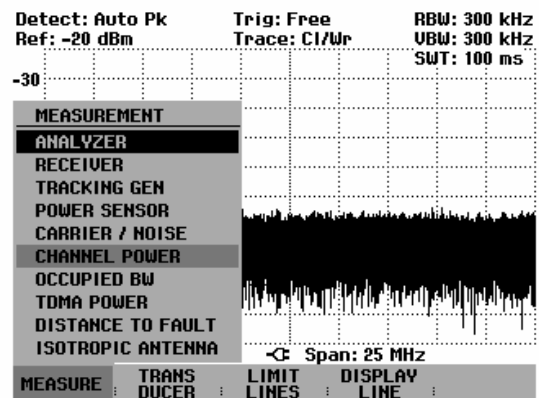

The R&S FSH displays the softkey menu for setting the channel power measurement. Two vertical lines in the measurement diagram indicate the channel bandwidth. The measured channel power is shown in large letters below the measurement diagram.

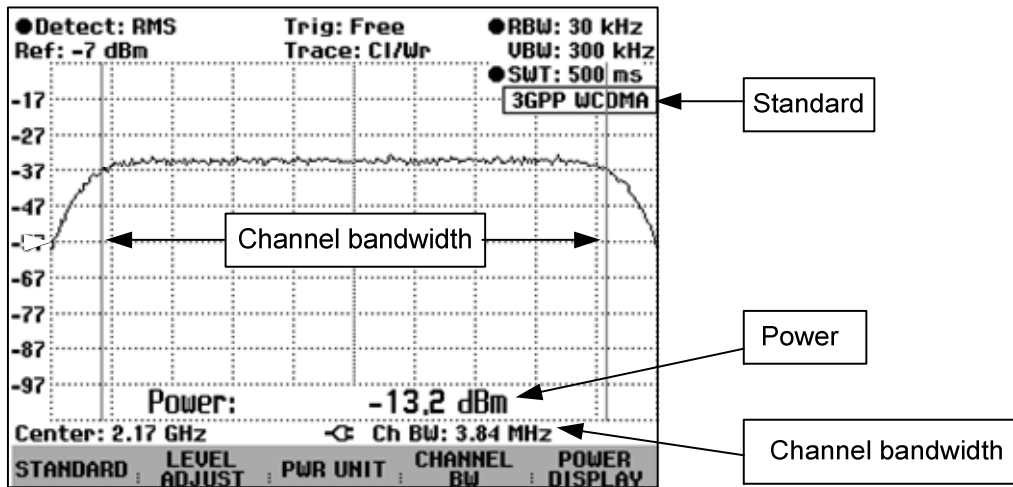

The default setting is power measurement for 3GPP WCDMA signals.

Selecting the standard

The R&S FSH has a channel power measurement default setting for various standards. It is also possible to define and save user-specified configurations.

- Press the STANDARD softkey.

A submenu with the available standards opens.

- Select the standard you want using the rotary knob or the cursor keys.
- Confirm your selection with the ENTER key or the STANDARD softkey.

The R&S FSH sets the selected standard. The optimal span, resolution bandwidth, video bandwidth, sweep time and detector for the standard are selected automatically.

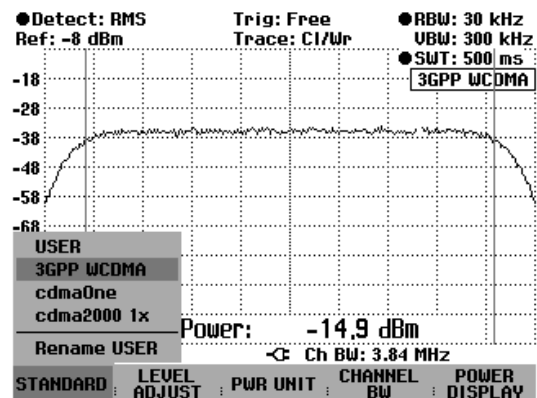

If USER is selected, the R&S FSH sets the last channel power measurement setting used in the USER mode. The R&S FSH automatically makes changes to the setting so that it is again available when the USER standard is called again.

The following should be noted when changes to the settings are made:

- The span is always coupled to the channel bandwidth. When changes are made, the R&S FSH automatically sets the appropriate span.
- The resolution bandwidth should be between 1 % and 4 % of the channel bandwidth. This means that the channel power measurement has good selectivity with respect to adjacent channels.
- The video bandwidth must be at least three times the resolution bandwidth. This prevents incorrect results due to the compression of signal peaks by the video filter.

- The RMS detector is recommended. This ensures that the true power is always obtained irrespective of the shape of the signal being investigated.
- The sweep time must be set so that the result is stable. If the sweep time is increased, the R&S FSH also increases the integration time for the RMS detector and so ensures more stable measured values.

Renaming the USER standard:

The setting for the USER standard can be assigned a user-defined name. Thus, the setting used by the R&S FSH in the USER setting is immediately clear. The name entered as the USER standard also appears on the screen, thus making it possible to document the setting along with the measurement.

Press the STANDARD softkey.

The R&S FSH will open a table with the available standards.

- Select Rename USER with the rotary knob or the cursor keys.
- Confirm your selection with the ENTER key or the STANDARD softkey.

The R&S FSH will open the input window for the name of the USER standard.

- Using the numeric keys, enter a name.
- Press the ENTER key to complete the entry.

When the STANDARD menu is called, the entered name appears under USER (e.g. DAB (USER)). The name also appears at the top right-hand corner of the screen after the USER standard is selected.

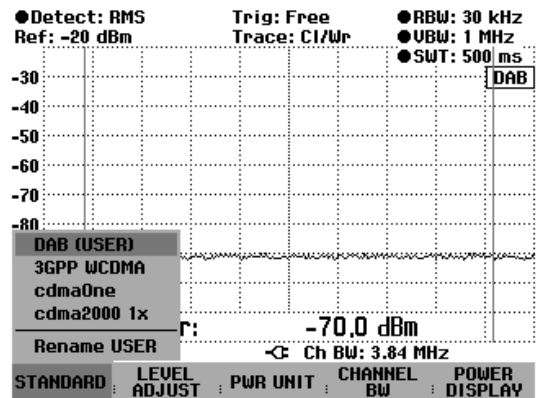
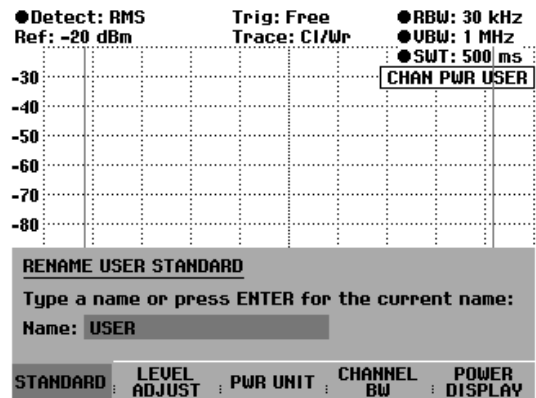

Using the R&S FSH View control software, additional standards can be generated and permanently loaded into the R&S FSH. You can also delete the factory-set standards provided in the instrument if you do not need them. The R&S FSH then offers only the standards you require, for example for measurements on TV signals.

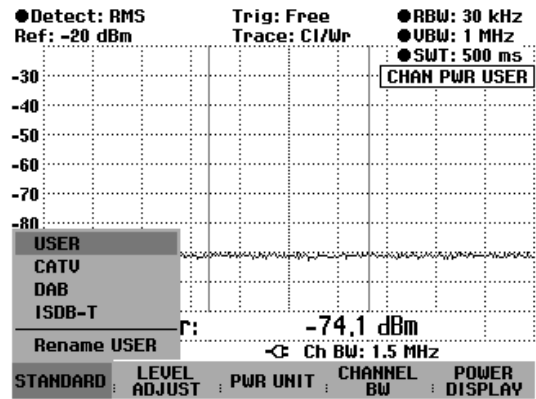

Setting the reference level

When selecting the reference level, ensure that the R&S FSH is not overdriven. As the power is measured with a resolution bandwidth that is small in comparison with the signal bandwidth, the R&S FSH may still be overdriven even though the trace is still within the measurement diagram. To prevent the R&S FSH from being overdriven, the signal can be measured at the largest resolution bandwidth possible using the peak detector. If this setting is selected, it is not possible for the trace to exceed the reference level.

To simplify operation and to prevent incorrect measurements, the R&S FSH has an automatic routine for setting the reference level.

- Press the LEVEL ADJUST softkey.

The R&S FSH starts the measurement of the optimal reference level using a resolution bandwidth of 1 MHz, a video bandwidth of 1 MHz and the peak detector. During the measurement, the message "Adjusting level for channel power measurement, please wait..." is output.

The optimal reference level is then set.

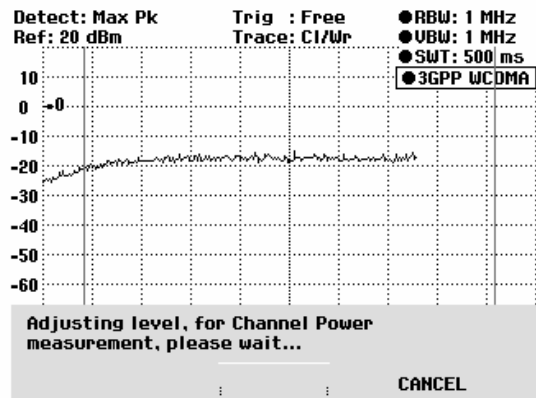

Setting the channel bandwidth

The channel bandwidth specifies the frequency range about the center frequency, over which the R&S FSH performs the power measurement.

- Press the CHAN BW softkey.

The value entry box showing the current channel bandwidth setting opens.

- Using the number keys enter a new channel bandwidth and terminate the entry with the appropriate unit, or
- Using the rotary knob or the cursor keys, change the channel bandwidth and confirm with the ENTER key or the CHANNEL BW softkey.

The R&S FSH automatically sets the appropriate span for the channel bandwidth that has been entered (span = 1.2 x channel bandwidth) to ensure that no incorrect channel power measurements are made.

The minimum channel bandwidth that can be set is 8.33 kHz with R&S FSH3 models 1145.5850.03 and 1145.5850.13.

If you attempt to enter a smaller channel bandwidth, the R&S FSH will automatically set 8.33 kHz and output the message “Out of range”.

With the R&S FSH3 model 1145.5850.23 and with the R&S FSH6, the minimum channel bandwidth is 833 Hz at a span of 1 kHz.

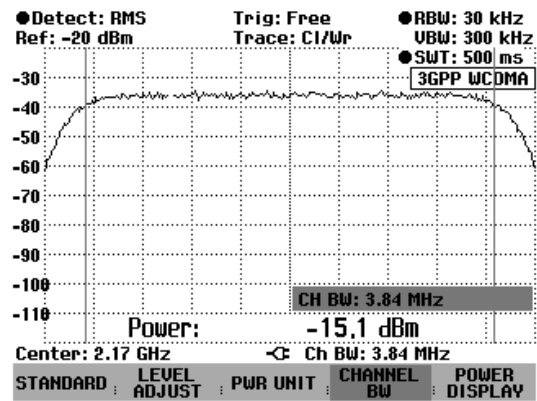

Changing the span

The span set by the R&S FSH yields extremely precise measurement results. However, signals in the environment of the measurement channel are no longer detectable. To enable users to see the spectrum outside the measurement channel, the span can be changed up to a factor of ten times the channel bandwidth during the channel power measurement.

Operation:

- Press the SPAN key.

The AUTO SPAN softkey label is highlighted in green to indicate that the optimum span for the channel power measurement is set. MANUAL SPAN is activated to allow immediate entry of another span.

- Using the numeric keys, enter a new span and terminate the entry with the appropriate unit, or
- Change the span with the rotary knob or the cursor keys and terminate the entry with the ENTER key or the MANUAL SPAN softkey.

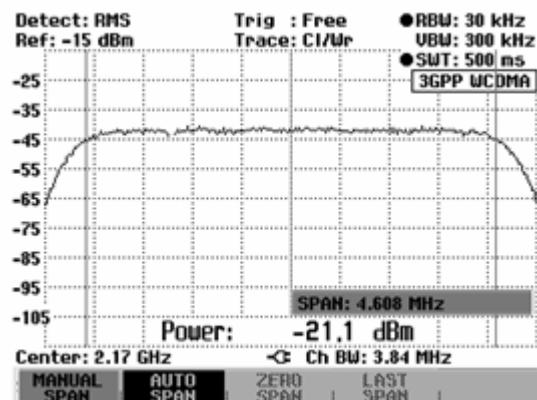

The largest permissible span for the channel power measurement is ten times the channel bandwidth. At larger spans, the result of the channel power measurement would be increasingly imprecise, because too few points of the trace occur in the channel to be measured.

- Press the AUTO SPAN softkey to again set the optimum span.

- To return to the menu for channel power measurement, press the MEAS key.

Measurement of maximum channel power:

If signal levels fluctuate significantly, you can define the maximum channel power by using the Max Hold function.

Operation:

- Press the POWER DISPLAY softkey.
- Select MAX HOLD by using the cursor keys or the rotary knob and then confirm with the POWER DISPLAY softkey or the ENTER key. The power display will switch from "Power" to "Max Power".
- To deactivate the Max Hold function, press the POWER DISPLAY softkey.
- Select CLR/WRITE by using the cursor keys or the rotary knob and confirm with the ENTER key. The power display will switch from "Max Power" to "Power".

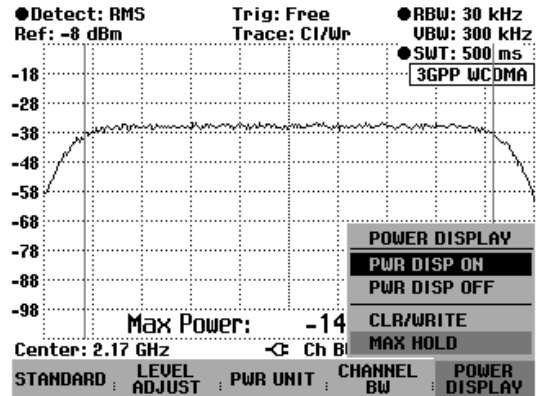

Power display

The R&S FSH displays the power at the bottom of the measurement diagram (Power = nn.n dBm). Usually the trace is not obscured. However, if the trace is in this area of the screen, the power readout can be removed from the screen. Simply press the PWR DISP ON/OFF softkey. If the softkey label is highlighted in green, the power readout is on.

Operation:

To deactivate the power display:

- Press the POWER DISPLAY softkey.
- Select PWR DISP OFF by using the cursor keys or rotary knob and confirm with the POWER DISPLAY softkey or the ENTER key.

To activate the power display:

- Press the POWER DISPLAY softkey.
- Select PWR DISP ON by using the cursor keys or rotary knob and confirm with the POWER DISPLAY softkey or the ENTER key.

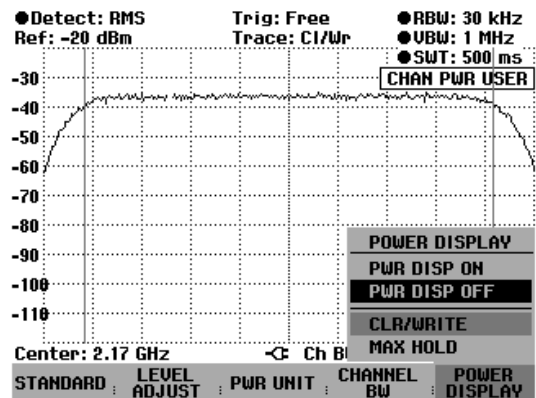

Unit for power display:

The R&S FSH can use different units for power output. The basic unit is dBm.

- Press the PWR UNIT softkey.

The R&S FSH opens the submenu with the units: dBm, dBmV and dBμV.

- Using the rotary knob or the cursor keys, select the required unit.
- Confirm your selection with the ENTER key or the PWR UNIT softkey.

The R&S FSH displays the power level in the selected unit.

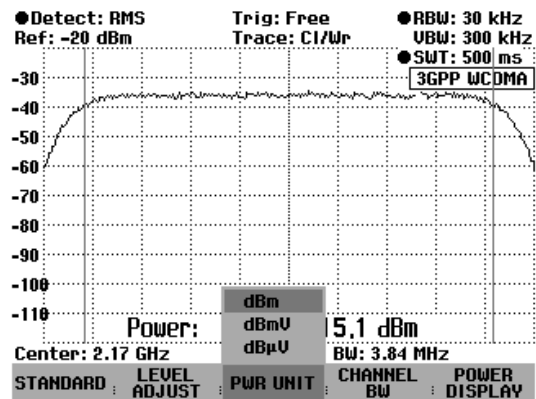

Power measurements on TDMA signals

When TDMA (time division multiple access) methods are used, e.g. for GSM, several users share a channel. Each user is assigned a period of time or timeslot. The R&S FSH's TDMA POWER function measures the power over one of these timeslots. This is a time-domain measurement (span = 0 Hz). The power measurement is started on an external trigger or the video trigger. The power measurement time is selected with MEAS TIME.

To prevent incorrect power measurements in the time domain, ensure that the whole signal lies within the selected resolution bandwidth. If the resolution bandwidth is too narrow, the displayed power will be lower than the actual power.

- Press the MEAS key.
- Press the MEASURE softkey.

The measurement function menu will open.

- Using the rotary knob or the cursor keys, select TDMA POWER.
- Confirm your selection with the ENTER key or the MEAS softkey.

The R&S FSH will display the softkeys for configuring time-domain power measurements.

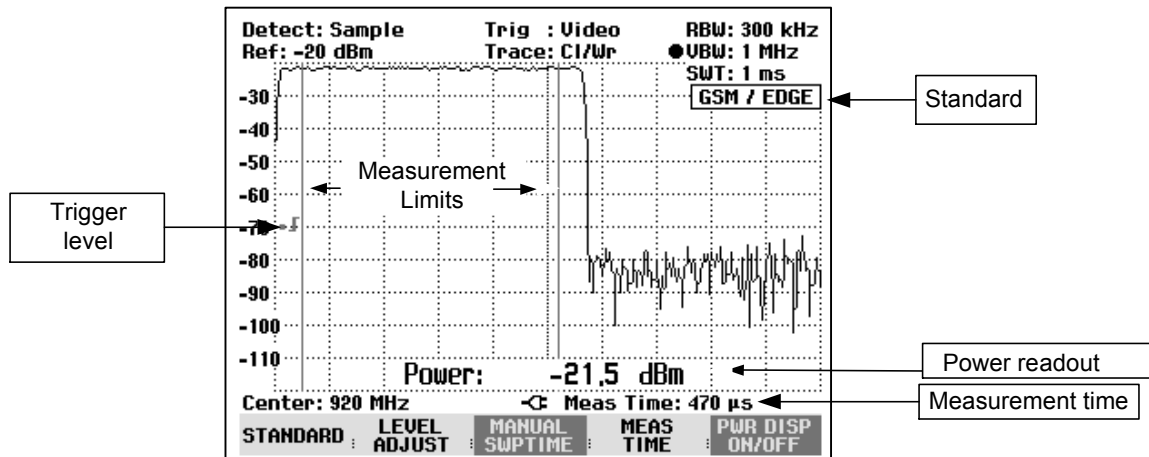
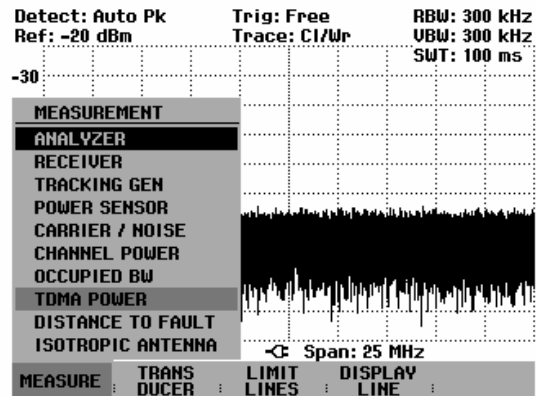

Selecting a standard

When the function is switched on, the R&S FSH automatically selects the GSM/EDGE standard. All default settings are selected so that power measurements on GSM or EDGE bursts give true readings.

A different default setting can be configured with USER.

- Press the STANDARD softkey.
- Using the rotary knob or the cursor keys, select the USER menu item.
- Confirm your selection with the ENTER key or the STANDARD softkey.

The USER STANDARD settings that have already been stored are set on the R&S FSH. When the USER STANDARD is called for the first time, it sets the measurement parameters for the GSM/EDGE standard.

If the USER STANDARD is set, the R&S FSH automatically accepts all measurement parameter changes so that they are available next time USER STANDARD is selected.

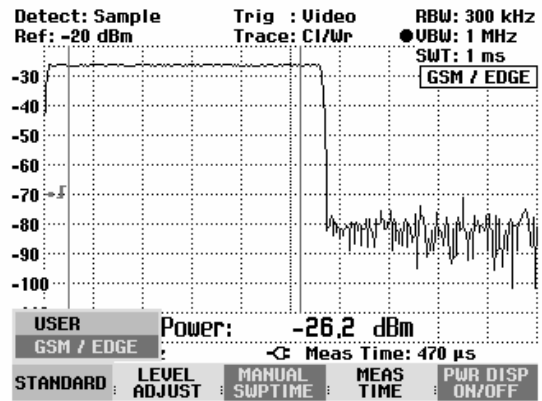

Renaming the USER standard:

The setting for the USER standard can be assigned a user-defined name. The name entered as the USER standard also appears on the screen, thus making it possible to document the setting along with the measurement.

- Press the STANDARD softkey.
- A table with the available standards opens.
- Select Rename USER with the rotary knob or the cursor keys.
 - Confirm your selection with the ENTER key or the STANDARD softkey.

The R&S FSH will open the input window for the name of the USER standard.

- Using the numeric keys, enter a name.
- Press the ENTER key to complete the entry.

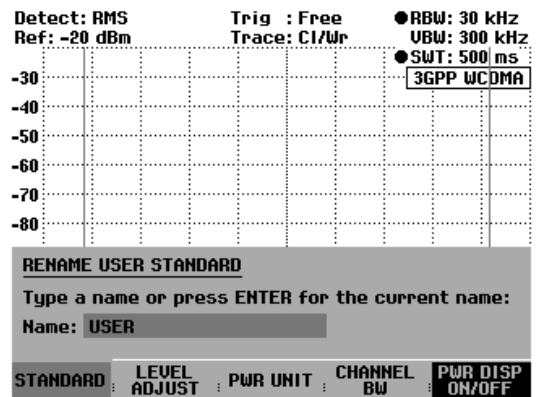

When the STANDARD menu is called, the entered name appears under USER (e.g. TETRA (USER)). The name also appears at the top right-hand corner of the screen after the USER standard is selected.

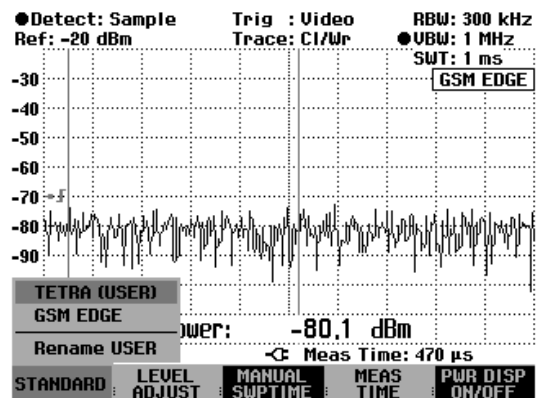

Using the R&S FSH View control software, additional standards can be generated and permanently loaded into the R&S FSH. You can also delete the factory-set standards provided in the instrument if you do not need them. The R&S FSH then offers only the standards you require.

Setting the measurement time

The measurement time (MEAS TIME) is the time over which the R&S FSH performs a power measurement. A value less than or equal to the sweep time can be selected.

- Press the MEAS TIME softkey.

The value entry box displaying the current measurement time opens.

- Using the number keys, enter a new measurement time and terminate the entry with the appropriate unit, or
- Using the rotary knob or the cursor keys change the measurement time and confirm with the ENTER key or the MEAS TIME softkey.

If the measurement time you have entered is greater than the sweep time, the R&S FSH outputs the message "Maximum reached" and sets a measurement time equal to the sweep time. If you want to set a longer measurement time, you must increase the sweep time first.

The minimum measurement time is the time corresponding to one trace pixel (= sweep time /301).

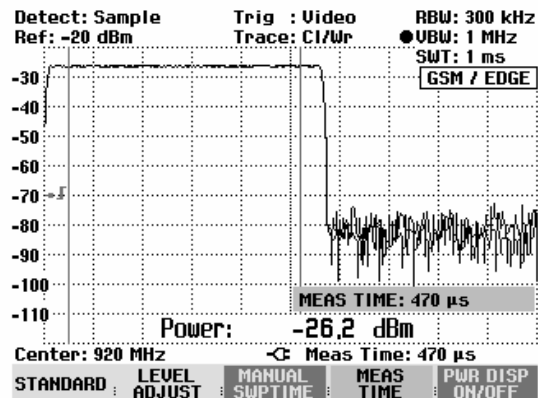

Optimizing the reference level

To obtain the greatest possible dynamic range for burst signals, the lowest reference level possible must be set. If this is not done, the R&S FSH will be overdriven by the measurement signal, if its maximum level exceeds the maximum reference level. Because the R&S FSH's resolution bandwidths are implemented digitally after the A/D converter, depending on the resolution bandwidth selected, the signal level at the A/D converter can be higher than the level indicated by the trace. To prevent the A/D converter from being overdriven, the signal must be measured at the widest resolution bandwidth (1 MHz) and video bandwidth (1 MHz) with the peak detector. The trace maximum then determines the optimal reference level.

The R&S FSH's LEVEL ADJUST routine will automatically determine the optimal reference level for you.

- Press the LEVEL ADJUST softkey.

The R&S FSH starts the measurement to determine the optimal reference level, using a resolution bandwidth of 1 MHz, a video bandwidth of 1 MHz and the peak detector. While the measurement is in progress, the R&S FSH outputs the message "Adjusting level for TDMA power measurement, please wait...".

The optimal reference level is then set.

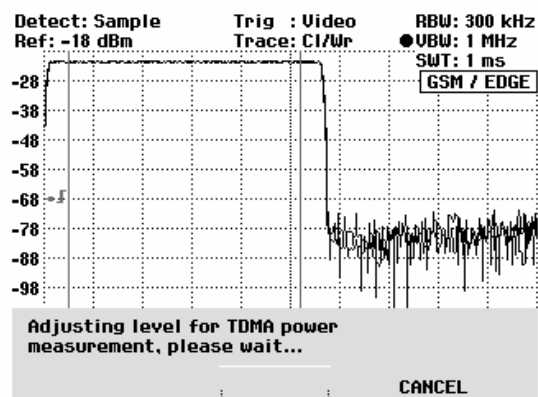

Power readout

The R&S FSH displays the measured power at the bottom of the measurement diagram (Power = nn.n dBm). Usually the trace is not obscured. However, if the trace is in this area of the screen, the power readout can be removed from the screen. Simply press the PWR DISP ON/OFF softkey. If the softkey label is highlighted in green, the power readout is on.

Setting the trigger

A trigger is usually required to perform power measurements on bursts. In the default setting, the R&S FSH is configured to use the video trigger at 50 % of the Y scale on the measurement diagram. Assuming that the burst on which the measurement is to be made crosses the 50 % point of the trigger, the R&S FSH will trigger on the rising edge of the burst.

Should this not be the case, the trigger level must be adjusted so that the R&S FSH is triggered by the burst edge. Otherwise no measurement will be performed.

If the DUT has a trigger facility, the external trigger can also be used for the measurement.

- Connect the DUT's trigger output to the R&S FSH's trigger input.
- Press the SWEEP key.
- Press the TRIGGER softkey.
- Select the EXTERN menu item (rising or falling edge).
- Confirm your selection with the ENTER key or the TRIGGER softkey.

Select the appropriate trigger delay to position the burst in the measurement window.

- Press the DELAY... softkey.
- Using the rotary knob or the cursor keys, adjust the trigger delay until the TDMA burst is inside the vertical lines indicating the measurement range, or
- Using the number keys, enter the appropriate trigger delay and terminate the entry with the appropriate unit key.

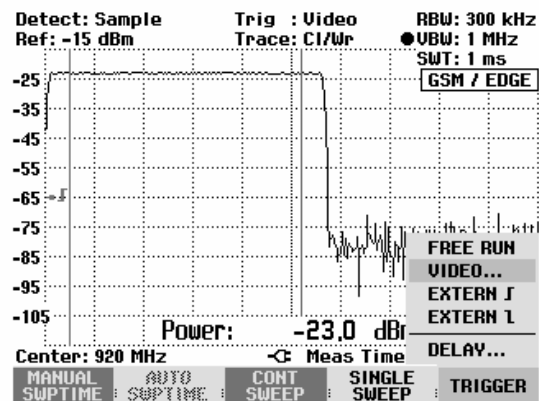

Measuring the occupied bandwidth

Ensuring the proper operation of a transmission network requires that all transmitters adhere to the bandwidths assigned to them. This is checked by measuring the occupied bandwidth, which is defined as the bandwidth in which a specified percent (99 %) of power is transmitted.

One of the measurement functions of the R&S FSH is the measurement of occupied bandwidth. After the channel bandwidth has been entered, the R&S FSH automatically selects the measurement parameters so that an optimal result is attained.

Operation:

- Press the MEAS key.
- Press the MEASURE softkey.

The R&S FSH will open the measurement function menu.

- Using the rotary knob or the cursor keys, select OCCUPIED BW from the menu (highlighted in red).
- Confirm your selection with the ENTER key or the MEASURE softkey.

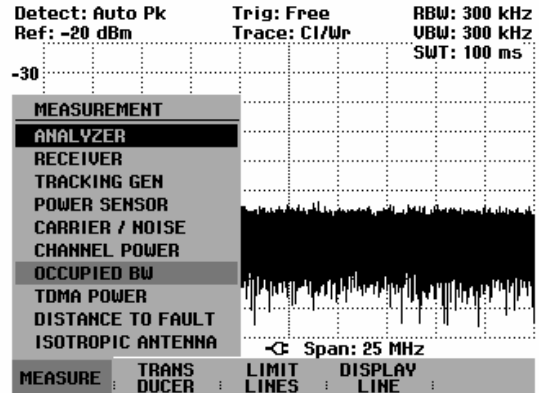

The R&S FSH displays the softkey menu for setting the measurement of occupied bandwidth. Two vertical lines in the measurement diagram indicate the occupied bandwidth. The measured numeric value (OBW) is shown in large characters below the measurement diagram.

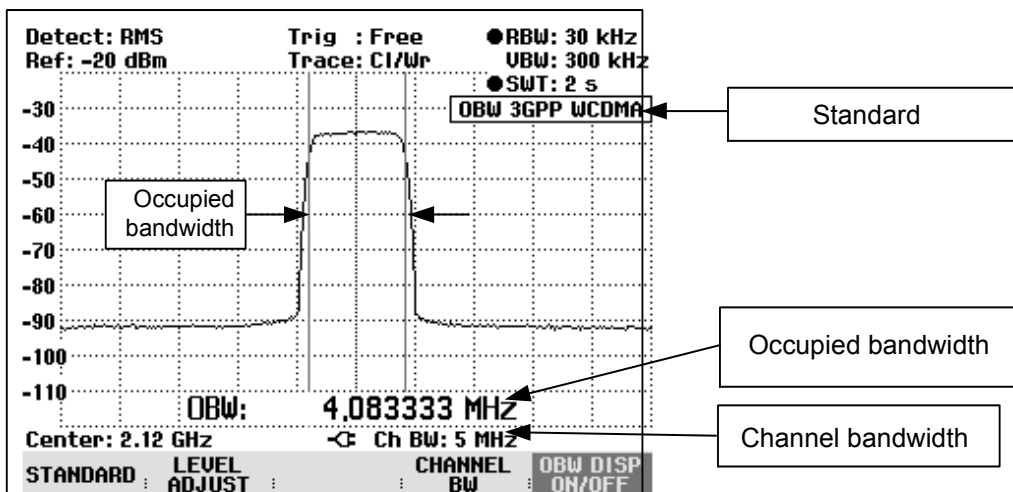

Selecting a standard

The R&S FSH offers a default for measuring the occupied bandwidth for different standards. It is also possible to define and save user-specific configurations.

- Press the STANDARD softkey.

A table with the available standards opens.

- Using the rotary knob or the cursor keys, select the appropriate standard.
- Confirm your selection with the ENTER key or the STANDARD softkey.

The selected standard is set. The optimal span, resolution bandwidth, video bandwidth, sweep time and detector for the standard are selected automatically.

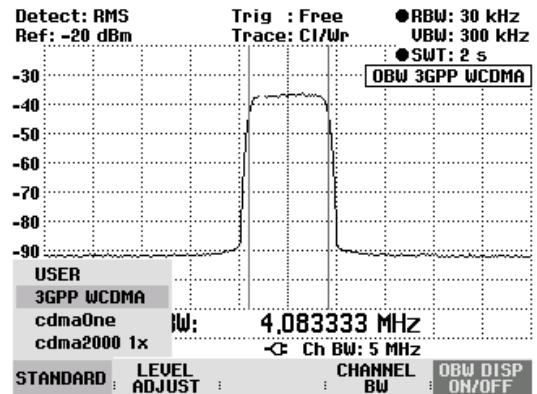

If USER is selected, the R&S FSH restores the last setting used in the USER mode for measuring the occupied bandwidth. The R&S FSH automatically makes changes to the setting so that it is again available when USER is called again.

The following should be noted when changes to the settings are made:

- The span is always coupled to the channel bandwidth (CHANNEL BW). When changes are made, the R&S FSH automatically sets the appropriate span (= 5 x channel bandwidth).
- The resolution bandwidth should be between 1% and 4% of the channel bandwidth. This ensures that the occupied bandwidth is measured with high accuracy.
- The video bandwidth must be at least three times the resolution bandwidth. This prevents incorrect results due to the compression of signal peaks by the video filter.
- The RMS detector is recommended. This ensures that the power measurement is always correct irrespective of the waveform being investigated.
- The sweep time must be set so that the result is stable. If the sweep time is increased, the R&S FSH also increases the integration time for the RMS detector and thus ensures more stable measured values.

Renaming the USER standard:

The setting for the USER standard can be assigned a user-defined name. The name entered as the USER standard also appears on the screen, thus making it possible to document the setting along with the measurement.

- Press the STANDARD softkey.

A table with the available standards opens.

- Select Rename USER with the rotary knob or the cursor keys.
- Confirm your selection with the ENTER key or the STANDARD softkey.

The R&S FSH will open the input window for the name of the USER standard.

- Using the numeric keys, enter a name.
- Press the ENTER key to complete the entry.

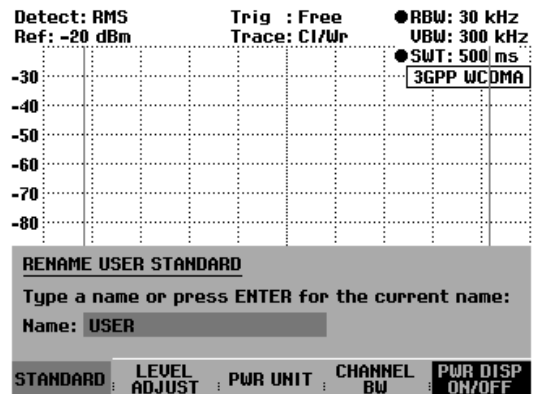

When the STANDARD menu is called, the entered name appears under USER (e.g. DAB (USER)). The name also appears at the top right-hand corner of the screen after the USER standard is selected.

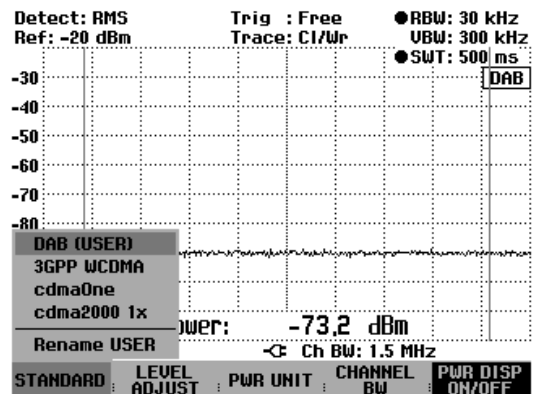

Using the R&S FSH View control software, additional standards can be generated and permanently loaded into the R&S FSH. You can also delete the factory-set standards provided in the instrument if you do not need them. The R&S FSH then offers only the standards you require.

Setting the reference level

When selecting the reference level, ensure that the R&S FSH is not overdriven. As the power is measured with a resolution bandwidth that is small in comparison with the signal bandwidth, the R&S FSH may still be overdriven even though the trace is within the measurement diagram. To prevent the R&S FSH from being overdriven, the signal can be measured at the largest resolution bandwidth possible using the peak detector. If this setting is selected, the trace may not exceed the reference level.

To simplify operation and to prevent incorrect measurements, the R&S FSH has an automatic routine for setting the reference level.

- Press the LEVEL ADJUST softkey.

The R&S FSH starts the measurement of the optimal reference level using a resolution bandwidth of 1 MHz, a video bandwidth of 1 MHz and the peak detector. While the measurement is in progress, the R&S FSH outputs the message "Adjusting level for OBW measurement, please wait...".

The optimal reference level is then set.

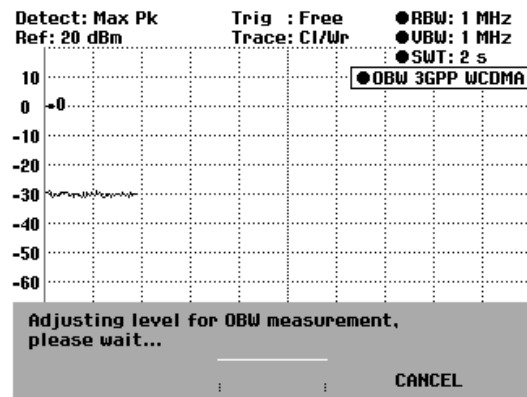

Setting the channel bandwidth

The channel bandwidth determines the span, resolution bandwidth and sweep time the R&S FSH uses for measuring the occupied bandwidth.

- Press the CHAN BW softkey.

An entry box showing the current channel bandwidth setting opens.

- Using the numeric keys, enter a new channel bandwidth and terminate the entry with the appropriate unit; or
- Change the channel bandwidth with the rotary knob or the cursor keys and terminate the entry with the ENTER key or the CHANNEL BW softkey.

The R&S FSH automatically adapts the span to the channel bandwidth that has been entered (span = 5 x channel bandwidth) to ensure that no incorrect measurements of occupied bandwidth are made. The minimum channel bandwidth that can be set is 2 kHz. If you attempt to enter a smaller channel bandwidth, the R&S FSH will automatically set 2 kHz and output the message "Limit exceeded".

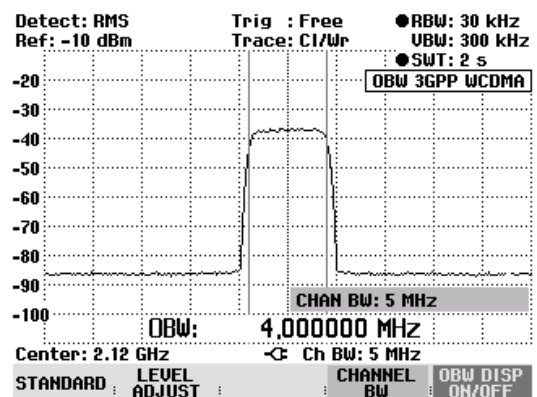

Displaying the occupied bandwidth

The R&S FSH now displays the occupied bandwidth (OBW: nnn.nn kHz) at the bottom of the measurement diagram. Usually the trace is not obscured. However, if the trace is in this area, the display of the occupied bandwidth can be turned off. Simply press the OBW DISP ON/OFF key. If the softkey is highlighted in green, display of the occupied bandwidth is on.

Changing the span

The span set by the R&S FSH normally yields optimum measurement results. In some cases, however, a larger span needs to be selected. This is the case, for example, when the area outside the span that is automatically set contains signal components that need to be included in the measurement.

Operation:

Press the SPAN key.

The AUTO SPAN softkey label is highlighted in green to indicate that the optimum span for measuring the occupied bandwidth is set. MANUAL SPAN entry is active for immediate entry of another span.

- Using the numeric keys, enter a new span and terminate the entry with the appropriate unit, or
- Change the span with the rotary knob or the cursor keys and terminate the entry with the ENTER key or the MANUAL SPAN softkey.

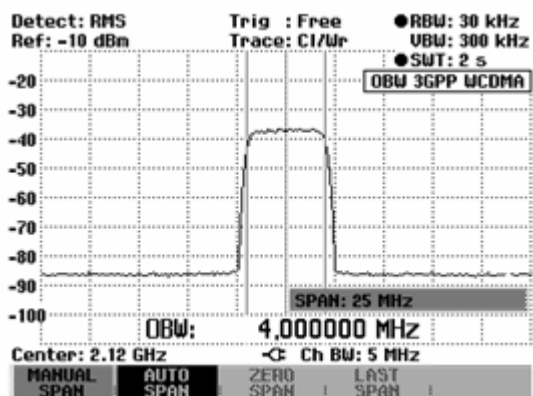

The largest permissible span for measuring the occupied bandwidth is ten times the channel bandwidth. At larger spans, the result of the channel power measurement would be increasingly imprecise, because too few points of the trace occur in the channel to be measured.

- Press the AUTO SPAN softkey to again set the optimum span.
- To return to the menu for measuring the occupied bandwidth, press the MEAS key.

Measuring the Carrier-to-Noise Ratio

(Available as of firmware version 8.0 or higher.)

The R&S FSH offers a carrier/noise measurement for measuring the ratio of carrier power to noise power. The R&S FSH performs the measurement in two steps.

First, it measures the carrier power of a transmission channel, or you determine a reference power which is then used for C/N calculation.

In the second step, the R&S FSH measures the noise power of an unoccupied transmission channel and calculates the ratio of carrier power to noise power.

Determining the carrier power (reference power or reference level)

The R&S FSH offers the carrier power measurement for three different types of carrier signals.

- **Digital Tx**

In the Digital Tx operating mode, the channel power of a reference channel with a digitally modulated signal is measured. This is common with digitally modulated carriers where power is equally distributed across the channel, i.e. where the carrier power is independent of the modulation signal.

- **Analog TV**

In the Analog TV operating mode, the peak power of the vision carrier is measured. This measurement method is common with amplitude-modulated TV signals.

- **CW Tx**

In the CW Tx operating mode, the power of an unmodulated carrier is measured.

- **Manual entry of a reference power or reference level**

The R&S FSH also allows you to manually enter the reference power or the reference level which will then be used for the carrier/noise calculation.

Noise power and carrier-to-noise power ratios C/N and C/N₀

For noise power measurements, the R&S FSH is set to an unoccupied transmission channel where it measures the noise power in accordance with the selected noise channel bandwidth.

The R&S FSH defines the carrier-to-noise ratio by determining the ratio of the previously determined reference to the measured noise power of the unoccupied transmission channel (C/N). The R&S FSH displays the ratio logarithmically.

$$C/N = \text{reference level} - \text{noise level in the channel}$$

If required, the R&S FSH determines the ratio with reference to the noise power density of the unoccupied transmission channel (C/N₀).

$$C/N_0 = C/N + 10 \lg (\text{noise channel bandwidth/Hz})$$

Operating sequence:

- Press the MEAS key.
- Press the MEASURE softkey.

The menu for measurement functions opens.

- Using the cursor keys or the rotary knob, select CARRIER / NOISE from the menu and confirm your choice with the ENTER key or the MEASURE softkey.

The R&S FSH activates the carrier/noise mode and starts the reference measurement that was selected last.

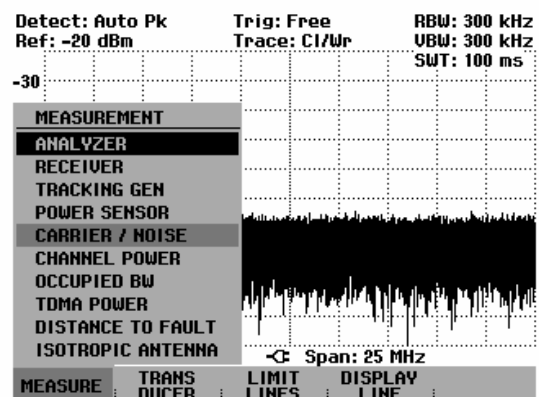

The major measurement parameter settings are available directly in the main menu of the carrier/noise measurement or can be entered using the corresponding function keys.



Determining the reference

Before the carrier-to-noise power ratio can be determined, the reference power or the reference level must be specified. To specify the reference, the R&S FSH offers four possibilities: the DIGITAL Tx, ANALOG TV, or CW Tx operating modes as well as manual reference. Enter the reference channel and the channel bandwidth of the reference channel to measure the reference. To indicate that the reference measurement has been activated, the REF MEASURE softkey is highlighted in green.

DIGITAL Tx mode

In the Digital Tx operating mode, the channel power of a reference channel is selectively measured. It is then used as a carrier power (reference) for determining the carrier-to-noise ratio.

The settings for span, resolution bandwidth, video bandwidth and sweep time are coupled to the channel bandwidth and are optimally set by the R&S FSH.

If you want to change the settings, note the following:

- The span is preset to 1.2 times the reference channel bandwidth. The span is always coupled to the channel bandwidth. When changes are made, the R&S FSH automatically sets the appropriate span.
- The resolution bandwidth should be between 1% and 4% of the channel bandwidth. This ensures that the channel power is measured with good selectivity with respect to adjacent channels.
- The video bandwidth must be at least three times the resolution bandwidth. This prevents incorrect results due to the compression of signal peaks by the video filter.
- The RMS detector is recommended. It ensures that the power is always correctly measured irrespective of the waveform to be measured.
- Set the sweep time in such a way that the result is stable. If the sweep time is extended, the R&S FSH also increases the integration time for the RMS detector, thus yielding measured values that are more stable.

➤ Press the SELECT MEASURE softkey.

The menu for selecting the reference measurement opens.

➤ Using the rotary knob or the cursor keys, select DIGITAL Tx and confirm your choice with the ENTER key or the F1 softkey.

The R&S FSH starts the DIGITAL Tx reference measurement. C/N-DTx is inserted in the top right-hand corner of the display. The reference channel and the channel bandwidth are set in accordance with the last DIGITAL Tx reference measurement.

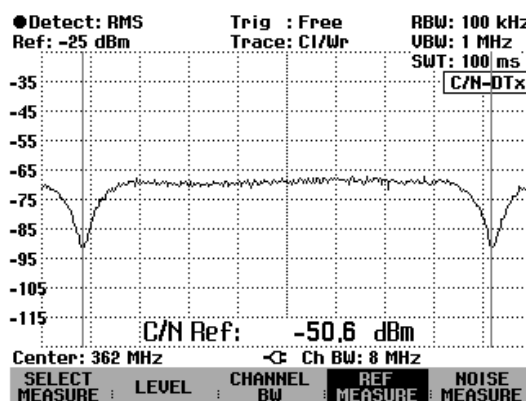

ANALOG TV mode

In the ANALOG TV operating mode, the maximum power in the reference channel is measured. It is then used as the carrier power (reference) for determining the carrier-to-noise ratio.

To measure the peak power of the vision carrier, the settings for span, resolution bandwidth, video bandwidth and sweep time are optimally preset by the R&S FSH.

If you want to change the settings, note the following:

- The span is preset to the channel bandwidth of the reference channel. The span is coupled to the channel bandwidth. When changes are made, the R&S FSH automatically sets the appropriate span.
- The resolution bandwidth should be at least 300 kHz to ensure that the peak power of the vision carrier is sampled.
- The video bandwidth must be at least as wide as the resolution bandwidth. This prevents incorrect results due to the compression of signal peaks by the video filter.
- The peak detector is recommended. It ensures that the peak power of the vision carrier is correctly measured.
- The sweep time is coupled to span, resolution bandwidth and video bandwidth. Set the sweep time in such a way that the filters can settle. Too short a sweep time distorts the measurement result.

➤ Press the SELECT MEASURE softkey.

The menu for selecting the reference measurement opens.

➤ Using the rotary knob or the cursor keys, select ANALOG TV and confirm your choice with the ENTER key or the F1 softkey.

The R&S FSH starts the ANALOG TV reference measurement. C/N-ATV is inserted in the top right-hand corner of the display. Reference channel and channel bandwidth are set in accordance with the last ANALOG TV reference measurement.

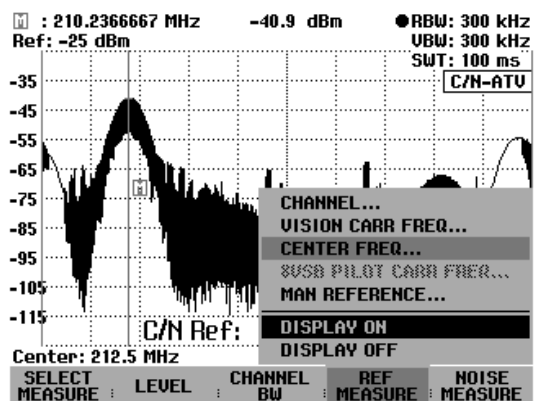

In the ANALOG TV operating mode, the count marker is automatically activated. After each sweep, the marker is set to the highest power in the reference channel. Marker power and marker frequency are indicated at the top edge of the display. The marker power corresponds to the reference.

CW Tx mode

In the CW Tx operating mode, the maximum power in the reference channel is measured, which is then used as a reference for determining the carrier-to-noise ratio.

The settings for span, resolution bandwidth, video bandwidth and sweep time are optimally set by the R&S FSH.

If you want to change the settings, note the following:

- The span is set and coupled to the channel bandwidth. When changes are made, the R&S FSH automatically sets the appropriate span.
- The resolution bandwidth is coupled to the channel bandwidth. When changes are made, the R&S FSH automatically sets the appropriate resolution bandwidth.
- The video bandwidth of the recommended peak detector must be at least as wide as the resolution bandwidth. If the RMS detector is used, the video bandwidth must be at least three times the

resolution bandwidth. This prevents incorrect results due to the compression of signal peaks by the video filter.

- The peak detector is recommended. It ensures that the peak power of the vision carrier is correctly measured.
- The sweep time is coupled to span, resolution bandwidth and video bandwidth. Set the sweep time in such a way that the filters can settle. Too short a sweep time distorts the measurement result.

➤ Press the SELECT MEASURE softkey.

The menu for selecting the reference measurement opens.

➤ Using the rotary knob or the cursor keys, select CW Tx and confirm your choice with the ENTER key or the F1 softkey.

The R&S FSH starts the CW Tx reference measurement. C/N-CW Tx appears in the top right-hand corner of the display. Reference channel and channel bandwidth are set in accordance with the last CW Tx reference measurement.

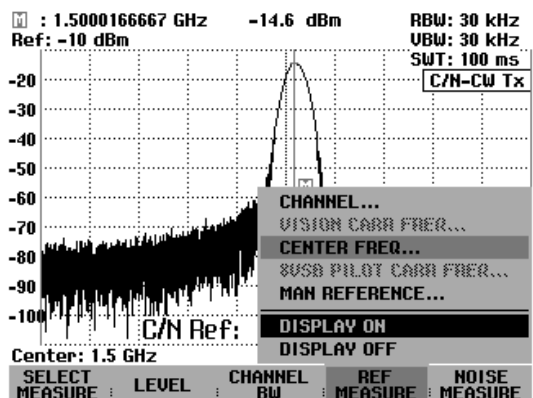

In the CW Tx operating mode, the count marker is automatically activated. After each sweep, the marker is set to the highest power in the reference channel. Marker power and marker frequency are indicated at the top edge of the display. The marker power corresponds to the reference.

Manual reference mode

As an alternative to the C/N reference measurement, the R&S FSH allows you to manually determine the C/N reference.

- Press the REF MEASURE softkey.
- Using the rotary knob or the cursor keys, select MAN REFERENCE POWER / LEVEL and confirm your choice with the ENTER key or the F4 softkey.
- Using the numeric keypad, enter the desired reference and terminate your entry with the appropriate unit key or the ENTER key.

The R&S FSH indicates the selected reference at the bottom of the display.

Setting the reference channel

The reference channel is set by entering the channel number in accordance with the selected channel/frequency table or by entering the channel center frequency. In the DIGITAL Tx operating mode, the 8VSB/ATSC pilot frequency can also be entered. In the ANALOG TV operating mode, you can additionally enter the vision carrier frequency.

- Press the REF MEASURE softkey.
- Using the rotary knob or the cursor keys, select the desired entry and confirm your choice with the ENTER key or the F4 softkey.
- Using the numeric keypad, enter the channel or frequency of the desired reference channel.
- Terminate your entry with the appropriate unit key or the ENTER key.

The R&S FSH displays the frequency spectrum of the reference channel as symmetrical to the channel center.

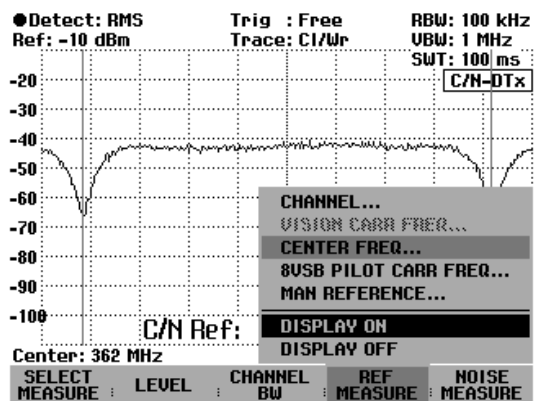

You can alternatively also enter the channel center frequency of the reference channel by pressing the FREQ function key.

Setting the reference channel bandwidth

The reference channel bandwidth is entered with the CHANNEL BW softkey. Make the entry after the reference measurement has been activated. To indicate this, the REF MEASURE softkey is highlighted in green.

Note: If the noise channel measurement has been activated, the NOISE MEASURE softkey is highlighted in green.

- If DIGITAL Tx is set, the R&S FSH measures the power in accordance with the selected channel bandwidth. Measurement is performed selectively, i.e. any existing adjacent channels do not affect the measurement.
- If the 8VSB/ATSC pilot frequency is entered, the R&S FSH calculates the channel center frequency as a function of the 8VSB/ATSC symbol rate.
Channel center frequency = 8VSB/ATSC pilot frequency + symbol rate / 4,
where the frequency of the 8VSB/ATSC symbol rate is 10.762238 MHz.
- If ANALOG TV is set, the R&S FSH measures the peak power of the vision power in the reference channel.
- If the vision carrier frequency is entered, the R&S FSH calculates the channel center frequency as a function of the channel bandwidth.
Channel center frequency = vision carrier frequency – 1.25 MHz + reference channel bandwidth / 2
- If CW Tx is set, the R&S FSH measures the peak power within the channel bandwidth.
- The R&S FSH indicates the channel limits by means of two blue vertical display lines.

Operating sequence:

- If the reference measurement is active, press the CHANNEL BW softkey.

An entry box showing the current channel bandwidth setting opens.

- Enter the reference channel bandwidth using the numeric keys and terminate your entry with the appropriate unit key, or
- Set the channel bandwidth with the rotary knob or the cursor keys.

The R&S FSH automatically adapts the span to the set channel bandwidth.

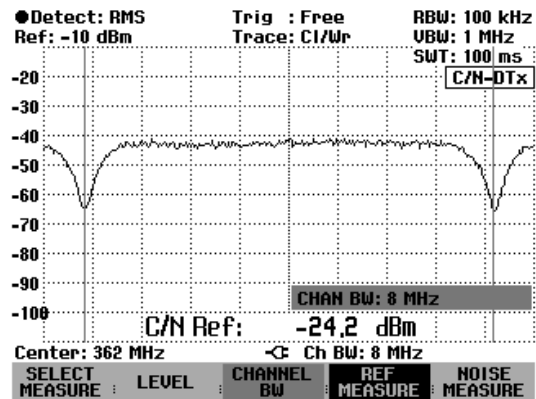

The minimum settable channel bandwidth is 8.33 kHz with the R&S FSH3 models 1145.5850.03 and 1145.5850.13.

If you attempt to enter a smaller channel bandwidth, the R&S FSH will automatically set 8.33 kHz and output the message "Limit exceeded".

With the R&S FSH3 model 1145.5850.23 and the R&S FSH6, the minimum channel bandwidth is 833 Hz.

Setting the analyzer reference level for the reference channel measurement

When selecting the reference level, make sure that the R&S FSH is not overdriven. Since the power is measured with a resolution bandwidth that is small in comparison with the signal bandwidth, the R&S FSH may be overdriven although the trace is within the measurement diagram. To prevent the R&S FSH from being overdriven, the signal can be measured at the largest possible resolution bandwidth using the peak detector. If this setting is selected, the trace must not exceed the reference level.

To simplify operation and to prevent incorrect measurements, the R&S FSH offers an automatic routine for setting the analyzer reference level.

- If the reference channel measurement is active (the REF MEASURE softkey is highlighted in green), press the LEVEL softkey.
- Confirm the LEVEL ADJUST selection with the ENTER key.

The R&S FSH starts the routine for determining the optimum reference level using a resolution bandwidth of 1 MHz, a video bandwidth of 1 MHz and the peak detector. During the measurement routine, a corresponding message is displayed. The optimum reference level is then set.

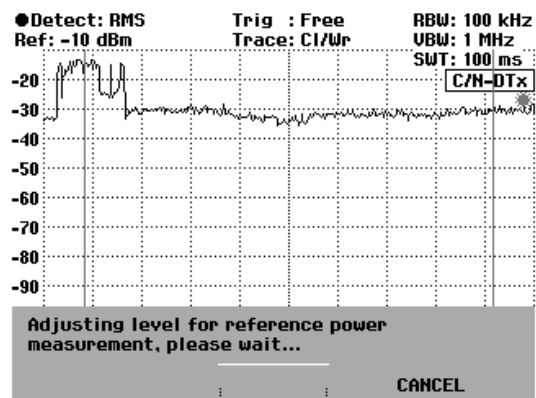

Inserting the C/N reference

If the reference measurement has been activated, the R&S FSH inserts the reference power or the reference level at the bottom of the measurement diagram. Usually this does not obscure the trace. However, if the trace is in this area of the screen, the reference display can be blanked out.

Switch off the reference display.

- Press the REF MEASURE softkey.
- Using the rotary knob or the cursor keys, select DISPLAY OFF and confirm your choice with the ENTER key or the F4 softkey.

Switch the reference display on again.

- Press the REF MEASURE softkey.

Using the rotary knob or the cursor keys, select DISPLAY ON and confirm your choice with the ENTER key or the F4 softkey.

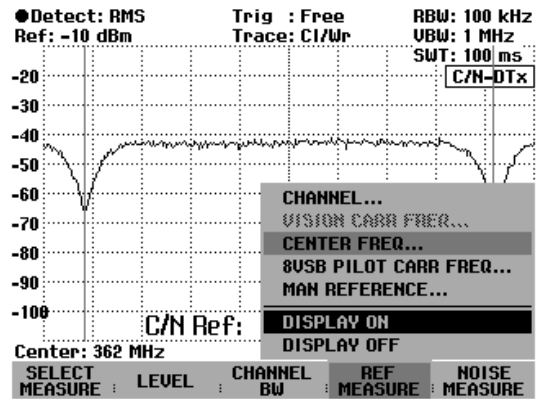

Note: Switching the measurement result on or off also affects the insertion of the measured value of the noise measurement.

Units of the C/N reference

The R&S FSH displays the C/N reference as a level in dBm, dBμV or dBmV. The C/N reference is manually entered in accordance with the selected unit.

- Press the LEVEL softkey.
- Using the rotary knob or the cursor keys, select the desired unit and confirm your choice with the ENTER key or the F2 softkey.

The C/N reference is displayed in the selected unit.

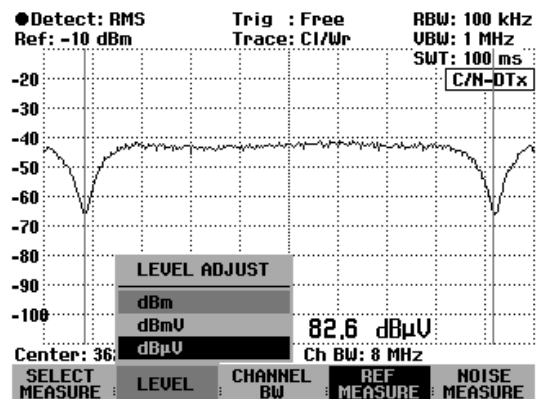

Measuring the noise channel power and calculating the carrier power/noise power

The noise channel power is measured in an unoccupied transmission channel. The R&S FSH measures the spectrum within the channel using a resolution bandwidth that is small in comparison with the channel bandwidth. The measured values on the trace are then integrated to form the total power. The R&S FSH takes into account the behavior of the selected display mode (linear or logarithmic) of the selected detector and the resolution bandwidth. The small resolution bandwidth acts like a steep channel filter, thus preventing out-of-channel emissions from affecting the result.

To determine the C/N power ratio, the measured noise channel power is set in relation to the reference.

$$\text{carrier/noise} = \text{reference/noise channel power}$$

The settings span, resolution bandwidth, video bandwidth and sweep time are coupled to the channel bandwidth and are optimally set by the R&S FSH.

If you want to change the settings, note the following:

- The span is coupled to the channel bandwidth. When changes are made, the R&S FSH automatically sets the appropriate span.
- The resolution bandwidth is coupled to the channel bandwidth. If it is set manually, it should be between 1% and 4% of the channel bandwidth. This ensures that the R&S FSH measures the channel power with good selectivity with respect to adjacent channels.
- The video bandwidth is coupled to the resolution bandwidth. If the RMS detector is used, the video bandwidth must be at least three times the resolution bandwidth. Thus, the video filter does not impair the power measurement by compressing signal peaks.
- The RMS detector is recommended. It ensures that the R&S FSH always measures the power correctly, irrespective of the measurement signal characteristics.
- Set the sweep time in such a way that the result is stable. If the sweep time is extended, the R&S FSH also increases the integration time for the RMS detector, thus yielding measured values that are more stable.

Press the NOISE MEASURE softkey to start the measurement. For calculation purposes, the R&S FSH uses the reference value that was last measured or manually set. During the noise channel measurement, it outputs the reference value at the top left edge of the display.

Setting the noise channel

The noise channel is set by entering the channel number in accordance with the selected channel/frequency table, or by entering the channel center frequency, the vision carrier frequency or the 8VSB/ATSC pilot frequency.

- Press the NOISE MEASURE softkey.

The R&S FSH starts the noise channel measurement in the noise channel last set and opens the NOISE MEASURE menu for setting a new channel.

- Using the rotary knob or the cursor keys, select the desired noise channel entry and confirm your choice with the ENTER key or the NOISE MEASURE softkey.

The appropriate entry field opens.

- Using the numeric keys, enter the channel or the frequency of the desired transmission channel and terminate your entry with the appropriate unit key or the ENTER key.

The R&S FSH displays the frequency spectrum of the noise channel as symmetrical to the channel center.

You can alternatively enter the channel center frequency using the FREQ key.

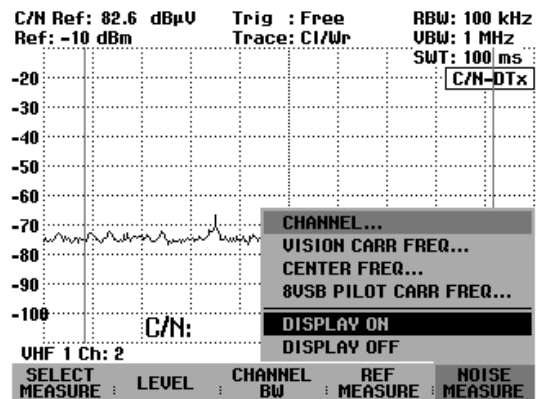

Setting the noise channel bandwidth

Enter the noise channel bandwidth with the CHANNEL BW softkey. Make the entry after the noise channel measurement has been activated. This is the case when the NOISE MEASURE softkey is highlighted in green.

Note: During the reference channel measurement, the REF MEASURE softkey is highlighted in green.

The R&S FSH indicates the channel limits by means of two vertical display lines.

- If the noise channel measurement is active, press the CHANNEL BW softkey.

The R&S FSH opens the entry box for the channel bandwidth (CHAN BW) with the noise channel bandwidth just selected.

- Using the numeric keys, enter the noise channel bandwidth and terminate your entry with the appropriate unit key, or
- Set the noise channel bandwidth with the rotary knob or the cursor keys.

The R&S FSH automatically adapts the span to the set channel bandwidth.

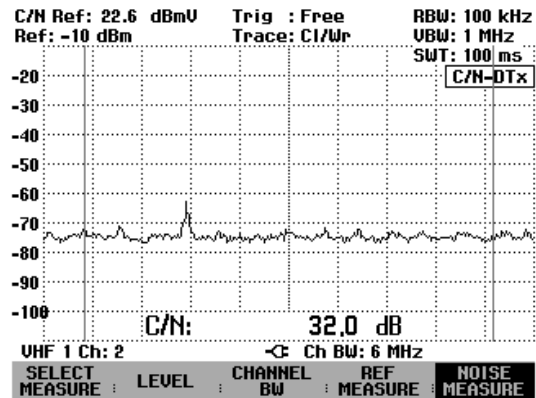

The minimum settable channel bandwidth is 8.33 kHz with the R&S FSH3 models 1145.5850.03 and 1145.5850.13.

If you attempt to enter a smaller channel bandwidth, the R&S FSH will automatically set 8.33 kHz and output the message "Limit exceeded".

With the R&S FSH3 model 1145.5850.23, the R&S FSH6 and the R&S FSH3-TV, the minimum channel bandwidth is 833 Hz.

Setting the R&S FSH reference level during noise channel measurement

When selecting the reference level, make sure that the R&S FSH is optimally set with regard to the input signal. It must be set to be as sensitive as possible (corresponds to a low reference level) without being overdriven to ensure optimum C/N measurement results. This is the case when the measured noise power is at its lowest or the C/N ratio at its highest.

To simplify operation and to prevent incorrect measurements, the R&S FSH has an automatic routine for setting the reference level.

- If the noise channel measurement is active (the NOISE MEASURE softkey is highlighted in green), press the LEVEL softkey.
- Confirm the LEVEL ADJUST selection with the ENTER key.

The R&S FSH starts the routine for determining the optimum reference level. During the measurement routine, a corresponding message is displayed. The optimum reference level is then set.

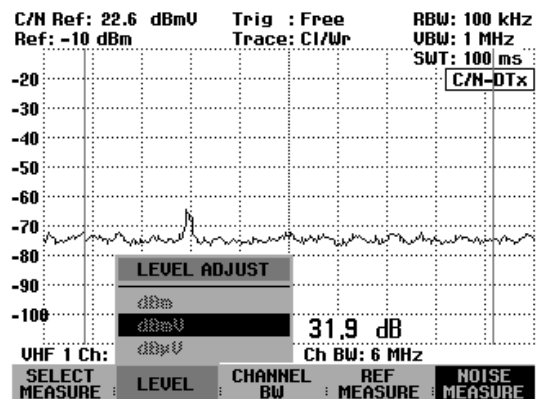

Selecting the C/N result display

The R&S FSH either displays the carrier/noise power ratio referenced to the total noise channel power C/N or referenced to the noise power density C/No. It calculates the noise power density from the set noise channel bandwidth.

$$C/No = C/N + 10 \lg (\text{noise channel bandwidth})$$

- Press the SELECT MEASURE softkey.
- Using the rotary knob or the cursor keys, select the desired result display and confirm your choice with the ENTER key or the SELECT MEASURE softkey.

If the noise channel measurement is active, the R&S FSH displays the measured C/N or C/No value.

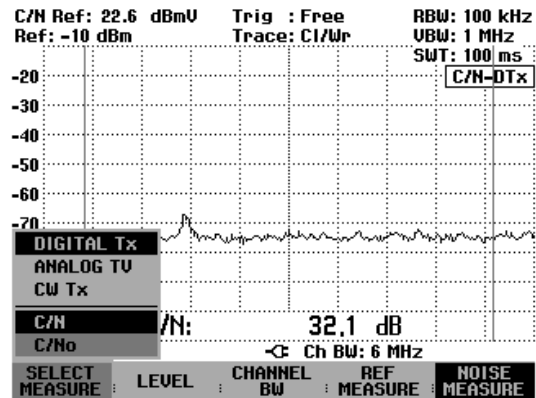

C/N measurement result display

If the noise channel measurement is active, the R&S FSH inserts the C/N measurement result at the bottom of the measurement diagram. Usually this does not obscure the trace. However, if the trace is in this area of the screen, the display can be blanked out.

Switch off the C/N measurement result.

- Press the NOISE MEASURE softkey.
- Using the rotary knob or the cursor keys, select DISPLAY OFF and confirm your choice with the ENTER key or the F5 softkey.

Switch the C/N measurement result on again.

- Press the NOISE MEASURE softkey.

Using the rotary knob or the cursor keys, select DISPLAY ON and confirm your choice with the ENTER key or the F5 softkey.

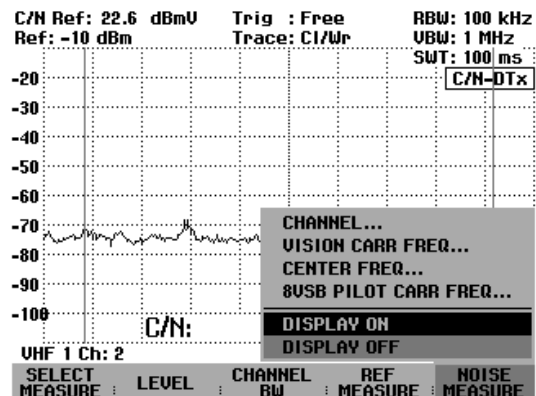

Note: Switching the C/N measurement result on or off also affects the insertion of the measured value of the reference measurement.

Changing the span

The span set by the R&S FSH yields extremely precise measurement results. However, signals in the environment of the measurement channel can now no longer be detected. To give you an overview of the spectrum outside the measurement channel, the span can be changed up to a factor of ten times the channel bandwidth during the channel power measurement.

- Press the SPAN key.

The AUTO SPAN softkey is highlighted in green to indicate that the optimum span for the channel power measurement is set. MANUAL SPAN is activated to allow immediate entry of another span.

- Using the numeric keys, enter a new span and terminate the entry with the appropriate unit, or
- Change the span with the rotary knob or the cursor keys and terminate the entry with the ENTER key or the MANUAL SPAN softkey.

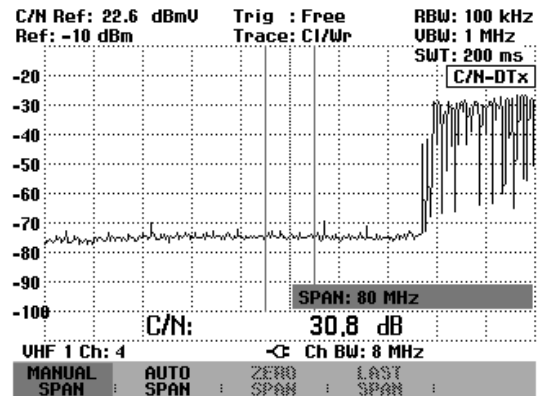

The largest permissible span for the channel power measurement is ten times the channel bandwidth. With larger spans, the result of the channel power measurement would be increasingly imprecise, because too few points of the trace occur in the channel to be measured.

- Press the AUTO SPAN softkey to reset the optimum span.
- To return to the menu for carrier/noise measurement, press the MEAS key.

Using the R&S FSH in receiver mode

(only available if option R&S FSH-K3 is installed)

The receiver mode (option R&S FSH-K3) is used for measuring levels on individual frequencies. In this mode, the R&S FSH functions as a receiver and measures the level on a prescribed frequency.

In addition, it is possible to perform measurements on several frequencies with a graphical display of the levels. Unlike the analyzer mode, in which the R&S FSH sweeps quasi-continuously over the specified frequency range, in the receiver mode the instrument measures on specified discrete frequencies using the selected measurement time per frequency.

Activating the receiver mode:

- Press the MEAS key.
- Press the MEASURE softkey.

The measurement function menu will open.

- Use the rotary knob or the cursor keys to select RECEIVER from the menu and confirm with the ENTER key or the MEASURE softkey.

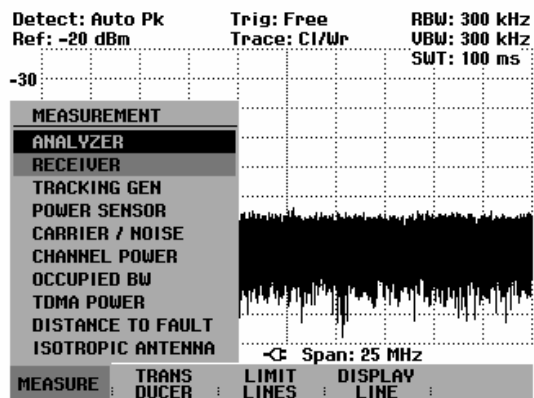

The R&S FSH activates the receiver mode and measures the level on the set frequency.

Screen layout:

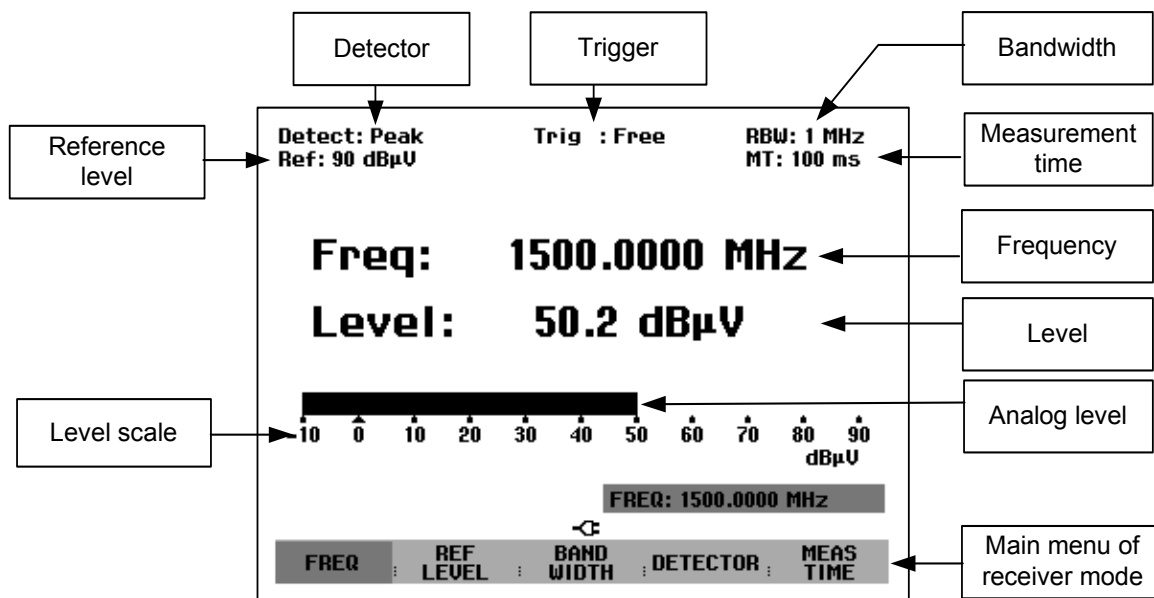

The R&S FSH provides the most important setting parameters such as frequency, reference level, measurement bandwidth, detector and measurement time in the main menu of the receiver mode. However, the settings can also be made using the corresponding keys.

Setting the frequency

The frequency is set either in the main menu of the receiver mode or by using the **FREQ** key.

Frequency entry is active immediately after the receiver mode has been called. The receiving frequency can be changed with the rotary knob, the cursor keys or by entering a numeric value.

If the R&S FSH is not in the main menu, the receiving frequency can be changed as follows:

- Press the **MEAS** key.

Frequency entry is activated. The frequency entry box is displayed, and the frequency can be changed directly.

Alternatively the frequency can be entered via the **FREQ** key.

- Press the **FREQ** key.

The R&S FSH switches to the frequency menu and activates frequency entry.

- Change the receiving frequency with the rotary knob or the cursor keys, or enter a new receiving frequency via the numeric keypad.

The frequency is displayed immediately after the entry.

Setting the frequency step size:

The step size for tuning the frequency with the rotary knob can be specified. The default tuning step size is 100 Hz, matching the minimum frequency resolution in the receiver mode. The tuning step size with the cursor keys is always 100 kHz.

- Press the **FREQ** key.
- Press the **FREQ STEPSIZE** softkey.
- Select the desired step size (100 Hz, 1 kHz, 10 kHz, 100 kHz or 1 MHz) in the menu for the step size.
- Confirm your selection with the **ENTER** key or by pressing the **FREQ STEPSIZE** softkey again.
- For step sizes other than those offered, select **MANUAL...** from the menu and confirm with the **ENTER** key or the **FREQ STEPSIZE** softkey.
- Enter the desired step size in the entry box using the numeric keypad and terminate the entry with the required unit key. Alternatively the step size can be changed with the rotary knob or the cursor keys.

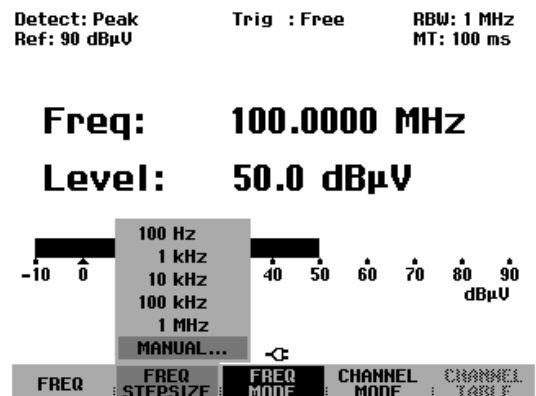

Frequency tuning in channel spacings:

For measurement in channel spacings, it is possible to enter a frequency channel instead of the frequency. A simple channel table can be defined directly from the R&S FSH's front panel. Complicated channel tables, e.g. ones with gaps in the channel numbers or the frequency, must be defined using the R&S FSH View software and loaded into the R&S FSH's memory.

- Press the **FREQ** key.
- Press the **CHANNEL MODE** softkey.

The R&S FSH now displays, instead of the frequency, a channel according to the channel table that was just switched on.

A channel table is selected as follows:

- Press the **CHANNEL TABLE** softkey.

The R&S FSH switches to the submenu for selecting the channel configuration. All channel tables available in the instrument that were loaded with the R&S FSH View software are displayed. If no channel table is loaded, "No bands available" is displayed.

- Select the desired channel table using the rotary knob or the cursor keys.
- Confirm your selection with the **SELECT** softkey.

| 30/03/2004 | BAND TABLE LIST | 22:10:16 |
|-----------------|---------------------|----------|
| TU France | 01/03/2004 15:59:02 | |
| TU Japan | 01/03/2004 14:58:52 | |
| TU DK_OIRT | 01/03/2004 14:40:20 | |
| TU Australia | 01/03/2004 14:40:08 | |
| TU Europe | 01/03/2004 14:39:56 | |
| TU China | 01/03/2004 14:34:40 | |
| TU Italy | 01/03/2004 14:30:40 | |
| TU Ireland | 01/03/2004 14:30:26 | |
| TU French Overs | 01/03/2004 14:30:16 | |
| PCS UL | 01/01/1995 02:00:00 | |
| PCS DL | 01/01/1995 02:00:00 | |
| GSM UL | 01/01/1995 02:00:00 | |
| GSM DL | 01/01/1995 02:00:00 | |

| | | | | |
|--------|-----------------|------|----------------|----------------|
| SELECT | SELECT USER TAB | EXIT | DEFIN USER TAB | LIST-> PRINTER |
|--------|-----------------|------|----------------|----------------|

The R&S FSH switches to the frequency entry menu. The frequency is displayed as channels, and the **FREQ** softkey is replaced by **CHANNEL**. All frequencies are now entered as channel numbers. The R&S FSH only accepts entries that are defined in the channel list. Other frequencies can no longer be entered.

The frequency associated with the set channel is additionally displayed above the displayed channel.

- Set a new channel using the rotary knob or the cursor keys or enter a new channel via the numeric keypad.

If you try to enter a channel outside of the defined range, the R&S FSH displays "Range exceeded".

If no channel table is stored in the instrument or a different one is necessary, a user table can also be defined.

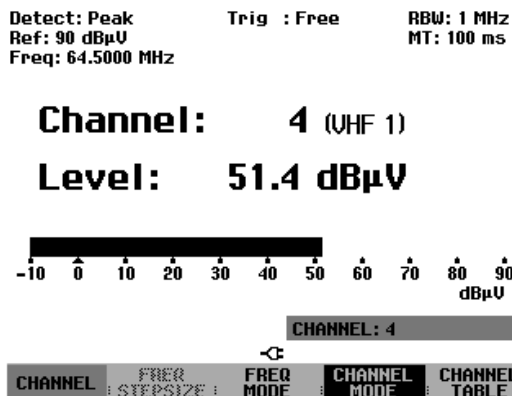

To define a user table, proceed as follows:

- Press the **FREQ** key.
- Press the **CHANNEL TABLE** softkey.
- Press the **SELECT USER TAB** softkey.
- Press the **DEFINE USER TAB** softkey.

The R&S FSH opens the submenu for entering the different parameters of the channel table.

A channel table is defined by the number used for the first channel and the associated frequency, and by the number of channels and their frequency spacing.

| 30/03/2004 | BAND TABLE LIST | 22:15:14 |
|-----------------|---------------------|---------------------|
| TU France | 01/03/2004 15:59:02 | |
| TU Japan | 01/03/2004 14:58:52 | |
| TU DK_OIRT | 01/03/2004 14:40:20 | |
| TU Australia | 01/03/2004 14:40:08 | |
| TU Europe | 01/03/2004 14:39:56 | |
| TU China | 01/03/2004 14:34:40 | |
| TU Italy | 01/03/2004 14:30:40 | |
| TU Ireland | 01/03/2004 14:30:26 | |
| TU French Overs | 01/03/2004 14:30:16 | |
| PCS UL | 01/01/1995 02:00:00 | |
| PCS DL | 01/01/1995 02:00:00 | |
| GSM UL | | 1ST CHANNEL NO... |
| GSM DL | | 1ST CHANNEL FREQ... |
| | | NO OF CHANNELS... |
| | | CHANNEL SPACING... |
| SELECT | SELECT USER TAB | EXIT |
| | | DEFINE USER TAB |
| | | LIST-> PRINTER |

- Select 1ST CHANNEL NO... by pressing the **ENTER** key.
- Enter the number of the first channel and confirm the entry with the **ENTER** key.
- Press the **DEFINE USER TAB** softkey.
- Select 1ST CHANNEL FREQ... from the menu and confirm with the **ENTER** key.
- Enter the frequency of the first channel and terminate the entry with the frequency unit.
- Press the **DEFINE USER TAB** softkey.
- Select **NO OF CHANNELS...** from the menu and confirm with the **ENTER** key.
- Enter the number of channels and confirm the entry with the **ENTER** key.
- Press the **DEFINE USER TAB** softkey.
- Select **CHANNEL SPACING...** from the menu and confirm with the **ENTER** key.
- Enter the channel spacing and terminate the entry with the required unit key.

Setting the reference level

The reference level is set either in the receiver main menu or by using the **AMPT** key. This level is the maximum level of the analog bar graph display.

Set the reference level such that the analog bar graph display is within its scale. However, make sure the reference level is so low that the measurement signal does not disappear in the inherent noise. This can be checked, for example, by removing the input signal.

Setting the reference level in the main menu of the receiver mode:

- Press the **MEAS** key.
- Press the **REF LEVEL** softkey.
- Change the reference level setting with the cursor keys or the rotary knob, or enter a new reference level via the numeric keypad.
- Confirm the entry of the reference level by pressing the **ENTER** key.

Setting the reference level in the amplitude menu:

- Press the AMPT key.
- Press the REF LEVEL softkey.
- Change the reference level setting with the cursor keys or the rotary knob, or enter a new reference level via the numeric keypad.
- Confirm the entry of the reference level by pressing the ENTER key.

Setting the bandwidth

The same bandwidths available in the analyzer mode are also available in the receiver mode. In addition, the R&S FSH provides the bandwidths 200 Hz, 9 kHz, 120 kHz and 1 MHz for measuring electromagnetic interference according to CISPR16. In contrast to the analyzer bandwidths, which are defined as 3 dB bandwidths, the CISPR bandwidths are 6 dB bandwidths.

- Press the BW key.

The R&S FSH immediately activates entry of the resolution bandwidth (the MANUAL RES BW softkey is highlighted in red).

- Change the current bandwidth with the cursor keys or the rotary knob, or enter a new bandwidth via the numeric keypad and terminate the entry with the required unit key.

Note: The 200 kHz bandwidth must always be entered via the numeric keypad.

CISPR16 bandwidths must be set as follows:

- Press the MANUAL CISPR BW softkey in the BW menu.
- Select one of the CISPR bandwidths using the cursor keys or the rotary knob.
- Confirm with the ENTER key.

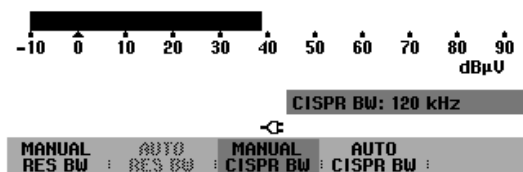

The bandwidths 200 Hz, 9 kHz, 120 kHz and 1 MHz are available.

The CISPR bandwidths are predefined for specific frequency ranges as follows according to CISPR16:

| Frequency range | Bandwidth |
|--------------------|-----------|
| <150 kHz | 200 Hz |
| 150 kHz to 30 MHz | 9 kHz |
| 30 MHz to 1000 MHz | 120 kHz |
| >1000 MHz | 1 MHz |

For this purpose, the R&S FSH automatically sets the predefined bandwidth as a function of the selected frequency.

- Press the BW key.
- Press the AUTO CISPR BW softkey.

Setting the detector

The following detectors are available in the receiver mode:

| | |
|------------|---|
| Peak | The peak detector displays the highest level during the set measurement time. |
| Average | The average detector displays the linear average of the measurement signal within the selected measurement time. |
| RMS | The RMS detector takes the rms value of the measurement signal during the set measurement time. |
| Quasi-peak | The quasi-peak detector evaluates the measurement signal according to the evaluation curves defined in the CISPR16 standard. The R&S FSH uses three different evaluation curves that are coupled to the set bandwidth. For frequencies below 150 kHz (CISPR band A), the R&S FSH sets the 200 Hz bandwidth. The evaluation for band B (to be used from 150 kHz to 30 MHz) is coupled to the 9 kHz bandwidth. The quasi-peak evaluation for the C/D band (30 MHz to 1000 MHz) is coupled to the 120 kHz bandwidth. |

The detector is selected either in the main menu of the receiver mode or by using the TRACE key.

- Press the DETECTOR softkey in the main menu of the receiver mode

or

- Press the TRACE key and then the DETECTOR softkey.

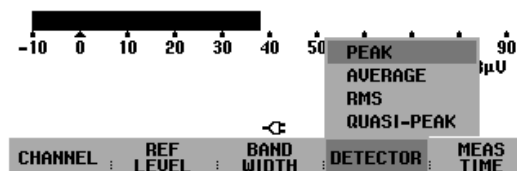

The menu for selecting the detector opens.

- Using the rotary knob or the cursor keys, select the desired detector.
- Confirm your selection with the ENTER key or by pressing the DETECTOR softkey again.

Setting the measurement time

The measurement time is the time during which the R&S FSH observes the signal and combines it with the result displayed at the end of the measurement time as a function of the set detector. The R&S FSH accepts measurement times between 1 ms and 100 s.

- Press the MEAS TIME softkey in the receiver main menu or in the trace menu.
- Change the measurement time in the entry box with the rotary knob or the cursor keys, or enter a new value via the numeric keypad.
- Confirm the entry with the ENTER key.

Measurement on multiple frequencies or channels (scan)

In a scan, the R&S FSH sequentially measures the levels in predefined channels and graphically displays the measurement results. The length of time the scan dwells on a frequency is determined by the measurement time. The measurement channels are specified by the selected channel table.

- Press the SPAN key.
- Press the **FREQ SCAN** softkey.

The **FREQ SCAN** softkey is highlighted in green to indicate that the R&S FSH is in the scan mode.

- Confirm the entry with the ENTER key.
- Press the **SCAN START** softkey.
- Enter the start frequency of the scan via the numeric keypad, or change the start frequency using the rotary knob or the cursor keys.
- Press the **STOP SCAN** softkey.
- Enter the stop frequency of the scan via the numeric keypad, or change the start frequency using the rotary knob or the cursor keys.
- Press the **SCAN STEP** softkey.
- Enter the step size of the scan via the numeric keypad, or change the start frequency using the rotary knob or the cursor keys.

The R&S now measures on the frequencies defined by the scan parameters. The levels are displayed by vertical lines on each of the frequencies. The height of each line indicates the level.

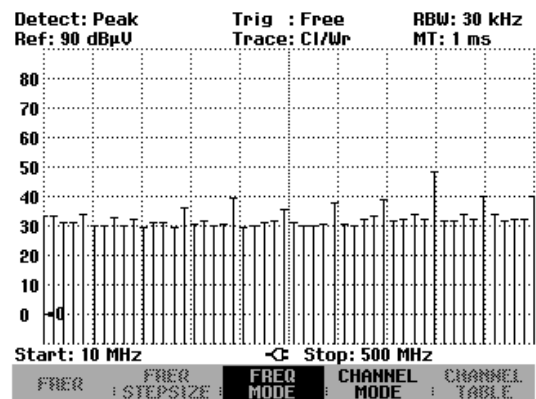

Pressing the **FIXED FREQ** softkey switches the R&S FSH back to the default setting of the receiver mode.

A scan is also possible via the channel table. If frequency entry is set to Channel, the R&S FSH uses the associated channel table.

- Press the **FREQ** key.
- Press the **CHANNEL MODE** softkey.
- Press the **SPAN** key.
- Press the **CHANNEL SCAN** key.

The R&S FSH now scans across the channels of the active channel table.

The frequency range for the scan is set using the **START SCAN** and **STOP SCAN** softkeys.

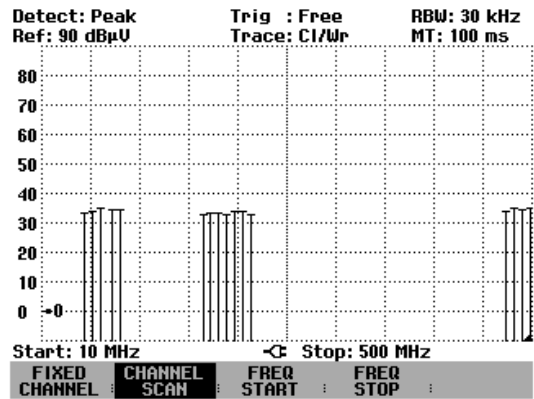

The channel table used can be displayed with the **FREQ** key and the **CHANNEL TABLE** softkey. It is highlighted in red in the table of channel tables.

The screenshot above shows a measurement using a channel table with frequency gaps. Different segments that are not interconnected are specified using the table defined with R&S FSH View.

In the default setting, the levels in each of the channels are displayed as vertical lines. Alternatively the R&S FSH provides a polygon display, in which the level values of the individual channels are interconnected by straight lines.

- Press the **TRACE** key.
- Press the **TRACE STYLE** softkey.
- Select **POLYGON** with the rotary knob or the cursor keys.

The R&S FSH switches to the polygon display.

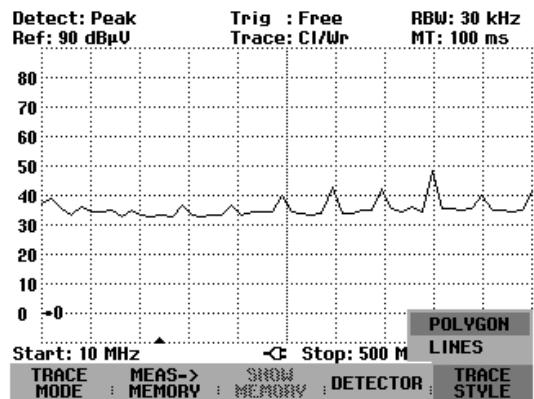

Measurements using the power sensor

For even more accurate power measurements, the R&S FSH can be used with the Power Sensors R&S FSH-Z1 and R&S FSH-Z18. Their frequency ranges are 10 MHz to 8 GHz and 10 MHz to 18 GHz, respectively. This means that both sine signals and modulated signals can be measured precisely over a large dynamic range.

Connecting the power sensor

The Power Sensors R&S FSH-Z1 and -Z18 are controlled and powered via a special interface. Connect the power sensor cable to the R&S FSH's power sensor connector and screw into position. The DUT is connected to the N-connector on the power sensor.

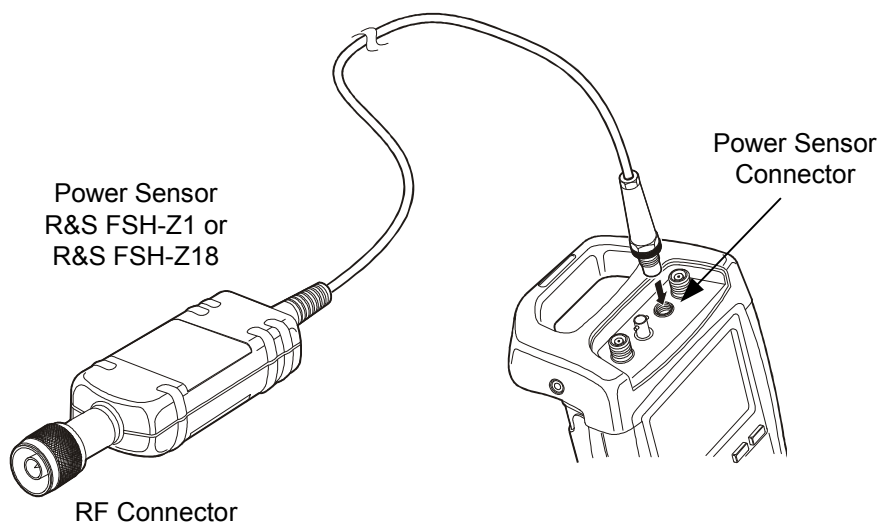

The continuous power applied to the power sensor's input must not exceed 400 mW (26 dBm). Short ($\leq 10 \mu\text{s}$) power peaks up to 1 W (30 dBm) are however permissible. Higher input powers may destroy the sensor. An attenuator pad must be used to ensure that the maximum permissible power for the sensor is never exceeded when measurements are made on high-power transmitters.

Measurement:

The POWER SENSOR function turns the R&S FSH into a wideband power meter. Then, it always measures the power of the whole signal from 10 MHz to 8 GHz or from 10 MHz to 18 GHz, in most cases the signal shape having no effect on the measurement.

Operating sequence:

- Press the MEAS key.
- Press the MEASURE softkey.

The measurement function submenu opens.

- Using the cursor keys or the rotary knob, select the POWER SENSOR menu item and confirm your selection with the ENTER key or the MEASURE softkey.

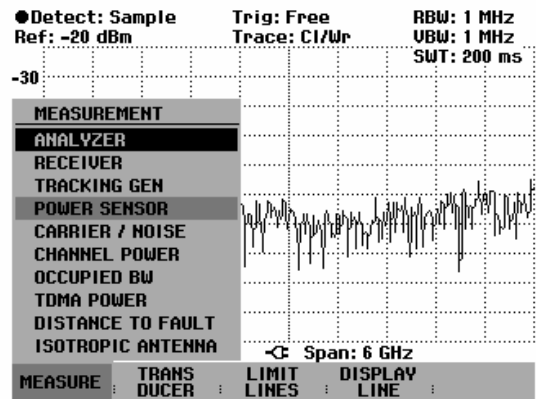

The R&S FSH opens the screen for power measurements. If no power sensor is connected, no measured value is displayed. If a power sensor is connected, the R&S FSH sets up a connection via its interface and after a few seconds displays the measured power.

In the event of incorrect operation or sensor malfunction, the R&S FSH outputs the following error messages:

| Message | Cause | Remedy |
|--------------------------------------|---|--|
| Error in zeroing: signal at sensor | A signal was present at the power sensor when zeroing was performed. | Unscrew the power sensor from the device under test and repeat zeroing. |
| Warning: Input overloaded | The power at the input of the power sensor exceeds the permitted power (23 dBm = 200 mW). | Reduce the power at the sensor input. |
| Power sensor hardware error | Communication error between the R&S FSH and the power sensor. | Unscrew the sensor from the R&S FSH and check the connectors. If the problem persists, contact a Rohde & Schwarz service center. |
| Power sensor error | The power sensor signals an error to the R&S FSH. | Contact a Rohde & Schwarz service center. |
| Unknown power sensor model connected | The R&S FSH cannot identify the device connected to its POWER SENSOR connector. | |

Screen layout for power-sensor measurements:

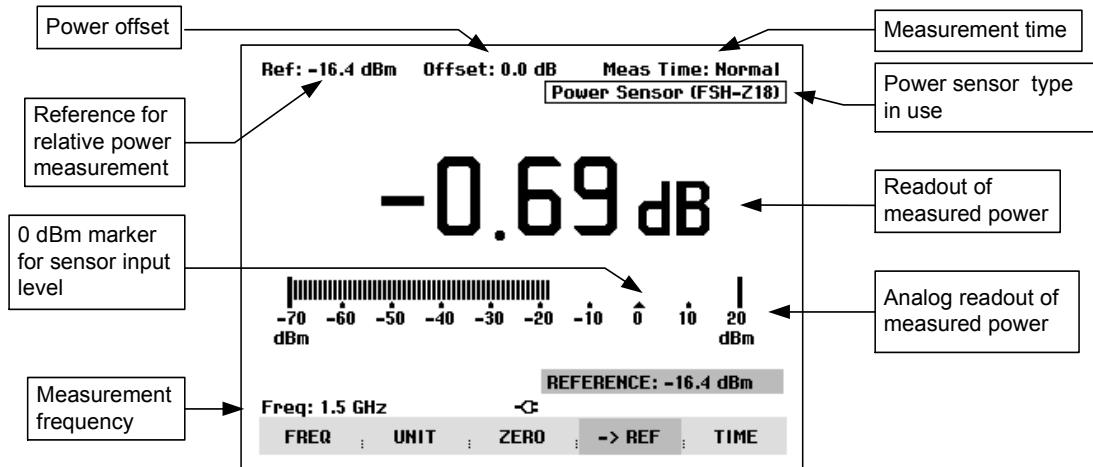

The power sensor has a memory containing frequency-dependent correction values. This means that the highest accuracy is reached for signals whose frequency is known. If the R&S FSH switches over to the power measurement mode from another operating mode, it uses the center frequency as the frequency for the power sensor.

If you want to perform measurements on another known signal, the power sensor can be “told” what the center frequency is via the frequency entry mode (FREQ softkey).

- Press the FREQ softkey.

The frequency value entry box opens.

- Using the number keys, enter the frequency you want and confirm the entry with the ENTER key or by pressing the FREQ softkey again.

The R&S FSH transfers the new frequency to the power sensor which then corrects the measured power readings.

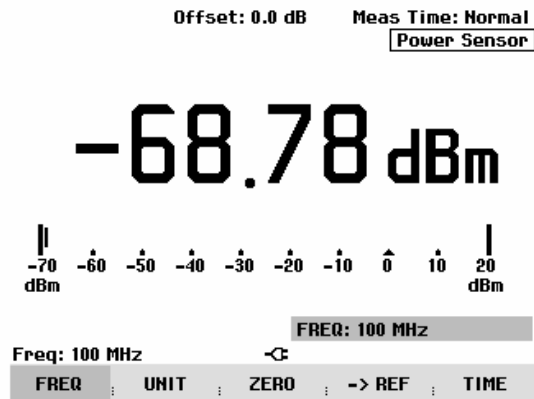

Zeroing the power sensor

Offset voltages and currents have most effect on the power readout when low powers are being measured. Zeroing is used to compensate for these offsets. The power sensor zeroes itself automatically when instructed to do so by the user. No power may be applied when zeroing is being performed, as the power sensor cannot distinguish between external powers and internal offsets.

- Press the ZERO softkey.

The R&S FSH outputs a message to tell the user not to apply any signals to the power sensor when zeroing is being performed.

- Disconnect the power sensor from any signal sources.
- Start zeroing with the first or second softkey (CONTINUE).

Softkeys 4 or 5 (CANCEL) can be used to abort zeroing, if, for example, a signal source cannot be disconnected.

The R&S FSH immediately starts power sensor zeroing. While zeroing is in progress, the R&S FSH outputs the message "Zeroing power sensor, please wait..".

When zeroing is over, the R&S FSH outputs the message "Power sensor zero OK" and switches back to the softkey menu for the power sensor.

Offset: 0.0 dB Meas Time: Normal
Power Sensor

-79.15 dBm

ZEROING POWER SENSOR
Before zeroing the power sensor, please remove all signals from the sensor input.
Press CONTINUE to start zeroing...

CONTINUE : : CANCEL

Zeroing power sensor, please wait...

: : CANCEL

Power Sensor Zero OK

Freq: 100 MHz ←

FREQ : UNIT : ZERO : -> REF : TIME

Selecting the unit for the power readout

The R&S FSH can display measured power in relative units (dBm) or in absolute units in Watts (W, mW, μW, nW and pW). A reference level in dB is also provided by the R&S FSH.

- Press the UNIT softkey.

The units submenu then opens.

- Using the rotary knob or the cursor keys select the appropriate unit.
- Confirm with the ENTER key or the UNIT softkey.

Offset: 0.0 dB Meas Time: Normal
Power Sensor

28.14 pW

-70 -60 -50 -40 -30 -20 -10 0 10 20
dBm

dBm
W
dB REL...

Freq: 100 MHz ←

FREQ : UNIT : ZERO : -> REF : TIME

If the unit dB REL... has been selected, the reference level value entry box opens.

- Enter the reference level (REFERENCE) with the number keys and terminate entry with the appropriate unit or change the reference level using the rotary knob or cursor keys.

REFERENCE: -56.2 dBm

Freq: 100 MHz ←

FREQ : UNIT : ZERO : -> REF : TIME

The current level reading can be made the reference level by just pressing the ->REF softkey.

- Press the ->REF softkey.

The R&S FSH sets the current measured level as the reference level and from then on displays the measured level relative to the reference level in dB. The unit (UNIT) is automatically set to dB REL...

The reference level is shown in the top left-hand corner of the screen (in this case Ref: -10.4 dBm).

In the REFERENCE value entry box, the reference level can be adjusted with the rotary knob or the cursor keys or corrected by making a numeric entry.

- Confirm the reference level with the ENTER key or by pressing the ->REF softkey.

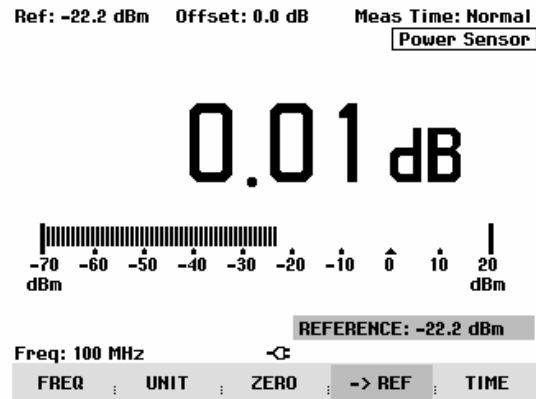

Setting the averaging time

The averaging time determines how long the signal will be measured for. The longer the averaging time, the more stable the display – particularly if signals are at the lower end of the measurement range or are noisy. The R&S FSH has three times for power measurements: fast, normal and slow.

Stationary sine signals with a high level (> -40 dBm) require only a short measurement time to produce a stable, accurate result. In this case, the FAST operating mode is recommended to obtain a high repetition rate for the measurement. When the NORMAL setting is selected, the stability of the display is increased for signals with low levels or for modulated signals. The LONG mode is recommended for signals at the lower end of the measurement range (<-50 dBm to <-60 dBm). The R&S FSH-Z1 averages out the noise most effectively and the effect of noise on the measurement is minimal.

- Press the TIME softkey.
- Using the rotary knob or the cursor keys select the measurement time you want from the menu (i.e. SHORT, NORMAL or LONG).
- Confirm your selection with the ENTER key or by pressing the TIME softkey again.

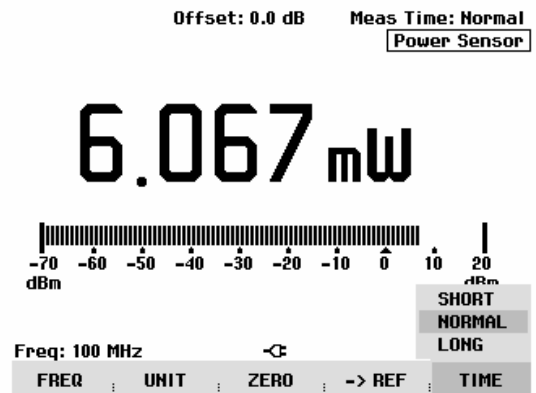

Taking additional loss or gain into account

At high powers which cause the R&S FSH-Z1's maximum input level to be exceeded or at very low levels which are below the instrument's minimum sensitivity, the R&S FSH can take additional loss or gain introduced between the DUT and the power sensor into account. These are defined in terms of an offset in dB relative to the measured level. A positive offset corresponds to a loss and a negative offset to a gain.

- Press the AMPT key.
- Press the REF OFFSET softkey.

The value entry box for the reference offset opens.

- Using the rotary knob, the cursor keys or the number keys enter the offset you want and confirm the entry with the ENTER key.

The offset is displayed centrally at the top of the screen and is taken into account in the power or level display.

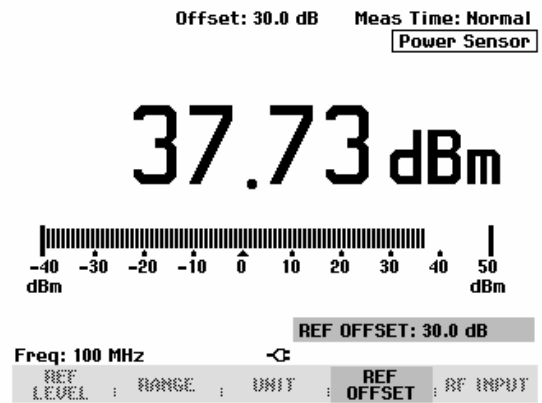

Measuring forward and reflected power

The Directional Power Sensors R&S FSH-Z14 and R&S FSH-Z44 are connected between the source and the load and measure the power flow in both directions, i.e. from the source to the load (forward power) and from the load to the source (reflected power). The ratio of forward to reflected power indicates how well a load is matched to the source. This ratio is referred to as return loss or voltage standing wave ratio (VSWR).

The Directional Power Sensors R&S FSH-Z14 and R&S FSH-Z44 are of non-symmetrical design, i.e. they must be connected such that the forward arrow (1 → 2) on the sensor points to the load (corresponding to the direction of forward power).

The directional power sensors are controlled and powered via a special serial interface. The sensor cable is to be connected and screwed to the POWER SENSOR connector on the R&S FSH. The sensor is to be connected between the source and the load.

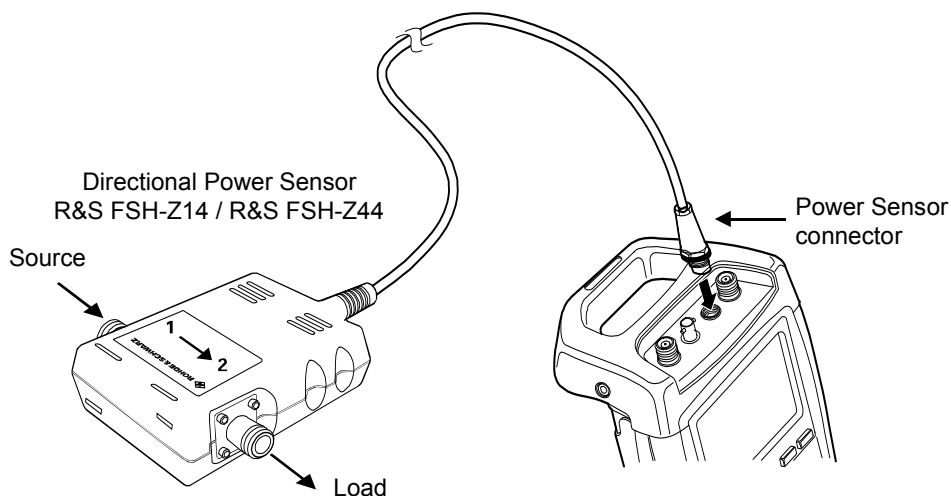

When measuring high powers, strictly observe the following instructions to prevent damage to the sensor or hazard to persons:



- *The permissible continuous power at the input of the directional power sensor must in no case be exceeded (see diagram on the rear of the sensor).*
- *Make sure that the RF power is switched off before connecting the sensor.*
- *Make sure that the RF connectors are tightly screwed.*

Failure to comply with these instructions may cause injuries like burns to the skin or may damage or even destroy the equipment used.

Operating sequence:

- Press the MEAS key.
- Press the MEASURE softkey.

The measurement functions submenu opens.

- Using the cursor keys or the rotary knob, select the POWER SENSOR menu item and confirm with the ENTER key or the MEASURE softkey.

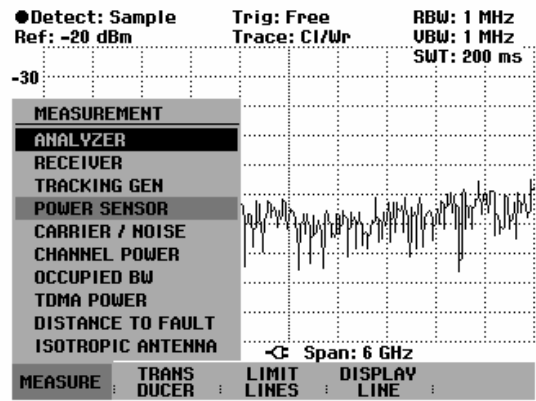

The R&S FSH opens the screen for power measurements. If no power sensor is connected, it does not display any measured value and outputs `Power sensor (unknown)` in the status field. If a power sensor is connected, the R&S FSH sets up a connection via its interface, displays first the message `Power sensor (Detecting)` and then the message `Power sensor (Booting)` in the status field and, after a few seconds, displays the type of the sensor connected (R&S FSH-Z44) as well as the measured power.

In the event of incorrect operation or sensor malfunction, the R&S FSH outputs the following error messages:

| Message | Cause | Remedy |
|------------------------------------|---|--|
| Error in zeroing: signal at sensor | A signal was present at the power sensor when zeroing was performed. | Unscrew the power sensor from the device under test and repeat zeroing. |
| Warning: input overloaded | The power at the input of the power sensor exceeds the permissible power. | Reduce the power at the sensor input. |
| Hardware error | Communication error between the R&S FSH and the power sensor. | Unscrew the sensor from the R&S FSH and check the connectors. If the problem persists, contact a Rohde & Schwarz service center. |
| Power sensor error | The power sensor signals an error to the R&S FSH. | Contact a Rohde & Schwarz service center. |

Screen layout for measurements with Directional Power Sensors R&S FSH-Z14/-Z44:

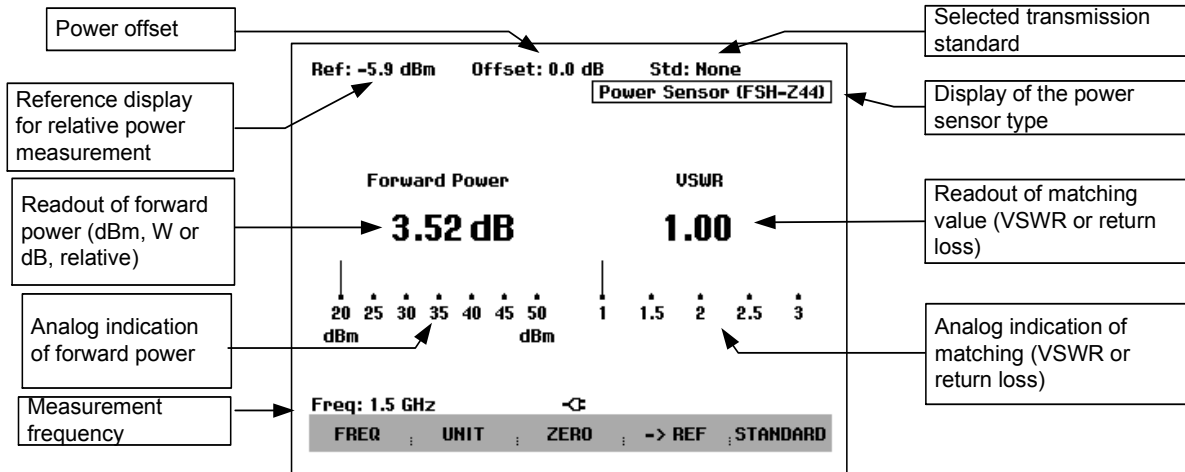

The power sensors contain frequency-dependent correction values. This means that the highest accuracy is reached for signals whose frequency is known. When the R&S FSH switches to the power measurement mode from another operating mode, it transfers its current center frequency to the power sensor.

If a signal at another frequency is to be measured, the new center frequency can be transferred to the power sensor by entering the frequency (FREQ softkey).

- Press the FREQ softkey.

The frequency value entry box opens.

- Using the number keys, enter the frequency you want and confirm the entry with the ENTER key or by pressing the FREQ softkey again.

The R&S FSH transfers the new frequency to the power sensor which corrects the measured power values accordingly.

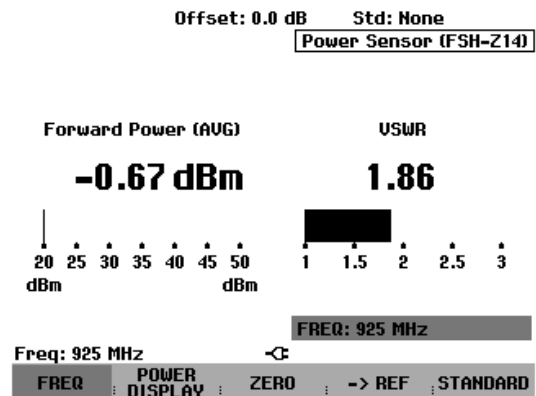

Zeroing the power sensor

Offset voltages and currents have the greatest effect on the power readout when low powers are being measured. Zeroing is used to compensate for these offsets. The power sensor automatically performs zeroing when the corresponding function is activated by the user. No power must be applied to the sensor while zeroing is being performed, since the sensor cannot distinguish between external powers and internal offsets.

- Press the ZERO softkey.

The R&S FSH outputs a message to inform the user that no signal should be present at the power sensor input while zeroing is being performed.

- Disconnect the power sensor from any signal sources.
- Start zeroing by pressing CONTINUE (first or second softkey).

Zeroing can be aborted before it is started by pressing CANCEL (4th or 5th softkey), for example if a signal source cannot be disconnected.

The R&S FSH immediately starts zeroing the power sensor after CONTINUE is pressed. While zeroing is in progress, the message "Zeroing power sensor, please wait..." is displayed on the R&S FSH.

When zeroing is completed, the R&S FSH outputs the message "Power Sensor Zero OK" and switches back to the softkey menu for the power sensor.

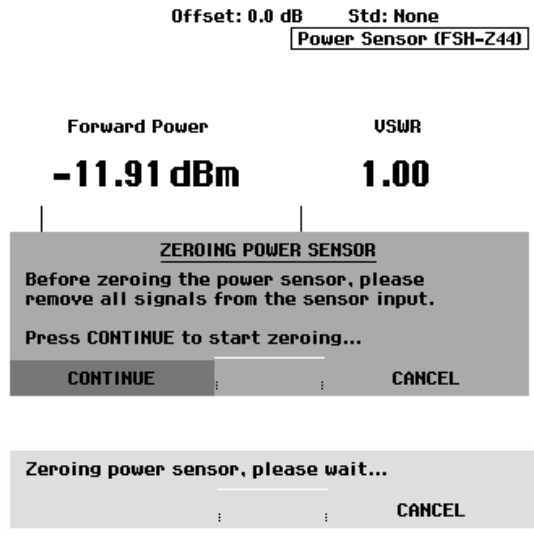

Setting the power measurement weighting

For forward power display, the R&S FSH provides both average power and peak envelope power. Use the POWER DISPLAY softkey in the Power Sensor menu to switch between the two.

- Press the POWER DISPLAY softkey.

The menu window for selecting the unit entry for forward power or reflection is opened.

- Select FORWARD POWER from the menu using the rotary knob or the cursor keys.
- Confirm your selection with the ENTER key or by pressing the POWER DISPLAY softkey.

In addition to possible units for the forward power, the R&S FSH displays the weightings average power and peak envelope power in a submenu. The currently set weighting mode is highlighted in green.

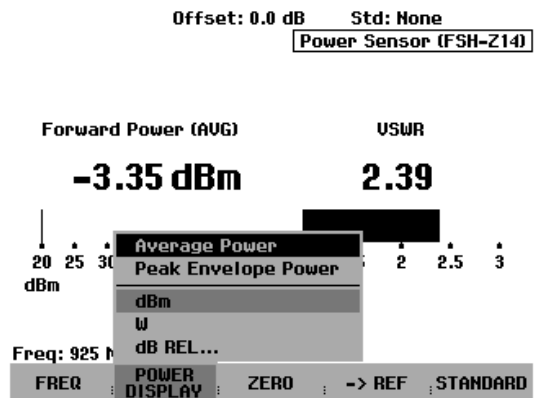

- Select the desired weighting mode using the rotary knob or the cursor keys.
- Confirm your choice with the ENTER key or the POWER DISPLAY softkey.

The R&S FSH displays the set weighting under the heading forward power on the screen:

Forward power (AVG) = average power
 Forward power (PEP) = peak envelope power

Selecting the unit for the power readout

The R&S FSH displays the measured forward power as a logarithmic level value in dBm (relative value) or as a linear value in W or mW (absolute value). Moreover, a reference level can be defined relative to which the R&S FSH indicates the level difference in dB. Load matching is indicated as return loss in dB or as voltage standing wave ratio (VSWR). In addition, the absolutely reflected power can be displayed in W, or the reflected level in dBm.

- Press the POWER DISPLAY softkey.

The menu for selecting the units for forward power and reflected power display opens.

- Using the rotary knob or the cursor keys, select the parameter for which a unit is to be entered.
- Confirm the parameter with the ENTER key or the POWER DISPLAY softkey.

A submenu with the available units opens.

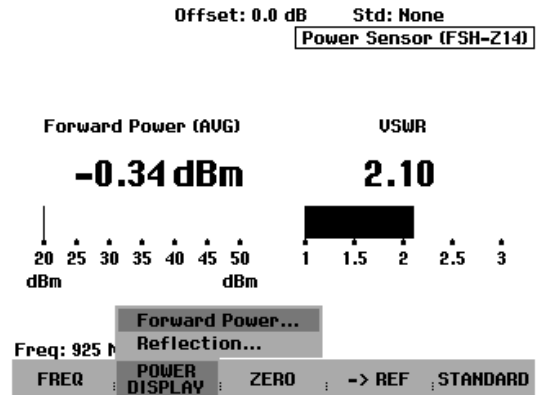

For the forward power, the following units can be selected:

- dBm
- W
- dB REL

For the reflected power or the reflection, the following units can be selected:

- dBm
- W
- VSWR
- dB (return loss)

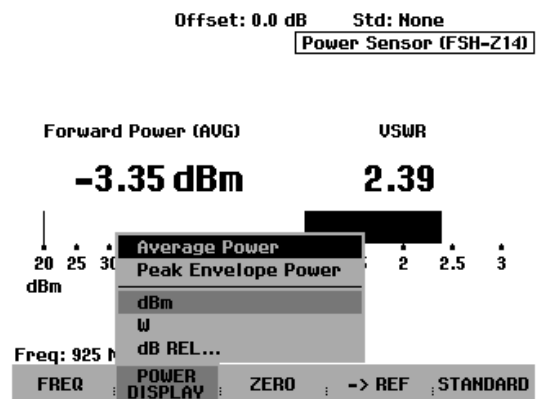

When the dB REL... unit is selected, an entry box for the reference level opens.

- Enter the reference level (REFERENCE) using the number keys and terminate the entry with the appropriate unit, or change the reference level using the rotary knob or the cursor keys.

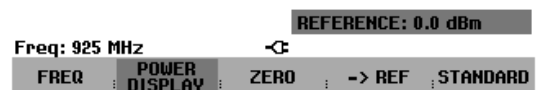

The current level reading can be defined as the reference level simply by pressing the ->REF softkey.

- Press the ->REF softkey.

The R&S FSH accepts the currently measured level as the reference level and displays the measured level difference relative to the reference level in dB. The unit (UNIT) is automatically set to dB REL...

The reference level is displayed in the upper left corner of the screen (in this case: Ref: -4.8 dBm).

The reference level can be adjusted in the REFERENCE entry box by means of the rotary knob, the cursor keys or the number keys.

- Confirm the reference level with the ENTER key or the ->REF softkey.
- To switch off the relative measurement to absolute values, press the POWER DISPLAY softkey.
- Select the Forward Power... parameter.
- Select dBm or Watt for forward power indication.

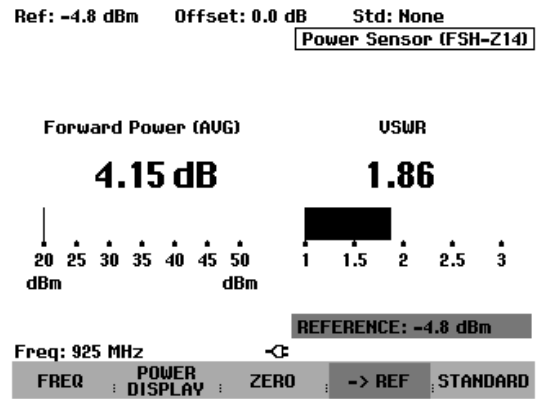

To ensure that true results are output when measuring modulated signals, the R&S FSH offers the possibility of taking correction values into account for a number of common transmission standards.

- Press the STANDARD softkey.

A menu with the selectable standards opens.

- Select the desired standard using the rotary knob or the cursor keys.
- Confirm with the ENTER key or by pressing the STANDARD softkey again.

The selected standard is displayed in the upper right corner of the screen.

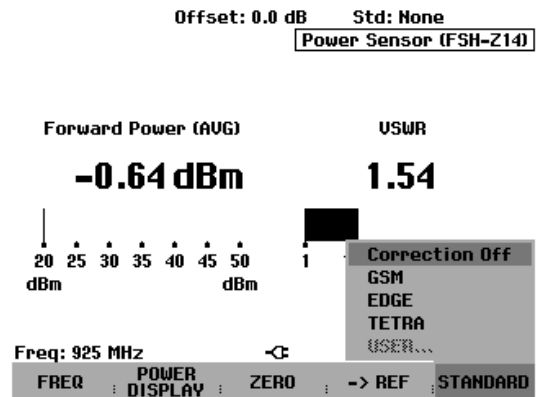

Taking additional attenuation into account

When the directional power sensor is connected to a test point not directly but via a cable, the influence of cable attenuation can be taken into account. For this purpose, the cable attenuation for the measurement frequency in question is to be entered, i.e. as a positive dB value if the power and matching are to be measured at the source and the cable is connected between the source and the power sensor, and as a negative dB value if the power and matching are to be measured at the load and the cable is connected between the load and the power sensor. The directional power sensor then corrects the power and matching values to produce the results that would have been obtained if it had been directly connected to the test point.

- Press the AMPT key.
- Press the REF OFFSET softkey.

The value entry box for the reference offset opens.

- Enter the desired offset using the rotary knob, the cursor keys or the number keys and confirm the entry with the ENTER key.

The selected offset is displayed in the middle at the top of the screen and is taken into account in the power (level) and matching results.

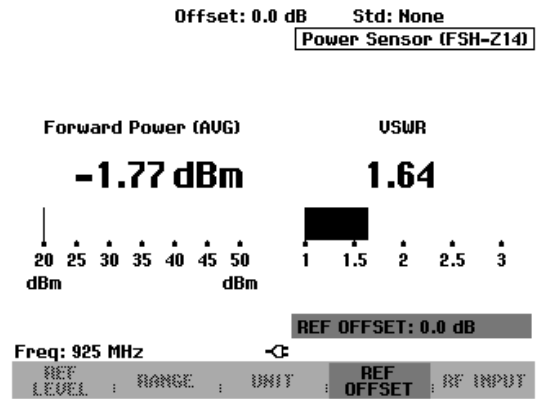

If high powers are applied that exceed the maximum input level of the R&S FSH-Z14 or R&S FSH-Z44, a directional coupler or an attenuator has to be connected ahead of the power sensor. In such cases, the coupling attenuation of the directional coupler or the attenuation value of the attenuator are to be entered as positive dB values (see above) into the R&S FSH to ensure true measured power readout. In both cases, a termination or an attenuator of sufficient power-handling capacity has to be connected to the power sensor at the load end. The matching readout is irrelevant in such case since it is likewise corrected by taking into account the attenuation value of the termination or attenuator (see measurement via cable).

Two-port measurements with the tracking generator

(Only for R&S FSH with tracking generator: R&S FSH3 order No. 1145.5850.13 and 1145.5850.23, R&S FSH6 order No. 1145.5850.26)

The R&S FSH can be supplied with an optional tracking generator to measure the transmission of two-ports or the reflection coefficients of one-ports and two-ports. The tracking generator outputs a signal at the current R&S FSH frequency. The nominal output level depends on the model as shown in the following table.

| Model | Tracking generator output level | Step attenuator |
|-------------------------|--|---|
| R&S FSH3 (1145.5850.13) | -20 dBm | - |
| R&S FSH3 (1145.5850.23) | -20 dBm / 0 dBm, switchable | 0 to 20 dB / 1 dB steps (serial numbers 102314 and later) |
| R&S FSH6 (1145.5850.26) | -10 dBm ($f < 3$ GHz) -20 dBm ($f > 3$ GHz) | 0 to 20 dB / 1 dB steps (serial numbers 100500 and later) |

Two-port transmission can be determined directly by connecting the input of the DUT to the output of the tracking generator and the DUT's output to the R&S FSH's RF input. A bridge is required to measure the reflection coefficient, e.g. the VSWR Bridge R&S FSH-Z2 (10 MHz to 3 GHz) or the R&S FSH-Z3 (10 MHz to 6 GHz).

Due to the calibration technique used, the R&S FSH's measurement accuracy is high for both transmission measurements and reflection measurements. The R&S FSH offers scalar calibration methods as standard; i.e. with transmission and reflection measurements, the magnitudes are corrected. Vector calibration methods and measurements (option R&S FSH-K2) are possible for increasing the dynamic range and the measurement accuracy. The operation of vector measurements primarily differs in the expanded calibration routines.

- Press the MEAS key.
- Press the MEASURE softkey.

The measurement function submenu opens.

- Using the cursor keys or the rotary knob, select the TRACKING GEN menu item (highlighted in red) and confirm your selection with the ENTER key or the MEAS softkey.

The R&S FSH turns on the tracking generator and switches to its softkey menu. However, the frequency and level settings from the spectrum analyzer mode are not changed.

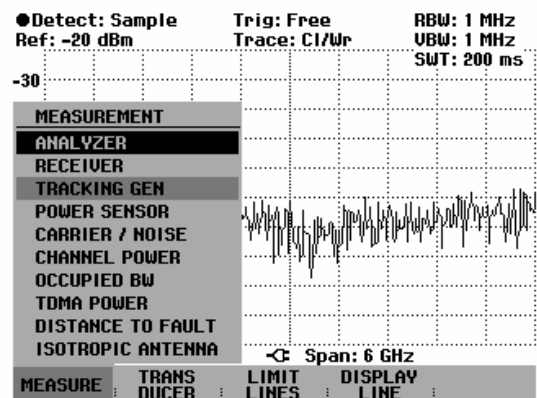

The softkey menu for the tracking generator contains softkeys for calibrating transmission measurements (TRANSM CAL) and reflection coefficient measurements (REFLECT CAL). Calibration is necessary because the tracking generator output level does not exactly match the values specified in the table and it is frequency-dependent. If transmission measurements are performed on a two-port, the calibration takes the transmission characteristics of the test setup and the frequency response of the tracking generator into account and corrects the measurement with the correction data that has been obtained. When a reflection measurement is to be performed, during calibration the R&S FSH measures the reflection coefficient at a short and at an open on the bridge. These two measurements provide the correction data for reflection measurements.

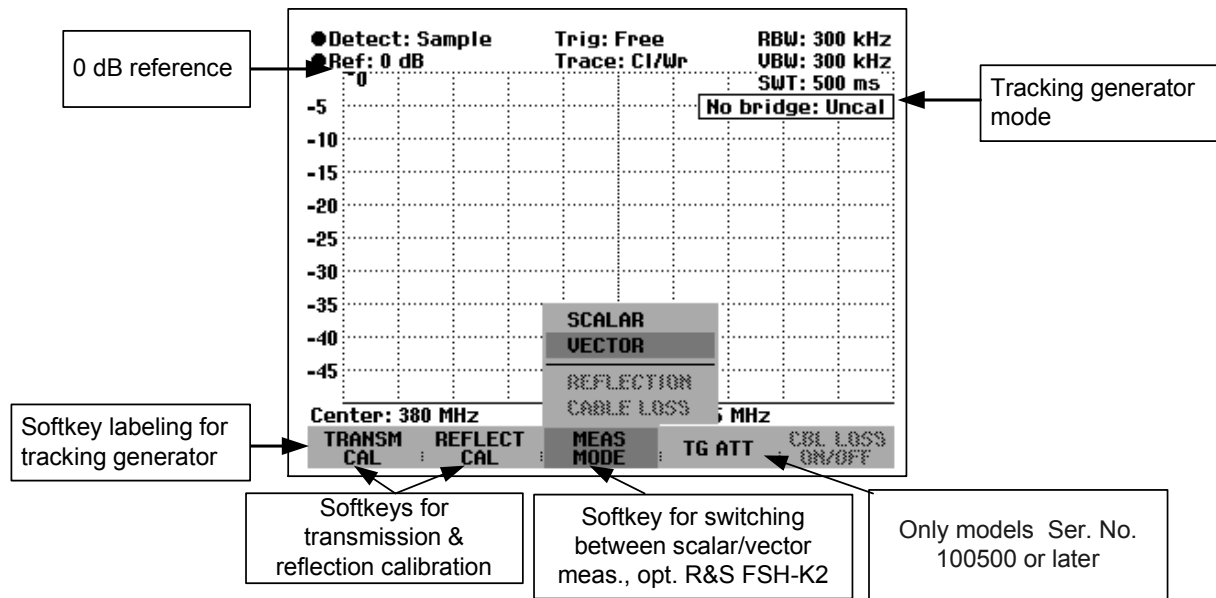

When the tracking generator is switched on, the R&S FSH displays Track Gen Uncal. This indicates that tracking generator measurements are uncalibrated. The level axis is in the relative unit dB. Apart from the level values, the 0 dB reference is also displayed. This corresponds to a reference level of -20 dBm in the spectrum analyzer mode (= nominal output level of the tracking generator with model 1145.5850.13). If an output level of 0 dBm is used with model 1145.5850.23, the 0 dB reference corresponds to a reference level of 0 dBm.

When the tracking generator is on, measurement parameters like bandwidth or the frequency range are selected with the appropriate keys as in the spectrum analyzer mode. When the MEAS key is pressed, the softkey menu for the tracking generator is displayed.

Before calibration, the output level of the tracking generator (models 1145.5850.23 and 1145.5850.26 only), the frequency range you want and the appropriate reference level should be set because calibration is only valid for the calibrated frequency range and reference. Changing these parameters after calibration invalidates calibration.

When you press the MEAS key twice, the R&S FSH again opens the menu for selecting the various measurements.

Setting the output level:

(model 1145.5850.23 only up to serial number 102314)

- Press the TG ATT softkey in the TRACKING GEN menu.

The submenu for selecting the output level will open. The output level is set by selecting an attenuation value (0 dB or 20 dB). If you select 0 dB, the output level will be 0 dBm. If you select 20 dB, the output level will be -20 dBm.

- Using the rotary knob or the cursor keys, place the red cursor on the attenuation value you want.
- Confirm your selection with the ENTER key or the TG ATT softkey.

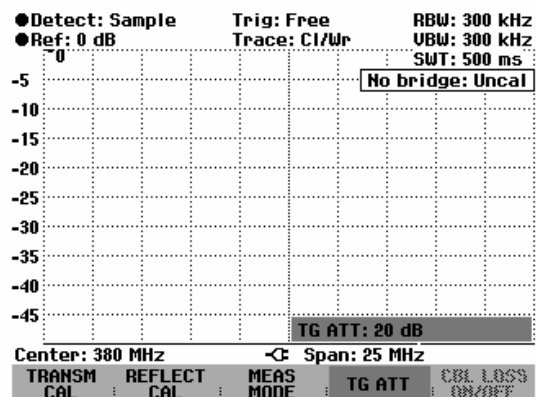

Setting the tracking generator step attenuator:

(Only model 1145.5850.26 with serial number 100500 or later; or model 1145.5850.23 with serial number 102314 or later).

To measure active DUTs with high gain, you can reduce the output level of the tracking generator by up to 20 dB in 1 dB steps by using the adjustable step attenuator.

- Press the TG ATT softkey in the TRACKING GEN menu.

The R&S FSH will open the entry field for setting the attenuation.

- Enter the attenuation value you want by using the rotary knob, the cursor keys, or the numeric keys.
- Confirm the selection by pressing the ENTER key or the TG ATT softkey.

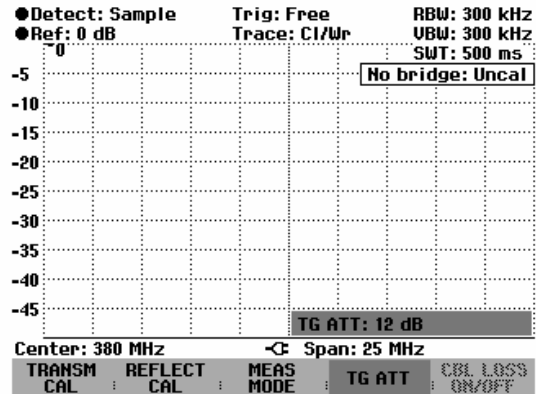
**Measuring the transmission of two-ports**

To perform a transmission measurement, connect the input of the DUT to the generator output and the DUT's output to the RF input of the R&S FSH. The R&S FSH measures the magnitude of the DUT's transmission. The operating sequence is explained below using a transmission measurement on a SAW filter with a center frequency of 380 MHz and a bandwidth of approx. 4 MHz as an example. The measurement example starts with the R&S FSH in its default setting.

Setting the frequency range:

- Press the PRESET key.
- Press the MEAS key.
- Press the MEASURE softkey.
- Using the rotary knob or the cursor keys in the MEASUREMENT menu, select the TRACKING GEN menu item and confirm the selection with the ENTER key or the MEASURE softkey.

The R&S FSH displays the tracking generator menu.

As calibration has not been performed, Track Gen Uncal is displayed in the top right-hand corner of the measurement diagram.

- Press the FREQ key.
- Using the number keys, enter the center frequency (380 MHz in this example).
- Press the SPAN key.
- Using the number keys, enter the span (25 MHz in this example).

- Connect the DUT between the RF input and the generator's output.

The R&S FSH displays the transmission magnitude. Values can be read off with, for example, the markers.

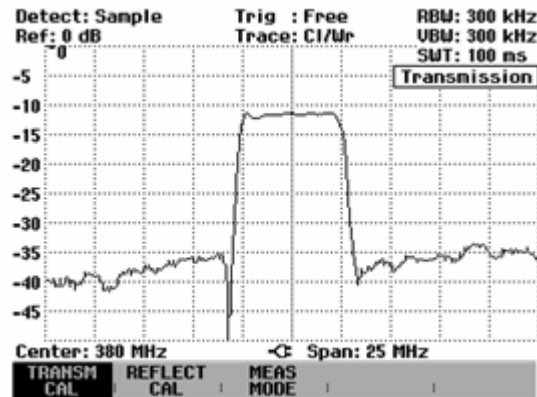

The transmission calibration remains valid until the center frequency or the span is changed on the R&S FSH. Track Gen Uncal is displayed in the top right-hand corner of the screen when calibration is no longer valid.

If the reference is changed after calibration, greater measurement uncertainty must be anticipated. The R&S FSH retains the calibration data but displays a red dot before **Transmission** in the top right-hand corner of the screen to indicate a possible increase in measurement uncertainty (< 0.3 dB).

Changing any other of the parameters like bandwidth, detector, sweep time or measurement range has no effect on measurement accuracy. This means they can be changed after calibration without any reduction in accuracy.

When a data set for scalar transmission measurement is stored with calibration performed, the calibration data can be stored along with the other settings (see Chapter 2, section "Saving Calibration Data"). When such a data set is recalled, measurements can be performed without prior calibration, providing the instrument's temperature does not deviate more than 5 °C from its temperature when the data set was stored.

If the temperature deviation is greater, the R&S FSH outputs a (red) dot in front of **• Transmission**. A precise measurement can then only be made after a calibration.

Measurement on amplifiers:

With measurements on amplifiers, the reference must be shifted so that the amplifier's transmission function can be seen on the screen. An increase of the reference level corresponds to an increase of the input attenuation. The R&S FSH provides a reference setting for this purpose. The position of the 0 dB reference can be shifted to positive or negative values.

- Press the AMPT key.
- Press the REF softkey.
- Change the reference using the rotary knob or the cursor keys, or enter a new reference via the numeric keypad.
- Confirm the entry with the ENTER key or the REF softkey.

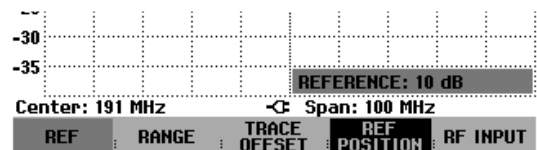

When performing measurements on amplifiers, make sure the R&S FSH is not overdriven. The risk of overdriving is eliminated when the trace is within the display area on the screen (with REF POSITION = 0 dB and TRACE OFFSET = 0 dB).

The reference can also be shifted without increasing the input attenuation – for example, in order to move the trace to the center of the screen. This is done using the REF POSITION function.

- Press the AMPT key.
- Press the REF POSITION softkey.
- Change the reference position using the rotary knob or the cursor keys, or enter a new reference position via the numeric keypad.
- Confirm the entry with the ENTER key or the REF POSITION softkey.

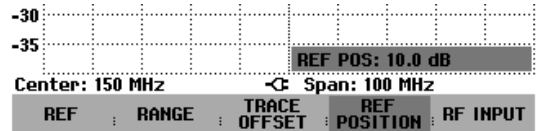

In addition, the trace can be offset without changing the reference and the scale of the y axis.

- Press the AMPT key.
- Press the TRACE OFFSET softkey.
- Change the level offset of the trace using the rotary knob or the cursor keys, or enter a new offset via the numeric keypad.
- Confirm the entry with the ENTER key or the TRACE OFFSET softkey.

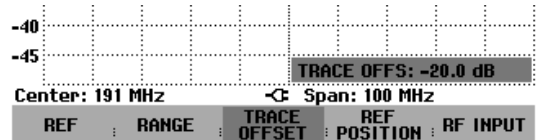

The trace offset function is useful if it is necessary to compensate for a fixed loss or gain during the measurement.

Vector transmission measurement

(only with option R&S FSH-K2)

With vector measurements, the R&S FSH analyzes both magnitude and phase of the receive signal, thus correcting the influence it has on the measurement result by means of the complex correction values obtained from the calibration routines with correct phase. Reference is made to the calibration standards used (through connection and 50 Ω termination).

Compared to scalar measurement, the vector transmission measurement yields higher measurement accuracy and dynamic range.

Switching on vector measurement:

- Press the MEAS key.
- Press the MEAS MODE softkey.
- Select VECTOR from the menu using the cursor keys or the rotary knob.
- Confirm your choice with the ENTER key or the MEAS MODE softkey.

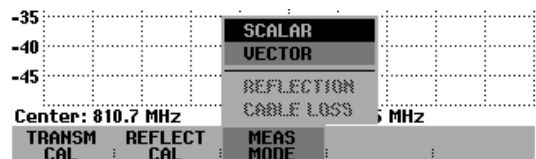

Calibrating the measurement:

Before the R&S FSH is calibrated, the desired center frequency and span must be set. If they are set later, the calibration values are lost and the measurement must be recalibrated.

- Press the MEAS key.
- Press the TRANSM CAL softkey.

To calibrate the transfer measurement, the R&S FSH requests that the RF input be connected to the tracking generator output.

- Connect the RF input of the R&S FSH directly to the tracking generator output without the DUT.
- Press the F1 or F2 (CONTINUE) softkey to start calibration.
- By pressing the F4 or F5 (CANCEL) softkey, calibration can be aborted.

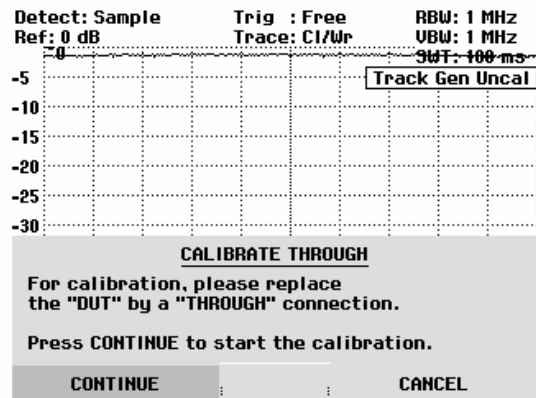

During calibration, the R&S FSH outputs the message "Calibrating THROUGH, please wait...".

Calibration can be aborted with CANCEL.

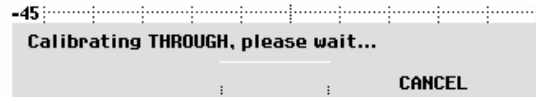

The R&S FSH then requests to terminate the output of the tracking generators into 50 Ω.

- Connect the generator output with the 50 Ω termination.
- Press the F1 or F2 (CONTINUE) softkey.

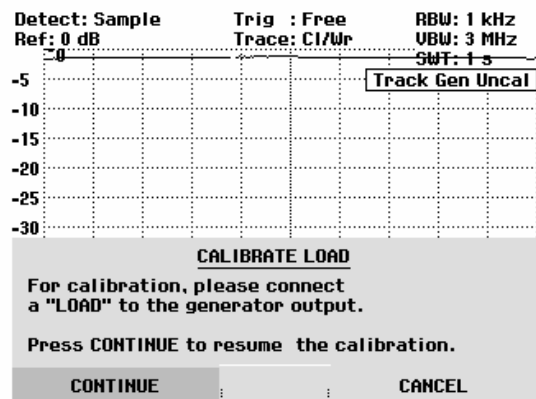

During calibration, the R&S FSH outputs the message "Calibrating LOAD, please wait".

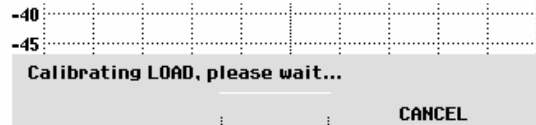

When calibration is over, Transm (vect) is displayed in the top right-hand corner to indicate that the R&S FSH is vector-calibrated for transmission measurement.

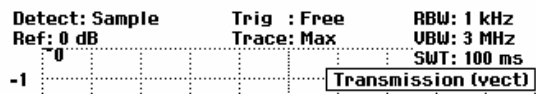

Connect the DUT between the tracking generator output and the RF input. The R&S FSH displays the magnitude of the transmission of the DUT.

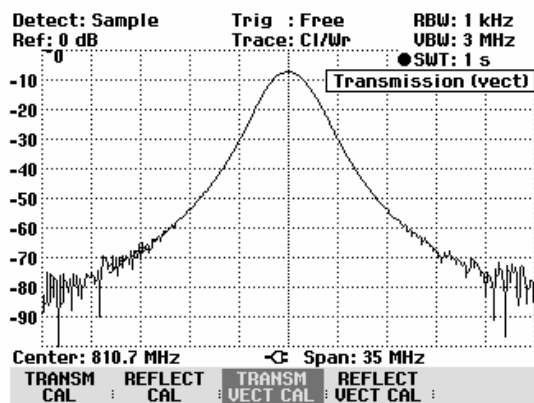

Transmission measurement using the connected VSWR Bridge R&S FSH-Z3

Some measurement tasks require that both the transmission and the reflection be determined. To eliminate having to repeatedly mount and dismount the VSWR bridge, the VSWR Bridge R&S FSH-Z3 (10 MHz to 6 GHz) includes a switch that bypasses the VSWR bridge and simultaneously switches the tracking generator signal to the output (Gen Output) of the VSWR bridge. The switch is controlled via the control cable, which is connected with the power sensor socket of the R&S FSH. Due to the insertion loss of the VSWR bridge, the output level of the tracking generator is typically 4 dB lower. The frequency-dependent insertion loss is compensated in the measurement after calibration.

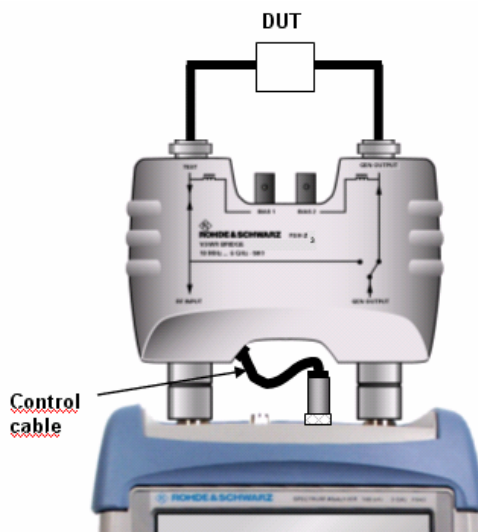

As soon as the control cable has been connected to the R&S FSH, the VSWR Bridge R&S FSH-Z3 is automatically detected and indicated both on the display and the status menu. Automatic detection requires that this feature be activated in the SETUP menu (default setting). See also "Settings for detection of the R&S FSH-Z3 in transmission and spectrum measurements".

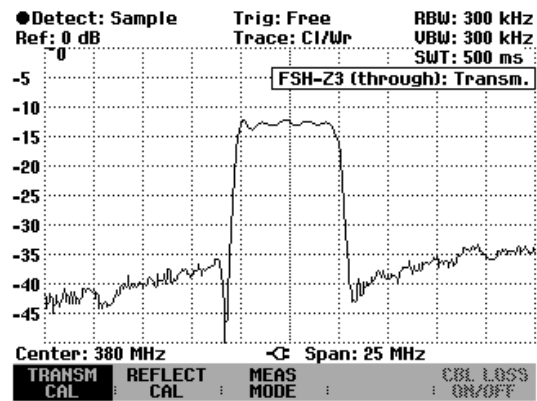

Spectrum measurements with the VSWR Bridge R&S FSH-Z3 or R&S FSH-Z2 connected

To localize interfering signals or to perform spectral evaluation of the DUT, it is useful to switch to the spectrum display. To eliminate having to dismount the VSWR bridge each time, a typical value for the insertion loss of the VSWR bridge is incorporated into the measurement. This corrective step requires that the control cable for automatically detecting the bridge be connected to the R&S FSH. Since the value is merely a typical frequency-independent correction value, an additional level measurement uncertainty of max. 2 dB must be anticipated.

Operation:

- Press the MEAS key.
- Select the MEASURE softkey.
- Select ANALYZER from the menu by using the rotary knob or the cursor keys and confirm the entry with the ENTER key.

As soon as the control cable has been connected to the R&S FSH, the VSWR Bridge R&S FSH-Z3 is automatically detected and indicated both on the display and the status menu. Automatic detection requires that this feature be activated in the SETUP menu (default setting). See also "Settings for detection of the R&S FSH-Z3 in transmission and spectrum measurements".

Both the display and the status menu will indicate that a VSWR bridge is connected.

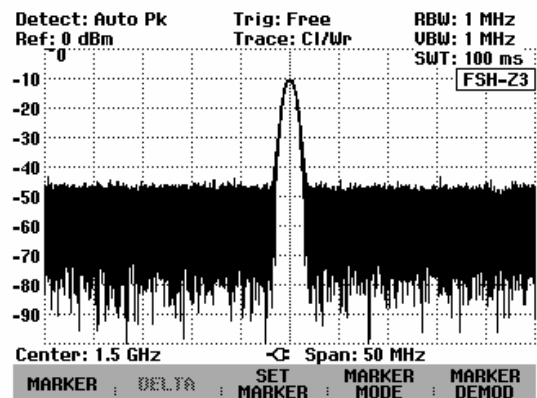

Settings for detection of the R&S FSH-Z3 in transmission and spectrum measurements

Operation:

- Press the SETUP key.
- Select the HARDWARE SETUP softkey.
- Select ACCESSORY from the menu by using the rotary knob or the cursor keys and confirm the entry with the ENTER key.

The R&S FSH opens a menu where different modes for detecting the R&S FSH-Z3 bridge can be selected.

- Select AUTO DETECT or BRIDGE FSH-Z3 from the menu by using the rotary knob or the cursor keys and confirm the entry with the HARDWARE SETUP softkey or the ENTER key.

If you select AUTO DETECT, the VSWR bridge is detected automatically as soon as the control cable has been connected to the probe power socket on the R&S FSH.

If you select BRIDGE FSH-Z3, the VSWR bridge is detected by default. This setting may be useful if you only work with the R&S FSH-Z3 connected and do not want to waste time on automatic detection.

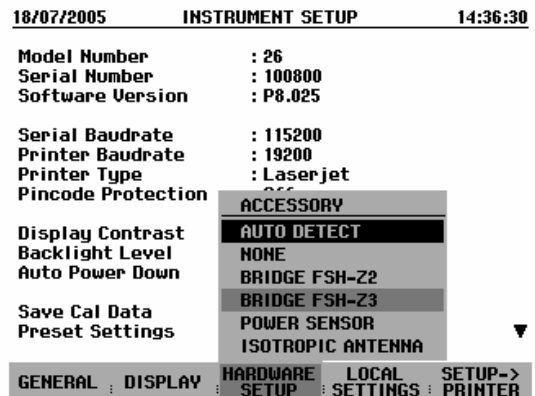

Supplying DC voltage to active DUTs

By using the VSWR Bridge R&S FSH-Z3, DC voltage can be supplied to active DUTs such as amplifiers through the integrated bias tees (BIAS 1 and BIAS 2) via the RF cable. The DC voltage is fed in from a suitable external power supply (max. 300 mA/max. 50 V). To measure the antenna coupling of mobile radio base stations, the DC voltage must be supplied to two tower-mounted amplifiers (TMA). This is done by applying a suitable voltage at the BIAS 1 and BIAS 2 BNC inputs of the VSWR bridge.

Reflection measurements

The VSWR Bridge R&S FSH-Z2 or R&S FSH-Z3 is required for reflection measurements. However, an equivalent bridge (e.g. the R&S ZRB2 from Rohde & Schwarz) can be used.

- Connect the control cable of the R&S FSH-Z2/-Z3 to the power sensor socket of the R&S FSH.
- Connect the RF connectors of the R&S FSH-Z2/-Z3 to the RF input and generator output of the R&S FSH (see labeling on VSWR bridge).

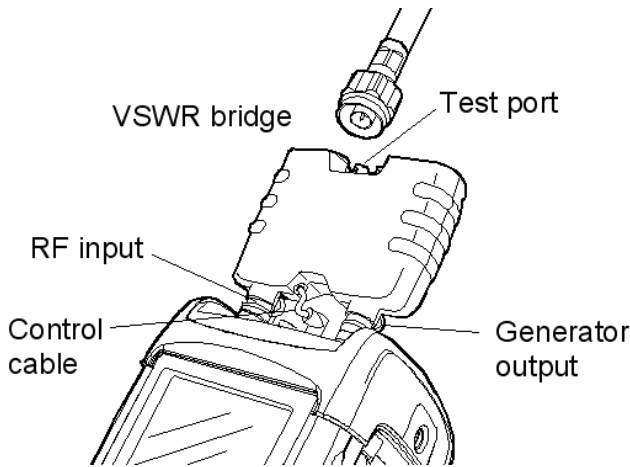

R&S FSH with the VSWR Bridge R&S FSH-Z3

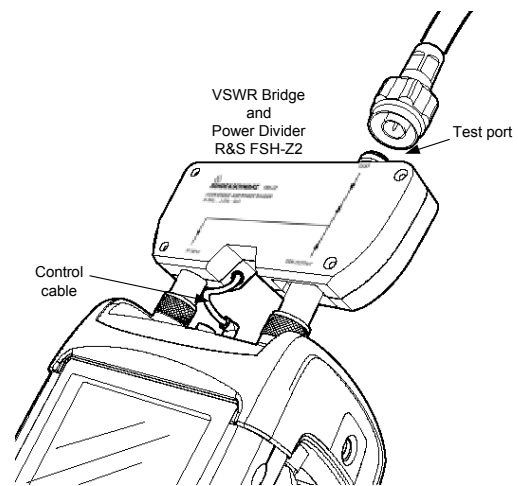

R&S FSH with the VSWR Bridge and Power Divider R&S FSH-Z2

Scalar measurement of reflection

The test setup must be calibrated before any measurements are made. This is done with a short and an open at the point where the reflection measurement is to be made. If a cable is to be inserted between the DUT and the bridge, perform the calibration at the measurement end of the cable.

- Press the REFLECT CAL softkey.

The R&S FSH prompts the user to connect an open to the measurement input.

- Connect an open to the measurement port of the bridge.
- By pressing the first or the second softkey (CONTINUE), start the OPEN calibration. While calibration is in progress, the R&S FSH outputs the message "Calibrating OPEN, please wait...".
- Press the CANCEL softkey to abort calibration.

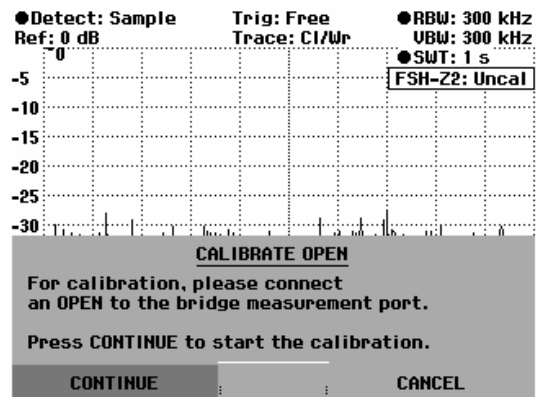

When OPEN calibration is over, the R&S FSH prompts the user to perform SHORT calibration.

- Connect a short to the measurement input of the bridge.
- Using CONTINUE start the SHORT calibration.
- Calibration can be aborted with CANCEL.

Note: Instead of a SHORT, the R&S FSH can be calibrated again with an OPEN. As the R&S FSH only measures the magnitude of the reflected voltage, it cannot distinguish between a SHORT and an OPEN. However, calibration with a SHORT increases measurement accuracy because the R&S FSH takes the average of the calibration values for the SHORT and the OPEN.

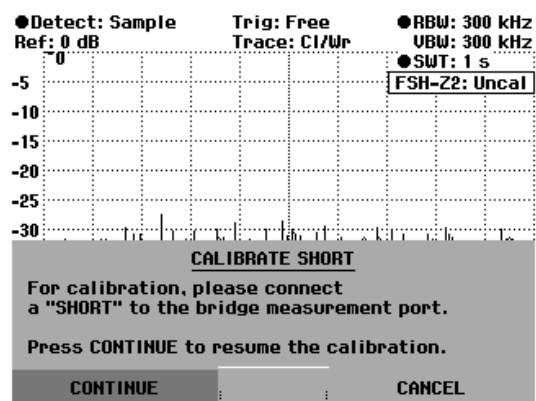

During calibration, the R&S FSH outputs the message "Calibrating SHORT, please wait...". Calibration can be aborted with the CANCEL softkey.

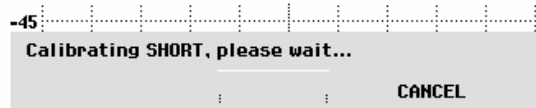

When calibration is over, the R&S FSH outputs the message "Reflect. calibrated" for 3 seconds.

Reflection is displayed in the top right-hand corner of the measurement diagram to indicate that the R&S FSH is calibrated for reflection measurements. The softkey label REFLECT CAL is highlighted in green.

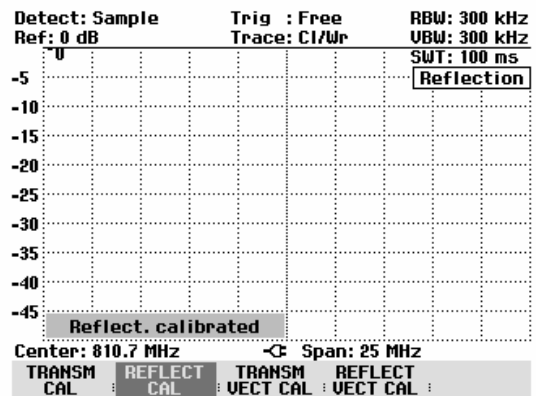

- Connect the DUT to the measurement port of the VSWR bridge.

The R&S FSH displays the return loss of the DUT.

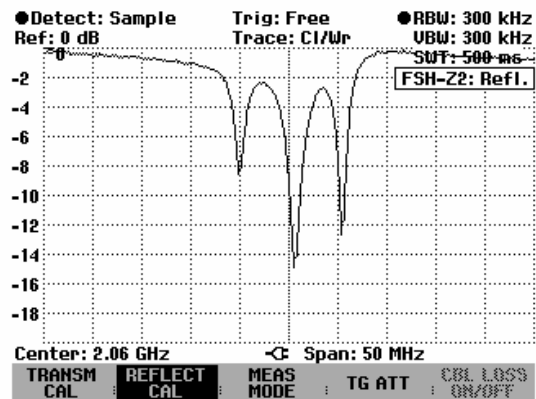

Entering the display unit:

Press the AMPT key.

- Press the RANGE softkey.

The submenu for selecting the display ranges will open. The following display units are available for the reflection measurement: return loss in dB, linear in %, standing wave ratio (VSWR), reflection coefficient (REFL COEFF (ROH)) and reflection coefficient (REFL COEFF (mROH)). Select the desired display unit by using the cursor keys or rotary knob.

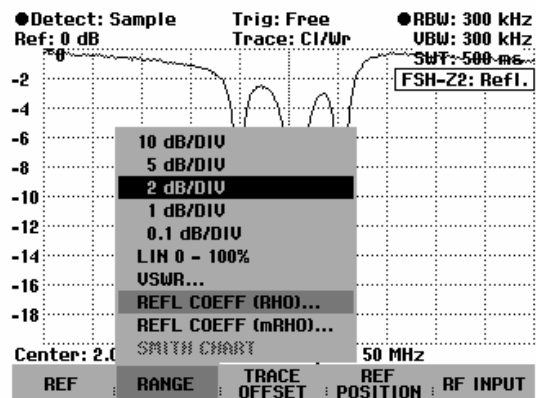

Note:

In the case of return loss and linear display, scaling is directly selected. In the case of all other units, a window for selecting the display range scaling opens. You can select a display range by using the cursor keys or the rotary knob.

Confirm the selection by pressing the ENTER key or the RANGE softkey.

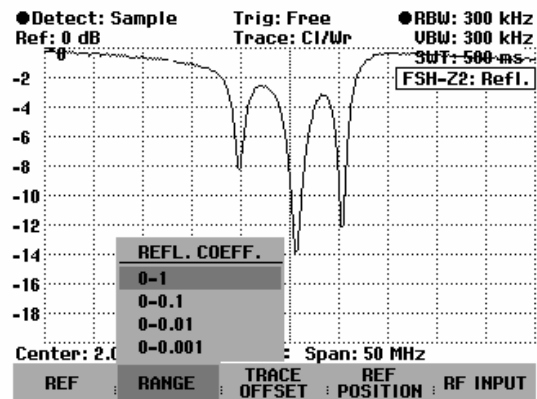

The R&S FSH displays the reflection coefficient of the DUT.

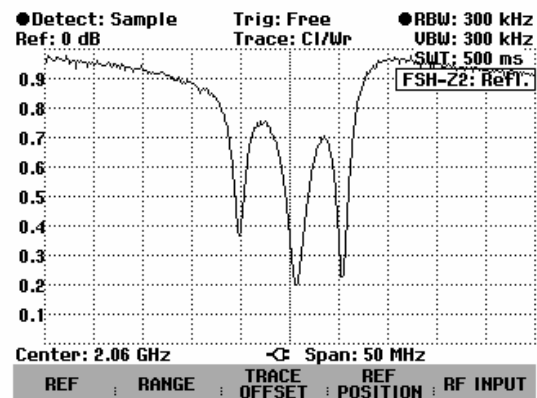

Reflection calibration remains valid until the R&S FSH's center frequency or span is changed. If calibration becomes invalid, the R&S FSH displays `Track Gen Uncal` in the top right-hand corner of the screen.

If the reference is changed after calibration, a larger measurement uncertainty must be anticipated. The R&S FSH retains the calibration data but places a red dot before the Reflection display in the top right-hand corner of the screen (`• Reflection`) to indicate a possible increase in measurement uncertainty up to 0.3 dB.

Changing other parameters like bandwidth, detector, sweep time or measurement range has no effect on measurement accuracy. This means they can be changed after calibration without any reduction in accuracy.

When a data set for scalar reflection measurement is stored with calibration performed, the calibration data can be stored along with the other settings (see Chapter 2, section "Saving Calibration Data"). When such a data set is recalled, measurements can be performed without prior calibration, providing the instrument's temperature does not deviate more than 5 °C from its temperature when the data set was stored.

If the temperature deviation is greater, the R&S FSH outputs a (red) dot in front of `• Reflection`. A precise measurement can then only be made after a calibration.

Vector measurement of reflection

(only available with option R&S FSH-K2)

Unlike with scalar measurement, the R&S FSH corrects the waveform reflected by the DUT according to magnitude and phase by means of the correction values obtained from calibration. In addition to

calibration with open circuit and short circuit, calibration with a $50\ \Omega$ termination is necessary. Thus, the characteristics of the VSWR bridge (directivity and impedances) no longer affect the measurement result. Rather, the decisive factor is the quality of the calibration parameters open circuit, short circuit and $50\ \Omega$ termination.

Vector measurement therefore yields higher dynamic range and thus accuracy.

With vector measurements, the R&S FSH sets the bandwidths (Res BW and Video BW) to a fixed, unchangeable value. It invariably uses the sample detector as a detector. All other measurement parameters can be set as with scalar measurement.

Switching on vector measurement:

- Press the MEAS key.
- Press the MEAS MODE softkey.
- Select VECTOR from the menu using the cursor keys or the rotary knob.
- Confirm your choice with the ENTER key or the MEAS MODE softkey.

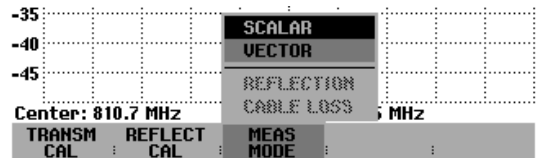

Calibration:

Before the R&S FSH is calibrated, the desired center frequency and span must be set. If they are set later, the calibration values are lost and the calibration must be repeated.

- Press the REFLECT CAL softkey.

The R&S FSH displays a message requesting termination of the measurement input into an open circuit (Open).

- Terminate the measurement input of the VSWR bridge or the end of the measurement cable into an open circuit.
- Start open-circuit calibration by pressing the first or the second softkey (CONTINUE). During calibration, the R&S FSH outputs the message "Calibrating OPEN, please wait...".
- Calibration can be aborted at any stage with the CANCEL softkey.

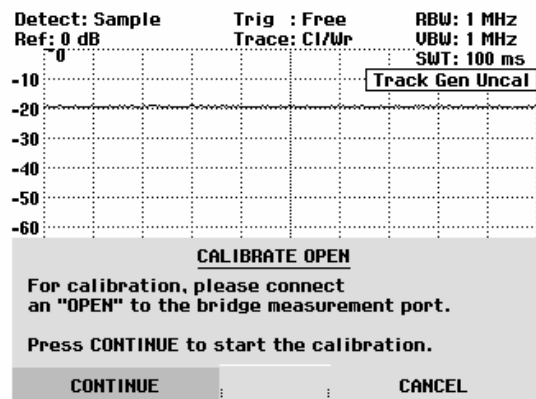

When the open-circuit calibration is over, the R&S FSH outputs a message requesting the termination of the measurement port into a short circuit.

- Terminate the measurement input of the bridge or the end of the measurement cable into a short circuit.
- Start the short-circuit calibration by pressing the first or the second softkey (CONTINUE). During calibration, the R&S FSH outputs the message "Calibrating SHORT, please wait...".

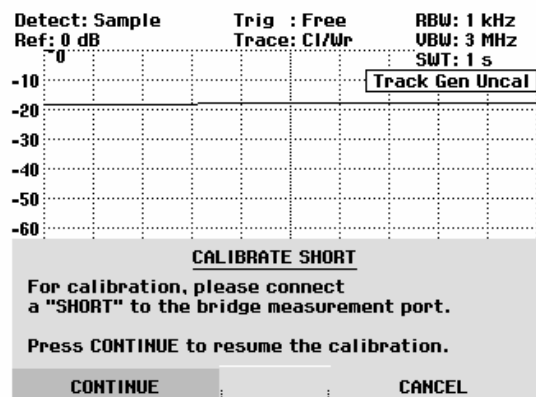

In the third step of calibration, terminate the measurement port into a 50 Ω termination.

- Terminate the measurement input of the bridge or the end of the measurement cable into a 50 Ω termination.
- Start termination calibration by pressing the first or the second softkey (CONTINUE). During calibration, the R&S FSH outputs the message "Calibrating LOAD, please wait...".

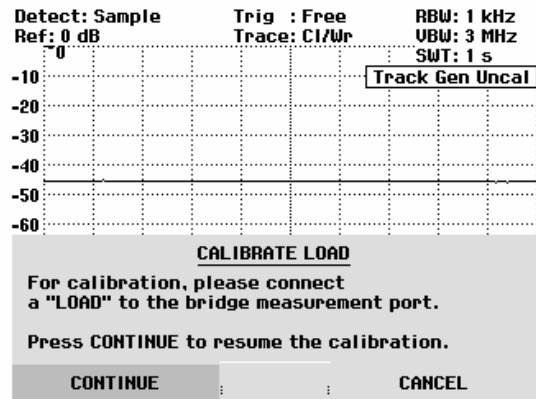

When calibration is over, the R&S FSH outputs the message "Reflect. calibrated" for three seconds.

Refl (vect) is displayed in the top right-hand corner of the diagram to indicate that the R&S FSH is vector-calibrated for reflection measurements. The softkey label REFLECT CAL is highlighted in green.

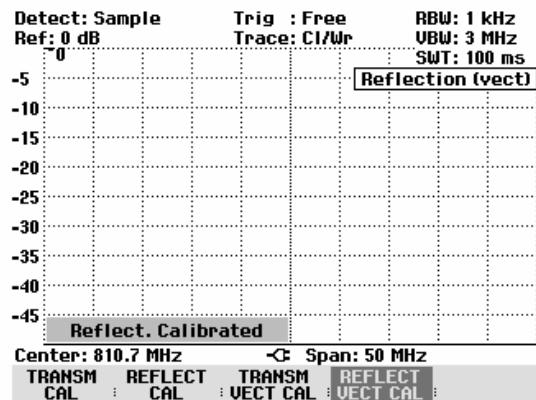

The reflection calibration remains valid until the center frequency or the span is changed on the R&S FSH. Track Gen Uncal is displayed in the top right-hand corner of the screen when calibration is no longer valid.

If the reference level is changed (AMPT key, REF softkey) after calibration, greater measurement uncertainty must be anticipated. The R&S FSH retains the calibration data but displays a red dot before the • Refl (vect) display in the top right-hand corner of the screen to indicate a possible increase in measurement uncertainty.

A change in sweep time does not affect reflection measurement.

The R&S FSH internally monitors the temperature. If temperature changes cause an increase in measurement error, the R&S FSH shows a red dot to the left of the measurement mode display (• Refl (vect)).

Display of reflection in vector measurement

Since the R&S FSH also evaluates the magnitude and phase during measurements following vector calibration, additional display capabilities are available as compared to scalar measurement. Owing to the larger dynamic range, the display ranges for the standing wave ratio (VSWR) and VSWR 1 –1.5 and VSWR 1 –1.1 are expanded. Thus, well matched DUTs can be measured with greater precision and higher display resolution.

However, one of the main advantages of vector measurement is also being able to display the complex measurement results in a Smith chart. This provides a much more in-depth look at the characteristics of the DUT than by displaying the reflection magnitude as return loss or VSWR.

- Press the AMPT key.
- Press the RANGE softkey.
- Using the cursor keys or rotary knob, select SMITH CHART from the menu.

Confirm your selection with the ENTER key or by pressing the RANGE softkey again.

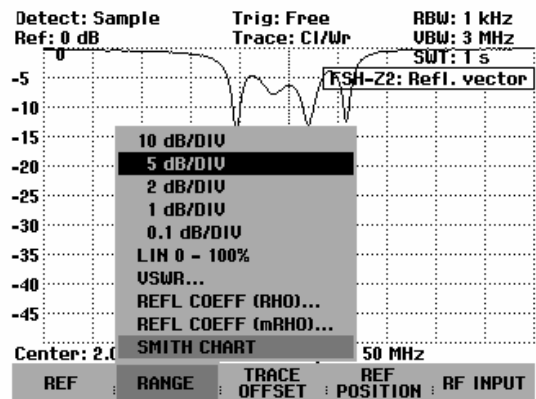

The R&S FSH displays the reflection of the DUT in the Smith chart.

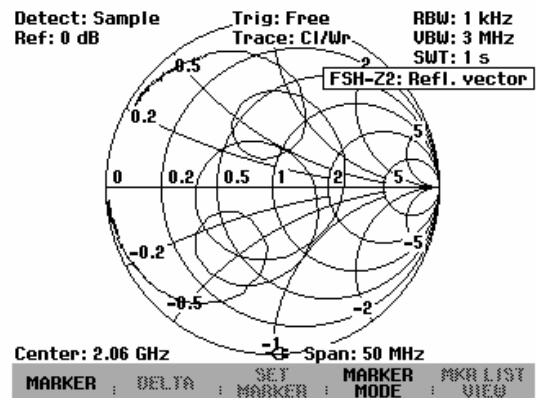

The markers in a Smith chart

As in scalar measurements, all marker functions (marker, delta marker, multi-markers) are available in the Smith chart.

- Press the MARKER key.

The R&S FSH activates the marker menu and a marker.

Using the rotary knob, cursor keys or numeric entry, move the marker on the complex impedance trace.

The numeric output of the marker values is provided along with the marker frequency and the complex impedance ((real component) + j (imaginary component)) in ohms.

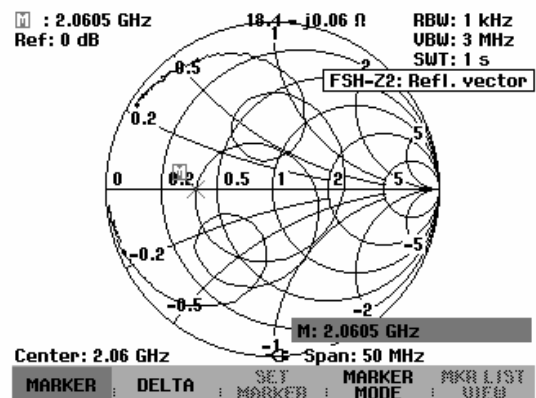

The output values for the delta marker(s) are in relation to the value of the reference marker.

Limit lines in the Smith chart:

To allow visual monitoring of VSWR limits, the R&S FSH offers VSWR limit values in the Smith chart. In a Smith chart, a VSWR limit value is shown by a circle whose center point is the reference resistance

and whose radius is determined by the VSWR value. All values within the circle have a VSWR value that is smaller than the VSWR value defined by the circle.

To activate the VSWR limit value:

- If starting from the main menu for the tracking generator, press the MEAS key. If starting from any other menu, press the MEAS key twice.
- Press the LIMIT LINES softkey.

The R&S FSH displays the menu for limit values in a Smith chart representation. If a VSWR limit value is already activated, the VSWR LIMIT softkey label is highlighted in green.

- To enter a VSWR limit value or to activate the available limit value, press the VSWR LIMIT key.
- Change the displayed VSWR limit value to the desired value by using the rotary knob, or enter a new limit value by using the numeric keys.
- Press the ENTER key to complete the entry.

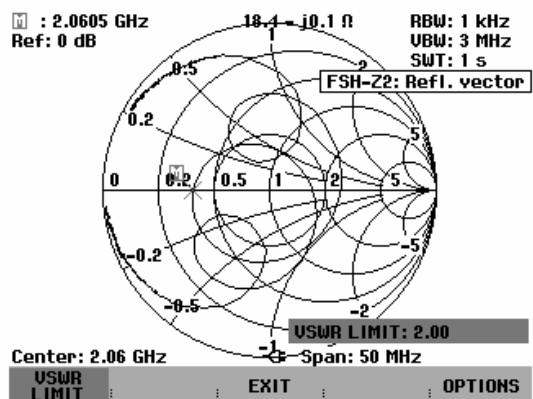

To deactivate the VSWR limit value:

- If starting from the main menu for the tracking generator, press the MEAS key. If starting from any other menu, press the MEAS key twice.
- Press the LIMIT LINES softkey.

The VSWR LIMIT softkey label is highlighted in green.

- Press the LIMIT LINES softkey twice.

The VSWR limit value is now deactivated.

As with limit value lines in scalar diagrams, the R&S FSH also offers automatic monitoring of limit values in Smith charts. If the entire impedance trace falls within the VSWR circle, the R&S FSH returns PASS after each sweep. If part of the trace falls outside the circle, FAIL is returned.

Limit value monitoring can be configured by using the OPTIONS softkey from the LIMIT LINES menu (see section "Using Limit Lines").

Zooming in on parts of the Smith chart:

To gain a better look at the measurement results, you can use the zoom function to enlarge any part of the Smith chart.

To activate the zoom function:

- Press the TRACE key.
- Press the ZOOM softkey.

The R&S FSH will display the menu for the zoom function, and a zoom window will appear in the Smith chart. You can change this window's size (zoom factor of 2, 4, or 8) and position.

To deactivate the zoom function:

- Press the EXIT softkey.

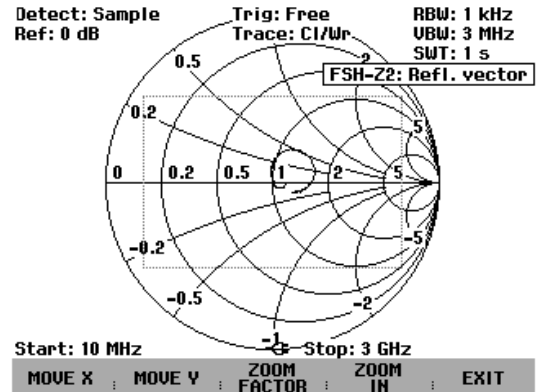
**To define the zoom area:**

Use the zoom factor to define the size of the zoom window or the zoom factor.

- Press the ZOOM FACTOR softkey.
- Select the desired zoom factor (2, 4 or 8) by using the rotary knob or cursor keys, or by entering a numeric value.
- Confirm the selection with the ENTER key or the ZOOM FACTOR softkey.

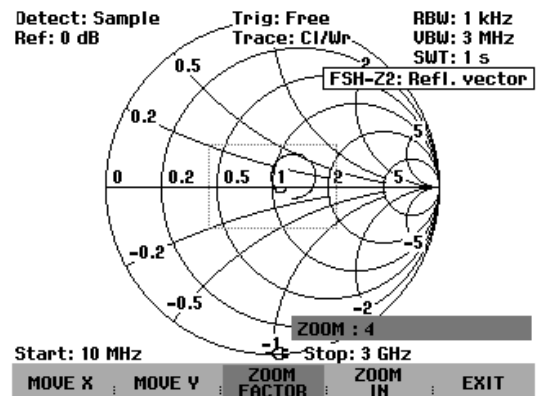
**To shift the zoom window:**

The reference point for shifting the zoom window in the x/y direction is the center of the Smith chart and the center of the zoom window. The shift value is specified as a percentage and ranges from -50% to +50% for the x and y directions. The equation $x = y = 0\%$ corresponds to the center of the Smith chart.

To shift in the x direction:

- Press the MOVE X softkey.
- Set a value from -50% to +50% by using the rotary knob or cursor keys or by entering a numeric value.
- Confirm the selection with the ENTER key or the MOVE X softkey.

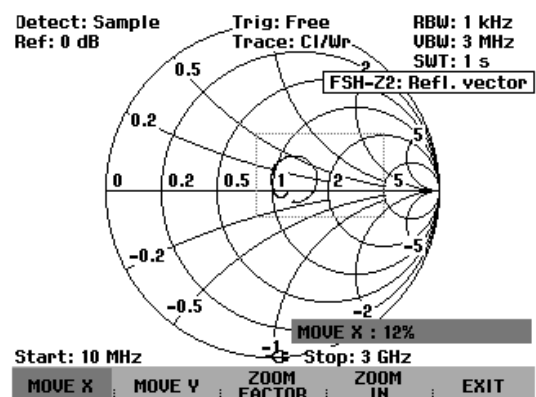

To shift in the y direction:

- Press the MOVE Y softkey.
- Set a value from -50% to +50% by using the rotary knob or cursor keys or by entering a numeric value.
- Confirm the selection with the ENTER key or the MOVE Y softkey.

To enlarge an area:

- Press the ZOOM IN softkey.

The selected window area will be enlarged by the zoom factor that has been set. You can fine-adjust the zoom window by using the MOVE X and MOVE Y as described.

To deactivate enlargement:

- Press the ZOOM OUT key.

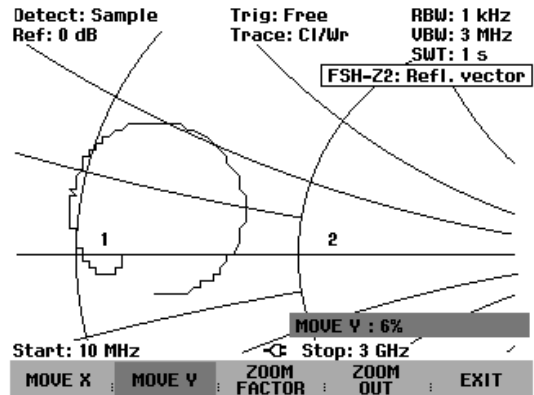

Spectrum measurements with the VSWR Bridge R&S FSH-Z3 or R&S FSH-Z2 connected

To localize interfering signals that can affect the reflection measurement on an antenna, for example, it is useful to switch to the spectrum display. To eliminate having to dismount the VSWR bridge each time, a typical value for the insertion loss of the VSWR bridge is incorporated in the measurement. This corrective step requires that the control cable for detecting the bridge be connected to the R&S FSH. Since the value is merely a typical frequency-independent correction value, an additional level measurement uncertainty of max. 2 dB must be anticipated.

Operation:

- Press the MEAS key.
- Select the MEASURE softkey.
- Select ANALYZER from the menu by using the rotary knob or the cursor keys.

As soon as the control cable has been connected to the R&S FSH, the VSWR Bridge R&S FSH-Z3 or R&S FSH-Z2 is automatically detected and indicated both on the display and the status menu. Automatic detection requires that this feature be activated in the SETUP menu (default setting).

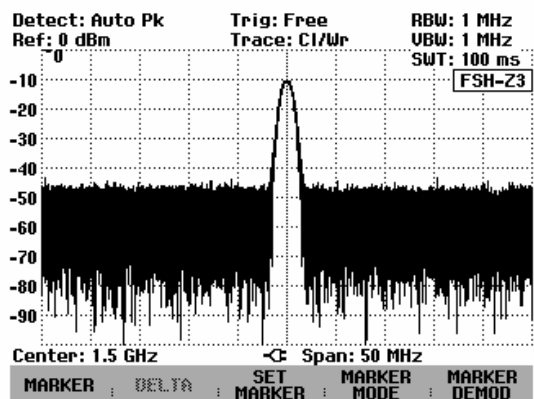

Settings for detection of the R&S FSH-Z2 and R&S FSH-Z3

Operation:

- Press the SETUP key.
- Select the HARDWARE SETUP softkey.
- Select ACCESSORY from the menu by using the rotary knob or the cursor keys and confirm the entry with the ENTER key.

The R&S FSH opens a menu where different modes for detecting the R&S FSH-Z2 or R&S FSH-Z3 VSWR bridge can be selected.

- Select AUTO DETECT or BRIDGE FSH-Z3 or BRIDGE FSH-Z2 from the menu by using the rotary knob or the cursor keys and confirm the entry with the HARDWARE SETUP softkey or the ENTER key.

If you select AUTO DETECT, the VSWR bridge is detected automatically as soon as the control cable has been connected to the probe power socket on the R&S FSH.

Note:

If you use the R&S FSH-Z2 bridge, removal of this VSWR bridge will not always be detected automatically. In this case, briefly change to another measurement function or the menu item NONE in order to update the instrument status.

If you select BRIDGE FSH-Z2/-Z3, the VSWR bridge is detected by default. This setting may be useful if you only work with the R&S FSH-Z2/-Z3 connected and do not want to waste time on automatic detection.

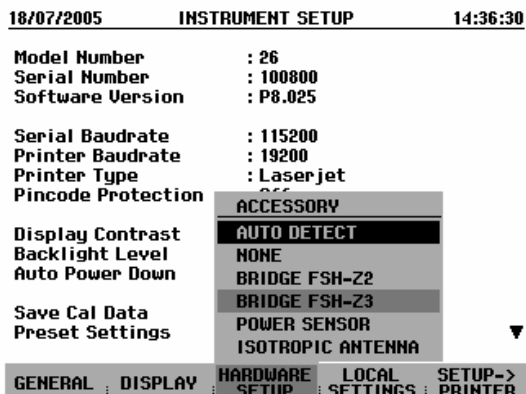

One-Port Measurement of Cable Loss

(Available only if the option R&S FSH-K2 is installed.)

When measuring return loss at the end of short-circuited or open-circuit cables, cable loss can be calculated on the basis of the following aspect: A short circuit or an open circuit at the end of the cable completely reflects the traversing wave. Since the wave traverses the cable twice, the returning wave at the measurement port of the bridge is attenuated by twice the amount of the cable loss. The level ratio of the received signal to the one fed to the cable is thus the same as twice the loss of the measured cable.

If the option R&S FSH-K2 is installed, the R&S FSH enables users to measure cable loss directly in accordance with the methods for return loss measurement without having to convert return loss to cable loss.

Operation:

- Connect the R&S FSH-Z2 or R&S FSH-Z3 bridge to the R&S FSH.
- Activate the TRACKING GEN mode on the R&S FSH (MEAS key, MEASURE: TRACKING GEN softkey).
- Set the required frequency range on the R&S FSH.
- Switch on vector measurement (MEAS key, MEAS MODE softkey, VECTOR menu item).
- Calibrate the R&S FSH (MEAS key, RELECT CAL softkey).
- Connect the cable to be measured to the measurement port of the bridge. The other end of the cable must be terminated with a short circuit or left open.

The R&S FSH shows the return loss of the cable.

- Press the MEAS MODE softkey.
- Using the rotary knob or the cursor keys, select CABLE LOSS from the menu.
- Confirm the selection with the ENTER key or the MEAS MODE softkey.

The R&S FSH will now display the measured cable loss in dB.

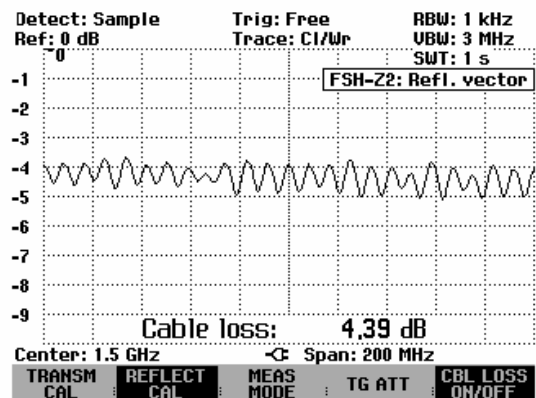

The R&S FSH calculates the cable loss from the average of the maximum and minimum values of the displayed trace. Thus, the cable loss is an average value within the displayed frequency range. Loss at specific frequencies can be determined with one or more markers.

Displaying the cable loss:

The R&S FSH displays the cable loss at the bottom of the measurement diagram (Cable loss = nn.nn dB). In most cases, the displayed information does not overlap the trace. However, if this does occur, you can hide the cable loss display by pressing the CBL LOSS ON/OFF softkey. If the softkey labeling has a green background, cable loss display is on.

Cable Measurements

(Only for R&S FSH with tracking generator (R&S FSH3 order No. 1145.5850.13 or 1145.5850.23, R&S FSH6 order No. 1145.5850.26) and with option R&S FSH-B1 (Distance-To-Fault Measurements) installed).

Measurements to determine the characteristics of cables to the antenna are key tasks when transmission equipment is being installed or maintained. Cable damage or bad connections have an adverse effect on the efficiency of the transmitter system. In conjunction with a tracking generator and the option "Distance-To-Fault Measurement" (DTF, R&S FSH-B1), the R&S FSH can locate cable faults and determine their distance from the measurement plane.

The only inputs required are the cable type and the approximate length. Using these parameters, the R&S FSH measures the distance to any faults and the degree of mismatch. It is easy to define the cable characteristics with the supplied "FSH View" software package and to transfer them to the R&S FSH. Up to 100 cable types can be stored by the R&S FSH.

The R&S FSH measures the sum of the tracking generator signal and the signal reflected by the cable under test in the frequency domain. Depending on the phase of the signal reflected at a fault relative to the generator signal there is either reinforcement or cancellation. Because of this effect there is ripple on the received sum signal in the frequency domain. The R&S FSH fast Fourier transforms the received signal to the time domain. Using the characteristic data of the cable under test, the R&S FSH directly calculates how far the reflections have travelled from the fault. The magnitude of the fault is given by the height of the reflection at a certain distance.

Test setup:

- Connect the cable of the VSWR Bridge R&S FSH-Z2 or R&S FSH-Z3 to the power sensor input on the R&S FSH.

Note: Supplying DC voltage to active DUTS: If the cable to be evaluated contains additional amplifiers, you can supply them with DC voltage via the RF cable by using the bias tee integrated in the R&S FSH-Z3. The DC voltage is fed in from a suitable power supply (max. 300 mA/max. 50 V). For example, a tower-mounted amplifier (TMA) can be supplied with DC voltage in a mobile radio base station in this manner. This is done by applying a suitable voltage at the BIAS 1 BNC input of the VSWR bridge.

- Connect the bridge to the generator output and the RF input on the R&S FSH.
- Connect the cable supplied with option R&S FSH-B1 to the bridge input.

Note: For distance-to-fault measurements, a cable of one meter length must be connected to the test port of the R&S FSH-Z2 or R&S FSH-Z3. Results are invalid without this cable.

Calling the function:

- Press the MEAS key.
- Press the MEASURE softkey.

The measurement function submenu opens.

- Using the cursor keys or the rotary knob, select the DISTANCE TO FAULT menu item and confirm your selection with the ENTER key or the MEAS softkey.

The R&S FSH turns on the "Distance To Fault" measurement function.

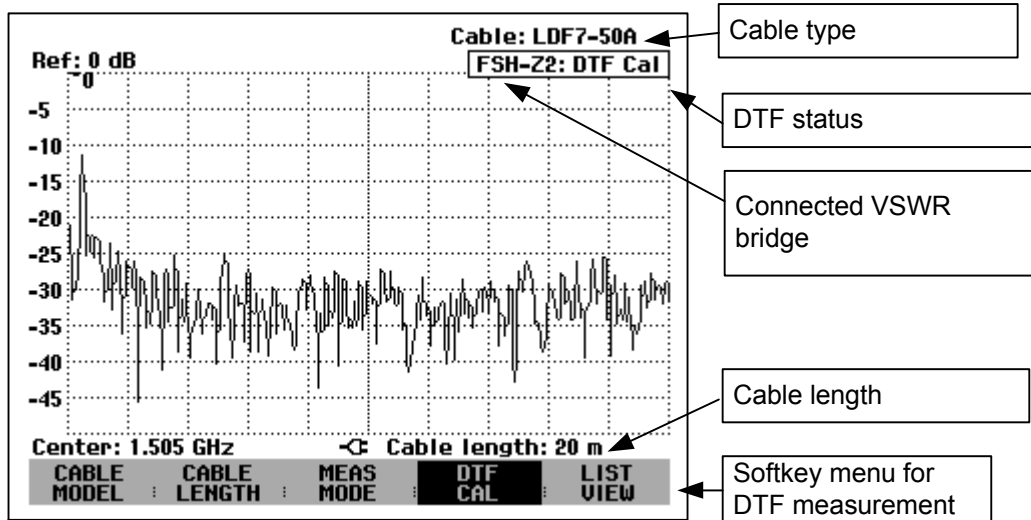
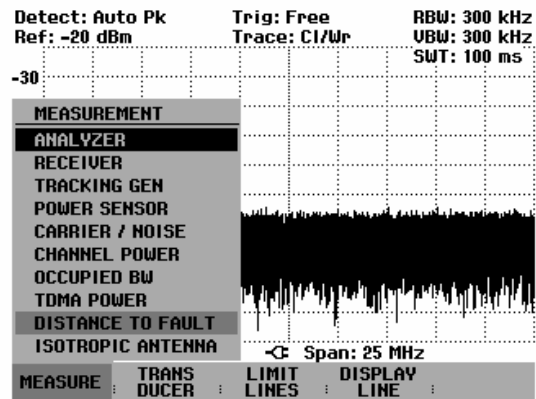

To perform distance-to-fault measurements, the R&S FSH needs to “know” the type of cable and its approximate length.

The cable type must be known to determine the speed of propagation and so the distance to any fault along the cable. The attenuation of the cable must be known to determine the size of the fault correctly. The R&S FSH automatically sets the span according to the approximate length of the cable.

Cable selection

Frequency-dependent cable models can be generated with the supplied R&S FSH View Windows software package and loaded into the R&S FSH. The procedure is described in the R&S FSH View manual. The R&S FSH can store up to 100 different cable types in its internal memory. The total number of storable limit lines, transducer factors and cable models is 100. If transducer factors, channel tables, limit lines or data sets are stored simultaneously, the maximum number of cable models decreases correspondingly (see "Saving and Loading Instrument Settings and Measurement Results" in this chapter).

Frequency-dependent cable models can also be defined directly on the R&S FSH in the corresponding menu. In this way, cable models not generated with R&S FSH View can be added.

If the distance to a cable fault is to be located precisely, it is essential to use the appropriate cable model. If not, the R&S FSH will not be able to correctly determine the distance of the fault from the measurement plane and the magnitude of the reflection at the fault.

Selecting a cable model from a predefined list:

- Press the CABLE MODEL softkey.

The R&S FSH displays the list of cable models.

- Using the rotary knob or the cursor keys, select the appropriate cable model.
- Using the softkey, activate the cable model you have selected.

The R&S FSH returns to the DTF measurement function and displays the cable used for the measurement in the top right-hand corner of the screen.

| 19/07/2003 | CABLE LIST | 12:36:25 |
|---------------|----------------------------|----------|
| RG8U | 18/12/2002 18:27:24 | |
| RG58C | 18/12/2002 18:27:24 | |
| RG223U | 18/12/2002 18:27:24 | |
| RG214 | 18/12/2002 18:27:24 | |
| RG213U | 18/12/2002 18:27:24 | |
| RG142 | 18/12/2002 18:27:24 | |
| RG141A | 18/12/2002 18:27:24 | |
| LMR900 | 18/12/2002 18:27:24 | |
| LMR600 | 18/12/2002 18:27:24 | |
| LMR1200 | 18/12/2002 18:27:24 | |

| | | | | |
|--------|-----------------|------|-----------------|----------------|
| SELECT | SELECT USER MOD | EXIT | DEFINE USER MOD | LIST-> PRINTER |
|--------|-----------------|------|-----------------|----------------|

Definition of cable parameters on the R&S FSH:

- Press the CABLE MODEL softkey.
- Press the SELECT USER MOD softkey.

The softkey is highlighted in green to indicate that a user-defined cable model has been selected. The cable model can be checked or modified using the DEFINE USER MOD softkey.

- Press the DEFINE USER MOD softkey.

A menu for entering the frequency, the velocity factor and the attenuation opens.

| 19/07/2003 | CABLE LIST | 14:39:17 |
|-------------|----------------------------|----------|
| RG8U | 18/12/2002 18:27:24 | |
| RG58C | 18/12/2002 18:27:24 | |
| RG223U | 18/12/2002 18:27:24 | |
| RG214 | 18/12/2002 18:27:24 | |
| RG213U | 18/12/2002 18:27:24 | |
| RG142 | 18/12/2002 18:27:24 | |
| RG141A | 18/12/2002 18:27:24 | |
| LMR900 | 18/12/2002 18:27:24 | |
| LMR600 | 18/12/2002 18:27:24 | |
| LMR1200 | 18/12/2002 18:27:24 | |

| |
|--------------------|
| FREQUENCY... |
| VELOCITY FACTOR... |
| ATTENUATION... |

| | | | | |
|--------|-----------------|------|-----------------|----------------|
| SELECT | SELECT USER MOD | EXIT | DEFINE USER MOD | LIST-> PRINTER |
|--------|-----------------|------|-----------------|----------------|

- Select FREQUENCY... and confirm with the ENTER key.

The current frequency is displayed in the value entry box.

- Confirm the frequency with the ENTER key or enter a new frequency.

FREQUENCY: 1.5 GHz

| | | | | |
|--------|-----------------|------|-----------------|----------------|
| SELECT | SELECT USER MOD | EXIT | DEFINE USER MOD | LIST-> PRINTER |
|--------|-----------------|------|-----------------|----------------|

- Press the DEFINE USER MOD softkey.
- Select VELOCITY FACTOR... and confirm with the ENTER key.

The current velocity factor is displayed in the value entry box.

- Confirm the current velocity factor with the ENTER key or enter a new velocity factor and confirm with the ENTER key or the DEFINE USER MOD softkey.

VELOCITY FACT: 0.880

| | | | | |
|--------|-----------------|------|-----------------|----------------|
| SELECT | SELECT USER MOD | EXIT | DEFINE USER MOD | LIST-> PRINTER |
|--------|-----------------|------|-----------------|----------------|

The velocity factor can be found, for example, in the manufacturer's data sheet for the cable in question.

- Press the DEFINE USER MOD softkey.
- Select ATTENUATION... and confirm with the ENTER key.

The current cable attenuation is displayed in the value entry box in dB/m or dB/ft, depending on the unit of length selected in the setup menu.

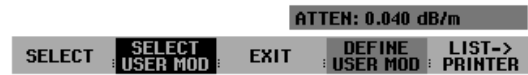

- Confirm the current cable attenuation with the ENTER key or enter a new cable attenuation and confirm with the ENTER key or the DEFINE USER MOD softkey.

The cable attenuation can be found, for example, in the manufacturer's data sheet for the cable in question.

Preselecting the cable length:

The R&S FSH uses the cable length to determine the optimal span for the measurement. The longer the cable under test is, the smaller the span used by the R&S FSH. The R&S FSH also calculates the cable attenuation from the selected cable model and the length setting so that the magnitude of the reflection at the fault is measured correctly. If the graphics display mode is selected for the results, the R&S FSH scales the x axis so that it represents the total length of the cable.

If the entered cable length is less than the actual cable length, the R&S FSH does not display the faults of the complete cable. A reflection at the end of the cable will not be shown. However, deliberately entering a cable length that is too short is a good way of increasing distance-to-fault accuracy for a fault that is near to the measurement plane. If the entered cable length is greater than the actual length, the measured values for lengths beyond the cable length are useless because they are caused by multiple reflections. If the length of the cable is not known precisely, it is best to enter a length that is about 20 % to 50 % greater than the best estimate of the cable length.

- Press the CABLE LENGTH softkey.

The R&S FSH opens the cable length (CABLE LEN) value entry box and displays the current length setting in meters or feet. The unit of length is selected by, and depends on, SETUP: LOCAL SETTINGS: UNIT OF LENGTH.

- Using the numeric keys, enter the cable length in meters and terminate the entry with the ENTER key or one of the unit keys, or
- Using the rotary knob (1 m steps) or the cursor keys (10 m steps) adjust the cable length.

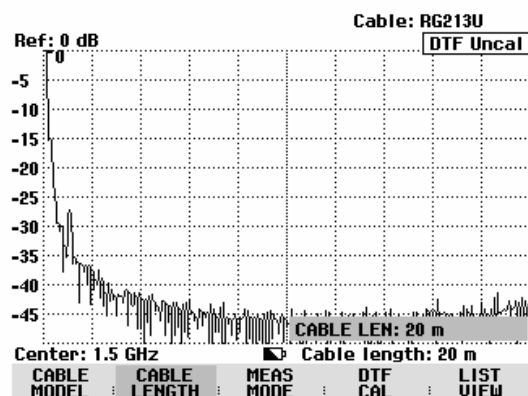

The minimum cable length is 3 meters or 10 feet. This value is determined by the maximum frequency range of the R&S FSH. A cable length of max. 1000 m can be entered. The maximum cable length that is suitable for measurements depends on the cable attenuation. Since the test signal must be twice routed through the cable, the signal reflected at the cable end arrives with twice the cable attenuation in attenuated form at the input of the power divider. Dynamic range decreases with increasing cable length.

If the cable attenuation exceeds 10 dB, the R&S FSH outputs a warning indicating that the cable attenuation is too high. It also indicates the maximum recommended cable length for obtaining accurate results.

Pressing CONTINUE accepts the entry.

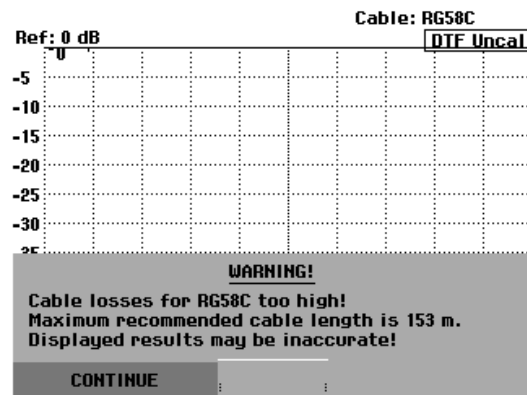

Selecting the frequency range

In the default setting, the R&S FSH automatically selects the frequency range around the set center frequency on the basis of the cable length and cable model. The R&S FSH selects a frequency range that enables maximum length resolution.

Particularly with relatively short cables, the frequency range in which the cable is specified may then be exceeded. Therefore, the R&S FSH allows the user to define the frequency range in which the distance-to-fault measurement is carried out. However, the length resolution of the measurement is reduced by using smaller frequency ranges.

When setting the frequency range, users are advised first to set the span and then the center frequency. This prevents a message from being output stating that the desired center frequency cannot be set for the span currently being used for the distance-to-fault measurement.

- Press the SPAN key.

The R&S FSH displays the span menu for the DTF measurement. If automatic setting of the span is selected, the AUTO SPAN softkey label is highlighted in green. If the AUTO SPAN softkey is pressed, the R&S FSH sets the span for the best length resolution. If the required span is too large for the current center frequency, the R&S FSH sets the center frequency to the smallest possible frequency.

- Press the MANUAL SPAN key.
- Set the required span by using either numeric entry, the cursor keys or the rotary knob.
- Confirm the setting with the ENTER key or by again pressing the MANUAL SPAN softkey again.

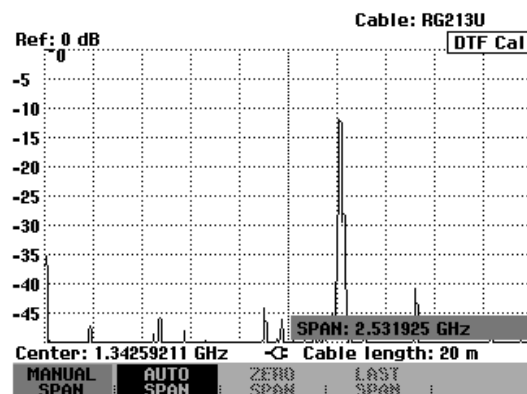

The minimum span that can be set is either 1/10 of the span automatically set by the R&S FSH in the case of AUTO SPAN or 200 MHz (whichever is smaller). Spans larger than the ones set by the R&S FSH with AUTO SPAN are not allowed. If an attempt is made to set smaller or larger spans, the R&S FSH responds with "Minimum reached" or "Range exceeded".

- Press the FREQ key.
- Using either the numeric keys, the cursor keys or the rotary knob, set the desired frequency.
- Confirm the entry with the ENTER key or the CENTER FREQ softkey.

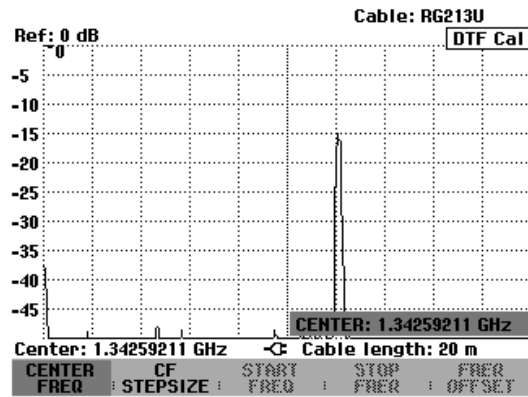

Calibrating the test setup

The test setup must be calibrated before any measurements are performed. To perform calibration, a SHORT is required at the output of the 1 m measurement cable. An OPEN can be used instead of a SHORT. However, if an OPEN is used, greater measurement uncertainties must be expected as an OPEN is not defined as precisely as a SHORT.

Note: The reference plane must be the output of the 1 m measurement cable; i.e. the measurement cable may not be dispensed with. If the output of the VSWR bridge is used as the reference plane, the DTF results are useless.

- Press the DTF CAL softkey.

The R&S FSH opens a text window which prompts the user to terminate the measurement cable with a SHORT.

- Firmly screw the SHORT to the output end of the measurement cable.
- Press the CONTINUE softkey to start the SHORT calibration.
- Calibration can be aborted by pressing CANCEL.

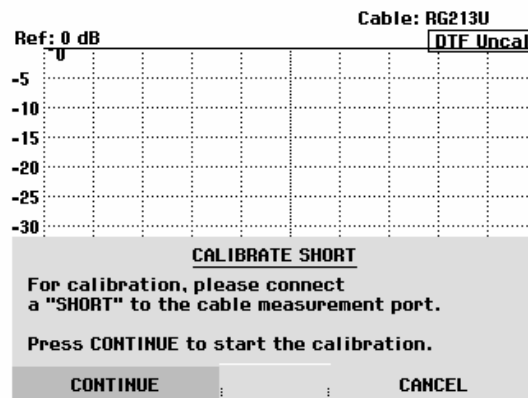

While SHORT calibration is in progress, the R&S FSH outputs the message "Calibrating SHORT, please wait...".

Calibration can be aborted with the CANCEL softkey.

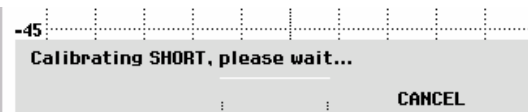

When calibration is over, the R&S FSH displays DTF CAL in the top right-hand corner of the screen. The REFLECT CAL softkey label is highlighted in green to indicate that calibration has been successfully completed.

The trace displays cable reflections versus distance from the measurement plane.

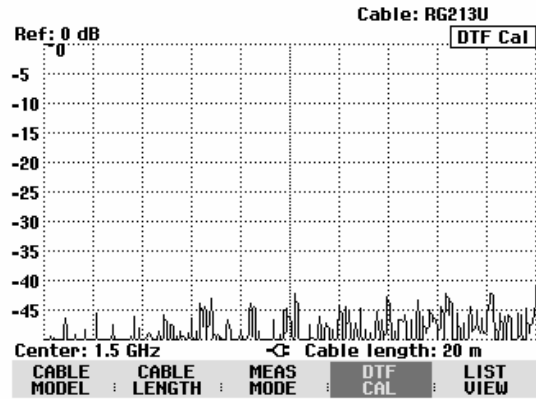

Note to Calibration:

Calibration is performed over the entire R&S FSH frequency range. This eliminates the need for recalibration when a different cable length is selected. The calibration data are saved in the R&S FSH's internal memory so that calibration remains effective when switchover is made to another operating mode or the instrument is switched off. As a precondition for calibration to remain valid, however, the instrument temperature must not change by more than 5 °C after calibration. If the temperature changes by more than 5 °C, a red circle is placed ahead of DTF CAL to indicate that there is a risk of increased measurement error. In such a case, it is advisable to recalibrate the test setup.

- Unscrew the SHORT from the measurement cable.
- Screw the cable under test to the measurement cable.

The R&S FSH displays the reflections produced in the cable under test. The measurement diagram on the right shows a cable that is approximately 15 m long and fitted with a connector 5 m from the start. The end of the cable is terminated with a 3 dB attenuator pad.

The R&S FSH shows that the return loss of the reflection from the termination at the end of the cable (approx. 157 m) is approx. 7 dB. The connector, for example, is the 20 dB peak at 5 m. On the extreme left of the trace, the matching of the connection to the cable under test can be seen.

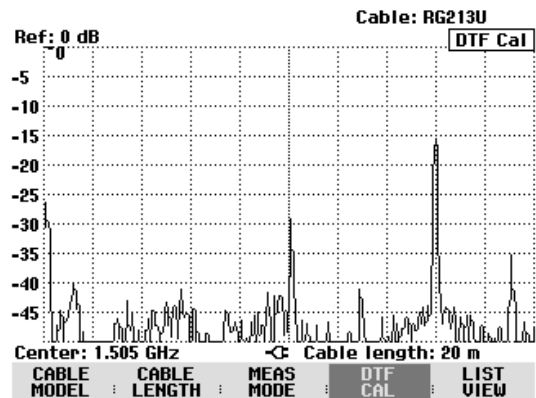

To select the display unit:

- Press the AMPT key.
- Press the RANGE softkey.

The R&S FSH will open the menu for selecting the display ranges. The following display units are available for distance-to-fault measurements: return loss in dB, linear in %, standing wave ration (VSWR), reflection coefficient (REFL COEFF (ROH)) and reflection coefficient (REFL COEFF (mROH)). Select the display unit you want by using the cursor keys or the rotary knob.

Note:

In the case of return loss and linear display, scaling is directly selected. In the case of all other units, a window for selecting the display range scaling opens. You can select a display range by using the cursor keys or the rotary knob.

Confirm the selection by pressing the ENTER key or the RANGE softkey.

The R&S FSH now shows a value such as the reflection coefficient of the measured cable over the cable length.

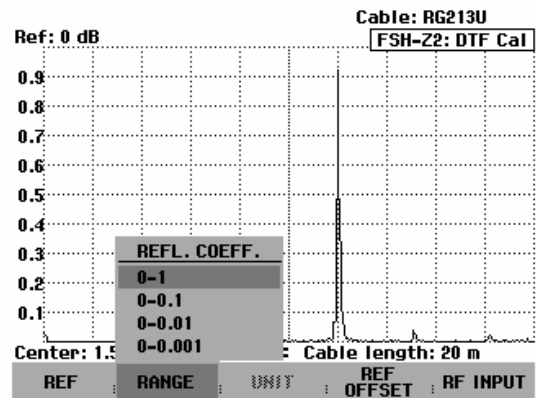
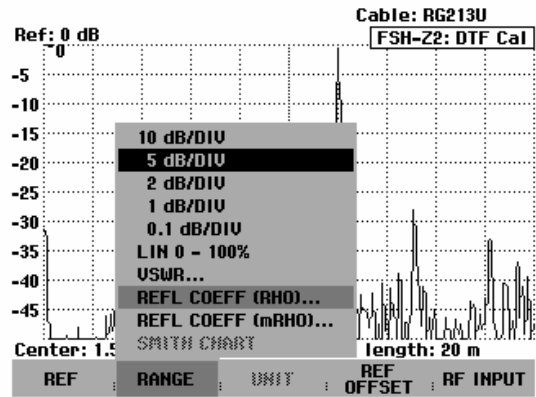

The R&S FSH can also list any cable faults. It displays the return loss and distance from the measurement plane of all reflections that exceed a settable threshold.

- Press the LIST VIEW softkey in the Distance to Fault menu.

The R&S FSH opens the threshold value entry box and also displays the threshold as a horizontal line across the measurement diagram.

- Set the threshold using the cursor keys (5 dB steps), the rotary knob (1 dB steps) or the number keys.

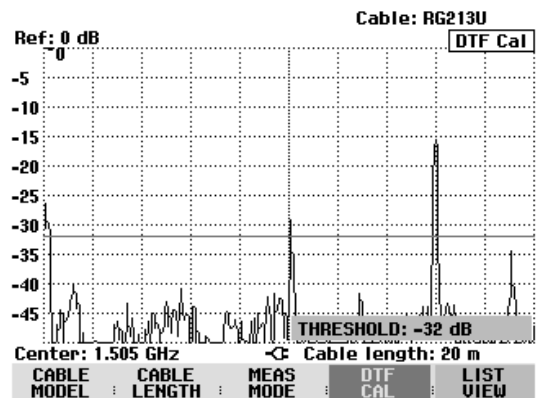

- Press the ENTER key or the LIST VIEW softkey again.

The R&S FSH displays a table listing all the reflections that are above the threshold sorted according to distance from the measurement plane.

| PEAK | DISTANCE | RETURN LOSS |
|------|----------|-------------|
| 1 | 10.07 m | -29.3 dB |
| 2 | 16.00 m | -15.6 dB |

- To change the threshold for the table display, press the THRESHOLD softkey and enter the new value.
- Use LIST->PRINTER to output the list to a printer.
- To close the list and to return to the graphics display mode, press the EXIT softkey.

| | |
|-------------------|--------------------|
| Center: 1.505 GHz | Cable length: 20 m |
| THRES | LIST-> |
| HOLD : | PRINTER : |
| | EXIT |

Locating cable faults by means of the marker function

The distance to cable faults or the distance between any two faults can also be read off with the marker.

- Press the MARKER key.

The R&S FSH opens the marker menu and places the marker on the fault with the largest reflection. The marker readout gives the distance of the fault from the measurement plane in meters and its return loss.

The marker that indicates the distance from the measurement plane is renamed the DISTANCE MARKER. It is activated for entry (DISTANCE value entry box).

- Change the distance marker by entering a number, adjusting the rotary knob (pixel by pixel) or by using the cursor keys (step = 10 % of the span).

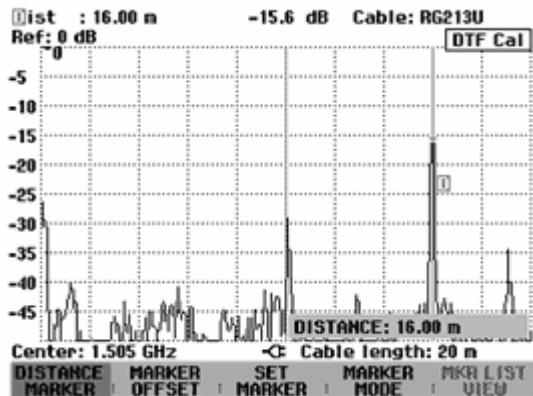

The reference plane to which the distance of a reflection is referred can be redefined using the marker offset.

- To define a new reference plane for the marker, press the MARKER OFFSET softkey.

The R&S FSH turns on the distance marker (OFFSET) and places it on the start of the trace. The offset marker readout box displays the distance from the measurement plane in meters and the return loss. The main marker (Dist) now gives the distance from the marker offset.

The marker readout label indicating the distance from the main marker is renamed the Offset. It is activated for an entry (OFFSET entry box).

- Change the offset marker by entering a number, adjusting the rotary knob (pixel by pixel) or by using the cursor keys (step = 10 % of the span).

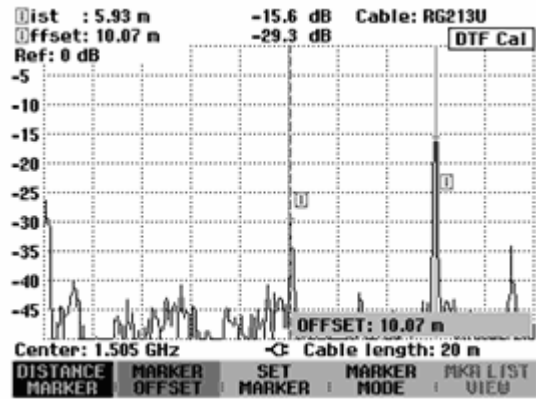

As is the case with spectrum analysis, the R&S FSH provides functions to automatically position the marker or the marker offset on the trace. These can all be accessed by pressing the SET MARKER softkey.

- Press the SET MARKER softkey.

The R&S FSH opens the submenu for automatically setting the active marker.

- Using the rotary knob or the cursor keys, select the menu item you want.
- Confirm your selection with the ENTER key or by pressing the SET MARKER softkey again.

The R&S FSH has the following functions:

- PEAK places the active marker on the highest reflection shown by the trace.
- NEXT PEAK places the active marker on the next highest reflection on the trace relative to the current position.
- MINIMUM places the active marker on the lowest reflection shown by the trace.

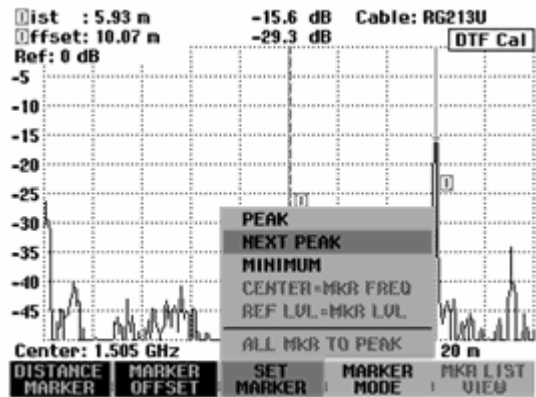

The resolution of cable faults can be increased by a zoom function. This is used primarily with long cables to better distinguish faults that are very close to each other.

- Set the marker on the cable fault to be examined.
- Press the MARKER MODE softkey.
- Using the rotary knob or the cursor keys, select the ZOOM ON menu item.
- Confirm with the ENTER key.

The R&S FSH zooms the display of the cable fault by the factor 2. The zoom factor is shown in the entry box (here, ZOOM FACTOR: 2).

- To zoom in on the fault even more, increase the zoom factor by turning the rotary knob or entering a higher value.

The permissible zoom factor depends on the selected cable length. The minimum span is 3 m.

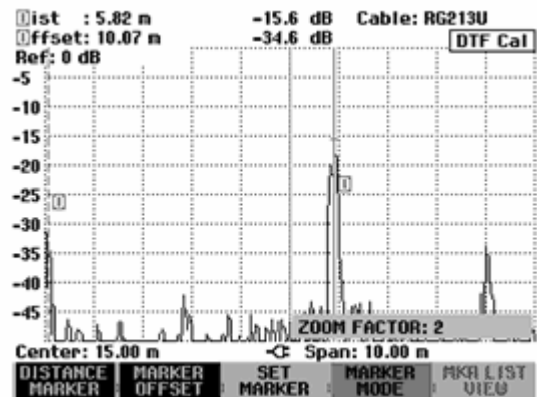

The screenshot on the right shows the fault from the preceding measurement zoomed by the factor 6. Faults mainly at the end of the cable can thus be clearly distinguished.

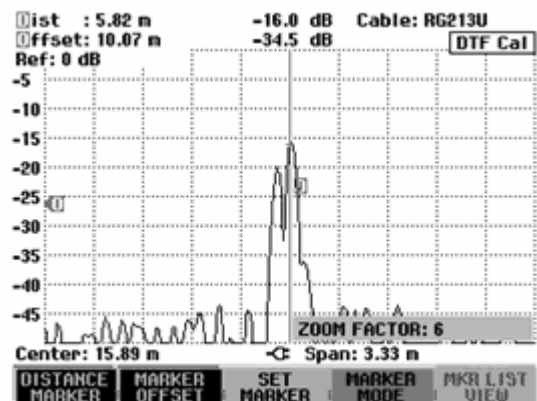

Switch the zoom function off as follows:

- Press the MARKER MODE softkey in the marker menu.
- Using the rotary knob or the cursor keys, select the ZOOM OFF menu item.
- Confirm with the ENTER key or by pressing the MARKER MODE softkey again.

Measurement of multiple cable faults using the multimarker function:

If several faults are detected in a cable, the position of each fault can be indicated by a separate marker (distance marker) by using the multimarker function.

- Press the MARKER MODE softkey.
- Using the rotary knob or the cursor keys, select the MULTIMARKER menu item.
- Confirm with the ENTER key or the MARKER MODE softkey.
- Press the DISTANCE MARKER softkey.

A menu with six markers opens.

The following options are possible:

- Select the highlighted marker as the active marker by pressing the ENTER key.
- Select another marker by means of the rotary knob or the cursor keys and confirm your selection with the ENTER key.
- Activate ALL MARKERS ON by means of the rotary knob or the cursor keys. All markers are switched on and positioned on the highest values of the trace.

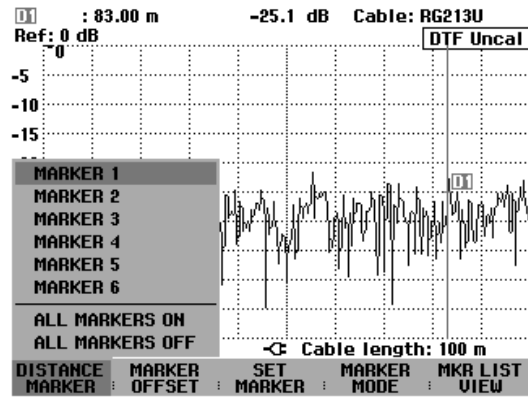

After a marker is activated, its position is indicated in the value entry box. To vary the marker position, use the number keys to enter a distance (e.g. 11.5 m), or move the marker pixel by pixel with the rotary knob, or move it in steps of 10% of the displayed cable length by means of the cursor keys. For fast marker positioning, it is recommended that first coarse adjustment be performed with the cursor keys, and then fine adjustment with the rotary knob.

The value entry box for the marker position is closed when the marker position is confirmed with the ENTER key.

With the MARKER OFFSET function, a new reference plane can be defined for the distance-to-fault measurement. If a marker offset is defined, all distance values output by the R&S FSH are referenced to the position of the offset marker.

Automatic marker positioning (PEAK, NEXT PEAK, MINIMUM) is always performed on the active marker. The active marker is indicated ahead of the selected function (example: D1: PEAK). The zoom function, too, acts on the active marker.

Measuring spectrum and reflection

Apart from distance-to-fault measurements for cables, the R&S FSH also provides an overview measurement for the frequency spectrum and reflections using the same settings – for example the center frequency and span. The spectrum display mode is useful for detecting spurious signals. External signals, e.g. from other transmitters, affect distance-to-fault measurements as they are picked up at the R&S FSH's RF input and are superimposed on the measurement signal. Reflection measurements are useful, e.g. for checking the matching of an antenna connected to the cable.

- Press the MEAS MODE softkey.

The R&S FSH opens the submenu with the various measurement mode options.

- Select the mode you want using the rotary knob or the cursor keys.
- Confirm your selection by pressing the MEAS MODE softkey again or by pressing the ENTER key.

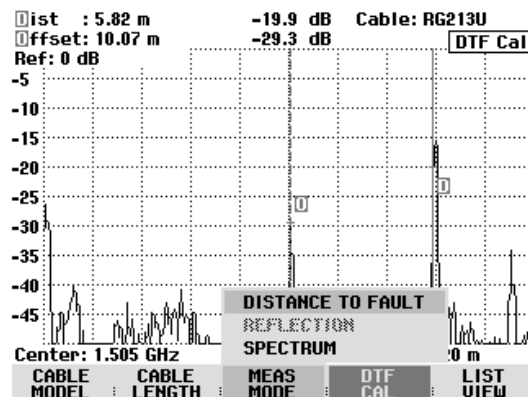

When SPECTRUM is selected, the R&S FSH turns off the tracking generator and displays the spectrum over the frequency range of the DTF measurement. To indicate that the R&S FSH is in the spectrum mode, DTF Spectrum is displayed in the top right-hand corner of the screen. Otherwise, the R&S FSH uses exactly the same settings as it did for DTF measurements.

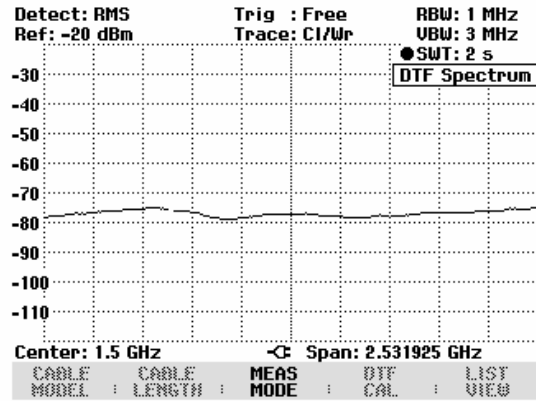

The spectrum mode is used to check if there are any spurious signals in the frequency range of the DTF measurement. These are most likely to be present if the cable under test is connected to an antenna.

When REFLECTION is selected, the R&S FSH measures the return loss over the frequency range which has been selected for the distance-to-fault measurement. This means, for example, an antenna can be matched without altering the test setup. The R&S FSH automatically switches the VSWR Bridge R&S FSH-Z2 or R&S FSH-Z3 to the VSWR measurement mode if REFLECTION has been selected.

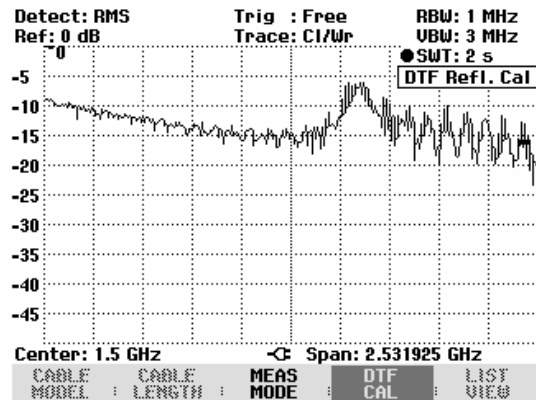

To indicate that the R&S FSH is measuring return loss, DTF refl. cal is displayed in the top right-hand corner of the screen.

Further information

Setting the span

If automatic setting (AUTO SPAN) is used, the R&S FSH automatically selects the span based on the cable length and cable model entered. The shorter the cable under test, the greater the selected span. If the center frequency is too high or too low for the cable length in question, the R&S FSH automatically adapts it to the required span.

The R&S FSH calculates the span from the cable length as follows:

$$\text{Span} = 1023 \cdot \frac{c_0 \cdot v_r}{2 \cdot \text{CL}} \cdot \frac{1024}{2048},$$

where

- c_0 = velocity of light
- v_r = velocity factor of cable
- CL = cable length
- 1024 = number of pixels calculated
- 2048 = number of pixels included in inverse Fourier transform

If, in the case of short cable lengths, the 3 GHz frequency range of the R&S FSH is not sufficient to set the span obtained with the above formula, the number of pixels calculated for displaying distance to fault is reduced accordingly.

If the span is set manually, the R&S FSH calculates 1024 points as in automatic setting. Since, however, not all 1024 points are valid owing to the restricted frequency range, the R&S FSH displays

only as many points as permitted by the span that has been set. Thus, the length resolution decreases and the span is reduced.

The following two screenshots show the measurements of the faults of a 22 m cable at a set cable length of 25 meters, measured once with automatic setting of the span and once with the span reduced to 400 MHz. Both measurements clearly show the cable coupling used at 12 m and the end of the cable which has a 50 Ω termination.

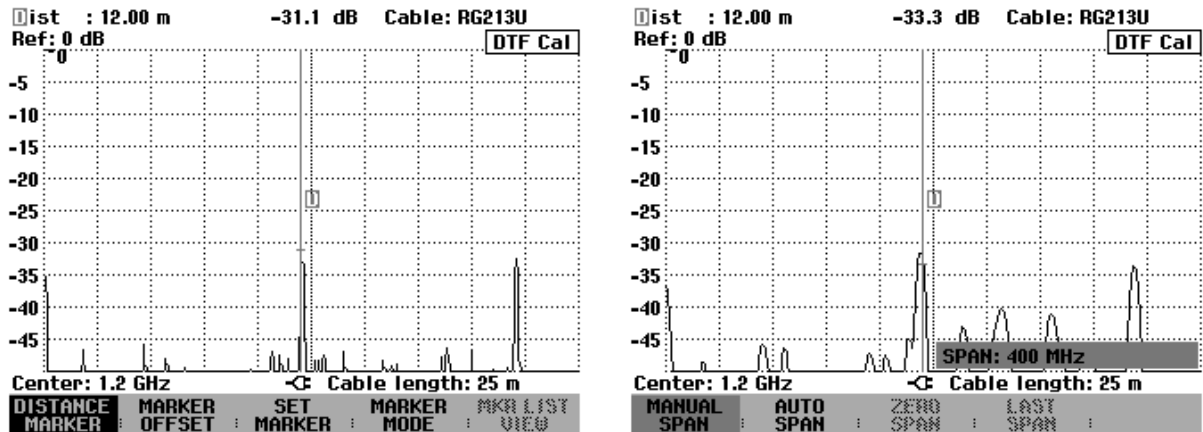

Measurement with automatic setting of the span (span = 2.025 GHz) Measurement with 400 MHz span

The trace on the right shows the fault location at the end of the cable clearly wider than the left one which was measured with optimum span. The reason is the reduced number of points in the calculation with reduced span. The points in reduced span are calculated using the following formula:

$$N = \frac{\text{SPAN}}{\text{AUTOSPAN}} \cdot 1024,$$

where

N = number of measurement points

SPAN = manually set span

AUTOSPAN = span used by the R&S FSH in automatic setting of the span

In the above measurement example, the resolution is thus 202 points for a cable length of 25 m, i.e. the distance is approx. 12.4 cm between the two measurement points.

Selecting the center frequency

The R&S FSH's center frequency should be as close to the cable under test's operating frequency as possible (for example the transmission frequency of the antenna connected to the cable). Cable attenuation increases with increasing frequency. This means that both the incident wave and the reflected wave from the end of the cable or at any faults is attenuated more at higher frequencies. This restricts the dynamic range at higher center frequencies. Therefore, never select a center frequency that is higher than necessary.

In the case of short cable lengths and automatic setting of the span, the R&S FSH uses its entire frequency range for the measurement. It automatically uses 1.505 GHz as the center frequency.

After the span is reduced, the R&S FSH can be set to the desired center frequency.

Measurement

The R&S FSH performs a sweep over 1024 test points to measure the sum signal of forward and reflected waveform. It transforms the sum signal in the frequency domain into the time domain by means of the inverse FFT (IFFT). The IFFT has a length of 2048 points. The data set is zero-padded to 2048 points and evaluated by means of a Hamming window before performing the IFFT. The R&S FSH corrects the result of the IFFT by using the correction values from calibration.

It then calculates the IFFT result into length units from the cable parameters, light velocity and frequency range. In addition, the R&S FSH considers the attenuation of the cable to be measured in order to display the discontinuities with correct level.

Length measurement accuracy

The length measurement accuracy is primarily determined by the deviation of the cable data of the cable model from the real cable data. Depending on the cable, the data may exhibit a tolerance of up to 10 %. This deviation directly affects the measurement error. A second factor of influence is the display resolution of the R&S FSH. Its uncertainty is $\pm 1/2$ pixel or $1/2 \times (\text{length}/301)$.

- Depending on the application, press the UPPER LIMIT or LOWER LIMIT softkey.

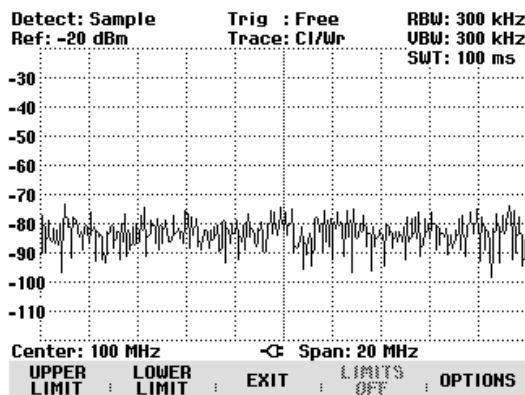

The R&S FSH displays a list of available limit lines. If no limit line is switched on, the first value in the list is marked. If a limit line has been switched on, the cursor is on the selected item. If no limit lines are stored in the R&S FSH, NO LIMIT LINES is displayed.

The unit of the limit line and the unit currently set on the x axis must be identical. The domain is marked next to the line name in the list to indicate the unit of the individual limit lines.

- freq Frequency (spectrum measurements)
- time Time (zero span measurements)
- dist Distance (DTF = distance-to-fault measurements)

30/11/2002 UPPER LIMIT LIST 10:51:18

| PowerMask | freq | rel | dB |
|---------------|------|-----|--------|
| New abs | freq | abs | dB |
| New Line2 | freq | rel | dB |
| New Line | freq | rel | dB |
| Limit2 | freq | abs | dBm |
| Limit1 | freq | abs | dBm |
| FreqMask2 | freq | abs | dBm |
| Fieldstrength | freq | abs | dBµV/m |

SELECT : LIMIT : EXIT : LIST-> : PRINTER

It is also indicated whether the limit lines are assigned to absolute frequency, time or distance values (abs) or whether they are specified relative the center of the x axis (rel). In the last column, the unit used for the limit line is displayed.

Switching on a limit line:

- Select the desired limit line from the list by means of the cursor keys or the rotary knob.

If the selected limit line does not match the unit currently selected on the x axis, the message "The unit of the limit line doesn't match the unit of the measurement" is displayed on the R&S FSH. The limit line is not switched on.

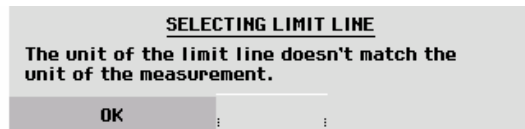

- Press SELECT to switch on the chosen limit line.

Switching off a limit line:

- Press the LIMIT OFF softkey to switch off the limit line.

Exiting the list of limit lines:

- Press the EXIT softkey to close the list of limit lines.

After a limit line has been switched on, the R&S FSH returns to the menu and the selected line is displayed in the diagram. The name and type of the limit line are also marked (UPPER for an upper limit line and LOWER for a lower line). To show which limit line is active, the respective softkey (UPPER LIMIT or LOWER LIMIT) is displayed in green.

If the limit line menu is quit with EXIT or with a key that opens another menu, the information on the limit line disappears. The name and type of active limit lines can thus be quickly viewed by calling the limit line menu.

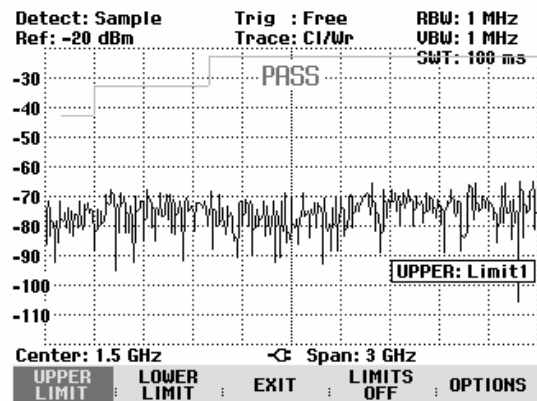

All active limit lines can be switched off together with the LIMITS OFF softkey.

Measurements with limit lines

During a measurement, the R&S FSH checks the trace after each frequency sweep for upper and lower limit violations. If all measured values are within specified limits, PASS is displayed at the top in the center of the diagram. FAIL is indicated even if only a single measured value (= pixel of the trace) exceeds a limit value. As long as a decision about limit violations cannot be made, e.g. because a sweep is not completed, "?" is displayed instead of PASS or FAIL.

The automatic limit check can be switched off in the OPTIONS menu. A limit violation can also be indicated by an acoustic signal.

PASS/FAIL information:

- Press the OPTIONS softkey.
- Select MESSAGE... with the rotary knob or the cursor keys.
- Select ON or OFF with the rotary knob or the cursor keys and confirm the selection with the OPTIONS softkey or with the ENTER key.

The R&S FSH switches the PASS/FAIL information in the diagram off or on.

Beep:

- Press the OPTIONS softkey.
- Select BEEP... with the rotary knob or the cursor keys.
- Select ON or OFF with the rotary knob or the cursor keys and confirm the selection with the OPTIONS softkey or with the ENTER key.

If BEEP has been selected, the R&S FSH outputs a beep each time a limit is exceeded.

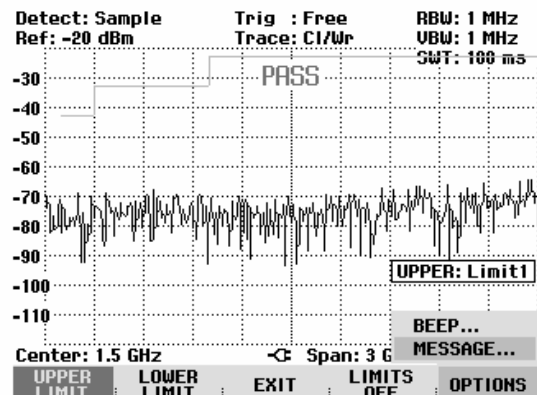

Definition range of limit lines

If a limit line is not defined in the entire frequency range or displayed span, a check is not performed outside the definition range.

Data sets containing limit lines

The R&S FSH stores data sets together with any limit lines that may have been active for the measurement in question. When such a data set is recalled, the associated limit lines are available too. They do however not appear in the list of limit lines.

Measuring with Transducer Factors

The frequency-dependent transducer factor of transducers and antennas can be directly considered in the measurement result. A transducer factor consists of a numeric values and a unit. The R&S FSH corrects the level values of the trace by the values of the transducer. At the same time, the unit of the transducer is assigned to the level axis. When field-strength measurements are performed with the aid of antennas, for instance, the electrical field strength is directly indicated in dB μ V/m on the R&S FSH. A transducer factor can also be used to correct a frequency-dependent attenuation, e.g. of a cable between DUT and RF input of the R&S FSH.

Up to 100 transducer factors with 60 reference values each can be stored internally. The maximum number of transducer factors may be reduced if cable models, channel tables, limit lines, or data sets are stored simultaneously (see "Saving and Loading Instrument Settings and Measurement Results" in this chapter).

Interpolation between the values is performed with the aid of a modified spline algorithm. Even if only relatively few values such as maxima, minima and turning points are available, this algorithm can easily simulate the correction factors of common transducers. Two transducers can be switched on at a time. The second transducer must be assigned the unit dB. The R&S FSH adds the two transducers to a total transducer.

Transducer factors are defined with the aid of control software FSH View. They are transferred from the PC to the instrument via the optical RS-232-C interface.

Units supported for transducer factors:

- dB
- dB μ V/m
- dB μ A/m
- W/m²

The unit dB does not change the unit set on the R&S FSH. It can be used, for instance, to compensate for frequency-dependent loss and gain at the input of the R&S FSH. The units dB μ V/m and dB μ A/m convert the output power of an antenna into electric or magnetic field strength. The unit W/m² is used to calculate and display the power flux density.

For example, to compensate for the cable loss between the transducer and the RF input, the R&S FSH can use two transducers at the same time. One of them must have the unit dB, however, i.e. it must correspond to one loss or gain value.

Operating sequence:

- Press the MEAS key.
- Press the TRANSDUCER softkey.

The softkey menu for operation of transducer factors is displayed on the screen.

N.B: Transducer factors are not available for measurements with the tracking generator and the Power Sensor R&S FSH-Z1. The TRANSDUCER softkey is therefore interactive.

Two transducer factors can be switched on with the TRANSD and TRANSD dB softkeys. With EXIT the transducer menu can be quit; with TRD'S OFF all transducer factors can be switched off.

- Press the TRANSD softkey.

The R&S FSH displays a list of transducer factors available in the unit. The cursor is on the active transducer factor (line highlighted). If no transducer is active, the cursor is on the first item in the list.

- Select the desired transducer factor with the rotary knob or the cursor keys and switch it on with the SELECT softkey.
- Switch off an active transducer factor with the TRANSD OFF softkey

or

- Quit the transducer menu with the EXIT softkey.

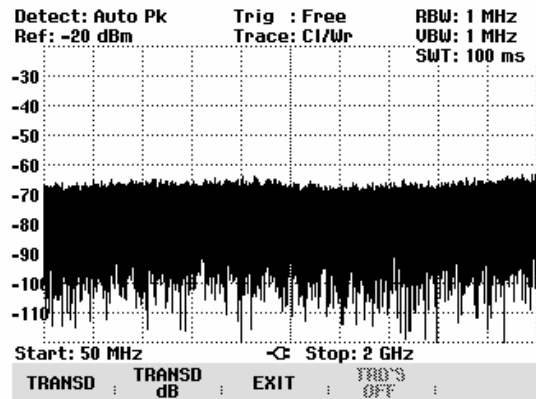

| 30/11/2002 | | TRANSDUCER LIST | | 10:09:19 |
|-----------------|--------|-----------------|----------|----------|
| RAM | dB | 30/10/2002 | 11:48:44 | |
| PreAmp | dB | 30/10/2002 | 11:48:44 | |
| HL223 | dBµV/m | 30/10/2002 | 11:48:44 | |
| HK116 | dBµV/m | 30/10/2002 | 11:48:44 | |
| HE200P-HF | dBµV/m | 30/10/2002 | 11:48:44 | |
| HE200P-500-3000 | dBµV/m | 30/10/2002 | 11:48:44 | |
| HE200P-200-500 | dBµV/m | 30/10/2002 | 11:48:44 | |
| HE200P-20-200 | dBµV/m | 30/10/2002 | 11:48:44 | |
| HE200A-HF | dBµV/m | 30/10/2002 | 11:48:44 | |
| HE200A-500-3000 | dBµV/m | 30/10/2002 | 11:48:44 | |
| HE200A-200-500 | dBµV/m | 30/10/2002 | 11:48:44 | |
| HE200A-20-200 | dBµV/m | 30/10/2002 | 11:48:44 | |
| CBL6111 | dBµV/m | 30/10/2002 | 11:48:42 | |

SELECT : TRANSD OFF : EXIT : LIST-> PRINTER

When LIST->PRINTER is pressed, the R&S FSH outputs the list of transducer factors to a printer.

Frequency range of transducer

If the set frequency range is wider than the span in which a transducer is defined, the R&S FSH assumes the transducer values outside the defined range to be zero.

Data sets containing transducer factors

The R&S FSH stores data sets together with any transducer factors that may have been active for the measurement in question. When such a data set is recalled, the associated transducer factor(s) are switched on as well. Transducer factors recalled as part of a data set do however not appear in the list of transducer factors.

Field-Strength Measurement with Isotropic Antenna

When used together with the R&S TS-EMF isotropic antenna (Order No. 1158.9295.13), the R&S FSH3 can determine the resultant field strength in the frequency range from 30 MHz to 3 GHz. The antenna has three orthogonal elements for measuring the resultant field strength. The R&S FSH triggers the three antenna elements one after the other via the probe power socket and calculates the resultant field strength (r = resultant field strength) E_r from the results of the three individual measurements:

$$E_r = \sqrt{E_x^2 + E_y^2 + E_z^2}$$

The transducer factors for each antenna element and the cable loss of the antenna cable are compensated in the measurement. If an extension cable such as the R&S TS-EMFZ2 (1166.5708.02) is used, the additional cable loss can be taken into account by using transducer factors. The transducer factors are antenna-specific and are supplied together with the TS-EMF antenna. Transducers are loaded into the R&S FSH by means of the R&S FSH View control software (see also "Measuring with Transducer Factors" in this chapter).

Connecting the antenna to the R&S FSH

The isotropic antenna includes factory-attached cables. The RF cable with the N coaxial plug is connected to the input of the R&S FSH. The control cable for switching between the X, Y and Z axes with the 9-pin D-Sub plug is connected with the R&S RSH probe power socket by using the supplied adapter cable.

- Press the MEAS key.
- Press the MEASURE softkey.

The R&S FSH will open the measurement function menu.

- Select ISOTROPIC ANTENNA with the cursor keys or rotary knob and confirm with the ENTER key or the MEAS softkey.

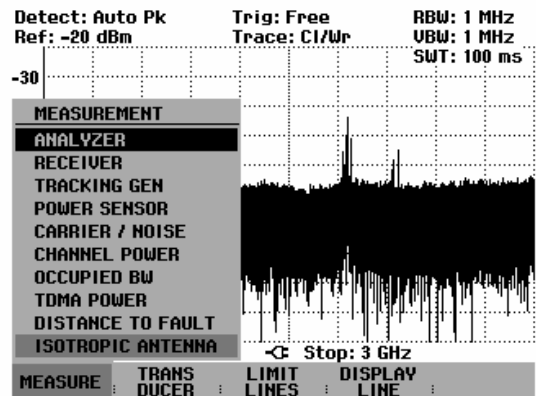

The R&S FSH will open the measurement function menu and activate the Isotropic Antenna measurement function. Before displaying final measurement results, the R&S FSH performs a measurement for each of the three antenna axes so that the update rate of the trace decreases accordingly.

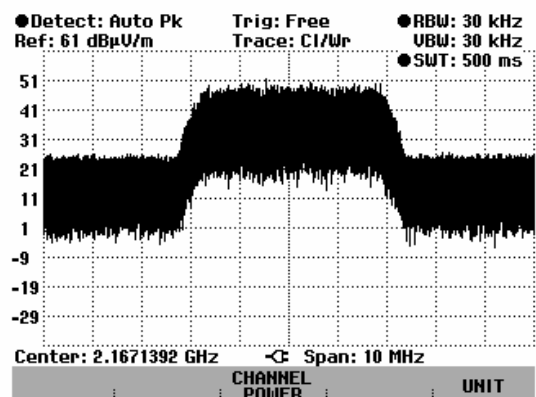

To use transducer factors for the isotropic antenna:

- Press the MEAS key.

The R&S FSH will display the softkey menu for controlling the transducer factors.

Note:

The TRANSD softkey enables you to activate the three transducer factors for the X, Y, and Z axes individually. The TRANSD dB softkey enables you to activate an additional transducer factor for compensating the antenna cable, which the R&S FSH adds to the measurement result. EXIT exits the transducer menu, and TRD'S OFF deactivate all transducer factors.

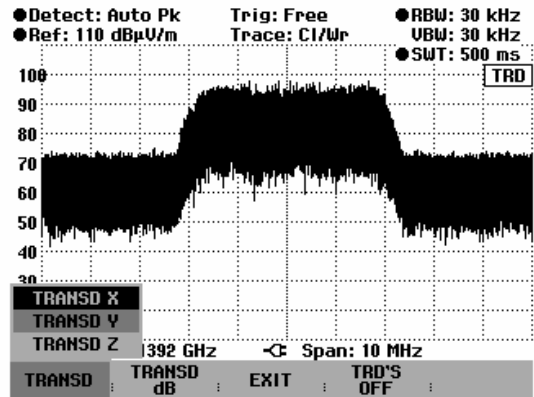

- Press the TRANSD softkey.

The R&S FSH will open the menu for selecting the transducers for the X, Y, and Z axes.

- Select an axis with the cursor keys or the rotary knob and confirm with the TRANSD softkey or the ENTER key. The highlighted row indicates which transducer factors are already activated.

The R&S FSH will display the list of transducer factors available in the instrument.

- Select the transducer factor associated with the previously selected axis by using the rotary knob or the cursor keys and activate with the SELECT softkey.
- Perform this same procedure for all three axes.

26/04/2005 TRANSDUCER LIST 13:20:24

| | | | |
|-----------------|--------|------------|----------|
| Z-Axis_D200002 | dBμV/m | 13/04/2005 | 14:07:30 |
| Y-Axis_D200002 | dBμV/m | 13/04/2005 | 14:07:18 |
| X-Axis_D200002 | dBμV/m | 13/04/2005 | 14:06:06 |
| HL223 | dBμV/m | 11/12/2002 | 12:29:20 |
| HK116 | dBμV/m | 11/12/2002 | 12:29:20 |
| HE200P-HF | dBμV/m | 11/12/2002 | 12:29:20 |
| HE200P-500-3000 | dBμV/m | 11/12/2002 | 12:29:20 |
| HE200P-200-500 | dBμV/m | 11/12/2002 | 12:29:20 |
| HE200P-20-200 | dBμV/m | 11/12/2002 | 12:29:20 |
| HE200A-HF | dBμV/m | 11/12/2002 | 12:29:20 |
| HE200A-500-3000 | dBμV/m | 11/12/2002 | 12:29:20 |
| HE200A-200-500 | dBμV/m | 11/12/2002 | 12:29:20 |
| HE200A-20-200 | dBμV/m | 11/12/2002 | 12:29:20 |
| CBL6111 | dBμV/m | 11/12/2002 | 12:29:20 |

SELECT TRANSD EXIT LIST->
 : OFF : : PRINTER

Do the following to compensate the antenna extension cable:

- Select the TRANSD dB softkey from the Transducer menu.

The R&S FSH will display the list of transducer factors available in the instrument with the unit dB.

- Select the appropriate transducer factor for the antenna by using the rotary knob or cursor keys and activate with the SELECT softkey.

The figure at the right shows a typical trace of the R&S TS-EMF antenna when transducer factors are activated. The antenna is defined between 30 MHz and 3 GHz. The R&S FSH displays the noise in this frequency range as a frequency-dependent value that is elevated by the antenna transducer factor. Outside the transducer range, the R&S FSH sets the antenna transducer factor to zero. Therefore, a measurement in this range does not yield useful results..

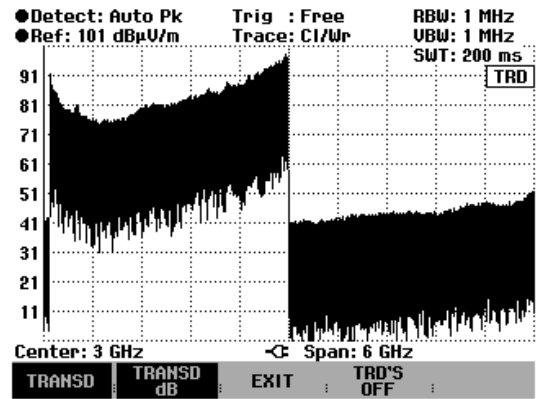

To enter the display unit:

- Press the UNIT softkey.
- Select the unit you want by using the rotary knob or cursor keys and confirm with the ENTER key.

The R&S FSH will display the selected unit of the resultant field strength. If you have selected W/m^2 the power flux density of the resultant field strength will be calculated and displayed.

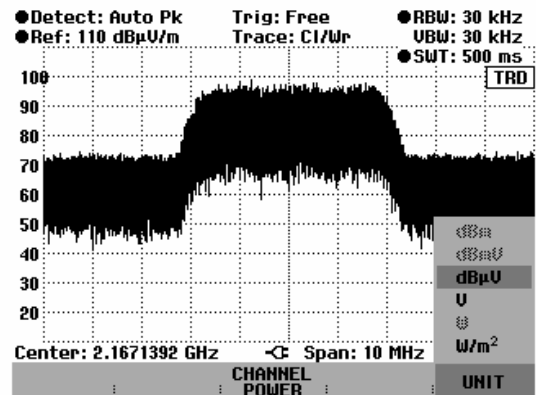

Measurement of the resultant field strength in a transmission channel with large bandwidth

To measure the resultant field strength in a transmission channel with large bandwidth, use the procedure for "measuring the channel power of continuously modulated signals" described in this chapter. Instead of the channel power, the R&S FSH will display the resultant field strength with inclusion of the antenna factors for the isotropic antenna.

The channel power measurement function allows you to selectively measure the resultant field strength of modulated signals by applying a high level of separation from adjacent signals. You can select the channel bandwidth, which also includes highly broadband signals.

When measuring the channel power, the R&S FSH measures the spectrum within the channel using a resolution bandwidth that is smaller than the channel bandwidth. It then integrates the measurement values of the trace for channel power. This procedure is repeated for each receive direction (x, y, z) of the isotropic antenna. The total power is determined from the three different channel powers, and it is then converted to the resultant field strength. In this process, the R&S FSH compensates the behavior of the type of display selected (linear or logarithmic), of the selected detected and of the resolution

bandwidth. By applying the narrow resolution bandwidth, it simulates a steep channel filter to prevent emissions from outside the channel from affecting the measurement result.

The R&S FSH offers default settings for the 3 GPP WCDMA, cdmaOne and CDMA2000 1x transmission systems that free you from having to enter analyzer settings. However, user-specific channel settings are also possible that adapt the R&S FSH to other transmission systems.

Operation:

- Press the CHANNEL POWER key.

The R&S FSH will open the measurement function menu.

- To exit the channel power menu, press the SPECTRUM softkey

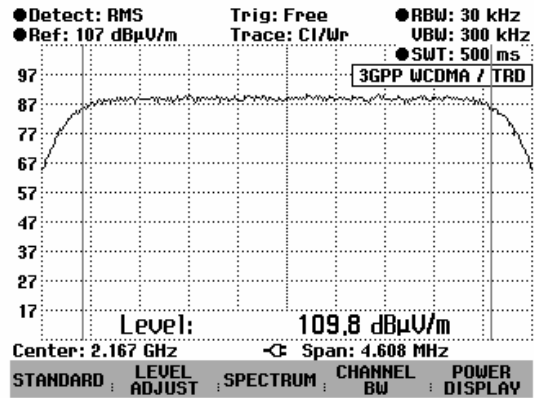

The R&S FSH will display the softkey menu for setting the channel power measurement. It indicates the channel bandwidth in the measurement diagram by means of two vertical lines. It displays the measured resultant field strength in large characters at the bottom of the diagram.

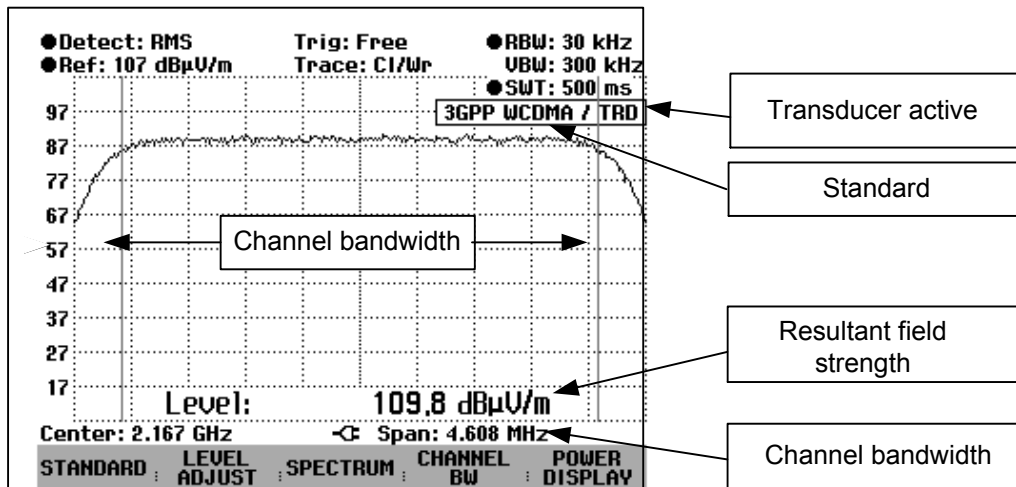

The default power measurement setting is for 3GPP WCDMA signals.

Selecting the standard:

The R&S FSH offers a default channel power measurement setting for various standards. In addition, you can define and store your own configuration.

- Press the STANDARD softkey.

The R&S FSH will open the table with available standards.

- Select the standard you want by using the rotary knob or the cursor keys.
- Confirm your selection with the ENTER key or the STANDARD softkey

The R&S FSH will set the selected standard. The parameters for frequency span, resolution bandwidth, video bandwidth, sweep time and detector will be set to the optimum values for the standard.

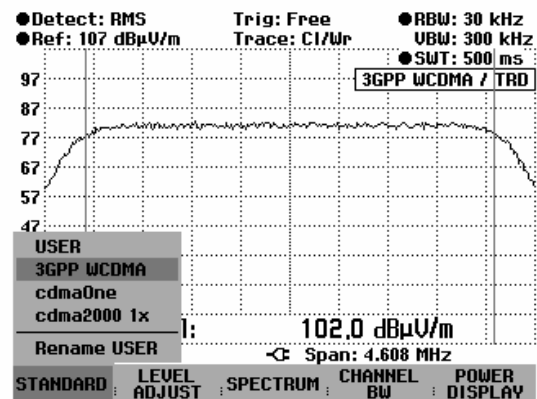

If you select USER, the R&S FSH will restore the channel power measurement setting last used with USER. It automatically incorporates changes in the settings so that they will also be available the next time the USER standard is called.

When changing settings, keep the following in mind:

- The span is always coupled with the channel bandwidth. If you change the bandwidth, the R&S FSH will automatically set the corresponding span.
- Select a resolution bandwidth that is between 1 % and 4 % of the channel bandwidth. This will ensure that the channel power measurement will be performed with good selection in reference to the adjacent channels.
- Select a video bandwidth that is at least three times as wide as the resolution bandwidth. This will keep the power measurement from being corrupted when signal peaks are compressed by the video filter.
- Use the RMS detector as the detector. This will ensure that the power and resultant field strength will always be measured correctly regardless of the signal waveform to be measured.
- Set a sweep time that yields a stable measurement result. If you increase the sweep time, the R&S FSH will also increase the integration time for the RMS detector, which also yields more stable measurement values.

Renaming the USER standards:

You can assign a user-defined name for the USER standard. This makes the standard being used by the R&S FSH immediately clear. The name entered for the USER standard will also appear on the screen, enabling you to document the setting when you document the measurement, for example.

- Press the STANDARD softkey.

The R&S FSH will open the table with the available standards.

- Select Rename USER with the rotary knob or the cursor keys.
- Confirm the selection with the ENTER key or the STANDARD softkey.

The R&S FSH will open the window for entering the name of the USER standard.

- Enter a name of your choice by using the numeric keys.
- Confirm the entry with the ENTER key.

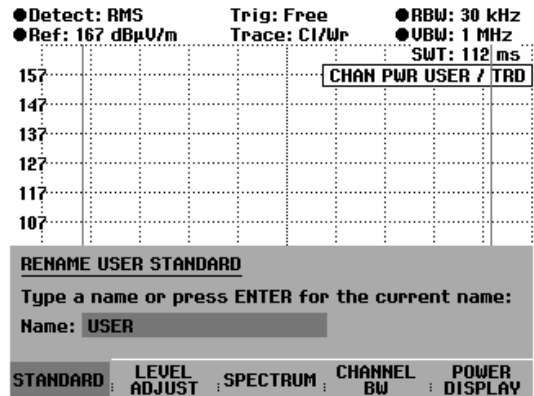

When you call the STANDARD menu, the name you entered will appear under USER, e.g. DAB (USER). The name will also appear in the upper right-hand corner of the screen after you select the USER standard.

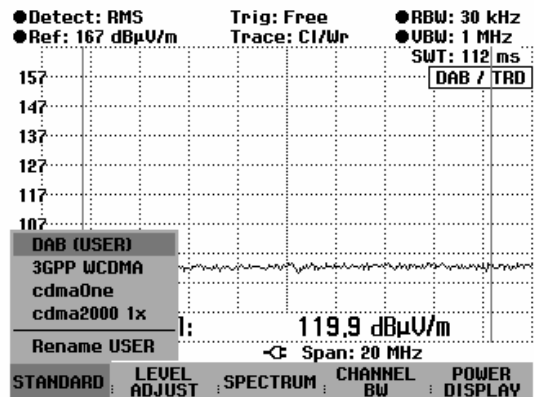

You can also create additional standards by using the R&S FSH View control software and load them into the R&S FSH. You can also use this software to delete factory-supplied standards if you do not need them. The R&S FSH will then offer only the standards you need, e.g. for measuring TV signals.

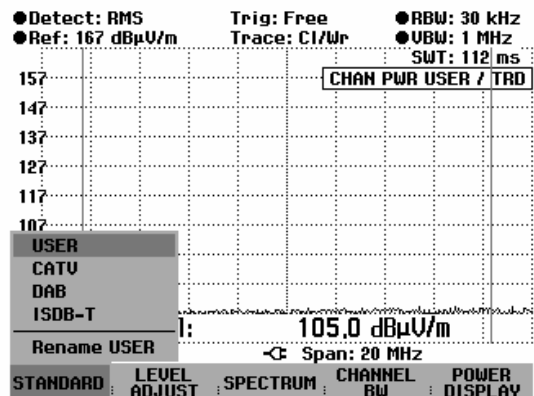

Setting the reference level:

When selecting the reference level, be sure not to overload the R&S FSH. Since the power is measured using a resolution bandwidth that is smaller than the signal bandwidth, the R&S FSH can be overloaded even though the trace is within the measurement diagram. To prevent overload from occurring, the signal can be measured using the largest possible resolution bandwidth and the peak detector. When this setting is used, the trace must not exceed the reference level.

To simplify operation and prevent measurement errors, the R&S FSH offers an automatic routine for setting the reference level.

- Press the LEVEL ADJUST softkey.

The R&S FSH will start the measurement of the optimum reference level using a resolution bandwidth of 1 MHz, a video bandwidth of 1 MHz and the peak detector. During the measurement, it displays the message "Please wait. Setting level for channel power measurement."

It will then set the optimum reference level.

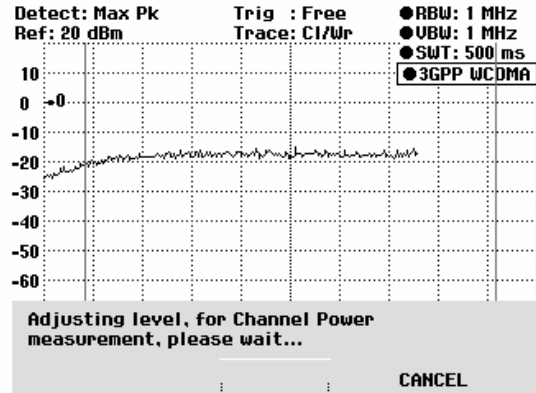

Setting the channel bandwidth:

The channel bandwidth is used to define the bandwidth in which the R&S FSH calculates the resultant field strength around the center frequency that has been set.

- Press the CHAN BW softkey.

The R&S FSH will open the entry field showing the channel bandwidth that is currently set.

- Enter a new channel bandwidth by using the numeric keys and confirm the entry with the unit you want, or
- Change the channel bandwidth by using the rotary knob or the cursor keys and confirm the entry with the ENTER key or the CHANNEL BW softkey.

The R&S FSH will automatically adapt the span to the entered channel bandwidth (span = 1.2 x channel bandwidth) so that the channel power will be measured correctly.

The minimum bandwidth that can be set is 8.33 kHz with R&S FSH3 models 1145.5850.03 and 1145.5850.13.

If you set a smaller bandwidth, the R&S FSH will set a frequency of 8.33 kHz and output the message "Range exceeded".

In the case of R&S FSH3 model 1145.5850.23 and the R&S FSH6, the minimum channel bandwidth is 833 Hz at a span of 1 kHz.

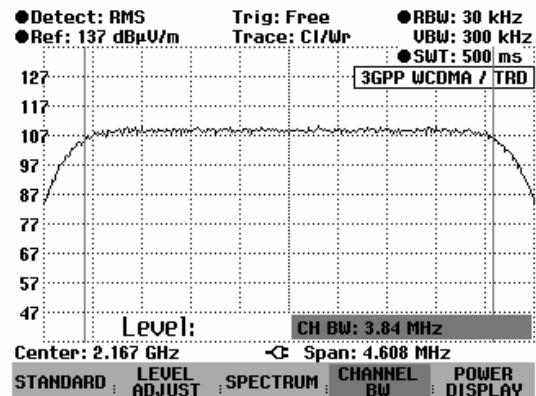

Changing the frequency span:

The frequency span set by the R&S FSH yields the most accurate measurement results. However, signals near the measurement channel will no longer be detected. To provide an overview of the spectrum outside the measurement channel, the frequency span can be changed up to a value ten times the channel bandwidth during the channel power measurement.

Operation:

- Press the SPAN key.

The AUTO SPAN softkey will have a green background to indicate that the optimum frequency range for the channel power measurement has been set. MANUAL SPAN input will be activated for immediately entering another frequency span.

- Enter a new frequency span by using the numeric keys and confirm the entry with the unit you want or
- Change the frequency span by using the rotary knob or cursor keys and confirm the entry with the ENTER key or the MANUAL SPAN softkey.

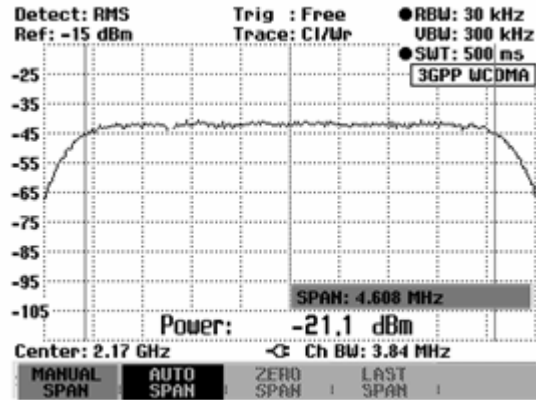

The largest span that is permitted in the channel power measurement is ten times the channel bandwidth. At larger spans, the result would be increasingly inaccurate, because not enough points of the trace are located in the channel to be measured.

- To reset the span to the optimum value, press the AUTO SPAN key.
- To return to the menu for channel power measurement, press the MEAS key and then the Channel Power softkey.

Measuring the maximum resultant field strength:

If signal levels fluctuate significantly, you can determine the maximum of the resultant field strength by using the Max Hold function.

Operation:

- Press the POWER DISPLAY softkey.
- Select the MAX HOLD function by using the cursor keys or the rotary knob and confirm with the POWER DISPLAY softkey or the ENTER key. The resultant field strength display will change from "Level" to "Max Level".
- To deactivate the MAX HOLD function, press the POWER DISPLAY softkey.
- Select the CLR/WRITE function by using the cursor keys or rotary knob and confirm with the POWER DISPLAY softkey or the ENTER key. The power display will change from "Max Level" to "Level".

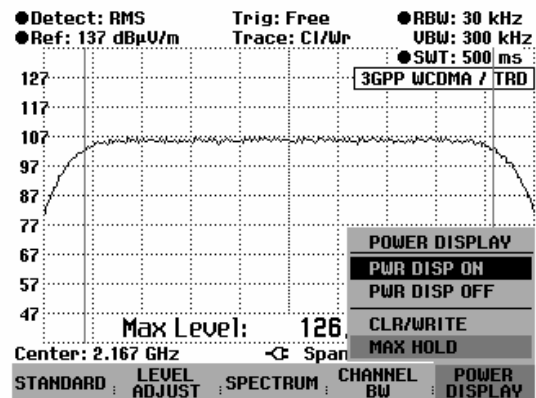

Displaying the resultant field strength:

The R&S FSH displays the resultant field strength at the bottom of the measurement diagram (Level = nn.nn dB μ V/m). It usually does not overlap the trace. However, if this occurs, you can hide the display.

Operation:

To deactivate the power display:

- Press the POWER DISPLAY softkey.
- Select PWR DISP OFF by using the rotary knob or cursor keys and confirm with the POWER DISPLAY softkey or the ENTER key.

To activate the power display:

- Press the POWER DISPLAY softkey.
- Select PWR DISP ON by using the rotary knob or cursor keys and confirm with the POWER DISPLAY softkey or the ENTER key.

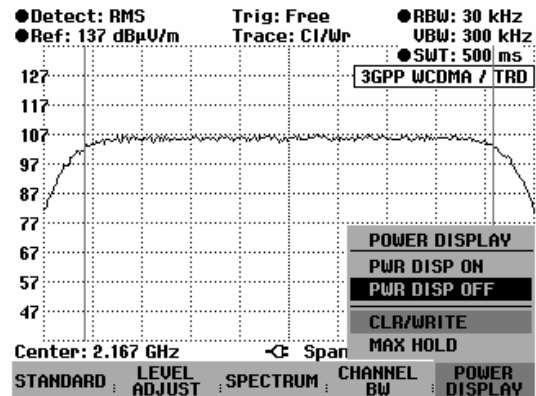
**Unit for displaying the resultant field strength:**

The R&S FSH can output the power in various units. The default unit is dB μ V.

- Press the SPECTRUM softkey.

The R&S FSH will return to the isotropic antenna menu.

- Press the UNIT softkey.
- Select the unit you want by using the rotary knob or the cursor keys.
- Confirm your selection with the ENTER key or the UNIT softkey.
- Press the CHANNEL POWER softkey.

The R&S FSH will show the selected unit for the resultant field strength. If you selected W/m², the power flux density will be calculated and displayed.

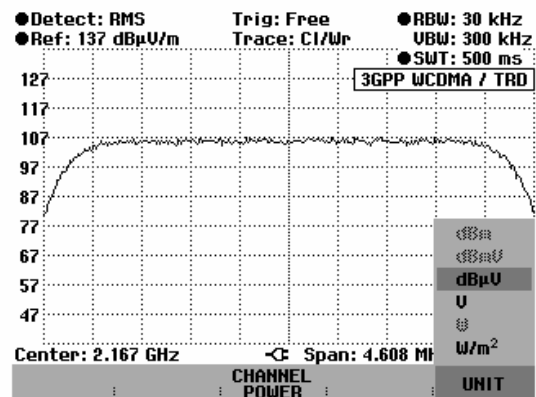

Code Domain Power Measurement on 3GPP FDD Signals

With the option R&S FSH-K4, the R&S FSH3 model 23 (serial number 103500 or later) allows you to perform the code domain power measurement in accordance with the 3GPP standard.

For analysis, a signal section of approx. 1.2 ms is recorded. In this signal section, the start of a WCDMA slot is searched for. If the start of such a slot is found in the signal, the CDP analysis for a slot is performed. The slot to be analyzed is selected at random. The number of the analyzed slot is indicated.

In addition to the total power for a slot, power is measured for the following channels:

- Common pilot channel (CPICH). This channel is definitely required in the channel configuration; otherwise no synchronization is possible.
- Primary common control physical channel (P-CCPCH).
- Primary synchronization channel (P-SCH).
- Secondary synchronization channel (S-SCH).

The Symbol EVM can be measured for the following channels:

- Common pilot channel (CPICH).
- Primary common control physical channel (P-CCPCH).

In addition, the carrier frequency error is measured. To obtain sufficient measurement accuracy, it is necessary to feed the reference frequency of the R&S FSH base station at the EXT REF IN input. See chapter 1 (External Reference / External Trigger Switchover).

Operation:

- Press the MEAS key.
- Press the MEASURE softkey.

The R&S FSH opens the menu with the measurement functions.

- Select the 3GPP BTS CDP menu item by using the rotary knob or the cursor keys.
- Confirm selection by using the ENTER key or the MEAS softkey.

Der R&S FSH displays the softkeys for setting the code domain power.

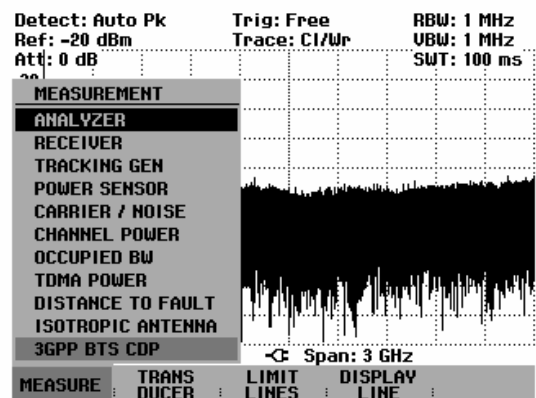

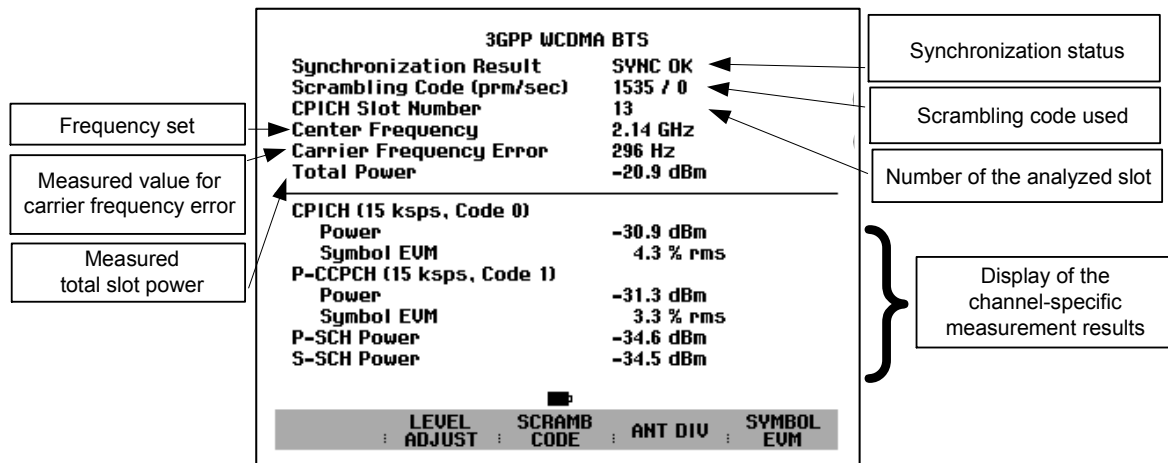

To simplify operation and to prevent incorrect measurements, the R&S FSH is equipped with an automatic routine for setting the reference level. After setting the carrier frequency to the 3GPP signal, you should first perform the level adjust.

- Press the LEVEL ADJUST softkey.

The R&S FSH determines the maximum in the time domain during the period of two slots by means of the peak detector. The optimum setting for the reference level is calculated and set on the basis of the maximum.

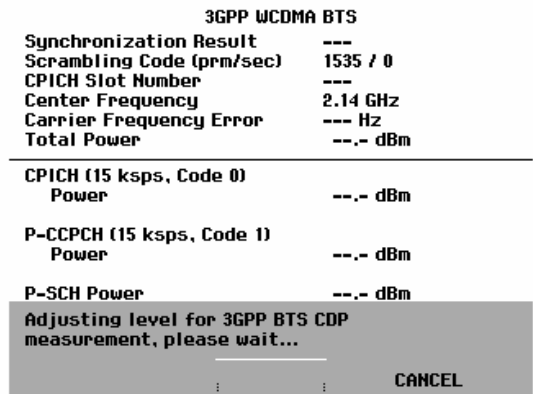

To demodulate the 3GPP signal, you must enter the scrambling codes (primary/secondary) of the base station.

Primary scrambling code entry:

- Press the SCRAMB CODE softkey.
- Select the PRIMARY SC... menu item by using the rotary knob or the cursor keys.
- Confirm selection with the ENTER key or the SCRAMB CODE softkey.

Der R&S FSH opens the entry window for the primary scrambling code. The code is entered in decimal format.

- Enter the primary scrambling code of the base station by using the numeric keys and terminate the entry with the ENTER key or SCRAMB CODE softkey.

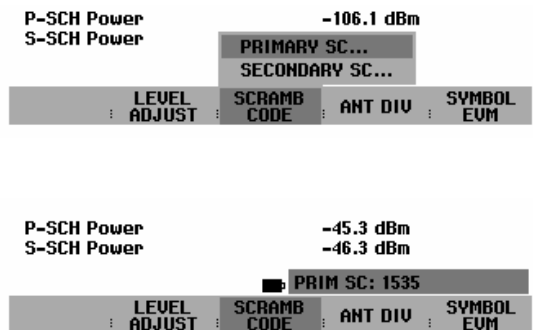

Secondary scrambling code entry:

- Press the SCRAMB CODE softkey.
- Select the SECONDARY SC... menu item by using the rotary knob or cursor keys.
- Confirm selection with the ENTER key SCRAMB CODE.

Der R&S FSH opens the entry window for the secondary scrambling code. The code is entered in decimal format.

- Enter the secondary scrambling code of the base station by using the numeric keys and terminate the entry with the ENTER key or SCRAMB CODE softkey. In most cases, you have to enter the value "0" for the secondary scrambling code.

After correct entry of the scrambling codes, frequency and reference level as well as correct selection of the antenna diversity (see below), the R&S FSH synchronizes to the 3GPP signal of the base station. SYNC OK is displayed on the screen and the measurement values are indicated.

| | | | |
|-----------------|-------------|---------|------------|
| P-SCH Power | -106.0 dBm | | |
| S-SCH Power | | | |
| PRIMARY SC... | | | |
| SECONDARY SC... | | | |
| LEVEL ADJUST | SCRAMB CODE | ANT DIV | SYMBOL EVM |
| P-SCH Power | -32.1 dBm | | |
| S-SCH Power | -36.0 dBm | | |
| SEC SC: 0 | | | |
| LEVEL ADJUST | SCRAMB CODE | ANT DIV | SYMBOL EVM |

| 3GPP WCDMA BTS | | | |
|---------------------------|-------------|---------|------------|
| Synchronization Result | SYNC OK | | |
| Scrambling Code (prm/sec) | 1535 / 0 | | |
| CPICH Slot Number | 9 | | |
| Center Frequency | 2.14 GHz | | |
| Carrier Frequency Error | 270 Hz | | |
| Total Power | -20.8 dBm | | |
| CPICH (15 ksps, Code 0) | | | |
| Power | -30.8 dBm | | |
| P-CCPCH (15 ksps, Code 1) | | | |
| Power | -31.4 dBm | | |
| P-SCH Power | | | |
| S-SCH Power | -33.2 dBm | | |
| | -30.5 dBm | | |
| LEVEL ADJUST | SCRAMB CODE | ANT DIV | SYMBOL EVM |

In the case of base stations with two antennas, you have to determine which antenna synchronization is to be performed. Base stations with only one antenna have the default setting OFF.

- Press the ANT DIV softkey.
- Select ANT DIV No. 1 (antenna 1) or ANT DIV No. 2 (antenne 2) by using the rotary knob or cursor keys.
- Confirm selection with the ENTER key or ANT DIV softkey.

The R&S FSH now synchronizes to the CPICH of antenna 1 or antenna 2 (prerequisite: reference level, frequency and scrambling code are set correctly).

- If only one antenna is available, press the ANT DIV softkey and select the ANT DIV OFF menu item by using the rotary knob or the cursor keys.
- Confirm selection with the ENTER key or the ANT DIV softkey.

| 3GPP WCDMA BTS | | | |
|---------------------------|-------------|---------|------------|
| Synchronization Result | SYNC OK | | |
| Scrambling Code (prm/sec) | 1535 / 0 | | |
| CPICH Slot Number | 12 | | |
| Center Frequency | 2.14 GHz | | |
| Carrier Frequency Error | 350 Hz | | |
| Total Power | -20.9 dBm | | |
| CPICH (15 ksps, Code 0) | | | |
| Power | -30.9 dBm | | |
| P-CCPCH (15 ksps, Code 1) | | | |
| Power | -31.3 dBm | | |
| P-SCH Power | | | |
| S-SCH Power | | | |
| ANT DIV OFF | | | |
| ANT DIV No. 1 | | | |
| ANT DIV No. 2 | | | |
| LEVEL ADJUST | SCRAMB CODE | ANT DIV | SYMBOL EVM |

Display of the Symbol EVM for the CPICH and P-CCPCH channels:

- Press the SYMBOL EVM softkey.
- Select the SYMBOL EVM ON menu item by using the rotary knob or the cursor keys.
- Confirm selection with the ENTER key or the SYMBOL EVM softkey.

The R&S FSH now displays also the Symbol EVM measurement values.

- To remove the SYMBOL EVM measurement values, press the SYMBOL EVM softkey and select the menu item SYMBOL EVM OFF by using the rotary knob or the cursor keys.
- Confirm selection with the ENTER key or the SYMBOL EVM softkey.

| 3GPP WCDMA BTS | |
|---------------------------|---|
| Synchronization Result | SYNC OK |
| Scrambling Code (prm/sec) | 1535 / 0 |
| CPICH Slot Number | 9 |
| Center Frequency | 2.14 GHz |
| Carrier Frequency Error | 286 Hz |
| Total Power | -20.8 dBm |
| <hr/> | |
| CPICH (15 ksps, Code 0) | |
| Power | -30.9 dBm |
| Symbol EVM | 6.7 % rms |
| P-CCPCH (15 ksps, Code 1) | |
| Power | -31.3 dBm |
| Symbol EVM | 2.3 % rms |
| P-SCH Power | -33.4 dBm |
| S-SCH Power | - |
| | <div style="border: 1px solid black; padding: 2px; display: inline-block;">SYMBOL EVM ON</div> <div style="border: 1px solid black; padding: 2px; display: inline-block;">SYMBOL EVM OFF</div> |
| ■ | |
| : LEVEL ADJUST : | : SCRAMB CODE : |
| : ANT DIV : | : SYMBOL EVM : |

Saving and Loading Instrument Settings and Measurement Results

The R&S FSH's settings and measurement results can be saved to the internal memory and recalled at a later date. Using the **R&S FSH View** software package, these data sets can also be saved to a PC from the R&S FSH or downloaded onto the R&S FSH from a PC.

Results and settings, including the measurement function, are always saved en bloc so that when the results are recalled the measurement context is clear. The R&S FSH can store a maximum of 256 data sets which are assigned a unique name.

Data sets for scalar transmission and reflection measurements can be stored along with their calibration data. When such data sets are recalled, therefore, measurements can be performed without prior calibration. Saving a data set with calibration data, however, requires twice as much memory space as without it, i.e. a data set with calibration data takes up the space required for two data sets without calibration data. This reduces the maximum number of data sets that can be stored by the number of data sets stored with calibration data.

Storage of calibration data can be selected in the SETUP menu (see Chapter 2, section "Saving Calibration Data").

If cable models, channel tables, limit lines or transducer factors are stored simultaneously, the maximum number of data sets will be reduced. In addition, the size of the data sets can vary as a function of the selected measurement function. The following table shows the storage space requirements for the various lists and data sets as well as the maximum or possible number allowed per data type.

| Type | Maximum number permitted or possible | Minimum storage space required (kB) | Maximum storage space required (kB) |
|---|--------------------------------------|-------------------------------------|-------------------------------------|
| Data set | 256 | 6 | 18 |
| Limit line | 100 | 2 | 2 |
| Transducer | 100 | 2 | 2 |
| Cable model | 100 | 2 | 2 |
| Channel table | 100 | 2 | 2 |
| User-defined standards for measuring channel power, occupied bandwidth and TDMA power | 5/5/5 | 2 | 2 |

The R&S FSH provides a total storage space of 2 MB. For example, if all lists with the maximum possible number are used, 121 data sets with a size of 10 kB can still be stored:

| Type | Number | Storage space required (kB) |
|---|--------|-----------------------------|
| Limit line | 100 | 200 |
| Transducer | 100 | 200 |
| Cable model | 100 | 200 |
| Channel table | 100 | 200 |
| User-defined standards for measuring channel power, occupied bandwidth and TDMA power | 5/5/5 | 30 |
| | | Total: 830 |

- Press the SAVE / PRINT key.

The R&S FSH opens the SAVE / PRINT menu where the functions for saving, clearing and loading data sets are displayed for selection.

A screenshot can also be output to a printer.

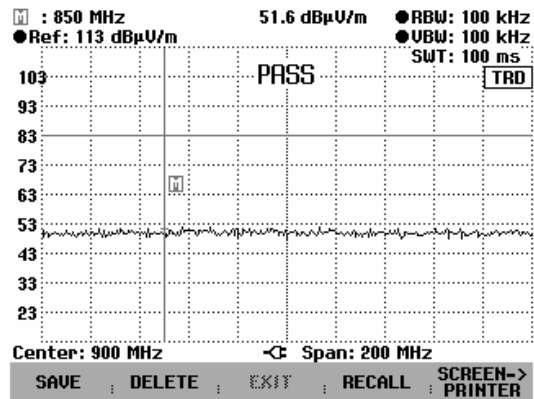

Saving results

- Press the SAVE softkey.

The R&S FSH opens a text box and prompts the user to enter a name for the data set.

The **Name** entry box, which is highlighted in red, also suggests a name for the data set (DATASET.000) which can be accepted by pressing the ENTER key.

For the sake of simplicity, the R&S FSH also saves the data set when the SAVE softkey under the suggested name is pressed twice.

The remaining *free memory* locations (**Free Locations**) are also displayed in the text box. Since the data sets can be different in size, the remaining storage space is indicated as a percentage value.

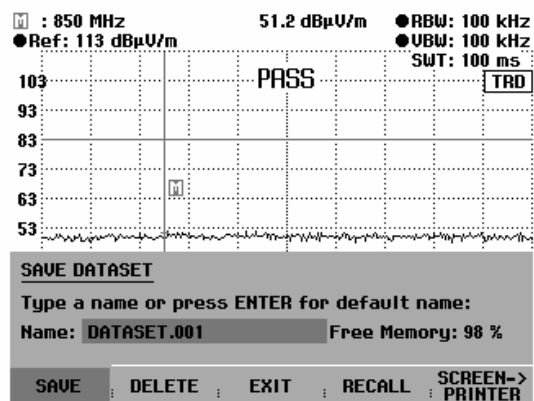

The data set name comprises a text section and a numeric extension, which are separated by a full stop. The data set name suggested by the R&S FSH is derived from the name of the data set last stored, the numeric extension being incremented by 1 in each case.

This means that consecutive data set names can be assigned by simply saving with SAVE or ENTER.

The names of the data sets already stored can be displayed one after the other using the BACK key. This allows, for example, to store new results under the name of a previous data set (for example Antenna.000), but with a new extension. The R&S FSH displays the old name together with the first unassigned extension, e.g. Antenna.001. No new name has to be entered.

Entering a data set name

A new name can be entered with the numeric keypad. The letter assignment for the keypad is the same as that for a mobile phone

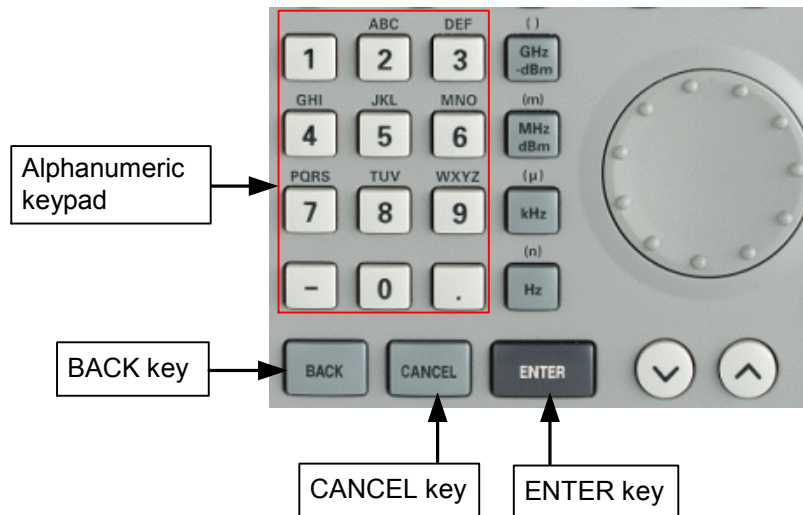

If the R&S FSH is expecting a letter entry, it automatically assigns the letters above the keys to the keys in the alphanumeric keypad. The keys have a multiple assignment. Enter the letter you want by pressing the key in question the appropriate number of times.

- Using the alphanumeric keypad enter a name for the data set and terminate the entry with the ENTER key.

The data set is saved to the R&S FSH's internal memory under the name that has been given.

Loading measurement results

Previously saved measurement results and settings can be recalled with the R&S FSH's recall function.

- Press the RECALL softkey.

The R&S FSH opens a list of all the data sets that have been saved (DATASET LIST).

The red selection bar indicates the last data set to have been saved.

Using the cursor keys, you can position the selection bar at the top or bottom of the page. This means fast scrolling if many data sets have been saved in the R&S FSH's memory.

The displayed list of data sets can be printed out by pressing the LIST->PRINTER softkey.

You can quit the menu by pressing the EXIT softkey. The R&S FSH returns to its previous settings.

| 30/11/2002 | DATASET LIST | 11:07:36 |
|--------------------|---------------------|----------|
| DATASET.002 | 30/11/2002 11:07:20 | |
| DATASET.001 | 30/11/2002 11:07:13 | |
| DATASET.000 | 30/11/2002 11:05:20 | |

| | | | | |
|------------|----------|--------|----------|------------------|
| DELETE ALL | : DELETE | : EXIT | : RECALL | : LIST-> PRINTER |
|------------|----------|--------|----------|------------------|

- Using the rotary knob or the cursor keys select a data set.
- Load the data set by pressing the RECALL softkey.

The R&S FSH displays the contents of the selected data set as a graph on the screen but the settings are not activated on the R&S FSH. This provides an opportunity to visually inspect the data set before its settings are activated.

The name of the data set is displayed in the bottom left-hand corner of the screen.

When this setting is activated, you can scroll through the data sets stored by the R&S FSH with the cursor keys or the rotary knob. This means that the results and the associated settings can be viewed together.

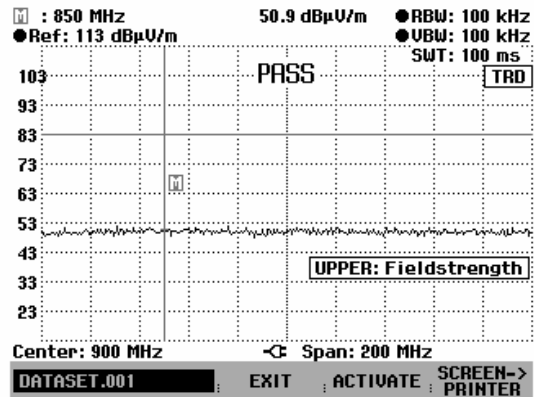

The user can now

- transfer the data set with ACTIVATE and with this setting return to the associated R&S FSH measurement mode,
- print out the measurement and settings stored in the data set to a printer using PRINT,
- press EXIT to quit the setting again.

When you press the EXIT softkey, you return again to the display mode where all saved data sets are listed (DATASET LIST). You can then select, load or delete data sets from this list.

Deleting saved data sets

Saved data sets can be selected from the DATASET LIST and individually deleted.

The R&S FSH marks the selected data set with the red selection bar.

Using the cursor keys, the selection bar is placed at the top or the bottom of the page. This facilitates fast scrolling if many data sets are stored in the R&S FSH's memory.

The displayed data set list can be printed out by pressing the LIST->PRINTER softkey.

You can quit the menu again by pressing the EXIT softkey. You then return to the previous R&S FSH setting.

| 11/12/2002 | DATASET LIST | 21:29:29 |
|-------------|---------------------|----------|
| DATASET.005 | 11/12/2002 21:28:10 | |
| DATASET.004 | 11/12/2002 21:28:09 | |
| DATASET.003 | 11/12/2002 21:28:07 | |
| DATASET.002 | 07/12/2002 19:53:23 | |
| DATASET.001 | 07/12/2002 19:53:23 | |
| DATASET.000 | 07/12/2002 19:53:21 | |

DELETE ALL : DELETE : EXIT : RECALL : LIST-> PRINTER

- Using the rotary knob or the cursor keys, select a data set.
- Delete the data set with the DELETE softkey.

The data set is cleared from the R&S FSH's memory and removed from the list.

Deleting all data sets

Starting from the DATASET LIST mode, all the data sets in the R&S FSH's memory can be completely deleted by pressing the DELETE ALL DATASETS softkey.

- Press the DELETE ALL DATASETS softkey.

Before all the data sets are deleted, the R&S FSH asks the user if he is sure that he wants to delete all the data sets.

The deletion of all data sets must be confirmed explicitly by pressing the YES softkey.

Deletion is aborted if the NO softkey is pressed – the same happens with the ENTER key to prevent accidental deletion of all the data sets.

| 11/12/2002 | DATASET LIST | 21:28:45 |
|-------------|---------------------|----------|
| DATASET.005 | 11/12/2002 21:28:10 | |
| DATASET.004 | 11/12/2002 21:28:09 | |
| DATASET.003 | 11/12/2002 21:28:07 | |
| DATASET.002 | 07/12/2002 19:53:23 | |
| DATASET.001 | 07/12/2002 19:53:23 | |
| DATASET.000 | 07/12/2002 19:53:21 | |

| DELETE ALL DATASETS | |
|--|-----|
| Do you really want to delete all datasets? | |
| NO | YES |

Printing out Measurement Results

An R&S FSH screenshot can be printed out on a printer. The printer type and the baud rate for the serial connection can be selected in the setup menu using the GENERAL / PRINTER... softkey.

- Press the SAVE / PRINT key.

The R&S FSH opens the SAVE / PRINT menu and the printout function offers to print out the current screen to a printer.

Instrument settings can also be saved and data sets loaded or deleted.

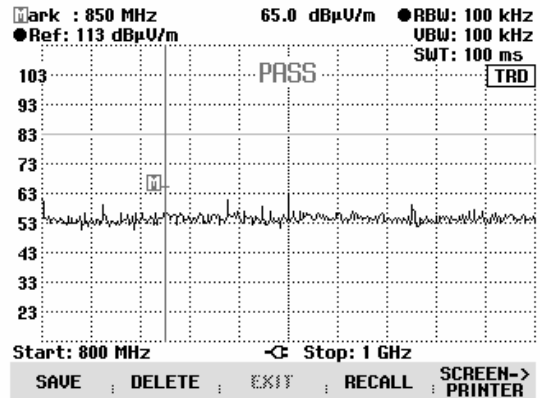

- The SCREEN->PRINTER softkey starts the screenshot printout on a printer.

The screenshot printout is black and white.

The print date and time and the measurement date and time are output in the two header lines.

The associated setup parameters for the measurement in question are printed out below the screenshot hardcopy.

Printed at : 01/02/2002 15:27:15
 Measured at: 01/02/2002 15:15:16

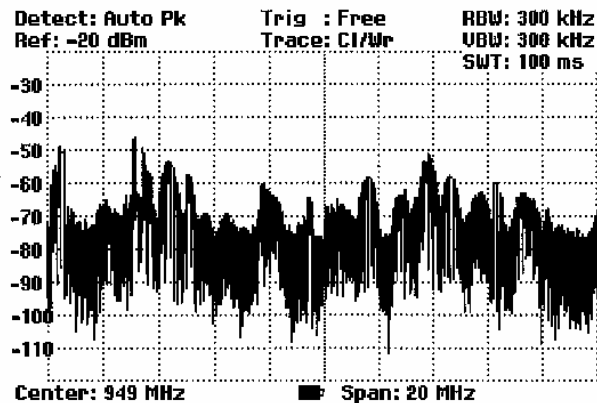

Center Frequency : 949 MHz
 Span : 20 MHz
 Reference Level : -20 dBm
 Reference Offset : 0.0 dB
 RF Input Reference : 50 Ω

Resolution Bandwidth : 300 kHz
 Video Bandwidth : 300 kHz
 Sweptime : 100 ms

Trigger Mode : Free run
 Trigger Level : ---
 Trigger Delay : ---
 Trace Mode : Clear / Write
 Detector : Auto peak

Measurements

How a spectrum analyzer operates

Basically, an RF signal can either be analyzed in the time domain or in the frequency domain.

In the time domain, how the signal varies with time can be observed on an oscilloscope, for example. In the frequency domain, a spectrum analyzer can be used to display the frequency components of a signal.

Both modes are essentially equivalent because applying the Fourier transform to any signal converts it into its spectral components. However, depending on the signal characteristic to be measured, one method is usually more appropriate than the other. Just by glancing at an oscilloscope, it is possible to tell whether a measurement signal is a sine signal, a squarewave with a certain on/off ratio or a sawtooth. However, it is not at all obvious what the harmonic content of the signal is or if low-level signals are superimposed. This is easy to see with a spectrum analyzer.

The following Fig. shows the theoretical basis of the two measurement techniques. In the time domain, an oscilloscope is showing a section of a signal which is approximately a squarewave. The same signal viewed with a spectrum analyzer shows a line spectrum, i.e. the fundamental and harmonics.

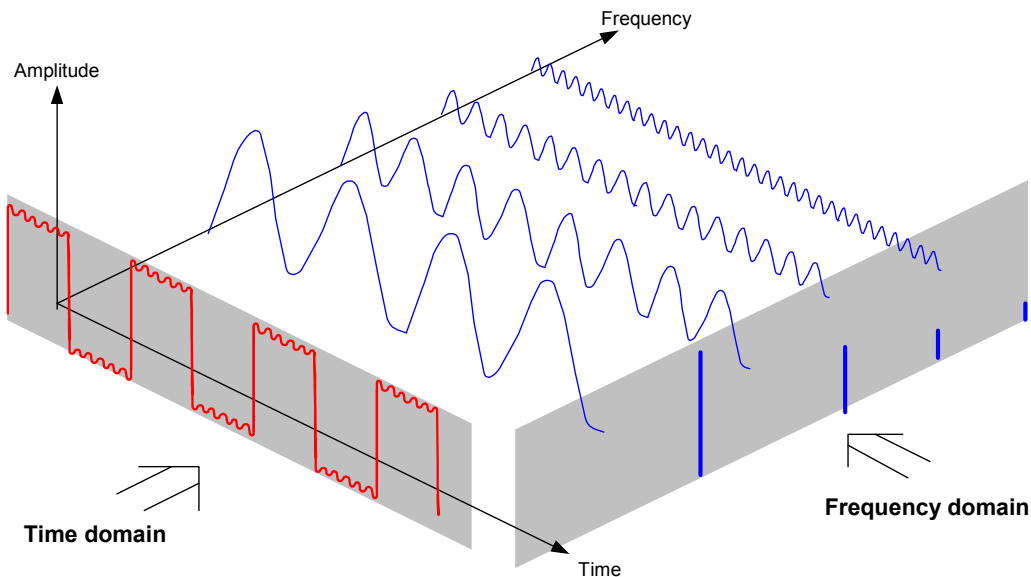

The periodic squarewave in the time domain can be Fourier transformed to the frequency domain. In the case of a squarewave there is a fundamental (= frequency of the squarewave) and its odd harmonics. Using a narrow bandpass filter, the spectrum analyzer makes measurements in the frequency domain. Only at frequencies where there is a signal is there a reading which gives the amplitude of the frequency component.

The block diagram below shows how a spectrum analyzer works.

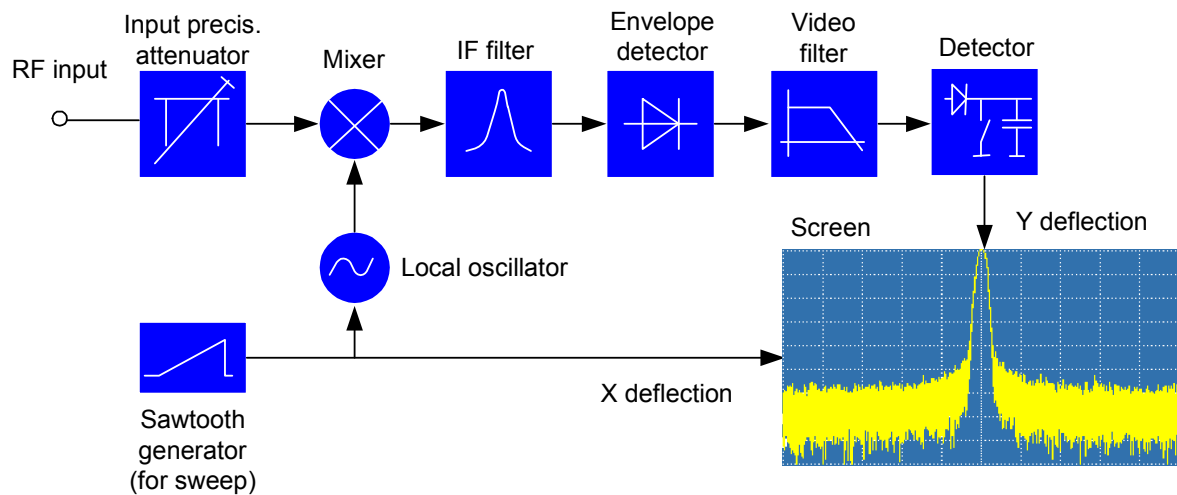

The precision attenuator at the input of the spectrum analyzer adjusts the level of the measurement signal to the level range that the mixer can handle without overdriving it. The precision attenuator at the input of the R&S FSH is adjustable in 10 dB steps from 0 dB to 30 dB and is directly coupled to the reference level setting.

The mixer converts the RF input signal to a fixed IF. Conversion is usually performed in several stages to an IF for which good narrowband IF filters are available. The R&S FSH3 has three mixing stages with the IFs 4031 MHz, 831.25 MHz and 31.25 MHz. Up to 3 GHz, the R&S FSH6 uses the same IFs as the R&S FSH3. Between 3 GHz and 6 GHz, it uses a first IF at 7231 MHz, which it converts to the second IF of 831.25 MHz with the aid of the second local oscillator at 6400 MHz. As of the second IF, the signal path for the two ranges is identical.

A local oscillator that can be tuned from 4031 MHz to 7031 MHz is used in the R&S FSH3 for conversion to the first IF so that a certain input frequency is converted to the first IF. The further conversions are performed by single-frequency oscillators.

The frequency of the local oscillator determines the input frequency at which the spectrum analyzer performs measurements:

$$f_{in} = f_{LO} - f_{IF}$$

The first mixer produces the sum frequency $f_{LO} + f_{in}$ (= image frequency f_{image}) as well as the difference frequency $f_{LO} - f_{in}$.

The image frequency is rejected by the bandpass at the IF so that it does not interfere with the subsequent frequency conversions.

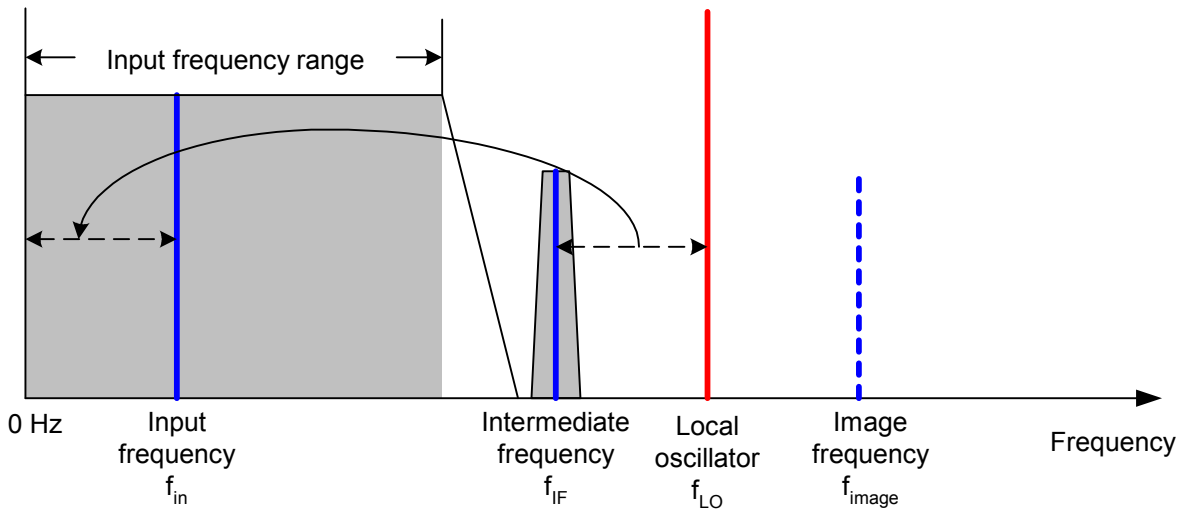

The first local oscillator is tuned with a sawtooth which simultaneously acts as the x deflection voltage for the display. In practice, synthesizer technology is used to generate the frequency of the first local oscillator and for a digital display.

The instantaneous sawtooth voltage therefore determines the input frequency of the spectrum analyzer.

The bandwidth of the IF filter at the IF determines the bandwidth that is used for measurements. Pure sine signals are passed by the IF filter characteristics. This means that signals closer together than the bandwidth of the IF filter cannot be resolved. This is why the bandwidth of the IF filter in a spectrum analyzer is referred to as the resolution bandwidth. The R&S FSH has resolution bandwidths from 1 kHz to 1 MHz.

The bandlimited IF is passed to the envelope detector. The envelope detector removes the IF from the signal and outputs its envelope. The output signal from the envelope detector is referred to as the video signal. As it has been demodulated, it only contains amplitude information. The phase information is lost.

With RF sine signals, the video signal is a DC voltage. With AM signals the video signal contains a DC component whose amplitude corresponds to the carrier power and an AC component whose frequency is equal to the modulation frequency, provided the modulation frequency is inside the resolution bandwidth.

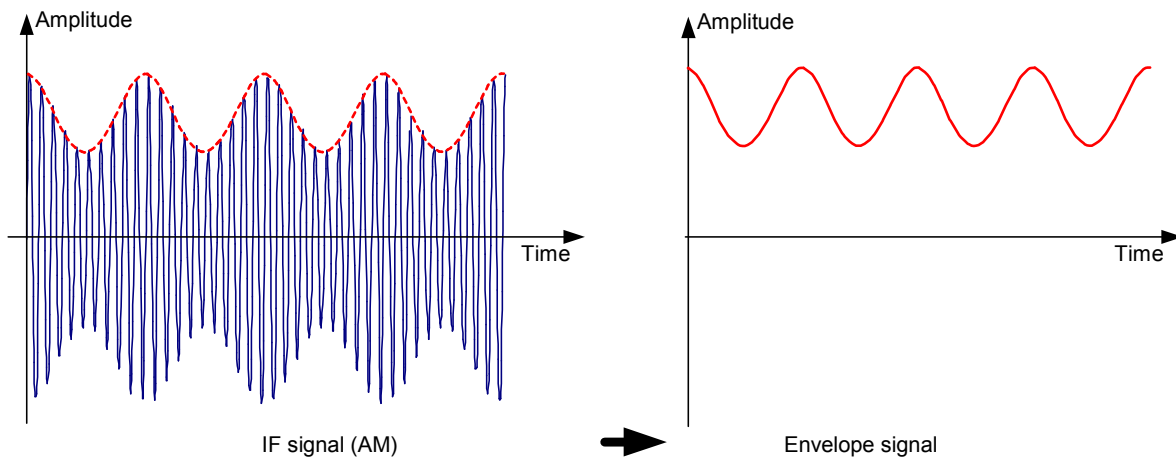

The video filter comes after the envelope detector. The filter is a lowpass with an adjustable cutoff frequency which limits the bandwidth of the video signal. It is particularly useful when sine signals are to be measured in the vicinity of the spectrum analyzer's intrinsic noise. The sine signal produces a video signal that is a DC voltage. At the IF, however, the noise is distributed over the whole bandwidth or, in the case of the video signal, over half the bandwidth of the resolution filter. By selecting a narrow video bandwidth relative to the resolution bandwidth, the noise can be suppressed, while the sine signal to be measured (= DC) is not affected.

The Figs. below show a weak sine signal. In the first Fig., it is measured with a large video bandwidth and in the second with a narrow video bandwidth.

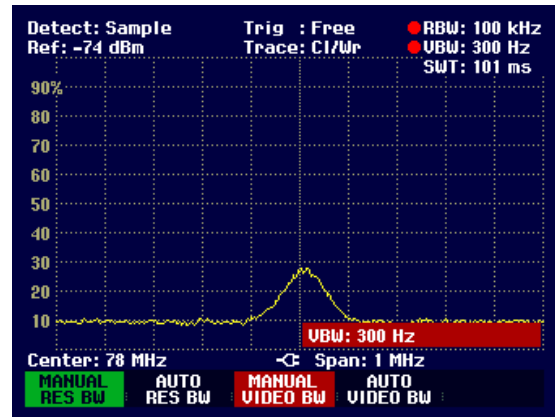
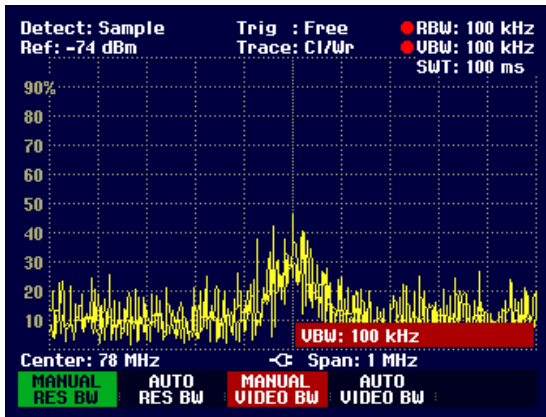

Limiting the video bandwidth smooths the trace considerably. This makes it much easier to determine the level of the measured signal.

The detector comes after the video filter. The detector combines the measured spectrum so that it can be represented as one pixel in the trace. The R&S FSH uses 301 pixels to form the trace, i.e. the whole measured spectrum has to be represented using just 301 pixels. Common types of spectrum analyzer detectors are the peak detector (PEAK), the sample detector (SAMPLE) and the RMS detector (RMS). An Auto Peak detector which simultaneously displays the maximum peak and the minimum peak is usually also provided. The Fig. below explains how these detectors work.

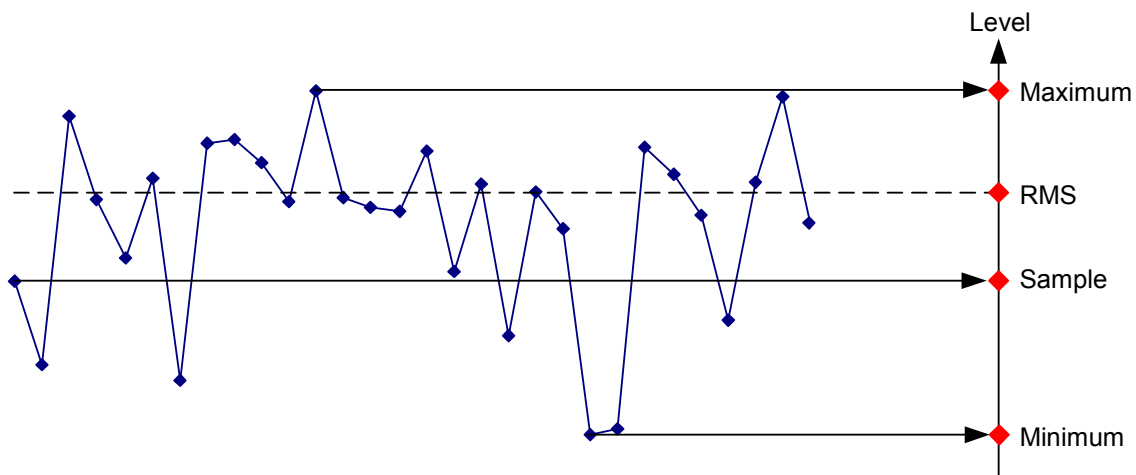

The Fig. above shows 30 measured values which are represented by a single pixel. The peak detector determines and displays the maximum measured value. The Auto Peak detector takes the maximum and minimum and displays them together. The two values are joined by a vertical line segment. This gives a good indication of the level variation over the measured values represented by a single pixel. The RMS detector is used by the spectrum analyzer to determine the RMS value of the measured values. It is therefore a measure of the spectral power represented by a pixel. The sample detector takes an arbitrary measurement value and displays it (in the Fig. above, the first). The other measured values are ignored.

On the basis of the operating principles of detectors, a few recommendations can be made as to their use.

- It is best to use the Auto Peak detector or the peak detector for spectrum analysis over large frequency ranges. This ensures that all signals are displayed.
- The RMS detector is recommended for power measurements on modulated signals. However, the display range should be chosen so as not to exceed 100 times the bandwidth of the signal or the resolution bandwidth, whichever is larger.
- The sample detector or the RMS detector (preferred) should be used for noise measurements. Only these two detectors are capable of measuring noise power correctly.
- When measurements are made on sine signals, the level display does not depend on the detector. However, if you use the RMS detector or the sample detector, ensure that the span is not too great. Otherwise, the displayed levels of sine signals may be lower than their true value.