

SPI225

Smart primary injection test system



- Up to 2000A output
- Smallest primary injection test system in its class
- Output current regulation
- Designed for switchgear commissioning, circuit breaker, CT commissioning, ground grid and relay testing
- Software includes thousands of circuit breaker TCC curves

DESCRIPTION

The Model SPI225 is a high current primary injection test system for all forms of high current testing required in a substation, including testing overcurrent relays, circuit breakers, motor overloads and current transformers.

The SPI system is the FIRST high current test systems to permit a user to type in a predetermined current and the SPI system will generate and regulate the requested high current without preheating the test sample by pulsing the output current at high currents. The SPI system also has the unique ability to turn on at the current zero crossing every time for any load by automatically adjust the output firing angle. This eliminates DC offset for every circuit breaker type and the need for the user to determine and adjust the firing angle for different loads and circuit breakers.

All SPI systems are both fully automated and/or manually controlled. The Smart Touch View Interface "STVI" permits users to manually control the unit and also perform automated testing. The SPI unit can also be controlled by a PC for fully automatic testing and report generation.

APPLICATION

Universal in application, the SPI225 is a high current primary injection test unit with the ability to perform high current commissioning test as well as test low-voltage molded-case circuit breakers. A single SPI225 is designed to test low-voltage molded-case circuit breakers up to a rating of 225A.

The SPI225 is the smallest, lightest primary injection test system designed to perform high current testing on switchgear, current transformers and ground fault protection systems and a multitude of other high current testing applications.

FEATURES AND BENEFITS

Smart Touch View Interface is a simplified input and control touch screen

A key feature of the SPI system is the simplified touch screen input. The STVI touch screen input eliminates the confusing menu system of other primary injection and circuit breaker test systems. The touch screen makes the STVI simple for any technician to use even if the technician does not use the STVI on a consistent basis.

Automatic Control

- The SPI system has many unique abilities to assist in testing
- The user can type a high current setting then the SPI system will generate the requested output without additional user intervention
- Automatically regulate the systems output to the pre-programmed setting
- Automatically regulate the systems output current to compensate for test sample heating or changing load
- Deliver the requested current without user intervention.

Most primary injection system require the user to turn on the system high current then manually adjust the output until the desired test current is set. Once the output is set, the user must still manually adjust the output in order to maintain the desired test current. The SPI system eliminates both of these issues.

Manual Control

The STVI manual controller of the SPI system is sometimes the desired test method. The SPI system permits an operator to run any of the standard test required for primary injection as well as low voltage circuit breakers without the need for a laptop computer.

DC Offset Elimination

DC offset is a common problem when testing instantaneous trips on low voltage circuit breakers. A standard high current test system will commonly cause DC offset in the initial 2 to 4 cycles of an output waveform. This DC offset will cause circuit breakers to trip at incorrect current amplitudes therefore providing incorrect results.

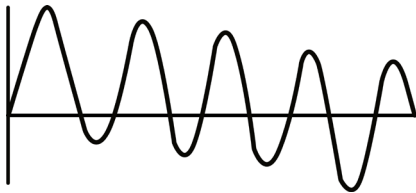

Current Decay

When performing primary injection testing the test leads or test sample will heat up due to the high currents applied. This will result in Current Decay unless the operator manually intervenes. This manual intervention can cause inconsistent test results to the decisions made by the individual operator.

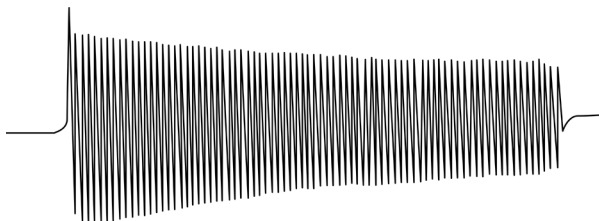

The SPI systems eliminate all these problems by providing a constant current output from the beginning of the waveform until test completion.

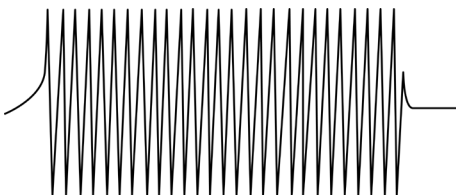

Construction

This test set is built for years of trouble-free, reliable operation. They feature rugged instrumentation and controls designed to withstand the vibration and shock of frequent transportation.

Protection

Fuse, circuit breaker and overload protective devices are incorporated. Temperature sensors provide protection from overheating. Emergency stop pushbutton is provided to de-energize all input power to the test set.

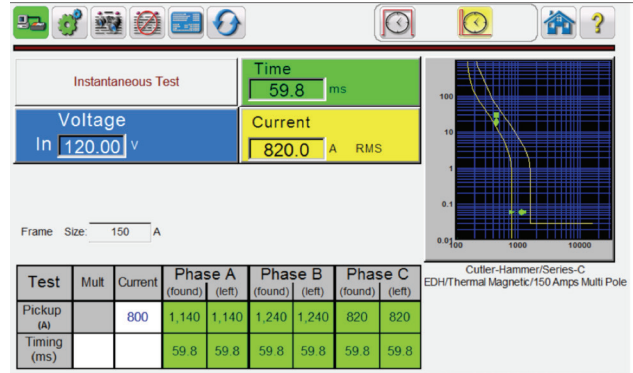

SPI Software

SPI software is the premier software for automated testing, report generation and maintenance record keeping of all primary injection and low voltage circuit breaker test. These results are then recorded in the Power DB database for archival or report generation.

The SPI software is specifically designed for primary injection testing of circuit breakers, relays and other substation equipment. In order to simplify testing the SPI software is pre-loaded with circuit breaker curves in order to permit the user to verify that the circuit breaker under test is operating correctly. Since the SPI software has the curves preloaded the user can test all breaker parameters including:

- Long Time Pick Up
- Long Time Timing
- Short Time Pick Up
- Short Time Timing
- Instantaneous Pick Up
- Ground Fault Pick Up
- Ground Fault Timing

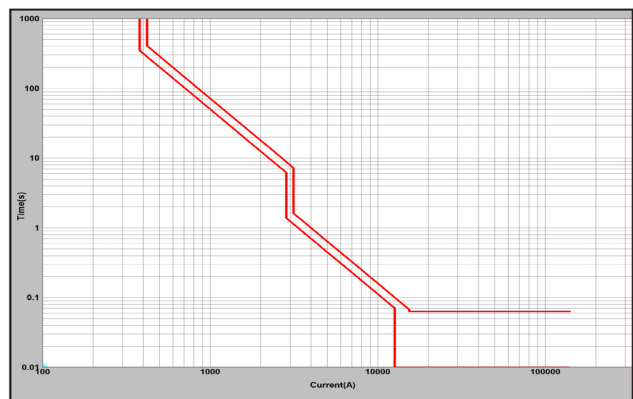

Included complex breaker curves

The SPI software includes report generation for all testing. Thus the user can not only perform all the primary injection testing required but also generate a report for a end customer or for historical purposes.

PARALLEL / SERIES OPERATION

Up to four SPI225 units may be operated in a parallel or series configuration. This allows for higher currents (up to 7800A) or a higher compliance voltage (up to 14V on the high current tap). SPI 225 units operated in a parallel or series configuration requires the main supply source have the same phase angle.

SPI225 PARALLEL CURRENT

		Number of SPI225 Units			
		1	2	3	4
120 V Source	2 ft (61 cm) leads	1952	3523	5725	7478
	10 ft (305 cm) leads	1394	2429	3097	5460
240 V Source	2 ft (61 cm) leads	1952	3524	5671	7882
	10 ft (305 cm) leads	1524	2798	3716	5797

*Actual data taken from testing with an 800 Amp breaker

SPI PRIMARY INJECTION TEST REPORT

www.megger.com

PAGE 1

AMBIENT TEMP 20 °C DATE 11/18/2014

SUBSTATION Electric Utility HUMIDITY 50 % JOB #

POSITION Cubical A ASSET ID 1245

EQUIPMENT LOCATION Toronto

MANUFACTURER Cutler-Hammer SN / SO NO. FRAME SIZE(F) 150

BREAKER TYPE Molded Case SENSOR TAPS MOUNTING B.1 D.O

FUSE CAT. NO. CUBICLE CODE THERMAL MEMORY ON OFF

TRIP UNIT TYPE Thermal Magnetic CATALOG NO. ZONE INTLK TARGETS

STYLE NUMBER NUMBER OF POLES 3

ALL TESTS PASSED

Cutler-Hammer/Series-C/EDH/Thermal Magnetic/150 Amps Multi Pole

Manufacturer's Curve number: Curve No. 3C-119-879

Frame Size: 150
Sensor Rating: 1

Legend

- A Phase Tri At
- B Phase Tri At
- C Phase Tri At
- A Phase Phup At
- B Phase Phup At
- C Phase Phup At
- A Phase Tri At
- B Phase Tri At
- C Phase Tri At
- A Phase Phup At
- B Phase Phup At
- C Phase Phup At

Test	Nominal (A)	TYP (A)	Tolerance	Phase A		Phase B		Phase C		Pass/Fail								
				Min (A) or (kV)	Max (A) or (kV)	As Found (A)	As Left (A)	As Found (A)	As Left (A)		As Found (A)	As Left (A)						
LT Timing	450.00	0.0	13.00%	56.012	450.00	15.690	450.00	14.7	450.00	25.826	450.00	25.83	450.00	33.560	450.00	36.79	Pass	
Inst Pickup	800.00			800.00	1,000.00	900.00	0.060	950	0.060	1,160.00	0.060	1220	0.060	1,420.00	0.060	1440	0.060	Pass

TEST EQUIPMENT USED: SPI 225(SM09978451) TESTED BY: job

COPYRIGHT © 2002-2014 PIONEER, INC. www.pioneer-db.com REVISED 10/20/2014

SPECIFICATIONS

Input

	Input Voltage	Input Current	Frequency
"N"	115 +10% -5%	15 A	60/50 Hz
"R"	230 +10% -5%	8A	60/50 Hz
"C"	230 +10% -5%	8A	60/50 Hz

Output

Output Ranges

Continuously adjustable in three ranges to meet a variety of test circuit impedances:

25 to 500 A at 3.5 V max.

6.25 to 125 A at 14 V max.

1.25 to 25 A at 70 V max.

Output Capacity

Percent Rated Current	Maximum Time On	Minimum Time Off
100% (1X)	30 min.	30 min.
200% (2X)	3 min.	8 min.
300% (3X)	30 sec.	4 min.
400% (4X)	7 sec.	2 min.

The output ranges will provide several times their current rating, provided the output voltage is sufficient to push the desired current through the impedance of the test circuit.

The SPI225 will test the time-delay characteristic of thermal devices rated up to 225 A using the recommended test current of three times their rating (675 A). Also, to perform an instantaneous trip test, it will provide 2000 A through a typical 225-ampere, molded-case circuit breaker.

Because the magnitude of the output current is determined by the impedance of the load circuit, the voltage rating must be sufficient to push the desired current through the device under test and the connecting test leads.

Ammeter

Operating Mode: Memory, Continuous

Digital Display: Autoranging display 5-digit

Ranges: 1.0000 A to 99.999 kA

Overall Ammeter System: Continuous ±1% of reading

Accuracy: RMS Pulse ±1.5% of reading

Voltmeter

Digital Display: 5-digit Autoranging display

Ranges: 0.01 to 600.00 Volts

Accuracy: ±1% of reading

Timer range

Digital Display: 5-digit Autoranging display

Ranges: 0.001 to 99999 seconds

0.01 to 99999 cycles

Accuracy: ±1% of reading

Communications port

Ethernet (2)

USB 2.0

Bluetooth (optional)

Dimensions

(N & R)

14.2 W x 7.6 H x 12.0 D in.

(360 W x 194 H x 305 D mm)

(C)

14.2 W x 7.6 H x 17.0 D in.

(360 W x 194 H x 432 D mm)

Weight

(N & R)

44.0 lb. (20 kg)

(C)

50.7 lb. (23 kg)

Operating temperature range and humidity

Operating: 0° C to 50° C

Storage: -30° C to 70° C

Humidity: 0 to 90% Non Condensing

Conformance Standards

Safety: EN 61010-1

Shock: EN/IEC 60068-2-27

Vibration: EN/IEC 68-2-6

Transit Drop: ISTA 1A

Free Fall: EN/IEC 60068-2-32





Drop / Topple: EN/IEC 60068-2-31





Electromagnetic Compatibility

Emissions: EN 61326-2-1, EN 61000-3-2/3, FCC Subpart B of Part 15 Class A

Immunity: EN 61000-4-2/3/4/5/6/8/11

INCLUDED ACCESSORY DESCRIPTIONS

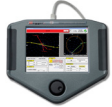
Description	Part No.
 <p>Accessory carry case: Used to carry power cord, Ethernet cable, Optional STVI and test leads.</p>	2001-487
 <p>Alligator clip: Alligator clip, red, 4.1 mm, use with test leads up to 1000 V/32 Amps CAT III. Excellent for test connections to terminal screws and pins where spade lugs cannot be used.</p>	684006
<p>Alligator clip, black, 4.1 mm, use with test leads up to 1000 V/32 Amps CAT III. Excellent for test connections to terminal screws and pins where spade lugs cannot be used.</p>	684007
<p>Sleeved pair of test leads with retractable shroud: Sleeved test leads, one red, one black, 200 cm (78.7") long, 600 V, 32 Amperes CAT II</p>	
 <p>Sleeved test leads in pairs will reduce tangling. These leads and alligator clips are used when the 25A 70V output tap is used. This lead set allows the user to utilize the maximum output compliance voltage.</p>	2008-539
<p>The 4/0 high current leads allow the SPI to generate the maximum current specified. These leads also include Megger's unique adapters to allow connection to multiple breaker styles. The AWG #6 high current lead is used with the SPI's 125A 14V output tap. This lead is used when 14V output compliance voltage is required.</p>	
 <p>Current Lead Current Lead, AWG#6, 61cm (2 ft) long</p>	1004-728
 <p>Current Lead Current Lead, AWG 4/0, 61cm (2 ft) long, red</p>	1008-280
<p>Current Lead Current Lead, AWG 4/0, 61cm (2 ft) long, black</p>	1008-279
<p>Power Cord - Depending on the style number, the unit will come with one of the following:</p>	
Power Cord Line cord, North American	620000
Power Cord Line cord, Continental Europe with CEE 7/7 Schuko Plug	50425
Power Cord Line cord, International color coded wire	15065
Power Cord Line cord, United Kingdom	90002-989

Description	Part No.
<p>Megger's high current alligator clips are used with Megger's high current leads to allow fast connection to circuit breakers with tab terminations.</p>	
 <p>High Current Alligator Clamp High Current Alligator Clamp Assembly, 100A</p>	1003-863
 <p>High Current Alligator Clamp High Current Alligator Clamp Assembly, 75A</p>	1003-864
<p>Megger's high current probes are used with Megger's high current leads to allow fast connection to circuit breaker lug terminations.</p>	
 <p>High Current Probe High Current Probe, dia 7.6mm (0.3 in)</p>	2003-732
<p>High Current Probe High Current Probe, dia 5.1 mm (0.2 in)</p>	2003-733
<p>High Current Probe High Current Probe, dia 3.2 mm (0.125 in)</p>	2003-734
<p>Ethernet cable Ethernet cable for interconnection to PC, 210cm (7 ft.) long</p>	90003-684
<p>SPI Software and Manual on USB Stick</p>	83404
<p>OPTIONAL ACCESSORY DESCRIPTIONS</p>	
 <p>Smart Touch View Interface Smart Touch View Interface for SMRT33, SMRT36, SMRT36D, SMRT410, and SPI225. This option allows the user to control the SPI unit without the need for a PC.</p>	STVI-1
<p>SPI 6' Lead Set consists of: SPI 6' RED 4/0 SPI 6' BLK 4/0 SPI 6' RED 14V</p>	1008-284
<p>Note: Reduces max current to 1725 Amps. 2 Current Leads, AWG 4/0, 183 cm (6ft) long one red, one black</p>	
<p>SPI 10' Lead Set consists of: SPI 10' RED LEAD SPI 10' BLK LEAD</p>	1008-747
<p>Note: Reduces max current to 1650 Amps. 2 Current Leads, AWG 4/0, 305 cm (10 ft) long one red, one black</p>	
 <p>High Current Test Probe Current Lead AWG 4/0, 305 cm (10ft) Probe dimensions: 61 cm (2ft), 15 cm (6 in) in diameter supplied with 2 high current tips. Return Lead AWG 4/0 122 cm (4ft)</p>	1007-833
<p>Ground Lead</p> 	610 cm (20 ft)
	2003-724

ORDERING INFORMATION

STYLE NUMBER IDENTIFICATION

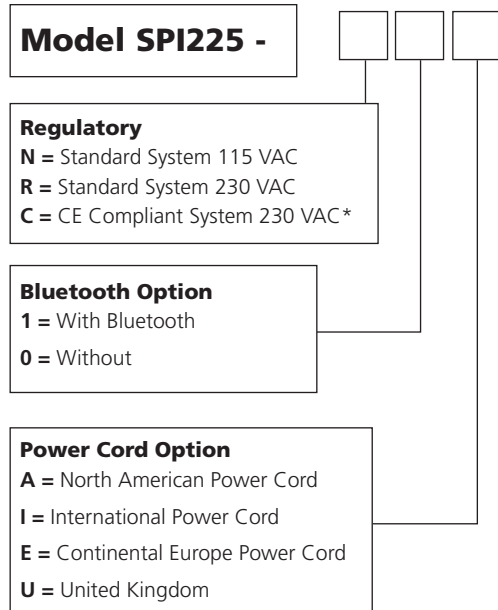

NOTE:

*CE Marked units operating at 230V will have reduced outputs

UK
 Archcliffe Road Dover
 CT17 9EN England
 T +44 (0) 1304 502101
 F +44 (0) 1304 207342
 UKsales@megger.com

UNITED STATES
 4271 Bronze Way
 Dallas TX 75237-1019 USA
 T 800 723 2861 (USA only)
 T +1 214 333 3201
 F +1 214 331 7399
 USsales@megger.com

OTHER TECHNICAL SALES OFFICES
 Valley Forge USA, College Station USA,
 Sydney AUSTRALIA, Danderyd SWEDEN,
 Ontario CANADA, Trappes FRANCE,
 Oberursel GERMANY, Aargau SWITZERLAND,
 Kingdom of BAHRAIN, Mumbai INDIA,
 Johannesburg SOUTH AFRICA, Chonburi THAILAND

CERTIFICATION ISO
 Registered to ISO 9001:2000 Cert. no. Q 09290
 Registered to ISO 14001-1996 Cert. no. EMS 61597
SPI225_DS_EN_V08
www.megger.com
 Megger is a registered trademark