

Keysight Technologies

Infiniium UXR-Series Oscilloscopes

Up to 110 GHz of Real-Time High-Definition Bandwidth

The Infiniium UXR is the first series of real-time oscilloscopes to offer ultra-high-performance acquisition with 10 bits of high-definition resolution. With four channels of simultaneous 110 GHz of bandwidth, each concurrently sampling at a staggering 256 GSa/s, Infiniium UXR delivers the world-leading performance, ultra-low noise and high signal fidelity necessary for engineers and scientists to truly see and understand even the fastest phenomena – enabling you to more quickly develop the next generation of technology and research.

Key Features

Models from 13 to 110 GHz of industry best real-time analog bandwidth

Up to 256 GSa/s sampling rate

2-channel and 4-channel models

- Unrestricted full bandwidth per channel
- Unrestricted full sampling per channel

10-bit Analog to Digital Converter (ADC)

Industry-leading deep memory

- Up to 2 Gpts per channel



Table of Contents

Infiniium UXR-Series Oscilloscopes	3
Superior Signal Fidelity from an Ultra-High-Performance Real-Time Oscilloscope	4
Meet the Infiniium UXR-Series Oscilloscopes	5
Creation of the Ultra-High-Performance Class of Real-Time Oscilloscopes	11
First Ever Factory-Quality Self-Calibration Modules	16
Industry's Most Advanced and Flexible Probing System	17
The Oscilloscope — Digital Measurement and Analysis	19
Spectrum Analyzer Capabilities — RF, Radar and Satellite Communications Analysis	20
Network Analyzer Capabilities — Time-Domain Transmission (TDT)	21
The Optical Modulation Analyzer — Research, development and coherent modulation	22
Ultimate Acquisition and Visibility	23
Infiniium UXR-Series Analysis Tools: PrecisionProbe (D9010DMBA)	25
Infiniium UXR-Series Analysis Tools: EZJIT Complete (D9010JITA)	26
Infiniium UXR-Series Analysis Tools: InfiniiSim (D9020ASIA)	28
Infiniium UXR-Series Analysis Tools: Serial Data Equalization (D9020ASIA)	29
Infiniium UXR-Series Analysis Tools: InfiniiScan (D9020SCNA)	29
Analysis Tools: Infiniium Offline Oscilloscope Analysis Software (D9010BSEO)	30
Analysis Tools: User-Defined Function (Standard)	31
Automation Testing: Switch Matrix Support	31
Compliance and Automated Testing	32
Compliance and Automation Testing: User-Defined Application (D9010UDAA)	33
Protocol Analysis	34
Configure your ultra-high-performance real-time oscilloscope solution today	35
Upgrade your Existing UXR Oscilloscope Hardware	41
Vertical System – Performance Characteristics	42
RMS Noise Floor – Performance Characteristics	45
Horizontal System – Performance Characteristics	46
Acquisition System – Performance Characteristics	48
Trigger System – Performance Characteristics	49
Measurements and Math	51
Keysight Infiniium UXR-Series – Platform Characteristics	52
Keysight Infiniium UXR-Series – General Characteristics	54
Definitions	55

Infiniium UXR-Series Oscilloscopes

Do what has never been done

The world's insatiable demand for better performance, shorter design cycles and faster systems with ever more bandwidth has driven the need for a new class of modular ultra-high-performance oscilloscopes with upgradable bandwidths from 13 GHz to 110 GHz, extremely low noise floors, 10-bit high-definition vertical resolution, femtoseconds of jitter, deep memory and hardware accelerated processing. That's the promise of Keysight Technologies Infiniium UXR-Series oscilloscopes. They are undeniably the fastest, lowest noise, highest signal fidelity and most powerful oscilloscopes in the world – with the features and performance necessary to enable and accelerate the next generation of electronic research and design.

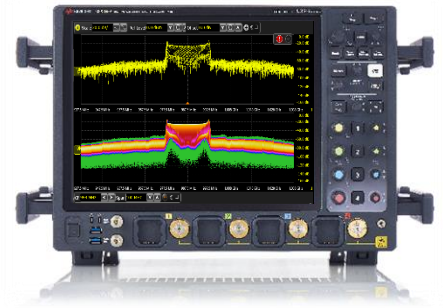

Featuring

- Up to 110 GHz of real-time oscilloscope bandwidth
- High-definition 10-bit analog-to-digital converter (ADC)
- Full bandwidth and channel upgradability
- The industry's lowest noise and jitter measurement floor
- The industry's highest ENOB for bandwidths over 13 GHz

Model Overview

Model Number		Maximum Bandwidth	Input Connector	Maximum Sample Rate	Memory Depth per Channel	
4 Channel	2 Channel				Standard	Maximum
UXR1104A	UXR1102A	110 GHz	1 mm	256 GSa/s	200 Mpts	2 Gpts
UXR1004A	UXR1002A	100 GHz	1 mm			
UXR0804A	UXR0802A	80 GHz	1 mm			
UXR0704A	UXR0702A	70 GHz	1.85 mm			
UXR0594AP	UXR0592AP	59 GHz	1 mm			
UXR0594A	UXR0592A	59 GHz	1.85 mm			
UXR0504A	UXR0502A	50 GHz	1.85 mm			
UXR0404A	UXR0402A	40 GHz	1.85 mm	128 GSa/s		
UXR0334A	N/A	33 GHz	3.5 mm			
UXR0254A	N/A	25 GHz	3.5 mm			
UXR0204A	N/A	20 GHz	3.5 mm			
UXR0164A	N/A	16 GHz	3.5 mm			
UXR0134A	N/A	13 GHz	3.5 mm			

Superior Signal Fidelity from an Ultra-High-Performance Real-Time Oscilloscope

Undeniably the Industry's Best Signal Integrity

- Up to 4 channels with 110 GHz of true analog bandwidth
- World's first high-performance oscilloscope series with a full high-definition 10-bit Analog-to-Digital Converter (ADC)
- Low-noise analog front ends for precision signal acquisition
 - A mere 150 μV (rms) noise at 32 mVfs with 13 GHz of bandwidth, 500 μV (rms) at 70 GHz and only 860 μV (rms) at 110 GHz
- The industry's highest ENOB for bandwidths above 13 GHz
 - 6.8 bits at 13 GHz over 3.5 mm inputs
 - 5.4 bits at 70 GHz over 1.85 mm inputs
 - 5.0 bits at 110 GHz over 1 mm inputs
- Down to 4 mV/div vertical scaling supported in hardware
- Hardware bandwidth limit filters enable accurate scalability
- Correction filters ensure flat frequency magnitude and phase response
- 20 fs (typical) of intrinsic jitter produce excellent jitter characterizations



Modular Design and Upgradable Platform with the Broadest Range of Capability

The world's insatiable demand for faster data throughputs and better performance are driving current digital and RF technologies to their limits. At the same time, new technologies are emerging every 2 to 3 years as opposed to every 4 to 5 years to meet this demand. Engineers and scientists can't afford to replace their research and development infrastructure to keep pace with every new technology wave. Keysight recognized this shift and designed the UXR-Series to be a modular and fully upgradable platform – offering upgradable bandwidths ranging from 13 GHz to 110 GHz, with 2 and 4 channel unrestricted configurations. Now, you can purchase an oscilloscope that meets your needs today and rest easy knowing it has the power, features, signal integrity and upgradability to meet your most demanding future requirements, while preserving your investment.

- Sequentially upgradable between supported bandwidths
 - Starting from 13 GHz to 110 GHz
 - Most accomplished onsite via simple license keys
- Grow from 2 to 4 channel full bandwidth configurations
- Upgrade to 1 Gpt and 2 Gpts of memory via license keys
- Full Infiniium software and compliance application support
- Widest range of probing and connectivity options
- Optional self-calibration module for a full factory quality frame calibration

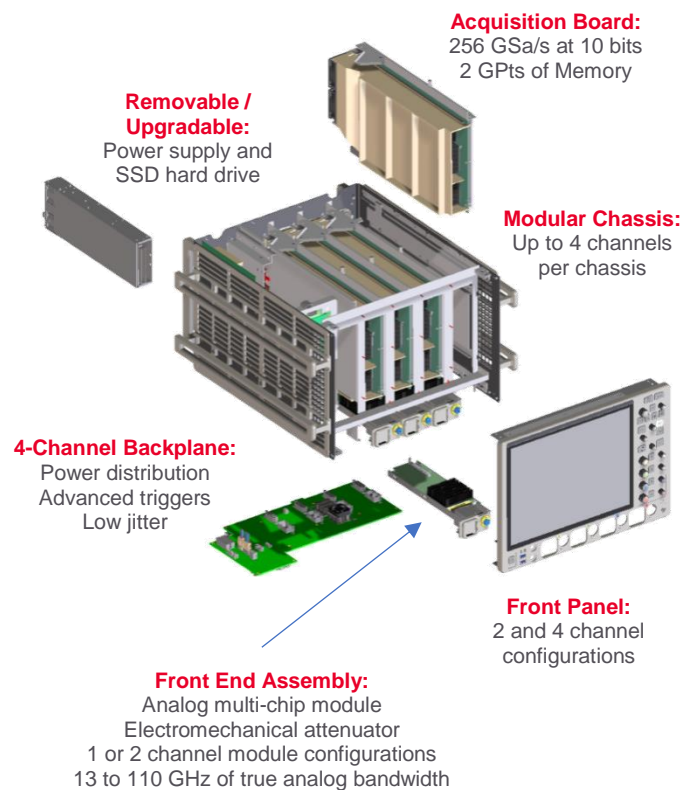

Meet the Infiniium UXR-Series Oscilloscope – 59 GHz to 110 GHz 1 mm Models

Delivering ultimate performance so you can do what has never been done

Models from 59 GHz to 110 GHz of fully sampled real-time analog bandwidth – simultaneously on up to four channels per scope

Unrestricted 256 GSa/s per channel sample rate – with a real-time resolution of 3.9 ps per sample

High-definition 10-bit analog-to-digital converter (ADC) for unrivaled vertical resolution

Ruggedized 1 mm analog input connectors with a new AutoProbe III interface

Up to 2 Gpts per channel of deep memory capable of capturing over 10 Tb/s



Up to 100x faster performance for some measurements – enabled by a powerful new measurement acceleration ASIC and memory controller capable of 5 trillion integer operations per second (IOPS)

Keysight Indium Phosphide ASIC technology enables the lowest noise and highest signal integrity through full bandwidth time-interleaved sampling (TIS)



16 GB RAM with 3.0 GHz quad core processor and hardware acceleration enable fast processing

See your signal more clearly with a large 15.4-inch capacitive touch screen display

Ability to measure edges as fast as 2.8 ps combined with the industry's lowest noise and 20 fs_{rms} of intrinsic jitter enables even the most demanding multi-channel applications like:

- Coherent optical modulation
- 100G/400G/600G/1T+
- Datacom system debug
- Gen 5 technologies
- PCIe debug and compliance
- Radar and satellite
- USB 3.x and DDR5
- PAM4 and NRZ
- Research and defense

The Infiniium UXR-Series oscilloscopes features application-specific software that allows you to gain the insight into your design that you need. Whether you are solving tough jitter or noise problems, removing loss due to cables or probes, or simply looking at protocol, the UXR-Series has the tools to help ensure you realize your best design.

Meet the Infiniium UXR-Series Oscilloscope – 40 GHz to 70 GHz 1.85 mm Models

Delivering the power and performance required for next generation technologies

Models from 40 GHz to 70 GHz of fully sampled real-time analog bandwidth – simultaneously on up to four channels per scope

Unrestricted 256 GSa/s per channel sample rate – with a real-time resolution of 3.9 ps per sample

High-definition 10-bit analog-to-digital converter (ADC) for unrivaled vertical resolution

Standard 1.85 mm analog input connectors with a new AutoProbe III interface

Up to 2 Gpts per channel of deep memory capable of capturing over 10 Tb/s



The UXR-Series improves upon Keysight's use of proven integrated circuits, multichip module packaging, thin-film components, and indium phosphide semiconductor processes to deliver industry-best signal integrity.

Calibration edge with a rise time of less than 15 ps enables TDT calibration with PrecisionProbe. Use the Infiniium calibration source as part of PrecisionProbe Advanced to extend calibration to an unmatched 63 GHz.



USB and LAN provide remote measurements. Infiniium application remote program interface allows application/compliance software automation

The horizontal and vertical knobs can be changed to control functions and waveform memories. Simply right-click the channel control in the GUI to change these controls

Measure section, including a toggling marker button and a dedicated marker knob, provides quick access to your marker control

For applications like:
Coherent optical modulation
100G/400G
802.11ad / 802.11ay
PCIe Gen5
Next generation memory
PAM4 and NRZ

Infiniium UXR-Series oscilloscopes are the world's only 4-channel oscilloscopes capable of bandwidths over 40 GHz on all 4 channels simultaneously. UXR-Series oscilloscopes feature InfiniiMax 30-GHz probes, making debugging your system easier and ensuring you aren't missing valuable harmonic content.

Meet the Infiniium UXR-Series Oscilloscope – 13 GHz to 33 GHz 3.5 mm Models

Best in class signal integrity and noise performance

Models ranging from 13 GHz to 33 GHz of fully sampled real-time analog bandwidth – simultaneously on up to four channels per scope

Unrestricted 128 GSa/s per channel sample rate – with a real-time sample resolution of 7.8125 ps per sample

High-definition 10-bit analog-to-digital converter (ADC) provides 1,024 quantization levels, enabling more accurate digitization of signals – 4x more vertical resolution than traditional 256 level, 8-bit systems

200 Mpts standard, with up to 2 Gpts per channel of optional deep memory



Threaded 3.5 mm RF connectors with convenient auto torque mechanism ensures the most reliable signal integrity and consistent 8 in-lbs connection. The AutoProbe II interface provides a robust interface and instant compatibility with the InfiniiMax III and III+ probing system.

Ultra-quiet analog multi-chip front-end module optimized for 33 GHz and lower bandwidths provides the lowest noise and highest signal integrity available in its class along with the advantage of full bandwidth time-interleaved sampling (TIS).



Enterprise grade 960GB removable solid-state drive improves processing speed and enhances data security

Customizable multipurpose key allows you to customize its function to make your favorite measurements, execute a script, save waveforms or load a setup

Industry best ENOB and less than 10 fs_{rms} of inter-channel intrinsic jitter enables precise capture of multi-channel applications and measurements like:

Datacom system debug
802.11ad and 802.11ay
PCIe debug and compliance
USB 3.x and Thunderbolt
Next-Gen DDR5
LTE and 5G technologies
HDMI and Display port
Power supply sequencing

The Infiniium UXR-Series is a full upgradable platform – enabling growth from 2 to 4 channels and bandwidths from 13 GHz all the way up to 110 GHz. You can invest with confidence today knowing your oscilloscope can adapt to meet the needs of even your most demanding future projects.

Creation of the Ultra-High-Performance Class of Real-Time Oscilloscopes

Groundbreaking next-generation oscilloscope technology enables superior measurements

The Infiniium UXR-Series is the 7th generation in Keysight Technologies' Infiniium portfolio of high-performance real-time oscilloscopes. It is undeniably the world's most technologically advanced and powerful oscilloscope. A single 110 GHz 4-channel Infiniium UXR incorporates over 80 custom Application-Specific Integrated Circuits (ASICs), 13 Field-Programmable Gate Arrays (FPGAs), 9 unique Monolithic Microwave Integrated Circuits (MMICs) and 38 thin films. These revolutionary chipsets are the basis for the building blocks used within the UXR-Series to realize an upgradable and modular design that delivers superior measurements, with the highest fidelity and signal integrity, in a platform that has the power you need today and the ability to conquer even your most demanding future needs.

Whether you are deploying emerging high-speed bus technology, identifying spectral content of wideband RF signals or analyzing transient physical phenomena, you need the truest representation of your signal under test. Keysight invests in advanced leading-edge technology to bring you the highest real-time oscilloscope measurement accuracy available today.

Indium Phosphide (InP) integrated circuits

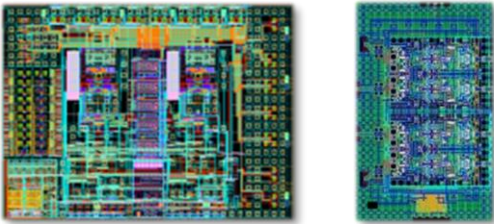

Keysight utilizes a proprietary Indium Phosphide (InP) integrated circuit process to design the key technology blocks necessary to deliver high-bandwidth performance, ultra-low noise and high-voltage signal input. This process is used in the pre-amplifier, trigger, sampling, and probe amplifier integrated circuit designs. Not only does this mean you are purchasing the best oscilloscope on the market today, but you can also count on technology leadership from Keysight in the future.

InP HB2C 110 GHz pre-amp and 265 GSa/s sampler MMICs

10-bit Analog-to-Digital Converter (ADC)

The Infiniium UXR is the world's first high-performance real-time oscilloscope, with offered bandwidths over 8 GHz, to come equipped with a high-definition 10-bit ADC architecture. Every UXR-Series acquisition board multiplexes four of the same 4-lane 10-bit ADCs as used in the award-winning Keysight S-Series oscilloscope. This industry-fastest high-fidelity ADC enables the Infiniium UXR to offer industry leading-sample rates as high as 256 GSa/s per channel across up to four channels simultaneously.

- 4x more vertical resolution than legacy 8-bit oscilloscopes
- ADC Effective Number of Bits (ENOB) up to 8.7 contributes to high system ENOB values
- Up to 14 bits of resolution with high-resolution mode
- Achieves SNR better than historical 8-bit ADC architectures
- Vertical scaling as low as 4 mV/div supported in hardware and 1 mV/div with software-assisted magnification



High-fidelity 10-bit ADC

- 65 nm CMOS (9 mm x 14 mm)
- 130 nm BiCMOS buffer IC
- Custom 33 mm BGA package

Faraday cage shielded analog front-end Multi-Chip Modules (MCMs)

Any oscilloscope is only as good as its analog front-end bandwidth and noise. Infiniium UXR-Series oscilloscopes incorporate 100% full bandwidth time interleave sampling (TIS) on up to 110 GHz of analog bandwidth – coupled with the most advanced front-end noise reducing technology available to ensure ultra-low noise high bandwidth acquisition. This Keysight technology ensures the scopes advanced 10-bit ADC provides high-definition quantization of the test signals, not the oscilloscope's noise. Additionally, MCMs are instantly upgradable to higher bandwidths with a simple software license, adding more value and future proofing your investment.

40 GHz to 110 GHz bandwidth model TIS analog front-end module

- Integrated pre-amplifier, trigger and sampling technology blocks using proprietary noise-shielding faraday cage packaging technology
- Leverages Keysight's proven packaging technologies developed for network analyzers and spectrum analyzers
- InP ICs enable full bandwidth DC to 110 GHz pre-amplifiers
- 256 GSa/s primary InP sampler synchronized with (4) 64 GSa/s SiGe samplers provide TIS aligned signals to (16) 10-bit ADCs
- 7.5 mV/div vertical sensitivity in hardware and 1 mV/div with software assisted magnification
- Analog and DSP bandwidth limit filters reduce unwanted noise
- Electro-mechanical attenuators for decreased noise and high reliability
- Industry lowest 500 μ V (rms) of noise at 70 GHz of bandwidth allows accurate viewing of small signal details

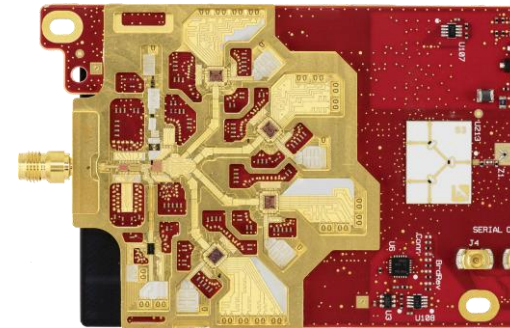

Single Channel 110 GHz MCM

Thin film multi-chip module packaging with faraday cage technology protects incoming signals from external noise and degradation – enabling you to see your signals the way your design experiences them

13 GHz to 33 GHz bandwidth model TIS analog front-end module

- Ultra-quiet design optimized for DC to 33 GHz bandwidths
- Low noise pre-amplifier synchronized with (2) 64 GSa/s SiGe samplers provide TIS aligned signals to (8) 10-bit ADCs
- 4 mV/div vertical sensitivity in hardware and 1 mV/div with software assisted magnification
- Analog and DSP bandwidth limit filters reduce unwanted noise
- Broad maximum input voltage ranging 32 mV to 8 V full scale
- Industry best 150 μ V (rms) noise at 32 mV full scale with 13 GHz of bandwidth
- 2 channels per acquisition board

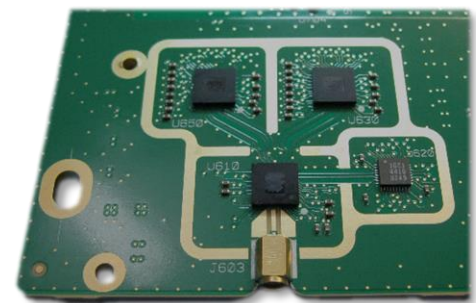

One channel of dual channel 33 GHz MCM

Optimized chipsets and processes, mixed with faraday cage technology, enable the lowest noise analog front end in the world for bandwidths from 13 GHz to 33 GHz

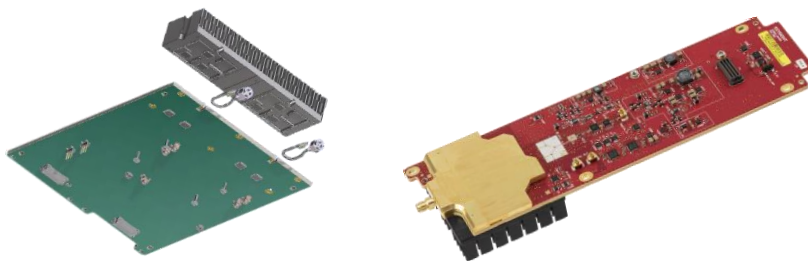

Dual-channel 33 GHz MCM and single-channel 110 GHz MCM with integrated faraday cage heat sink

World's most powerful acquisition and analysis system

To harness the power of a 256 GS/a per second analog front-end and provide 10 bits of high-definition vertical resolution, Keysight needed to develop an acquisition and analysis system capable of quantizing and capturing 2.56 Tb per second of data per channel.

The heart of the Infiniium UXR-Series oscilloscope is a powerful 24-layer acquisition board consisting of 3 sub-laminations and over 1,000 high-speed traces that won the Mentor Graphic Design of the Year award for industrial design. Each 40 GHz to 110 GHz MCM feeds a single acquisition board, while every dual-channel 13 GHz to 33 GHz MCM shares one across each of its channels. At 256 GSa/s, a 4-channel UXR-Series oscilloscope is capable of capturing 10.24 Tb/s of data across 4 acquisition boards – time synchronized to within 10 fs (rms) of inter-channel intrinsic jitter.

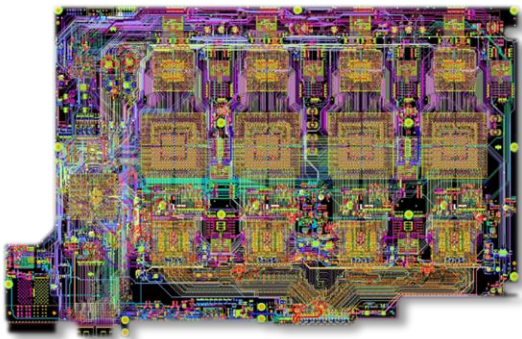

Award Winning Acquisition board

- (4) 10-bit high-definition ADCs
- (4) 100m gate memory controllers
- 2.56 Tb/s of real-time acquisition bandwidth
- (2) signal processing FPGAs
- From 200 Mpts to 2 Gpts of ultra-high-speed memory
- Frequency response correction filters produce flat responses for both magnitude and phase for more accurate waveforms
- User-selectable hardware bandwidth-limiting correction filters from 1 GHz up to the oscilloscope's bandwidth reduce unwanted noise, plus additional front-end filters for even more bandwidth limiting options
- Fast update rates mean your oscilloscope will stay responsive with deep memory on to ensure precise representation of analog signals

Advanced signal processing memory controller

- CMOS ASIC with 100M+ gates
- Capable of 5 trillion integer operations per second
- Improves performance of some features by 100x
- Keysight proprietary DSP technology blocks support rapid optional de-embedding technologies such as InfiniiSim, Precision Probe, and equalization
- Available hardware-based acceleration speeds:
 - Waveform plotting
 - Averaging
 - Equalization (CTLE, FFE, TIE)
 - Jitter measurements (TIE)
 - InfiniiSim
 - Plus, much more ...

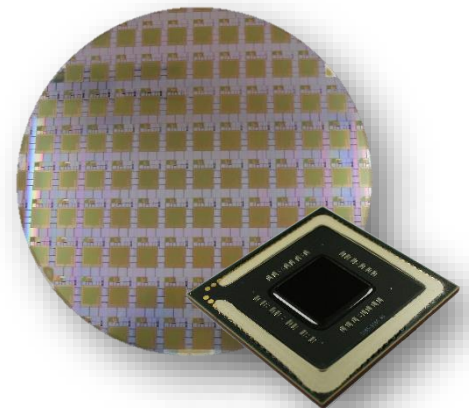

Time-Interleaved Sampling (TIS) vs. Frequency interleaving technologies

Traditional digital storage oscilloscopes used full bandwidth time-interleaved sampling and high-speed 8-bit analog-to-digital converters (ADCs) to capture signals with low noise and the highest levels of signal integrity. Unfortunately, the traditional IC technologies used to power the amplifiers and samplers used in TIS oscilloscopes maxed out below 40 GHz.

To bridge this performance gap, sophisticated frequency interleaving processes like Asynchronous Time Interleaving (ATI), Digital Bandwidth Interleave (DBI), and RealEdge were developed. These complicated technologies split an incoming high-bandwidth signal into two or more lower bandwidth paths – allowing multiple slower ASICs to amplify, sample, acquire and process pieces of faster bandwidth signals. Frequency interleaving consequently comes with the cost of less available simultaneous channels and/or reduced sample rates, which requires multiple scopes for some applications. Consequentially, these innovations come with the disadvantage of increased noise, higher jitter and lower signal fidelity, impacting an engineer or researcher’s ability to measure and analyze today’s ultra-fast, low-voltage signals.

The new ultra-performance solution

Keysight recognized the need for a better solution and, after 5 years of development, has perfected new TIS technologies capable of meeting the needs of today’s most demanding technologies. Powered by advanced Keysight Indium Phosphide ASIC processes, the UXR is able to acquire, amplify and sample an incoming analog signal at a blazing fast 256 GSa/s across a full 110 GHz of bandwidth. This is accomplished without legacy signal degrading frequency interleaving technologies. UXR-Series of oscilloscopes return to the industry-proven, low noise, high signal integrity time-interleaved sampling (TIS) method used in traditional high-definition lower bandwidth oscilloscopes.

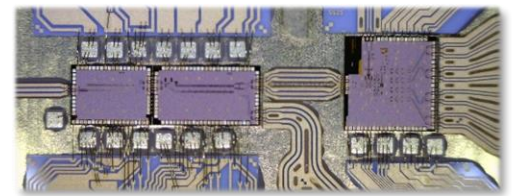

High-Performance Indium Phosphide MMICs

110 GHz pre-amplifier and 256 GSa/s sampler incorporated in thin film multi-chip module

See your signal – not oscilloscope noise

Infiniium UXR incorporates the most powerful and technologically advanced analog front end ever imagined in a real-time oscilloscope. Its leading-edge Indium Phosphide chip technology, custom thin film multi-chip module packaging and integrated faraday cage architecture ultimately guarantees the speed, low noise, and high fidelity needed to capture and measure today’s and the future’s high-bandwidth low-voltage signals - where picoseconds and microvolts matter.

These revolutionary capabilities ensure signals are clearer, eye diagrams are more open, and test results are truly accurate – empowering leading-edge researchers to see their signals the way they really operate in their designs and ultimately accelerate time to market for next generation and advanced technologies such as PAM4, 5G, NRZ, optical solutions and RF signal bursts.

Comparison of 32 Gbps NRZ Eye diagram with ~24 dBm of loss – Measurements after equalization, captured with 40 GHz bandwidth

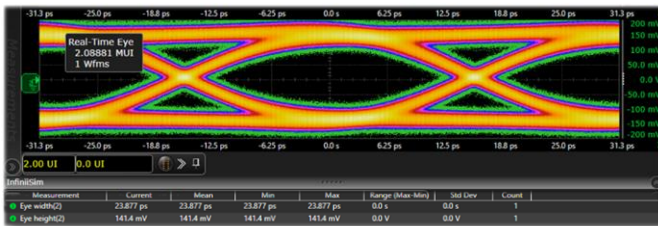

UXR-Series – TIS Channel

- 141.4 mV eye height
- 23.877 ps eye width
- 38.6% more eye height
- 4% more eye width
- Results in more margin for de-embedding / equalization

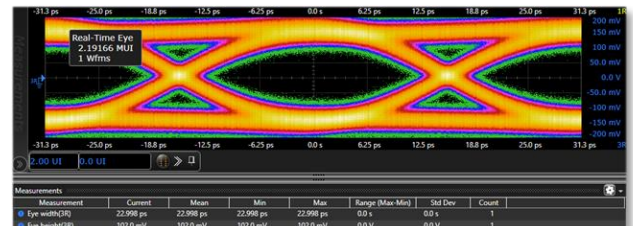

Z-Series – RealEdge Channel

- 102.0 mV eye height
- 22.998 ps eye width

Rugged analog bulkhead connectors ensure reliable high-integrity acquisition at any bandwidth

To economically support bandwidths ranging from 13 GHz to 110 GHz, the various UXR-Series models come equipped with standard and ruggedized male inputs that best support the specified maximum bandwidths. Ruggedized male connectors (also known as outside-thread connectors or NMD connectors) have threads on the inside of the connector nut that are used when making a standard connection, and threads on the outside of the connector nut that are used when making a ruggedized connection.

- 13 GHz to 33 GHz models are equipped with ruggedized male 3.5 mm NMD analog bulkhead connectors
 - Allows the use of standard female SMA, 3.5 mm and 2.92 mm cables and adapters
 - Integrated outer clutch acts as an attached 8 in-lb torque wrench
 - 2 sets of threads for connector diversity
 - Internal – use for standard connections
 - External – use for ruggedized connections
 - AutoProbe II interface ensures compatibility with existing InfiniiMax III and III+ probing technologies

- 40 GHz to 70 GHz models are equipped with standard male 1.85 mm analog bulkhead connectors
 - Allows the use of standard female 1.85 mm and 2.4 mm cables and adapters
 - Housing is knurled for easy finger tightening
 - Includes a hex front end for use with 8 in-lb torque wrenches
 - Advanced AutoProbe III interface enables next generation high-speed probing technologies

- 80 GHz to 110 GHz and AP models are equipped with ruggedized male 1 mm analog bulkhead connectors
 - Allows the use of standard female 1 mm cables and adapters
 - Housing is knurled for easy finger tightening
 - Includes a 14 mm hex front end for use with 10 in-lb and 14 in-lb torque wrenches
 - 2 sets of threads for connector diversity
 - Internal – use for standard connections
 - External – use for ruggedized connections
 - Advanced AutoProbe III interface enables next generation high-speed probing technologies



Ruggedized 1 mm Male Bulkhead Connector with AutoProbe III Interface



Standard 1.85 mm Male Bulkhead Connector with AutoProbe III Interface



Ruggedized 3.5 mm Male Bulkhead Connector with AutoProbe II Interface

Every UXR-Series includes female-to-female connector savers to help protect the unit's primary bulkhead connector from damage. Additional adapters are optionally available, enabling you to support your connectivity needs.

Adapter Type	Part Number
1 mm F Ruggedized to 1 mm F	Y1900B
1 mm F Ruggedized to 1 mm M	Y1900C
1 mm F Ruggedized to 1.85 mm F	Y1901B
1 mm F Ruggedized to 2.92 mm F	Y1903B
1.85 mm F to F Adapter Assembly	N5520B
2.4 mm M to 2.92 M	11904A
2.4 mm F to 2.92 mm F	11904B
2.4 mm M to 2.92 F	11904C
2.4 mm F to 2.92 mm M	11904D
3.5 mm F to 3.5 mm F - kit of 5	54916-68717



Y1900B



Y1903B



Y1901B



11904D



11904B



3.5 mm F to 3.5 mm F

First Ever Factory-Quality Self-Calibration Modules

Regular calibrations are required to ensure your investment in a high-performance oscilloscope is protected and your equipment is operating to its specified performance. However, annual calibration cycles can come up at inconvenient times and encroach on project schedules or impact productivity. With design cycles shortening and greater emphasis on equipment ROI, reducing downtime and improving capital asset utilization is more important than ever.

The Infiniium UXR-Series is the first real-time oscilloscope to offer an optional self-calibration module – capable of performing a full factory-quality frame calibration under site environmental conditions. No longer do you have to lose productivity or time associated with returning your Infiniium UXR-Series oscilloscope back to the factory or a certified calibration center for calibration. Calibration modules are available for all UXR-Series bulkhead connector types and supported bandwidths.

Infiniium UXR Real-Time Oscilloscope Calibration Module

- Calibrate all channels on one or more UXR-Series Oscilloscopes
- Performs an automated full factory-quality frame calibration¹
- Support for calibrating models with bandwidths up to 110 GHz
- Enables full calibration under site environmental conditions
- 1-1/2 hours to calibrate the first channel
 - About an hour per each additional channel
- High-speed Indium Phosphide (InP) step generator
 - Calibrated and traceable to National Institute of Standards and Technology (NIST) standards
- 1-year calibration cycle
- Time scale calibration optionally supported with additional equipment

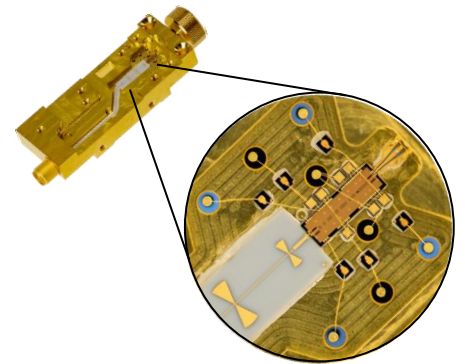

An Indium Phosphide enabled high-speed step generator lies at the heart of every Infiniium calibration module

Model number	Description	Interface type	Max bandwidth
N2125A	Infiniium UXR Real-Time Oscilloscope Calibration Module, 1.0 mm	AutoProbe III	110 GHz
N2126A	Infiniium UXR Real-Time Oscilloscope Calibration Module, 1.85 mm	AutoProbe III	110 GHz
N2127A	Infiniium UXR Real-Time Oscilloscope Calibration Module, 3.5 mm	AutoProbe II	110 GHz



**N2127A – 33 GHz max,
3.5 mm calibration module**



**N2126A – 70 GHz max,
1.85 mm calibration module**



**N2125A – 110 GHz max,
1.0 mm calibration module**

¹ A full factory certified calibration consists of calibration and subsequent testing and verification to ensure the oscilloscope is performing to its documented specifications. The calibration module performs only the factory-level frame calibration step. If verification or a certified calibration certificate is required, the UXR must be returned to a qualified Keysight service center.

Industry's Most Advanced and Flexible Probing System

To take advantage of your investment in a high-bandwidth oscilloscope, you must have a diverse probing system that delivers high-performance measurements. The InfiniiMax III and III+ probing system is unmatched by any product in the market for measuring differential and single-ended signals – with flexible connectivity solutions for today's high-density ICs and circuit boards. It uses a proprietary 200 GHz indium phosphide IC process and advanced thick-film technology to accommodate even your highest-performance needs.

Upgradable InfiniiMax probe amplifiers, ranging from 8 GHz to 30 GHz of low noise bandwidth, deliver unrivaled performance and real-world usability for a completely new level of signal fidelity and accuracy. The built-in InfiniiMode technology allows convenient measurement of differential, single-ended and common mode signals – without adjusting probe tip connections.

The N7000A Series InfiniiMax III+ probing system is the next generation of InfiniiMax probing, greatly expanding the measurement capabilities and usability of a probe capable of measuring all components of a differential signal. The InfiniiMax III+ probe's InfiniiMode provides the following modes of operation.

- A - B (differential)
- A - ground (single-ended A)
- B - ground (single-ended B)
- $(A + B) / 2$ - ground (common mode)



AutoProbe II to AutoProbe III interface adapter

Easily adapt your UXR-Series scope to accept InfiniiMax III and III+ probes with the N2852A AutoProbe II to AutoProbe III interface adapter



N7004A 33 GHz Optical-to-Electrical Converter

- DC to 33 GHz typical (-3 dBe, electrical)
- Single-mode and multimode inputs
- 50/125 μ m, 750 nm - 1650 nm
- Perform reference receiver testing of industry optical standards or characterizing raw response of an optical transmitter

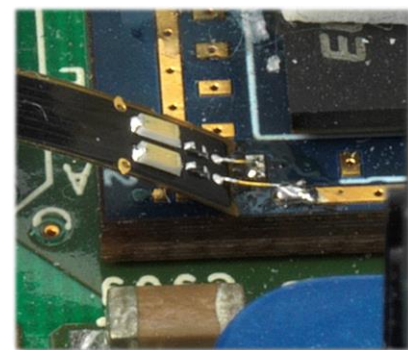

MX0100A InfiniiMax II Micro Probe Head

- Designed to access small geometry target devices
- 3.4 mm trimmable gold-plated nickel lead wires
- 4 mil (0.1mm) diameter
- Excellent 0.17 pF probe loading
- Ground thru-hole for InfiniiMode
- Reusable, small, flat and flexible

Broadest Range of Probing Solutions for Your Highest Performance Needs

All UXR-Series models are compatible with Keysight's InfiniiMax III and III+ probing solutions, supporting a wide variety of high-speed applications with an extensive line-up of probe heads and accessories.

InfiniiMax probe amps	Probe or accessory	Bandwidth
30-GHz InfiniiMax III probe amplifier	N2803A	30 GHz
25-GHz InfiniiMax III probe amplifier	N2802A	25 GHz
20-GHz InfiniiMax III probe amplifier	N2801A	20 GHz
16-GHz InfiniiMax III probe amplifier	N2800A	16 GHz
20-GHz InfiniiMax III+ probe amplifier	N7003A	20 GHz
16-GHz InfiniiMax III+ probe amplifier	N7002A	16 GHz
13-GHz InfiniiMax III+ probe amplifier	N7001A	13 GHz
12-GHz InfiniiMax II probe amplifier (RC)	1169B	12 GHz
8-GHz InfiniiMax III+ probe amplifier	N7000A	8 GHz
InfiniiMax probe heads and tips		
Browser (handheld) probe head	N5445A	30 GHz
Browser tip replacement	N5476A	30 GHz
3.5/2.92/SMA probe head	N5444A	28 GHz
ZIF probe head	N5439A	28 GHz
PC board ZIF tips (set of five)	N2838A	25 GHz
450-ohm ZIF tip kit (set of five)	N5440A	28 GHz
200-ohm ZIF tip kit (set of five)	N5447A	28 GHz
Solder-in probe head	N2836A	26 GHz
Micro probe head (set of five) (compatible with 1169B)	MX0100A	12 GHz
InfiniiMax accessories		
Performance verification fixture	N5443A	30 GHz
Precision BNC adaptor	N5442A	13 GHz
Sampling scope adaptor	N5477A	30 GHz
2.92-mm phase-matched cable pair (1m)	N2823A	40 GHz
2.92-mm phase-matched cable pair (25cm)	N5448B	40 GHz
2.92-mm flexible cable	N5448B	30 GHz
35 GHz flexible cable	N2812B	35 GHz
High-impedance probe adaptor	N5449A	500 MHz
Other recommended probes and accessories		
Optical-to-electrical converter	N7004A	33 GHz
Active termination adapter	N7010A	30 GHz
Power rail probe	N7024A	6 GHz
AutoProbe II to AutoProbe III interface adapter	N2852A	40 GHz
3D probe positioner	N2787A	Not Applicable

For more information, see the Infiniium probes and accessories data sheet – publication number 5968-7141EN.

The Oscilloscope — Digital Measurement and Analysis

With 110 GHz of bandwidth to capture rise times as fast as 2.8 ps and recover clocks on NRZ data rates as fast as 220 Gb/s, the UXR-Series is the world's fastest real-time oscilloscope. Its four channels each capable of simultaneous 110 GHz acquisition make it ideal for even the most bandwidth intensive SERDES designs. In addition to providing leading-edge bandwidth, the UXR-Series helps you see what's really happening in your design, by featuring the industry's lowest noise and jitter measurement floor, which means less scope noise in your measurements and a truer depiction of your signal.

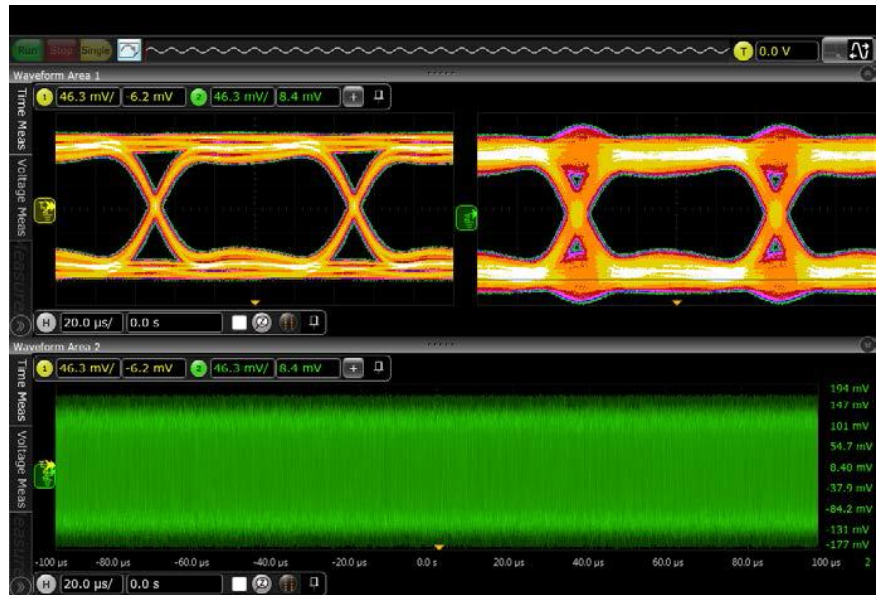

Capture, display and measure multiple real-time eyes simultaneously with the UXR-Series

UXR-Series features the following to enable ultimate digital analysis

- Full offline analysis
- Flexible user interface that supports multiple displays and multi-touch
- Two unique jitter separation algorithms, including bounded uncorrelated jitter (BUJ) breakdown
- Clock recovery on NRZ data rates as fast as 220 Gb/s
- Memory depth that captures milliseconds of data at 256 GSa/s



With its flat frequency response and low noise, the UXR-Series is able to accurately measure jitter components such as ISI.

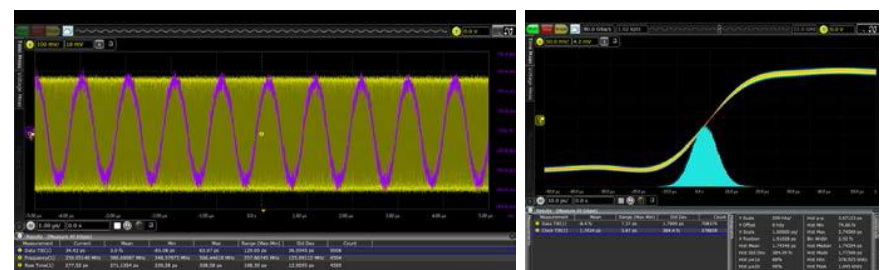

With 110 GHz bandwidth and a 256 GS/s sample rate, the UXR-Series is able to effectively characterize the time interval error trend of high-speed signals as well as fast rising edges, down to 2.8 ps.

Spectrum Analyzer Capabilities — RF, Radar and Satellite Communications Analysis

You need to easily compute both magnitude and phase

Infiniium UXR-Series oscilloscopes include a Fast Fourier Transform (FFT) for frequency domain (spectrum) analysis. The integrated FFT offers an alternative to a dedicated spectrum analyzer. Use the FFT to compute both magnitude and phase and take advantage of several useful features to assist in spectral analysis. The FFT can control span and resolution bandwidth. Automatic measurements and markers measure spectral peak frequencies and magnitudes as well as deltas between peaks. Use the amplitude demodulation (envelope mode) to measure rise and fall times on the entire envelope.

UXR-Series features the following to enable ultimate RF analysis

- Multiple FFT windows including Hanning, rectangular, Blackman-Harris, flattop, and Hamming
- Peak search and navigation for fast analysis
- RF style markers
- Amplitude modulation (envelope mode) — create radar envelopes
- FFT mask trigger
- Gated FFT measurements

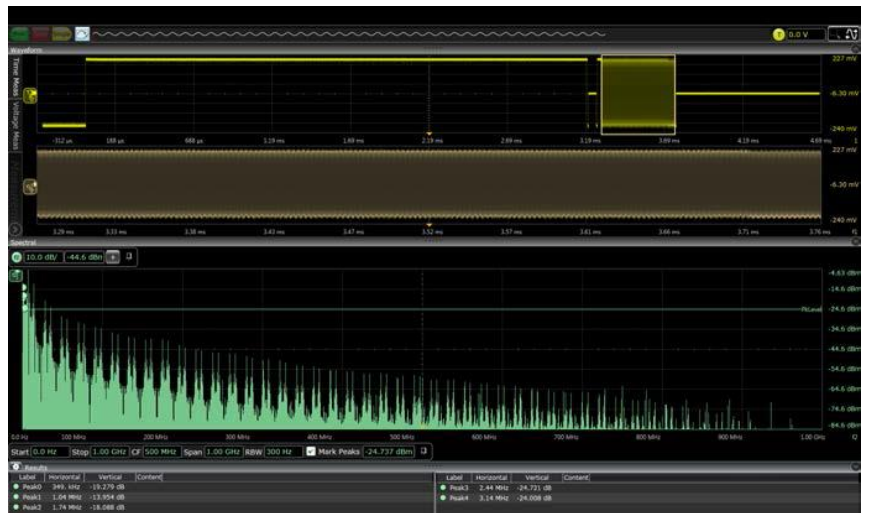

The UXR-Series FFT quickly identifies peaks and has key controls such as span, start and stop, which make the oscilloscope behave more like a spectrum analyzer

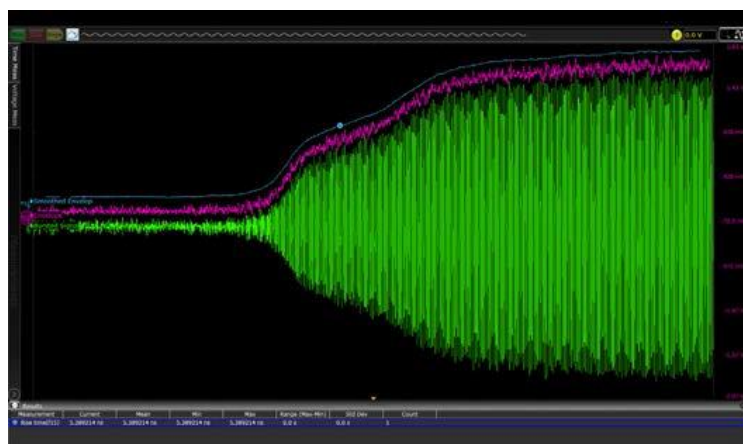

Amplitude demodulation makes it possible to analyze difficult waveforms such as envelopes

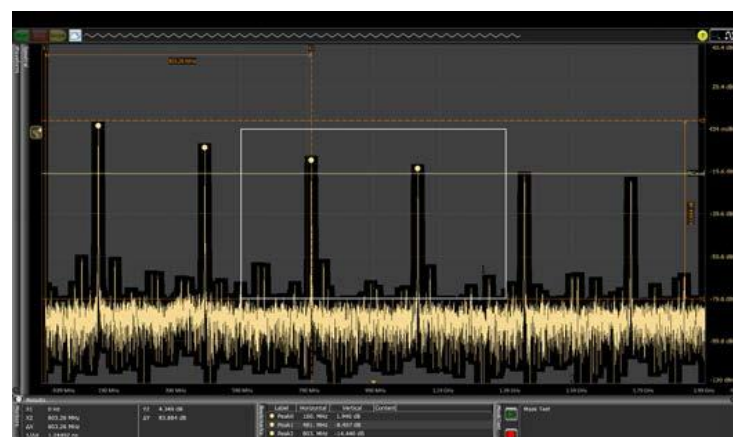

Use the FFT mask to test frequency margins and capture rare events.

Network Analyzer Capabilities — Time-Domain Transmission (TDT)

You need to be able to maximize your margins by removing the effects of cables and fixtures

As bandwidths continue to increase and cable loss becomes more and more of a problem, the UXR-Series has the technology to solve this issue. UXR-Series oscilloscopes offer award-winning PrecisionProbe Advanced technology. You no longer need to ignore cable loss because you are short on time or budget. Using PrecisionProbe Advanced technology, you can characterize cables as fast as 63 GHz and remove the loss they create. PrecisionProbe Advanced technology gives you one of the world's fastest edges at less than 5 ps and uses this edge to perform a TDT on your cable. Based on the loss of your cable, PrecisionProbe Advanced then compensates your measurement system, gaining back valuable margin typically lost in cables.

You need to test multiple lanes automatically and still maximize margins

The UXR-Series features many compliance applications, which provide full automation of any switch connected to your system. The software is fully compatible with PrecisionProbe Advanced compensation, which allows you to characterize every input using only your UXR-Series oscilloscope and then seamlessly automate every measurement in your compliance application. Save valuable time and resources in such technologies as DisplayPort and PCI Express® Gen4.

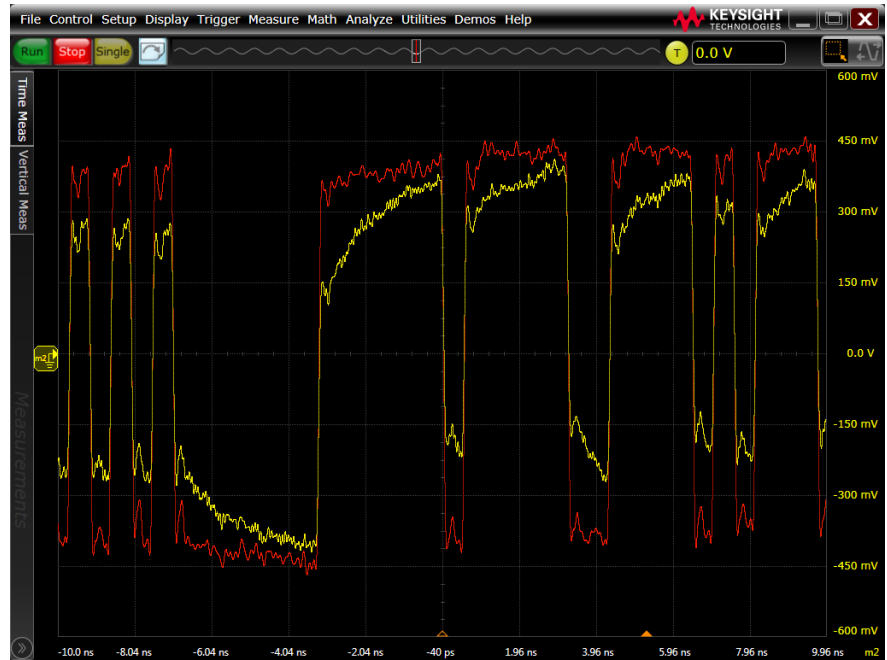

By analyzing cables, you can increase your margins by removing insertion loss caused by cables

The Optical Modulation Analyzer — Research, development and coherent modulation

The ever-growing demand for higher transmission capability is driving advanced symbol rates from 64 GBaud today to 112 GBaud and higher ranges in the longer term. To keep up with continual symbol rate increases, a test instrument is required that can handle baud rate classes of transceivers from 400 Gb/s to 1.2 Tb/s and beyond – from the first day of advanced research through the development phase.

Not only are today's baud rates more challenging, but modulation formats are getting more demanding due to higher-order Quadrature Amplitude Modulation (QAM) and probabilistic shaping, which requires significantly better noise performance.

Infiniium UXR-Series oscilloscopes achieves these requirements and are available in combination with a powerful optical coherent receiver as the N4391B, capable of 160 to 210 Gbaud symbol rates – providing a fully specified turnkey instrument. This compact solution offers the highest real-time bandwidth options and is the most advanced test solution available for research on 400G to terabit and beyond transmission. By providing four channels of up to 110 GHz bandwidth, the UXR-Series saves you the expense of a second instrument to analyze dual polarization. Even for the lower 20 GHz bandwidth range, this easy-to-use solution, with the best EVM and highest ENOB, is a preferred reference system for 100G transmission and beyond.

If you prefer to operate with your own optical receivers but want to benefit from the solutions enormous analysis capability, you can get the N4391B's analysis software as a standalone package.

Features and benefits

- Up to 220 Gbaud symbol rate analysis
- Four times better EVM noise floor than typical QPSK transmitters
- Four channels of 256 GSa/s real-time sampling for optimal phase tracking
- Include your own MATLAB algorithms
- Configurable APSK and OFDM decoders
- Reliable and flexible vector signal analysis (VSA) software

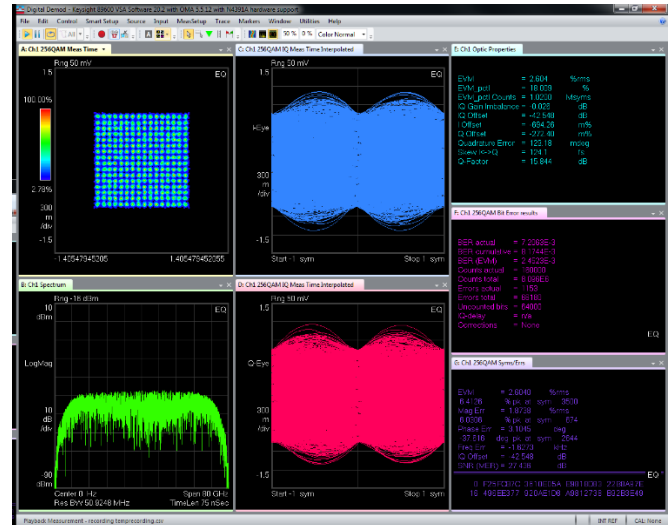

Never before seen 64 Gbaud 256 QAM 1-Tb/s coherent modulation analysis with 2.6% EVM – made possible by the Infiniium UXR-Series real-time oscilloscope and its world's lowest noise, 110 GHz of bandwidth, 256 GSa/s sampling, high-definition 10-bit ADC and industry best ENOB



Integrated N4391B Coherent Optical Solution

Compact fully calibrated turn-key solution for 400Gb/s to 1.2 Tb/s and beyond

Ultimate Acquisition and Visibility

Infiniium User Interface



Easy to use FFTs

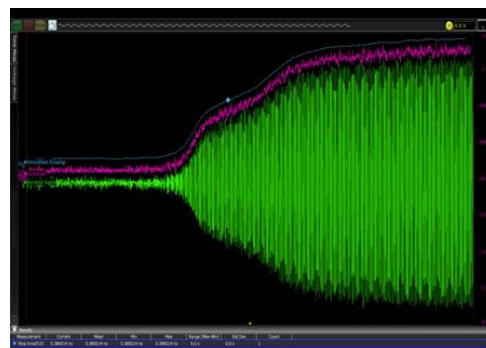

Amplitude demodulation



Protocol Decode

The Infiniium user interface features:

- Full offline viewer
- Up to 16 functions
- Up to 16 horizontal gates
- Up to 9 jitter analysis charts
- Up to 9 noise analysis charts
- Up to 4 InfiniiSim charts
- Up to 16 FFTs at once
- Up to 16 grids in each window
- Peak annotation
- Composite files for easy file sharing
- On-screen marker measurements
- Up to 20 measurements displayed at once
- Multiple display support
- Drag and drop measurements
- My Infiniium menu customization
- Up to 16 user-defined functions
- Full spectral window
- Spectral analysis controls
- Quick save
- Multi-touch for touch capacitive screen
- Function overviews/window
- Up to 16 measurement trends
- Up to 16 histograms
- Nearly unlimited real-time eyes
- Tail fit versus spectral analysis chart
- Hardware acceleration
- Plus, much more ...

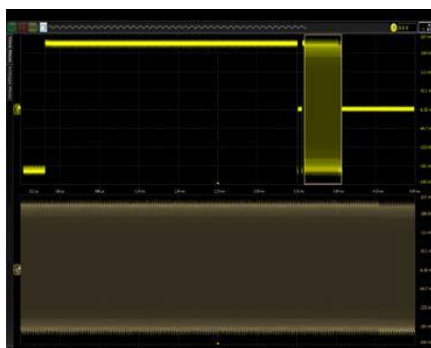
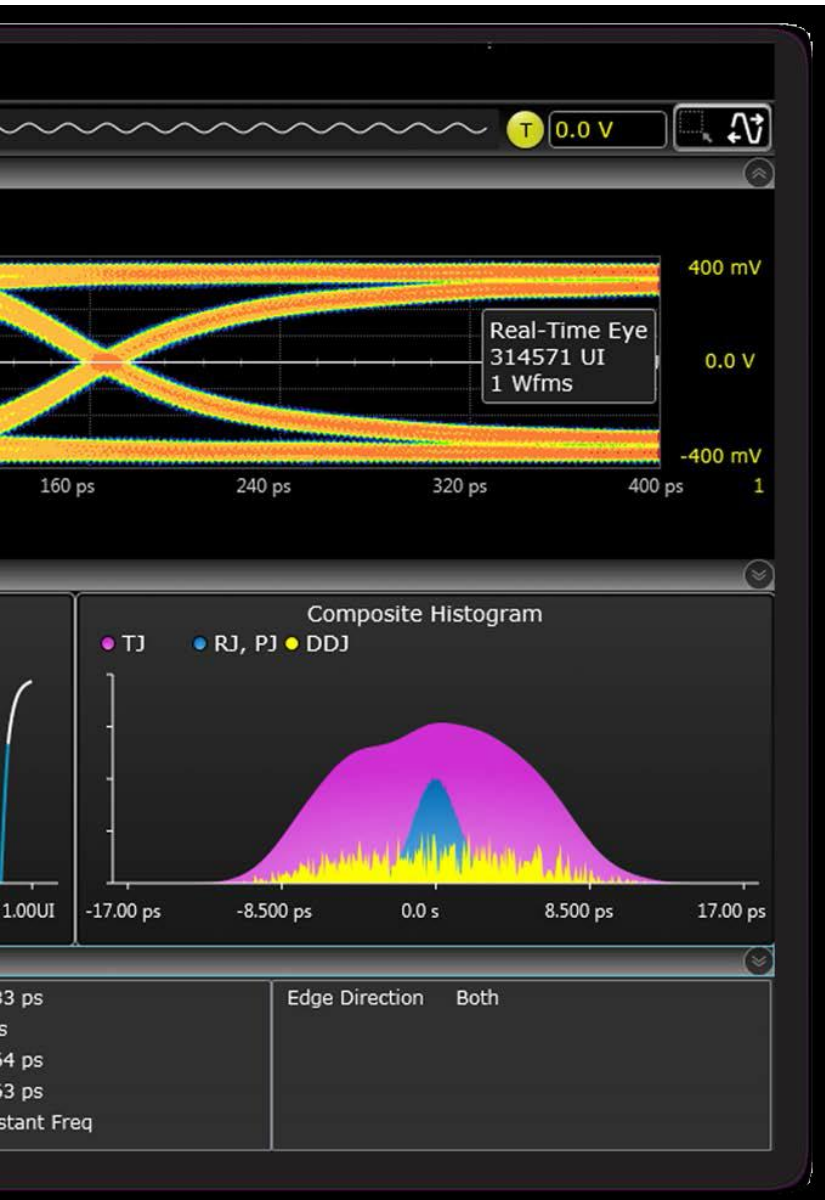

Up to 16 horizontal gates

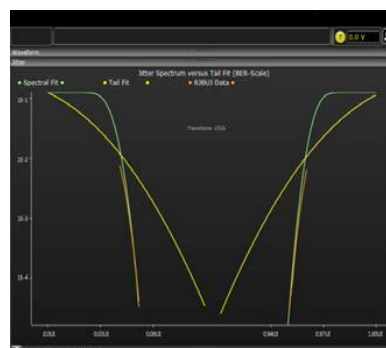

Jitter algorithm verifying window

Infiniium UXR-Series Analysis Tools: PrecisionProbe (D9010DMBA)

Quickly characterize and compensate any input into your scope

PrecisionProbe technology turns your high-performance oscilloscope into the ultimate characterization tool. Not only can you do the normal waveform transformations such as de-embedding through InfiniiSim, PrecisionProbe allows quick characterization of your entire probe system (including cables and switches) without the need for extra equipment. PrecisionProbe takes advantage of the fast “cal output” signal built into the UXR-Series to characterize and compensate insertion loss on the measurement system.

PrecisionProbe technology:

- Properly creates custom probe transfer function = V_{Out} / V_{In}
- Properly characterizes probed system transfer function such that $V_{Out} / V_{In} = V_{Out} / V_{Src}$
- Removes unwanted S21 cable loss
- Ensures every probe has the same frequency response and phase for consistent measurements across multiple probes
- Kit includes N2806A Calibration Pulse Generator capable producing of sub-7 ps rise times



Now every probe and cable in the system can have the exact same response — probe to probe or cable to cable — without the inaccuracies that using one model can produce. You can properly characterize custom probes and remove unwanted responses. In addition to characterizing the cables, PrecisionProbe allows for immediate use on the same instrument. PrecisionProbe saves you time and money while increasing your measurement accuracy.

Characterize probes and cables in five minutes or less and characterize and remove insertion loss up to 63 GHz.

When you combine InfiniiMax probes with switches between the amplifier and the probe head, PrecisionProbe allows for full correction and automation of each probe's path. Full automation is then available to allow for quick swapping of the inputs via the Infiniium software's compliance framework.



N2806A Calibration Pulse Generator

Infiniium UXR-Series Analysis Tools: EZJIT Complete (D9010JITA)

Gain insight into the causes of signal jitter to ensure high reliability of your design

With faster edge speeds and shrinking margins in today's high-speed digital designs, insight into the causes of jitter has become critical for success. Using EZJIT Complete analysis software, the UXR-Series oscilloscopes help you identify and quantify jitter margins that affect the reliability of your design. Time correlation of jitter to the real-time signal makes it easy to trace jitter components to their sources. Additional compliance views and a measurement setup wizard simplify and automate RJ/DJ separation for testing against industry standards.

EZJIT Complete automatically detects embedded clock frequencies and repetitive data patterns on the oscilloscope inputs and calculates the level of data-dependent jitter (DDJ) that is contributed to the total jitter (TJ) PDF by each transition in the pattern, a feature not available on any other real-time oscilloscope today.

Measurement trends and jitter spectrum

EZJIT's simple tools help you quickly analyze the causes of jitter. Measurement trends allow you to see deeper views of factors affecting measurements. Jitter spectrum is a fast method to find the causes of jitter.

Two ways to separate jitter

EZJIT comes with two ways to separate jitter: the spectral method and the emerging tail fit method. Both methods allow for simple separation of RJ and DJ, but the tail fit method provides proper jitter separation in the unique case of bounded uncorrelated jitter.

Unique RJ/DJ threshold view

EZJIT Complete also provides a unique threshold view of the jitter spectrum with the threshold drawn on the chart. The spectral view provides insight into the decision point of the separation and works with both narrow and wide spectral separation.

Real-time eye and clock recovery

Serial data analysis (SDA) software provides flexible clock recovery including 1st and 2nd-order PLL and constant algorithms. With a stable clock, you can look at real-time eyes of transition and non-transition bits. UXR-Series scopes with SDA software also provide a new unique view of bits preceding an eye.

Flexible charts

EZJIT Complete displays up to 10 graphs with unique information. Use them all to maximize your jitter analysis

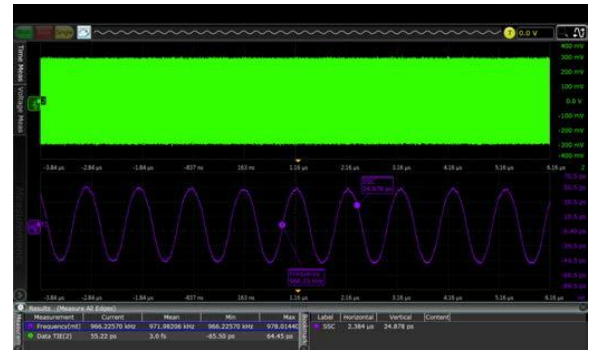

Use EZJIT software to extract spread spectrum clocks

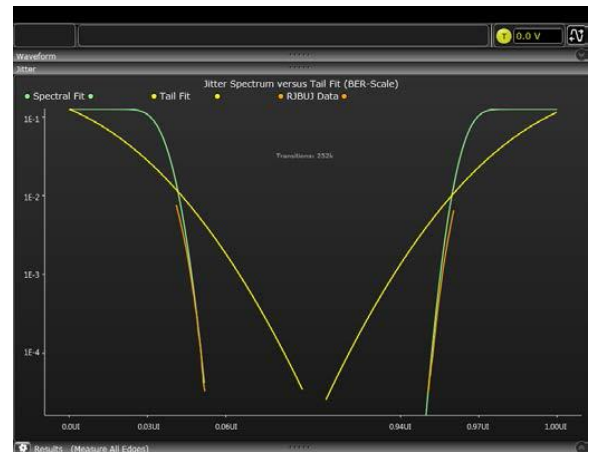

Determine which algorithm fits your data best



Jitter separation makes debugging your device easy

Infiniium UXR-Series Analysis Tools: EZJIT Complete (D9010JITA) (Continued)

Discover signal anomalies to the noise of the waveform



More than your standard jitter package

To efficiently determine root cause for any type of signal degradation in the amplitude domain, you must first determine whether the problem is caused by random or deterministic sources. To help you accomplish this task, EZJIT Complete takes analysis techniques used in the time domain (jitter analysis) and extends them into the amplitude domain.

More than just an eye contour

EZJIT Complete is an in-depth view into impairments related to signal levels – either logic ones or logic zeroes – deviating from their ideal positions. Some tools simply provide a view of an eye contour, but provide no real measurement data other than nice graphics.

EZJIT Complete uses separation techniques to allow each bit to be examined to determine correlated effects and to make multiple measurements on individual bits to determine uncorrelated effects. Use FFTs to analyze the frequency domain and extract random components. Dual-Dirac modeling techniques are also carried from the jitter domain and used in the interference domain.

Key Measurements and Features

- Decomposition of Vertical Noise into constituent components:
 - Random Noise (RN)
 - Periodic Interference (PI)
 - Deterministic Interference (dual dirac model) (DI)
 - Data Dependent Interference, or Intersymbol Interference (ISI)
 - RIN (dBm or dB/Hz)
 - Q-factor
 - Aperiodic Bounded Uncorrelated Interference
- Total Interference (TI) to a specified Bit Error Ratio
- Cumulative Average of High (One) and Low (Zero)
- Tabular Results of all measured quantities
- Graphical Results of:
 - InterSymbol Interference per bit
 - RN / PI Histogram
 - Total (Composite) Interference Histogram
 - BathTub curve (Measured and Extrapolated)
 - Interference Frequency Spectrum
- Settable location in the UI for vertical analysis
- Scope noise compensation
- Arbitrary or Periodic Data patterns
- Advanced spectral and tail fit algorithms for accurate RN, ABUI extraction in crosstalk environments
- Setup Wizard for robust setups

Infiniium UXR-Series Analysis Tools: InfiniiSim (D9020ASIA)

The most advanced waveform transformation software helps you render waveforms anywhere in a digital serial data link

InfiniiSim waveform transformation toolset provides the most flexible and accurate means to render waveforms anywhere in a digital serial data link. The highly configurable system modeling enables you to remove the deleterious effects of unwanted channel elements, simulate waveforms with channel models inserted, view waveforms in physically improbable locations, compensate for loading of probes and other circuit elements, and do so simply and quickly on your tool of choice, the UXR-Series, with up to 110 GHz of bandwidth.

Circuit models to define your setup

The InfiniiSim waveform transformation toolset provides a graphical user interface for you to define your system as you understand it and even make it arbitrarily complex. You do this by selecting topologies and defining circuit blocks.

Model reflections

With the InfiniiSim waveform transformation toolset, you can transform signals with confidence, whether you are inserting or removing channel elements or relocating the measurement plane. InfiniiSim's advanced toolset lets you model up to 27 different elements at once and model the interaction between elements. Only toolsets with the ability to model more than one element will properly reflect a model including the oscilloscope's input. The UXR-Series scopes provide their own S11 parameter to allow modeling of their own input.



InfiniiSim renders the waveform through hardware acceleration

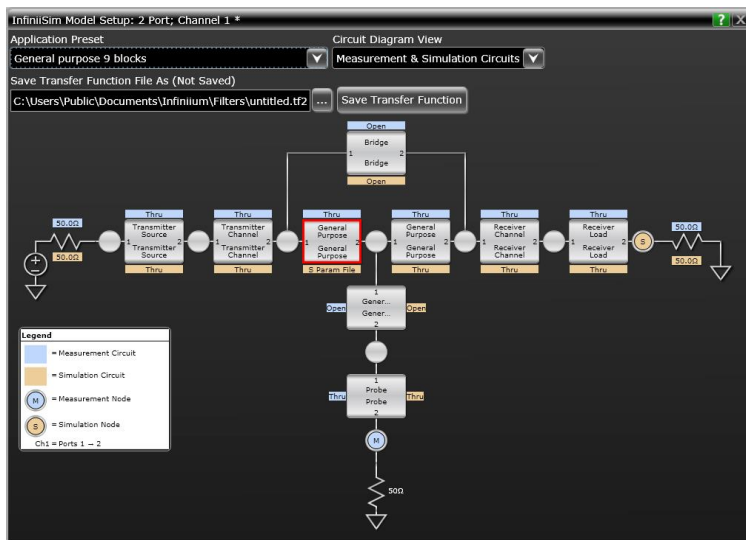

InfiniiSim allows embedding and de-embedding of up to 27 different elements or S-parameter models at once to meet your most demanding requirements.

Model your system with as much detail as you need

InfiniiSim features the model setup that best matches your design. Whether it is a simple single-element model or an advanced general-purpose model with up to 27 elements in the link, you can perfectly model your design and simulate the exact probing point you want.

Infiniium UXR-Series Analysis Tools: Serial Data Equalization (D9020ASIA)

Significantly reduce receiver errors by opening even tightly shut eyes through equalization emulation



Serial data equalization (SDE) for the UXR-Series provides fast and accurate equalization using decision feedback equalization (DFE), feed-forward equalization (FFE), and continuous-time linear equalization (CTLE) modeling in real-time. The UXR's hardware acceleration options further improve equalization performance and real-time usability. Serial data equalization software allows you to input your own self-designated tap values to verify your design. If you prefer, the software will find the optimal tap values for you. CTLE allows DC gain and two-pole modeling.

Infiniium UXR-Series Analysis Tools: InfiniiScan (D9020SCNA)

Quickly and easily identify waveform anomalies

Today's digital signals are increasingly complex. Designers of serial links and parallel buses want to quickly identify signal anomalies in their designs. Engineers have traditionally relied on hardware triggering and deep memory to capture such illusive events. However, these classic methods fall short in some key areas.

Trigger on events that hardware triggers can't handle

InfiniiScan software allows you to use an oscilloscope to identify signal integrity issues that hardware triggering is unable to find in your electronic designs. This innovative software scans through thousands of acquired waveforms per second to help you isolate signal anomalies, saving you time and improving designs.

Innovative triggers

The zone qualify finder allows you to draw a "must intersect" or "must not intersect" zone on the oscilloscope screen to visually determine the event identify condition. If you can see the event of interest on the screen, you can create a trigger that will isolate it, saving significant time over some complicated hardware triggers.

Other triggers include non-monotonic edge, measurement limit search, runt and pulse width.

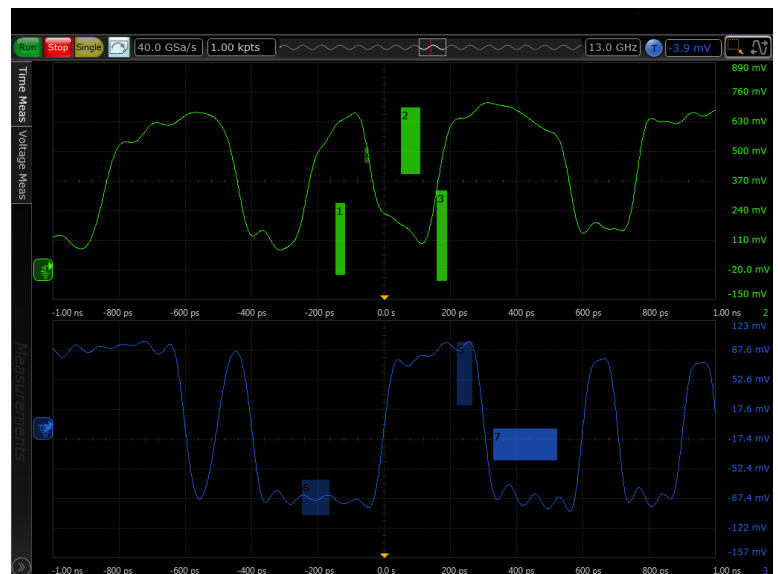

Draw zones on your screen for a unique triggering experience

Analysis Tools: Infiniium Offline Oscilloscope Analysis Software (D9010BSEO)

View and analyze away from your oscilloscope and target system

Ever wish you could do additional signal viewing and analysis away from your scope and target system? Now you can. Capture waveforms on your scope, save to a file, and recall into Keysight's Infiniium Offline application.

It goes anywhere your PC goes

Take advantage of large high-resolution and multiple displays found in your office. Use familiar scope controls to quickly navigate and zoom in to any event of interest. Use auto measurements and functions for additional insight.

Share scope measurements more easily across your team

You can share entire data records instead of being limited exclusively to static screen shots.

Create more useful documentation

Use features such as right-click cut-and-paste to move screen images between applications, without ever having to save the image to a file. Add up to 100 bookmark annotations and up to 20 simultaneous measurements.

Need advanced analysis capability?

Infiniium Offline includes a variety of upgrade options including serial decode upgrades for a variety of serial buses, jitter analysis, and serial data analysis.



Infiniium Offline software works with all Infiniium applications

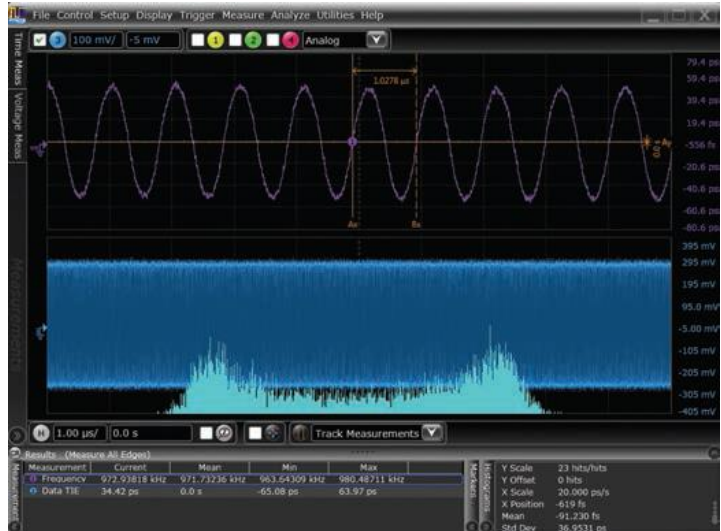

Use Infiniium Offline to find signal anomalies, such as power supply coupling



Peak search capability makes Infiniium Offline a frequency domain tool

Analysis Tools: User-Defined Function (Standard)

Combine Infiniium and MATLAB for even more analysis

Enhance the UXR-Series with a seamless gateway to powerful MATLAB analysis functionality. User-defined function software adds new analysis capabilities to the UXR-Series, beyond traditional math/analysis features. Now you have the freedom to develop your own math functions or filters using MATLAB and its Signal Processing Toolbox. With a seamless integration to MATLAB, Infiniium oscilloscopes allow you to display your math and analysis functions live on the oscilloscope screen, just like any other scope's standard functions.

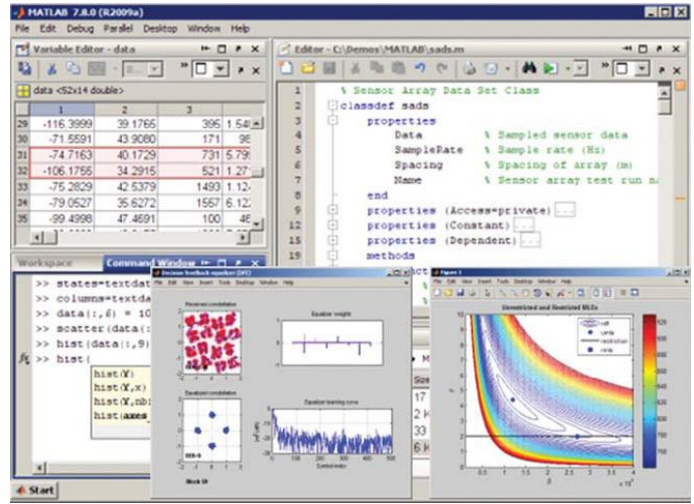

Automation Testing: Switch Matrix Support (N8890A)

Comprehensive testing, easily achieved

Compliance applications on the UXR-Series support a switch matrix, making testing simple by automating tests for each lane of a multi-lane bus. Typical testing requires reconnecting the oscilloscope each time you switch a lane, which causes wasted time and inaccuracies. The UXR-Series solves this problem by supporting switch matrix through its compliance test. Simply connect the switch to the oscilloscope and all the lanes, and then click Run to complete full testing of your entire device.

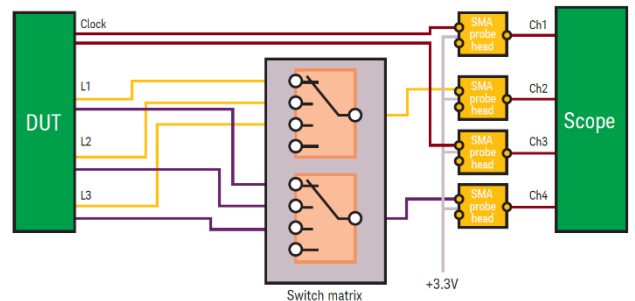

Typical switch configuration for HDMI testing

Maintain accuracy

The framework fully supports Keysight's PrecisionProbe software (N2809A) and InfiniiSim software (N5465A). This gives you the ability to characterize every switch path to the device under test (both magnitude and skew) and ensure that all of them maintain the same level of accuracy.

Customize your testing

Use the remote programming interface (standard feature on the UXR-Series) and N5467B user-defined application for device control, instrument control and test customization.

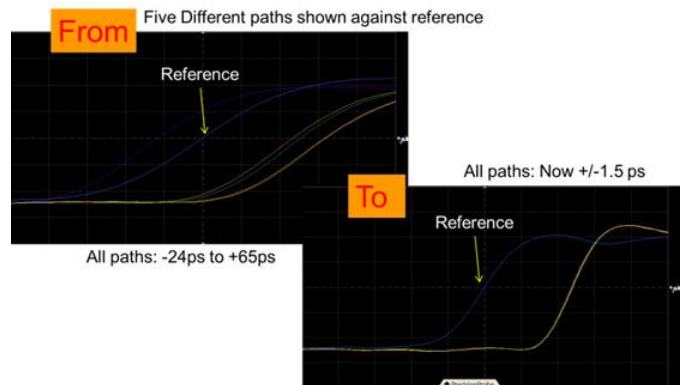

Skews between switch paths are easily maintained with Keysight's unique Infiniium software

Compliance and Automated Testing

Today's demanding environment means you have much less time to understand the intricacies of the technologies you are testing. You also have less time to develop and test automation software that is designed to increase measurement throughput and decrease time to market. Compliance applications save you time and money with measurement automation built into the compliance application. No longer do valuable resources need to be exclusively tied to writing automation software. Instead they can be deployed to designing the next big project.

Infiniium's compliance applications are fully functional with design tools such as ADS. Imagine running your waveforms at design through the entire suite of compliance tests, giving more insight earlier than was previously possible. As the design moves to silicon and then to validation, the same suite of tests can be run live on your device.

Compliance applications that run on UXR-Series oscilloscopes are certified to test to the exact specifications of each technology standard. If a test passes on the UXR-Series scope in your lab, you can be assured that it will pass in test labs and at plug fests worldwide. Keysight experts on technology boards and industry standards committees help define compliance requirements. As a result, you can be sure that UXR-Series oscilloscope tools deliver to critical specifications. Setup wizards combined with intelligent test filtering give you confidence you're running the right tests. Comprehensive HTML reports with visual documentation and pass/fail results guarantee that critical information is retained on each test.

Quick and easy automated switching

Only Keysight's UXR-Series oscilloscopes feature compliance applications with both the user-defined application's add-in capability and integrated PrecisionProbe compensation. Switch paths can vary in their characteristics and have unwanted loss. By enabling PrecisionProbe in its compliance applications, UXR-Series scopes allow you to characterize and compensate for every path in the switch, making every path's frequency response identical in both magnitude and phase. These tools make switch automation quick and painless. The UXR-Series and its compliance applications make automation more automated than ever. Your technicians no longer need to spend valuable time physically changing connections.



Compliance applications make testing technologies standards easy

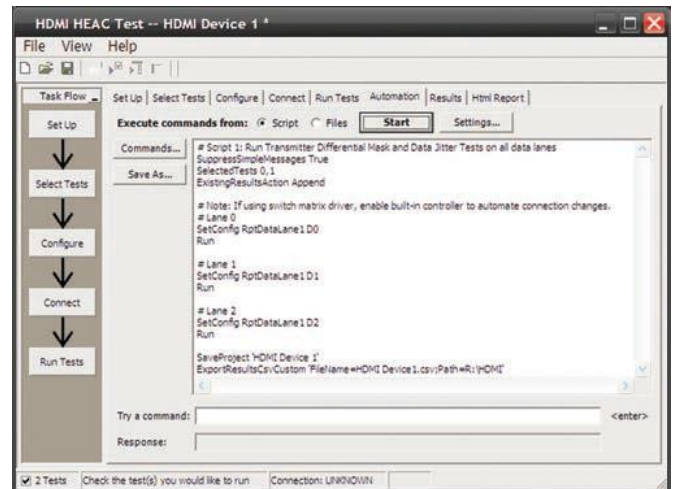

The remote programming interface makes it easy to control automation



PrecisionProbe is fully integrated in automation applications

Compliance and Automation Testing: User-Defined Application (D9010UDAA)

Custom automation for your UXR-Series oscilloscope

The user-defined application is the only fully customizable automated environment made for an oscilloscope by an oscilloscope designer. It provides full automation, including the ability to control other Keysight instruments, external applications such as MATLAB and your DUT software.

Simplify your automation

The user-defined application (UDA) makes automation simple. The application takes the Infiniium compliance application framework and gives you full access to its interface. UDA allows for automation testing in as little as one minute. Use UDA to control other Keysight instruments such as signal generators and network analyzers to create a full suite of measurements.

Full measurement report

No automation would be complete without a simple-to-view and easy-to-understand report. UDA provides a full report of the pass/fail criteria you have provided.

Add-in capability

Ever wanted to add testing to your compliance applications? All Infiniium compliance applications support the industry's most flexible testing mechanism with UDA add-in capability. Create the custom testing you need and then plug it into your compliance application to expand the application to your testing needs. UDA add-in capability is available only on Infiniium oscilloscopes.

PrecisionProbe and switch compatibility

UDA makes automation of switches in your system simple and accurate. Use PrecisionProbe to characterize the path of the switch and then let UDA's unique GUI switch between every input in your switch system. Every input can look identical in its frequency response thanks to this advanced technology.

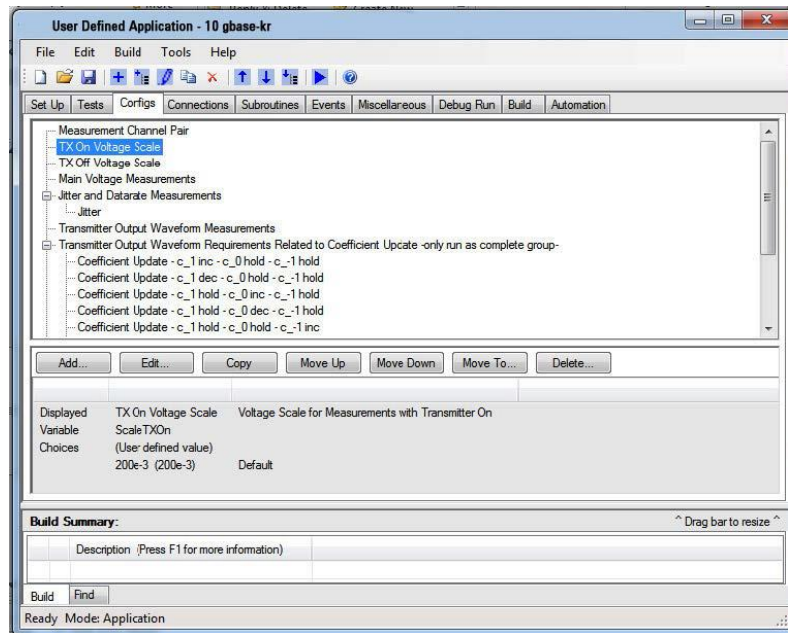

Customize your own tests and requirements with user-defined application in the familiar Keysight framework

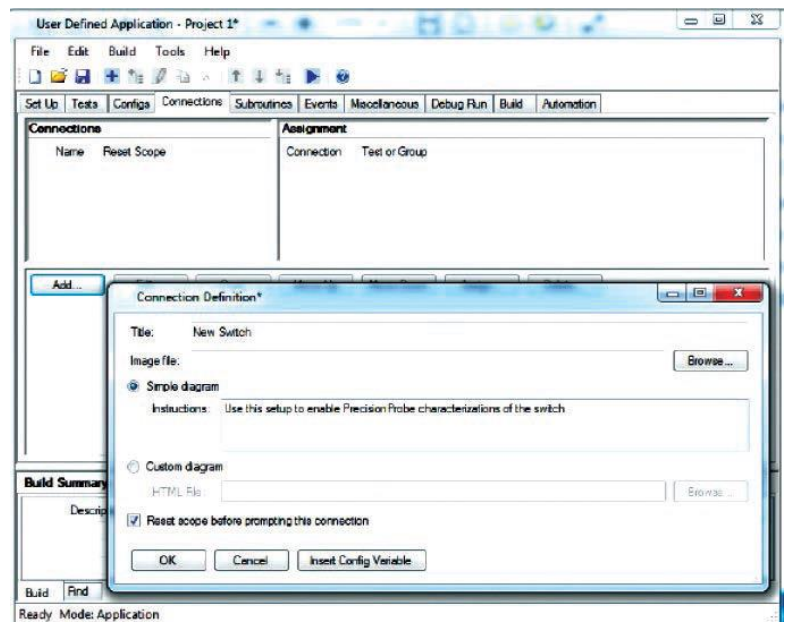

Add a switch when testing your multi-lane signals to automate tedious test requirements

Protocol Analysis

Infiniium UXR-Series oscilloscopes supports more than 20 different advanced protocol decoders, including the industry's first 64/66b decoder. The UXR-Series protocol tools feature time-correlated markers that let you easily move between the listing window and the waveform. Protocol tools can be used on up to four lanes simultaneously.

These unique tools feature search and trigger capability that lets you scan through the waveform to find the trigger condition that interests you. Protocol tools are fully compatible with Infiniium's serial data analysis and are also available on the Infiniium offline tool.



UXR-Series 25 GHz 4-channel model decoding PCI Express Gen 3 packets.

Configure your ultra-high-performance real-time oscilloscope solution today

With an Infiniium UXR you can do what has never been done

Get the most out of your oscilloscope investment by choosing options and software to speed your most common tasks. Use option numbers when ordering at time of purchase. Use model numbers to add to an existing scope.

1. Choose your Infiniium UXR Real-Time Oscilloscope

UXR-Series Oscilloscope Models		Maximum Bandwidth	Input Connector	Minimum Input Power Required		Maximum Sample Rate
4 Channel	2 Channel			4 Channel	2 Channel	
UXR1104A	UXR1102A	110 GHz	1 mm	200 V _{ac}	110 V _{ac}	256 GSa/s
UXR1004A	UXR1002A	100 GHz	1 mm			
UXR0804A	UXR0802A	80 GHz	1 mm			
UXR0704A	UXR0702A	70 GHz	1.85 mm			
UXR0594AP	UXR0592AP	59 GHz	1 mm			
UXR0594A	UXR0592A	59 GHz	1.85 mm			
UXR0504A	UXR0502A	50 GHz	1.85 mm			
UXR0404A	UXR0402A	40 GHz	1.85 mm			
UXR0334A	N/A	33 GHz	3.5 mm	100 V _{ac}	N/A	128 GSa/s
UXR0254A		25 GHz	3.5 mm			
UXR0204A		20 GHz	3.5 mm			
UXR0164A		16 GHz	3.5 mm			
UXR0134A		13 GHz	3.5 mm			

All models come standard with:

- 200 Mpts of hybrid memory cube deep memory
- A removable 960GB Enterprise grade SSD 2.5" hard drive
- Country-specific power cord, front cover, mini USB keyboard, USB optical mouse, input-specific connector savers (one per channel), input-specific torque wrench(es), and an ESD mat with wrist and heel straps.

2. Choose your Optional Memory Upgrade

Memory per scope channel	Option numbers (for new UXR oscilloscopes)
1 Gpt per channel High Performance Memory	UXR0000-01G
2 Gpts per channel High Performance Mmemory	UXR0000-02G

3. Choose your Infiniium Probes and Probe Accessories

See [page 18](#) for supported probing options.

For more information about Infiniium Oscilloscope Probes and Accessories – Data Sheet, view the Keysight publication number 5968-7141EN.

For more information about InfiniiMax III/III+ Probing System – Data Sheet, view the Keysight publication number 5990-5653EN.

*13 GHz UXR-Series models (UXR0134A) come standard with two Precision BNC adaptors (N5442A)

4. Choose your Optional UXR Oscilloscope Accessories

Model numbers	Description
N2125A	Infiniium UXR Real-Time Oscilloscope Calibration Module, 1 mm
N2126A	Infiniium UXR Real-Time Oscilloscope Calibration Module, 1.85 mm
N2127A	Infiniium UXR Real-Time Oscilloscope Calibration Module, 3.50 mm
N2131A-01T	Additional removable SSD for Infiniium UXR Real-Time Oscilloscope – 960GB
N2156A	Rack mount kit for Infiniium UXR Real-Time Oscilloscopes
N2158A	UXR Real-Time Oscilloscope Transportation case
1181BZ	Testmobile System Cart
Y1900B	1 mm F Ruggedized to 1 mm F connector saver
Y1900C	1 mm F Ruggedized to 1 mm M connector saver
Y1901B	1 mm F Ruggedized to 1.85 mm F connector saver
Y1903B	1 mm F Ruggedized to 2.92 mm F connector saver
85058-60114	1.85 mm F to F Adapter Assembly
11904A	2.4 mm M to 2.92 M
11904B	2.4 mm F to 2.92 mm F
11904C	2.4 mm M to 2.92 F
11904D	2.4 mm F to 2.92 mm M
54916-68717	3.5 mm F to 3.5 mm F - kit of 5
N2806A	Calibration Pulse Generator
N2806A-OPT	Add cable N2814A option to N2806A calibration pulse generator
N2161A	Accessory Kit for D9010DMBA Precision Probe and V/Z/UXR Series Scopes <= 33GHz

5. Choose your Infiniium Measurement, Analysis, and Decode Software Options

All Infiniium UXR models come standard with:

- Serial data analysis (SDA) software to provide flexible clock recovery including 1st and 2nd-order PLL and constant algorithms. With a stable clock, you can look at real-time eyes of transition and non-transition bits. UXR-Series scopes with SDA software also provide a new unique view of bits preceding an eye
- User defined function

Each of the Infiniium measurement, analysis and decode software options are offered as perpetual or time-based (subscription) licenses, as described in the tables and examples below. A valid support contract is included in the pricing for the term of any time-based licenses. For perpetual license holders, a separate support contract is required to access Keysight technical support and receive software updates.

Model numbers	Measurement and Analysis Software Options
D9010ASIO	Infiniium Offline - Adv Signal Integrity Software (InfiniiSim Adv/EQ/Crosstalk)
D9010BSEO	Infiniium Offline - Base Software
D9010HSPO	Infiniium Offline - High Speed Protocol Software Bundle
D9010JITO	Infiniium Offline - EZJIT Complete Software
D9010LSPO	Infiniium Offline - Low Speed Protocol Software Bundle
D9010DMBA	De-embedding Software (Precision Probe, InfiniiSim Basic)
D9010EXMA	External Mixer Assistant Software
D9010PAMA	Pulse Amplitude Modulation PAM-N Analysis Software
D9010POWA	Power Integrity Analysis Software
D9010UDAA	User Defined Application Software
D9020JITA	EZJIT Complete - Jitter and Vertical Noise Analysis Software for V/Z/UXR-Series
D9020SCNA	InfiniiScan Event Identification Software for V/Z/UXR-Series
D9020ASIA	Advanced Signal Integrity Software (EQ, InfiniiSimAdv, Crosstalk)

Model numbers	Protocol Decode Bundle Software Options
D9010AUTP	Automotive Protocol Decode/Trigger Software (CAN, LIN, CAN-FD, FlexRay ...)
D9010BDLP	Protocol Decode/Trigger Software Bundle (Low Speed, Auto, MIPI, Military ...)
D9010EKRP	10G/100GBASE-KR 64b/66b and Link Training Decode/Trigger Software
D9010EMBP	Embedded Protocol Decode/Trigger Software (USB2.0, 10/100 ETH, PCIe 2/1 ...)
D9010LSSP	Low Speed Protocol Decode/Trigger Software (I2C, SPI, RS232, I2S, JTAG ...)
D9010MCDP	MIPI CSI and DSI Protocol Decode/Trigger Software (C-PHY and D-PHY)
D9010MILP	Military Protocol Decode/Trigger Software (ARINC 429, MIL-STD 1553, SpaceWire)
D9010MPLP	Low Speed MIPI Protocol Decode/Trigger Software (RFFE, I3C, SPMI)
D9010MPMP	MIPI M-PHY Protocol Decode/Trigger Software (DigRF,LLI,CSI-3,UniPro,UFS,SSIC)
D9010PCIP	Advanced PCIe Protocol Decode/Trigger Software (PCIe 4/3/2/1, SATA/SAS)
D9010USBP	USB 3.x Protocol Decode/Trigger Software (USB 3.1 - 5 and 10 Gbps)

Flexible Software Licensing and KeysightCare Software Support Subscriptions

Keysight offers a variety of flexible licensing options to fit your needs and budget. Choose your license term, license type, and KeysightCare software support subscription.

License Terms

Perpetual – Perpetual licenses can be used indefinitely.

Time-based – Time-based licenses can be only be used through the term of the license (6, 12, 24, or 36 months license options available).

License Types

Node-locked – License can be used on one specified instrument/computer.

Transportable – License can be used on one instrument/computer at a time but may be transferred to another using Keysight Software Manager (Internet connection required).

USB Portable – License can be used on one instrument/computer at a time but may be transferred to another using a certified USB dongle (available for additional purchase with Keysight part number E8900-D10).

Floating (single site) – Networked instruments/computers can access a license from a server one at a time. Multiple licenses can be purchased for concurrent usage.

KeysightCare Software Support Subscriptions

Perpetual licenses are sold with a 12 (default), 24, 36, or 60-month software support subscription. Support subscriptions can be renewed for a fee after that.

Time-based licenses include a software support subscription through the term of the license.

KeysightCare Software Support Subscription provides peace of mind amid evolving technologies

- Ensure your software is always current with the latest enhancements and measurement standards.
- Gain additional insight into your problems with live access to our team of technical experts.
- Stay on schedule with fast turnaround times and priority escalations when you need support.

Selecting your license:

- Step 1.** Choose your software product (eg. S1234567A).
- Step 2.** Choose your license term: perpetual or time-based.
- Step 3.** Choose your license type: node-locked, transportable, USB portable, or floating.
- Step 4.** Depending on the license term, choose your support subscription duration.

Examples:

If you selected:	Your quote will look like:	
	Part Number	Description
D9020JITA node-locked perpetual license with a 12-month support subscription	D9020JITA	EZJIT Complete - Jitter and Vertical Noise Analysis Software for V/Z/UXR-Series
	R-B5P-001-A	Node-locked perpetual license
	R-B6P-001-L	KeysightCare software support subscription, node-locked-12 months
D9010EKRP transportable time-based 6-month license	Part Number	Description
	D9010EKRP	10G/100GBASE-KR 64b/66b and Link Training Decode/Trigger Software
	R-B4P-001-F	6-months, node-locked, license, KeysightCare software support subscription

To configure your product and request a quote:

<http://www.keysight.com/find/software>

Contact your Keysight representative or authorized partner for more information or to place an order:

www.keysight.com/find/contactus

6. Choose your Infiniium Compliance Test and Validation Software Options

Description	License Type		
	Fixed	Floating	Server Based
BroadR-Reach	N6467A-1FP	N6467A-1TP	N5435A-062
Compliance Application Switch Matrix	N8890A-1FP	N8890A-1TP	N5435A-124
DDR1 and LPDDR1	U7233A-1FP	U7233A-1TP	N5435A-021
DDR2 and LPDDR2 Compliance Test Application	N5413B-1FP	N5413B-1TP	N5435A-037
DDR2 and LPDDR2 Debug Tool	N5413B-3FP	N5413B-3TP	N5435A-136
DDR3 and LPDDR3 Compliance Test Application	U7231B-1FP	U7231B-1TP	N5435A-053
DDR3 and LPDDR3 Debug Tool	U7231B-3FP	U7231B-3TP	N5435A-137
DDR4 and LPDDR4 Compliance Test Application	N6462A-1FP	N6462A-1TP	N5435A-087
DDR4 and LPDDR4 Data Analytics Web Service	N6462A-5FP	N6462A-5TP	N5435A-108
DDR4 Debug Tool	N6462A-3FP	N6462A-3TP	N5435A-138
LPDDR4 Debug Tool	N6462A-4FP	N6462A-4TP	—
DisplayPort 1.4	U7232E-1FP	U7232E-1TP	N5435A-041
eDP 1.4	N6469A-1FP	N6469A-1TP	N5435A-083
eMMC	N6465A-1FP	N6465A-1TP	N5435A-061
IEEE802.3bs/cd Compliance Application	N6472A-1FP	N6472A-1TP	N5435A-130
Ethernet + EEE 10/100/1000BASE-T	N5392B-1FP	N5392B-1TP	N5435A-060
Ethernet 10GBASE-T	U7236A-1FP	U7236A-1TP	N5435A-023
Ethernet nBASE-T 2.5G Compliance Software	U7236A-6FP	U7236A-6TP	N5435A-098
Ethernet nBASE-T 5G Compliance Software	U7236A-5FP	U7236A-5TP	N5435A-097
Ethernet MGBASE-T 2.5G Compliance Software	U7236A-4FP	U7236A-4TP	N5435A-100
Ethernet MGBASE-T 5G Compliance Software	U7236A-3FP	U7236A-3TP	N5435A-099
Ethernet 10GBASE-KR	N8814B-1FP	N8814B-1TP	N5435A-059
Ethernet 100GBASE-CR10	N8828A-1FP	N8828A-1TP	N5435A-078
Ethernet 100GBASE-CR4	N8830A-1FP	N8830A-1TP	N5435A-080
Ethernet 100GBASE-KR4	N8829A-1FP	N8829A-1TP	N5435A-079
Ethernet CAUI-4 Compliance Application	N8841A-1FP	N8841A-1TP	N5435A-102
GDDR5 Compliance Test Application	U7245A-1FP	U7245A-1TP	N5435A-139
HDMI 1.4	N5399C-3FP	N5399C-3TP	—
HDMI 2.0	N5399C-1FP	N5399C-1TP	N5435A-070
MHL 3.0	N6460B-1FP	N6460B-1TP	N5435A-078
MIPI C-PHY	U7250A-1FP	U7250A-1TP	N5435A-089
MIPI D-PHY	U7238C-1FP	U7238C-1TP	N5435A-022
MIPI M-PHY	U7249C-1FP	U7249C-1TP	N5435A-043
MOST	N6466A-1FP	N6466A-1TP	N5435A-068
OIF-CEI 4.0 Compliance Application	N6473A-1FP	N6473A-1TP	N5435A-131
ONFI Compliance Test	N6474A-1FP	N6474A-3FP	N5435A-132
PCIe 3.x (2.5G, 5G, 8G) Compliance Application	N5393F-3FP	N5393F-3TP	N5435A-113
PCIe 4.0 (2.5G, 5G, 8G, 16G) Compliance Application	N5393F-1FP	N5393F-1TP	N5435A-112
SAS-3	N5412E-3FP	N5412E-3TP	N5435A-073
SAS-4	N5412E-1FP	N5412E-1TP	N5435A-111
SATA 6Gb/s compliance application	N5411B-1FP	N5411B-1TP	N5435A-028
SFP+	N6468A-1FP	N6468A-1TP	N5435A-074
Thunderbolt 3	N6470B-1FP	N6470B-1TP	N5435A-120
USB 2.0	N5416A-1FP	N5416A-1TP	N5435A-017
USB 3.1: 5 Gbps only Transmitter Compliance	U7243C-3FP	U7243C-3TP	N5435A-030
USB 3.1: 5 Gbps and 10 Gbps Transmitter Compliance	U7243C-1FP	U7243C-1TP	N5435A-118
UHS-I	U7246A-1FP	U7246A-1TP	—
UHS-II	N6461A-1FP	N6461A-1TP	N5435A-052
User-defined application	N5467B-1FP	N5467B-1TP	N5435A-058
User-defined function and MATLAB Bundle	N8806A-1FP	N8806A-1FP	—
XAUI	N5431A-1FP	N5431A-1TP	N5435A-018

7. Choose your Advanced Mathematics Options

Description (Legacy Software Options)	License Type		
	Fixed	Floating	Server Based
MATLAB - Basic digital analysis	N8831A-001	—	—
MATLAB - Standard digital analysis	N8831A-002	—	—

Legacy Infiniium software support

Infiniium UXR-Series oscilloscopes maintain backward compatibility with legacy Infiniium software applications and decode packages. A valid support contract will be required to receive and use software updates or receive product support for legacy Infiniium software.

For more information about all available Infiniium software and options please visit:

<https://www.keysight.com/en/pc-1152185/oscilloscope-software>

8. Choose your Infiniium UXR Support, Services and Training Options

Gain business value and a clear advantage in product performance and reliability with Keysight Services.

Model numbers	Description
R-51B-001-3C	Warranty Assurance Plan - Return to Keysight - 3 years
R-51B-001-5C	Warranty Assurance Plan - Return to Keysight - 5 years
R-50C-001-3	Calibration Assurance Plan - Return to Keysight - 3 years
R-50C-001-5	Calibration Assurance Plan - Return to Keysight - 5 years
PS-S10	Remote scheduled productivity assistance. Select 1 to 999 hours.
PS-S20	On site startup assistance, daily
PS-T10-SCOPES	On site 0.5 day - H7240B-100 - Digitizing Oscilloscope Fundamentals class. Max 8 students.
PS-X10	Custom services

Upgrade your Existing UXR Oscilloscope Hardware

Upgrade your Existing UXR Oscilloscope Memory

Memory upgrade model numbers	Description
N2130A-01G	Memory upgrade from 200 Mpts to 1 Gpts per channel
N2130A-02G	Memory upgrade from 1 Gpt to 2 Gpts per channel

Upgrade your Existing UXR Oscilloscope Bandwidth

Bandwidth upgrade model numbers	Description
N2129BU-003	Bandwidth upgrade – 4-Channel Infiniium UXR – 13 GHz to 16 GHz
N2129BU-004	Bandwidth upgrade – 4-Channel Infiniium UXR – 16 GHz to 20 GHz
N2129BU-005	Bandwidth upgrade – 4-Channel Infiniium UXR – 20 GHz to 25 GHz
N2129BU-006	Bandwidth upgrade – 4-Channel Infiniium UXR – 25 GHz to 33 GHz
N2129BU-007	Bandwidth upgrade – 4-Channel Infiniium UXR – 33 GHz to 40 GHz
N2129BU-008	Bandwidth upgrade – 2-Channel Infiniium UXR – 40 GHz to 50 GHz
N2129BU-009	Bandwidth upgrade – 2-Channel Infiniium UXR – 50 GHz to 59 GHz
N2129BU-010	Bandwidth upgrade – 2-Channel Infiniium UXR – 59 GHz to 70 GHz
N2129BU-011	Bandwidth upgrade – 2-Channel Infiniium UXR – 70 GHz to 80 GHz
N2129BU-012	Bandwidth upgrade – 2-Channel Infiniium UXR – 80 GHz to 100 GHz
N2129BU-013	Bandwidth upgrade – 2-Channel Infiniium UXR – 100 GHz to 110 GHz
N2129BU-014	Bandwidth upgrade – 4-Channel Infiniium UXR – 40 GHz to 50 GHz
N2129BU-015	Bandwidth upgrade – 4-Channel Infiniium UXR – 50 GHz to 59 GHz
N2129BU-016	Bandwidth upgrade – 4-Channel Infiniium UXR – 59 GHz to 70 GHz
N2129BU-017	Bandwidth upgrade – 4-Channel Infiniium UXR – 70 GHz to 80 GHz
N2129BU-018	Bandwidth upgrade – 4-Channel Infiniium UXR – 80 GHz to 100 GHz
N2129BU-019	Bandwidth upgrade – 4-Channel Infiniium UXR – 100 GHz to 110 GHz
N2157A-005	Infiniium UXR 59AP Model bandwidth upgrade – 2-Channel – 59 GHz to 70 GHz
N2157A-006	Infiniium UXR 59AP Model bandwidth upgrade – 4-Channel – 59 GHz to 70 GHz
N2157A-007	Infiniium UXR 70AP Model bandwidth upgrade – 2-Channel – 70 GHz to 80 GHz
N2157A-008	Infiniium UXR 70AP Model bandwidth upgrade – 4-Channel – 70 GHz to 80 GHz

Upgrade your Existing UXR Oscilloscope Channels

Channel upgrade model numbers	Description
N2129BU-030	Upgrade from 2 channels to 4 channels – for 40 GHz Infiniium UXR
N2129BU-031	Upgrade from 2 channels to 4 channels – for 50 GHz Infiniium UXR
N2129BU-032	Upgrade from 2 channels to 4 channels – for 59 GHz Infiniium UXR
N2129BU-033	Upgrade from 2 channels to 4 channels – for 70 GHz Infiniium UXR
N2129BU-034	Upgrade from 2 channels to 4 channels – for 80 GHz Infiniium UXR
N2129BU-035	Upgrade from 2 channels to 4 channels – for 100 GHz Infiniium UXR
N2129BU-036	Upgrade from 2 channels to 4 channels – for 110 GHz Infiniium UXR

Vertical System – Performance Characteristics (3.5 mm input models – AutoProbe II)

Vertical System Specifications (13 GHz to 33 GHz models)	UXR0134A	UXR0164A	UXR0204A	UXR0254A	UXR0334A
Full bandwidth analog input channels	4	4	4	4	4
Analog input connector	Ruggedized 3.5 mm Male - with AutoProbe II jack				
Analog bandwidth (3 dB)					
Typical bandwidth	13.6 GHz	16.8 GHz	21.0 GHz	26.2 GHz	33.0 GHz
Warranted bandwidth*	13.0 GHz	16.0 GHz	20.0 GHz	25.0 GHz	32.0 GHz
Sample rate per channel	128 GSa/s	128 GSa/s	128 GSa/s	128 GSa/s	128 GSa/s
Rise time/fall time					
10 to 90% ⁴	33.8 ps	27.5 ps	22.0 ps	17.6 ps	13.3 ps
20 to 80% ⁵	23.9 ps	19.4 ps	15.6 ps	12.4 ps	9.4 ps
Input impedance ¹	50 Ω, ± 3%				
Displayed input sensitivity ²	1 mV/div to 1 V/div				
Hardware sensitivity ²	32 mV full scale to 8.0 V full scale				
Input coupling	DC				
Vertical resolution ^{2,3}	10 bits, ≥ 14 bits with averaging				
DC gain accuracy ^{*,1,2,3}	± 1.5% of full scale (Typical: ±1% of full scale ≤ 10 mV/div, ±0.5% of full scale >10 mV/div)				
Maximum input voltage	± 8 divisions from center screen				
ENOB typical ⁶					
at ≥400 mV _{fs}	6.8	6.7	6.5	6.2	5.9
at 40 mV _{fs}	6.1	6.0	5.8	5.6	5.3
Channel to channel isolation	Channel to Channel (with equal V/div settings): 1-3, 1-4, 2-3, and 2-4: 60 dB Channel to Channel (with equal V/div settings): 1-2, 3-4: 40 dB				
Offset range	Vertical sensitivity		Available offset		
	1 mV/div to 54 mV/div		± 0.40 V		
	55 mV/div to 93 mV/div		± 0.70 V		
	94 mV/div to 172 mV/div		± 1.25 V		
	173 mV/div to 306 mV/div		± 2.25 V		
	307 mV/div to 1000 mV/div		± 4.00 V		
Offset accuracy ^{*,1,2,3}	± 1% of channel offset + 1% of full scale				
Offset accuracy (typical)	± 1% of channel offset + 0.5% of full scale				
Input range	± 4 divisions from center screen				
DC voltage accuracy					
Dual Cursor:	± [(DC gain accuracy) + (resolution)]				
Single Cursor:	± [(DC gain accuracy) + (offset accuracy) + (resolution/2)]				

* Denotes warranted specifications, all others are typical. Specifications are valid after 30-minute warm up period and ± 5°C from oscilloscope firmware calibration temperature

¹ Input impedance is valid when V/div scaling is adjusted to show all waveform vertical values within scope display

² Full scale is defined as 8 vertical divisions. Magnification is used below 10 mV/div. Below 10 mV/div, full scale is defined as 80 mV. The major scale settings are 1 mV/div, 2 mV/div, 5 mV/div, 10 mV/div, 20 mV/div, 50 mV/div, 100 mV/div, 200 mV/div, 500 mV/div and 1V/div. Magnification scales of 1mV/div, 2mV/div & 5mV/div are not warranted for Offset Accuracy & DC Gain Accuracy

³ Vertical resolution for 10 bits = 0.1% of full scale, for 14 bits = 0.006% of full scale

⁴ Calculation based on Tr = 0.44/BW

⁵ Calculation based on Tr = 0.31/BW

⁶ The average value from DC to full bandwidth of model

Vertical System – Performance Characteristics (1.85 mm input models – AutoProbe III)

Vertical System Specifications (40 GHz to 70 GHz models)	UXR0404A / UXR0402A	UXR0504A / UXR0502A	UXR0594A / UXR0592A	UXR0704A / UXR0702A
Full bandwidth analog input channels	4 / 2	4 / 2	4 / 2	4 / 2
Analog input connector	1.85 mm Male - with AutoProbe III jack			
Analog bandwidth (3 dB)				
Typical bandwidth	42.0 GHz	52.5 GHz	61.9 GHz	70.3 GHz
Warranted bandwidth*	40.0 GHz	50.0 GHz	59.0 GHz	67.0 GHz
Sample rate per channel	256 GSa/s	256 GSa/s	256 GSa/s	256 GSa/s
Rise time/fall time				
10 to 90% ⁴	11.0 ps	8.8 ps	7.5 ps	6.3 ps
20 to 80% ⁵	7.8 ps	6.2 ps	5.3 ps	4.4 ps
Input impedance ¹	50 Ω, ± 3%			
Displayed input sensitivity ²	1 mV/div to 500 mV/div			
Hardware sensitivity ²	60 mV full scale to 4.0 V full scale			
Input coupling	DC			
Vertical resolution ^{2,3}	10 bits, ≥ 14 bits with averaging			
DC gain accuracy ^{*,1,2,3}	± 2% of full scale (Typical: ±1% of full scale)			
Maximum input voltage	± 8 divisions from center screen			
ENOB typical ⁶				
at ≥400 mV _{fs}	5.8	5.6	5.5	5.4
at 60 mV _{fs}	5.4	5.2	5.1	5.0
Channel to channel isolation	60 dB			
Offset range	Vertical sensitivity		Available offset	
	1 mV/div to 59 mV/div		± 0.40 V	
	60 mV/div to 127 mV/div		± 0.86 V	
	128 mV/div to 279 mV/div		± 1.85 V	
	280 mV/div to 500 mV/div		± 4.00 V	
Offset accuracy ^{*,1,2,3}	± 2% of channel offset + 1% of full scale			
Offset accuracy (typical)	± 1% of channel offset + 1% of full scale			
Input range	± 4 divisions from center screen			
DC voltage accuracy				
Dual Cursor:	± [(DC gain accuracy) + (resolution)]			
Single Cursor:	± [(DC gain accuracy) + (offset accuracy) + (resolution/2)]			

* Denotes warranted specifications, all others are typical. Specifications are valid after 30-minute warm up period and ± 5°C from oscilloscope firmware calibration temperature

¹ Input impedance is valid when V/div scaling is adjusted to show all waveform vertical values within scope display

² Full scale is defined as 8 vertical divisions. Magnification is used below 10 mV/div. Below 10 mV/div, full scale is defined as 80 mV. The major scale settings are 1 mV/div, 2 mV/div, 5 mV/div, 10 mV/div, 20 mV/div, 50 mV/div, 100 mV/div, 200 mV/div and 500 mV/div. Magnification scales of 1mV/div, 2mV/div & 5mV/div are not warranted for Offset Accuracy & DC Gain Accuracy

³ Vertical resolution for 10 bits = 0.1% of full scale, for 14 bits = 0.006% of full scale

⁴ Calculation based on Tr = 0.44/BW

⁵ Calculation based on Tr = 0.31/BW

⁶ The average value from DC to full bandwidth of model

Vertical System – Performance Characteristics (1 mm input models – AutoProbe III)

Vertical System Specifications (59 GHz to 110 GHz models)	UXR0594AP / UXR0592AP	UXR0704AP# / UXR0702AP#	UXR0804A / UXR0802A	UXR1004A / UXR1002A	UXR1104A / UXR1102A
Full bandwidth analog input channels	4 / 2	4 / 2	4 / 2	4 / 2	4 / 2
Analog input connector	Ruggedized 1 mm Male - with AutoProbe III jack				
Analog bandwidth (3 dB)					
Typical bandwidth	61.9 GHz	70.3 GHz	84.0 GHz	105.0 GHz	113.0 GHz
Warranted bandwidth*	59.0 GHz	67.0 GHz	80.0 GHz	100.0 GHz	110.0 GHz
Sample rate per channel	256 GSa/s	256 GSa/s	256 GSa/s	256 GSa/s	256 GSa/s
Rise time/fall time					
10 to 90% ⁴	7.5 ps	6.3 ps	5.5 ps	4.4 ps	4.0 ps
20 to 80% ⁵	5.3 ps	4.4 ps	3.9 ps	3.1 ps	2.8 ps
Input impedance ¹	50 Ω, ± 3%				
Displayed input sensitivity ²	1 mV/div to 500 mV/div				
Hardware sensitivity ²	60 mV full scale to 4.0 V full scale				
Input coupling	DC				
Vertical resolution ^{2,3}	10 bits, ≥ 14 bits with averaging				
DC gain accuracy ^{*,1,2,3}	± 2% of full scale (Typical: ±1% of full scale)				
Maximum input voltage	± 8 divisions from center screen				
ENOB typical ⁶					
at ≥400 mV _{fs}	5.5	5.4	5.3	5.1	5.0
at 60 mV _{fs}	5.1	5.0	4.8	4.4	4.2
Channel to channel isolation	60 dB				
Offset range	Vertical sensitivity		Available offset		
	1 mV/div to 59 mV/div		± 0.40 V		
	60 mV/div to 127 mV/div		± 0.86 V		
	128 mV/div to 279 mV/div		± 1.85 V		
	280 mV/div to 500 mV/div		± 4.00 V		
Offset accuracy ^{*,1,2,3}	± 2% of channel offset + 1% of full scale				
Offset accuracy (typical)	± 1% of channel offset + 1% of full scale				
Input range	± 4 divisions from center screen				
DC voltage accuracy					
Dual Cursor:	± [(DC gain accuracy) + (resolution)]				
Single Cursor:	± [(DC gain accuracy) + (offset accuracy) + (resolution/2)]				

* Denotes warranted specifications, all others are typical. Specifications are valid after 30-minute warm up period and ± 5°C from oscilloscope firmware calibration temperature

Only available as a bandwidth upgrade to 59 GHz 1 mm models

¹ Input impedance is valid when V/div scaling is adjusted to show all waveform vertical values within scope display

² Full scale is defined as 8 vertical divisions. Magnification is used below 10 mV/div. Below 10 mV/div, full scale is defined as 80 mV. The major scale settings are 1 mV/div, 2 mV/div, 5 mV/div, 10 mV/div, 20 mV/div, 50 mV/div, 100 mV/div, 200 mV/div and 500 mV/div. Magnification scales of 1mV/div, 2mV/div & 5mV/div are not warranted for Offset Accuracy & DC Gain Accuracy

³ Vertical resolution for 10 bits = 0.1% of full scale, for 14 bits = 0.006% of full scale

⁴ Calculation based on Tr = 0.44/BW

⁵ Calculation based on Tr = 0.31/BW

⁶ The average value from DC to full bandwidth of model

RMS Noise Floor - Performance Characteristics (Measured)

RMS Noise Floor – 3.5 mm (13 GHz to 33 GHz models)	UXR0134A	UXR0164A	UXR0204A	UXR0254A	UXR0334A
Vertical setting, Full scale					
32 mV _{full scale (fs)}	150 µV (rms)	165 µV (rms)	188 µV (rms)	212 µV (rms)	266 µV (rms)
80 mV _{full scale (fs)}	210 µV (rms)	231 µV (rms)	262 µV (rms)	303 µV (rms)	388 µV (rms)
100 mV _{full scale (fs)}	258 µV (rms)	286 µV (rms)	313 µV (rms)	365 µV (rms)	470 µV (rms)
160 mV _{full scale (fs)}	377 µV (rms)	414 µV (rms)	469 µV (rms)	541 µV (rms)	702 µV (rms)
400 mV _{full scale (fs)}	810 µV (rms)	878 µV (rms)	975 µV (rms)	1.16 mV (rms)	1.48 mV (rms)
800 mV _{full scale (fs)}	1.58 mV (rms)	1.75 mV (rms)	1.92 mV (rms)	2.24 mV (rms)	2.91 mV (rms)
1.6 V _{full scale (fs)}	3.50 mV (rms)	3.77 mV (rms)	4.31 mV (rms)	4.97 mV (rms)	6.48 mV (rms)
4.0 V _{full scale (fs)}	7.86 mV (rms)	8.74 mV (rms)	9.61 mV (rms)	11.2 mV (rms)	14.7 mV (rms)
8.0 V _{full scale (fs)}	15.5 mV (rms)	17.2 mV (rms)	19.2 mV (rms)	22.3 mV (rms)	28.8 mV (rms)

RMS Noise Floor – 1.85 mm (40 GHz to 70 GHz models)	UXR0404A / UXR0402A	UXR0504A / UXR0502A	UXR0594A / UXR0592A	UXR0704A / UXR0702A
Vertical setting, Full scale				
60 mV _{full scale (fs)}	340 µV (rms)	410 µV (rms)	460 µV (rms)	500 µV (rms)
100 mV _{full scale (fs)}	490 µV (rms)	560 µV (rms)	640 µV (rms)	680 µV (rms)
160 mV _{full scale (fs)}	720 µV (rms)	820 µV (rms)	950 µV (rms)	970 µV (rms)
400 mV _{full scale (fs)}	1.6 mV (rms)	1.8 mV (rms)	2.1 mV (rms)	2.2 mV (rms)
800 mV _{full scale (fs)}	3.4 mV (rms)	3.7 mV (rms)	4.3 mV (rms)	4.5 mV (rms)
1.6 V _{full scale (fs)}	6.7 mV (rms)	7.5 mV (rms)	8.4 mV (rms)	9.0 mV (rms)
4.0 V _{full scale (fs)}	16 mV (rms)	18 mV (rms)	20 mV (rms)	21 mV (rms)

RMS Noise Floor – 1.0 mm (59 GHz to 110 GHz models)	UXR0594AP / UXR0592AP	UXR0704AP# / UXR0702AP#	UXR0804A / UXR0802A	UXR1004A / UXR1002A	UXR1104A / UXR1102A
Vertical setting, Full scale					
60 mV _{full scale (fs)}	460 µV (rms)	500 µV (rms)	580 µV (rms)	770 µV (rms)	860 µV (rms)
100 mV _{full scale (fs)}	640 µV (rms)	680 µV (rms)	780 µV (rms)	990 µV (rms)	1.1 mV (rms)
160 mV _{full scale (fs)}	950 µV (rms)	970 µV (rms)	1.1 mV (rms)	1.4 mV (rms)	1.5 mV (rms)
400 mV _{full scale (fs)}	2.1 mV (rms)	2.2 mV (rms)	2.4 mV (rms)	2.8 mV (rms)	2.9 mV (rms)
800 mV _{full scale (fs)}	4.3 mV (rms)	4.5 mV (rms)	4.8 mV (rms)	5.8 mV (rms)	6.1 mV (rms)
1.6 V _{full scale (fs)}	8.4 mV (rms)	9.0 mV (rms)	9.7 mV (rms)	12 mV (rms)	13 mV (rms)
4.0 V _{full scale (fs)}	20 mV (rms)	21 mV (rms)	23 mV (rms)	27 mV (rms)	29 mV (rms)

Only available as a bandwidth upgrade to 59 GHz 1 mm models

Horizontal System – Performance Characteristics

Horizontal System: Oscilloscope channels	
Main timebase range	2 ps/div to 20 s/div real-time (13 GHz to 33 GHz models) 1 ps/div to 20 s/div real-time (40 GHz to 110 GHz models)
Main timebase delay range	200 s to -200 s real-time
Reference position	Continuously adjustable across horizontal display range
Zoom timebase range	1 ps/div to current main timescale setting
Channel de-skew range	± 1 ms range, 10 fs resolution
Time scale accuracy ^{*,1}	± (25 ppb initial + 100 ppb/year aging) first year of manufacture ± (25 ppb initial + 30 ppb/year aging) after first year of manufacture
Intrinsic jitter ³	
Acquired time range / delta-time interval	Internal Reference External Reference
<1 μs (100 ns/div)	25 fs rms 25 fs rms
10 μs (100 μs/div)	25 fs rms 25 fs rms
100 μs (1 μs/div)	40 fs rms 40 fs rms
1 ms (10 μs/div)	50 fs rms 50 fs rms
Inter-channel intrinsic jitter ²	< 10 fs rms
Inter-channel skew drift ^{3,5,6}	± 1 ps
Inter-channel intrinsic skew ³	± 5 ps

* Denotes warranted specification, all others are typical. Specifications are valid after a 30-minute warm-up period and ± 5 °C from calibration temperature.

¹ initial = immediately after factory or user calibration.

² intra-chan = both edges on the same channel, inter-chan = two edges on different channels of the same scope frame.

³ External timebase reference values measured using a Wenzel 501-04608A 10 MHz reference. Intrinsic jitter value depends on acquisition time range for TIE formula and depends on delta-time between edges for all two-edge formulas.

⁵ Scope channels and signal interconnect de-skewed prior to measurement.

⁶ Skew between channels caused by ± 5 deg C temperature change.

Horizontal System – Performance Characteristics (continued)

Horizontal System: Oscilloscope channels	
Jitter measurement floor ^{1,2} (sec rms)	
Time interval error (sec rms)	$\sqrt{\left(\frac{\text{Noise Floor}}{\text{Slew Rate}}\right)^2 + (\text{Intrinsic Jitter})^2}$
Period jitter (sec rms)	$\sqrt{2} \cdot \sqrt{\left(\frac{\text{Noise Floor}}{\text{Slew Rate}}\right)^2 + (\text{Intrinsic Jitter})^2}$
Cycle-cycle / N-cycle jitter (sec rms)	$\sqrt{3} \cdot \sqrt{\left(\frac{\text{Noise Floor}}{\text{Slew Rate}}\right)^2 + (\text{Intrinsic Jitter})^2}$
Inter-channel jitter ² (sec rms)	$\sqrt{\left(\frac{\text{Time Interval}}{\text{Error (Edge1)}}\right)^2 + \left(\frac{\text{Time Interval}}{\text{Error (Edge2)}}\right)^2 + \left(\frac{\text{Inter channel}}{\text{Intrinsic Jitter}}\right)^2}$
Inter-scope jitter ² (sec rms)	
Delta-time measurement accuracy ^{2,3,4,5}	
Intra-channel no averaging	$\pm \left[5 \cdot \sqrt{\left(\frac{\text{Time Interval}}{\text{Error (Edge1)}}\right)^2 + \left(\frac{\text{Time Interval}}{\text{Error (Edge2)}}\right)^2} + \left(\left(\frac{\text{Time Scale}}{\text{Accuracy}}\right) \cdot \left(\frac{\text{Delta}}{\text{Time}}\right) \right) \right]$
Intra-channel 256 averages	$\pm \left[\frac{5}{16} \cdot \sqrt{\left(\frac{\text{Time Interval}}{\text{Error (Edge1)}}\right)^2 + \left(\frac{\text{Time Interval}}{\text{Error (Edge2)}}\right)^2} + \left(\left(\frac{\text{Time Scale}}{\text{Accuracy}}\right) \cdot \left(\frac{\text{Delta}}{\text{Time}}\right) \right) \right]$
Inter-channel no averaging	$\pm \left[5 \cdot \sqrt{\left(\frac{\text{Time Interval}}{\text{Error (Edge1)}}\right)^2 + \left(\frac{\text{Time Interval}}{\text{Error (Edge2)}}\right)^2 + \left(\frac{\text{Inter channel}}{\text{Intrinsic Jitter}}\right)^2} + \left(\left(\frac{\text{Time Scale}}{\text{Accuracy}}\right) \cdot \left(\frac{\text{Delta}}{\text{Time}}\right) + \left(\frac{\text{Inter channel}}{\text{Skew Drift}}\right) \right) \right]$
Inter-channel 256 averages	$\pm \left[\frac{5}{16} \cdot \sqrt{\left(\frac{\text{Time Interval}}{\text{Error (Edge1)}}\right)^2 + \left(\frac{\text{Time Interval}}{\text{Error (Edge2)}}\right)^2 + \left(\frac{\text{Inter channel}}{\text{Intrinsic Jitter}}\right)^2} + \left(\left(\frac{\text{Time Scale}}{\text{Accuracy}}\right) \cdot \left(\frac{\text{Delta}}{\text{Time}}\right) + \left(\frac{\text{Inter channel}}{\text{Skew Drift}}\right) \right) \right]$

¹ Specifications are typical and valid after a 30-minute warm-up period and $\pm 5^\circ\text{C}$ from calibration temperature.

² Scope channels and signal interconnect de-skewed prior to measurement.

³ Sample rate at maximum. Noise and slew rate determined at fixed-voltage measurement threshold, near middle of signal. Displayed signal not vertically clipped.

Slew rate of sine wave = (peak signal amplitude) $\cdot 2 \cdot \pi \cdot f$, slew rate of fast step \approx (10-90% rise time).

⁴ intra-chan = both edges on the same channel, inter-chan = two edges on different channels of the same scope frame, inter-scope = two edges on different scope frames. TIE(Edge1) = time-interval error measurement floor of first edge, TIE(Edge2) = time-interval error measurement floor of second edge.

⁵ Reading is the displayed DTMA measurement value. Do not double the listed TSA value in DTMA formula.

Acquisition System – Performance Characteristics

Acquisition System Specifications	UXR0134A / UXR0164A / UXR0204A / UXR0254A / UXR0334A	UXR040xA / UXR050xA / UXR059xA / UXR059xA / UXR070xA / UXR070xA / UXR070xA / UXR080xA / UXR100xA / UXR110xA
Maximum real-time sample rate	128 GSa/s	256 GSa/s
Sampling resolution	7.8125 ps/Sample	3.90625 ps/Sample
Memory depth per channel		
200 Mpts	Standard	Standard
1 Gpt	Option 01G	Option 01G
2 Gpts	Option 02G	Option 02G
Memory depth (with RT Averaging)		
standard	200 Mpts	200 Mpts
option 01G or 02G	320 Mpts	335.556 Mpts
Acquisition time at max sampling rate		
200 Mpts	1.56 ms	780 µs
1 Gpt	7.8 ms	3.9 ms
2 Gpts	15.6 ms	7.8 ms
Sampling Modes		
Real-time	Successive single shot acquisitions	
Real-time with averaging	Selectable from 2 to 1,048,575	
Real-time with peak detect, Segmented with peak detect	128 GSa/s	256 GSa/s
	Extends acquisition time range by compressing un-aliased full-sample rate waveform samples into voltage range values collected over and reported at larger time intervals	
Real-time with high resolution, Segmented with high resolution	Real-time boxcar averaging reduces random noise and increases resolution	
Segmented Memory	Captures bursting signals at max sample rate without consuming memory during periods of inactivity	
Max # of Segments:	Independent of memory option	
High-bandwidth trigger enabled	25,680	20,825
High-bandwidth trigger disabled	134,885	134,885
Min time between triggers		
High-bandwidth trigger enabled	5.0 µs	
High-bandwidth trigger disabled	3.5 µs	
Max time between triggers	> 100,000 years	
Filters		
Bandwidth limit	Brick wall or 4th order Bessel, selectable bandwidth value	
Frequency response	Flat mag and linear phase, Gaussian mag and linear phase: Slower filter roll off while maintaining linear phase	
Sin(x)/x interpolation	On/off selectable FIR digital filter with selectable 2x to 32x ratio: Digital signal processing adds points between acquired data points to enhance measurement accuracy and waveform display	

Trigger System – Performance Characteristics

Hardware Trigger Specifications	UXR0134A / UXR0164A / UXR0204A / UXR0254A / UXR0334A	UXR040xA / UXR050xA / UXR059xA / UXR059xAP / UXR070xA / UXR070xAP / UXR080xA / UXR100xA / UXR110xA
Trigger sources	All channel inputs, 1 auxiliary trigger input	
Sensitivity	1 div p-p	
Edge trigger bandwidth	Equal to acquisition analog bandwidth	
Edge trigger bandwidth (AUX)	400 MHz	
Minimum pulse width trigger		
Hardware	50 ps	
Software (InfiniiScan)	40 ps	
Level range		
Internal	± 4 div from center screen or ± 4 V, whichever is smaller	
Auxiliary	± 5 V (into 50 Ω), 5 Vpp maximum input signal swing	
Sweep Modes	Auto, triggered, single	
Display jitter (Trigger Jitter)	116 fs (rms) ¹	71 fs (rms) ²
Trigger holdoff range	Fixed 40 ns to 10 s, Random 100 ns to 10 s	
Trigger qualification (AND qualifier)	Qualify a trigger setup by logically ANDing or ORing it with signal levels on analog channels	
Trigger actions	Specify an action to occur (and the frequency of the action) when a trigger conditions occurs. Actions include email on trigger and execute "multipurpose" user setting.	
Trigger Sequences	Sequence triggers let you trigger on an event that follows another event. Three stage trigger sequences including two-stage hardware (find event (A) and trigger event (B)) and one-stage InfiniiScan software trigger. Supports all hardware trigger modes except "edge then edge" and "video" and "Gbit serial." Supports "delay (by time)" and "reset (by time or event)" between two hardware sequences.	
Trigger modes - Hardware		
Burst	Trigger on the Nth edge of a burst that occurs after an idle time from 1.5 ns to 20 s.	
Edge	Triggers on a specified slope (rising, falling or alternating between rising and falling) and voltage level on any channel or auxiliary trigger.	
Edge transition	Trigger on rising or falling edges that cross two voltage levels in > or < the amount of time specified. Edge transition setting from 75 ps	
Edge then edge (Time)	The trigger is qualified by an edge. After a specified time delay between 1.5 ns to 20 s, a rising or falling edge on any one selected input will generate the trigger	
Edge then edge (Event)	The trigger is qualified by an edge. After a specified delay between 1 to 65,000,000,000 rising or falling edges, another rising or falling edge on any one selected input will generate the trigger	
Glitch	Triggers on glitches narrower than the other pulses in your waveform by specifying a width less than your narrowest pulse and a polarity. Triggers on glitches as narrow as 50 ps. Glitch range settings: < 75 ps to < 10 s	

¹ Value shown represents typical Display jitter for UXR0334A at 100 mV/div triggering on 500 mVpp 16 GHz sin wave signal.

² Value shown represents typical Display jitter for UXR1104A at 100 mV/div triggering on 500 mVpp 55 GHz sin wave signal.

Trigger modes – Hardware (Continued)

High-Bandwidth Trigger	Edge trigger up to scopes maximum bandwidth (works with edge positive slope and edge negative slope only)
OR'd Edges	Identifies a trigger condition by looking for selected edges on up to four channels
Pattern / State	Identifies a trigger condition by looking for a specified pattern or a pattern and an edge (state) across the input channels
Pulse width	Trigger on a pulse that is wider or narrower than the other pulses in your waveform by specifying a pulse width and a polarity. Triggers on pulse widths as narrow as 75 ps. Pulse width range settings 75 ps to 20 s. Trigger point can be configured for “end of pulse” or “time out”
Window	Specify a voltage range and then trigger when the waveform either exits this range, enters this range, stays outside the range for too long or too short, or stays inside the range for too long or too short. Range setting from 75 ps to 20 s.
Runt	Trigger on a pulse that crosses one threshold but fails to cross a second threshold before crossing the first again. Can be time qualified with minimum setting of 75 ps
Timeout	Triggers the oscilloscope when the waveform has been at a higher voltage than the voltage specified by the Level control for too long (High Too Long), when the waveform has been at a lower voltage than the Level voltage for too long (Low Too Long), or when the waveform has taken too long to pass through the Level voltage (Unchanged Too Long). Timeout settings from 75 ps to 20 s.
Setup and hold	Trigger on violations of Setup time, Hold time, or both Setup and Hold time. Setup times from 75 ps to 20 s and hold times from 75 ps to 100 ns.
Protocol	Trigger on certain packets or patterns in protocol-based data.

Trigger modes – Software (Requires N5414B InfiniiScan event identification software)

Zone qualify	Software triggers on the user-defined zones on screen. Zones can be specified as either “must intersect” or “must not intersect.” Up to eight zones can be defined across multiple channels
Generic serial	Software triggers on NRZ-encoded data up to 8.0 Gbps, up to 80-bit pattern. Support multiple clock data recovery methods including constant frequency, 1st-order PLL, 2nd-order PLL, explicit clock, explicit 1st-order PLL, explicit 2nd-order PLL, Fibre Channel, FlexRay receiver, FlexRay transmitter
Measurement limit	Software triggers on the results of the measurement values. For example, when the “pulse width” measurement is turned on, InfiniiScan measurement software trigger triggers on a glitch as narrow as 40 ps. When the “time interval error (TIE)” is measured, InfiniiScan can trigger on a specific TIE value
Non-monotonic edge	Software triggers on the non-monotonic edge. The non-monotonic edge is specified by setting a hysteresis value
Runt	Software triggers on a pulse that crosses one threshold but fails to cross a second threshold before crossing the first again. Unlike hardware runt trigger, InfiniiScan runt trigger can be further qualified via a hysteresis value

Measurements and Math

Oscilloscope Measurements	
Measurement update rate	> 50,000 measurement/sec (one measurement turned on) > 250,000 measurement/sec/measurement (ten measurements turned on)
Measurement modes	Standard, Measure all edges mode
Jitter analysis measurements ¹	
Clock	Time interval error, N-period, period to period, positive width to positive width, neg width to neg width, and duty cycle to duty cycle
Data	Time interval error, unit interval, N Unit Interval, unit interval to unit interval, data rate, CDR, de-emphasis
Waveform Measurements	
Vertical	Peak to peak, minimum, maximum, average, RMS, amplitude, base, top, overshoot, preshoot, upper, middle, lower, Vovershoot, Vtime, Vpreshoot, crossing, pulse base, pulse amplitude, pulse top, PAM level mean ² , PAM level RMS ² , PAM level skew ² , PAM level thickness ²
Time	Delta time, rise time, fall time, positive width, negative width, burst width, burst period, burst interval, Tmin, Tmax, Tvolt, + pulse count, - pulse count
Clock	Period, frequency, duty cycle, phase, N-period
Data	Setup time, hold time
Mixed	Area, slew rate
Frequency domain	FFT frequency, FFT magnitude, FFT delta frequency, FFT delta magnitude, FFT Channel Power, FFT Power Spectral Density, FFT Occupied Bandwidth, and peak detect mode
Level qualification	Any channels that are not involved in a measurement can be used to level-qualify all timing measurements
Eye-diagram measurements	Eye height, eye width, eye jitter, crossing percentage, Q factor, and duty-cycle distortion
PAM4 measurements ²	Level mean, level RMS, level skew, level thickness, eye height, eye width, eye skew, eye level, BER (Cumulative), BER (Per Acq), SER (Cumulative), SER (Per Acq), PRBS13Q J4u, PRBS13Q Jrms, PRBS13Q EOJ, clock recovery rate, pattern length, rise time, fall time, and time interval error
Statistics	Displays the current, mean, minimum, maximum, range (max-min), standard deviation, number of measurements value for the displayed automatic measurements. Also shows Fail Min and Fail Max when measurement Limit Test is enabled
Histograms	
Source	Waveform or measurement
Orientation	Vertical (for timing and jitter measurements) or horizontal (noise and amplitude change) modes, regions are defined using waveform markers
Measurements (available as a function)	Mean, standard deviation, mean \pm 1, 2, and 3 sigma, median, mode, peak-to-peak, min, max, total hits, peak (area of most hits), X scale hits, and X offset hits
Mask testing	Allows pass/fail testing to user-defined or Keysight-supplied waveform templates. Automask lets you create a mask template from a captured waveform and define a tolerance range in time/voltage or screen divisions. Test modes (run until) include test forever, test to specified time or event limit, and stop on failure. Executes “multipurpose” user setting on failure “Unfold real-time eye” feature allows individual bit errors to be observed by unfolding a real-time eye when clock recovery is on Communications mask test kit option provides a set of ITU-T G.703, ANSI T1.102, and IEEE 802.3 industry-standard masks for compliance testing

¹ Requires EZJIT Complete analysis application (D9010JITA)

² Requires PAM4 analysis application (D9010PAMA)

Oscilloscope Measurements (continued)

Waveform math	
Number of functions	16
Hardware accelerated math operations	Differential and Common Mode
Math functions	Absolute value, add, amplitude demodulation (radar envelope), average, Butterworth ¹ , common mode, delay, differentiate, divide, FFT magnitude, FFT, phase, FIR ¹ , high pass filter, histogram, horizontal gating, integrate, invert, LFE ¹ , low pass filter (4th-order Bessel Thompson filter), magnify, max, measurement trend, min, multiply, RT Eye ¹ , smoothing, SqrtSumOfSquare ¹ , square, square root, subtract, versus, and optional user defined function
FFT	
Frequency range	DC to scope's maximum bandwidth
Frequency resolution	Sample rate/memory depth = resolution
Window modes	Hanning, flattop, rectangular, Blackman-Harris, Hamming
Measurement modes	
Automatic measurements	Measure menu access to all measurements, up to 20 measurements can be displayed simultaneously
Multipurpose	Front-panel button activates up to ten pre-selected or up to ten user-defined automatic measurements
Drag-and-drop measurement toolbar	Measurement toolbar with common measurement icons that can be dragged and dropped onto the displayed waveforms
Marker modes	Manual markers, track waveform data, track measurements, track RF (on FFT math function waveforms)
Bookmarks and callouts	Supports callouts for measurements and FFT peaks. Supports bookmarks for team collaboration

Keysight Infiniium UXR-Series – Platform Characteristics

Computer system and peripherals	
Operating system	Windows 10 64-bit
CPU	Intel i5-3550S quad-core CPU at 3.00 GHz
PC system memory	16 GB DDR3 RAM
PC ports	USB 2.0 hi-speed (host), USB 2.0 hi-speed (device), VGA, DisplayPort, USB 3.0 (host), USB 3.0 (device), dual-monitor video output, audio, 10/100/1000 LAN, LXI LAN
Drives (SSD)	960GB Enterprise grade internal SSD removable hard drive
Peripherals	Optical USB mouse, compact USB keyboard supplied. All UXR models support any Windows-compatible input device with a USB interface
File types	
Waveforms	Compressed internal format (*.wfm (200 Mpts)), comma-separated values (*.csv (2 Gpts)), tab-separated values (*.tsv (2 Gpts)), public binary format (.bin (500 Mpts)), Y value files (*.txt (2 Gpts)), hierarchal data file (*.hf5 (2 Gpts))
Images	BMP, PNG, TIFF, GIF, JPG or osc file format

I/O Ports	
Aux in	5 Vpp max signal between -5 V and +5 V, 50 Ω impedance
Aux out	0 V to 5 V, 50 Ω impedance
Cal out	-2.4 V to +2.4 V, 50 Ω impedance
Probe compensation terminal	0 V to 5 V, 50 Ω impedance
Reference clock input	400 MHz, 0.25 Vpp to 0.50 Vpp, 50 Ω impedance
Reference clock output	400 MHz, 0.25 Vpp to 0.50 Vpp, 50 Ω impedance
Sample clock input	8 GHz, -5 dBm to +15 dBm, 50 Ω impedance
Sample clock output	8 GHz, +10 dBm to +15 dBm, 50 Ω impedance
Timebase reference input	Input frequency lock range: 10 MHz \pm 20 ppm, 50 Ω impedance Amplitude, sine wave input: 630 mVpp (0 dBm) min to 3.54 Vpp (+15 dBm) max, 50 Ω impedance Amplitude, square wave input: 500 mVpp min to 3.54 Vpp max, 50 Ω impedance
Timebase reference output	Amplitude into 50 Ω (internal or external timebase reference selected): 1.1 to 2.0 Vpp (+ 5 to + 10 dBm) sine wave Frequency (internal timebase reference selected): \pm (25 ppb initial + 100 ppb/year aging) first year of manufacture \pm (25 ppb initial + 30 ppb/year aging) after first year of manufacture Frequency, external timebase reference selected: external reference frequency
Trig out	0 V to 5 V, 50 Ω impedance

Display	
Display	15.4-inch color XGA TFT-LCD with capacitive touch screen
Intensity grayscale	256-level intensity-graded display
Resolution XGA	1024 pixels horizontally x 768 pixels vertically
Annotation	Up to 100 bookmarks can be inserted into the waveform window. Each can float or be tied to a specific waveform
Grids	Choose between 1-16 grids per waveform area, 10-bit vertical resolution
Waveform areas	Supports eight waveform areas plus chart mode for EZJIT, InfiniiSim, protocol, and PrecisionProbe
Waveform styles	Connected dots, dots, infinite persistence, color graded infinite persistence. Includes up to 256 levels of intensity-graded waveforms., variable persistence
Maximum update rate	> 400,000 waveforms per second (when in the segment memory mode)

Keysight Infiniium UXR-Series – General Characteristics

General Characteristics	
Temperature	<p>Operating: 5 to + 40 °C up to 2,000 meters, de-rated between 2,000 and 3,000 meters by 1 °C for every 100 meters</p> <p>Non-operating: –20 to +70 °C</p>
Humidity	<p>Operating: Up to 95% relative humidity (non-condensing) at +40 °C</p> <p>Non-operating: Up to 90% relative humidity at +65 °C</p>
Altitude	<p>Operating: Up to 3,000 meters (9,842 feet); de-rate maximum temperature by 1 °C for every 100 meters above 2,000 meters</p> <p>Non-operating: Up to 4,600 meters (15,090 feet)</p>
Vibration	<p>Operating random: 0.21 g (rms)</p> <p>Non-operating random: 2.0 g (rms)</p> <p>Swept sines: 0.50 g (rms)</p>
Power	<p>UXR0334A, UXR0254A, UXR0204A, UXR0164A, UXR0134A</p> <p>100 to 240 VAC at 50/60 Hz</p> <p>Maximum input power 1350 VA</p>
	<p>UXR1102A, UXR1002A, UXR0802A, UXR0702A/AP, UXR0592A/AP, UXR0502A, UXR0402A</p> <p>110 to 240 VAC at 50/60 Hz</p> <p>Maximum input power 1370 VA</p>
	<p>Well-regulated power is required for 110-120 V operation: Connect only to a 20-amp outlet or a dedicated 15-amp outlet.</p>
	<p>UXR1104A, UXR1004A, UXR0804A, UXR0704A/AP, UXR0594A/AP, UXR0504A, UXR0404A</p> <p>200 VAC to 240 VAC at 50/60 Hz</p> <p>Maximum input power 2615 VA</p>
	<p>Connect only to outlets rated for 15 amps or higher.</p>
Weight	<p>UXR0334A, UXR0254A, UXR0204A, UXR0164A, UXR0134A</p> <p>37.56 kg (82.8 lbs)</p>
	<p>UXR1102A, UXR1002A, UXR0802A, UXR0702A/AP, UXR0592A/AP, UXR0502A, UXR0402A</p> <p>36.15 kg (79.7 lbs)</p>
	<p>UXR1104A, UXR1004A, UXR0804A, UXR0704A/AP, UXR0594A/AP, UXR0504A, UXR0404A</p> <p>42.05 kg (92.7 lbs)</p>
Dimensions	<p>Width: 435 mm with handles removed (17.126") 530 mm with handles (20.866")</p>
	<p>Depth: 513 mm main body (20.197") 560 mm including knobs and rear feet (22.047")</p>
	<p>Height: 311 mm (7U) with feet removed (12.244") The rackmount kit will take up 8U to allow for airflow and cabling 333 mm with feet (13.11")</p>
	<p>Inputs: Connectors are 75 mm apart horizontally on the 4-channel frame and 150 mm apart on the 2-channel frame. Centers are 49 mm above the surface when resting flat (no tilt levers) and 90 mm above the surface when using the front tilt levers.</p> <p>Clearances: Fans draw cool air in from the sides and bottom, and blow it out the back of the oscilloscope. Allow at least 8 inches (203 mm) of clearance from the rear. Side handles provide sufficient airflow clearance side to side.</p>
Safety	<p>CAN/CSA-C22.2 No. 61010-1-12 ANSI/UL Std. No. 61010-1:2012</p>

Definitions

Measured (meas)

An attribute measured during development for purposes of communicating the expected performance. This data is not warranted, does not include measurement uncertainty, and is measured at room temperature (approximately 23°C).

Nominal (nom)

The mean or average characteristic performance, or the value of an attribute that is determined by design such as a connector type, physical dimension, or operating speed. This data is not warranted and is measured at room temperature (approximately 23°C).

Specification (spec)

The warranted performance of a calibrated instrument that has been stored for a minimum of 2 hours within the operating temperature range of 5 – 40°C and after a 30-minute warm up period.

Typical (typ)

The characteristic performance, which 80% or more of manufactured instruments will meet. This data is not warranted, does not include measurement uncertainty, and is valid only at room temperature (approximately 23°C).

Operating frequency range

The operating frequency range is the frequency range of corrected signal spectral components by deembedding for frequency and phase characteristics of the individual hardware.

Analog bandwidth

The analog bandwidth describes the 3 dB bandwidth of the full opto-electronic input path without any frequency or phase corrections.

Sensitivity

The sensitivity limit corresponds to the received signal power at the input interface for which a 32 GBaud DP-QPSK exhibits an EVM of 32.5% or less. An EVM of 32.5% corresponds to a BER of 1E-3 for assumed added Gaussian white noise (AWGN) according to $=0.5 \cdot \text{ERFC}(1/(\text{SQRT}(2) \cdot (\text{EVM}^2 + 1)))$.

Effective Number of Bits (ENOB)

Definition in accordance with IEEE 1057: "For an input sinewave of specified frequency and amplitude, ENOB is the number of bits of an ideal waveform recorder for which the rms quantization error is equal to the rms NAD of the waveform recorder under test."

ENOB is determined by equation.

Additional Products in the Keysight Infiniium Oscilloscope Portfolio

Keysight's Infiniium oscilloscope lineup includes additional oscilloscopes with bandwidths from 500 MHz to 63 GHz. Use the following selection guide to determine which best matches your specific needs. All Infiniium real-time oscilloscopes feature the following:

- Industry's best signal integrity for each family series
- Industry's most advanced probing system
- Industry's most comprehensive software solution

Infiniium Series	S-Series	90000A	V-Series	Z-Series
Available bandwidths	500 MHz, 1 GHz, 2.5 GHz, 4 GHz, 6 GHz, 8GHz	2.5 GHz, 4 GHz, 6 GHz, 8 GHz, 12 GHz, 13 GHz	8 GHz, 13 GHz, 16 GHz, 20 GHz, 25 GHz, 33 GHz	20 GHz, 25 GHz, 33 GHz, 50 GHz, 63 GHz
Maximum upgradeable bandwidth	8 GHz	13 GHz	33 GHz	63 GHz
Maximum sample rate	20 GSa/s	40 GSa/s	80 GSa/s	160 GSa/s
Maximum memory (2-channel)	1 Gpts	1 Gpts	2 Gpts	2 Gpts
Standard memory (2-channel)	100 Mpts	40 Mpts	100 Mpts	100 Mpts
Standard memory (4-channel)	50 Mpts	20 Mpts	50 Mpts	50 Mpts
Channel inputs	50 Ω and 1 M Ω	50 Ω	50 Ω	50 Ω
Connector type	Precision BNC	Precision BNC	3.5 mm	3.5 mm (33 GHz input) 1.85 mm (> 33 GHz input)
Connector mate	BNC	BNC	SMA, 2.92 mm	SMA, 2.92 mm (33 GHz input), 2.4 mm (> 33 GHz input)
MSO models	Yes	No	Yes ²	No
Hardware serial trigger option	No	No	Yes ^{1,2}	No
Supported InfiniiMax probe series	InfiniiMax II	InfiniiMax II InfiniiMax III+	InfiniiMax III/III+ InfiniiMax II with N5442A adapter	InfiniiMax III/III+ InfiniiMax II with N5442A adapter

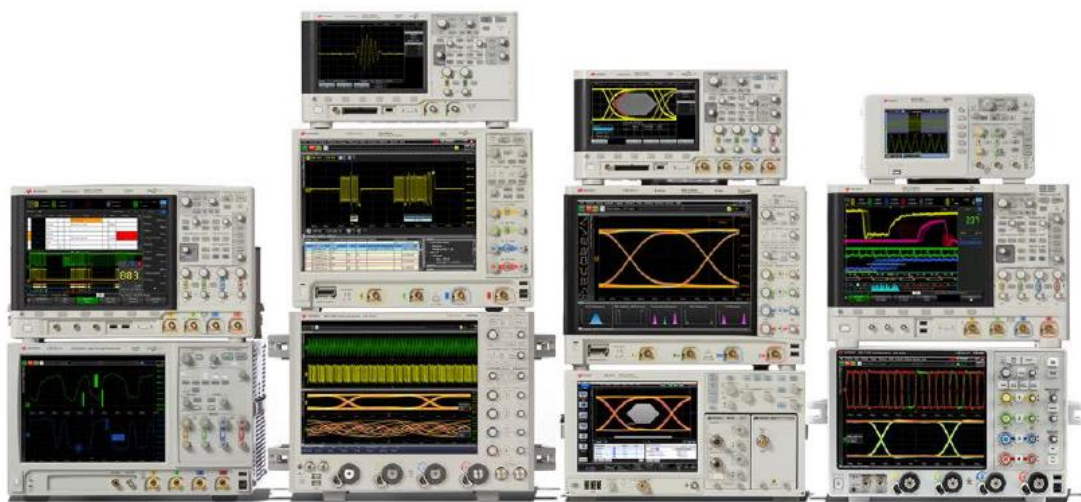

¹ Trigger at a maximum 160-bit sequence or sixteen 8b/10b symbols. Works only on channel 1

² Either MSO or hardware serial trigger option can be added to the oscilloscope.

www.axiestandard.org



AdvancedTCA® Extensions for Instrumentation and Test (AXIe) is an open standard that extends the AdvancedTCA for general purpose and semiconductor test. The business that became Keysight was a founding member of the AXIe consortium. ATCA®, AdvancedTCA®, and the ATCA logo are registered US trademarks of the PCI Industrial Computer Manufacturers Group.

www.lxistandard.org



LAN eXtensions for Instruments puts the power of Ethernet and the Web inside your test systems. The business that became Keysight was a founding member of the LXI consortium.

www.pxisa.org



PCI eXtensions for Instrumentation (PXI) modular instrumentation delivers a rugged, PC-based high-performance measurement and automation system.

Download your next insight

Keysight software is downloadable expertise. From first simulation through first customer shipment, we deliver the tools your team needs to accelerate from data to information to actionable insight.

- Electronic design automation (EDA) software
- Application software
- Programming environments
- Productivity software



Learn more at

www.keysight.com/find/software

Start with a 30-day free trial.

www.keysight.com/find/free_trials

Learn more at: www.keysight.com

For more information on Keysight Technologies' products, applications or services, please contact your local Keysight office. The complete list is available at: www.keysight.com/find/contactus