

# Keysight Technologies

## FieldFox Handheld Analyzers

4/6.5/9/14/18/26.5/32/44/50 GHz



### Data Sheet

- N9913A
- N9914A
- N9915A N9925A N9935A
- N9916A N9926A N9936A
- N9917A N9927A N9937A
- N9918A N9928A N9938A
  
- N9950A N9960A
- N9951A N9961A
- N9952A N9962A

## Table of Contents

Definitions . . . . .	3
Cable and Antenna Analyzer and Vector Network Analyzer . . . . .	4
Corrected Measurement Uncertainty for N9913/4/5/6/7A and N9925/6/7A . . . . .	13
Corrected Measurement Uncertainty for N9913/4/5/6/7/8A and N9925/6/7/8A . . . . .	14
Corrected Measurement Uncertainty for N9913/4/5/6/7/8A and N9925/6/7/8A, 85518A or 85519A . . . . .	15
Corrected Measurement Uncertainty for N9913/4/5/6/7/8A and N9925/6/7/8A, 85054D . . . . .	16
Corrected Measurement Uncertainty for N9918A, N9928A . . . . .	17
Corrected Measurement Uncertainty for N9913/4/5/6/7/8A and N9925/6/7/8A, 85520A or 85521A . . . . .	18
Corrected Measurement Uncertainty for N9913/4/5/6/7/8A and N9925/6/7/8A, 85052D . . . . .	19
Corrected Measurement Uncertainty for N9950A/51A/52A, 85056D . . . . .	20
Corrected Measurement Uncertainty for N9950/1/2A, N4693A ECal . . . . .	21
TDR Cable Measurements (Option 215) . . . . .	22
VNA Time Domain (Option 010) . . . . .	22
Mixed-Mode S-Parameters (Option 212) . . . . .	23
Vector Voltmeter (VVM) (Option 308) . . . . .	23
Spectrum Analyzer (Option 233 on Combination Analyzers) . . . . .	24
Tracking Generator or Independent Source . . . . .	32
Real-Time Spectrum Analyzer (RTSA) (Option 350) . . . . .	34
Spectrum Analyzer IF Output . . . . .	35
Preamplifier (Option 235) . . . . .	35
Interference Analyzer and Spectrogram (Option 236) . . . . .	35
Channel Scanner (Option 312) . . . . .	35
AM/FM Analog demodulation, Tune and Listen . . . . .	36
Spectrum Analyzer Time Gating (Option 238) . . . . .	37
Reflection Measurements (RL, VSWR) (Option 320, applicable to SA only models) . . . . .	37
Extended Range Transmission Analysis (ERTA) (Option 209) . . . . .	38
Built-in Power Meter (Option 310) . . . . .	43
External USB Power Sensor Support (Option 302) . . . . .	44
Pulse Measurements (Option 330) . . . . .	44
USB Power Sensor Measurements Versus Frequency (Option 208) . . . . .	44
Built-In GPS Receiver (Option 307) . . . . .	46
DC Bias Variable-Voltage Source (Option 309) . . . . .	46
Remote Control Capability (Option 030) . . . . .	46
General Information . . . . .	47

This data sheet provides the specified and typical performance of the FieldFox family of portable analyzers. This data sheet should be used in conjunction with the technical overviews and configuration guide, for a complete description of the analyzers.

The specifications and measurement capabilities listed in this document require certain options on the FieldFox analyzer. Refer to the [FieldFox Configuration Guide](http://literature.cdn.keysight.com/litweb/pdf/5990-9836EN.pdf) to obtain option information. The configuration guide (<http://literature.cdn.keysight.com/litweb/pdf/5990-9836EN.pdf>) is the main resource for option/measurement capability information.

## Definitions

### Specification (spec)

Specifications include guardbands to account for the expected statistical performance distribution, measurement uncertainties, and changes in performance due to environmental conditions. Specifications are warranted performance. FieldFox must be within its calibration cycle. No warm-up required for the specifications listed on pages 20 through 39.

### Typical

Describes additional product performance information not covered by the product warranty. It is performance beyond specifications that 80% of the units exhibit with a 95% confidence level over the temperature range  $23 \pm 5$  °C, unless otherwise noted. Typical performance does not include measurement uncertainty. FieldFox must be within its calibration cycle.

### Nominal

A general, descriptive term or design parameter. It is not tested, and not covered by the product warranty. FieldFox must be within its calibration cycle.

## Cable and Antenna Analyzer and Vector Network Analyzer

The performance listed in this section applies to the cable and antenna analyzer (referred to as CAT) and vector network analyzer (VNA) capabilities available in the following models:

- FieldFox RF & microwave (combination) analyzers: N9913A, N9914A, N9915A, N9916A, N9917A, N9918A  
N9950A, N9951A, N9952A
- FieldFox microwave vector network analyzers: N9925A, N9926A, N9927A, N9928A

NOTE: Combination analyzers = Cable and antenna tester (CAT) + Vector network analyzer (VNA) + Spectrum analyzer (SA)

### Frequency specifications

	Models	Frequency range
N991xA, N992xA	N9913A	30 kHz to 4 GHz
	N9914A	30 kHz to 6.5 GHz
	N9915A, N9925A	30 kHz to 9 GHz
	N9916A, N9926A	30 kHz to 14 GHz
	N9917A, N9927A	30 kHz to 18 GHz
	N9918A, N9928A	30 kHz to 26.5 GHz
N995xA	N9950A	300 kHz to 32 GHz
	N9951A	300 kHz to 44 GHz
	N9952A	300 kHz to 50 GHz
<b>Frequency reference, -10 to 55 °C</b>		
Accuracy	± 0.7 ppm (spec) + aging	
	± 0.4 ppm (typical) + aging	
Accuracy, when locked to GPS	± 0.010 ppm (spec)	
Accuracy, when GPS antenna is disconnected	± 0.2 ppm (nominal) <sup>1</sup>	
Aging Rate	± 1 ppm/yr for 20 years (spec), will not exceed ± 3.5 ppm	
<b>Frequency resolution (start, stop, center, marker)</b>		
	<b>Spec</b>	
Frequency ≤ 5 GHz	1 Hz	
Frequency ≤ 10 GHz	1.34 Hz	
Frequency ≤ 20 GHz	2.68 Hz	
Frequency ≤ 40 GHz	5.36 Hz	
Frequency ≤ 50 GHz	8.04 Hz	
<b>Data points or resolution</b>		
101, 201, 401, 601, 801, 1001, 1601, 4001, 10,001		
Arbitrary number of points settable through front panel and SCPI		
<b>IF bandwidth <sup>2</sup></b>		
10 Hz, 30 Hz, 100 Hz, 300 Hz, 1 kHz, 3 kHz, 10 kHz, 30 kHz, 100 kHz		
<b>System impedance</b>		
50 Ω (nominal), 75 Ω with appropriate adapter and calibration kit		

1. The maximum drift expected in the frequency reference applicable when the ambient temperature changes ±5 °C from the temperature when the GPS signal was last connected.
2. VNA mode only. Recommend using averaging in CAT mode

## Cable and Antenna Analyzer and Vector Network Analyzer (continued)

### Test port output specifications

**High power** in N991xA and N992xA refers to the target output power level of the analyzer when the *Power Setting* is set to *High*. As an example, if you have a frequency sweep from 3 to 6.5 GHz, the analyzer will achieve the power level of -1 dBm across the band.

**Low power** level for N991xA and N992xA analyzers is a flat -45 dBm across the whole frequency band, and is the output of the analyzer when the *Power Setting* is set to *Low*.

**High power** in the N995xA refers to the target output power level of the analyzer when the *Power Setting* is set to *High*. As an example, if you have a frequency sweep from 39 to 46 GHz, the analyzer will achieve the power level of -2 dBm across the band.

**Low power** level for N995xA analyzers is the lowest power level that can be set and is the output of the analyzer when the *Power Setting* is set to *Low*.

**Max leveled power** in the N995xA refers to the maximum leveled (flattened) power that can be achieved across the designated frequency range. For example, if you have a frequency sweep from 32 to 44 GHz, and set up the analyzer to measure all four S-parameters, needing both ports 1 and 2, the maximum power the analyzer can be set to is -6 dBm.

Test port output power (dBm), high power	Typical	Nominal
N991xA, N992xA	Port 1 or Port 2	Port 1 or Port 2
30 to 300 kHz	-11	-
> 300 kHz to 2 MHz	-3	-2
> 2 to 625 MHz	-2	-1
> 625 MHz to 3 GHz	1	3
> 3 to 6.5 GHz	-1	1
> 6.5 to 9 GHz	-2	0
> 9 to 14 GHz	-4	-2.5
> 14 to 18 GHz	-6	-4.5
> 18 to 23 GHz	-10	-8.5
> 23 to 26.5 GHz	-12	-11
Test port output power (dBm), low power	Typical	Nominal
N991xA, N992xA	Port 1 or Port 2	Port 1 or Port 2
30 kHz to 26.5 GHz	-	-45 (flattened)

## Cable and Antenna Analyzer and Vector Network Analyzer (continued)

### Test port output specifications (continued)

<b>Test port output power (dBm), high power</b>		<b>Typical</b>		<b>Nominal</b>
<b>N995xA</b>		<b>Port 1</b>	<b>Port 2</b>	
300 kHz to 2 MHz		0	0	–
> 2 MHz to 1 GHz		2	2	–
> 1 to 6.5 GHz		2	0	–
> 6.5 to 18 GHz		4	1	–
> 18 to 39 GHz		1	-2	–
> 39 to 46 GHz		-2	-5	–
> 46 to 50 GHz		-4	-7	–
<b>Test port output power (dBm), low power</b>		<b>Typical</b>		<b>Nominal</b>
<b>N995xA</b>		<b>Port 1</b>	<b>Port 2</b>	
500 kHz to 10 MHz		-35	-38	–
> 10 MHz to 10 GHz		-38	-42	–
> 10 to 20 GHz		-43	-47	–
> 20 to 44 GHz		-44	-50	–
> 44 to 50 GHz		-53	-55	–
<b>Max leveled output power (dBm)</b>		<b>Typical</b>		<b>Nominal</b>
<b>N995xA</b>		<b>Port 1</b>	<b>Port 2</b>	
500 kHz to 10 MHz		-2	-2	–
> 10 MHz to 25 GHz		0	0	–
> 25 to 32 GHz		0	-4	–
> 32 to 44 GHz		-3	-6	–
> 44 to 50 GHz		-7	-10	–
<b>Output power range</b>				
CAT		High, low, and manual. Default (preset) power is high Manual power is flattened.		
VNA		High, low, and manual. Default (preset) power is manual, -15 dBm. Manual power is flattened.		
<b>Power step size</b>				
Power settable in 1 dB steps across power range. Flat power, in 1 dB steps, is available across the whole frequency span, nominal.				
<b>Power level accuracy<sup>1</sup></b>		<b>Typical</b>		
N991xA, N992xA		± 1.5 dB at -15 dBm, for frequencies > 250 kHz		
N995xA		± 0.7 dB at -15 dBm, for frequencies > 500 kHz to 10 MHz ± 0.5 dB at -15 dBm, for frequencies > 10 MHz to 50 GHz		
<b>Power level linearity</b>		<b>Nominal</b>		
<b>N995xA</b>		<b>Port 1 or port 2, -25 dBm ≤ P &lt; max leveled power</b>		
10 MHz to 50 GHz		± 0.5 dB		

1. N991xA and N992xA power levels are calibrated in the factory using a broadband power sensor, which means all tones (fundamental and harmonics) are included. N995xA power levels are calibrated based on PNA-X's tuned receiver, which means primarily the fundamental is included (for frequencies ≥ 10 MHz).

## Cable and Antenna Analyzer and Vector Network Analyzer (continued)

### System performance specifications

<b>System dynamic range<sup>1,2</sup> (dB), high power, 300 Hz IFBW, 100 point average, Port 1 or port 2 (-10 to 55 °C)</b>			
	<b>Frequency</b>	<b>Spec</b>	<b>Typical</b>
N991xA, N992xA	> 300 kHz to 9 GHz <sup>3</sup>	95	100
	> 9 to 14 GHz	91	97
	> 14 to 18 GHz	90	94
	> 18 to 20 GHz	87	90
	> 20 to 25 GHz	74	79
	> 25 to 26.5 GHz	65	70
N995xA	> 300 kHz to 1 MHz	–	70 (nominal)
	> 1 to 10 MHz	–	100 (nominal)
	> 10 MHz to 20 GHz <sup>4</sup>	100	110
	> 20 to 44 GHz <sup>5</sup>	90	100
	> 44 to 50 GHz <sup>6</sup>	81	90
<b>Measurement stability over temperature</b>		<b>Nominal</b>	
	<b>Frequency</b>	<b>Magnitude (dB/°C)</b>	<b>Phase (deg/°C)</b>
N991xA, N992xA	≤ 15 GHz	± 0.018	–
	> 15 to 26.5 GHz	± 0.080	–
N995xA	≤ 15 GHz	± 0.005	± 0.1
	≤ 25 GHz	± 0.030	± 0.3
	> 25 GHz	± 0.060	± 0.6
<b>Measurement speed (Sweep time)</b>			
<b>CAT</b>		<b>N991xA, N992xA</b>	<b>N995xA</b>
	Return loss, 30 kHz to 26.5 GHz, 1-port cal, 1001 points <sup>7</sup>	433 μs /pt	–
	Return loss, 300 kHz to 50 GHz, 1-port cal, 1001 points	–	650 μs /pt
	Distance-to-fault, 100 meter cable, 1-port cal, 1001 points <sup>7</sup>	480 μs /pt	650 μs /pt
<b>VNA</b>		<b>N991xA, N992xA</b>	<b>N995xA</b>
	S11 and S21, 30 kHz to 26.5 GHz, enhanced response cal, 100 kHz IF bandwidth, 1001 points <sup>8</sup>	483 μs /pt	–
	S11 and S21, 300 kHz to 50 GHz, enhanced response cal, 100 kHz IF bandwidth, 1001 points	–	580 μs /pt

- System dynamic range is measured in the factory with loads on the test ports after a thru normalization.
- For CAT mode, "Insertion loss (2-port)", decrease listed dynamic range specifications by 20 dB, as CAT mode IFBW is fixed at 10 kHz. Can obtain full dynamic range by using S21 measurement in VNA mode with 100 Hz IFBW.
- < 300 kHz: 63 dB nominal; 2 to 9 MHz: 85 dB spec, 90 dB typical.
- Decrease by 3 dB from 15 to 15.8 GHz for S21.
- Decrease by 5 dB from 21.7 to 22.1 GHz for S21.
- Decrease by 4 dB from 44 to 50 GHz for S21.
- 850 μs /pt; slower speed applicable to FieldFox models with serial number prefix ≤ MY5607/SG5607/US5607 and FieldFox models not upgraded with the fast CPU Option N9910HU-100/200/300.
- 850 μs /pt; slower speed applicable to FieldFox models with serial number prefix ≤ MY5607/SG5607/US5607 and FieldFox models not upgraded with the fast CPU Option N9910HU-100/200/300.

## Cable and Antenna Analyzer and Vector Network Analyzer (continued)

### Test port input specifications

Trace noise <sup>1</sup> , high power, 300 Hz IFBW, Port 1 or port 2		Spec (-10 to 55 °C)	
	Frequency	Magnitude (dB rms)	Phase (deg rms)
N991xA, N992xA, N995xA	> 300 kHz to 20 GHz <sup>2</sup>	± 0.004	± 0.07
	> 20 to 26.5 GHz	± 0.007	± 0.14
	> 26.5 to 30 GHz	± 0.007	± 0.14
	> 30 to 50 GHz	± 0.008	± 0.22
Receiver compression		Typical	
	Frequency	Port 1 or port 2	
N991xA, N992xA	500 MHz to 1 GHz	+10 dBm, 0.15 dB compression	
	> 1 to 26.5 GHz	+10 dBm, 0.10 dB compression	
N995xA	2 MHz to 50 GHz	+5 dBm, 0.10 dB compression	
Maximum input level		Port 1 or port 2	
		Average CW power	DC
N991xA, N992xA		+27 dBm, 0.5 watts	± 50 VDC
		+25 dBm, 0.3 watts	± 40 VDC
N995xA		+25 dBm, 0.3 watts	± 40 VDC
Immunity to interfering signals		Nominal	
		+16 dBm	

- For CAT mode, increase trace noise by a factor of 5.7, as CAT mode IFBW is fixed at 10 kHz. Can use averaging in CAT mode to reduce trace noise or use VNA mode with 300 Hz IFBW.
- Excludes multiples of 390 kHz.

### CAT and VNA measurements

<b>CAT measurements</b>	Distance-to-fault (dB) Return loss (dB) VSWR Distance-to-fault (VSWR) Cable loss (1-port) Insertion loss (2-port) (requires option 211) Distance-to-fault (Lin) TDR (Lin rho) (requires option 215) TDR (ohm) (requires option 215) TDR & DTF (requires option 215)
<b>VNA Transmission/Reflection (T/R)</b>	S11, S21 magnitude and phase (requires option 211)
<b>VNA S-parameters</b>	S11, S21, S22, S12 magnitude and phase (requires options 211 and 212)
<b>Number of traces</b>	Four traces available, Tr1, Tr2, Tr3, Tr4
<b>Display formats</b>	Single-trace Dual-trace overlay (both traces on one graticule) Dual-trace split (each trace on separate graticule) Three-trace split (each trace on separate graticule) Three-trace overlay (all three traces on one graticule) Quad-trace split (each trace on separate graticule) Quad-trace overlay (all four traces on one graticule)
<b>VNA trace formats</b>	Log magnitude, linear magnitude, VSWR, phase, Smith chart, polar, group delay, unwrapped phase, real impedance, imaginary impedance, Z magnitude



## Cable and Antenna Analyzer and Vector Network Analyzer (continued)

### CAT and VNA measurements (continued)

<b>Frequency settings</b>	Start, stop, center, span
<b>Frequency sweep type</b>	Linear
<b>Sweep trigger</b>	Continuous, single
<b>CAT mode distance-to-fault settings</b>	Start distance, stop distance
<b>Sweep time</b>	Units: meters or feet (Can also be set as Preferences)
<b>CAT mode averaging</b>	Set sweep time in seconds
<b>NA mode averaging</b>	Sweep averaging. 2 to 1000
<b>Smoothing</b>	Computes the moving average of adjacent data points. Smoothing aperture defines the trace width (number of points) to be averaged. Minimum aperture: 0.05% of frequency span Maximum aperture: 25% of frequency span
<b>Scale</b>	Autoscale, scale, reference level, reference position Autoscale: Automatically selects scale resolution and reference value to center the trace. Autoscale all: Scales all visible traces.
<b>Return loss, log magnitude</b>	-1000 to 1000 dB
<b>Log magnitude resolution</b>	0.01 dB
<b>Phase</b>	-180 to +180 degrees (unwrapped phase can show larger values)
<b>Phase resolution</b>	0.01 degrees
<b>Phase offset</b>	-360 to +360 degrees
<b>VSWR</b>	1.01 to 1000
<b>VSWR resolution</b>	0.01
<b>Magnitude offset</b>	-100 to +100 dB
<b>Title</b>	Add custom titles to the display
<b>Display data</b>	Display data, memory, data and memory, or data math
<b>Trace math</b>	One memory trace per data trace. Total of 4 memory traces
<b>Port extension</b>	Vector division or subtraction of current linear measurement values and memory data
<b>Data markers</b>	For both port 1 and port 2, delay settings. Port extensions apply to all measurements.
<b>Marker formats</b>	Default marker format is the trace format. Other formats: R + jX Z magnitude Phase Real Imaginary Mag & Phase
<b>Marker functions</b>	Peak, Next Peak, Peak Left, Peak Right, Mkr→ Center, Mkr→Delay, Min Search, Peak Excursion, Peak Threshold, Target, Bandwidth (BW, Q, Loss), Tracking CAT mode only: Tracking 3 peaks (CAT mode), Marker→ Start distance, Marker→ Stop distance
<b>Marker table</b>	On/Off
<b>Marker types</b>	Normal, delta, data trace and memory trace markers
<b>Marker coupling</b>	On/Off (coupling between traces)
<b>Frequency blanking</b>	Security level: none, high. If high, all frequency information is blanked out. An instrument preset is required to re-enable the frequency information.

## Cable and Antenna Analyzer and Vector Network Analyzer (continued)

### Test port input specifications (continued)

---

<b>Distance-to-fault</b>	<p>Available in CAT mode. Standard on N991xA and N995x analyzers. Option 305 on N992xA analyzers</p> <p>Range = velocity factor x speed of light x (number of points -1) / frequency span x 2</p> <p>Number of points auto coupled according to start and stop distance entered.</p> <p>Resolution = range / (number of points -1)</p> <p>Transform modes: Bandpass, low-pass</p> <p>Window types: Maximum, medium, and minimum</p> <p>Alias free range indicator: On/Off</p> <p>Dispersion compensation for waveguide: Yes</p>
--------------------------	---------------------------------------------------------------------------------------------------------------------------------------------------------------------------------------------------------------------------------------------------------------------------------------------------------------------------------------------------------------------------------------------------------------------------------------------------------------------------------------------------------------------------------

---

### CAT and VNA mode Calibrations

FieldFox analyzers offer three tiers of calibrations, thus providing users with different levels of calibration effort and accuracy.

#### CalReady

CalReady is the most basic calibration. Every FieldFox is calibrated at the factory, at test ports 1 and 2, at room temperature. This calibration is stored in the instrument and is sufficient for quick verification of device performance, assuming the device under test (DUT) is connected directly to the test ports. CalReady can be applied either as an “enhanced response CalReady” or a “2-port CalReady.” The default setting is 2-port CalReady, so correction is applied to both ports. A user preference allows user to change the CalReady methodology to enhanced response CalReady.

A 30-minute warm-up period is recommended.

If CalReady is the basis for most measurements, it is highly recommended that the annual cal cycle be followed, as the CalReady calibration will be updated during the annual cal cycle.

#### QuickCal

QuickCal is the next level of calibration. QuickCal uses internal standards and a subset of external standards, and builds on the factory-created CalReady. Users can perform QuickCal with a load or without a load. A QuickCal calibration with a load yields a more accurate measurement.

Important note: QuickCal is most accurate for DUTs with 7/16 and Type-N connectors and measurement uncertainties are provided for frequencies  $\leq$  18 GHz. Accuracy is reduced for DUTs with 3.5 mm (m), SMA (m), or other male coaxial connectors; performance is unspecified. QuickCal is not recommended for DUTs with 3.5 mm (f), SMA (f), or other similar female connectors. QuickCal is not applicable to waveguide.

A 30-minute warm-up period is recommended.

If QuickCal is the basis for most measurements, it is highly recommended that the annual cal cycle be followed, as QuickCal builds on CalReady and CalReady data are updated during the annual cal cycle.

## Cable and Antenna Analyzer and Vector Network Analyzer (continued)

### Standard calibrations

Standard calibrations are the most accurate calibrations offered in FieldFox. FieldFox's calibration engine is based on Keysight's flagship PNA calibration engine, and as such, offers many of the standard calibrations. FieldFox supports both coaxial and waveguide calibrations. The table below lists the commonly used calibrations.

A 60-minute warm-up period is recommended for standard calibrations. For ultimate in stability and accuracy, a 90-minute warm-up period is recommended.

<b>Frequency response</b> <b>Open Response</b> <b>Short Response</b> <b>Thru Response</b> <b>With and without isolation</b>	Simultaneous magnitude and phase correction of frequency response errors for either reflection or transmission measurements. Isolation corrects for crosstalk errors.
<b>1-port OSL (Port 1)</b> <b>1-port OSL (Port 2)</b> <b>SSL (for waveguide)</b>	Open, short, and load Traditional 1-port calibration for reflection measurements. Corrects for directivity, source match, and frequency response errors. For waveguide calibrations, depending on the calibration kit definition, this is presented as a short, offset short and load calibration.
<b>Enhanced response (also known as one-path, two-port)</b> <b>Forward Enhanced Response</b> <b>Reverse Enhanced Response</b>	Corrects for frequency response and source match. Partial correction for load match for low-loss reciprocal devices.
<b>QSOLT (2-port)</b>	QSOLT or Quick short-open-load-thru is FieldFox's default recommended calibration for insertable devices. Full 12-term error correction. Requires fewer connections, compared to traditional SOLT (4 compared to 7). Corrects for directivity, source match, reflection frequency response, load match, and transmission frequency response.
<b>Full 2-port (unknown thru calibration)</b>	FieldFox's default recommended calibration for non-insertable devices. Full 12-term error correction. Beneficial for characterizing non-insertable devices such as Type-N to 3.5 mm, or female-female devices. Corrects for directivity, source match, reflection frequency response, load match, and transmission frequency response.
<b>TRL</b>	TRL or thru-reflect-line compensates for directivity, reflection, and transmission frequency response in both the forward and reverse directions.

\*\* Note: FieldFox does not offer the traditional SOLT calibration. Instead, it offers the more accurate Full 2-port (unknown thru), and also QSOLT.

### ECal

FieldFox supports all Keysight USB ECal modules, both standard and value-line ECals.

### FieldFox's Guided Calibration Wizard

FieldFox's calibration wizard recommends a calibration type and calibration kit based on selected parameters and connector types. Alternatively, users can select their own calibration type and calibration kit. FieldFox's calibration wizard ensures a valid calibration selection.

### Interpolation Error Correction

With any type of accuracy enhancement applied, interpolated mode recalculates the error coefficients when the test frequencies are changed. The number of points can be increased or decreased and the start/stop frequencies can be changed, but the resulting frequency span must be a subset of the original calibration frequency span.

## Cable and Antenna Analyzer and Vector Network Analyzer (continued)

### Connectors

The following connector types are included by default with the FieldFox firmware. Additional connector types can be added by adding a new calibration kit that is based on the new connector type.

Coaxial	Waveguide
Type-N 50 ohm	WR-10
Type-N 75 ohm	WR-15
7/16	WR-22
TNC	WR-28
Type-F	WR-42
7 mm	WR-62
3.5 mm	WR-75
2.4 mm	WR-90
2.92 mm	WR-112
	WR-137
	WR-187
	WR-284
	WR-650

### FieldFox S-parameter measurement uncertainty charts

This data sheet includes measurement uncertainty charts for the configurations listed in the table below. Additional uncertainty charts are available in the secondary data sheet **5992-1926EN**.

FieldFox model	Calibration Kit	Calibration Type	DUT Connector	Uncertainty
N9913/4/5/6/7A & N9925/6/7A	-	CalReady	Type-N (m)	Nominal
N9913/4/5/6/7/8A & N9925/6/7/8A	-	QuickCal	Type-N(m)	Nominal
N9913/4/5/6/7/8A & N9925/6/7/8A	85518A or 85519A	Full 2-port calibration	Type-N	Spec
N9913/4/5/6/7/8A & N9925/6/7/8A	85054D	Full 2-port calibration	Type-N	Spec
N9918A & N9928A	-	CalReady	3.5 mm (f)	Nominal
NN9913/4/5/6/7/8A & N9925/6/7/8A	85520A or 85521A	Full 2-port calibration	3.5 mm	Spec
N9913/4/5/6/7/8A & N9925/6/7/8A	85052D	Full 2-port calibration	3.5 mm	Spec
N9925/6/7/8A	85056D	Full 2-port calibration	2.4 mm	Spec
N9950/1/2A	N4693A ECal	Full 2-port calibration	2.4 mm	Spec

## Corrected Measurement Uncertainty

### N9913/4/5/6/7A and N9925/6/7A, CalReady, DUT: Type-N(m), Nominal<sup>1</sup>

Power level of -15 dBm, 10 Hz IF bandwidth, no averaging, battery saver off, and 30-minute warm-up time. Includes uncertainties due to drift, noise, compression, and dynamic accuracy. Coverage factor of x1 applied to uncertainties, for ease of comparison with other industry handheld analyzers.

#### Transmission uncertainty (S21, S12)

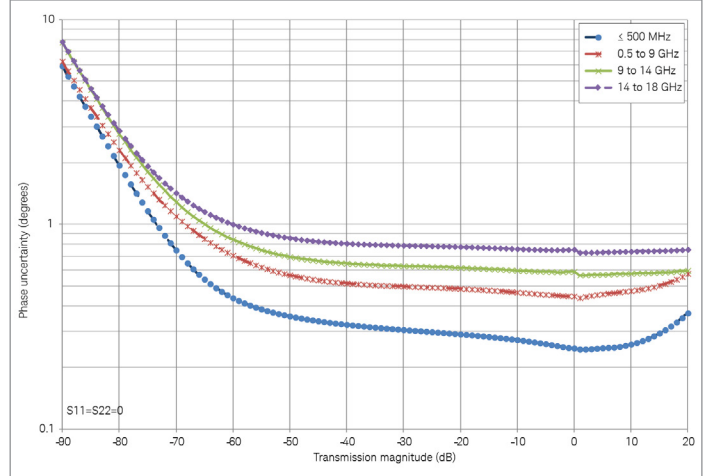
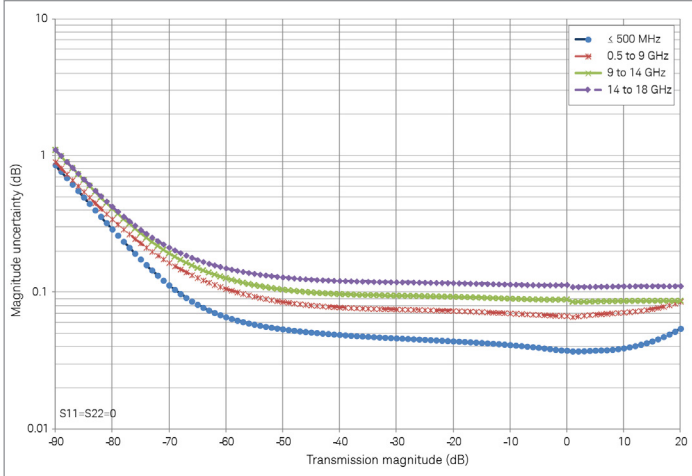

#### Reflection uncertainty (S11, S22)

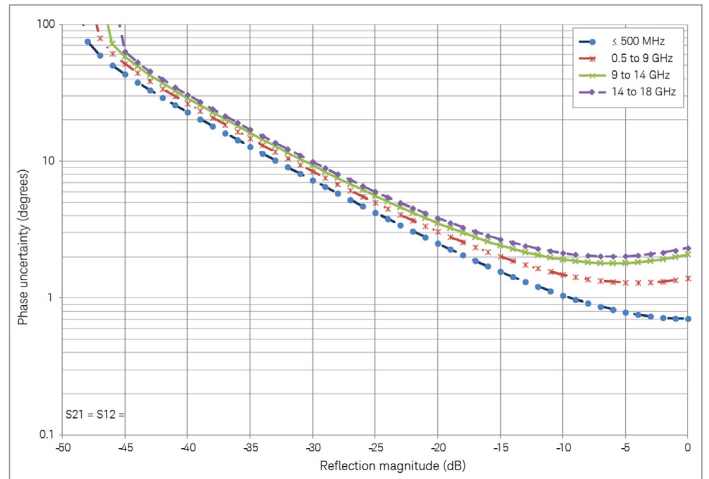
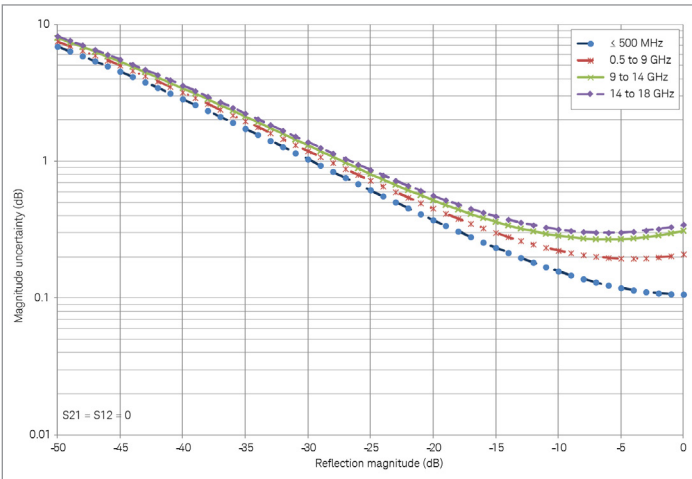

1. Uncertainties shown based on a factory calibration using data-based calibration kits.

## Corrected Measurement Uncertainty (continued)

N9913/4/5/6/7/8A and N9925/6/7/8A, QuickCal, DUT: Type-N(m), Nominal<sup>1</sup>

Power level of -15 dBm, 10 Hz IF bandwidth, no averaging, battery saver off, and 30-minute warm-up time. Includes uncertainties due to drift, noise, compression, and dynamic accuracy. Coverage factor of x1 applied to uncertainties, for ease of comparison with other industry handheld analyzers.

### Transmission uncertainty (S21, S12)

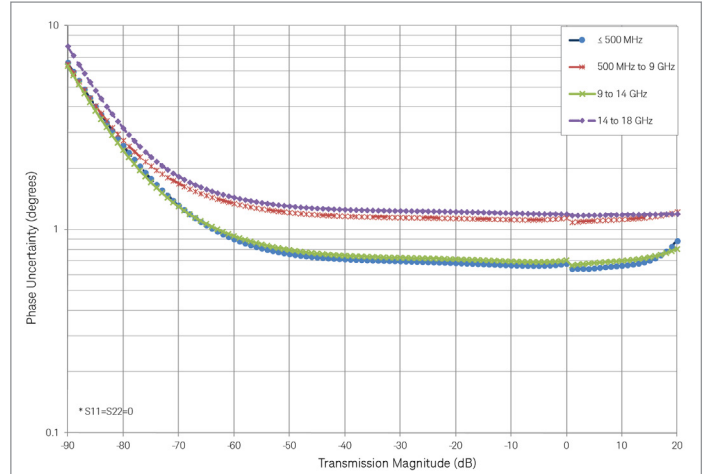
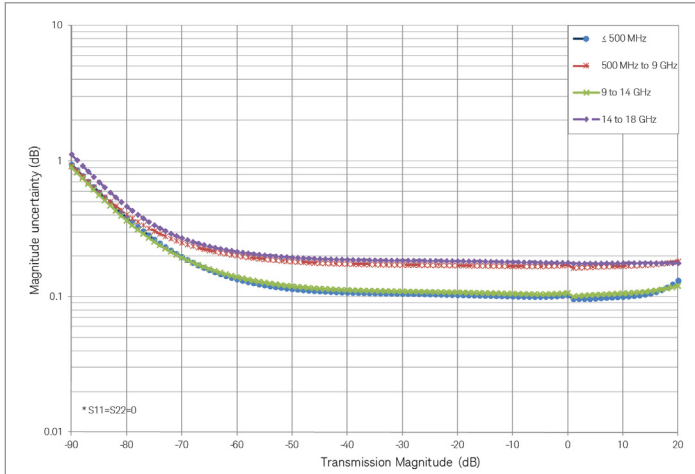

### Reflection uncertainty (S11, S22)

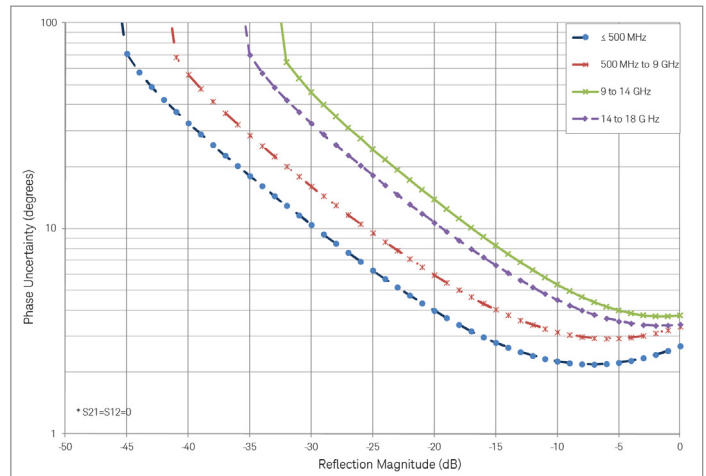
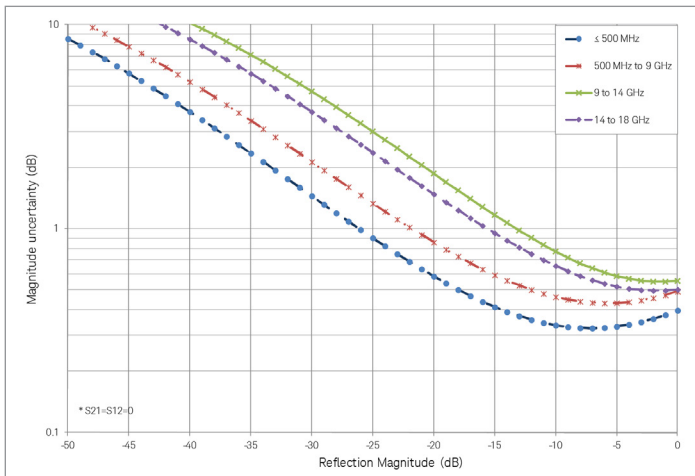

1. Uncertainties shown based on a factory calibration using data-based calibration kits.

## Corrected Measurement Uncertainty (continued)

N9913/4/5/6/7/8A and N9925/6/7/8A, 85518A or 85519A, Full 2-port Cal, DUT: Type-N, Spec

Power level of -15 dBm, 10 Hz IF bandwidth, no averaging, battery saver off, and 60-minute warm-up time. Includes uncertainties due to drift, noise, compression, and dynamic accuracy. Coverage factor of x1 applied to uncertainties, for ease of comparison with other industry handheld analyzers.

Corrected performance (dB)	≤ 0.5 GHz	0.5 to 2 GHz	2 to 9 GHz	9 to 18 GHz
Directivity	44	42	35	32
Source match	37	36	33	30
Load match	38	37	31	27
Reflection tracking	± 0.050	± 0.060	± 0.070	± 0.100
Transmission tracking	± 0.070	± 0.100	± 0.180	± 0.500

Transmission uncertainty (S21, S12)

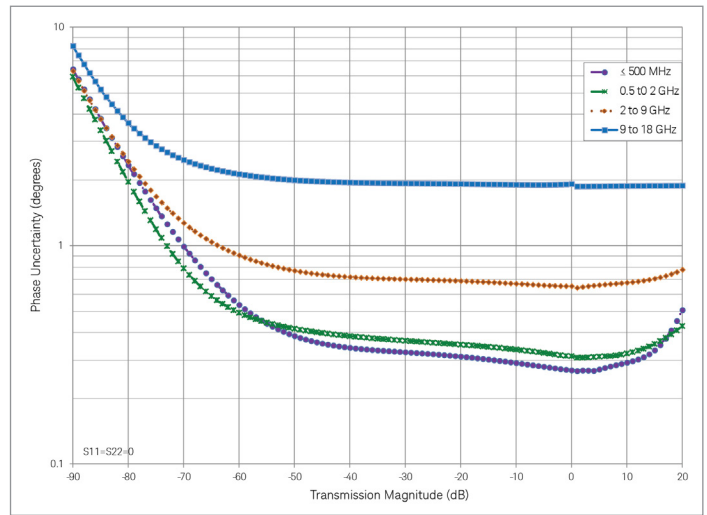
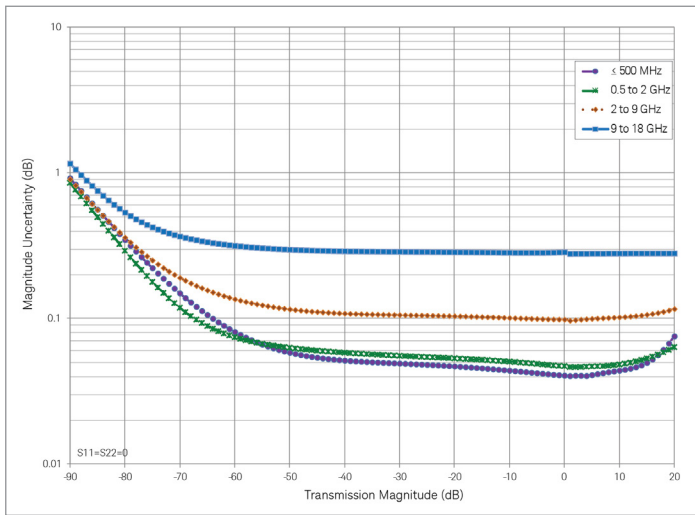

Reflection uncertainty (S11, S22)

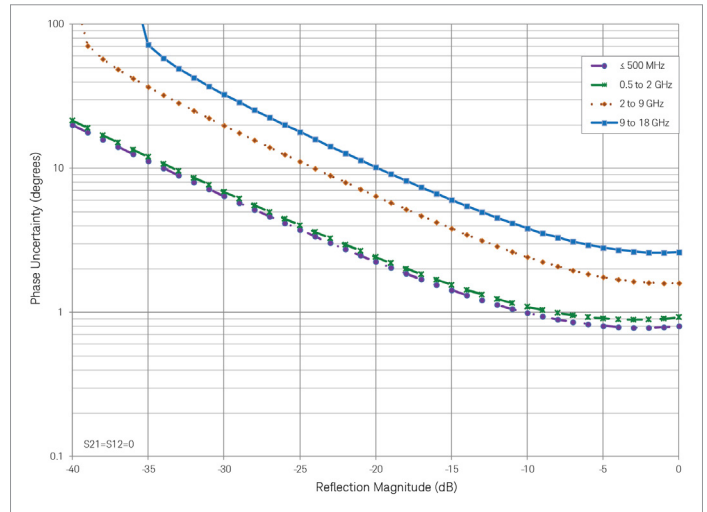
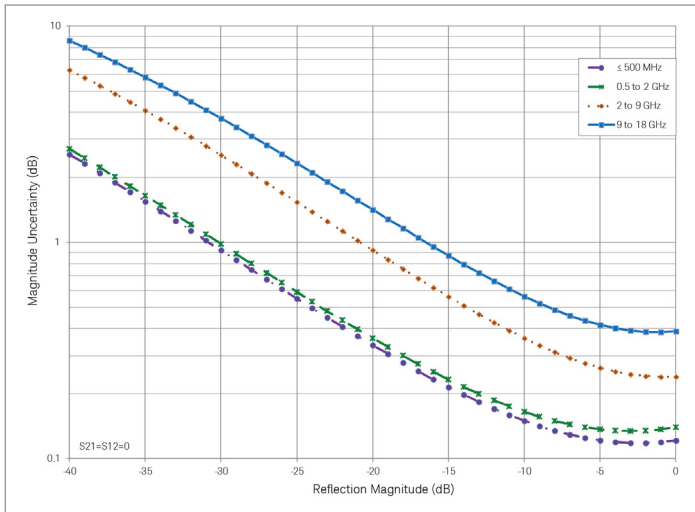

## Corrected Measurement Uncertainty (continued)

N9913/4/5/6/7/8A and N9925/6/7/8A, 85054D, Full 2-port Cal, DUT: Type-N, Spec

Power level of -15 dBm, 10 Hz IF bandwidth, no averaging, battery saver off, and 60-minute warm-up time. Includes uncertainties due to drift, noise, compression, and dynamic accuracy. Coverage factor of x1 applied to uncertainties, for ease of comparison with other industry handheld analyzers.

Corrected performance (dB)	≤ 0.5 GHz	0.5 to 2 GHz	2 to 8 GHz	8 to 18 GHz
Directivity	40	40	36	34
Source match	38	33	33	27
Load match	37	35	32	27
Reflection tracking	± 0.006	± 0.006	± 0.009	± 0.027
Transmission tracking	± 0.070	± 0.100	± 0.150	± 0.430

### Transmission uncertainty (S21, S12)

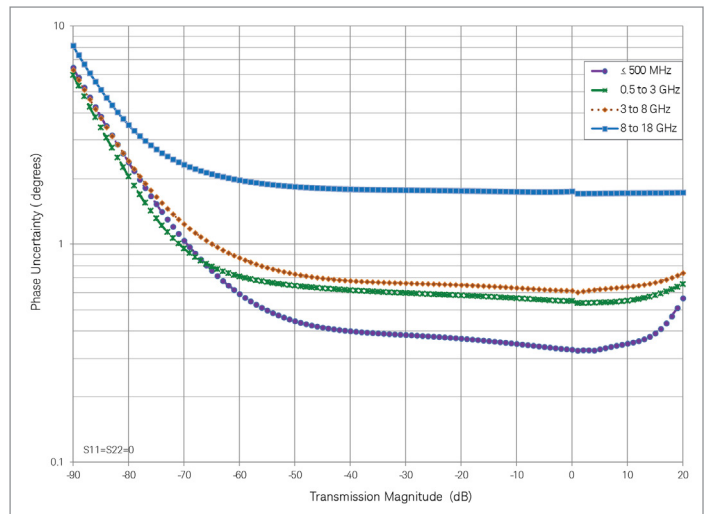
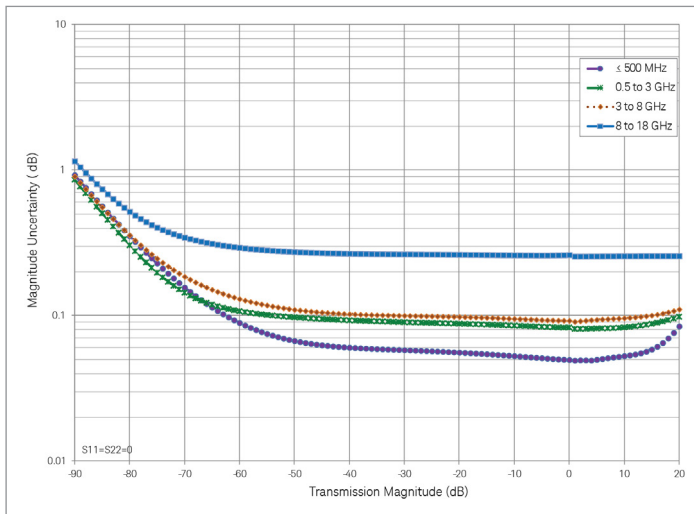

### Reflection uncertainty (S11, S22)

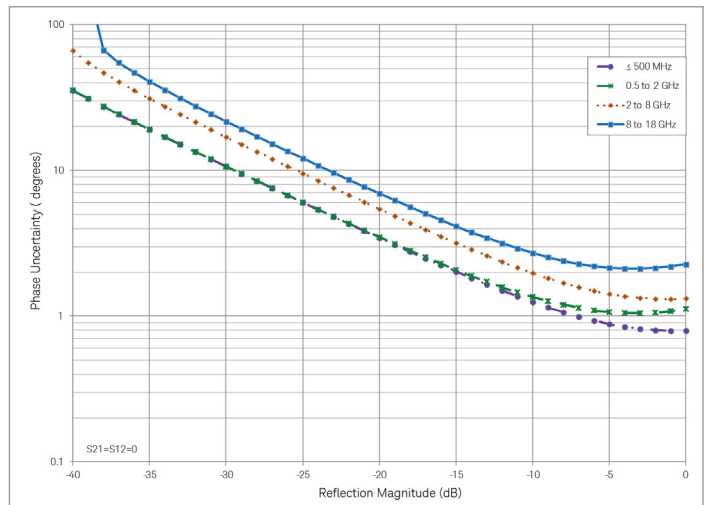
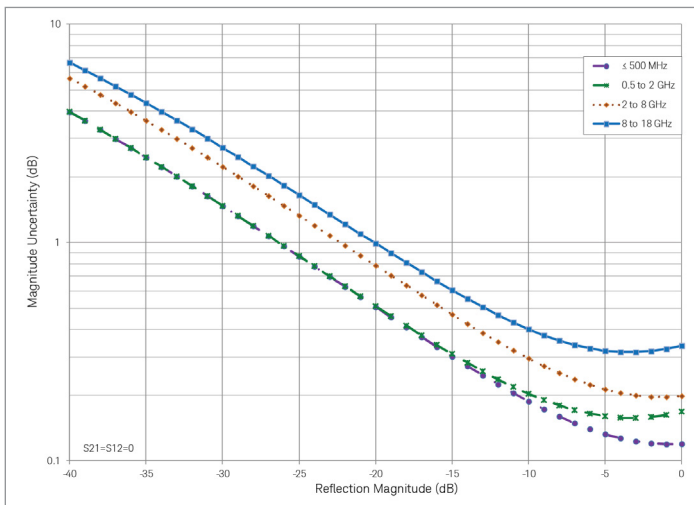



## Corrected Measurement Uncertainty (continued)

N9918A, N9928A, CalReady, DUT: 3.5 mm (f), Nominal<sup>1</sup>

Power level of -15 dBm, 10 Hz IF bandwidth, no averaging, battery saver off, and 30-minute warm-up time. Includes uncertainties due to drift, noise, compression, and dynamic accuracy. Coverage factor of x1 applied to uncertainties, for ease of comparison with other industry handheld analyzers.

### Transmission uncertainty (S21, S12)

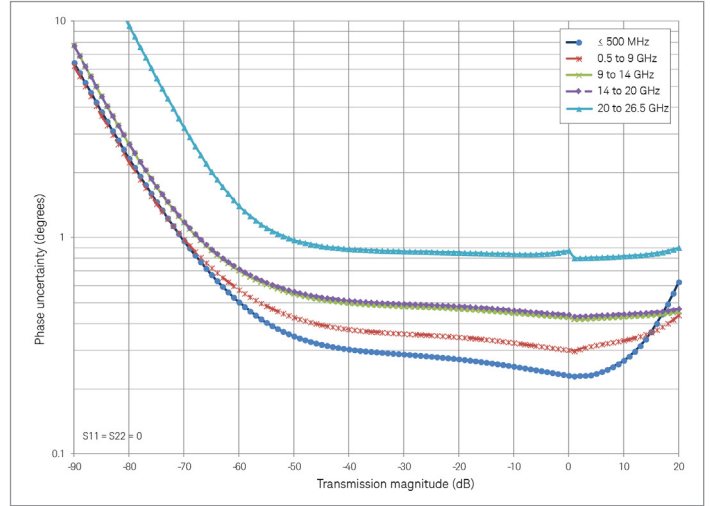
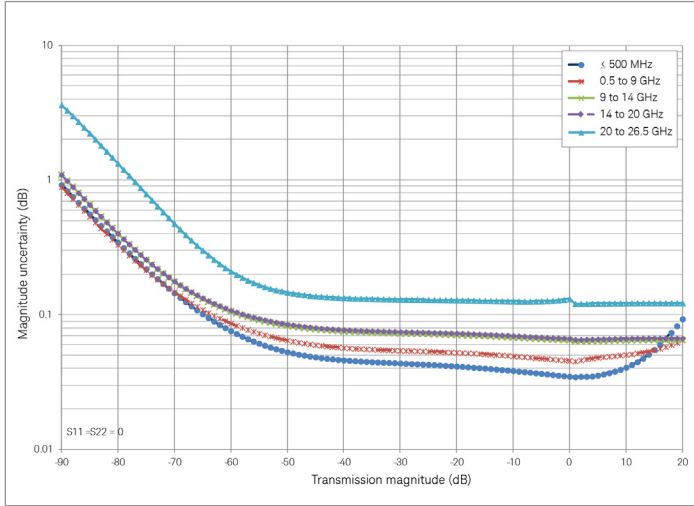

### Reflection uncertainty (S11, S22)

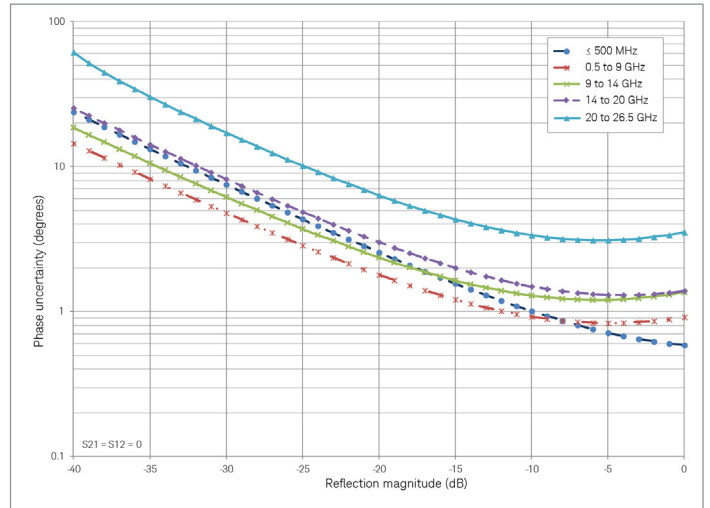
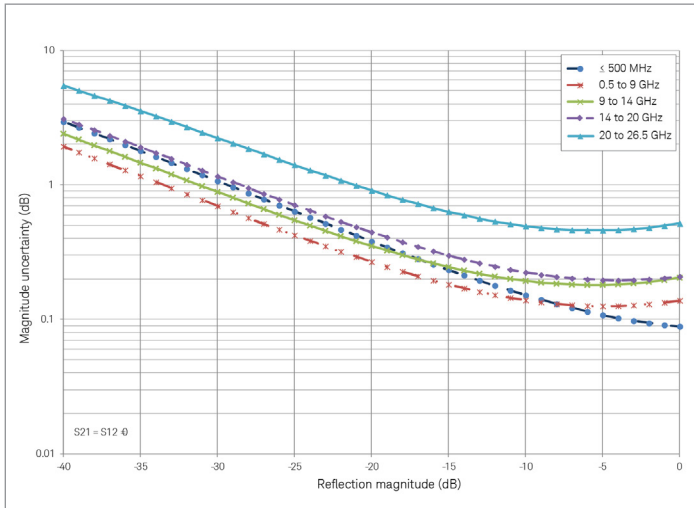

1. Uncertainties shown based on a factory calibration using data-based calibration kits.

## Corrected Measurement Uncertainty (continued)

N9913/4/5/6/7/8A and N9925/6/7/8A, 85520A or 85521A, Full 2-port Cal, DUT: 3.5 mm, Spec

Power level of -15 dBm, 10 Hz IF bandwidth, no averaging, battery saver off, and 60-minute warm-up time. Includes uncertainties due to drift, noise, compression, and dynamic accuracy. Coverage factor of x1 applied to uncertainties, for ease of comparison with other industry handheld analyzers.

Corrected performance (dB)	≤ 0.5 GHz	0.5 to 9 GHz	9 to 18 GHz	18 to 26.5 GHz
Directivity	42	36	32	32
Source match	37	30	28	27
Load match	37	30	28	24
Reflection tracking	± 0.035	± 0.130	± 0.140	± 0.210
Transmission tracking	± 0.070	± 0.290	± 0.330	± 0.520

### Transmission uncertainty (S21, S12)

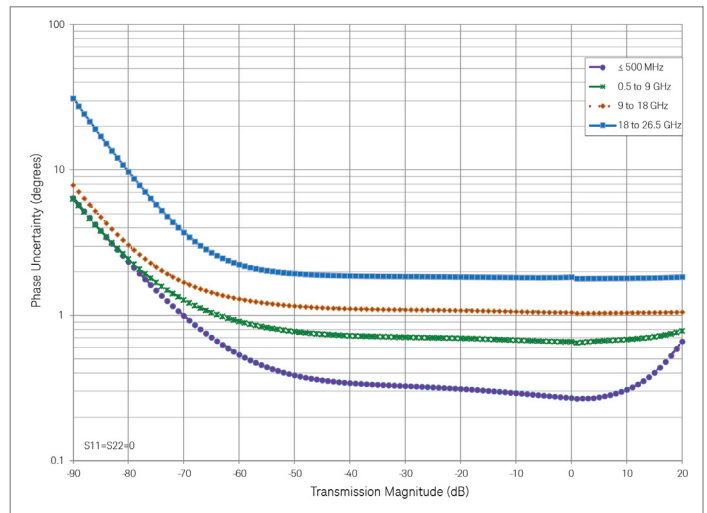
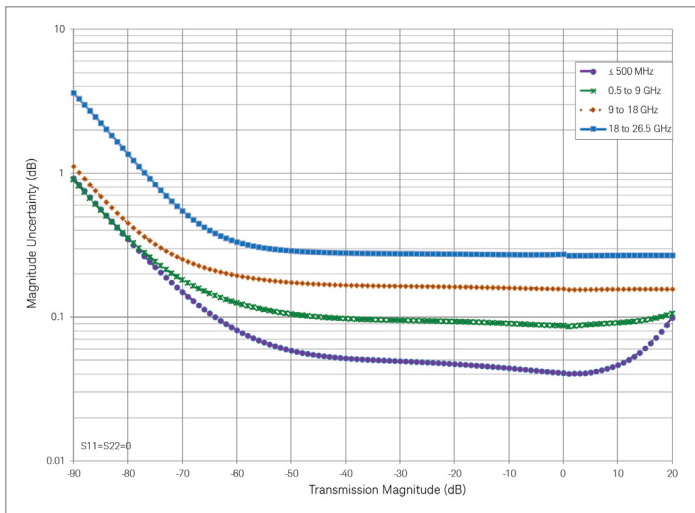

### Reflection uncertainty (S11, S22)

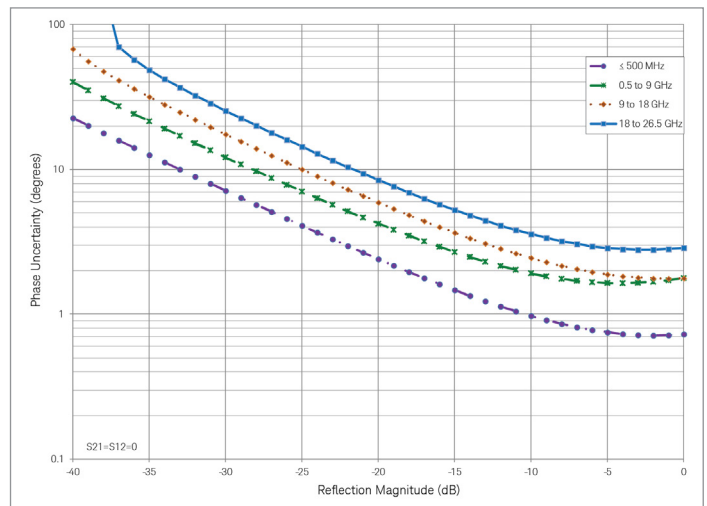
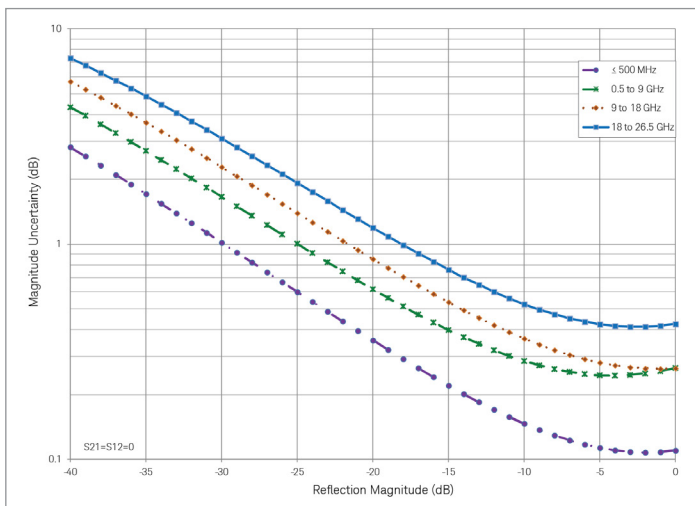

## Corrected Measurement Uncertainty (continued)

N9913/4/5/6/7/8A and N9925/6/7/8A, 85052D, Full 2-port Cal, DUT: 3.5 mm, Spec

Power level of -15 dBm, 10 Hz IF bandwidth, no averaging, battery saver off, and 60-minute warm-up time. Includes uncertainties due to drift, noise, compression, and dynamic accuracy. Coverage factor of x1 applied to uncertainties, for ease of comparison with other industry handheld analyzers.

Corrected performance (dB)	≤ 0.5 GHz	0.5 to 8 GHz	8 to 20 GHz	20 to 26.5 GHz
Directivity	42	38	36	30
Source match	37	31	28	25
Load match	38	33	29	24
Reflection tracking	± 0.005	± 0.006	± 0.009	± 0.012
Transmission tracking	± 0.070	± 0.135	± 0.320	± 0.500

### Transmission uncertainty (S21, S12)

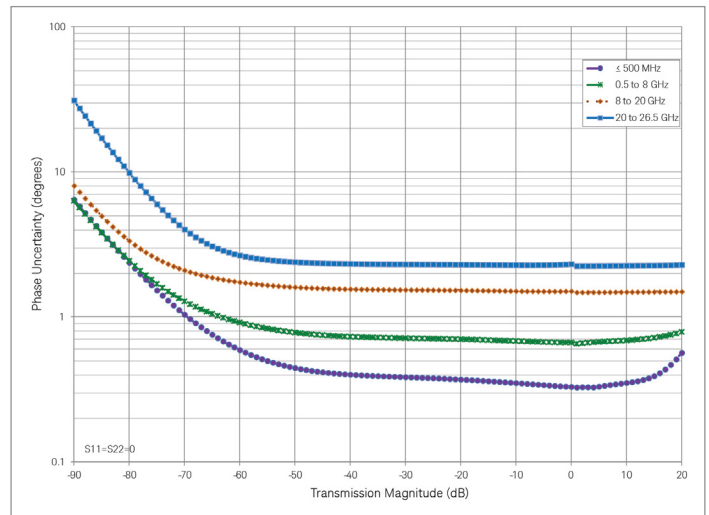
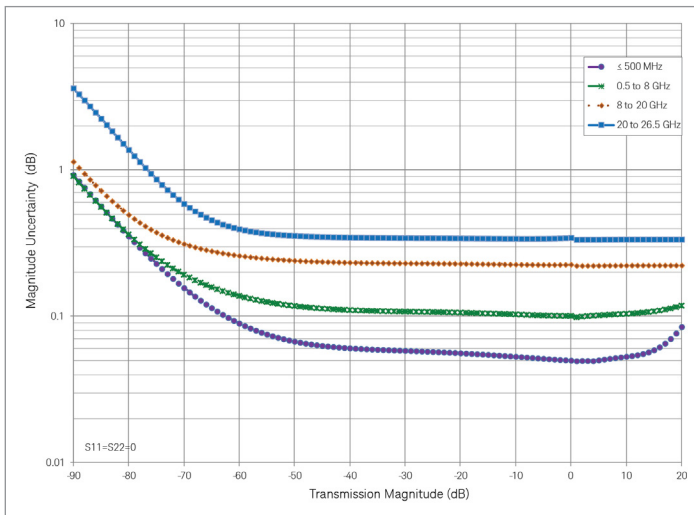

### Reflection uncertainty (S11, S22)

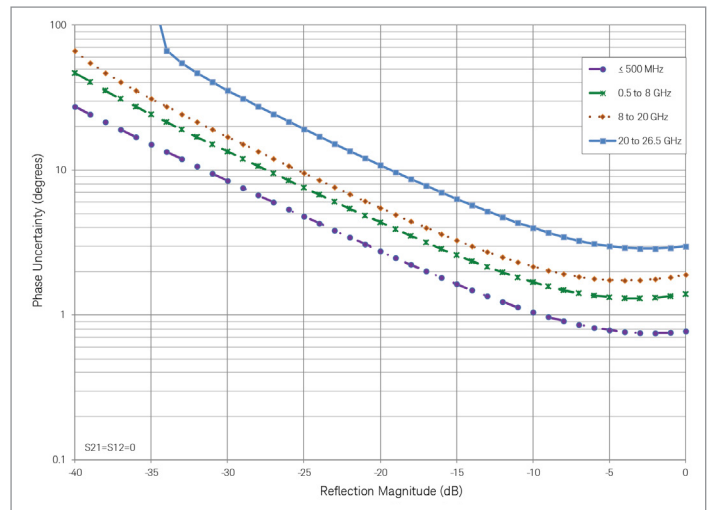
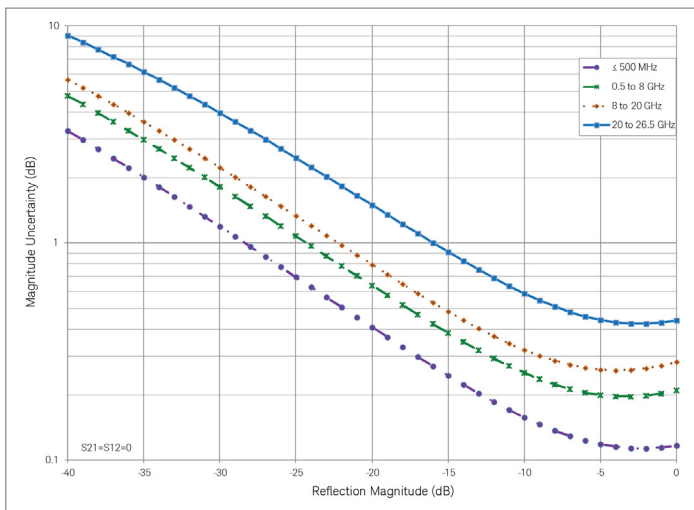

## Corrected Measurement Uncertainty

### N9950/1/2A, 85056D, Full 2-port Cal, DUT: 2.4 mm, Spec<sup>1</sup>

Power level of -15 dBm, 10 Hz IF bandwidth, no averaging, battery saver off, and 60-minute warm-up time. Includes uncertainties due to drift, noise, compression, and dynamic accuracy. Coverage factor of x1 applied to uncertainties, for ease of comparison with other industry handheld analyzers.

Corrected performance (dB)	≤ 2 GHz	2 to 20 GHz	20 to 40 GHz	40 to 50 GHz
Directivity	42	34	26	26
Source match	39	30	23	23
Load match	42	34	26	26
Reflection tracking	± 0.002	± 0.029	± 0.080	± 0.075
Transmission tracking	± 0.003	± 0.034	± 0.109	± 0.105

### Transmission uncertainty (S21, S12)

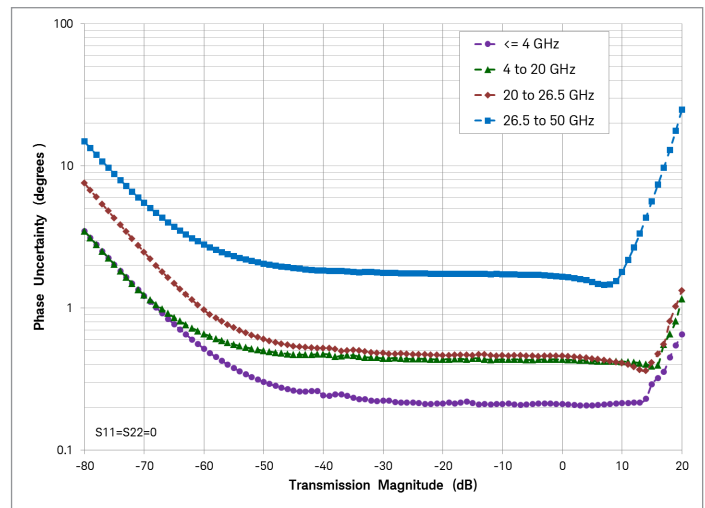
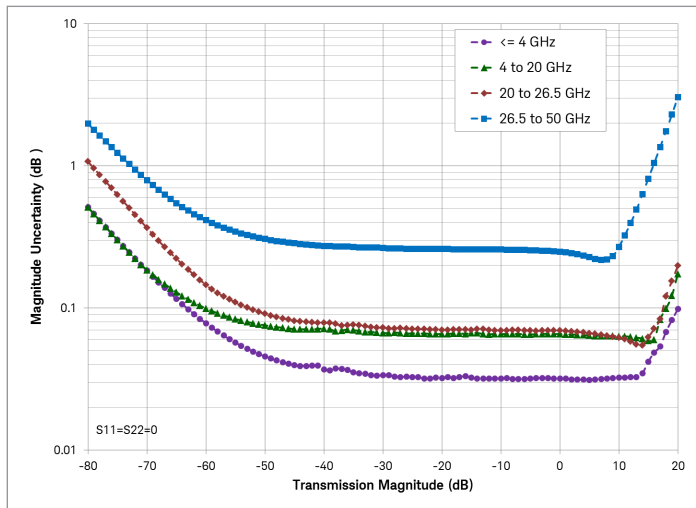

### Reflection uncertainty (S11, S22)

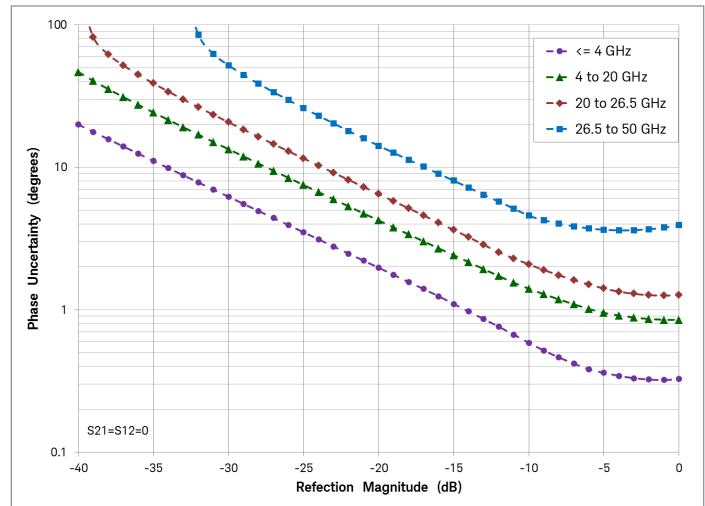
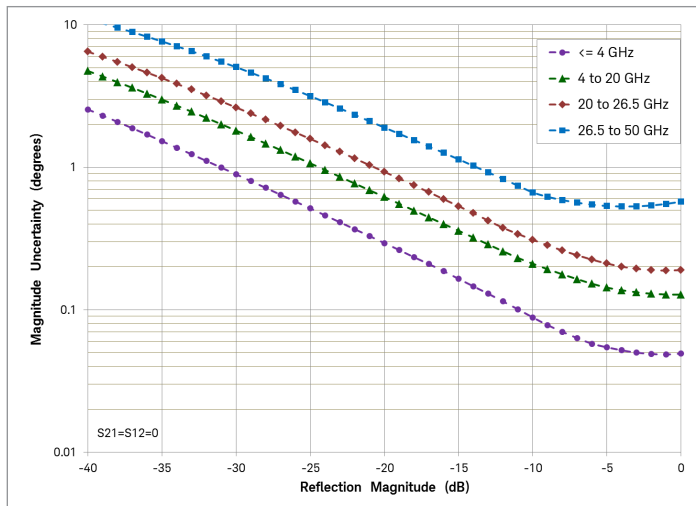

1. Uncertainty curves shown are calculated based on ISO GUM methodology. The values in the table are provided for reference only, in accordance to legacy uncertainty methods.

## Corrected Measurement Uncertainty (continued)

N9950/1/2A, N4693A ECal, Full 2-port Cal, DUT: 2.4 mm, Spec<sup>1</sup>

Power level of -15 dBm, 10 Hz IF bandwidth, no averaging, battery saver off, and 60-minute warm-up time. Includes uncertainties due to drift, noise, compression, and dynamic accuracy. Coverage factor of x1 applied to uncertainties, for ease of comparison with other industry handheld analyzers.

Corrected performance (dB)	10 to 50 MHz	50 MHz to 2 GHz	2 to 10 GHz	10 to 20 GHz	20 to 40 GHz	40 to 50 GHz
Directivity	32	42	49	45	41	36
Source match	25	44	42	37	35	32
Load match	25	43	41	36	34	31
Reflection tracking	± 0.050	± 0.030	± 0.040	± 0.050	± 0.060	± 0.080
Transmission tracking	± 0.118	± 0.038	± 0.047	± 0.065	± 0.091	± 0.134

### Transmission uncertainty (S21, S12)

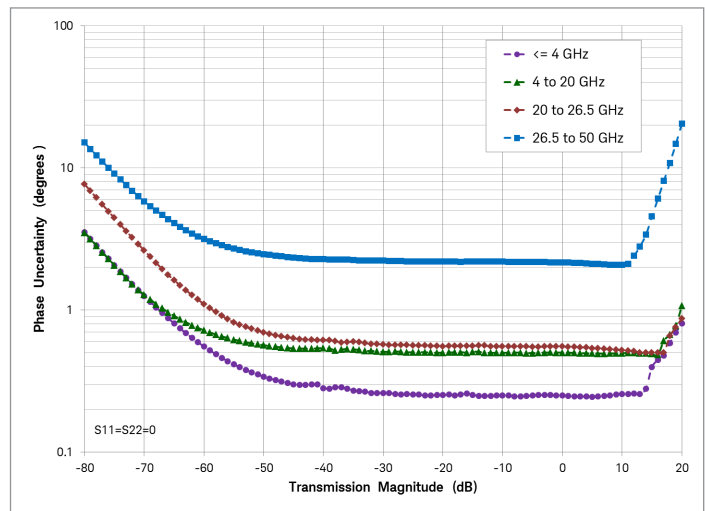
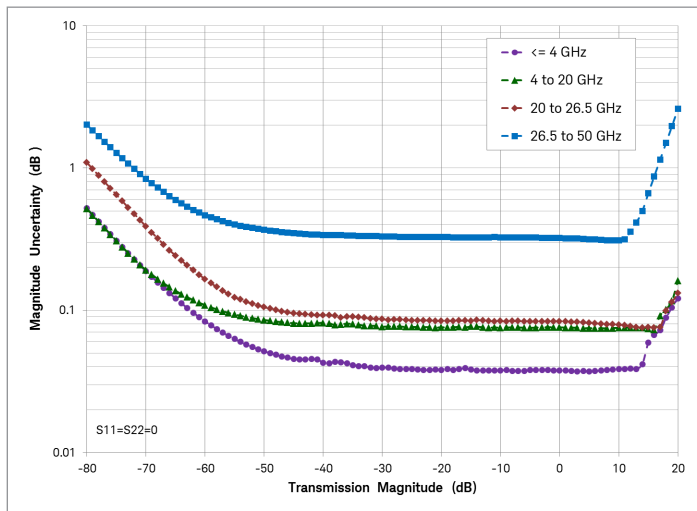

### Reflection uncertainty (S11, S22)

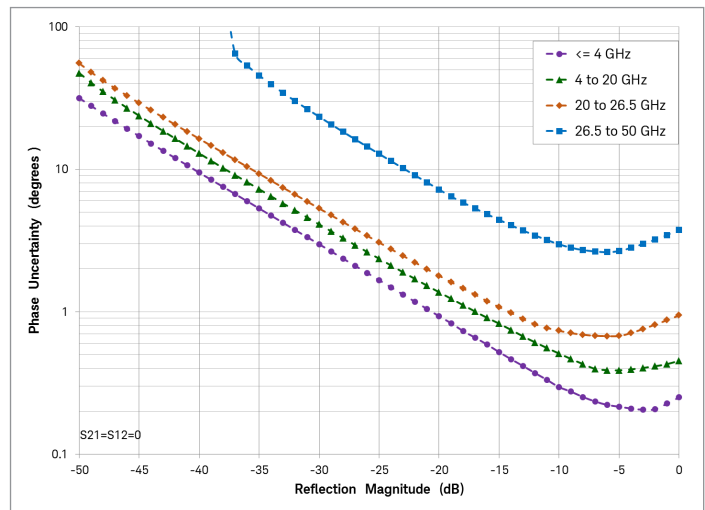
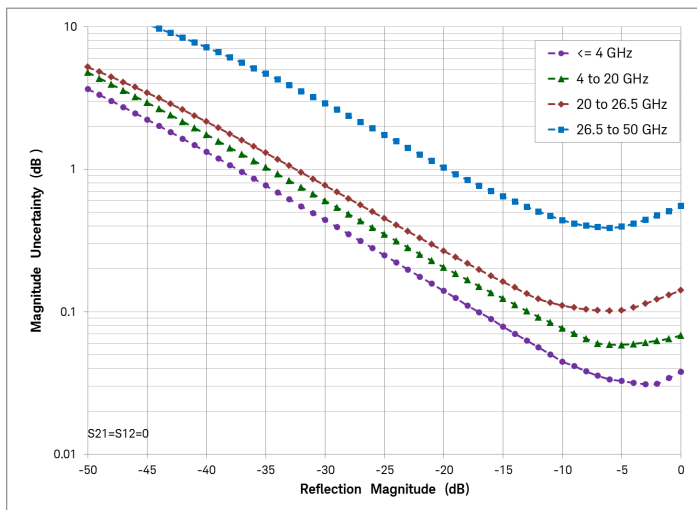

1. Uncertainty curves shown are calculated based on ISO GUM methodology. The values in the table are provided for reference only, in accordance to legacy uncertainty methods.

The performance listed in TDR cable measurements, VNA time domain, mixed-mode S-parameters and vector voltmeter sections applies to the capabilities available in the following models:

- FieldFox RF & microwave analyzers: N9913A, N9914A, N9915A, N9916A, N9917A, N9918A  
N9950A, N9951A, N9952A
- FieldFox microwave vector network analyzers: N9925A, N9926A, N9927A, N9928A

See [FieldFox Configuration Guide](#) for option information. Many capabilities listed in this Data Sheet require options.

## TDR Cable Measurements (Option 215)

The TDR cable option adds time domain reflectometry (TDR) measurements to FieldFox's CAT mode. FieldFox's TDR measurements are based on an inverse Fourier transform of the frequency-domain data. TDR measurements are useful in not only identifying the location of faults along cables, but also the nature of the fault. Resistive, inductive and capacitive faults will each have a different response. These differences help engineers and technicians trouble-shoot line faults.

Measurements: TDR (linear rho), TDR (ohm), TDR & DTF

Y-axis: linear (rho) or impedance (ohm)

X-axis: distance (meters or feet)

## VNA Time Domain (Option 010)

In time-domain mode, FieldFox computes the inverse Fourier transform of the frequency-domain data to display reflection or transmission coefficients versus time.

### Setup parameters

Time	Start, stop, center, span
------	---------------------------

Gating	Start, stop, center, span, and on/off
--------	---------------------------------------

Numbers of points, velocity vector, line loss, window shape, independent control for all four traces

### Time stimulus modes

Low-pass step	Low-pass step is similar to a traditional time domain reflectometer (TDR) stimulus waveform. It is used to measure low-pass devices. The frequency-domain data should extend from DC (extrapolated value) to a higher value.
---------------	------------------------------------------------------------------------------------------------------------------------------------------------------------------------------------------------------------------------------

Low-pass impulse	Low-pass impulse response is used to measure low-pass devices.
------------------	----------------------------------------------------------------

Bandpass impulse	The bandpass impulse simulates a pulsed RF signal and is used to measure the time domain response of band-limited devices.
------------------	----------------------------------------------------------------------------------------------------------------------------

### Windows

The windowing function can be used to filter the frequency domain data and thereby reduce overshoot and ringing in the time domain response.

Windows	Minimum, medium and maximum, manual entry of Kaiser Beta and impulse width.
---------	-----------------------------------------------------------------------------

### Gating

The gating function can be used to selectively remove reflection or transmission time domain responses. In converting back to the frequency domain the effects of the responses outside the gate are removed. The results can be viewed with gating on and off, using two traces.

Gate types	Notch, bandpass
------------	-----------------

Gate shapes	Maximum, wide, normal, minimum
-------------	--------------------------------

## Mixed-Mode S-Parameters (Option 212)

Mixed-mode S-parameters are also known as balanced measurements.

Measurements	
Scc11	Common mode reflection
Sdd11	Differential mode reflection
Scd11	Differential mode stimulus, common mode response
Sdc11	Common mode stimulus, differential mode response

FieldFox's mixed-mode S-parameter measurements require the use of the default factory calibration or a user 2-port calibration. So the FieldFox analyzer must be equipped with 2-port measurement functionality to measure mixed-mode S-parameters. Mixed-mode S-parameters are an extension of the VNA capabilities.

## Vector Voltmeter (VVM) (Option 308)

With vector voltmeter mode, you can characterize the difference between two measurements easily. The zeroing function allows you to create a reference signal, and characterize the difference between two device measurements. The results are shown on a large display in digital format.

	Models	Frequency range
N991xA, N992xA	N9913A	30 kHz to 4 GHz
	N9914A	30 kHz to 6.5 GHz
	N9915A, N9925A	30 kHz to 9 GHz
	N9916A, N9926A	30 kHz to 14 GHz
	N9917A, N9927A	30 kHz to 18 GHz
	N9918A, N9928A	30 kHz to 26.5 GHz
N995xA	N9950A	300 kHz to 32 GHz
	N9951A	300 kHz to 44 GHz
	N9952A	300 kHz to 50 GHz

Setup parameters	
1-port cable trimming	Reflection (S11 or S22 measurement), magnitude and phase
2-port transmission	Transmission or S21 measurement, magnitude and phase
A/B and B/A	Ratio of two receivers or channels, magnitude and phase – Need an external signal generator for the A/B or B/A measurement
	Frequency (one CW frequency point)
	F bandwidth: 10 Hz to 100 kHz
	Output power: Low, high, manual

### Ratio accuracy (A/B and B/A)

Must zero before measuring DUT. Recommend using a high-quality power splitter or 6 dB attenuators to minimize uncertainty due to mismatch.

	Frequency	Nominal (dB)
N991xA, N992xA, N995xA	100 to 300 kHz <sup>1</sup>	± 1.0
	> 300 kHz to 1 MHz	± 0.4
	> 1 to 100 MHz	± 0.2
	> 100 to 300 MHz	± 0.4
	> 300 MHz to 1.5 GHz	± 0.6
	> 1.5 to 2 GHz	± 1.0

1. Does not apply to N995xA models, which start at 300 kHz.

## Spectrum Analyzer (Option 233 on Combination Analyzers)

The performance listed in this section applies to the spectrum analyzer capabilities available in the following models:

- FieldFox RF & microwave analyzers: N9913A, N9914A, N9915A, N9916A, N9917A, N9918A  
N9950A, N9951A, N9952A
- FieldFox microwave spectrum analyzers: N9935A, N9936A, N9937A, N9938A  
N9960A, N9961A, N9962A

See [FieldFox Configuration Guide](#) for option information. Many capabilities listed in this Data Sheet require options.

### Frequency and time specifications

	Models	Frequency range	
N991xA, N993xA	N9913A	100 kHz to 4 GHz	Usable to 5 kHz
	N9914A	100 kHz to 6.5 GHz	Usable to 5 kHz
	N9915A, N9935A	100 kHz to 9 GHz	Usable to 5 kHz
	N9916A, N9936A	100 kHz to 14 GHz	Usable to 5 kHz
	N9917A, N9937A	100 kHz to 18 GHz	Usable to 5 kHz
	N9918A, N9938A	100 kHz to 26.5 GHz	Usable to 5 kHz
N995xA, N996xA	N9950A, N9960A	9 kHz to 32 GHz	Usable to 5 kHz
	N9951A, N9961A	9 kHz to 44 GHz	Usable to 5 kHz
	N9952A, N9962A	9 kHz to 50 GHz	Usable to 5 kHz

The spectrum analyzer is tunable to 0 Hz or DC.

#### Frequency reference, -10 to 55 °C

Accuracy	$\pm 0.7$ ppm (spec) + aging
	$\pm 0.4$ ppm (typical) + aging
Accuracy, when locked to GPS	$\pm 0.01$ ppm (spec)
Accuracy, when GPS antenna is disconnected	$\pm 0.2$ ppm (nominal) <sup>1</sup>
Aging Rate	$\pm 1$ ppm/yr for 20 years (spec), will not exceed $\pm 3.5$ ppm

#### Frequency readout accuracy (start, stop, center, marker)

$\pm$ (readout frequency x frequency reference accuracy + RBW centering + 0.5 x horizontal resolution)	Horizontal resolution = frequency span / (trace points – 1) RBW centering: – 5% x RBW, FFT mode (nominal) – 16% x RBW, step mode (nominal)
--------------------------------------------------------------------------------------------------------	-----------------------------------------------------------------------------------------------------------------------------------------------------

#### Marker frequency counter

Accuracy	$\pm$ (marker frequency x frequency reference accuracy + counter resolution)
Resolution	1 Hz

#### Frequency Span

	Spec	
Range	0 Hz (zero span), 10 Hz to maximum frequency range of instrument	
Resolution	1 Hz	
Accuracy	$\pm$ (2 x RBW centering + horizontal resolution)	$\pm$ (2 x RBW centering + horizontal resolution) for detector = Normal

Sweep time readout	Measured value of the time required to complete a sweep from start to finish, including time to tune receiver, acquire data, and process trace.
--------------------	-------------------------------------------------------------------------------------------------------------------------------------------------



## Spectrum Analyzer (Option 233 on Combination Analyzers) (continued)

### Frequency and time specifications (continued)

Trace update, nominal	N991xA, N993xA	N995xA, N996xA
Span = 20 MHz, RBW, VBW = 3 kHz	6.7 updates per second <sup>2</sup>	8 updates per second
Span = 100 MHz, RBW, VBW autocoupled	15.4 updates per second <sup>3</sup>	19 updates per second
Center frequency tune and transfer <sup>4</sup>	N991xA, N993xA <sup>5</sup>	N995xA, N996xA
101 points, zero span	70 ms	69 ms
101 points, 1 MHz span	72 ms	72 ms

1. The maximum drift expected in the frequency reference applicable when the ambient temperature changes  $\pm 5$  °C from the temperature when the GPS signal was last connected.
2. 1.2 updates per second; applicable to FieldFoxes with serial number prefix  $\leq$  MY5607/SG5607/US5607 and FieldFoxes not upgraded with the fast CPU Option N9910HU-100/200/300.
3. 4.1 updates per second; applicable to FieldFoxes with serial number prefix  $\leq$  MY5607/SG5607/US5607 and FieldFoxes not upgraded with the fast CPU Option N9910HU-100/200/300.
4. Within full frequency range of instrument, not band dependent
5. Applicable to FieldFoxes with serial number prefix  $\geq$  MY5607/SG5607/US5607 and FieldFoxes not upgraded with the fast CPU Option N9910HU-100/200/300.

Sweep time, zero span	Nominal
Range	N991xA, N993xA: 1 $\mu$ s to 1000 s N995xA, N996xA: 1 $\mu$ s to 6000 s
Resolution	100 ns
Readout	Entered value representing trace horizontal scale range
Trigger (for zero span and FFT sweeps)	
Trigger type	Free run, external, video, RF burst
Trigger slope	Positive edge, negative edge
Trigger delay	Range: -150 ms to 10 s Resolution: 100 ns
Auto trigger	Forces a periodic acquisition in the absence of a trigger event Range: 0 (off) to 10 s
Trigger position (zero span)	Controls horizontal position of the pulse edge; use sweep time to zoom into pulse edge Range: 0 to 10, integer steps; 0 is left edge of graticule, 10 is right edge of graticule
RF burst trigger	Nominal
Dynamic range	40 dB
Bandwidth	20 MHz
Operating frequency range	20 MHz to maximum instrument frequency
Sweep (trace) point range	
All spans	101, 201, 401, 601, 801, 1001 (defaults to 401); arbitrary 2 to 10,001 settable through SCPI
Resolution bandwidth (RBW)	Nominal
Range (-3 dB bandwidth)	
Zero span	10 Hz to 5 MHz 1, 3, 10 sequence
Non-zero span	1 Hz to 5 MHz 1, 1.5, 2, 3, 5, 7.5, 10 sequence < 300 kHz, 300 kHz, 1 MHz, 3 MHz, 5 MHz (Other RBWs may be set depending on settings) Step keys change RBW in 1, 3, 10 sequence
Selectivity (-60 dB / -3 dB)	4:1

## Spectrum Analyzer (Option 233 on Combination Analyzers) (continued)

### Frequency and time specifications (continued)

Bandwidth accuracy		Nominal
Zero span	10 Hz to 1 MHz	± 5%
	3 MHz	± 10%
	5 MHz	± 15%
Non-zero span	1 Hz to 100 kHz	± 1%
	300 kHz to 1 MHz	± 5%
	3 MHz	± 10%
	5 MHz	± 15%
Video bandwidth (VBW)		
	1 Hz to 5 MHz	1, 1.5, 2, 3, 5, 7.5, 10 sequence

### Amplitude accuracy and range specifications

Amplitude range				
Measurement range	DANL to +20 dBm			
Input attenuator range	0 to 30 dB, in 5 dB steps			
Preamplifier		Nominal		
Frequency range	Full band (100 kHz to maximum frequency of instrument)			
Gain	N991xA, N993xA	+20 dB, 100 kHz to 26.5 GHz		
	N995xA, N996xA	+20 dB, 100 kHz to 7.5 GHz +15 dB, > 7.5 to 50 GHz		
Max safe input level	Average CW power	DC		
N991xA, N993xA	+27 dBm, 0.5 watts	± 50 VDC		
N995xA, N996xA	+25 dBm, 0.3 watts	± 40 VDC		
Display range				
Log scale	10 divisions			
	0.01 to 100 dB/division in 0.01 dB steps			
Linear scale	10 divisions			
Scale units	dBm, dBmV, dBμV, dBmA, dBμA, W, V, A, dBμV/m, dBμA/m, DBG, dBT			
50 MHz absolute amplitude accuracy (dB)				
0 dB attenuation, input signal 0 to -35 dBm, peak detector, preamplifier off, 300 Hz RBW, all settings auto-coupled. No warm-up required.				
	Spec (-10 to 55 °C)	Typical (-10 to 55 °C)		
N991xA, N993xA	± 0.30	± 0.10		
0 dB attenuation, input signal -5 to -35 dBm, peak detector, preamplifier off, 300 Hz RBW, all settings auto-coupled. No warm-up required.				
	Spec (-10 to 55 °C)	Typical (-10 to 55 °C)		
N995xA, N996xA	± 0.45	± 0.20		
Total absolute amplitude accuracy (dB)				
10 dB attenuation, input signal -15 to -5 dBm, peak detector, preamplifier off, 300 Hz RBW, all settings auto-coupled, includes frequency response uncertainties. No warm-up required.				
N991xA, N993xA <sup>1</sup>	Spec (23 ± 5 °C)	Spec (-10 to 55 °C)	Typical (23 ± 5 °C)	Typical (-10 to 55 °C)
100 kHz to 18 GHz	± 0.80	± 1.00	± 0.35	± 0.50
> 18 to 26.5 GHz	± 1.00	± 1.20	± 0.50	± 0.60

1. 9 to 100 kHz: 0.4 dB (nominal) preamp on or off; applicable only for serial number with prefix of MY5607/SG5607/US5607 and FieldFox upgraded with Option N9910HU-100/200/300/400.

## Spectrum Analyzer (continued)

### Amplitude accuracy and range specifications (continued)

#### Total absolute amplitude accuracy (dB)

10 dB attenuation, input signal -15 to -5 dBm, peak detector, preamplifier off, 300 Hz RBW, all settings auto-coupled, includes frequency response uncertainties. No warm-up required.

N995xA, N996xA <sup>2</sup>	Spec (23 ± 5 °C)	Spec (-10 to 55 °C)	Typical (23 ± 5 °C)	Typical (-10 to 55 °C)
9 to 100 kHz	± 1.60	± 2.50	± 0.60	± 1.30
> 100 kHz to 2 MHz	± 1.30	± 1.90	± 0.60	± 0.80
> 2 to 15 MHz	± 1.00	± 1.20	± 0.30	± 0.50
> 15 MHz to 32 GHz	± 0.80	± 1.00 <sup>2</sup>	± 0.30	± 0.50
> 32 to 40 GHz	± 0.90	± 1.40	± 0.50	± 0.70
> 40 to 43 GHz	± 1.30	± 2.00	± 0.50	± 0.70
> 43 to 50 GHz	± 1.40	± 2.70	± 0.50	± 0.90

- For N995x and N996x models, for frequencies > 100 kHz, absolute amplitude accuracy specifications apply to not only preamplifier off, but also preamplifier on.
- Increase by 0.2 dB between 18 and 32 GHz.

Resolution bandwidth switching uncertainty	Nominal	
RBW < 5 MHz	0.0 dB	
For signals not at center frequency	0.7 dB peak-to-peak	
RF input VSWR	Nominal	
N991xA, N993xA (10 dB attenuation)	10 MHz to 2.7 GHz	1.7 : 1
	> 2.7 to 7.5 GHz	1.5 : 1
	> 7.5 to 26.5 GHz	2.2 : 1
N995xA, N996xA (0 dB attenuation)	10 to 100 MHz	2.0 : 1
	> 100 to 500 MHz	1.7 : 1
	> 500 MHz to 17 GHz	1.5 : 1
	> 17 to 50 GHz	2.2 : 1
Reference level		
Range	-210 to +90 dBm	
Traces		
Detectors	Normal, positive peak, negative peak, sample, average (RMS)	
States	Clear/write, max hold, min hold, average, view, blank	
	Number of averages: 1 to 10,001	
Number	4: all four can be active simultaneously and in different states	
Markers		
Number of markers	6	
Type	Normal, delta, marker table	
Marker functions	Noise, band power, frequency counter	
Audio beep	Volume and tone change with signal strength	
Marker table	Display 6 markers	
Marker to →	Peak, next peak, peak left, peak right, center frequency, reference level, minimum	
	Tune frequency, for AM/FM tune and listen	
Marker properties	Peak criteria: peak excursion, peak threshold	
	Delta reference fixed: Off or On	
	Time zero fixed: Off or On	

## Spectrum Analyzer (continued)

### Dynamic range specifications

#### Displayed average noise level (DANL) - (dBm)

Input terminated, RMS detection, log averaging, 0 dB input attenuation, reference level of -20 dBm, normalized to 1 Hz RBW

#### N991xA, N993xA<sup>1</sup>

Preamp off	Spec (23 ± 5 °C)	Spec (-10 to 55 °C)	Typical (23 ± 5 °C)	Typical (-10 to 55 °C)
2 MHz to 4.5 GHz <sup>2</sup>	-137	-135	-139	-138
> 4.5 to 7 GHz	-133	-131	-136	-130
> 7 to 13 GHz	-129	-127	-132	-130
> 13 to 17 GHz	-124	-122	-126	-125
> 17 to 22 GHz	-119	-117	-122	-121
> 22 to 25 GHz	-114	-111	-117	-114
> 25 to 26.5 GHz	-110	-108	-112	-111
Preamp on	Spec (23 ± 5 °C)	Spec (-10 to 55 °C)	Typical (23 ± 5 °C)	Typical (-10 to 55 °C)
2 MHz to 4.5 GHz <sup>2</sup>	-153	-151	-155	-154
> 4.5 to 7 GHz	-149	-147	-151	-150
> 7 to 13 GHz	-147	-145	-149	-148
> 13 to 17 GHz	-143	-141	-145	-144
> 17 to 22 GHz	-140	-139	-143	-142
> 22 to 25 GHz	-134	-132	-137	-134
> 25 to 26.5 GHz	-128	-126	-131	-129

#### N995xA, N996xA

Preamp off	Spec (23 ± 5 °C)	Spec (-10 to 55 °C)	Typical (23 ± 5 °C)	Typical (-10 to 55 °C)
9 kHz to 2 MHz	-91	-91	-118	-118
> 2 MHz to 2.1 GHz	-137	-135	-143	-141
> 2.1 to 2.8 GHz	-135	-133	-142	-140
> 2.8 to 4.5 GHz	-137	-135	-143	-141
> 4.5 to 7 GHz	-134	-133	-140	-138
> 7 to 13 GHz	-134	-132	-141	-139
> 13 to 22 GHz	-132	-129	-140	-137
> 22 to 35 GHz	-130	-127	-137	-134
> 35 to 40 GHz	-122	-119	-132	-129
> 40 to 46 GHz	-119	-116	-126	-123
> 46 to 50 GHz	-117	-112	-124	-120
Preamp on	Spec (23 ± 5 °C)	Spec (-10 to 55 °C)	Typical (23 ± 5 °C)	Typical (-10 to 55 °C)
9 kHz to 2 MHz	-94	-94	-131	-130
> 2 MHz to 2.1 GHz	-153	-151	-159	-158
> 2.1 to 2.8 GHz	-151	-149	-157	-155
> 2.8 to 4.5 GHz	-153	-151	-158	-156
> 4.5 to 7 GHz	-150	-149	-156	-154
> 7 to 13 GHz	-146	-144	-152	-150
> 13 to 22 GHz	-142	-139	-149	-147
> 22 to 35 GHz	-141	-139	-147	-145
> 35 to 40 GHz	-136	-132	-144	-141
> 40 to 46 GHz	-131	-128	-138	-135
> 46 to 50 GHz	-126	-123	-135	-132

1. 9 kHz to 2 MHz: -116 (nominal) preamp off, -120 (nominal) preamp on, applicable only for FieldFox with serial number prefixes of MY5607/SG5607/US5607 and FieldFox upgraded with Option N9910HU-100/200/300/400.

2. Add 4 dB between 2.1 and 2.8 GHz.

## Spectrum Analyzer (continued)

### Dynamic range specifications (continued)

Residual responses (dBm)		Nominal	
Input terminated preamp off, 0 dB attenuation	N991xA, N993xA	N995xA, N996xA	
100 kHz to 13 GHz <sup>1</sup>	-110	-	
> 13 to 20 GHz	-90	-	
> 20 to 26.5 GHz	-80	-	
100 kHz to 10 MHz	-	-90	
> 10 MHz to 1 GHz	-	-115	
> 1 to 30 GHz	-	-120	
> 30 to 35 GHz	-	-85	
> 35 to 50 GHz	-	-110	
Input related responses (dBc)		Nominal	
	N991xA, N993xA	N995xA, N996xA	
-30 dBm signal at mixer input (excludes frequencies listed below)	-80	-80	
f = center frequency			
< 2.6 GHz, f + 2 x 33.75 MHz	-80	-80	
< 2.6 GHz, f - 2 x 866.25 MHz	-80	-80	
< 2.6 GHz, f + 2 x 3.63375 MHz	-85	-90	
≥ 2.6 to 7.5 GHz, f + 2 x 33.75 MHz	-80	-80	
≥ 2.6 to 7.5 GHz, f + 2 x 866.25 MHz	-80	-80	
≥ 2.6 to 7.5 GHz, f + 2 x 9.86625 GHz	-80	-85	
≥ 7.5 to 16.3 GHz, f + 2 x 3.63375 GHz	-65	-65	
≥ 16.3 to 26.5 GHz, f - 2 x 3.63375 GHz	-60	-	
≥ 7.5 to 26.5 GHz, f + 2 x 33.75 MHz	-80	-	
≥ 7.5 to 26.5 GHz, f - 2 x 866.25 MHz	-80	-	
≥ 16.3 to 23 GHz, f - 2 x 3.63375 MHz	-	-60	
≥ 23 to 32.5 GHz, f + 2 x 3.63375 MHz	-	-65	
≥ 32.5 to 43 GHz, f - 2 x 3.63375 MHz	-	-55	
≥ 7.5 to 50 GHz, f - 2 x 866.25 MHz	-	-80	
≥ 7.5 to 50 GHz, f + 2 x 33.75 MHz	-	-80	
Other spurious responses (dBc)		Nominal	
	N991xA, N993xA	N995xA, N996xA	
LO related spurs	-60	-60	
Sideband	-80	-80	
Second harmonic distortion (dBc)		Nominal	
-30 dBm signal at mixer input	N991xA, N993xA	N995xA, N996xA	
≤ 1.3 GHz <sup>2</sup>	-	< -75	
> 1.3 GHz	-	< -60	
≤ 4 GHz <sup>2</sup>	< -60	-	
> 4 GHz	< -80	-	

1. Excludes 4.5 MHz, -95 dBm at 4.5 MHz.
2. Applies to frequencies > 15 MHz

## Spectrum Analyzer (continued)

### Dynamic range specifications (continued)

Third order intermodulation distortion (TOI) - (dBm)	Spec	Typical
Two -15 dBm signals, 100 kHz spacing at input mixer (-10 to 55 °C) N991xA, N993xA	At 2.4 GHz, +15	< 1 GHz, +10 1 to 7.5 GHz, +15 > 7.5 GHz, +21
N995xA, N996xA	At 2.4 GHz, +14.2	50 to 500 MHz, +9.5 > 500 MHz to 1 GHz, +13 > 1 to 2.4 GHz, +16 > 2.4 to 2.6 GHz, +12 > 2.6 GHz, +13
Spur free dynamic range (dB) at 2.4 GHz 2/3 (TOI - DANL) in 1 Hz RBW	Nominal	
N991xA, N993xA	> 105	
N995xA, N996xA	> 104	

### Nominal distortion and noise limited (10 Hz RBW) dynamic range

Applies to N991xA and N993xA

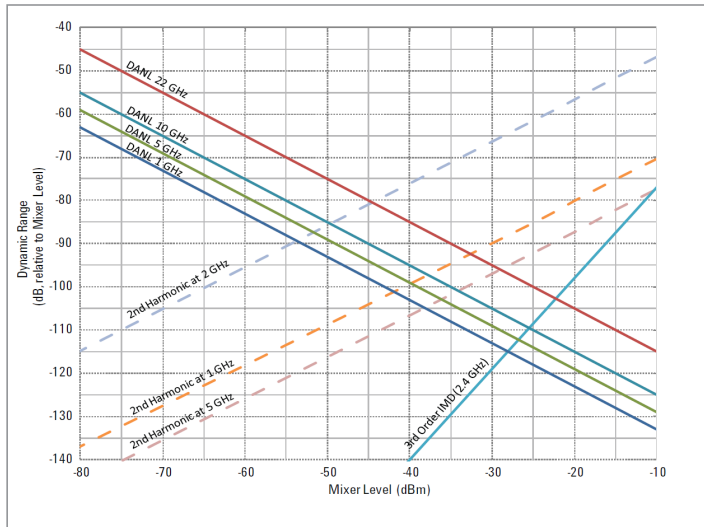

Applies to N995xA and N996xA

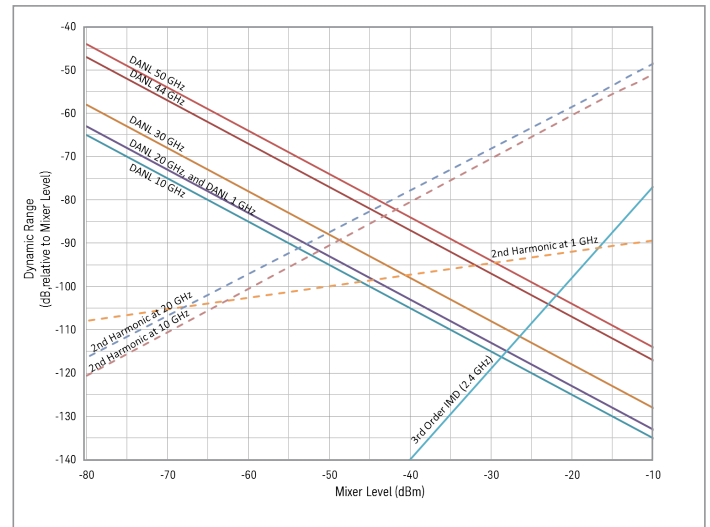

## Spectrum Analyzer (continued)

Phase noise (dBc/Hz)	SSB phase noise at 1 GHz (N991xA, N993xA, N995xA, N996xA)				
	Offset	Spec (23 ± 5 °C)	Spec (-10 to 55 °C)	Typical (23 ± 5 °C)	Typical (-10 to 55 °C)
	10 kHz	-106	-106	-111	-111
	30 kHz	-106	-104	-108	-110
	100 kHz	-100	-99	-104	-105
	1 MHz	-110	-110	-113	-113
	3 MHz	-119	-118	-122	-122
	5 MHz	-120	-120	-123	-123

### Phase noise at different center frequencies (nominal)

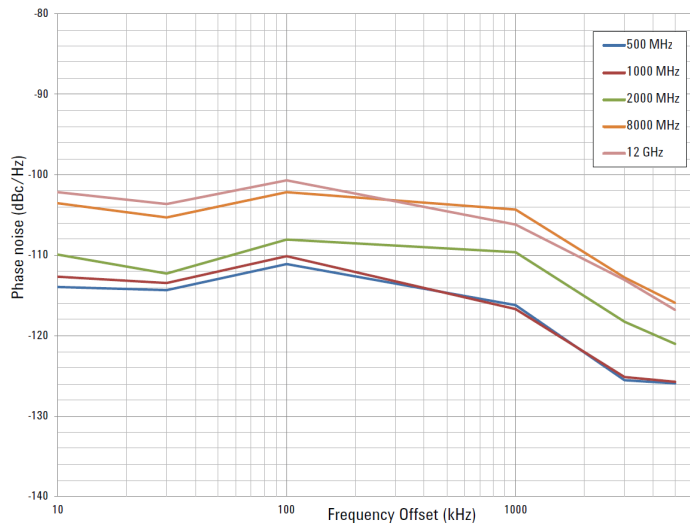

### Dynamic range versus offset frequency versus RBW (nominal)

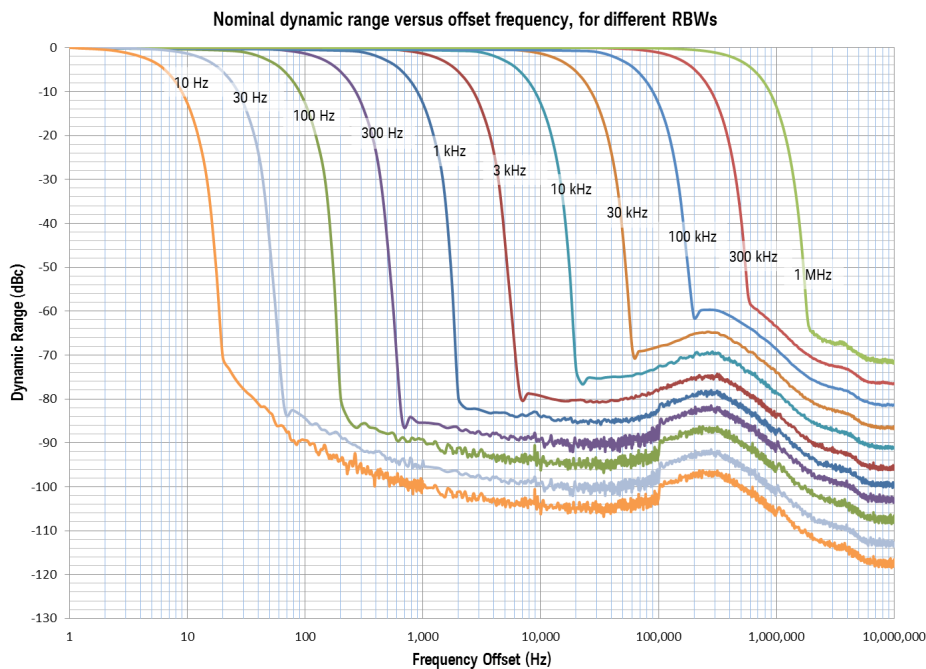

## Tracking Generator or Independent Source (See Configuration Guide for option information)

The performance listed in this section applies to the tracking generator and independent source capabilities available in the following models:

- FieldFox RF & microwave analyzers: N9913A, N9914A, N9915A, N9916A, N9917A, N9918A  
N9950A, N9951A, N9952A
- FieldFox microwave spectrum analyzers: N9935A, N9936A, N9937A, N9938A  
N9960A, N9961A, N9962A

See [FieldFox Configuration Guide](#) for option information. Many capabilities listed in this Data Sheet require options.

Note: Traditional tracking generators track the receiver frequency only. In FieldFox analyzers, the tracking generator frequency can be set to either track the receiver frequency, or act as an independent CW source.

	<b>Models</b>	<b>Tracking generator or independent source frequency range</b>
N991xA, N993xA	N9913A	30 kHz to 4 GHz
	N9914A	30 kHz to 6.5 GHz
	N9915A, N9935A	30 kHz to 9 GHz
	N9916A, N9936A	30 kHz to 14 GHz
	N9917A, N9937A	30 kHz to 18 GHz
	N9918A, N9938A	30 kHz to 26.5 GHz
N995xA, N996xA	N9950A, N9960A	300 kHz to 32 GHz
	N9951A, N9961A	300 kHz to 44 GHz
<b>Power step size</b>		
	Power settable in 1 dB steps across power range	
<b>Functions</b>		
Mode	Continuous wave (CW), CW coupled, tracking (swept frequency)	
Operations	Normalization, frequency offset, spectral reversal	
<b>RF output VSWR (10 dB attenuation)</b>		
	<b>Nominal</b>	
10 MHz to 2.7 GHz	1.7 : 1	
> 2.7 to 7.5 GHz	1.5 : 1	
> 7.5 GHz	2.2 : 1	



## Tracking Generator or Independent Source (continued)

Output power (dBm)	Frequency	Typical	Nominal
N991xA, N993xA	30 to 300 kHz	-11	-
	> 300 kHz to 2 MHz	-3	-2
	> 2 to 625 MHz	-2	-1
	> 625 MHz to 3 GHz	1	3
	> 3 to 6.5 GHz	-1	1
	> 6.5 to 9 GHz	-2	0
	> 9 to 14 GHz	-4	-2.5
	> 14 to 18 GHz	-6	-4.5
	> 18 to 23 GHz	-10	-8.5
> 23 to 26.5 GHz	-12	-11	
N995xA, N996xA	300 to 500 kHz	-	-9
	> 500 kHz to 2 MHz	-1	-
	> 2 MHz to 1 GHz	2	-
	> 1 to 6.5 GHz	2	-
	> 6.5 to 18 GHz	4	-
	> 18 to 26.5 GHz	2	-
	> 26.5 to 39 GHz	1	-
	> 39 to 44 GHz	-1	-
	> 44 to 46 GHz	-2	-
> 46 to 50 GHz	-4	-	
Dynamic range (dB)	Frequency	Preamp off Typical, -10 to 55 °C	Preamp on Nominal
N991xA, N993xA	2 MHz to 2 GHz	97	112
	> 2 to 7 GHz	93	108
	> 7 to 11 GHz	88	103
	> 11 to 16 GHz	79	95
	> 16 to 21 GHz	71	86
	> 21 to 23 GHz	55	70
	> 23 to 25 GHz	50	65
	> 25 to 26.5 GHz	45	60
N995xA, N996xA	500 kHz to 2 MHz	79	100
	> 2 MHz to 2.1 GHz	101	115
	> 2.1 to 2.8 GHz	99	112
	> 2.8 to 4.5 GHz	101	115
	> 4.5 to 10 GHz	99	105
	> 10 to 18 GHz	88	95
	> 18 to 40 GHz	85	90
> 40 to 43 GHz	65	80	
> 43 to 50 GHz	73	76	

## Real-Time Spectrum Analyzer (RTSA) (Option 350)

The performance listed in this section applies to the real-time spectrum analyzer capabilities available in the following models:

- FieldFox RF & microwave analyzers: N9913A, N9914A, N9915A, N9916A, N9917A, N9918A  
N9950A, N9951A, N9952A
- FieldFox microwave spectrum analyzers: N9935A, N9936A, N9937A, N9938A  
N9960A, N9961A, N9962A

See [FieldFox Configuration Guide](#) for option information. Many capabilities listed in this Data Sheet require options.

	Models	Real-time analysis frequency range	
N991xA, N993xA	N9913A	100 kHz to 4 GHz	Usable to 5 kHz
	N9914A	100 kHz to 6.5 GHz	Usable to 5 kHz
	N9915A, N9935A	100 kHz to 9 GHz	Usable to 5 kHz
	N9916A, N9936A	100 kHz to 14 GHz	Usable to 5 kHz
	N9917A, N9937A	100 kHz to 18 GHz	Usable to 5 kHz
	N9918A, N9938A	100 kHz to 26.5 GHz	Usable to 5 kHz
N995xA, N996xA	N9950A, N9960A	9 kHz to 32 GHz	Usable to 5 kHz
	N9951A, N9961A	9 kHz to 44 GHz	Usable to 5 kHz
	N9952A, N9962A	9 kHz to 50 GHz	Usable to 5 kHz

Real-time analysis		
Maximum real-time bandwidth	10 MHz	
Resolution bandwidth	1 Hz to 500 kHz	Span dependent, $20 \leq \text{Span}/\text{RBW} \leq 280$ . Default is 35.7 kHz
Minimum signal duration with 100% probability of intercept (POI) at full amplitude accuracy	12.2 $\mu$ s	At 10 MHz span, 500 kHz RBW
Minimum detectable signal Absolute amplitude accuracy at center frequency	22 ns	Minimum pulse signal duration where measured amplitude is no worse than 60 dB below a CW signal for a 10 MHz span and auto coupled RBW
Spurious-free dynamic range across maximum BW	63 dB	
FFT rate	120,000 FFT/s	At 10 MHz span
IF flatness ( <i>typical</i> )	$\pm 0.2 \text{ dB} \leq 26.5 \text{ GHz}$ ,	$\pm 0.3 \text{ dB} > 26.5 \text{ GHz}$
Number of display points	561	
Min. acquisition time	20 ms	At 10 MHz span
Max. acquisition time	500 ms	At 10 MHz span
Traces		
Number of traces	4: all four can be active simultaneously and in different states	
Detectors	Normal, positive peak, negative peak, sample, average (RMS)	
States	Clear/write, max. hold, min. hold, average, view, blank	
Markers		
Number of markers	6	
Type	Normal, delta, peak	
Marker $\rightarrow$	Peak, next peak, center frequency, reference level, minimum	
Trigger		
Trigger type	Free run, external, video, RF burst, periodic	

The performance listed in these sections below applies to the spectrum analyzer capabilities available in the following models:

- FieldFox RF & microwave analyzers: N9913A, N9914A, N9915A, N9916A, N9917A, N9918A, N9950A, N9951A, N9952A
- FieldFox microwave spectrum analyzers: N9935A, N9936A, N9937A, N9938A, N9960A, N9961A, N9962A

See [FieldFox Configuration Guide](#) for option information. Many capabilities listed in this Data Sheet require options.

## Spectrum Analyzer IF Output

	Description
Center Frequency	33.75 MHz
IF bandwidth	5 MHz (default), 25 MHz
Connector	SMB male
Conversion loss	0 to 27 dB nominal The loss increases approximately linearly as frequency increases, with ~27 dB loss at 26.5 GHz. Conversion loss is defined from RF input to SA output with -10 dBm input power, 0 dB attenuation, and preamp off.

## Analysis bandwidth<sup>1, 2</sup>

Model	N9913 /14 /15 /16 /17 /18A N9935 /36 /37 /38A		N9950 /51 /52A N9960 /61 /62A	
	Typical <sup>3</sup>		Typical <sup>3</sup>	
Maximum bandwidth			10 MHz	
IF flatness	Magnitude	± 0.2 dB	± 0.2 dB ≤ 26.5 GHz, ± 0.3 dB > 26.5 GHz	
	Phase deviation from linearity <sup>4</sup>	2.3° peak-to-peak, 1.6° rms	2.6° peak-to-peak, 1.8° rms	
	Group delay flatness (peak-to-peak) <sup>4</sup>	11 ns		
EVM (at center frequency 1 GHz)	LTE-A FDD TM3.1 (10 MHz)	0.6%	0.7%	
	WCDMA TM4 (5 MHz)	0.8%	0.85%	

## Preamplifier (Option 235)

	Nominal	
Frequency range	Full band (100 kHz to maximum frequency of instrument)	
Gain	N991xA, N993xA	+20 dB, 100 kHz to 26.5 GHz
	N995xA, N996xA	+20 dB, 100 kHz to 7.5 GHz
		+15 dB, > 7.5 to 50 GHz

## Interference Analyzer and Spectrogram (Option 236)

	Description
Spectrogram display	Overlay, full screen, top, or bottom with active trace
Waterfall angle	Moderate, steep, gradual, wide angle
Markers	Time, delta time
Trace playback and recording	<ul style="list-style-type: none"> <li>– Record all spectrum analyzer measurements</li> <li>– Playback recorded data using FieldFox</li> <li>– Store data internally or USB or SD card</li> <li>– Frequency mask trigger allows recording to occur upon trigger</li> </ul>

## Channel Scanner (Option 312)

	Description
Scan Mode	Range or custom list
Display Type	Bar chart vertical, bar chart horizontal, channel power, strip chart, chart overlay, scan & listen
Data logging mode	Time with geo tagging
Trace playback and recording	<ul style="list-style-type: none"> <li>– Record channel power measurement</li> <li>– Playback recorded data using FieldFox</li> <li>– Store data internally or USB or SD card in .csv or .kml format</li> <li>– Data in .kml format can be exported to Google Earth</li> </ul>

1. Analysis bandwidth is the instantaneous bandwidth available around a center frequency over which the input signal can be digitized for further analysis or processing in the time, frequency, or modulation domain.

2. Analysis bandwidth capability supported on 89600 VSA Software.  
3. These numbers were generated from the room temperature results.  
4. Not guaranteed below 50 MHz.

The performance listed in this section applies to the AM/FM analog demodulation, tune and listen capabilities available in the following models:

- FieldFox RF & microwave analyzers: N9913A, N9914A, N9915A, N9916A, N9917A, N9918A  
N9950A, N9951A, N9952A
- FieldFox microwave spectrum analyzers: N9935A, N9936A, N9937A, N9938A  
N9960A, N9961A, N9962A

See [FieldFox Configuration Guide](#) for option information. Many capabilities listed in this Data Sheet require options.

## AM/FM Analog demodulation, Tune and Listen (Option 355)

	Description
Display type	RF spectrum view, demodulated waveform, including peak+ and peak- traces
Audio demodulation type	AM, FM narrow, FM wide, Listen to the tones using FieldFox's built-in speaker or headphones
Audio bandwidth	16 kHz
Measurement type	RF carrier power (dBm), RF carrier frequency (Hz), modulation rate (Hz), SINAD (dB), THD (%)
<b>Receiver IF bandwidth</b>	<b>Nominal</b>
AM	35 kHz
FM narrow	12 kHz
FM wide	150 kHz
Listen time range	0 to 100 seconds
<b>AM &amp; FM metrics</b>	<b>Nominal</b>
SINAD	2.5 dB to 65 dB
THD	0 to 75%
<b>AM measurements</b>	<b>Nominal</b>
Maximum modulation rate	5 kHz, demod sweep time: 50 $\mu$ s to 50 ms
Depth	(peak-to-peak/2) (%), $\pm$ peak depth (%)
Depth accuracy	$\pm$ 2%
Depth range	Modulation: 0.1 % to 99%
<b>FM measurements</b>	<b>Nominal</b>
Maximum modulation rate	5 kHz, demod sweep time: 50 $\mu$ s to 50 ms
Frequency deviation	(Hz), $\pm$ peak deviation (Hz)
Maximum deviation	30 kHz (typical)

## Radio standards

With a radio standard applied, pre-defined frequency bands, channel numbers or uplink / downlink selections can be used instead of manual frequency entry. The pre-defined FieldFox radio standards include bands such as W-CDMA, LTE, and GSM. Alternately, users can create custom standards and import them into FieldFox analyzers.

## Spectrum Analyzer Time Gating (Option 238)

With time gating, you can measure the spectrum of a periodic signal during a specified time interval. Pulsed-RF signals are an example of a periodic signal that can be measured with time gating. For example, you can measure the pulse during the on period, not the transition or the off period. Or you can exclude interfering signals such as a periodic transient. Time gating allows you to view spectral components that would otherwise be hidden. FieldFox's time gating method is a Gated FFT.

	Description
Gate method	Gated FFT
Span range	Any span
RBW range	1 Hz to 300 kHz (derived from gate width)
Gate delay range	-150 ms to 10 s
Gate width (length) range	6 $\mu$ s to 1.8 s
Gate sources	External, RF burst, Video

## Reflection Measurements (RL, VSWR) (Option 320, applicable to SA only models)

The performance listed in this section applies to the reflection measurements capabilities available in the following models:

- FieldFox microwave spectrum analyzers: N9935A, N9936A, N9937A, N9938A<sup>1</sup>  
N9960A, N9961A, N9962A

See [FieldFox Configuration Guide](#) for option information. Many capabilities listed in this Data Sheet require options.

	Models	Reflection Measurements
N993xA	N9935A	30 kHz to 9 GHz
	N9936A	30 kHz to 14 GHz
	N9937A	30 kHz to 18 GHz
	N9938A <sup>1</sup>	30 kHz to 26.5 GHz
N996xA	N9960A	300 kHz to 32 GHz
	N9961A	300 kHz to 44 GHz
	N9962A	300 kHz to 50 GHz

### Measurements

Return loss, VSWR normalization using data/memory

1. Reflection measurements in N9938A specifically require 3.5 mm (m) test ports instead of the standard Type-N (f).

## Extended Range Transmission Analysis (ERTA) (Option 209)

ERTA specifications apply to the following FieldFox models. The RF & microwave analyzers must be equipped with the spectrum analyzer option.

- FieldFox RF & microwave analyzers: N9913A, N9914A, N9915A, N9916A, N9917A, N9918A  
N9950A, N9951A, N9952A
- FieldFox microwave spectrum analyzers: N9935A, N9936A, N9937A, N9938A  
N9960A, N9961A, N9962A

ERTA operation requires two FieldFoxes, each one configured with specific options, and certain accessories. See FieldFox [Configuration Guide](#) for detailed option ordering information. Many capabilities listed in this Data Sheet require options.

### System description

ERTA can be used to measure the scalar transmission gain or loss of an RF system. It is useful when measuring long lossy cables where the two ends cannot easily be brought together, such as those bolted in on ships or aircrafts. It is also useful in measuring the insertion loss of waveguide systems, or using the frequency-offset feature, devices such as mixers and converters.

ERTA measurements are based on two FieldFoxes; one at each end of the measured DUT. One FieldFox is the source and reference receiver (R), while the other is the measurement receiver (B). The two FieldFoxes are synchronized using hardware triggering. By taking advantage of FieldFox's InstAlign technique, ERTA can be used to make accurate gain or loss measurements.

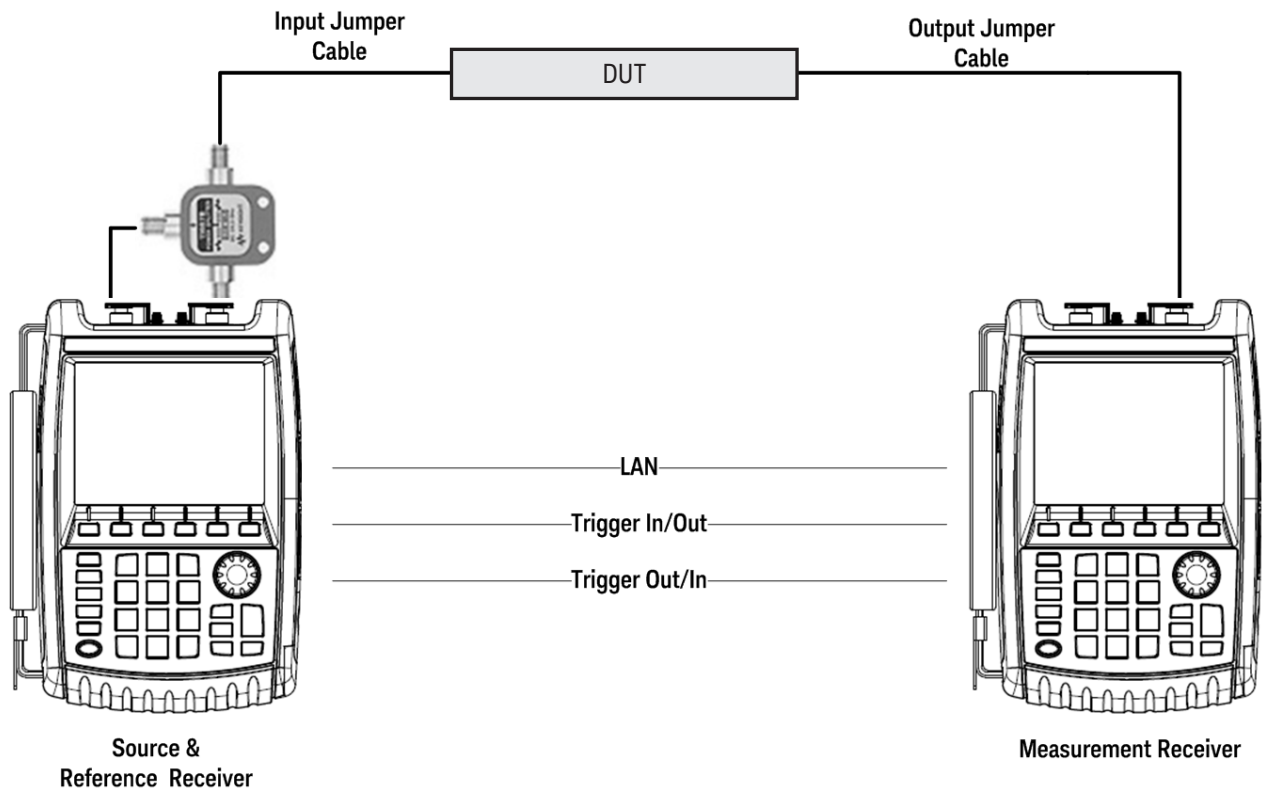

## Extended Range Transmission Analysis (ERTA) (continued)

### Frequency specifications

The ERTA frequency range is limited by each individual analyzer's frequency range.

	Models	Reflection measurements	Receiver frequency range <sup>1</sup>
N991xA, N993xA	N9913A	30 kHz to 4 GHz	100 kHz to 4 GHz
	N9914A	30 kHz to 6.5 GHz	100 kHz to 6.5 GHz
	N9915A, N9935A	30 kHz to 9 GHz	100 kHz to 9 GHz
	N9916A, N9936A	30 kHz to 14 GHz	100 kHz to 14 GHz
	N9917A, N9937A	30 kHz to 18 GHz	100 kHz to 18 GHz
	N9918A, N9938A	30 kHz to 26.5 GHz	100 kHz to 26.5 GHz
N995xA, N996xA	N9950A, N9960A	300 kHz to 32 GHz	300 kHz to 32 GHz
	N9951A, N9961A	300 kHz to 44 GHz	300 kHz to 44 GHz
	N9952A, N9962A	300 kHz to 50 GHz	300 kHz to 50 GHz

1. The receiver (spectrum analyzer) is usable to 5 kHz, though only specified to 100 kHz or 300 kHz.

#### Frequency reference

Refer to the frequency accuracy specifications.

#### Source output power

Refer to the test port output power typical data.

#### Frequency setup parameters

Receiver frequency	Center/span or start/stop (standard spectrum analyzer settings) Reverse receiver sweep direction (default direction is forward, but can be set to reverse)
Source frequency [Remote]	[Tracking] – FieldFox source tracks the receiver by default. The frequencies are identical. [CW] – FieldFox's source can be set to a CW frequency independent of FieldFox's receiver frequency. FieldFox's source is at a single CW frequency; FieldFox's receiver is swept. [Coupled CW] – FieldFox's source CW frequency is auto-coupled to FieldFox's receiver [Center Frequency] setting.

#### Frequency-offset capability

This feature allows the FieldFox's source frequency to be offset from FieldFox's receiver frequency. The offset frequency can be negative, zero, or positive. The frequency-offset capability is useful when characterizing the scalar transmission response of devices such as mixers and converters.

#### Frequency-offset setup parameters

Receiver frequency	Center/span or start/stop (standard spectrum analyzer settings) Reverse receiver sweep direction (default direction is forward, but can be set to reverse)
Frequency tracking offset	On/Off Offset values: 0, > 0, < 0
Receiver sweep direction	Reversal: Off Default setting Both source and receiver sweep in the forward direction. Receiver stop frequency > Receiver start frequency Source frequency = Offset + Receiver frequency  Reversal: On Source and receiver sweep in opposite directions. Source frequency = Offset – Receiver frequency Offset > receiver frequency

## Extended Range Transmission Analysis (ERTA) (continued)

### Dynamic range and maximum attenuation

**Dynamic range** is the difference between the maximum output power available from FieldFox's source and the noise floor of the second FieldFox, while ensuring that neither FieldFox's ADC goes into over-range. Dynamic range also accounts for the loss of the power splitter. Dynamic range is applicable when testing devices such as filters, where there is low loss in the passband, and significant loss in the stopband, and both passband and stopband need to be on the display at the same time (same sweep).

**Maximum attenuation** is the difference between maximum output power available from FieldFox's source and the noise floor of FieldFox. It also accounts for the loss of power splitter. Maximum attenuation is applicable when testing devices such as cables, which have relatively uniform loss over the swept frequency range.

The values shown are based on the recommended minimum RBW of 3 kHz when the frequency references are locked via GPS, and 300 kHz when the frequency references are unlocked. Locking the frequency references to GPS allows for greater frequency accuracy of the FieldFoxes and use of a narrower RBW, which in turn results in a lower DANL, and hence a wider measurement range. When the GPS signals cannot be present at all times, the GPS hold-over mode can be used.

Dynamic range (dB)		Typical		
N991xA, N993xA	Preamp off	Preamp on	Preamp off	Preamp on
	Frequency references locked to GPS, RBW 3 kHz	Frequency references locked to GPS, RBW 3 kHz	Frequency references unlocked, RBW 300 kHz	Frequency references unlocked, RBW 300 kHz
> 2 MHz <sup>1</sup> to 6 GHz	88	83	68	63
> 6 to 13 GHz	86	83	66	63
> 13 to 22 GHz	70	86	50	66
> 22 to 25 GHz	63	83	43	63
> 25 to 26.5 GHz	58	77	38	57
Maximum attenuation (dB)		Typical		
N991xA, N993xA	Preamp off	Preamp on	Preamp off	Preamp on
	Frequency references locked to GPS, RBW 3 kHz	Frequency references locked to GPS, RBW 3 kHz	Frequency references unlocked, RBW 300 kHz	Frequency references unlocked, RBW 300 kHz
> 2 MHz to 6 GHz	93	108	73	88
> 6 to 13 GHz	86	103	66	83
> 13 to 22 GHz	70	91	50	71
> 22 to 25 GHz	63	83	43	63
> 25 to 26.5 GHz	58	77	38	57

1. Dynamic range is decreased from 3 to 9 dB at 2 MHz.



## Extended Range Transmission Analysis (ERTA) (continued)

### Dynamic range and maximum attenuation (continued)

Dynamic range (dB)		Typical		
N995xA, N996xA	Preamp off	Preamp on	Preamp off	Preamp on
	Frequency references locked to GPS, RBW 3 kHz	Frequency references locked to GPS, RBW 3 kHz	Frequency references unlocked, RBW 300 kHz	Frequency references unlocked, RBW 300 kHz
> 2 to 5 MHz	83	87	62	58
> 5 MHz to 11 GHz	93	97	69	68
> 11 to 19 GHz	95	96	71	70
> 19 to 22 GHz	93	94	69	68
> 22 to 40 GHz	88	90	63	65
> 40 to 43 GHz	82	89	57	64
> 43 to 46 GHz	81	93	56	68
> 46 to 50 GHz	77	88	52	63

Maximum attenuation (dB)		Typical		
N995xA, N996xA	Preamp off	Preamp on	Preamp off	Preamp on
	Frequency references locked to GPS, RBW 3 kHz	Frequency references locked to GPS, RBW 3 kHz	Frequency references unlocked, RBW 300 kHz	Frequency references unlocked, RBW 300 kHz
> 2 MHz to 13 GHz	100	113	74	88
> 13 to 18 GHz	101	110	76	85
> 18 to 22 GHz	99	108	74	83
> 22 to 35 GHz	95	105	70	80
> 35 to 40 GHz	88	100	63	75
> 40 to 46 GHz	81	93	56	63
> 46 to 50 GHz	77	88	52	63

### Absolute power and gain measurement uncertainties

Verified with input level of -10 dBm, peak detector, 10 dB attenuation, preamplifier off, all settings auto-coupled, no warm-up required. Includes frequency response uncertainties. Assumes an ERTA system using a Keysight 11667A, 11667B, or 11667C power splitter.

N991xA and N993xA				
Input power (R) measurements uncertainty, 30 kHz RBW (dB)				
	Spec (23 ± 5 °C)	Spec (-10 to 55 °C)	Typical (23 ± 5 °C)	Typical (-10 to 55 °C)
100 kHz to 18 GHz	± 1.10	± 1.30	± 0.40	± 0.50
> 18 to 26.5 GHz	± 1.40	± 1.50	± 0.50	± 0.60

Output power (B) measurement uncertainty, frequency references locked to GPS, RBW ≥ 3 kHz (dB)				
	Spec (23 ± 5 °C)	Spec (-10 to 55 °C)	Typical (23 ± 5 °C)	Typical (-10 to 55 °C)
100 kHz to 18 GHz	± 1.00	± 1.20	± 0.40	± 0.50
> 18 to 26.5 GHz	± 1.20	± 1.40	± 0.50	± 0.60

Output power (B) measurement uncertainty, frequency references unlocked, RBW ≥ 300 kHz (dB)				
	Spec (23 ± 5 °C)	Spec (-10 to 55 °C)	Typical (23 ± 5 °C)	Typical (-10 to 55 °C)
100 kHz to 18 GHz	± 1.00	± 1.30	± 0.40	± 0.50
> 18 to 26.5 GHz	± 1.40	± 1.60	± 0.50	± 0.60

Gain/Loss (B/R) measurement uncertainty, frequency references locked to GPS, RBW ≥ 3 kHz (dB)				
	Spec (23 ± 5 °C)	Spec (-10 to 55 °C)	Typical (23 ± 5 °C)	Typical (-10 to 55 °C)
100 kHz to 18 GHz	± 1.30	± 1.70	± 0.60	± 0.70
> 18 to 26.5 GHz	± 1.70	± 2.10	± 0.70	± 0.90

Gain/Loss (B/R) measurement uncertainty, frequency references unlocked, RBW ≥ 300 kHz (dB)				
	Spec (23 ± 5 °C)	Spec (-10 to 55 °C)	Typical (23 ± 5 °C)	Typical (-10 to 55 °C)
100 kHz to 18 GHz	± 1.40	± 1.70	± 0.70	± 0.70
> 18 to 26.5 GHz	± 2.00	± 2.10	± 0.90	± 1.00

## Extended Range Transmission Analysis (ERTA) (continued)

### Absolute power and gain measurement uncertainties (continued)

<b>N995xA and N996xA</b>				
<b>Input power (R) measurements uncertainty, 30 kHz RBW (dB)</b>				
	<b>Spec (23 ± 5 °C)</b>	<b>Spec (-10 to 55 °C)</b>	<b>Typical (23 ± 5 °C)</b>	<b>Typical (-10 to 55 °C)</b>
2 MHz to 18 GHz	± 1.10	± 1.30	± 0.50	± 0.60
> 18 to 32 GHz	± 1.20	± 1.50	± 0.50	± 0.70
> 32 to 40 GHz	± 1.30	± 1.80	± 0.60	± 0.80
> 40 to 43 GHz	± 1.60	± 2.30	± 0.70	± 1.10
> 43 to 50 GHz	± 1.70	± 3.20	± 0.80	± 1.40
<b>Output power (B) measurement uncertainty, frequency references locked to GPS, RBW ≥ 3 kHz (dB)</b>				
	<b>Spec (23 ± 5 °C)</b>	<b>Spec (-10 to 55 °C)</b>	<b>Typical (23 ± 5 °C)</b>	<b>Typical (-10 to 55 °C)</b>
2 MHz to 18 GHz	± 0.40	± 1.00	± 0.40	± 0.50
> 18 to 32 GHz	± 0.45	± 1.30	± 0.40	± 0.60
> 32 to 40 GHz	± 0.50	± 1.50	± 0.50	± 0.70
> 40 to 43 GHz	± 0.80	± 2.30	± 0.70	± 1.00
> 43 to 50 GHz	± 0.90	± 3.00	± 0.80	± 1.40
<b>Output power (B) measurement uncertainty, frequency references unlocked, RBW ≥ 300 kHz (dB)</b>				
	<b>Spec (23 ± 5 °C)</b>	<b>Spec (-10 to 55 °C)</b>	<b>Typical (23 ± 5 °C)</b>	<b>Typical (-10 to 55 °C)</b>
2 MHz to 18 GHz	± 1.00	± 1.10	± 0.40	± 0.50
> 18 to 32 GHz	± 1.20	± 1.50	± 0.50	± 0.60
> 32 to 40 GHz	± 1.60	± 1.90	± 0.60	± 0.80
> 40 to 43 GHz	± 2.10	± 2.50	± 0.70	± 1.30
> 43 to 50 GHz	± 2.60	± 3.60	± 1.00	± 1.60
<b>Gain/Loss (B/R) measurement uncertainty, frequency references locked to GPS, RBW ≥ 3 kHz (dB)</b>				
	<b>Spec (23 ± 5 °C)</b>	<b>Spec (-10 to 55 °C)</b>	<b>Typical (23 ± 5 °C)</b>	<b>Typical (-10 to 55 °C)</b>
2 MHz to 18 GHz	± 1.40	± 1.70	± 0.60	± 0.70
> 18 to 32 GHz	± 1.50	± 2.00	± 0.70	± 0.90
> 32 to 40 GHz	± 1.60	± 2.30	± 0.80	± 1.00
> 40 to 43 GHz	± 2.20	± 3.10	± 1.00	± 1.40
> 43 to 50 GHz	± 2.40	± 4.00	± 1.20	± 1.90
<b>Gain/Loss (B/R) measurement uncertainty, frequency references unlocked, RBW ≥ 300 kHz (dB)</b>				
	<b>Spec (23 ± 5 °C)</b>	<b>Spec (-10 to 55 °C)</b>	<b>Typical (23 ± 5 °C)</b>	<b>Typical (-10 to 55 °C)</b>
2 MHz to 18 GHz	± 1.40	± 1.70	± 0.70	± 0.70
> 18 to 32 GHz	± 1.80	± 2.10	± 0.80	± 1.00
> 32 to 40 GHz	± 2.10	± 2.80	± 1.00	± 1.30
> 40 to 43 GHz	± 2.70	± 3.50	± 1.40	± 1.70
> 43 to 50 GHz	± 3.00	± 4.80	± 1.60	± 2.40

### Cable correction

Input and output jumper cable losses can be accounted for using ERTA's cable correction wizard.

The performance listed in built-on power meter, external USB power sensor support, pulse measurements, USB power sensor measurements versus frequency sections applies to the capabilities available in the following models:

- FieldFox RF & microwave analyzers: N9913A, N9914A, N9915A, N9916A, N9917A, N9918A  
N9950A, N9951A, N9952A
- FieldFox microwave vector network analyzers: N9925A, N9926A, N9927A, N9928A
- FieldFox microwave spectrum analyzers: N9935A, N9936A, N9937A, N9938A  
N9960A, N9961A, N9962A

See [FieldFox Configuration Guide](#) for option information. Many capabilities listed in this Data Sheet require options.

## Built-in Power Meter (Option 310)

Using the built-in power meter, FieldFox is able to make very accurate channel power measurements. The channel bandwidth can be set wide to simulate average power meter measurements. This measurement function provides the flexibility to make user definable channel power measurements.

Description				
Setup parameters	Center frequency, including selection of radio standards and channel selection, span or channel width			
Functions	Relative/absolute measurements, offsets, units of dBm or watts, or dB or %, minimum and maximum limits			
Models	Frequency range			
N991xA, N992xA, N993xA	N9913A	30 kHz to 4 GHz	Usable to 5 kHz	
	N9914A	30 kHz to 6.5 GHz	Usable to 5 kHz	
	N9915A, N9925A, N9935A	30 kHz to 9 GHz	Usable to 5 kHz	
	N9916A, N9926A, N9936A	30 kHz to 14 GHz	Usable to 5 kHz	
	N9917A, N9927A, N9937A	30 kHz to 18 GHz	Usable to 5 kHz	
	N9918A, N9928A, N9938A	30 kHz to 26.5 GHz	Usable to 5 kHz	
N995xA, N996xA	N9950A, N9960A	300 kHz to 32 GHz	Usable to 5 kHz	
	N9951A, N9961A	300 kHz to 44 GHz	Usable to 5 kHz	
	N9952A, N9962A	300 kHz to 50 GHz	Usable to 5 kHz	
Amplitude accuracy (dB)				
N991xA, N992xA, N993xA	Spec (23 ± 5 °C)	Spec (-10 to 55 °C)	Typical (23 ± 5 °C)	Typical (-10 to 55 °C)
100 kHz to 18 GHz	± 0.80	± 1.00	± 0.35	± 0.50
> 18 to 26.5 GHz	± 1.00	± 1.20	± 0.50	± 0.60
N995xA, N996xA	Spec (23 ± 5 °C)	Spec (-10 to 55 °C)	Typical (23 ± 5 °C)	Typical (-10 to 55 °C)
9 to 100 kHz	± 1.60	± 2.50	± 0.60	± 1.30
> 100 kHz to 2 MHz	± 1.30	± 1.90	± 0.60	± 0.80
> 2 to 15 MHz	± 1.00	± 1.20	± 0.30	± 0.50
> 15 MHz to 32 GHz	± 0.80	± 1.00 <sup>1</sup>	± 0.30	± 0.50
> 32 to 40 GHz	± 0.90	± 1.40	± 0.50	± 0.70
> 40 to 43 GHz	± 1.30	± 2.00	± 0.50	± 0.70
> 43 to 50 GHz	± 1.40	± 2.70	± 0.50	± 0.90

1. Increase by 0.2 dB between 18 and 32 GHz.

## External USB Power Sensor Support (Option 302)

The external USB power sensor option supports various Keysight USB power sensors. For an up-to-date listing of the supported power sensors, visit <http://www.keysight.com/find/fieldfoxsupport>.

	Description
Setup parameters	Frequency
Functions	Relative/absolute measurements, offsets, units of dBm or watts, or dB or %, minimum and maximum limits.
Internal source	FieldFox's internal source can be turned on in the USB power sensor mode. CW frequency and nominal power level control are available.

## Pulse Measurements (Option 330)

FieldFox's pulse measurement option can be used to characterize RF pulses such as those used in radar and electronic warfare systems. Measurements are made using FieldFox and Keysight's USB peak power sensors.

Performance specifications such as frequency, dynamic range and minimum pulse width depend on the peak power sensor. Supported peak power sensors: <http://www.keysight.com/find/fieldfoxsupport>

	Description
Setup parameters	Frequency, time (center), time/division, gating, triggering, video bandwidth, averaging
Functions	Average power, peak power, and peak to average ratio
	Analog gauge display and digital display, dBm and watts
	Relative/absolute measurements, offset, dB or %, minimum and maximum limits
	Trace graph for pulse profiling with gating
	Rise time, fall time, pulse width, pulse period, pulse repetition frequency

## USB Power Sensor Measurements versus Frequency (Option 208)

This feature allows FieldFox's source frequency to be set independently from the power sensor (receiver) frequency. With frequency-offset using power sensor (FOPS), the frequency of both the source and receiver are swept, and the two track each other. The offset frequency can be negative, zero, or positive.

FOPS can be used to characterize the scalar transmission response of devices such as mixers and converters. This frequency-offset capability is necessary for conversion loss/gain measurements on frequency-translating devices, since by definition, the input and output frequencies of the DUT are different. The FieldFox source stimulates the DUT and the power sensor is used as the measurement receiver.

Since power sensors are inherently broadband devices (not frequency-selective), the user should ensure that only the signal of interest is present at the power sensor input and that all other signals are filtered appropriately.

Setup parameters	
Source frequency	Center/span or start/stop
Receiver frequency	Range determined by power sensor range
Frequency offset	Positive offset or negative offset
Frequency step size	30 kHz minimum
Number of points	2 to 1601
Combination of number of points and frequency step size limited by span.	
Dwell time/point	0 to 1.0 sec

## USB Power Sensor Measurements versus Frequency (continued)

Source frequency span must be equal to receiver frequency span.

Receiver sweep direction: forward (default setting) or reverse.

For some DUTs, the output frequency may sweep in a reverse direction, as compared to the source frequency. The basic relationships between the source, receiver and offset frequencies are shown in the table below. The FieldFox analyzer includes an offset calculator that ensures a fast measurement setup.

Src sweep direction	Rx sweep direction	Frequency calculations
Forward $f2_{src} > f1_{src}$	Forward $f2_{rx} > f1_{rx}$	Receiver frequency = Source frequency $\pm$ Offset
Forward $f2_{src} > f1_{src}$	Reverse $f2_{rx} > f1_{rx}$	Receiver frequency = Offset – Source Frequency Offset > Source frequency

	Description
Measurements	Source power, gain/loss and receiver (Rx) power Gain = Rx power / source power (memory). Source power (memory) is measured during setup.
Output power	Refer to the test port output power typical data on page 5.
Dynamic range	The dynamic range with FOPS is dependent on FieldFox's output power and the power sensor's dynamic range. Supported USB power sensors: <a href="http://www.keysight.com/find/fieldfoxsupport">www.keysight.com/find/fieldfoxsupport</a>

The graph below shows a filter measurement using two different power sensors, the U2002A (–60 to +20 dBm) and the U2021XA (–45 to +20 dBm). While a filter is not commonly measured using FOPS, it is a useful device for demonstrating dynamic range.

For both measurements, the FieldFox source power was set to –1 dBm, the maximum available in the selected frequency range of 7.25 to 13.25 GHz. An external amplifier was not used in this case, but one can be added to increase the source power and hence dynamic range.

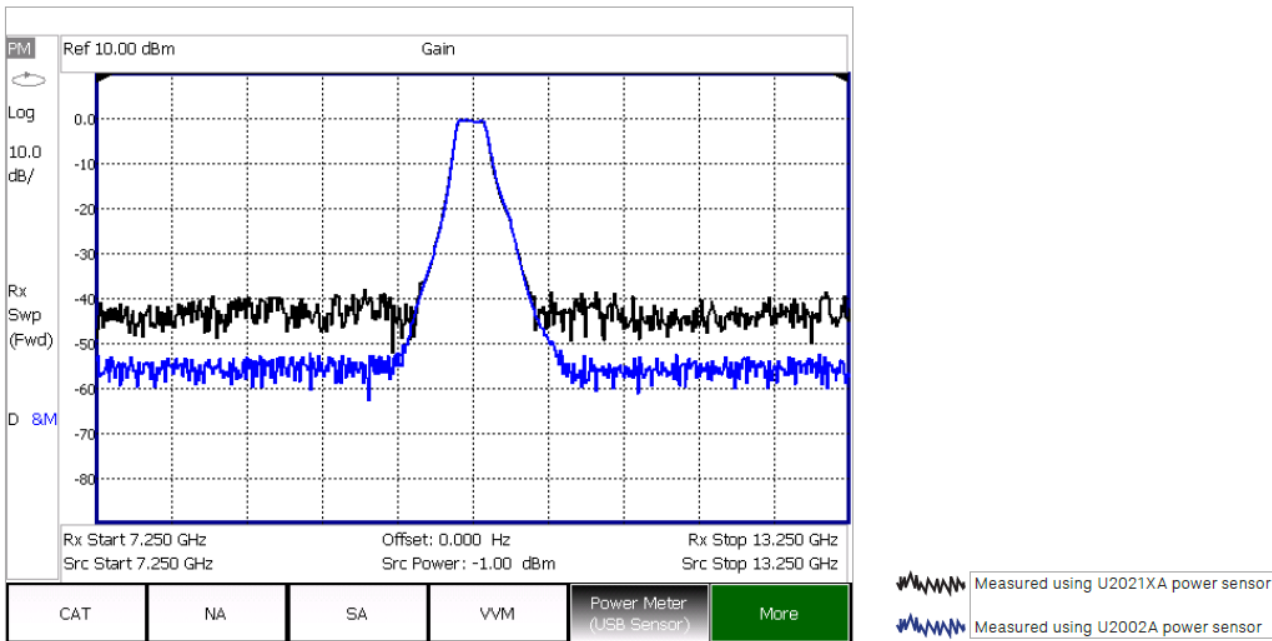

Example showing typical dynamic range of FOPS

## Built-In GPS Receiver (Option 307)

	Description
GPS receiver	The internal GPS receiver can be used as a frequency reference. <sup>1</sup>
Modes	Off, internal, external
Sync clock	On, off
Functionality	Geo-location: latitude, longitude, altitude (elevation), time, sync time/data Requires external GPS antenna (can use N9910X-825, GPS active antenna)
Connector for antenna	SMA (f), 3.3 V

1. External GPS USB receivers can be used to provide geo-location data. However, they cannot be used for frequency reference locking.

## DC Bias Variable-Voltage Source (Option 309)

	Description
	Nominal
Connector	SMB (m)
Voltage	+1 to +32 V
Resolution	0.1 V
Maximum current <sup>1</sup>	0.65 A
DC current readout resolution	0.01 A
Maximum power <sup>1</sup>	7 watts
Display read out	Voltage, current
Overload trip protection	Automatically engages when voltage source is on. The trip circuit can be reset from front panel without presetting or power cycling the analyzer.

1. Battery life will be reduced when DC source is used. A trip function turns off the power supply when the rated current or power is exceeded.

## Remote Control Capability (Option 030)

Option 030 adds remote control capability to FieldFox analyzers, so that FieldFox can be controlled via an iOS device. The FieldFox app, running on the iOS device, combined with Option 030 on the FieldFox analyzer provides full control of the instrument from a remote location. The app emulates the front panel of FieldFox, so users can press the FieldFox hardkeys or softkeys using their iPhone or iPad, and make measurements remotely.

For example, a tower climber can be on the tower with a FieldFox analyzer, while the technician controls and makes the measurements down below, using an iPad. The iPad and FieldFox communicate via a network connection.

iOS device requirements

- iPad, iPhone, or iPod Touch
- iOS of 6.1 or higher
- A WiFi or 3G/4G connection

The FieldFox app communicates with FieldFox via a network connection, so both the iOS device and FieldFox need to be on a network where both devices can reach the other. For example, a company intranet or a site installation using a wireless router. FieldFox can directly be connected to a LAN cable, or if wired LAN is not available, a user supplied wireless router can be configured to work with FieldFox. FieldFox does not include a wireless router.

## Remote Control Capability (continued)

### FieldFox app without Option 030

The FieldFox app can be installed on an iOS device independent of the presence of Option 030 on the analyzer. Without Option 030, users can view the live display screen of their FieldFox remotely, but cannot control the instrument. With 030 purchased and installed on their FieldFox, users can both view and control their FieldFox. Control refers to the ability to press hardkeys, softkeys, make or change measurements, etc.

Option 030 does not include the iOS device itself. Users must supply their own iOS device. Option 030 is a license on the FieldFox analyzer.

Option 030 and the FieldFox app are not applicable to Android, BlackBerry, or Windows phone/tablet devices.

## General Information

<b>Calibration cycle</b>	
	1 year
<b>Weight</b>	
N991xA, N992xA, N993xA	3.0 kg or 6.6 lb including battery
N995xA, N996xA	3.2 kg or 7.1 lb including battery
<b>Dimensions: H x W x D</b>	
	292 x 188 x 72 mm (11.5 in x 7.4 in x 2.8 in)
<b>Environmental</b>	
MIL-PRF-28800F Class 2	Operating temperature Storage temperature Operating humidity Random vibration Functional shock Bench drop
Maximum humidity	95% RH at 40 °C for 5 days
Altitude – operating	9,144 m or 30,000 ft (using battery)
Altitude – Non-operating	15,240 m or 50,000 ft
Altitude – AC to DC adapter	3,000 m or 9,840 ft
<b>Ingress protection</b>	
	This product has been type tested to meet the requirements for ingress protection IP53 in accordance with IEC/EN 60529 (IP rating for instrument by itself, with no cover).
<b>Temperature range</b>	
Operating, AC power, spec	–10 to 55 °C (14 to 131 °F) (–10 to 45 °C/14 to 113 °F in RTSA mode)
Operating, battery, spec	–10 to 50 °C (14 to 122 °F)
Operating, battery, typical	–10 to 55 °C (14 to 131 °F)
Storage, spec <sup>1</sup>	–51 to 71 °C (–60 to 160 °F)

1. The battery packs should be stored in an environment with low humidity. Extended exposure to temperature above 45 °C could degrade battery performance and life.

## General Information (continued)

**EMC:** Complies with the essential requirements of the European EMC Directive as well as current editions of the following standards (dates and editions are cited in the Declaration of Conformity):

IEC/EN 61326-1

CISPR Pub 11 Group 1, class B

AS/NZS CISPR 11

ICES/NMB-001

This ISM device complies with Canadian ICES-001.

Cet appareil ISM est conforme a la norme NMB-001 du Canada.

**SAFETY:** Complies with the essential requirements of the European Low Voltage Directive as well as current editions of the following standards (dates and editions are cited in the Declaration of Conformity):

IEC/EN 61010-1

Canada: CSA C22.2 No. 61010-1

USA: UL std no. 61010-1

To find a current Declaration of Conformity for a specific Keysight product, go to: <http://www.keysight.com/go/conformity>

### Explosive environment

This product has been type tested to meet the requirements for operation in explosive environments in accordance with MIL-STD-810G, Method 511.5, Procedure I.

### Power supply

External DC input 15 to 19 VDC, 40 watts maximum when battery charging

External AC power adapter Efficiency level IV

Input 100 to 250 VAC, 50 to 60 Hz, 1.25 to 0.56 A

Output 15 VDC, 4 A

Power consumption 14 watts typical, mode dependent

### Battery

Lithium ion 10.8 V, 4.6 A-h

Operating time 3.5 hours (typical), mode dependent

Charge time A fully discharged battery takes about 1.5 hours to recharge to 80%. Four hours to 100%.

Discharge temperature limits -10 to 60 °C, ≤ 85% RH

Charge temperature limits 0 to 45 °C, ≤ 85% RH

Storage temperature limits -20 to 50 °C, ≤ 85% RH

The battery packs should be stored in an environment with low humidity. Extended exposure to temperatures above 45 °C could degrade battery performance and life.

### Test port connectors

≤ 18 GHz models Type-N (f)

26.5 GHz models 3.5 mm (m) for FieldFox microwave analyzer, N9918A and FieldFox microwave VNA analyzer, N9928A. On FieldFox SA N9938A, you may choose 3.5 mm (m) or Type-N (f). Type-N (f) port connector is not available for the 26.5 GHz microwave analyzer, N9918A or 26.5 GHz microwave VNA analyzer, N9928A

≥ 32 GHz models NMD 2.4mm (m), torque .9 Nm or 8 in-lb, use torque wrench N9910X-886

### Display

6.5" transfective color LCD-LED backlit

### Headphone jack connector

3.5 mm (1/8 inch) miniature audio jack



## General Information (continued)

<b>USB-A, 2-ports</b>	
	Hi-speed USB 2.0
<b>Mini USB, 1 port<sup>1</sup></b>	
	Hi-speed USB 2.0; used for SCPI programming; USBTMC (USB IEEE488)
<b>Keyboard</b>	
	USB keyboards are supported (user must supply their own keyboard)
<b>LAN</b>	
Connector	RJ-45
	Used for programming, data saving, remote control, and connection to DataLink software
N991xA, N992xA, N993xA	100/10 base-T (auto switching)
N995xA, N996xA	1000/100/10 base-T (auto switching)
	SCPI over LAN using sockets and VX11 (LAN IEEE488); HTTP
<b>Programming</b>	
	SCPI, using the built-in LAN interface, BenchVue
<b>Languages</b>	
	English, Spanish, German, Italian, French, Russian, Japanese, Chinese, Turkish, Korean, and Portuguese
<b>Preset</b>	
	User preset for both mode preset and complete system preset
<b>Limit lines</b>	
The limit line capabilities listed in this section apply to the cable and antenna analyzer, network analyzer and spectrum analyzer modes in all FieldFox analyzers.	
Limit lines can be a combination of horizontal lines, sloping lines, or discrete data points	
Limit types: Fixed or relative	
Each trace can have its own limit line	
Limit lines can be built from a current trace	
Limit segments > 100, limited by memory size	
Max limit line number of points: 10,001	
Beep: Beep off, Beep on fail, Beep on pass	
Pass/fail warning: on/off	
Offset and margin: An increase or decrease in the limit line	
Save/recall limit lines	
<b>Data storage</b>	
Internal	Internal Minimum: 4 GB
	Minimum states and traces: 1000
External	Supports USB 2.0 compatible memory devices and SD/SDHC memory cards
Data types	Trace, trace+state, picture (png), data (csv), S1P, S2P
<b>Secure operation</b>	
Frequency blanking	For protection of sensitive data all frequency information can be turned off.
Erase user data	All user data can be erased on a FieldFox analyzer. For more information visit: <a href="http://www.keysight.com/find/securefieldfox">http://www.keysight.com/find/securefieldfox</a>

1. SCPI over USB for the N991x/2x/3x models is only available for serial number prefix starting with MY5607/SG5607/US5607 or upgraded with Option N9910HU-100/200/300/400.

## General Information (continued)

Reference out/trigger out	
Connector	SMB (m), 50 Ω
Output amplitude	≥ 0 dBm
Frequency	10 MHz (1 + frequency reference accuracy)
Trigger out	Reserved for future use; currently only used for ERTA 2-box handshaking
Reference in/trigger in	
Connector	SMA (f), 50 Ω
Reference input	10 MHz, -5 to +10 dBm
Trigger input	3.3 or 5 V TTL logic levels

## FieldFox Physical Dimensions

### FieldFoxe models with Type-N test port connectors

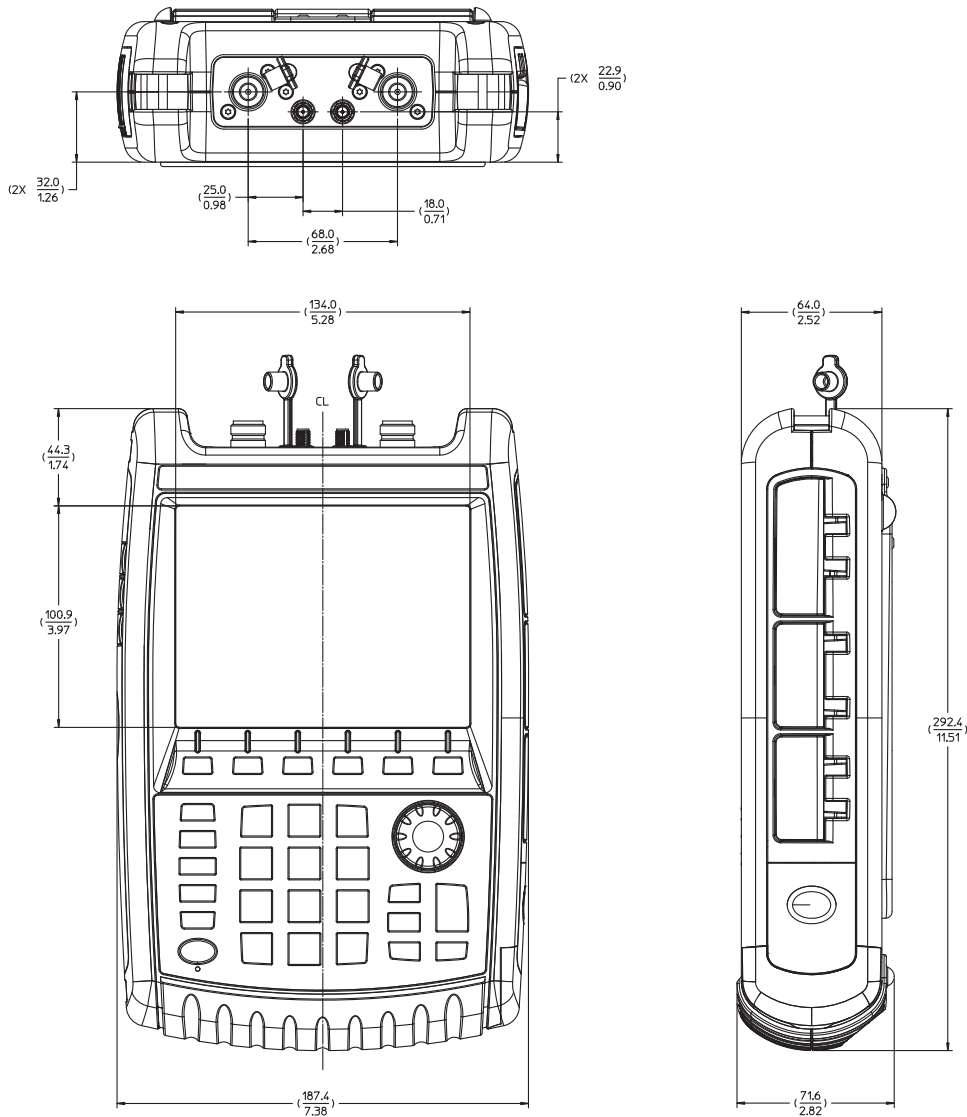

.stp files and rackmount kits are available upon request

## FieldFox Physical Dimensions (continued)

FieldFox models with 3.5 mm test port connectors

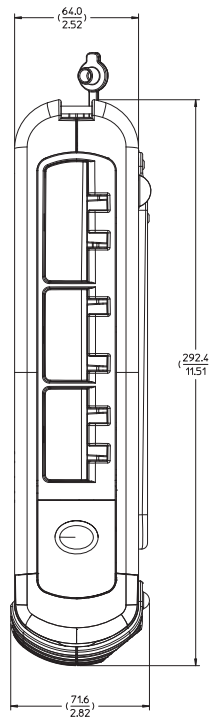
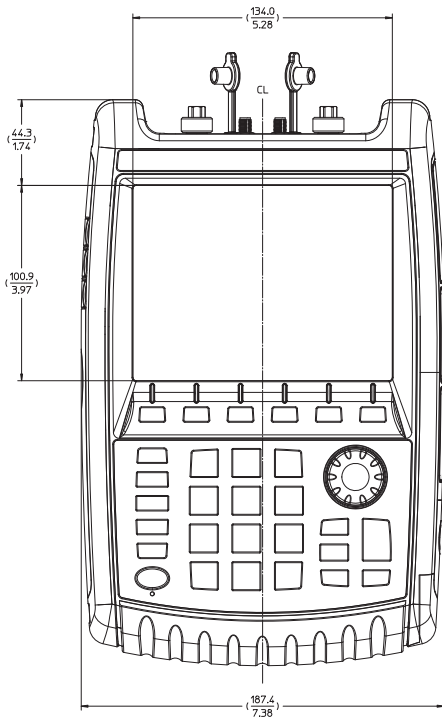
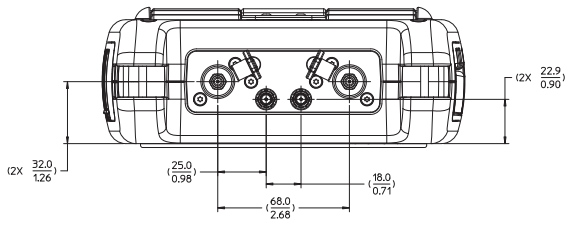

.stp files and rackmount kits are available upon request

## FieldFox Physical Dimensions (continued)

### FieldFox models with 2.4 mm test port connectors

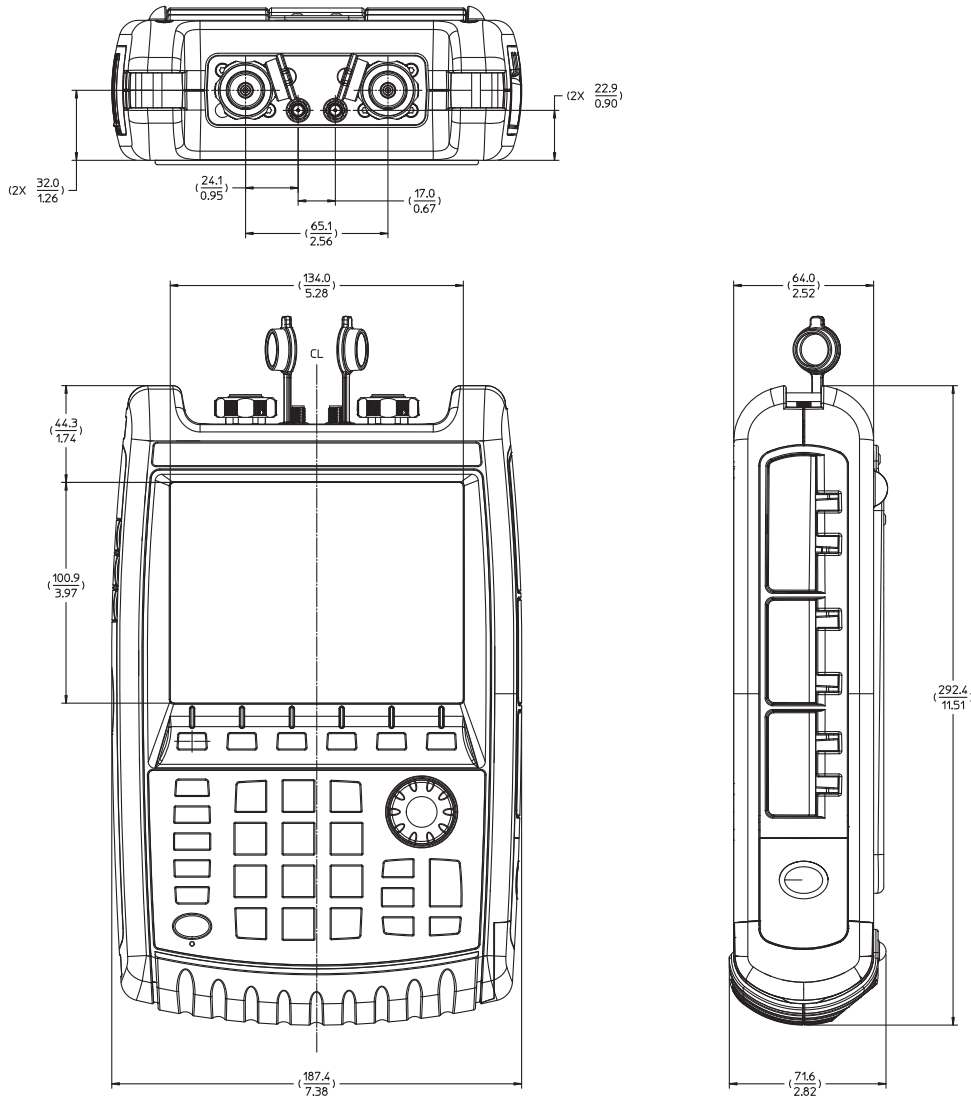

.stp files and rackmount kits are available upon request

## Carry Precision With You

Every piece of gear in your field kit had to prove its worth. Measuring up and earning a spot is the driving idea behind Keysight's FieldFox analyzers. They're equipped to handle routine maintenance, in-depth troubleshooting and anything in between. Better yet, FieldFox delivers precise microwave measurements—wherever you need to go. Add FieldFox to your kit and carry precision with you.

Related literature	Publication number
<i>FieldFox Handheld Analyzers</i> , Configuration Guide	5990-9836EN
<i>FieldFox Handheld Analyzers</i> , Technical Overview	5992-0772EN
<i>FieldFox N9923A RF Vector Network Analyzer</i> , Technical Overview	5990-5087EN
<i>FieldFox N9923A RF Vector Network Analyzer</i> , Data Sheet	5990-5363EN
<i>FieldFox N9912A RF Analyzer</i> , Technical Overview	5989-8618EN
<i>FieldFox N9912A RF Analyzer</i> , Data Sheet	N9912-90006

Download application notes, watch videos, and learn more: [www.keysight.com/find/fieldfox](http://www.keysight.com/find/fieldfox)

## Evolving

Our unique combination of hardware, software, support, and people can help you reach your next breakthrough. **We are unlocking the future of technology.**

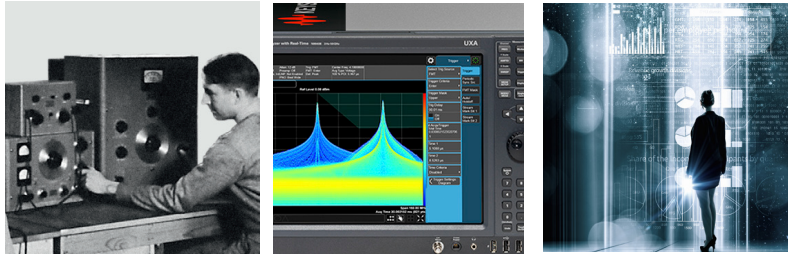

From Hewlett-Packard to Agilent to Keysight

For more information on Keysight Technologies' products, applications or services, please contact your local Keysight office. The complete list is available at: [www.keysight.com/find/contactus](http://www.keysight.com/find/contactus)

### Americas

Canada	(877) 894 4414
Brazil	55 11 3351 7010
Mexico	001 800 254 2440
United States	(800) 829 4444

### Asia Pacific

Australia	1 800 629 485
China	800 810 0189
Hong Kong	800 938 693
India	1 800 11 2626
Japan	0120 (421) 345
Korea	080 769 0800
Malaysia	1 800 888 848
Singapore	1 800 375 8100
Taiwan	0800 047 866
Other AP Countries	(65) 6375 8100

### Europe & Middle East

Austria	0800 001122
Belgium	0800 58580
Finland	0800 523252
France	0805 980333
Germany	0800 6270999
Ireland	1800 832700
Israel	1 809 343051
Italy	800 599100
Luxembourg	+32 800 58580
Netherlands	0800 0233200
Russia	8800 5009286
Spain	800 000154
Sweden	0200 882255
Switzerland	0800 805353
	Opt. 1 (DE)
	Opt. 2 (FR)
	Opt. 3 (IT)
United Kingdom	0800 0260637

For other unlisted countries:  
[www.keysight.com/find/contactus](http://www.keysight.com/find/contactus)  
 (BP-12-14-16)

**DEKRA Certified**  
ISO 9001 Quality Management System

[www.keysight.com/go/quality](http://www.keysight.com/go/quality)  
 Keysight Technologies, Inc.  
 DEKRA Certified ISO 9001:2015  
 Quality Management System

This information is subject to change without notice.  
 © Keysight Technologies, 2014 - 2017  
 Published in USA, June 1, 2017  
 5990-9783EN  
[www.keysight.com](http://www.keysight.com)

### myKeysight

**myKeysight**  
[www.keysight.com/find/mykeysight](http://www.keysight.com/find/mykeysight)  
 A personalized view into the information most relevant to you.

### KEYSIGHT SERVICES

Accelerate Technology Adoption.  
 Lower costs.

**Keysight Services**  
[www.keysight.com/find/service](http://www.keysight.com/find/service)  
 Our deep offering in design, test, and measurement services deploys an industry-leading array of people, processes, and tools. The result? We help you implement new technologies and engineer improved processes that lower costs.



**Three-Year Warranty**  
[www.keysight.com/find/ThreeYearWarranty](http://www.keysight.com/find/ThreeYearWarranty)  
 Keysight's committed to superior product quality and lower total cost of ownership. Keysight is the only test and measurement company with three-year warranty standard on all instruments, worldwide. And, we provide a one-year warranty on many accessories, calibration devices, systems and custom products.



**Keysight Assurance Plans**  
[www.keysight.com/find/AssurancePlans](http://www.keysight.com/find/AssurancePlans)  
 Up to ten years of protection and no budgetary surprises to ensure your instruments are operating to specification, so you can rely on accurate measurements.

**Keysight Channel Partners**  
[www.keysight.com/find/channelpartners](http://www.keysight.com/find/channelpartners)  
 Get the best of both worlds: Keysight's measurement expertise and product breadth, combined with channel partner convenience.

[www.keysight.com/find/fieldfox](http://www.keysight.com/find/fieldfox)