

Keysight Technologies

2-Port PNA-L Microwave Network Analyzer

N5230C

300 kHz to 6, 13.5 GHz

10 MHz to 20, 40, 50 GHz

Data Sheet

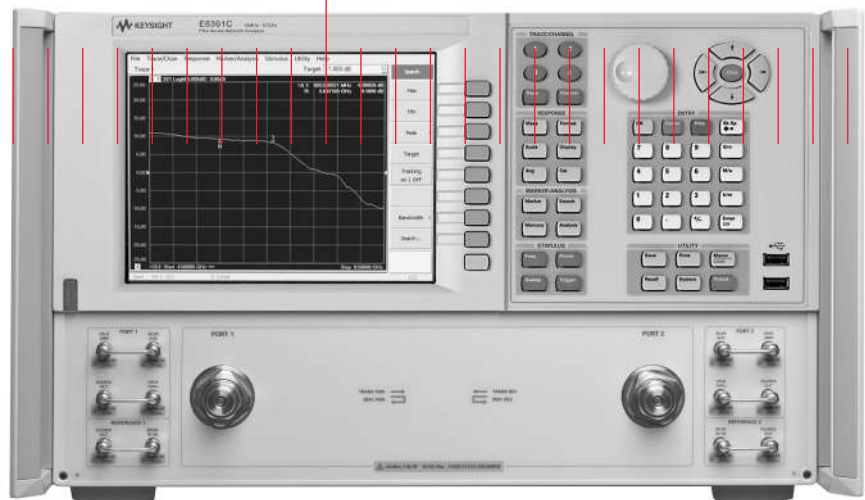

Specification information in this document is also available within the PNA-L network analyzer's internal Help system.

Table of Contents

Definitions	3
Corrected System Performance	4
Table 1. System dynamic range	4
Table 2. Extended dynamic range	5
N5230C Corrected system performance with 3.5 mm connectors	6
Table 3. 85052B Calibration kit N5230C – Configurable test set and extended power range (Option 025 or 125)	6
Table 4. 85052B Calibration kit N5230C – Configurable test set and extended power range (Option 225)	8
Table 5. N4691A Electronic calibration module N5230C – Configurable test set and extended power range (Option 225)	10
Table 6. 85056A Calibration kit N5230C – Configurable test set and extended power range (Option 425 or 525)	12
Table 7. N4693A Electronic calibration module N5230C – Configurable test set and extended power range (Option 425 or 525)	14
N5230C Corrected system performance with Type-N connectors	16
Table 8. N5232B Calibration kit N5230C – Configurable test set and extended power range (Option 025)	16
Table 9. Uncorrected system performance	18
Table 10. Test port output	19
Table 11. Test port input	21
Dynamic Accuracy	25
Table 12. Test port input (group delay)	25
General Information	26
Table 13. Miscellaneous information	26
Table 14. Front panel information	26
Table 15. Rear panel information	27
Table 16. Analyzer environment and dimensions	28
Measurement Throughput Summary	29
Table 17. Typical cycle time (ms) for measurement completion	29
Table 18. Cycle time vs IF bandwidth (Options 020, 025, 120, 125)	30
Table 19. Cycle time vs IF bandwidth (Options 220, 225, 420, 425)	31
Table 20. Cycle time vs number of points (Options 020, 025, 120, 125)	32
Table 21. Cycle time vs number of points (Options 220, 225, 420, 425, 520, 525)	33
Table 22. Data transfer time (ms)	34
Specifications: Front-Panel Jumpers	35
Table 23: Measurement receiver inputs (Rcvr A In, Rcvr B In)	35
Table 24: Reference receiver inputs (Rcvr R1, Rcvr R2)	36
Table 25: Reference outputs (Reference 1 Source out, Reference 2 Source Out)	36
Table 26: Source outputs (Port 1 source out, Port 2 Source Out)	37
Table 27: Coupler inputs (port 1 Cplr Thru, Port 2 Cplr Thru)	37
Table 28: Coupler outputs (port 1 Cplr Arm, Port 2 Cplr Arm)	37
Test Set Block Diagrams	38
N5230C Option 220, or 420, or 520 (standard test set and standard power range) network analyzer	38
N5230C Option 225, or 425, or 525 (configurable test set and extended power range) network analyzer	38
Web Resources	39

This is a subset of technical specifications for the Keysight Technologies, Inc. N5230C network analyzer.

To view or print the N5230C technical specifications, visit our web site at www.keysight.com/find/pnal

This N5230C document provides technical specifications for the following calibration kits and ECal modules only: 85052B, 85056A, 85032B, N4691A, and N4693A. Please download our free Uncertainty Calculator from www.keysight.com/find/na_calculator to generate the curves for your calibration kit and PNA setup.

Definitions

All specifications and characteristics apply over a 25 °C \pm 5 °C range (unless otherwise stated) and 90 minutes after the instrument has been turned on.

Specification (spec.): Warranted performance. Specifications include guardbands to account for the expected statistical performance distribution, measurement uncertainties, and changes in performance due to environmental conditions.

Characteristic (char.): A performance parameter that the product is expected to meet before it leaves the factory, but that is not verified in the field and is not covered by the product warranty. A characteristic includes the same guardbands as a specification.

Typical (typ.): Expected performance of an average unit which does not include guardbands. It is not covered by the product warranty.

Nominal (nom.): A general, descriptive term that does not imply a level of performance. It is not covered by the product warranty.

Calibration: The process of measuring known standards to characterize a network analyzer's systematic (repeatable) errors.

Corrected (residual): Indicates performance after error correction (calibration). It is determined by the quality of calibration standards and how well "known" they are, plus system repeatability, stability, and noise.

Uncorrected (raw): Indicates instrument performance without error correction. The uncorrected performance affects the stability of a calibration.

Standard: When referring to the analyzer, this includes no options unless noted otherwise.

Corrected System Performance

The specifications in this section apply for measurements made with the N5230C analyzer with the following conditions:

- 10 Hz IF bandwidth
- No averaging applied to data
- Isolation calibration with an averaging factor of 8

Table 1. System dynamic range¹

Standard configuration and standard power range

Description	Specification (dB) at test port				Typical (dB) at test port				
	Option 020, 120	Option 220	Option 420	Option 520	Option 020, 120	Option 220	Option 420	Option 520	
300 kHz to 3 MHz ³	934								
3 to 10 MHz	113								
10 to 45 MHz	122						103	89	89
5 to 70 MHz ²	122	101	90	90					
70 to 500 MHz ²	122	105	90	90					
500 MHz to 2 GHz	122	110	110	110					
2 to 6 GHz	122	110	110	110					
6 to 8 GHz	120	110	110	110					
8 to 9 GHz	120	110	100	100					
9 to 10.5 GHz	116	110	100	100					
10.5 to 12.5 GHz	111	110	100	100					
12.5 to 13.5 GHz	109	108	100	100					
13.5 to 20 GHz		108	100	100					
20 to 31.25 GHz				95	95				
31.25 to 40 GHz				90	90				
40 to 50 GHz				79					

Configurable test set and extended power range

Description	Specification (dB) at test port				Typical (dB) at test port				
	Option 025, 125	Option 225	Option 425	Option 525	Option 025, 125	Option 225	Option 425	Option 525	
300 kHz to 3 MHz ³	92 ⁴								
3 to 10 MHz	112								
10 to 45 MHz	121						103	88	88
45 to 70 MHz ²	121	101	90	90					
70 to 500 MHz ²	121	105	90	90					
500 MHz to 2 GHz	121	110	110	110					
2 to 6 GHz	121	110	110	110					
6 to 8 GHz	120	110	110	110					
8 to 9 GHz	120	110	100	100					
9 to 10.5 GHz	116	110	100	100					
10.5 to 12.5 GHz	111	110	100	100					
12.5 to 13.5 GHz	108	108	100	100					
13.5 to 20 GHz		108	100	100					
20 to 31.25 GHz				92	92				
31.25 to 40 GHz				87	87				
40 to 50 GHz				75					

1. The system dynamic range is calculated as the difference between the noise floor and the specified source maximum output power. The effective dynamic range must take measurement uncertainties and interfering signals into account.

2. May be degraded typically by 10 dB at particular frequencies (multiples of 5 MHz) below 500 MHz due to spurious receiver residuals. Methods are available to regain the full dynamic range.

3. May be limited by crosstalk at certain frequencies below 3 MHz.

4. Value and frequency band changed July 2006.

Table 2. Extended dynamic range¹

Configurable test set and extended power range

Description	Specification (dB) at direct receiver access input				Typical (dB) at direct receiver access input			
	Option 025, 125	Option 225	Option 425	Option 525	Option 025, 125	Option 225	Option 425	Option 525
300 kHz to 3 MHz ³	108 ⁴							
3 to 10 MHz	128							
10 to 45 MHz	137				115	109	109	
45 to 70 MHz ²	137	113	111	111				
70 to 500 MHz ²	137	117	111	111				
500 MHz to 2 GHz	137	122	122	122				
2 to 6 GHz	137	122	122	122				
6 to 8 GHz	136	122	122	122				
8 to 9 GHz	136	122	122	122				
9 to 10.5 GHz	132	122	112	112				
10.5 to 12.5 GHz	127	122	112	112				
12.5 to 13.5 GHz	124	120	112	112				
13.5 to 20 GHz		120	112	112				
20 to 31.25 GHz			103	103				
31.25 to 40 GHz			98	98				
40 to 50 GHz				83				

1. The direct receiver access input extended dynamic range is calculated as the difference between the direct receiver access input noise floor and the source maximum output power. The effective dynamic range must take measurement uncertainties and interfering signals into account. This set-up should only be used when the receiver input will never exceed its compression or damage level. When the analyzer is in segment sweep mode, it can have predefined frequency segments which will output a higher power level when the extended dynamic range is required (i.e. devices with high insertion loss), and reduced power when receiver compression or damage may occur (i.e. devices with low insertion loss). The extended range is only available in one-path transmission measurements.
2. May be degraded typically by 10 dB at particular frequencies (multiples of 5 MHz) below 500 MHz due to spurious receiver residuals. Methods are available to regain the full dynamic range.
3. May be limited by crosstalk at certain frequencies below 3 MHz.
4. Value and frequency band changed July 2006.

N5230C Corrected system performance with 3.5 mm connectors

Table 3. 85052B Calibration kit

N5230C – configurable test set and extended power range (Option 025, 125)

Configurable test set, extended power range

Applies to the N5230C Option 025 and 125 analyzers, 85052B (3.5 mm) calibration kit, 85131F flexible test port cable set, and a full 2-port calibration. Also applies to the following condition: Environmental temperature $23^{\circ} \pm 3^{\circ} \text{C}$, with $< 1^{\circ} \text{C}$ deviation from calibration temperature.

Description	Specification (dB)			
	300 kHz to 10 MHz	10 MHz to 2 GHz	2 to 8 GHz	8 to 13.5 GHz
Directivity	48	48	44	44
Source match	40	40	33	31
Load match	48	48	44	44
Reflection tracking	± 0.003 (+0.02/ $^{\circ}\text{C}$)	± 0.003 (+0.02/ $^{\circ}\text{C}$)	± 0.003 (+0.03/ $^{\circ}\text{C}$)	± 0.006 (+0.03/ $^{\circ}\text{C}$)
Transmission tracking	± 0.017 (+0.02/ $^{\circ}\text{C}$)	± 0.015 (+0.02/ $^{\circ}\text{C}$)	± 0.075 (+0.03/ $^{\circ}\text{C}$)	± 0.131 (+0.03/ $^{\circ}\text{C}$)

Transmission uncertainty (specifications)

Magnitude

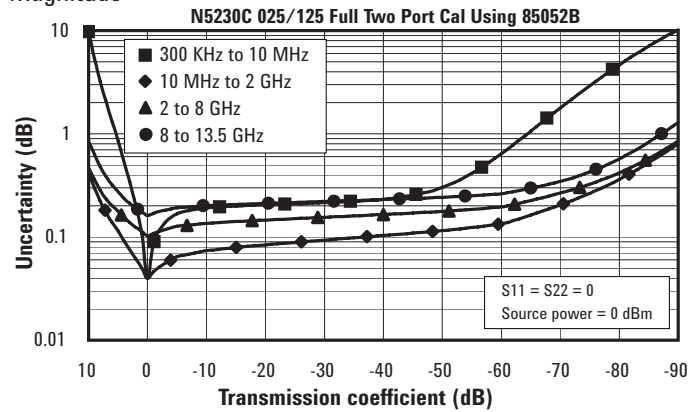

Phase

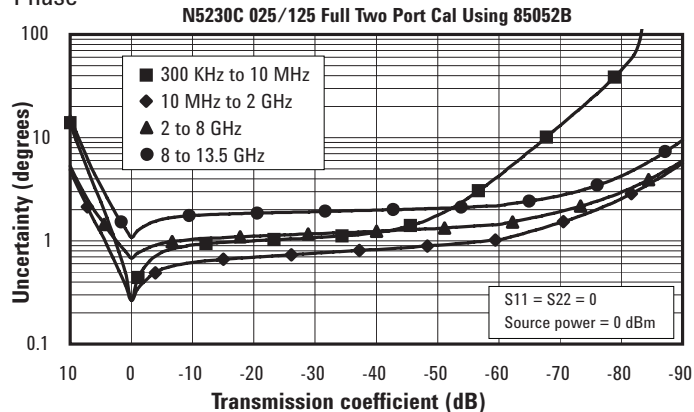

Reflection uncertainty (specifications)

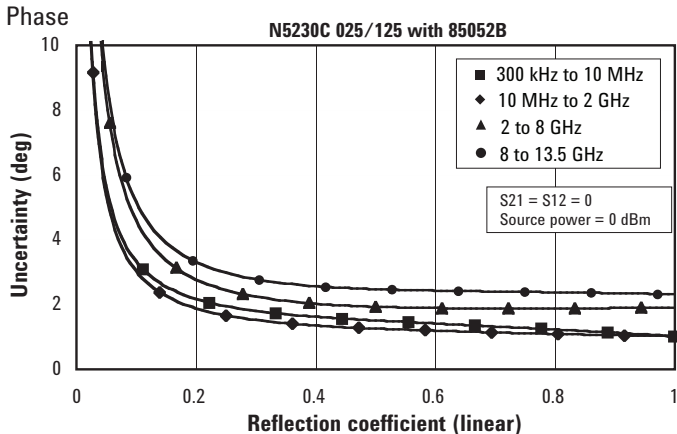
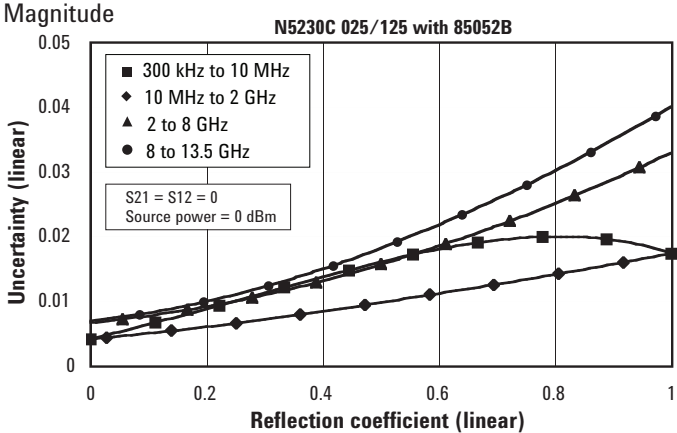

N5230C Corrected system performance with 3.5 mm connectors

Table 4. 85052B Calibration kit

N5230C – configurable test set and extended power range (Option 225)

Configurable test set, extended power range

Applies to the N5230C Option 225 analyzers, 85052B (3.5 mm) calibration kit, 85131F flexible test port cable set, and a full 2-port calibration. Also applies to the following condition:
Environmental temperature $23^{\circ} \pm 3^{\circ} \text{C}$, with $< 1^{\circ} \text{C}$ deviation from calibration temperature.

Description	Specification (dB)			
	45 to 500 MHz	500 MHz to 2 GHz	2 to 8 GHz	8 to 20 GHz
Directivity	48	48	44	44
Source match	40	40	33	31
Load match	48	48	44	44
Reflection tracking	± 0.003 (+0.02/ $^{\circ}\text{C}$)	± 0.003 (+0.02/ $^{\circ}\text{C}$)	± 0.003 (+0.03/ $^{\circ}\text{C}$)	± 0.006 (+0.03/ $^{\circ}\text{C}$)
Transmission tracking	± 0.010 (+0.02/ $^{\circ}\text{C}$)	± 0.014 (+0.02/ $^{\circ}\text{C}$)	± 0.062 (+0.03/ $^{\circ}\text{C}$)	± 0.104 (+0.03/ $^{\circ}\text{C}$)

Transmission uncertainty (specifications)

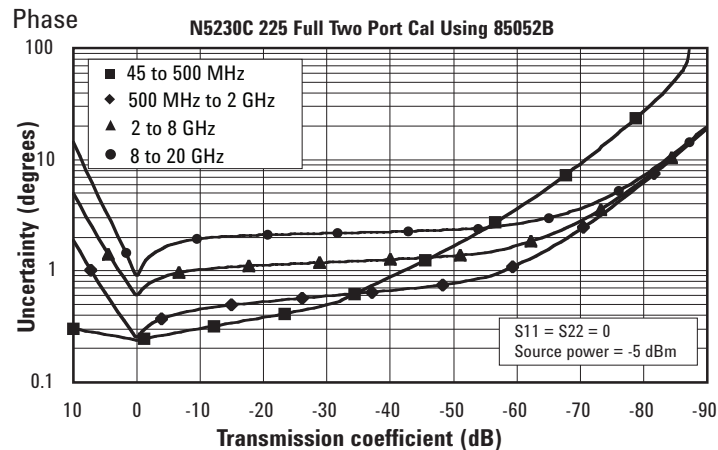
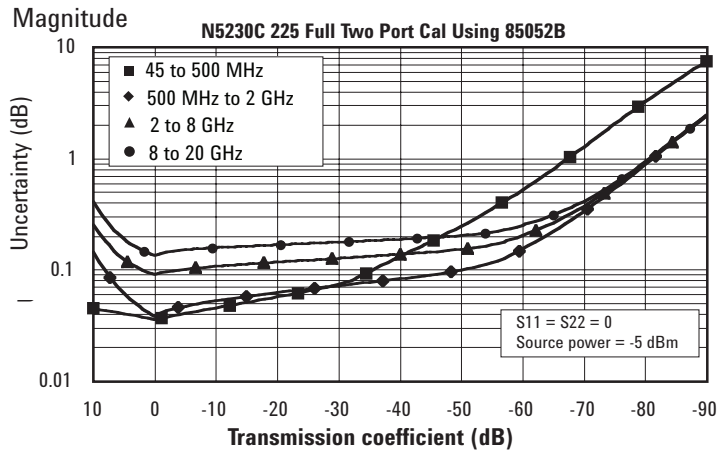

N4691A Electronic calibration module
N5230C – configurable test set and extended power range (Option 225)

Reflection uncertainty (specifications)

Magnitude

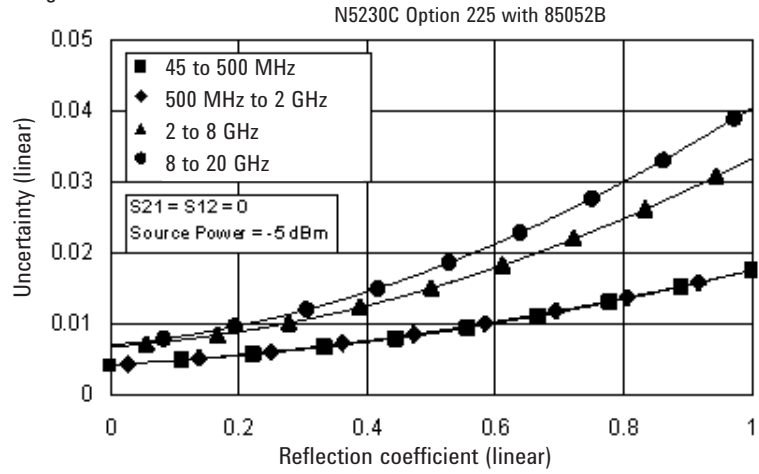

Phase

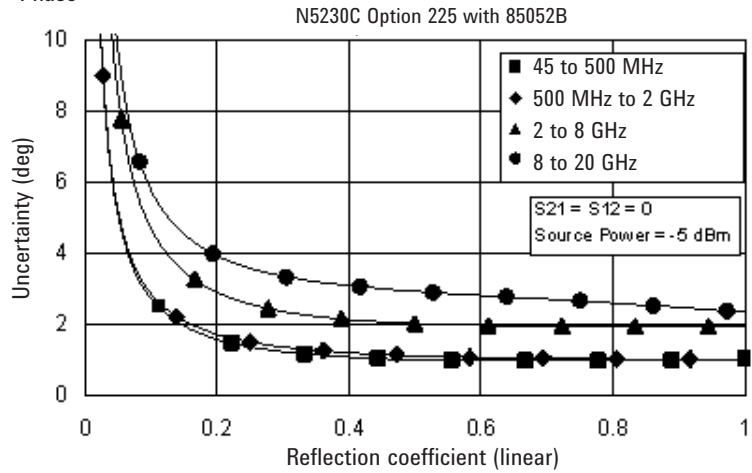

N5230C Corrected system performance with 3.5 mm connectors

Table 5. N4691B Electronic calibration module
N5230C – configurable test set and extended power range (Option 225)

Configurable test set, extended power range

Applies to the N5230C Option 225 analyzers, N4691B electronic calibration module, 85131F flexible test port cable set, and a full 2-port calibration. Also applies to the following condition: Environmental temperature $23^\circ \pm 3^\circ \text{C}$, with $< 1^\circ \text{C}$ deviation from calibration temperature.

Description	Specification (dB)			
	45 to 500 MHz	500 MHz to 2 GHz	2 to 8 GHz	8 to 20 GHz
Directivity	46	56	54	48
Source match	41	47	45	44
Load match	41	47	44	42
Reflection tracking	± 0.050 (+0.02/°C)	± 0.020 (+0.02/°C)	± 0.030 (+0.03/°C)	± 0.040 (+0.03/°C)
Transmission tracking	± 0.053 (+0.02/°C)	± 0.021 (+0.02/°C)	± 0.034 (+0.03/°C)	± 0.052 (+0.03/°C)

Transmission uncertainty (specifications)

Magnitude

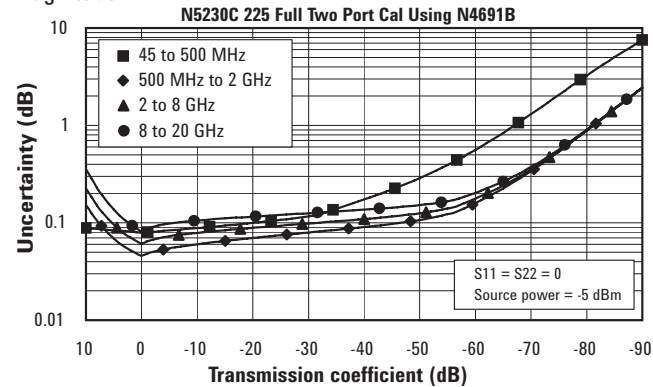

Phase

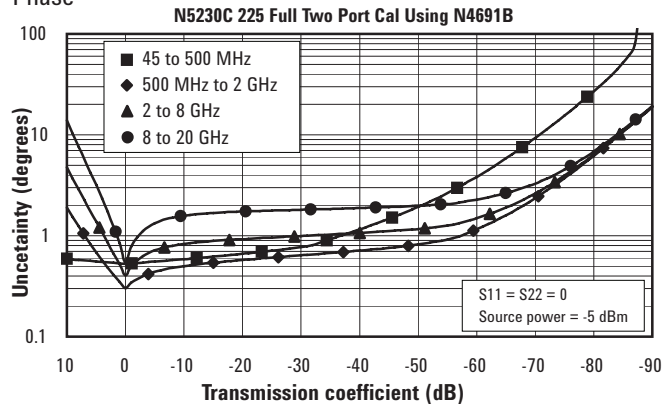

N4691A Electronic calibration module
N5230C – configurable test set and extended power range (Option 225)
Reflection uncertainty (specifications)

Magnitude

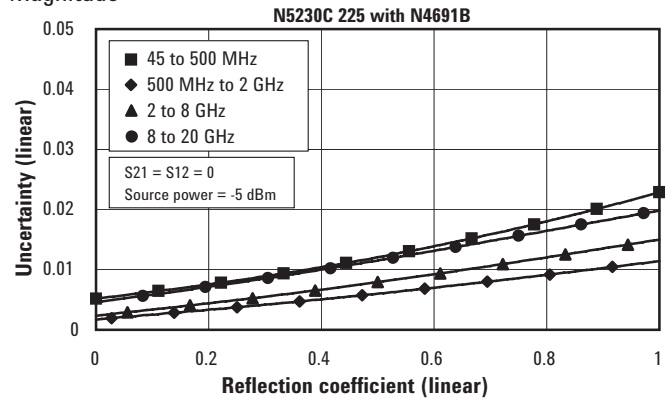

Phase

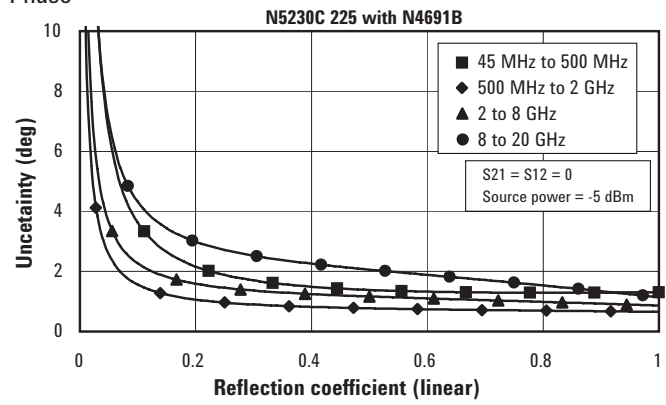

N5230C Corrected system performance with 2.4 mm connectors

Table 6. 85056A Calibration kit

N5230C – configurable test set and extended power range (Option 425 or 525)

Configurable test set, extended power range

Applies to the N5230C Option 425 or 525 analyzers, 85056A (2.4 mm) electronic calibration module, 85133F flexible test port cable set, and a full 2-port calibration. Also applies to the following condition: Environmental temperature $23^{\circ} \pm 3^{\circ} \text{C}$, with $< 1^{\circ} \text{C}$ deviation from calibration temperature.

Description	Specification (dB)			
	45 MHz to 2 GHz	2 to 20 GHz	20 to 40 GHz	40 to 50 GHz
Directivity	42	42	38	36
Source match	41	38	33	31
Load match	42	42	37	35
Reflection tracking	± 0.001 (+0.02/ $^{\circ}\text{C}$)	± 0.008 (+0.02/ $^{\circ}\text{C}$)	± 0.020 (+0.02/ $^{\circ}\text{C}$)	± 0.027 (+0.03/ $^{\circ}\text{C}$)
Transmission tracking	± 0.019 (+0.02/ $^{\circ}\text{C}$)	± 0.057 (+0.02/ $^{\circ}\text{C}$)	± 0.124 (+0.02/ $^{\circ}\text{C}$)	± 0.211 (+0.03/ $^{\circ}\text{C}$)

Transmission uncertainty (specifications)

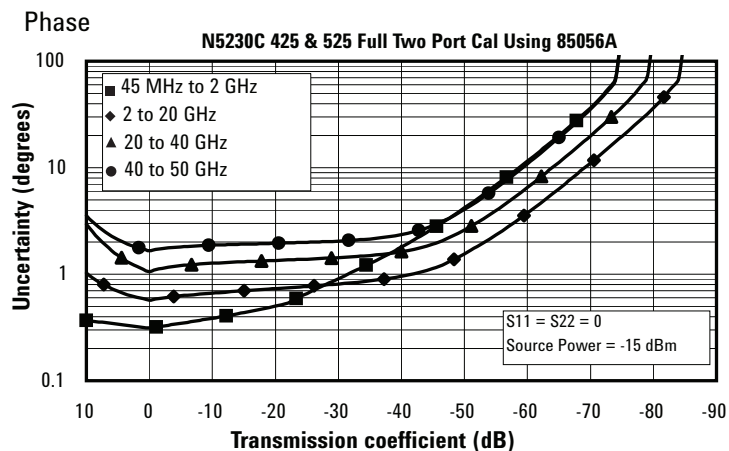
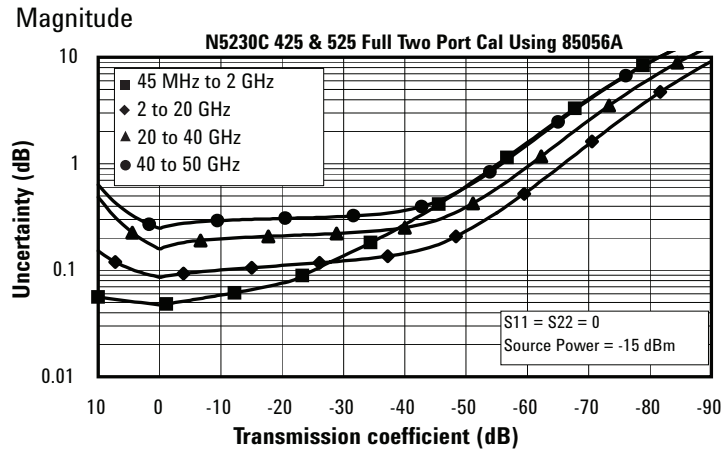

Reflection uncertainty (specifications)

Magnitude

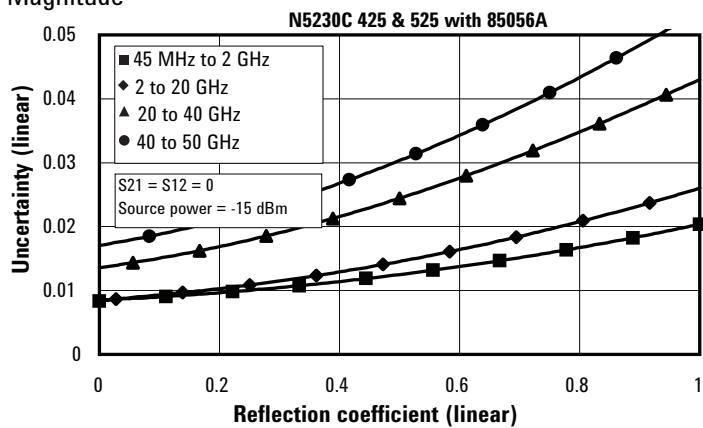

Phase

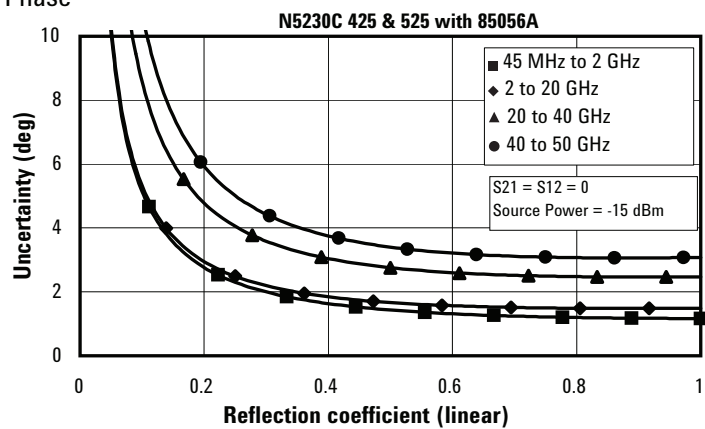

Table 7. N4693A Electronic calibration module
 N5230C – configurable test set and extended power range (Option 425 or 525)

Configurable test set, extended power range

Applies to the N5230C Option 425 or 525 analyzers, N4693A (2.4 mm) electronic calibration module, 85133F flexible test port cable set, and a full 2-port calibration. Also applies to the following condition: Environmental temperature $23^{\circ} \pm 3^{\circ} \text{C}$, with $< 1^{\circ} \text{C}$ deviation from calibration temperature.

Description	Typical (dB)		Specification (dB)		
	10 to 200 MHz	200 MHz to 2 GHz	2 to 20 GHz	20 to 40 GHz	40 to 50 GHz
Directivity	32	55	49	43	41
Source match	25	46	42	35	30
Load match	24	43	41	37	36
Reflection tracking	± 0.05 (+0.02/°C)	± 0.030 (+0.02/°C)	± 0.040 (+0.02/°C)	± 0.060 (+0.02/°C)	± 0.080 (+0.03/°C)
Transmission tracking	± 0.10 (+0.02/°C)	± 0.056 (+0.02/°C)	± 0.078 (+0.02/°C)	± 0.107 (+0.02/°C)	± 0.130 (+0.03/°C)

Transmission uncertainty (specifications)

Magnitude

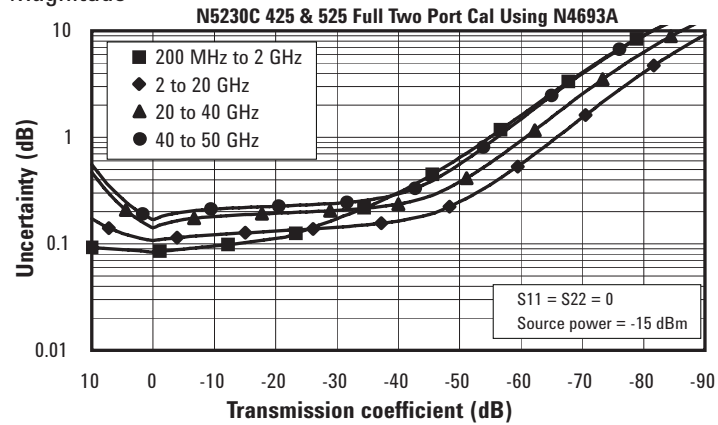

Phase

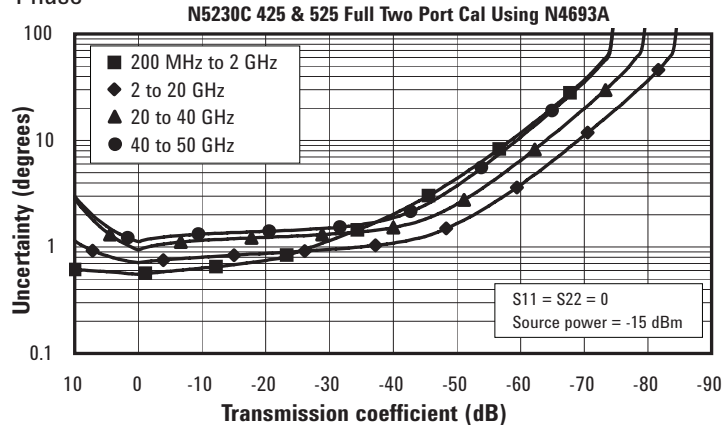

Reflection uncertainty (specifications)

Magnitude

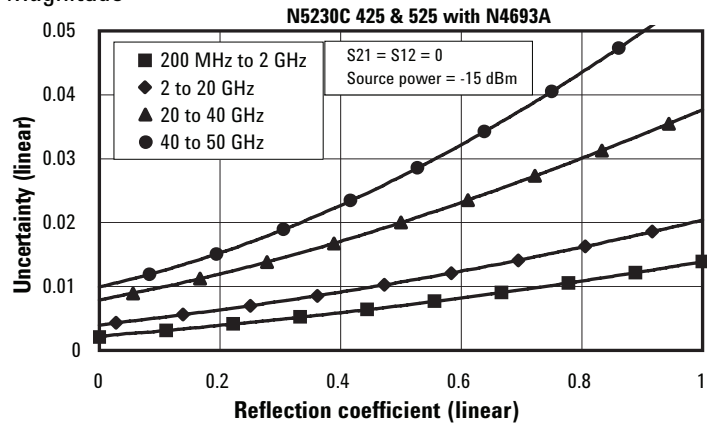

Phase

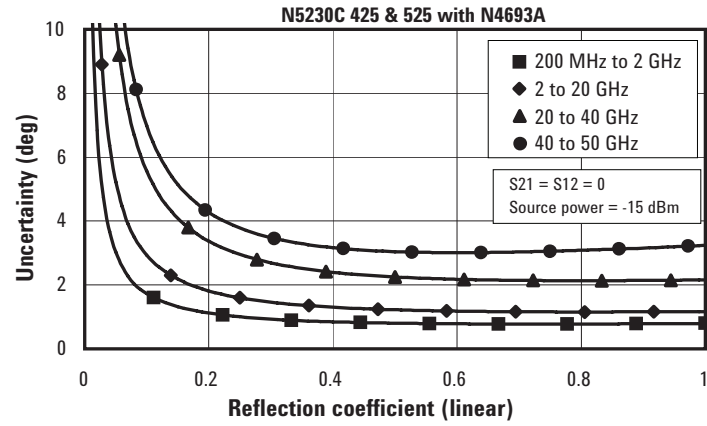

N5230C Corrected system performance with Type-N connectors

Table 8. 85032B Calibration kit

N5230C – configurable test set and extended power range (Option 025)

Configurable test set, extended power range

Applies to the N5230C Option 025 analyzers, 85032B (Type-N) calibration kit, 85132F flexible test port cable set with 85130C adapter set, and a full 2-port calibration. Also applies to the following condition: Environmental temperature $23^{\circ} \pm 3^{\circ}\text{C}$, with $< 1^{\circ}\text{C}$ deviation from calibration temperature.

Description	Specification (dB)			
	300 kHz to 1 MHz	1 to 10 MHz	10 to 45 MHz	45 MHz to 6 GHz
Directivity	50	50	47	40
Source match	42	42	37	31
Load match	50	50	47	38
Reflection tracking	± 0.009 (+0.01/ $^{\circ}\text{C}$)	± 0.009 (+0.01/ $^{\circ}\text{C}$)	± 0.019 (+0.01/ $^{\circ}\text{C}$)	± 0.069 (+0.02/ $^{\circ}\text{C}$)
Transmission tracking	± 0.013 (+0.01/ $^{\circ}\text{C}$)	± 0.007 (+0.01/ $^{\circ}\text{C}$)	± 0.021 (+0.01/ $^{\circ}\text{C}$)	± 0.101 (+0.02/ $^{\circ}\text{C}$)

Transmission uncertainty (specifications)

Magnitude

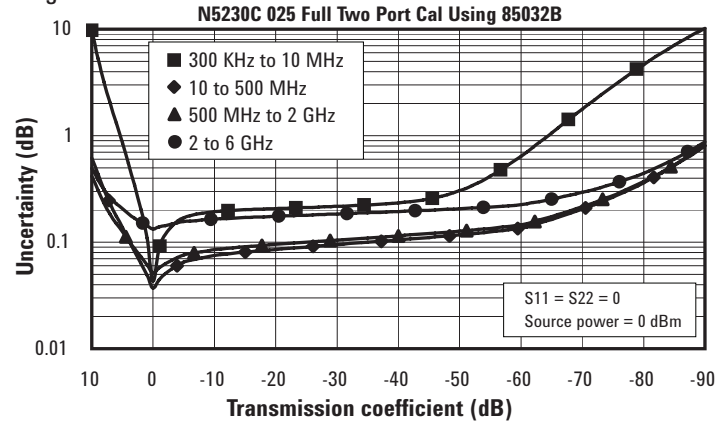

Phase

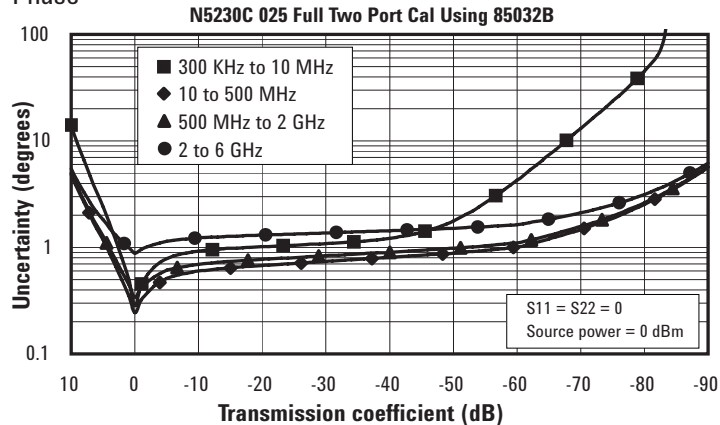

Transmission uncertainty (specifications)

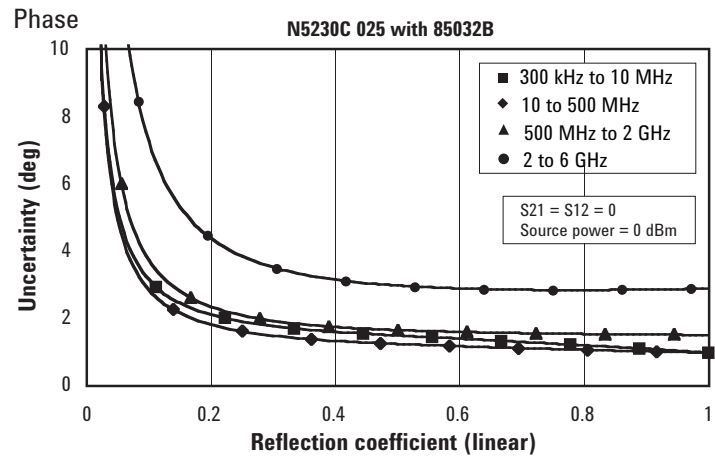
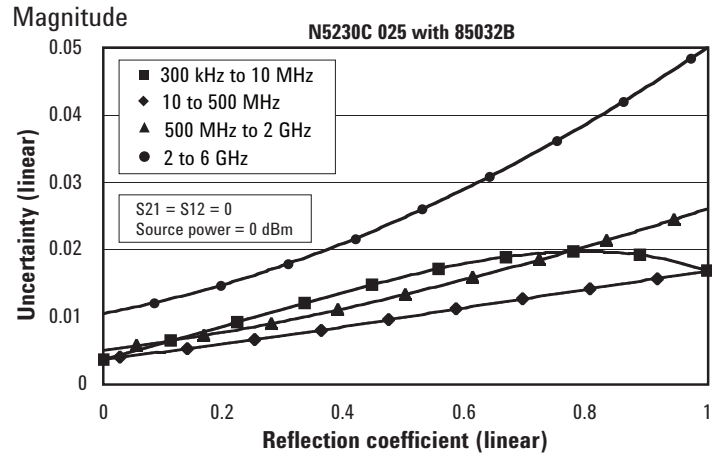

Table 9. Uncorrected system performance

Directivity	Specifications				Typicals			
	Option 020, 025, 120, 125	Option 220, 225	Option 420, 425	Option 520, 525	Option 020, 025, 120, 125	Option 220, 225	Option 420, 425	Option 520, 525
300 kHz to 10 MHz	16 dB							
10 to 45 MHz	28 dB					23 dB	20 dB	20 dB
45 to 500 MHz	28 dB	24 dB	23 dB	23 dB				
500 MHz to 1 GHz	28 dB	27 dB	23 dB	23 dB				
1 to 2 GHz	25 dB	27 dB	23 dB	23 dB				
2 to 3 GHz	25 dB	21 dB	21 dB	21 dB				
3 to 5 GHz	20 dB	21 dB	21 dB	21 dB				
5 to 8 GHz	17 dB	21 dB	21 dB	21 dB				
8 to 11.5 GHz	17 dB	16 dB	16 dB	16 dB				
11.5 to 13.5 GHz	15 dB	16 dB	16 dB	16 dB				
13.5 to 20 GHz		16 dB	16 dB	16 dB				
20 to 40 GHz			15 dB	15 dB				
40 to 50 GHz				13 dB				
Source match	Option 020, 025, 120, 125	Option 220, 225	Option 420, 425	Option 520, 525	Option 020, 025, 120, 125	Option 220, 225	Option 420, 425	Option 520, 525
300 kHz to 10 MHz	18 dB							
10 to 45 MHz	25 dB					12 dB	11 dB	11 dB
45 to 500 MHz	25 dB	20 dB	17 dB	17 dB				
500 MHz to 2 GHz	21 dB	17 dB	17 dB	17 dB				
2 to 3 GHz	19 dB	12 dB	12 dB	12 dB				
3 to 8 GHz	12 dB	12 dB	12 dB	12 dB				
8 to 9 GHz	12 dB	11 dB	11 dB	11 dB				
9 to 12.5 GHz	10 dB	11 dB	11 dB	11 dB				
12.5 to 13.5 GHz	8 dB	10 dB	11 dB	11 dB				
13.5 to 20 GHz		10 dB	11 dB	11 dB				
20 to 40 GHz			7 dB	7 dB				
40 to 50 GHz				6 dB				
Load match	Option 020, 025, 120, 125	Option 220, 225	Option 420, 520	Option 425, 525	Option 020, 025, 120, 125	Option 220, 225	Option 420, 425	Option 520, 525
300 kHz to 10 MHz	17 dB							
10 to 45 MHz	22 dB					15 dB	13 dB	13 dB
45 to 500 MHz	22 dB	22 dB	18 dB	18 dB				
500 MHz to 2 GHz	17 dB	20 dB	18 dB	18 dB				
2 to 3 GHz	14 dB	12 dB	14 dB	14 dB				
3 to 8 GHz	10 dB	12 dB	14 dB	14 dB				
8 to 9 GHz	9 dB	10 dB	12 dB	12 dB				
9 to 12.5 GHz	9 dB	10 dB	12 dB	12 dB				
12.5 to 13.5 GHz	7 dB	9 dB	9 dB	9.5 dB				
13.5 to 20 GHz		9 dB	9 dB	9.5 dB				
20 to 40 GHz			8 dB	8.5 dB				
40 to 50 GHz				5 dB				
Crosstalk ¹					Option 020, 025, 120, 125	Option 220, 225	Option 420, 425	Option 520, 525
300 kHz to 10 MHz					75 dB ²			
10 to 45 MHz					115 dB	88 dB	88 dB	88 dB
45 to 500 MHz					122 dB	95 dB	94 dB	94 dB
500 MHz to 2 GHz					122 dB	96 dB	95 dB	95 dB
2 to 8 GHz					122 dB	110 dB	108 dB	108 dB
8 to 10.5 GHz					120 dB	116 dB	113 dB	113 dB
10.5 to 12.5 GHz					115 dB	116 dB	113 dB	113 dB
12.5 to 13.5 GHz					109 dB	115 dB	112 dB	112 dB
13.5 to 20 GHz						115 dB	112 dB	112 dB
20 to 40 GHz							97 dB	97 dB
40 to 50 GHz								89 dB

1. Measurement conditions: normalized to a thru, measured with two shorts, 10 Hz IF bandwidth, averaging factor of 8, alternate mode, source power set to the specified maximum power output or the minimum receiver input power specified by the 0.1 dB compression power

2. Value changed July 2006.

Table 10. Test port output¹

Description	Specifications					Typicals			
	Option 020, 025	Option 120, 125	Option 220, 225	Option 420, 425	Option 520, 525	Option 020, 025, 120, 125	Option 220, 225	Option 420, 425	Option 520, 525
Frequency range									
N5230C	300 kHz to 6 GHz	300 kHz to 13.5 GHz	10 MHz to 20 GHz	10 MHz to 40 GHz	10 MHz to 50 GHz				
Nominal power									
Preset power; attenuator switch point 10 dB below nominal power									
	0 dBm	0 dBm	-5 dBm	-10 dBm	-15 dBm				
Frequency resolution									
	1 Hz								
CW accuracy									
	±1 ppm								
Frequency stability									
						±0.05 ppm. -10° to 70° C ±0.1 ppm/yr maximum			

Description	Specifications					Typicals			
	Option 020, 025, 120, 125	Option 220, 225	Option 420, 425	Option 520	Option 525	Option 020, 025, 120, 125	Option 220, 225	Option 420, 425, 520, 525	
Power level accuracy									
Variation from nominal power in range 0									
300 kHz to 10 MHz	±1.0 dB								
10 to 45 MHz	±1.0 dB						±0.5 dB	±0.5 dB	
45 MHz to 6 GHz	±1.0 dB	±1.0 dB	±1.0 dB	±1.0 dB	±1.0 dB				
6 to 8 GHz	±1.5 dB	±1.0 dB	±1.0 dB	±1.0 dB	±1.0 dB				
8 to 9 GHz	±1.5 dB	±1.0 dB	±1.5 dB	±1.5 dB	±1.5 dB				
9 to 10.5 GHz	±1.5 dB	±1.0 dB	±1.5 dB	±1.5 dB	±1.5 dB				
10.5 to 13.5 GHz	±2.0 dB	±1.0 dB	±1.5 dB	±1.5 dB	±1.5 dB				
13.5 to 20 GHz		±1.0 dB	±1.5 dB	±1.5 dB	±1.5 dB				
20 to 40 GHz			±2.5 dB	±2.5 dB	±2.5 dB				
40 to 50 GHz				±3.5 dB	±3.5 dB				

Description	Specifications							Typicals
	Option 020, 120	Option 025, 125	Option 220, 225	Option 420	Option 425	Option 520	Option 525	Option 220, 225
Max leveled power								
300 kHz to 10 MHz	10 dBm	9 dBm						
10 to 45 MHz	10 dBm	9 dBm						5 dBm
45 MHz to 6 GHz	10 dBm	9 dBm	5 dBm	0 dBm	0 dBm	0 dBm	0 dBm	
6 to 9 GHz	8 dBm	8 dBm	5 dBm	0 dBm	0 dBm	0 dBm	0 dBm	
9 to 12.5 GHz	4 dBm	4 dBm	5 dBm	0 dBm	0 dBm	0 dBm	0 dBm	
12.5 to 13.5 GHz	2 dBm	1 dBm	3 dBm	0 dBm	0 dBm	0 dBm	0 dBm	
13.5 to 20 GHz			3 dBm	0 dBm	0 dBm	0 dBm	0 dBm	
20 to 40 GHz				-5 dBm	-8 dBm	-5 dBm	-8 dBm	
40 to 50 GHz						-11 dBm	-15 dBm	
Power level linearity ² Test reference is at the nominal power level								Options as indicated
300 kHz to 1 MHz	±4.5 dB	±4.5 dB						±2.0 dB (Opt 020, 025, 120, 125)
1 to 10 MHz	±1.0 dB	±1.0 dB						
10 to 45 MHz	±2.0 dB	±2.0 dB						±0.35 dB (Opt 220, 225) ±0.40 dB (Opt 420, 425, 520, 525)
45 MHz to 1 GHz	±2.0 dB	±2.0 dB	±1.0 dB	±1.0 dB	±1.0 dB	±1.0 dB	±1.0 dB	
1 to 12.5 GHz	±1.5 dB	±1.5 dB	±1.0 dB	±1.0 dB	±1.0 dB	±1.0 dB	±1.0 dB	
12.5 to 13.5 GHz	±1.5 dB	±1.5 dB	±1.0 dB	±1.0 dB	±1.0 dB	±1.0 dB	±1.0 dB	
13.5 to 20 GHz			±1.0 dB	±1.0 dB	±1.0 dB	±1.0 dB	±1.0 dB	
20 to 40 GHz				±1.0 dB	±1.0 dB	±1.0 dB	±1.0 dB	
40 to 50 GHz						±1.0 dB	±1.0 dB	

1. Performance specified on Port 1 only. Port 2 performance is a characteristic.

2. Power level linearity specified on Port 1 only. Port 2 performance is typical. Test reference is at the nominal power level.

Table 10. Test port output¹ (Continued)

Description	Specifications							Typicals
	Option 020, 120	Option 025, 125	Option 220, 225	Option 420	Option 425	Option 520	Option 525	Option 220, 225
Power sweep range (ALC)²								
300 kHz to 10 MHz	37 dB	36 dB						
10 to 45 MHz	37 dB	36 dB						25 dB
45 MHz to 6 GHz	37 dB	36 dB	25 dB	25 dB	25 dB	25 dB	25 dB	
6 to 9 GHz	35 dB	35 dB	25 dB	25 dB	25 dB	25 dB	25 dB	
9 to 12.5 GHz	31 dB	31 dB	25 dB	25 dB	25 dB	25 dB	25 dB	
12.5 to 13.5 GHz	29 dB	28 dB	23 dB	25 dB	25 dB	25 dB	25 dB	
13.5 to 20 GHz			23 dB	25 dB	25 dB	25 dB	25 dB	
20 to 40 GHz				20 dB	17 dB	20 dB	17 dB	
40 to 50 GHz						14 dB	10 dB	
Power resolution								Options as indicated
								0.01 dB (all options)
Description	Typicals							
	Option 020, 120	Option 025, 125	Option 220	Option 225	Option 420, 520	Option 425, 525		
Power range								
300 kHz to 10 MHz	-30 to +10 dBm	-90 to +9 dBm						
10 to 45 MHz	-30 to +10 dBm	-90 to +9 dBm	-27 to +12 dBm	-87 to +12 dBm	-27 to +9 dBm	-87 to +8 dBm		
45 MHz to 6 GHz	-30 to +10 dBm	-90 to +9 dBm	-27 to +12 dBm	-87 to +12 dBm	-27 to +8 dBm	-87 to +8 dBm		
6 to 9 GHz	-30 to +8 dBm	-90 to +8 dBm	-27 to +12 dBm	-87 to +12 dBm	-27 to +8 dBm	-87 to +8 dBm		
9 to 12.5 GHz	-30 to +4 dBm	-90 to +4 dBm	-27 to +12 dBm	-87 to +12 dBm	-27 to +8 dBm	-87 to +8 dBm		
12.5 to 13.5 GHz	-30 to +2 dBm	-90 to +1 dBm	-27 to +7 dBm	-87 to +7 dBm	-27 to +5 dBm	-87 to +4 dBm		
13.5 to 20 GHz			-27 to +7 dBm	-87 to +7 dBm	-27 to +5 dBm	-87 to +4 dBm		
20 to 40 GHz					-27 to +1 dBm	-87 to -2 dBm		
40 to 50 GHz					-27 to -5 dBm	-87 to -9 dBm		
Power settings								
Minimum power setting	-33 dBm	-93 dBm	-30 dBm	-90 dBm	-30 dBm	-90 dBm		
Maximum power setting	+20 dBm	+20 dBm	+20 dBm	+20 dBm	+20 dBm	+20 dBm		
Description	Typicals							
	Option 020, 025, 120, 125			Option 220, 225, 420, 425, 520, 525				
Phase noise (Nominal power at test port)								
	10 kHz Offset	100 kHz Offset	1 MHz Offset	10 kHz Offset	100 kHz Offset	1 MHz Offset		
300 kHz to 10 MHz	-86 dBc/Hz	-86 dBc/Hz	-95 dBc/Hz					
10 MHz to 1.5 GHz	-86 dBc/Hz	-91 dBc/Hz	-95 dBc/Hz	-77 dBc/Hz	-77 dBc/Hz	-89 dBc/Hz		
1.5 to 3.125 GHz	-83 dBc/Hz	-91 dBc/Hz	-95 dBc/Hz	-83 dBc/Hz	-91 dBc/Hz	-95 dBc/Hz		
3.125 to 6.25 GHz	-77 dBc/Hz	-85 dBc/Hz	-89 dBc/Hz	-77 dBc/Hz	-85 dBc/Hz	-89 dBc/Hz		
6.25 to 12.5 GHz	-71 dBc/Hz	-79 dBc/Hz	-83 dBc/Hz	-71 dBc/Hz	-79 dBc/Hz	-83 dBc/Hz		
12.5 to 13.5 GHz	-65 dBc/Hz	-73 dBc/Hz	-77 dBc/Hz	-65 dBc/Hz	-73 dBc/Hz	-77 dBc/Hz		
13.5 to 20 GHz				-65 dBc/Hz	-73 dBc/Hz	-77 dBc/Hz		
20 to 40 GHz				-59 dBc/Hz	-67 dBc/Hz	-71 dBc/Hz		
40 to 50 GHz				-59 dBc/Hz	-67 dBc/Hz	-71 dBc/Hz		
Description	Typicals							
	Option 020, 025, 120, 125			Option 220, 225, 420, 425, 520, 525				
Non-harmonic spurious (at nominal output power)³								
300 kHz to 10 MHz	-50 dBc for offset frequency > 1 kHz							
10 MHz to 13.5 GHz								
13.5 to 20 GHz								
20 to 40 GHz	-30 dBc for offset frequency > 1 kHz							
40 to 50 GHz								
Description	Typicals							
	Option 020, 025, 120, 125		Option 220, 225	Option 420, 425		Option 520, 525		
Harmonics (2nd or 3rd) at maximum output power								
300 kHz to 10 MHz	-17 dBc							
10 to 500 MHz	-17 dBc		-22 dBc	-15 dBc		-15 dBc		
500 MHz to 1 GHz	-17 dBc		-22 dBc	-15 dBc		-15 dBc		
1 to 13.5 GHz	-20 dBc		-22 dBc	-20 dBc		-20 dBc		
13.5 to 20 GHz			-22 dBc	-20 dBc		-20 dBc		
20 to 40 GHz				-22 dBc		-22 dBc		
40 to 50 GHz						-22 dBc		

1. Performance specified on Port 1 only. Port 2 performance is a characteristic.

2. ALC range starts at maximum leveled power and decreases in power level indicated by the dB amount specified here.

3. Spurious signal levels are valid for a 10 MHz span centered on the carrier frequency. Spurious signals up to -15 dBc may exist outside the span. These signals do not affect the accuracy of the network analyzer measurements.

Table 11. Test point input

Description	Specifications				Typicals			
	Option 020, 025, 120, 125	Option 220, 225	Option 420, 425	Option 520, 525	Option 020, 025, 120, 125	Option 220, 225	Option 420, 425	Option 520, 525
Test port noise floor¹ 10 Hz IF bandwidth²								
300 kHz to 3 MHz ³	< -83 dBm				< -94 dBm			
3 to 10 MHz	< -103 dBm				< -110 dBm			
10 to 45 MHz	< -112 dBm				< -116 dBm	< -89 dBm	< -80 dBm	< -80 dBm
45 to 70 MHz	< -112 dBm	< -96 dBm	< -90 dBm	< -90 dBm	< -116 dBm			
70 to 500 MHz	< -112 dBm	< -100 dBm	< -90 dBm	< -90 dBm	< -116 dBm			
500 MHz to 2 GHz	< -112 dBm	< -105 dBm	< -110 dBm	< -110 dBm	< -120 dBm			
2 to 4 GHz	< -112 dBm	< -105 dBm	< -110 dBm	< -110 dBm	< -120 dBm			
4 to 8 GHz	< -112 dBm	< -105 dBm	< -110 dBm	< -110 dBm	< -119 dBm			
8 to 10.5 GHz	< -112 dBm	< -105 dBm	< -100 dBm	< -100 dBm	< -119 dBm			
10.5 to 13.5 GHz	< -107 dBm	< -105 dBm	< -100 dBm	< -100 dBm	< -114 dBm			
13.5 to 20 GHz	< -105 dBm				< -100 dBm			
20 to 31.25 GHz					< -100 dBm			
31.25 to 40 GHz					< -95 dBm			
40 to 50 GHz					< -90 dBm			
Test port noise floor¹ 1 KHz IF bandwidth								
300 kHz to 3 MHz ³	< -73 dBm				< -83 dBm			
3 to 10 MHz	< -83 dBm				< -90 dBm			
10 to 45 MHz	< -92 dBm				< -96 dBm	< -69 dBm	< -60 dBm	< -60 dBm
45 to 70 MHz	< -92 dBm	< -76 dBm	< -70 dBm	< -70 dBm	< -96 dBm			
70 to 500 MHz	< -92 dBm	< -80 dBm	< -70 dBm	< -70 dBm	< -96 dBm			
500 MHz to 2 GHz	< -92 dBm	< -85 dBm	< -90 dBm	< -90 dBm	< -100 dBm			
2 to 4 GHz	< -92 dBm	< -85 dBm	< -90 dBm	< -90 dBm	< -100 dBm			
4 to 8 GHz	< -92 dBm	< -85 dBm	< -90 dBm	< -90 dBm	< -99 dBm			
8 to 10.5 GHz	< -92 dBm	< -85 dBm	< -80 dBm	< -80 dBm	< -99 dBm			
10.5 to 13.5 GHz	< -87 dBm	< -85 dBm	< -80 dBm	< -80 dBm	< -94 dBm			
13.5 to 20 GHz	< -85 dBm				< -80 dBm			
20 to 31.25 GHz					< -80 dBm			
31.25 to 40 GHz					< -75 dBm			
40 to 50 GHz					< -70 dBm			
Description	Specifications				Typicals			
	Option 020, 125	Option 225	Option 425	Option 525	Option 020, 125	Option 225	Option 425	Option 525
Direct receiver access input noise floor¹ 10 Hz IF bandwidth²								
300 kHz to 3 MHz ³	< -99 dBm							
3 to 10 MHz	< -119 dBm							
10 to 45 MHz	< -128 dBm				< -120 dBm < -126 dBm < -126 dBm			
45 to 70 MHz	< -128 dBm	< -108 dBm	< -111 dBm	< -111 dBm				
70 to 500 MHz	< -128 dBm	< -112 dBm	< -111 dBm	< -111 dBm				
500 MHz to 2 GHz	< -128 dBm	< -117 dBm	< -122 dBm	< -122 dBm				
2 to 8 GHz	< -128 dBm	< -117 dBm	< -122 dBm	< -122 dBm				
8 to 10.5 GHz	< -128 dBm	< -117 dBm	< -112 dBm	< -112 dBm				
10.5 to 13.5 GHz	< -128 dBm	< -117 dBm	< -112 dBm	< -112 dBm				
13.5 to 20 GHz	< -117 dBm				< -112 dBm			
20 to 31.25 GHz					< -111 dBm			
31.25 to 40 GHz					< -106 dBm			
40 to 50 GHz					< -98 dBm			
Direct receiver access input noise floor¹ 1 KHz IF bandwidth								
300 kHz to 3 MHz ³	< -89 dBm							
3 to 10 MHz	< -99 dBm							
10 to 45 MHz	< -108 dBm				< -100 dBm < -106 dBm < -106 dBm			
45 to 70 MHz	< -108 dBm	< -88 dBm	< -91 dBm	< -91 dBm				
70 to 500 MHz	< -108 dBm	< -92 dBm	< -91 dBm	< -91 dBm				
500 MHz to 2 GHz	< -108 dBm	< -97 dBm	< -102 dBm	< -102 dBm				
2 to 8 GHz	< -108 dBm	< -97 dBm	< -102 dBm	< -102 dBm				
8 to 10.5 GHz	< -108 dBm	< -97 dBm	< -92 dBm	< -92 dBm				
10.5 to 13.5 GHz	< -108 dBm	< -97 dBm	< -92 dBm	< -92 dBm				
13.5 to 20 GHz	< -97 dBm				< -92 dBm			
20 to 31.25 GHz					< -91 dBm			
31.25 to 40 GHz					< -86 dBm			
40 to 50 GHz					< -78 dBm			

1. Total average (rms) noise power calculated as the mean value of a linear magnitude trace expressed in dBm.

2. 10 Hz IFBW test port noise floor performance is mathematically derived from the 1 kHz IFBW noise floor performance. The performance could be limited by crosstalk below 3 MHz at certain frequencies. The measurement is defined as a single receiver measurement with loads on the ports at a given CW frequency with power set to the minimum plus 5 dB.

3. Value and/or frequency changed July 2006.

Table 11. Test port input (Continued)

Description	Specifications						Typicals	
	Option 220, 225		Option 420, 520		Option 425, 525		Option 220, 225	
Compression level								
	Power	Compression	Power	Compression	Power	Compression	Power	Compression
10 to 45 MHz ²							+5 dBm	0.10 dB
45 to 500 MHz	+5 dBm	0.10 dB	+5 dBm	0.40 dB	+5 dBm	0.40 dB		
500 MHz to 2 GHz	+5 dBm	0.15 dB	+5 dBm	0.77 dB	+5 dBm	0.67 dB		
2 to 8 GHz	+5 dBm	0.21 dB	+5 dBm	0.75 dB	+5 dBm	0.55 dB		
8 to 12.5 GHz	+5 dBm	0.21 dB	+5 dBm	0.56 dB	+5 dBm	0.51 dB		
12.5 to 20 GHz	+3 dBm	0.20 dB	+5 dBm	0.79 dB	+5 dBm	0.69 dB		
20 to 31.25 GHz			0 dBm	0.60 dB	0 dBm	0.50 dB		
31.25 to 40 GHz			-3 dBm	0.55 dB	-3 dBm	0.60 dB		
40 to 50 GHz			-3 dBm	0.66 dB	-3 dBm	0.71 dB		

Description	Specifications		Typicals	Description	Typicals	
	Option 020, 120, 025, 125				Option 020, 120, 025, 125	
Compression level				Compression level - 0.1 dB		
	Power	Compression			Power	Compression
300 kHz to 10 MHz	+8 dBm	1.0 dB	0.1 dB at +5 dBm	300 kHz to 10 MHz	+5 dBm	0.1 dB
10 to 50 MHz	+8 dBm	0.35 dB		10 MHz to 1 GHz	+9 dBm	0.1 dB
50 MHz to 1 GHz	+8 dBm	0.35 dB		1 to 12.5 GHz	+10 dBm	0.1 dB
1 to 6 GHz	+8 dBm	0.25 dB		12.5 to 13.5 GHz	+9 dBm	0.1 dB
6 to 8 GHz	+8 dBm	0.25 dB				
8 to 12.5 GHz	+8 dBm	0.30 dB				
12.5 to 13.5 GHz	+8 dBm	0.40 dB				

Description	Specifications			Typicals			
	Option 220, 225	Option 420, 425	Option 520, 525	Option 220	Option 225	Option 420, 425	Option 520, 525
Test port compression - 0.1 dB							
300 kHz to 10 MHz	-	-	-				
10 to 45 MHz ²	-	-	-	+10 dBm	Negligible	Negligible	Negligible
45 to 500 MHz	-	-	-	+10 dBm	+10 dBm	0.0 dBm	+1.0 dBm
500 MHz to 2 GHz	-	-	-	+9 dBm	+9 dBm	0.0 dBm	+1.0 dBm
2 to 12.5 GHz	-	-	-	+6 dBm	+6 dBm	0.0 dBm	+1.5 dBm
12.5 to 13.5 GHz	-	-	-	+6 dBm	+6 dBm	-1.0 dBm	0.0 dBm
13.5 to 20 GHz	-	-	-	+6 dBm	+6 dBm	-1.0 dBm	0.0 dBm
20 to 31.25 GHz	-	-	-			-5.5 dBm	-3.0 dBm
31.25 to 40 GHz	-	-	-			-8.5 dBm	-7.5 dBm
40 to 50 GHz	-	-	-				-10.0 dBm
Trace noise magnitude ³							
1 kHz IF bandwidth, ratioed measurement, nominal power at test port.							
300 kHz to 10 MHz	-	-	-				
10 to 45 MHz				0.004 dB rms	0.015 dB rms	0.015 dB rms	
45 to 500 MHz	0.004 dB rms	0.010 dB rms	0.010 dB rms				
500 MHz to 2 GHz	0.004 dB rms	0.006 dB rms	0.006 dB rms				
2 to 10.5 GHz	0.004 dB rms	0.006 dB rms	0.006 dB rms				
10.5 to 13.5 GHz	0.006 dB rms	0.010 dB rms	0.010 dB rms				
13.5 to 20 GHz	0.006 dB rms	0.010 dB rms	0.010 dB rms				
20 to 31.25 GHz		0.010 dB rms	0.010 dB rms				
31.25 to 40 GHz		0.020 dB rms	0.020 dB rms				
40 to 50 GHz			0.020 dB rms				

1. Total average (rms) noise power calculated as the mean value of a linear magnitude trace expressed in dBm.

2. For Options 225, 420, 425, 520, and 525 coupler roll-off will reduce compression to a negligible level below 45 MHz.

3. 1 kHz IF BW, ratioed measurement, nominal power at the test port.

Table 11. Test port input (Continued)

Description	Specifications	Typicals
	Option 020, 120, 025, 125	Option 020, 120, 025, 125
Trace noise magnitude ³ (continued)		
100 kHz IF bandwidth, ratioed measurement, nominal power at test port.		
300 kHz to 10 MHz	12 mdB	
10 MHz to 6 GHz	4 mdB	
6 to 10.5 GHz	4 mdB	
10.5 to 13.5 GHz	8 mdB	
600 kHz IF bandwidth, ratioed measurement, nominal power at test port.		
300 kHz to 10 MHz	–	20 mdB
10 MHz to 6 GHz	–	8 mdB
6 to 10.5 GHz	–	8 mdB
10.5 to 13.5 GHz	–	10 mdB

Description	Specifications			Typicals		
	Option 220, 225	Option 420, 425	Option 520, 525	Option 220, 225	Option 420, 425	Option 520, 525
Trace noise phase ³						
1 kHz IF bandwidth, ratioed measurement, nominal power at test port.						
300 kHz to 10 MHz	–	–	–			
10 to 45 MHz				0.025° rms	0.100° rms	0.100° rms
45 to 500 MHz	0.060° rms	0.100° rms	0.100° rms			
500 MHz to 2 GHz	0.060° rms	0.060° rms	0.060° rms			
2 to 10.5 GHz	0.060° rms	0.060° rms	0.060° rms			
10.5 to 13.5 GHz	0.060° rms	0.100° rms	0.100° rms			
13.5 to 20 GHz	0.060° rms	0.100° rms	0.100° rms			
20 to 31.25 GHz		0.100° rms	0.100° rms			
31.25 to 40 GHz		0.200° rms	0.200° rms			
40 to 50 GHz			0.200° rms			

Description	Specifications	Typicals
	Option 020, 120, 025, 125	Option 020, 120, 025, 125
Trace noise phase ³		
100 kHz IF bandwidth, ratioed measurement, nominal power at test port.		
300 kHz to 10 MHz	80 mdeg	
10 MHz to 6 GHz	30 mdeg	
6 to 10.5 GHz	30 mdeg	
10.5 to 13.5 GHz	60 mdeg	
600 kHz IF bandwidth, ratioed measurement, nominal power at test port.		
300 kHz to 10 MHz	–	100 mdeg
10 MHz to 6 GHz	–	60 mdeg
6 to 10.5 GHz	–	60 mdeg
10.5 to 13.5 GHz	–	80 mdeg

Description	Specifications	Typicals
	Option 020, 025, 120, 125, 220, 225, 420, 425, 520, 525	Option 020, 025, 120, 125, 220, 225, 420, 425, 520, 525
Reference level magnitude		
Range	±200 dB	
Resolution	0.001 dB	
Reference level phase		
Range	±500°	
Resolution	0.01°	

1. Total average (rms) noise power calculated as the mean value of a linear magnitude trace expressed in dBm.

2. For Options 225, 420, 425, 520, and 525 coupler roll-off will reduce compression to a negligible level below 45 MHz.

3. 1 kHz IF BW, ratioed measurement, nominal power at the test port.

4. Stability is defined as a ratio measurement made at the test port.

Table 11. Test port input (Continued)

Description	Typicals		
	Option 020, 025, 120, 125	Option 220, 225	Option 420, 425, 520, 525
Stability magnitude⁴			
300 kHz to 10 MHz	±0.015 dB/°C		
10 to 45 MHz	±0.010 dB/°C	±0.015 dB/°C	±0.015 dB/°C
45 to 500 MHz	±0.010 dB/°C	±0.010 dB/°C	±0.010 dB/°C
500 MHz to 2 GHz	±0.010 dB/°C	±0.010 dB/°C	±0.010 dB/°C
2 to 4 GHz	±0.015 dB/°C	±0.020 dB/°C	±0.010 dB/°C
4 to 8 GHz	±0.020 dB/°C	±0.020 dB/°C	±0.010 dB/°C
8 to 13.5 GHz	±0.020 dB/°C	±0.030 dB/°C	±0.015 dB/°C
13.5 to 20 GHz		±0.030 dB/°C	±0.015 dB/°C
20 to 40 GHz			±0.040 dB/°C
40 to 50 GHz			±0.060 dB/°C
Stability phase⁴			
300 kHz to 10 MHz	±0.30°/°C		
10 to 45 MHz	±0.025°/°C	±0.25°/°C	±0.25°/°C
45 to 500 MHz	±0.035°/°C	±0.20°/°C	±0.22°/°C
500 MHz to 2 GHz	±0.050°/°C	±0.15°/°C	±0.22°/°C
2 to 4 GHz	±0.10°/°C	±0.15°/°C	±0.10°/°C
4 to 8 GHz	±0.15°/°C	±0.15°/°C	±0.10°/°C
8 to 13.5 GHz	±0.30°/°C	±0.45°/°C	±0.15°/°C
13.5 to 20 GHz		±0.45°/°C	±0.15°/°C
20 to 40 GHz			±0.40°/°C
40 to 50 GHz			±0.40°/°C

Description	Typicals				
	Option 020, 120	Option 220	Option 420, 520	Option 025, 125	Option 225, 425, 525
Damage input level					
Test port 1 and 2	+27 dBm or ±16 VDC	+30 dBm or ±25 VDC	+30 dBm or ±40 VDC	+27 dBm or ±16 VDC	+27 dBm or ±7 VDC
R1, R2 in				+15 dBm or ±16 VDC	+15 dBm or ±7 VDC
A, B in				+15 dBm or ±16 VDC	+15 dBm or ±7 VDC
Coupler thru				+27 dBm or ±16 VDC	+30 dBm or ±40 VDC
Coupler arm				+15 dBm or ±0 VDC	+30 dBm or ±7 VDC
Source out (reference)				+20 dBm or ±16 VDC	+20 dBm or ±7 VDC
Source out (test ports)				+27 dBm or ±16 VDC	+30 dBm or ±7 VDC

1. Total average (rms) noise power calculated as the mean value of a linear magnitude trace expressed in dBm.

2. For Options 225, 420, 425, 520, and 525 coupler roll-off will reduce compression to a negligible level below 45 MHz.

3. 1 kHz IF BW, ratioed measurement, nominal power at the test port.

4. Stability is defined as a ratio measurement made at the test port.

Dynamic Accuracy

Note: Dynamic accuracy uncertainty curves are available within the PNA-L network analyzer's internal Help system. The Help system is also available online at www.keysight.com. Navigate to the home page for your PNA model, then click on manuals & guides. Please download our free uncertainty calculator from www.keysight.com/find/na_calculator to generate the curves for your calibration kit and PNA setup.

Table 12. Test port input (group delay)¹

Description	Supplemental information (typ.)
Aperture (selectable)	(frequency span)/(number of points - 1)
Maximum aperture	20% of frequency span
Range	0.5 x (1/minimum aperture)
Maximum delay	Limited to measuring no more than 180° of phase change within the minimum aperture
Accuracy	See graph below. (Char.)

Group delay (typical)

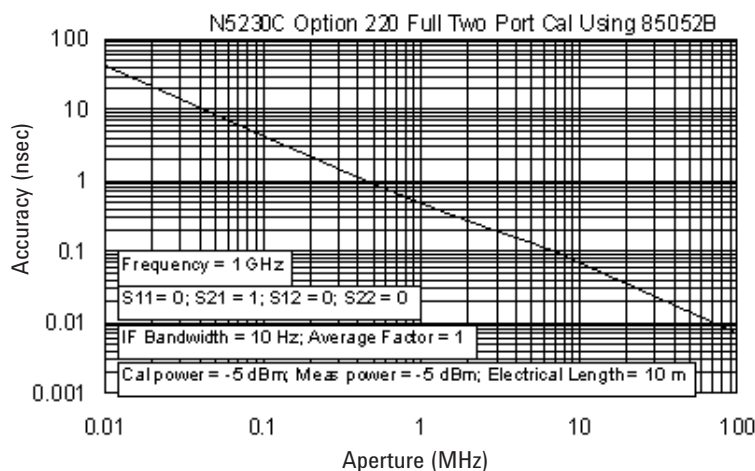

The following graph shows characteristic group delay accuracy with full 2-port calibration and a 10 Hz IF bandwidth. Insertion loss is assumed to be < 2 dB and electrical length to be ten meters.

In general, the following formula can be used to determine the accuracy, in seconds, of specific group delay measurement:

$$\pm \text{Phase Accuracy (deg)} / [360^\circ \text{ Aperture (Hz)}]$$

Depending on the aperture and device length, the phase accuracy used is either incremental phase accuracy or worst case phase accuracy.

1. Group delay is computed by measuring the phase change within a specified frequency step (determined by the frequency span and the number of points per sweep).

General Information

Table 13. Miscellaneous information

Description	Supplemental information
System IF bandwidth range	Option 020, 025, 120, 125 1 Hz to 600 kHz, nominal Option 220, 225, 420, 425, 520, 525 1 Hz to 250 kHz, nominal
CPU	Intel 1.1 GHz Pentium M with 1 GByte RAM

Table 14. Front panel information

Description	Supplemental information
RF connectors	
N5230C	
Type	Option 020, 025, 120, 125, 220 or 225: 3.5 mm (male), 50 ohm, (nominal) Option 420, 425, 520, or 525: 2.4 mm (male), 50 ohm, (nominal)
Center pin recession	0.002 in. (characteristic)
Display	
Size	21.3 cm (8.4 in) diagonal color active matrix LCD; 1024 (horizontal) X 768 (vertical) resolution
Refresh rate	60 Hz
Display range	The PNA display must remain in the 16-bit color setting in order to comply with international emissions regulations
Magnitude	± 500 dB (at 20 dB/div), max
Phase	$\pm 500^\circ$, max
Polar	10 pUnits, min 1000 Units, max
Display resolution	
Magnitude	0.001 dB/div, min
Phase	0.01°/div, min
Marker resolution	
Magnitude	0.001 dB, min
Phase	0.01°, min
Polar	0.01 mUnit, min; 0.01°, min

Table 15. Rear panel information

Description	Supplemental information
Trigger inputs/outputs	BNC (f), TTL/CMOS compatible
10 MHz Reference in	
Connector	BNC, female
Input frequency	10 MHz \pm 10 ppm, typical
Input level	-15 to +20 dBm, typical
Input impedance	200 Ω , nom.
10 MHz Reference out	
Connector	BNC, female
Output frequency	10 MHz \pm 1 ppm, typical
Signal type	Sine Wave, typical
Output level	+10 dBm \pm 4 dB into 50 W, typical
Output impedance	50 Ω , nominal
Harmonics	< -40 dBc, typical
VGA Video output	
Connector	15-pin mini D-Sub; Drives VGA compatible monitors
Test set IO	
	25-pin D-Sub connector, available for external test set control
Aux IO	
	25-pin D-Sub connector, male, analog and digital I/O
Handler IO	
	36-pin parallel I/O port; all input/output signals are default set to negative logic; can be reset to positive logic via GPIB command
GPIB	
	Two ports: dedicated Controller and dedicated Talker/Listener. 24-pin D-sub (Type D-24), female; compatible with IEEE-488.
USB Port	
	2 ports on front panel and 4 ports on rear panel.
LAN	
	10/100BaseT Ethernet, 8-pin configuration; auto selects between the two data rates
Line power (single phase)	
Frequency, voltage	50/60 Hz/400 Hz for 100 to 120 V, 50/60 Hz for 220 to 240 V, (power supply is auto switching)
Maximum	350 Watts

Table 16. Analyzer environment and dimensions

Description	Supplemental information		
General environmental			
EMC	Complies with European EMC directive 2004/108/EC – IEC/EN 61326-1:2005 – CISPR Pub 11 Group 1, class A – AS/NZS CISPR II:2004 – ICES/NMB-001		
Safety	Complies with European Low Voltage Directive 2006/95/EC – IEC/EN 61010-1:2001 – Canada: CSA C22.2 No. 61010-1:2004 – USA: UL 61010-1:2004		
Operating environment			
Temperature	0 to +40 °C		
	Instrument powers up and displays no error messages within this temperature range (except for "source unlevelled" error message that may occur at temperatures outside the specified performance temperature range of 25 ± 5 °C).		
Error-corrected temperature range	23 °C ± 3 °C with less than 1 °C deviation from calibration temp.		
Relative humidity	Type-tested 0 to 95% at 40 °C, non-condensing		
Altitude	0 to 4600 m (15,000 ft.)		
Non-operating storage environment			
Temperature	–40 to +70 °C		
Cabinet dimensions			
	Height	Width	Depth
Excluding front and rear panel hardware and feet	267 mm 10.5 in	426 mm 16.75	427 mm 16.8 in
As shipped - includes front panel connectors, rear panel bumpers, and feet.	280 mm 11 in	435 mm 17.10 in	470 mm 18.5 in
As shipped plus handles	280 mm 11 in	458 mm 18 in	501 mm 19.7 in
As shipped plus rack-mount flanges	280 mm 11 in	483 mm 19 in	470 mm 18.5 in
As shipped plus handles and rack-mount flanges	280 mm 11 in	483 mm 19 in	501 mm 19.7 in
Weight			
Net			
N5230C	24.9 kg (55 lb), nominal		
Shipping			
N5230C	36.3 kg (80 lb), nominal		

Measurement Throughput Summary

Table 17. Typical cycle time^{1,2} (ms) for measurement completion

	Number of Points				
	201	401	801	1601	16,001
Start 8 GHz, stop 18 GHz, 30 kHz IF bandwidth					
Uncorrected	97.5	102.7	103.8	108.2	683.9
2-Port cal	203.7	213.5	218.5	234.6	1504.3
Start 10 MHz, stop 10 GHz, 30 kHz IF bandwidth					
Uncorrected	112.6	120.6	124.8	138.2	738.4
2-Port cal	232.8	251.8	265.2	304.3	1623.4
Start 10 MHz, stop 20 GHz, 30 kHz IF bandwidth					
Uncorrected	146	199.3	210.9	217.2	753.9
2-Port cal	302.3	410.5	438.7	462.5	1660.5
Start 8 GHz, stop 18 GHz, 50 kHz IF bandwidth					
Uncorrected	79.1	81	81.7	86.6	482
2-Port cal	164.5	170.3	175.3	193.5	1104.7
Start 10 MHz, stop 10 GHz, 50 kHz IF bandwidth					
Uncorrected	96.8	101.7	108.8	122.2	524.6
2-Port cal	202.1	215.6	236.7	276.7	1198.8
Start 10 MHz, stop 20 GHz, 50 kHz IF bandwidth					
Uncorrected	141.6	163.9	170.7	179.7	546.5
2-Port cal	293.6	341	360	389.5	1248.8

1. Typical performance.

2. Includes sweep time, retrace time and band-crossing time. Analyzer display turned off with DISPLAY:ENABLE OFF. Add 21 ms for display on. Data for one trace (S11) measurement.

Table 18. Cycle Time vs IF bandwidth¹ (Options 020, 025, 120, 125 only)

Applies to the preset condition (201 points, correction off) except for the following changes:

- CF = 10 GHz
- Span = 100 MHz
- Display off (add 21 ms for display on)

Description	Typical performance	
	IF Bandwidth (Hz)	Cycle time (ms) ²
600,000	7	0.0035
360,000	7	0.0026
280,000	7	0.0022
200,000	7	0.0021
150,000	7	0.0016
100,000	7	0.0012
70,000	7	0.0011
50,000	9	0.0009
30,000	11	0.0008
20,000	14	0.0006
15,000	17	0.0005
10,000	28	0.0004
7,000	37	0.0004
5,000	48	0.0003
3,000	72	0.0003
2,000	102	0.0002
1,500	130	0.0001
1,000	218	0.0001
700	294	0.0001
500	399	0.0001
300	636	0.0001
200	932	Negligible
100	1,826	Negligible
30	6,004	Negligible
10	17,903	Negligible
1	178,398	Negligible

1. Typical performance.

2. Cycle time includes sweep and retrace time.

Table 19. Cycle Time vs IF bandwidth¹ (Options 220, 225, 420, 425, 520, 525 only)

Applies to the preset condition (201 points, correction off) except for the following changes:

- CF = 10 GHz
- Span = 100 MHz
- Display off (add 21 ms for display on)

Description	Typical performance	
	IF Bandwidth (Hz)	Cycle time (ms) ²
250,000	8	37
200,000	9	39
150,000	9	40
100,000	10	41
70,000	11	43
50,000	12	45
30,000	15	50
20,000	18	53
15,000	21	57
10,000	27	65
7,000	34	75
5,000	48	93
3,000	72	124
2,000	108	169
1,500	126	187
1,000	272	
700	357	
500	460	
300	697	
200	1003	
150	1307	
100	1917	
30	6173	
10	18214	
1	181699	

1. Typical performance.

2. Cycle time includes sweep and retrace time.

Table 20. Cycle time vs number of points¹ (Options 020, 025, 120, 125 only)

Applies to the preset condition (201 points, correction off) except for the following changes:

- CF = 10 GHz
- Span = 100 MHz
- Display off (add 21 ms for display on)

Description	Typical performance	
	Number of points	Cycle time (ms) ²
30,000	3	6
	11	7
	51	6
	101	7
	201	11
	401	18
	801	32
	1,601	59
	6,401	224
	16,001	556
300,000	3	6
	11	6
	51	6
	101	7
	201	7
	401	9
	801	13
	1,601	22
	6,401	75
	16,0001	180
600,000	3	6
	11	6
	51	6
	101	6
	201	7
	401	8
	801	9
	1,601	12
	6,401	27
	16,0001	59

1. Typical performance.

2. Cycle time includes sweep and retrace time.

Table 21. Cycle time vs number of points¹ (Options 220, 225, 420, 425, 520, 525 only)

Applies to the preset condition (correction off) except for the following changes:

- CF = 10 GHz
- Span = 100 MHz
- Display off (add 21 ms for display on)

IF Bandwidth (Hz)	Number of points	Cycle time (ms) ²
30,000	3	8
	11	8
	51	9
	101	11
	201	15
	401	23
	801	39
	1,601	71
	6,401	265
	16,001	650
50,000	3	7
	11	7
	51	8
	101	10
	201	13
	401	18
	801	29
	1,601	52
	6,401	184
	16,001	448
250,000	101	8
	201	9
	401	10
	801	14
	1,601	21
	6,401	61
	16,001	147

1. Typical performance.

2. Cycle time includes sweep and retrace time.

Note: Specifications for recall and sweep speed are not provided for the N5230C analyzers.

Table 22. Data transfer time (ms)¹

	Number of points			
	201	401	1601	16,001
SCPI over GPIB (program executed on external PC)				
32-bit floating point	7	12	43	435
64-bit floating point	12	22	84	856
ASCII	64	124	489	5054
SCPI (program executed in the analyzer)				
32-bit floating point	1	2	3	30
64-bit floating point	2	2	4	40
ASCII	29	56	222	2220
COM (program executed in the analyzer)				
32-bit floating point	< 0.4	0.4	0.5	1.9
Variant type	0.7	1	3	32
DCOM over LAN (program executed on external PC)				
32-bit floating point	< 0.8	1	1.5	7.1
Variant type	1.8	2.7	8.5	80

1. Typical performance.

Note: Specifications for recall and sweep speed are not provided for the N5230C analyzers.

Specifications: Front-Panel Jumpers

Model N5230C Option 025, 125, 225, 425, or 525

Note: The N5230C Option 020, 120, 220, 420, or 520 (standard test set and standard power range) has no front-panel jumpers.

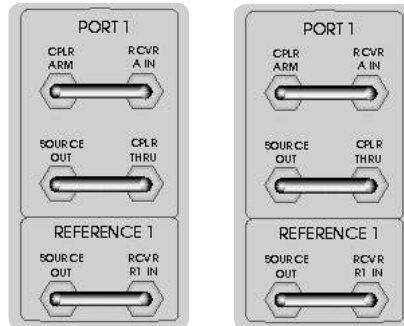

Table 23. Measurement receiver inputs (rcvr A In, rcvr B In) 0-1 dB Typical Compression

Description	Typicals		
	Option 025, 125	Option 225	Options 425, 525
Maximum input level			
300 kHz to 10 MHz	-11 dBm		
10 to 45 MHz	-7 dBm	-2 dBm	-20 dBm
45 to 500 MHz	-7 dBm	-2 dBm	-19 dBm
500 MHz to 2 GHz	-6 dBm	-3 dBm	-14 dBm
2 to 12.5 GHz	-6 dBm	-6 dBm	-14 dBm
12.5 to 13.5 GHz	-7 dBm	-6 dBm	-15 dBm
13.5 to 20 GHz		-6 dBm	-15 dBm
20 to 31.25 GHz			-16 dBm
31.25 to 40 GHz			-21 dBm
40 to 45 GHz			-24 dBm
45 to 50 GHz			-22 dBm
Damage level			
N5230C	+15 dBm	+15 dBm	+15 dBm
Maximum DC level			
N5230C	±16 V	±7 V	±7 V

Table 24. Reference receiver inputs (rcvr R1, rcvr R2) at maximum specified output power

Description	Typicals		
	Option 025, 125	Option 225	Options 425, 525
Maximum input level			
300 kHz to 10 MHz	-15 dBm		
10 to 500 MHz	-13 dBm	-18 dBm	-28 dBm
500 to 2 MHz	-14 dBm	-18 dBm	-28 dBm
2 to 6 GHz	-14 dBm	-19 dBm	-28 dBm
6 to 8 GHz	-16 dBm	-19 dBm	-28 dBm
8 to 9 GHz	-16 dBm	-21 dBm	-27 dBm
9 to 10.5 GHz	-20 dBm	-21 dBm	-27 dBm
10.5 to 12.5 GHz	-22 dBm	-21 dBm	-27 dBm
12.5 to 13.5 GHz	-24 dBm	-23 dBm	-26 dBm
13.5 to 20 GHz		-23 dBm	-26 dBm
20 to 31.25 GHz			-33 dBm
31.25 to 40 GHz			-27 dBm
40 to 45 GHz			-29 dBm
45 to 50 GHz			-28 dBm
Damage level			
N5230C	+15 dBm	+15 dBm	+15 dBm
Maximum DC level			
N5230C	±16 V	±7 V	±7 V

Table 25. Reference Outputs (reference 1 source out, reference 2 source out) at maximum specified output power

Description	Typicals		
	Option 025, 125	Option 225	Options 425, 525
Maximum output level			
300 kHz to 10 MHz	-15 dBm		
10 to 500 MHz	-13 dBm	-18 dBm	-28 dBm
500 MHz to 2 GHz	-14 dBm	-18 dBm	-28 dBm
2 to 6 GHz	-14 dBm	-19 dBm	-28 dBm
6 to 8 GHz	-16 dBm	-19 dBm	-28 dBm
8 to 9 GHz	-16 dBm	-20 dBm	-27 dBm
9 to 10.5 GHz	-20 dBm	-20 dBm	-27 dBm
10.5 to 12.5 GHz	-22 dBm	-20 dBm	-27 dBm
12.5 to 13.5 GHz	-24 dBm	-23 dBm	-26 dBm
13.5 to 20 GHz		-23 dBm	-26 dBm
20 to 31.25 GHz			-32 dBm
31.25 to 40 GHz			-26 dBm
40 to 45 GHz			-29 dBm
45 to 50 GHz			-28 dBm
Damage level			
N5230C	+20 dBm	+20 dBm	+20 dBm
Maximum DC level			
N5230C	±16 V	±7 V	±7 V

Table 26. Source outputs (port 1 source out, port 2 source out) at maximum specified output power

Description	Typicals		
	Option 025, 125	Option 225	Options 425, 525
Maximum output level			
300 kHz to 10 MHz	+11 dBm		
10 to 500 MHz	+11 dBm	+6 dBm	+1 dBm
500 MHz to 6 GHz	+11 dBm	+7 dBm	+1 dBm
6 to 9 GHz	+10 dBm	+7 dBm	+1 dBm
9 to 12.5 GHz	+8 dBm	+7 dBm	+1 dBm
12.5 to 13.5 GHz	+5 dBm	+5 dBm	+3 dBm
13.5 to 20 GHz		+5 dBm	+3 dBm
20 to 31.25 GHz			-5 dBm
31.25 to 40 GHz			-4 dBm
40 to 45 GHz			-11 dBm
45 to 50 GHz			-11 dBm
Damage level			
N5230C	+27 dBm	+30 dBm	+30 dBm
Maximum DC level			
N5230C	±16 V	±7 V	±7 V

Table 27. Coupler inputs (port 1 Cplr Thru, port 2 Cplr Thru)

Description	Typicals		
	Option 025, 125	Option 225	Options 425, 525
Insertion loss to test port			
30 kHz to 10 MHz	2 dB		
10 to 500 MHz	2 dB	0.6 dB	0.6 dB
500 MHz to 2 GHz	3 dB	1.6 dB	0.8 dB
2 to 8 GHz	3 dB	1.8 dB	1.0 dB
8 to 9 GHz	3 dB	1.9 dB	1.0 dB
9 to 12.5 GHz	4 dB	1.9 dB	1.0 dB
12.5 to 13.5 GHz	4 dB	2.0 dB	2.0 dB
13.5 to 20 GHz		2.0 dB	2.0 dB
20 to 31.25 GHz			3.0 dB
31.25 to 50 GHz			4.0 dB
Damage level			
N5230C	+27 dBm	+30 dBm	+30 dBm
Maximum DC level			
N5230C	±16 V	±40 V	±40 V

Table 28. Coupler outputs (port 1 Cplr Arm, port 2 Cplr Arm)

Description	Typicals		
	Option 025, 125	Option 225	Options 425, 525
Damage level			
N5230C	+15 dBm	+30 dBm	+30 dBm
Maximum DC level			
N5230C	+0 Vdc	+7 Vdc	+7 Vdc

Test Set Block Diagrams

N5230C Option 020, 120, 220, 420, or 520

(standard test set and standard power range) network analyzer

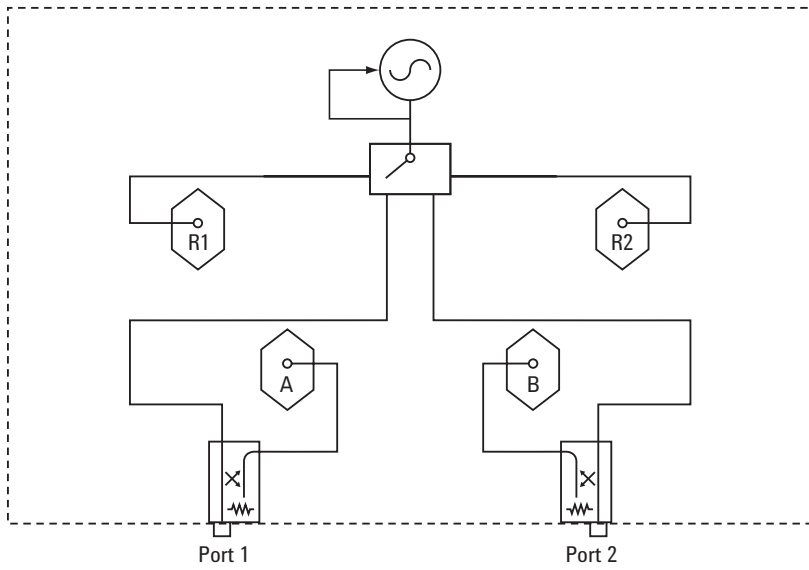

N5230C Option 025, 125, 225, 425, or 525

(configurable test set and extended power range) network analyzer

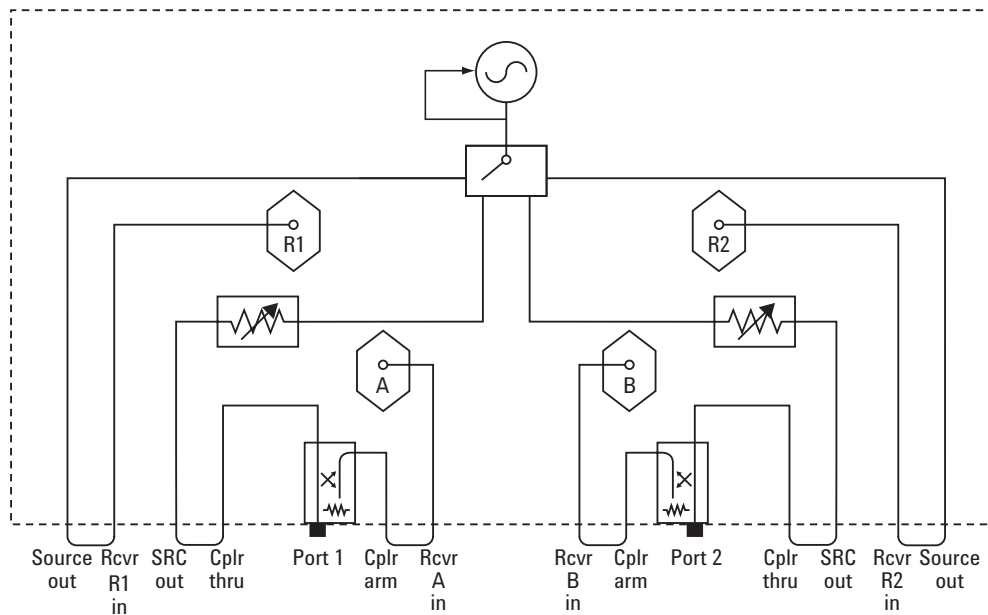

myKeysight



myKeysight

www.keysight.com/find/mykeysight

A personalized view into the information most relevant to you.

www.keysight.com/find/ThreeYearWarranty

Keysight's commitment to superior product quality and lower total cost of ownership. The only test and measurement company with three-year warranty standard on all instruments, worldwide.

Keysight Assurance Plans

www.keysight.com/find/AssurancePlans

Up to five years of protection and no budgetary surprises to ensure your instruments are operating to specification so you can rely on accurate measurements.

www.keysight.com/quality

Keysight Electronic Measurement Group
DEKRA Certified ISO 9001:2008
Quality Management System

Keysight Channel Partners

www.keysight.com/find/channelpartners

Get the best of both worlds: Keysight's measurement expertise and product breadth, combined with channel partner convenience.

www.keysight.com/find/pnal

Web Resources

Visit our Web sites for additional product information and literature.

PNA Microwave network analyzers:

www.keysight.com/find/pna

PNA-L network analyzers:

www.keysight.com/find/pnal

Electronic calibration (ECal):

www.keysight.com/find/ecal

Test and measurement solutions:

www.keysight.com/find/accessories

For more information on Keysight Technologies' products, applications or services, please contact your local Keysight office. The complete list is available at: www.keysight.com/find/contactus

Americas

Canada	(877) 894 4414
Brazil	55 11 3351 7010
Mexico	001 800 254 2440
United States	(800) 829 4444

Asia Pacific

Australia	1 800 629 485
China	800 810 0189
Hong Kong	800 938 693
India	1 800 112 929
Japan	0120 (421) 345
Korea	080 769 0800
Malaysia	1 800 888 848
Singapore	1 800 375 8100
Taiwan	0800 047 866
Other AP Countries	(65) 6375 8100

Europe & Middle East

Austria	0800 001122
Belgium	0800 58580
Finland	0800 523252
France	0805 980333
Germany	0800 6270999
Ireland	1800 832700
Israel	1 809 343051
Italy	800 599100
Luxembourg	+32 800 58580
Netherlands	0800 0233200
Russia	8800 5009286
Spain	0800 000154
Sweden	0200 882255
Switzerland	0800 805353
	Opt. 1 (DE)
	Opt. 2 (FR)
	Opt. 3 (IT)
United Kingdom	0800 0260637

For other unlisted countries:

www.keysight.com/find/contactus

(BP-06-09-14)