

Keysight Technologies

E5080A ENA Vector Network Analyzer

- 9 kHz to 4.5/6.5/9 GHz

E5092A Configurable Multiport Test Set

Data Sheet

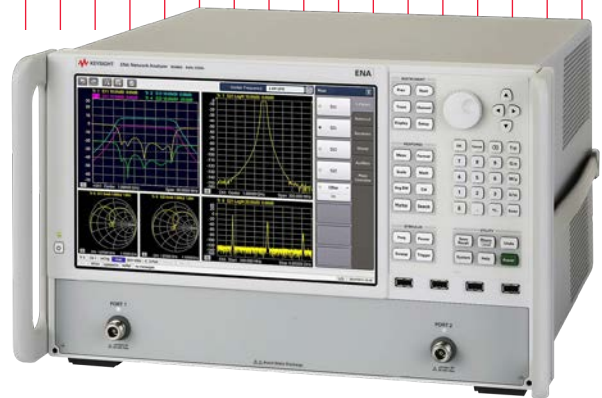
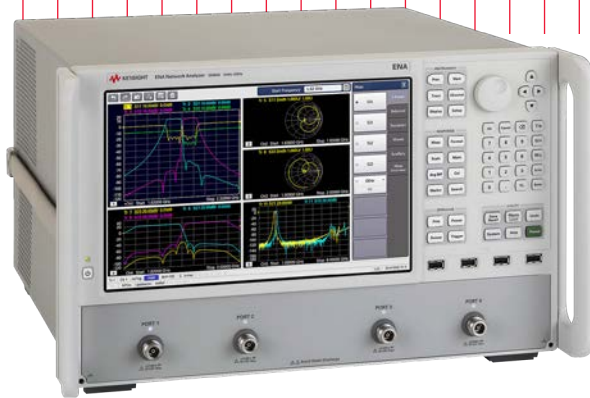

Table of Contents

Options	03
Calibration kits and ECal modules	03
Definitions	03
Corrected System Performance	04
Corrected System Performance with Calibration Kit	05
Uncorrected System Performance	09
Test Port Output (Source)	09
Test port output signal purity	10
Test Port Input	11
General Information	14
Measurement Throughput Summary	20
E5092A Configurable multiport test set	23

Options

This document provides technical specifications for the E5080A ENA vector network analyzer

E5080A-245	2-port test set, 9 kHz to 4.5 GHz, with bias tees
E5080A-265	2-port test set, 9 kHz to 6.5 GHz, with bias tees
E5080A-295	2-port test set, 9 kHz to 9 GHz, with bias tees
E5080A-445	4-port test set, 9 kHz to 4.5 GHz, with bias tees
E5080A-465	4-port test set, 9 kHz to 6.5 GHz, with bias tees
E5080A-495	4-port test set, 9 kHz to 9 GHz, with bias tees

Calibration kits and ECal modules

This E5080A data sheet also provides technical specifications for the following calibration kits and ECal modules. For models not listed in this data sheet, please download the free Uncertainty Calculator from http://www.keysight.com/find/na_calculator to generate the curves for your calibration kit and enable ENA setup.

85032F	Calibration kit
85033E	Calibration kit
85092C	Electronic calibration (ECal) module
85093C	Electronic calibration (ECal) module

Definitions

Specification (spec.):

Warranted performance. All specifications apply at 25 °C (± 5 °C), unless otherwise stated, and 90 minutes after the instrument has been turned on. Specifications include guard bands to account for the expected statistical performance distribution, measurement uncertainties, and changes in performance due to environmental conditions.

Typical (typ.):

Expected performance of an average unit which does not include guardbands. It is not covered by the product warranty.

General characteristics:

A general, descriptive term that does not imply a level of performance.



Corrected System Performance

The specifications in this section apply to measurements made with the Keysight E5080A network analyzer under the following conditions:

- No averaging applied to data
- Environmental temperature of 23 °C (± 3 °C) with less than 1 °C deviation from the calibration temperature
- Response and isolation calibration performed

System dynamic range¹

	Specification (10 Hz IFBW)	Typical (3 Hz IFBW)
9 k to 100 kHz	120 dB	137 dB
100 k to 50 MHz	129 dB	146 dB
50 M to 6 GHz	135 dB	152 dB
6 G to 8.5 GHz	132 dB	145 dB
8.5 G to 9 GHz	120 dB	135 dB

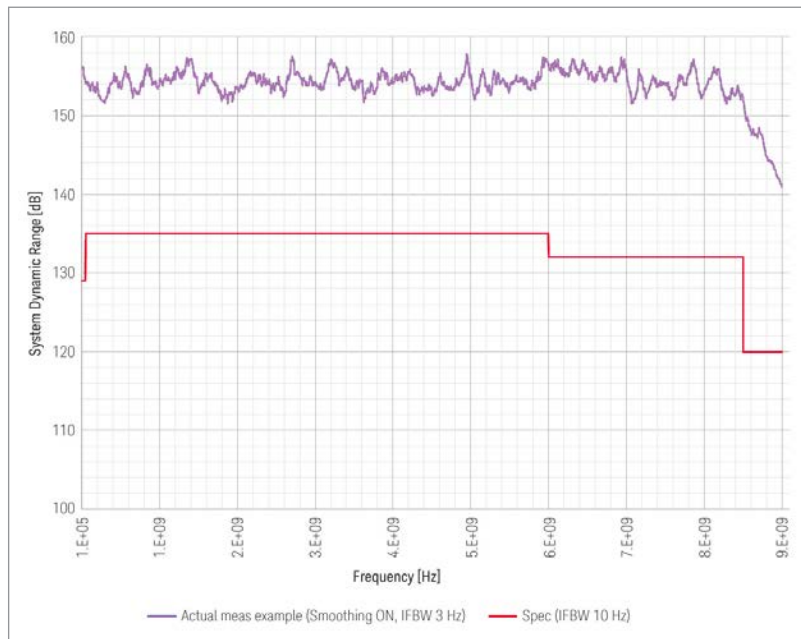

System dynamic range (specification and actual measurement data example)

1. The test port dynamic range is calculated as the difference between the test port rms noise floor and the source maximum output power. The effective dynamic range must take measurement uncertainty and interfering signals into account.



Corrected System Performance with Calibration Kit

Corrected system performance with type-N device connectors, 85032F calibration kit

Network analyzer : E5080A
 Calibration kit : 85032F (Type-N, 50 Ω)
 Calibration : full 2-port

IF bandwidth = 10 Hz, no averaging applied to data, environmental temperature = 23 °C (± 3 °C) with < 1 °C deviation from calibration temperature, isolation calibration performed

Description	Specification					
	9 k to 300 kHz	300 k to 10 MHz	10 M to 3 GHz	3 G to 6 GHz	6 G to 8.5 GHz	8.5 G to 9 GHz
Directivity	49	49	46	40	38	38
Source match	41	41	40	36	35	35
Load match	48	49	46	40	37	36
Reflection tracking	± 0.011	± 0.011	± 0.021	± 0.032	± 0.054	± 0.054
Transmission tracking	± 0.045	± 0.015	± 0.018	± 0.056	± 0.088	± 0.113

Transmission uncertainty (Specification)¹

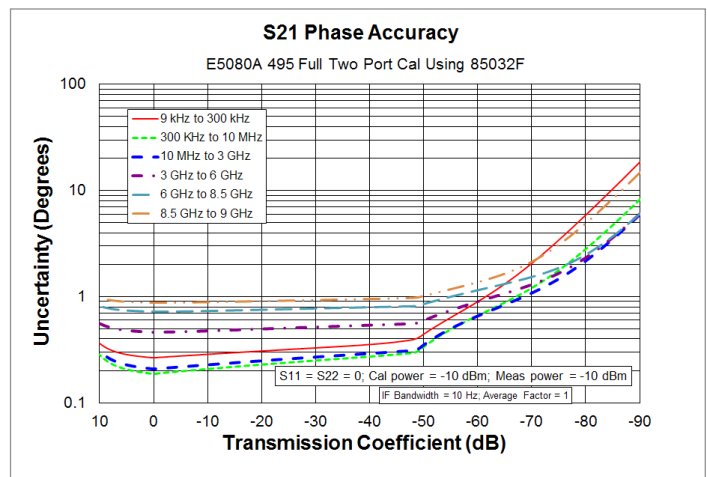
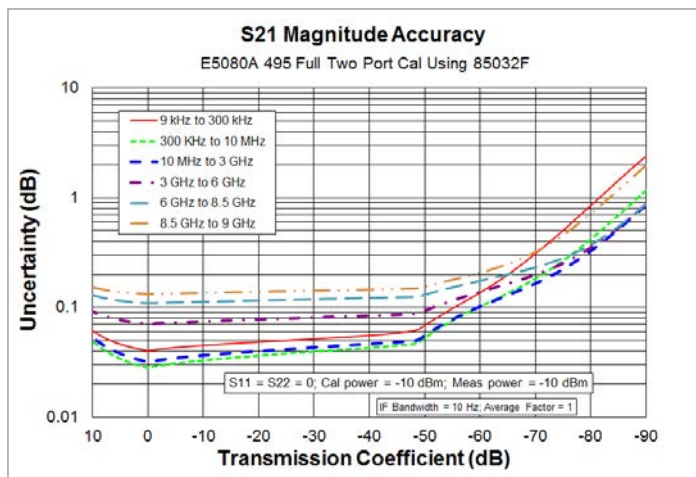

Reflection uncertainty (Specification)¹

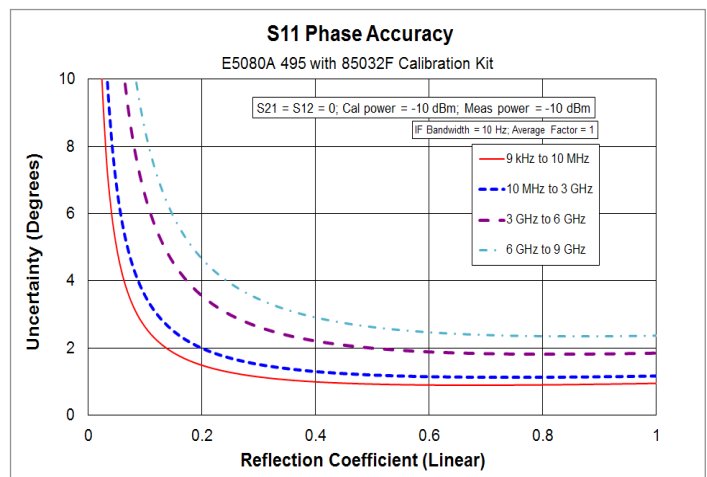
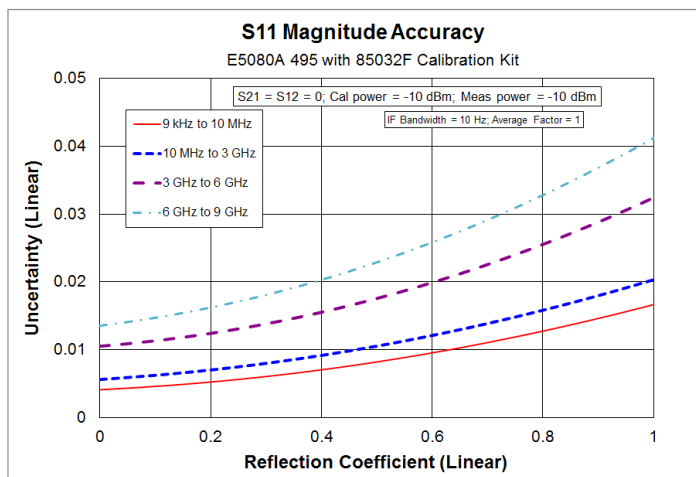

1. Applies to the units with Serial Number Prefix MY552/SG552 and above



Corrected system performance with type-N device connectors, 85092C electronic calibration (ECal) module

Network analyzer : E5080A
 Calibration kit : 85092C (Type-N, 50 Ω) Electronic calibration (ECal) module
 Calibration : full 2-port

IF bandwidth = 10 Hz, no averaging applied to data, environmental temperature = 23 °C (± 3 °C) with < 1 °C deviation from calibration temperature , isolation calibration is not performed

Description	Specification				
	300 k to 10 MHz	10 M to 3 GHz	3 G to 6 GHz	6 G to 8.5 GHz	8.5 G to 9 GHz
Directivity	45	52	49	45	45
Source match	36	44	41	36	36
Load match	37	45	41	38	38
Reflection tracking	± 0.1	± 0.04	± 0.06	± 0.07	± 0.07
Transmission tracking	± 0.082	± 0.050	± 0.102	± 0.157	± 0.169

Transmission uncertainty (Specification)¹

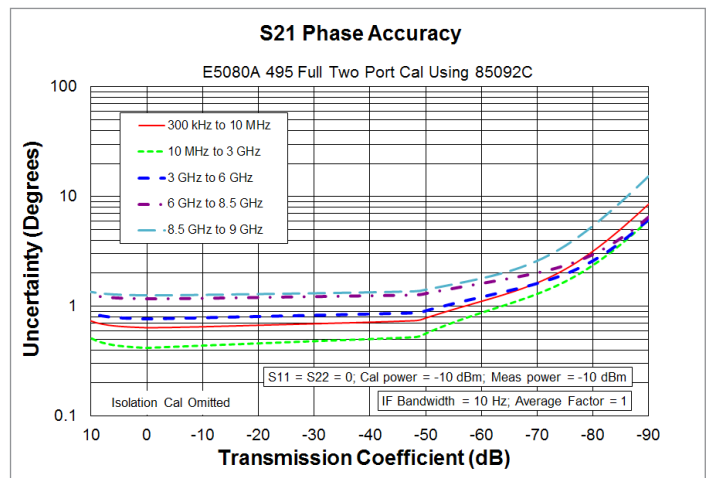
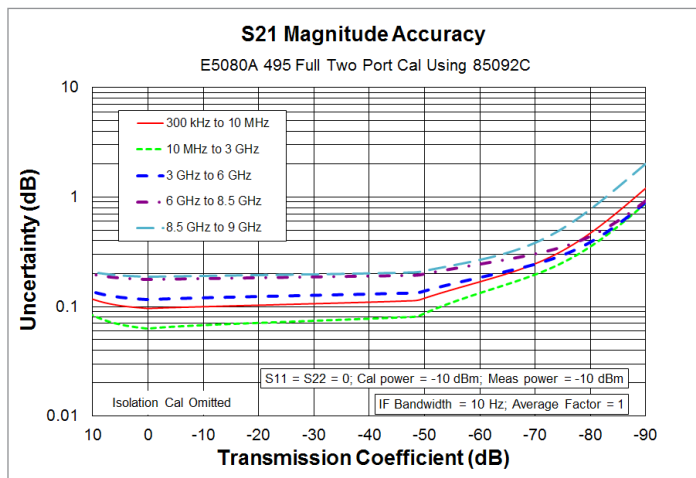

Reflection uncertainty (Specification)¹

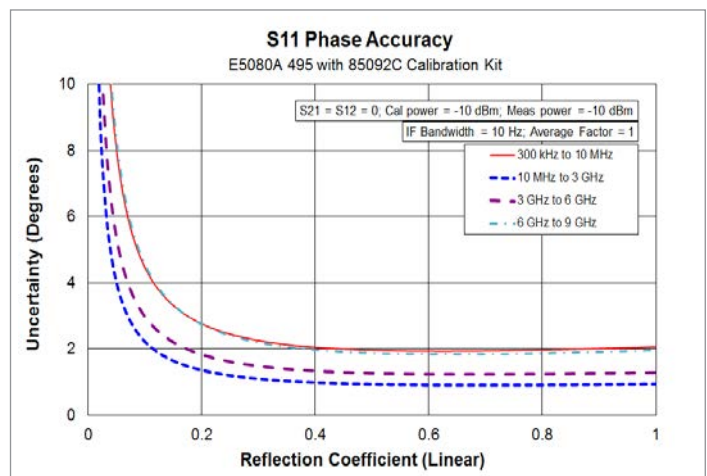
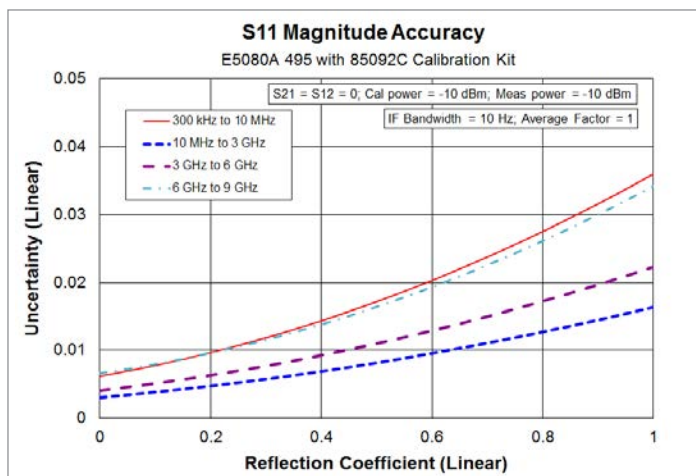

1. Applies to the units with Serial Number Prefix MY552/SG552 and above



Corrected system performance with 3.5 mm device connector type, 85033E calibration kit

Network analyzer : E5080A
 Calibration kit : 85033E (3.5 mm, 50 Ω)
 Calibration : full 2-port

IF bandwidth = 10 Hz, no averaging applied to data, environmental temperature = 23 °C (± 3 °C) with < 1 °C deviation from calibration temperature, isolation calibration performed

Description	Specification					
	9 k to 300 kHz	300 k to 10 MHz	10 M to 3 GHz	3 G to 6 GHz	6 G to 8.5 GHz	8.5 G to 9 GHz
Directivity	46	46	44	38	38	38
Source match	43	43	40	37	36	36
Load match	46	46	44	38	38	38
Reflection tracking	± 0.006	± 0.006	± 0.007	± 0.009	± 0.010	± 0.010
Transmission tracking	± 0.043	± 0.015	± 0.020	± 0.058	± 0.079	± 0.099

Transmission uncertainty (Specification)¹

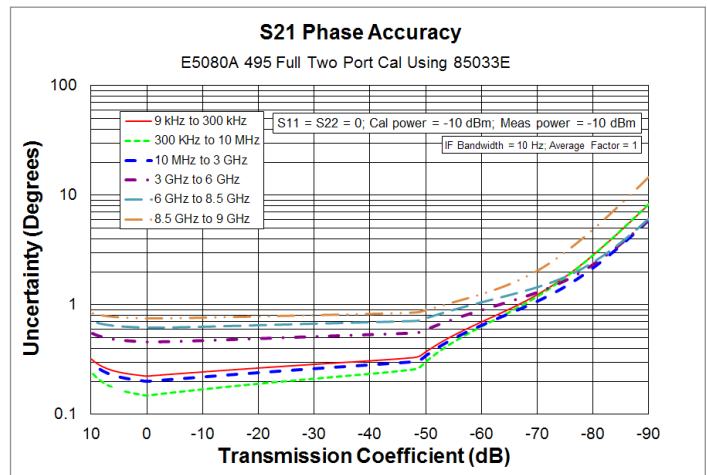
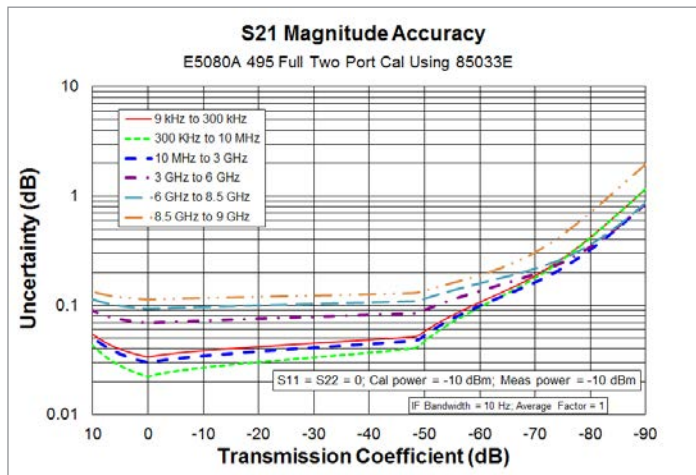

Reflection uncertainty (Specification)¹

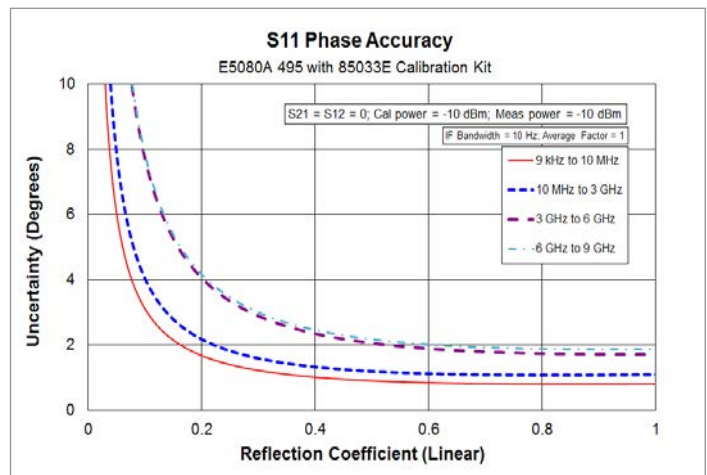
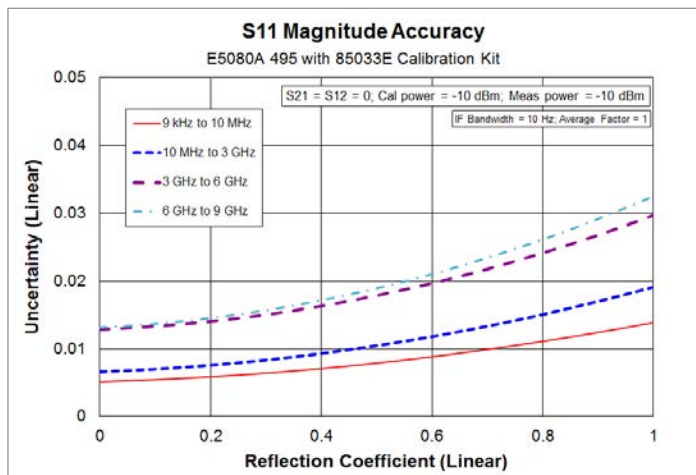

1. Applies to the units with Serial Number Prefix MY552/SG552 and above



Corrected system performance with 3.5 mm device connector type, 85093C electronic calibration (ECal) module

Network analyzer : E5080A
 Calibration kit : 85093C (3.5 mm, 50 Ω) Electronic calibration (ECal) module
 Calibration : full 2-port

IF bandwidth = 10 Hz, no averaging applied to data, environmental temperature = 23 °C (± 3 °C) with < 1 °C deviation from calibration temperature , isolation calibration is not performed

Description	Specification				
	300 k to 10 MHz	10 M to 3 GHz	3 G to 6 GHz	6 G to 8.5 GHz	8.5 G to 9 GHz
Directivity	45	52	50	47	47
Source match	36	44	39	34	34
Load match	37	45	42	40	39
Reflection tracking	± 0.1	± 0.04	± 0.05	± 0.07	± 0.07
Transmission tracking	± 0.086	± 0.045	± 0.094	± 0.143	± 0.154

Transmission uncertainty (Specification)¹

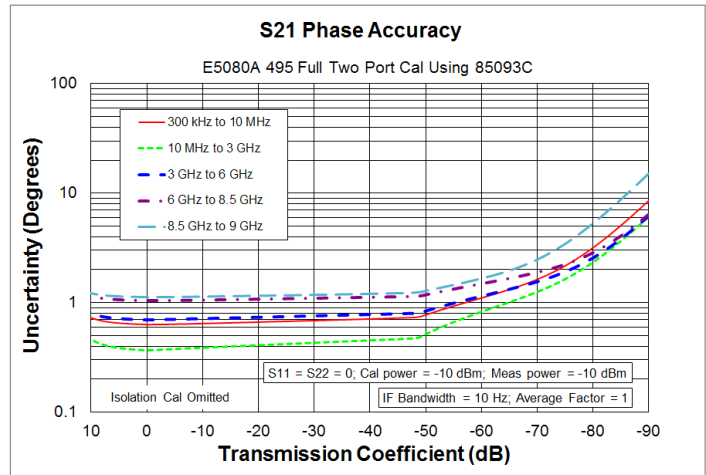
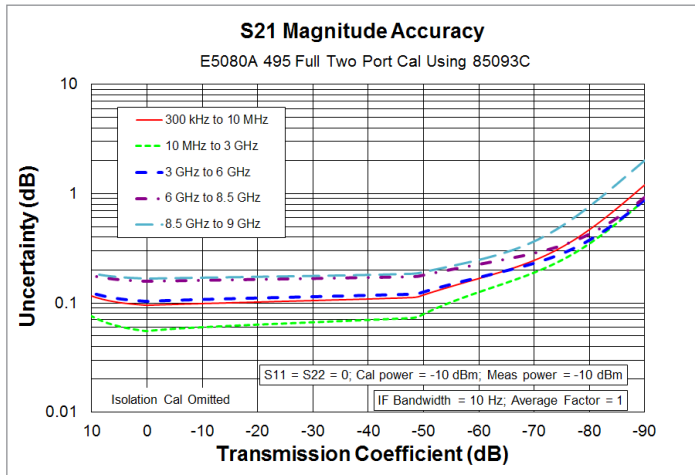

Reflection uncertainty (Specification)¹

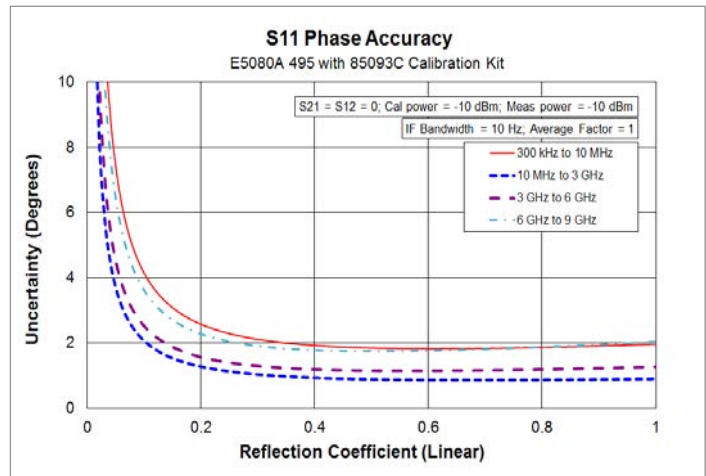
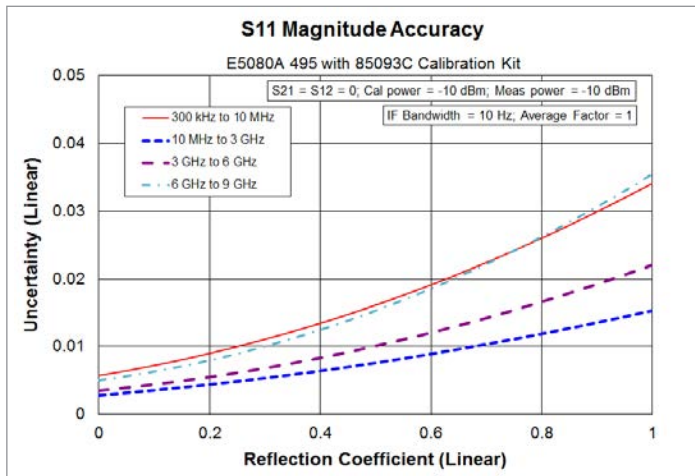

1. Applies to the units with Serial Number Prefix MY552/SG552 and above



Uncorrected System Performance

User correction: OFF, system error correction: ON

Description	Specification					
	9 k to 50 kHz	50 k to 300 kHz	300 k to 3 GHz	3 G to 6 GHz	6 G to 8.5 GHz	8.5 G to 9 GHz
Directivity	20	20	25	20	15	15
Source match	20	20	25	20	15	15
Load match	8	12	17	12	10	8

Description	Typical					
	9 k to 50 kHz	50 k to 300 kHz	300 k to 3 GHz	3 G to 6 GHz	6 G to 8.5 GHz	8.5 G to 9 GHz
Directivity	40	40	40	35	35	35
Source match	40	40	40	35	35	35
Load match	12	18	20	20	16	14
Transmission tracking	± 0.1	± 0.1	± 0.1	± 0.1	± 0.2	± 0.2
Reflection tracking	± 0.1	± 0.1	± 0.1	± 0.1	± 0.2	± 0.2

Description	Typical				
	9 k to 100 kHz	100 k to 50 MHz	50 M to 6 GHz	6 G to 8.5 GHz	8.5 G to 9 GHz
Crosstalk	132	141	147	140	130

Test Port Output (Source)

Test port output frequency

Description	Specification	Typical
Frequency range		
Option 245, 445	9 k to 4.5 GHz	
Option 265, 465	9 k to 6.5 GHz	
Option 295, 495	9 k to 9 GHz	
Resolution	1 Hz	
CW accuracy		
Standard	± 7 ppm (23 ± 3 °C)	± 3.0 ppm (25 ± 5 °C)
Option 1E5	± 0.45 ppm	
Source stability		
Standard		± 7 ppm (0 to 40 °C)
Option 1E5		± 0.05 ppm (0 to 40 °C) ± 0.4 ppm/year



Test port output power¹

Description	Specification	Typical
Nominal power (preset power)	0 dBm	
Range		
9 k to 100 kHz	-90 to 10 dBm	-110 to 12 dBm
100 k to 50 MHz	-90 to 12 dBm	-110 to 14 dBm
50 M to 6 GHz	-90 to 15 dBm	-110 to 17 dBm
6 G to 8.5 GHz	-90 to 12 dBm	-110 to 14 dBm
8.5 G to 9 GHz	-90 to 8 dBm	-110 to 12 dBm
Max leveled power		
9 k to 100 kHz	10 dBm	12 dBm
100 k to 50 MHz	12 dBm	14 dBm
50 M to 6 GHz	15 dBm	17 dBm
6 G to 8.5 GHz	12 dBm	14 dBm
8.5 G to 9 GHz	8 dBm	12 dBm
Resolution	0.01 dB	
Level accuracy²		
Sweep type: stepped		
9 k to 50 kHz	± 2.0 dB	
50 k to 9 GHz	± 1.5 dB	
Sweep type: auto		
9 k to 9 GHz		± 2.0 dB
Level linearity		
-20 dBm to maximum power		
Sweep type: stepped	± 0.75 dB	
Sweep type: auto		± 1.0 dB
-110 dBm to -20 dBm		± 1.0 dB
Power sweep range		
9 k to 100 kHz	-90 to 10 dBm	
100 k to 50 MHz	-90 to 12 dBm	
50 M to 6GHz	-90 to 15 dBm	
6 G to 8.5 GHz	-90 to 12 dBm	
8.5 G to 9 GHz	-90 to 8 dBm	

Test port output signal purity

Description	Specification	Typical
Harmonics (2nd or 3rd) (at 0 dBm)		
9 k to 2 GHz		< -25 dBc
2 G to 9 GHz		< -20 dBc
Non-harmonic spurious (at 0 dBm)		< -30 dBc

1. Source output performance on all ports.
2. Power calibration using an external power meter improves level accuracy of the test port output power.
3. Level linearity given is relative to 0 dBm.



Test Port Input

Description	Specification	Typical
Test port noise floor¹		
9 k to 100 kHz	-120 dBm	-130 dBm
100 k to 50 MHz	-127 dBm	-137 dBm
50 M to 6 GHz	-130 dBm	-140 dBm
6 G to 8.5 GHz	-130 dBm	-136 dBm
8.5 G to 9 GHz	-122 dBm	-128 dBm
Compression level (@+10dBm input)		
Magnitude		
9 k to 6 GHz	0.207 dB	0.04 dB
6 G to 9 GHz	0.207 dB	0.08 dB
Phase		
9 k to 6 GHz	0.503 deg	0.3 deg
6 G to 9 GHz	0.503 deg	0.6 deg
0.1 dB compression input level		
9 k to 100 k		10 dBm
100 k to 50 MHz		12 dBm
50 M to 6 GHz		15 dBm
6 G to 8.5 GHz		12 dBm
8.5 G to 9 GHz		10 dBm

1. IFBW=1 Hz, FOM is off.



Trace noise

Description	Specification	Typical
(test port input level = maximum power in Specification)		
Magnitude		
(Transmission)		
9 k to 30 kHz, 1 kHz IFBW	0.003 dBrms	0.001 dBrms
30 k to 10 MHz, 1 kHz IFBW	0.0015 dBrms	0.0005 dBrms
10 M to 6 GHz, 10 kHz IFBW	0.0015 dBrms	0.0005 dBrms
6 G to 9 GHz, 10 kHz IFBW	0.002 dBrms	0.0006 dBrms
(Reflection)		
9 k to 30 kHz, 1 kHz IFBW	0.004 dBrms	0.002 dBrms
30 k to 10 MHz, 1 kHz IFBW	0.003 dBrms	0.001 dBrms
10 M to 1.5 GHz, 10 kHz IFBW	0.003 dBrms	0.001 dBrms
1.5 G to 6 GHz, 10 kHz IFBW	0.0015 dBrms	0.0005 dBrms
6 GHz to 9 GHz, 10 kHz IFBW	0.002 dBrms	0.0006 dBrms
Phase		
(Transmission)		
9 k to 30 kHz, 1 kHz IFBW	0.03 degrms	0.015 degrms
30 k to 100 kHz, 1 kHz IFBW	0.02 degrms	0.008 degrms
100 k to 10 MHz, 1 kHz IFBW	0.01 degrms	0.003 degrms
10 M to 6 GHz, 10 kHz IFBW	0.01 degrms	0.003 degrms
6 GHz to 9 GHz, 10 kHz IFBW	0.02 degrms	0.006 degrms
(Reflection)		
9 k to 30 kHz, 1 kHz IFBW	0.06 degrms	0.02 degrms
30 k to 100 kHz, 1 kHz IFBW	0.035 degrms	0.01 degrms
100 k to 10 MHz, 1 kHz IFBW	0.02 degrms	0.005 degrms
10 M to 1.5 GHz, 10 kHz IFBW	0.02 degrms	0.005 degrms
1.5 G to 6 GHz, 10 kHz IFBW	0.01 degrms	0.003 degrms
6 GHz to 9 GHz, 10 kHz IFBW	0.02 degrms	0.006 degrms

Stability

Description	Specification	Typical
Magnitude		
9 k to 3 GHz		± 0.005 dB/°C
3 G to 6 GHz		± 0.01 dB/°C
6 G to 9 GHz		± 0.04 dB/°C
Phase		
9 k to 3 GHz		± 0.1 deg/°C
3 G to 6 GHz		± 0.2 deg/°C
6 G to 9 GHz		± 0.8 deg/°C



Dynamic accuracy^{1,2}

Description	Specification	Typical
Magnitude		
10 dBm	± 0.207 dB	
5 dBm	± 0.071 dB	
0 dBm	± 0.027 dB	
-5 dBm	± 0.012 dB	
-10 dBm (Ref.)	± 0.006 dB	
-15 dBm	± 0.009 dB	
-20 dBm	± 0.011 dB	
-30 dBm	± 0.014 dB	
-40 dBm	± 0.018 dB	
-50 dBm	± 0.021 dB	
-60 dBm	± 0.029 dB	
-70 dBm	± 0.072 dB	
-80 dBm	± 0.116 dB	
-90 dBm	± 0.159 dB	
-100 dBm	± 0.202 dB	
Phase		
10 dBm	± 5.02 deg	
5 dBm	± 0.67 deg	
0 dBm	± 0.14 deg	
-5 dBm	± 0.06 deg	
-10 dBm (Ref.)	± 0.04 deg	
-15 dBm	± 0.05 deg	
-20 dBm	± 0.06 deg	
-30 dBm	± 0.08 deg	
-40 dBm	± 0.10 deg	
-50 dBm	± 0.13 deg	
-60 dBm	± 0.18 deg	
-70 dBm	± 0.47 deg	
-80 dBm	± 0.76 deg	
-90 dBm	± 1.05 deg	
-100 dBm	± 1.34 deg	

1. Accuracy of the test port input power reading is relative to -10 dBm reference input power level. IFBW is equal to or lower than 10 Hz. Refer to Uncertainty Calculator from (http://www.keysight.com/find/na_calculator) for IFBW above 10 Hz.
2. Applies to the units with Serial Number Prefix MY552/SG552 and above.

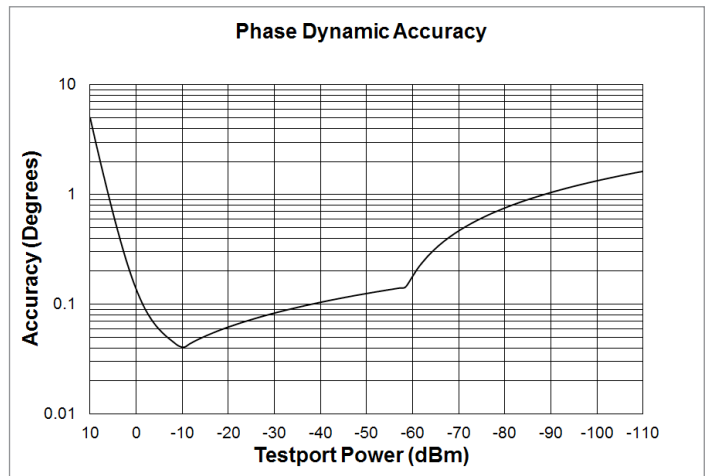
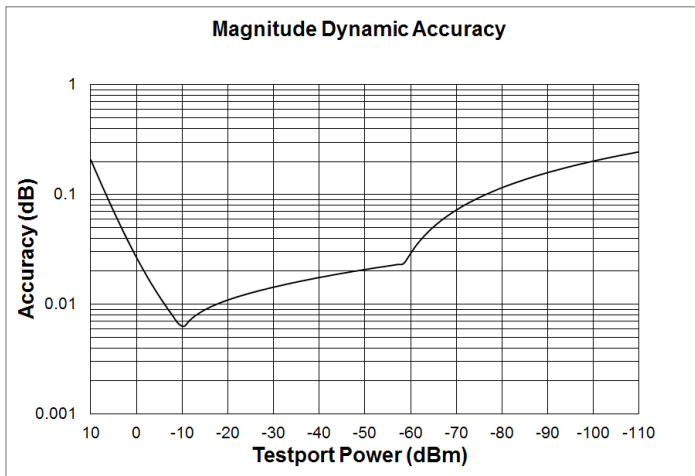

Group delay¹

Description	Specification	Typical
Aperture (selectable)	(frequency span)/(number of points - 1)	
Maximum aperture	25% of frequency span	
Minimum delay		Limited to measuring no more than 180° of phase change within the minimum aperture.
Accuracy		See graph below (typical)

1. Group delay is computed by measuring the phase change within a specified step (determined by the frequency span and the number of points per sweep).

The following graph shows group delay accuracy with type-N connectors, full 2-port calibration and a 10 Hz IF bandwidth.

- Calibration kit (85032F).
- Insertion loss is assumed to be < 2 dB.

In general, the following formula can be used to determine the accuracy, in seconds, of a specific group delay measurement:

$$\pm \text{phase accuracy (degrees)} / [360 \times \text{aperture (Hz)}]$$

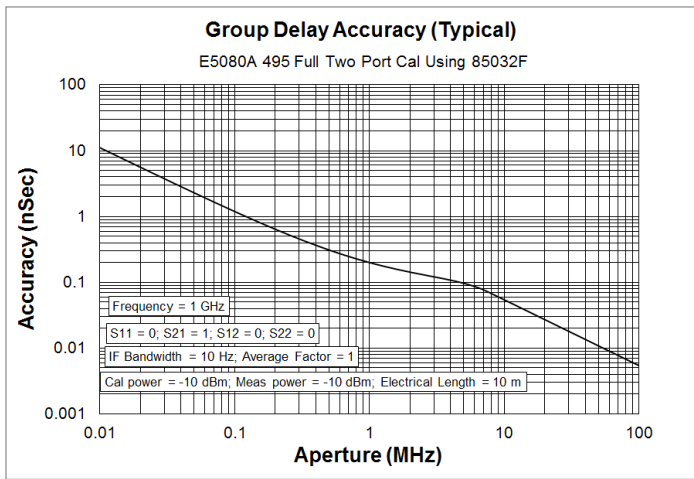

General Information

Description	General characteristics
IF band width Range	1 Hz to 1.5 MHz Nominal settings are: 1, 2, 3, 4, 5, 7, 10, 15, 20, 30, 40, 50, 70, 100, 150, 200, 300, 400, 500, 700, 1 k, 1.5 k, 2 k, 3 k, 4 k, 5 k, 7 k, 10 k, 15 k, 20 k, 30 k, 40 k, 50 k, 70 k, 100 k, 150 k, 200 k, 300 k, 400 k, 500 k, 700 k, 1M, 1.5 M
Number of points per traces	1 to 100,001 ¹

Front panel

Description	Typical	General characteristics
Test Ports		Type -N, female, 50 Ω (nominal)
Damage Level		+27dBm or \pm 35 VDC (warranted)
Display Type Resolution		12.1 inch TFT color LCD with touch screen WXGA (1280 x 800) ²
USB host port		Universal serial bus jack, Type A configuration; female; provides connection to mouse, key board, printer, ECal module, USB power sensor, or USB/GPIB interface

Rear panel

Description	Typical	General characteristics
External trigger input connector Type Input level Pulse width Polarity		BNC, female Low threshold voltage: 0.5 V High threshold voltage: 2.1 V Input level range: 0 to + 5 V \geq 2 μ sec Positive or negative
External trigger output connector Type Maximum output current Output level Pulse width Polarity		BNC, female 50 mA Low level voltage: 0 V High level voltage: 5 V 1 μ sec Positive or negative
External reference signal input connector Type Input frequency Input level Input impedance		BNC, female 10 MHz \pm 10 ppm -3 to +10 dBm 50 Ω
Internal reference signal output connector Type Output frequency Signal Type Output level Output Impedance	10 MHz \pm 7 ppm Sinewave 0 dBm \pm 3 dB into 50 Ω	BNC, female 50 Ω

1. Applied for Standard Measurement Class. The maximum number varies according to Measurement Class setup.

2. Valid pixels are 99.99% and more. Below 0.02% of fixed points of black, blue, green or red are not regarded as failure.









Description	Typical	General characteristics
Internal reference signal oven connector (option 1E5)		
Type		BNC, female
Output frequency	10 MHz \pm 0.45 ppm	
Output level	0 dBm minimum	
Bias tee input connector		
Type		BNC, female
Damage level	\pm 35 V, 500 mA DC	
Max. current (no degradation in RF specifications)	\pm 300 mA at 100 kHz to 9 GHz	
Over current protection	500 mA (with Fuse)	
Video output		15-pin mini D-Sub; female; drives WXGA compatible monitors
GPIB		24-pin D-Sub (Type D-24), female; compatible with IEEE-488
USB host port		Universal serial bus jack, Type A configuration; female; provides connection to mouse, key board, printer, ECal module, USB power sensor, or USB/GPIB interface
USB (USBTMC¹) interface port		Universal serial bus jack, Type B configuration (4 contacts inline); female; provides connection to an external PC; compatible with USBTMC-USB488 and USB 2.0.LA
LAN		10/100BaseT Ethernet, 8-pin configuration; auto selects between the two data rates
Handler I/O port		36-pin centronics, female; provides connection to handler system
Line power²		
Frequency		47 Hz to 63 Hz
Power consumption ³	2-port: 135 W 4-port: 165 W	
Voltage		90-264 VAC ($V_{peak} > 120$ V)
VA max		300 VA max.

1. USB Test and Measurement Class (TMC) interface that communicates over USB, complying with the IEEE 488.1 and IEEE 488.2 standards.
2. A third-wire ground is required.
3. At preset.

Description	Specification	Typical
AUX input connector		
Type		BNC, female x 2 ports
Input range		\pm 1 V or \pm 10 V selectable
Accuracy	1 % \pm 1 mV for 1 V input range 1 % \pm 10 mV for 10 V input range	



EMC, safety, environment and compliance

Description	General characteristics
EMC	
 ISM 1-A	European Council Directive 2004/108/EC IEC 61326-1:2012 EN 61326-1:2013 CISPR 11:2009 +A1:2010 EN 55011: 2009 +A1:2010 Group 1, Class A IEC 61000-4-2:2008 EN 61000-4-2:2009 4 kV CD / 8 kV AD IEC 61000-4-3:2006 +A1:2007 +A2:2010 EN 61000-4-3:2006 +A1:2008 +A2:2010 3 V/m, 80-1000 MHz, 1.4 - 2.0 GHz /1V/m, 2.0 - 2.7 GHz, 80% AM IEC 61000-4-4:2004 +A1:2010 EN 61000-4-4:2004 +A1:2010 1 kV power lines / 0.5 kV signal lines IEC 61000-4-5:2005 EN 61000-4-5:2006 0.5 kV line-line / 1 kV line-ground IEC 61000-4-6:2008 EN 61000-4-6:2009 3 V, 0.15-80 MHz, 80% AM IEC 61000-4-8:2009 EN 61000-4-8:2010 30A/m, 50/60Hz IEC 61000-4-11:2004 EN 61000-4-11:2004 0.5-300 cycle, 0% / 70%
ICES/NMB-001	ICES-001:2006 Group 1, Class A
	AS/NZS CISPR11:2004 Group 1, Class A
 MSIP-REM-Kst- WNMODSF36	KN11, KN61000-6-1 and KN61000-6-2 Group 1, Class A
Safety	
 ISM 1-A	European Council Directive 2006/95/EC IEC 61010-1:2001/EN 61010-1:2001 Measurement Category I Pollution Degree 2 Indoor Use
 C US	CAN/CSA C22.2 No. 61010-1-12 Measurement Category I Pollution Degree 2 Indoor Use
Environment	
	This product complies with the WEEE Directive (2002/96/EC) marking requirements. The affixed label indicates that you must not discard this electrical/electronic product in domestic household waste. Product Category: With reference to the equipment types in the WEEE Directive Annex I, this product is classed as a "Monitoring and Control instrumentation" product. Do not dispose in domestic household waste. To return unwanted products, contact your local Keysight office, or see http://www.keysight.com/environment/product/ for more information.
Compliance	
	Class C



Analyzer environmental specifications and dimensions

Description	General characteristics
Operating environment	
Temperature	0 °C to +40 °C
Error-corrected temperature range	23 °C (± 3 °C) with < 1 °C deviation from calibration temperature
Humidity	20% to 80 % at wet bulb temperature < +29 °C (non-condensation)
Altitude	0 to 2,000 m (0 to 6561 feet)
Vibration	0.21 G maximum, 5 Hz to 500 Hz
Non-operating environment	
Temperature	-10 °C to +60 °C
Humidity	20 % to 90 % at wet bulb temperature < +40 °C (non-condensation)
Altitude	0 to 4,572 m (0 to 15,000 feet)
Vibration	0.5 G maximum, 5 Hz to 500 Hz
Weight (net)	Option 245/265/295: 20.3 kg Option 445/465/495: 22.7 kg

Dimensions

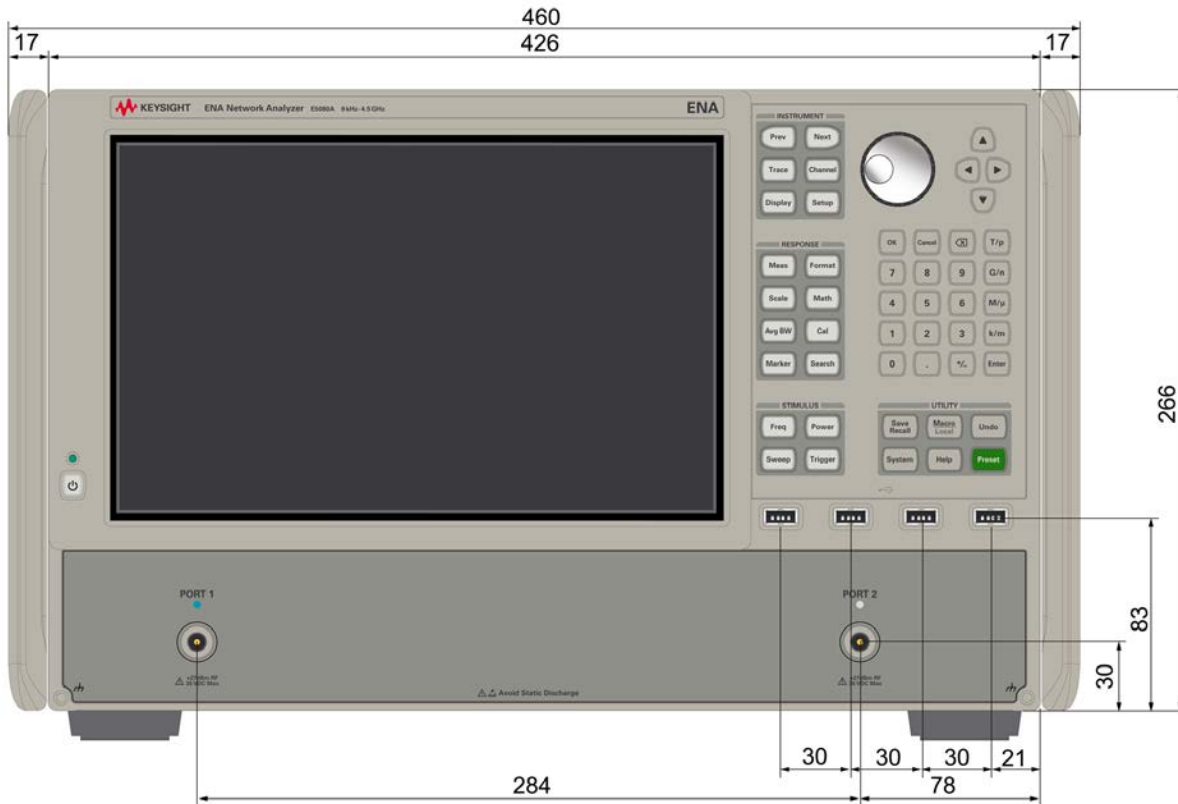

Dimensions (front view, E5080A with option 245/265/295, in millimeters)



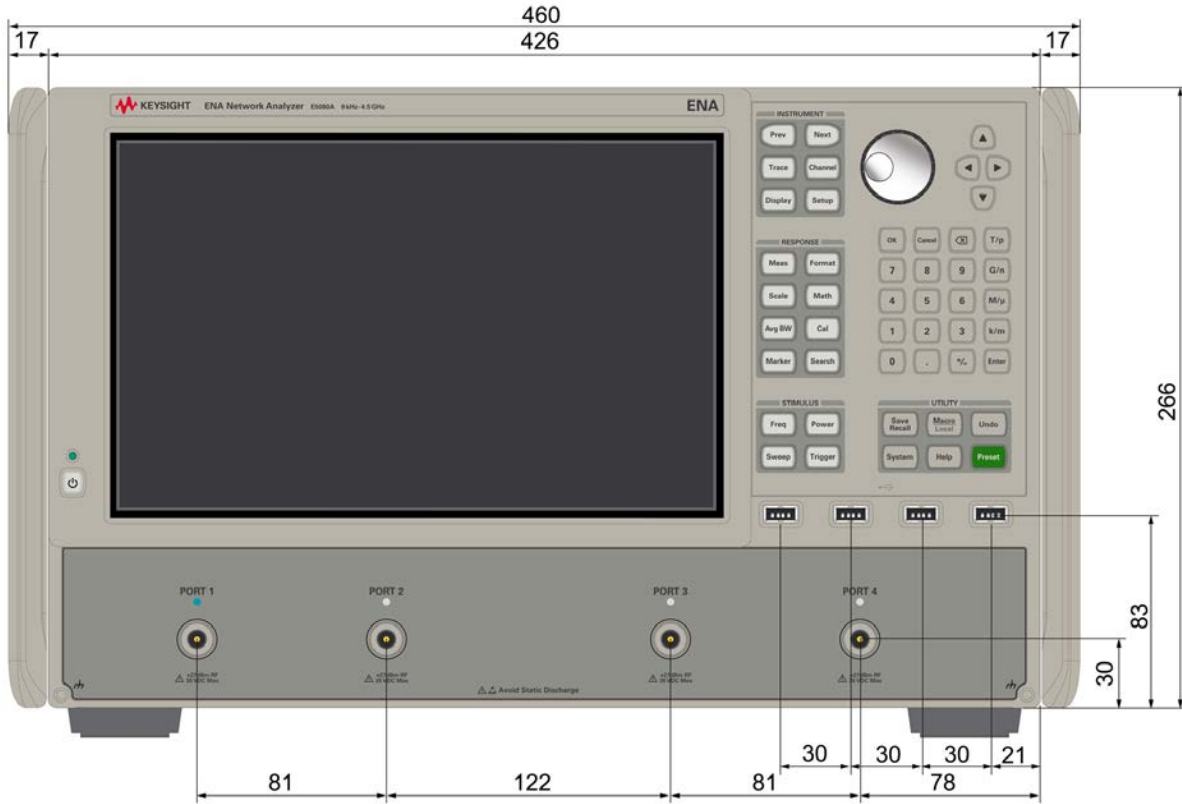

Dimensions (front view, E5080A with option 445/465/495, in millimeters)

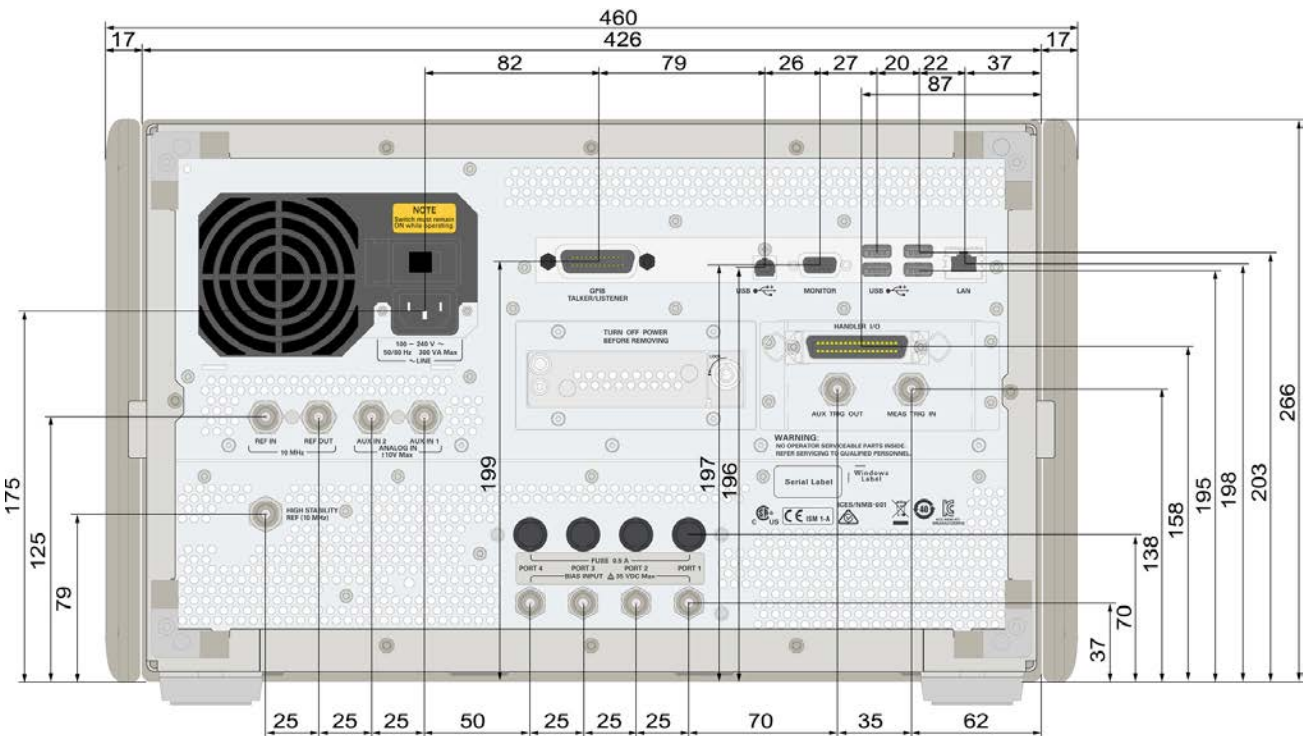

Dimensions (rear view with option 1E5, in millimeters)



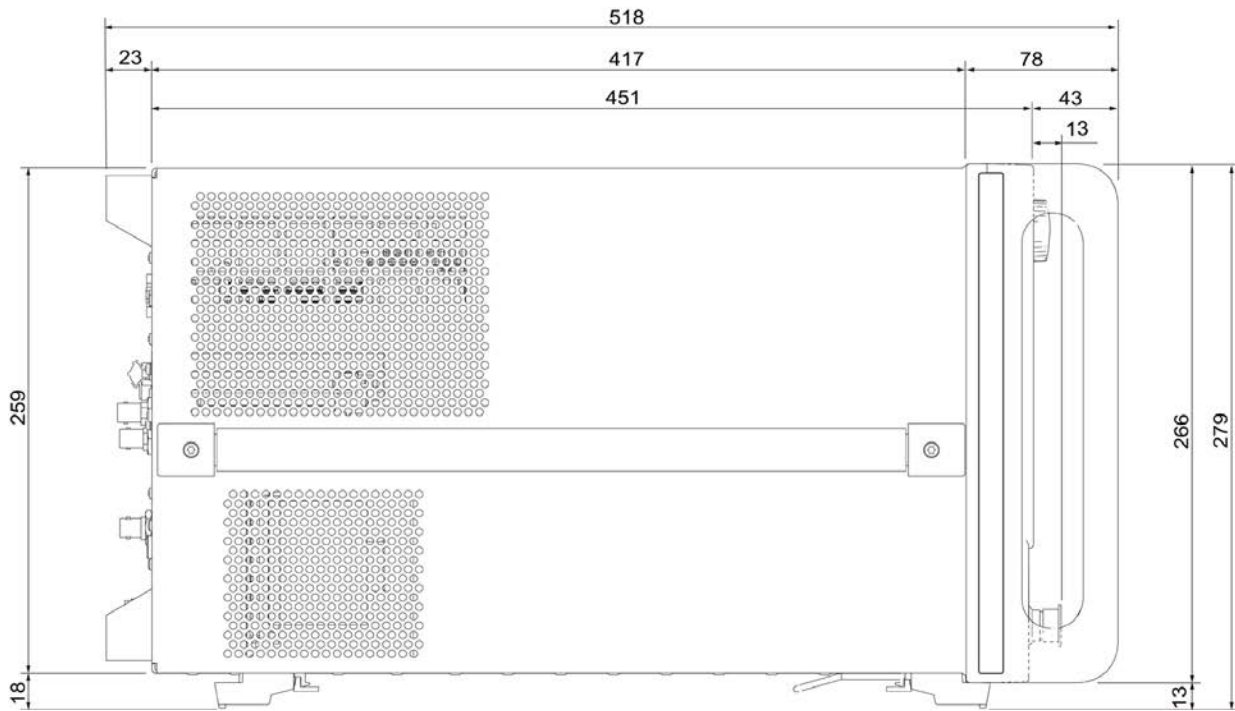

Dimensions (rear view with option 1E5, in millimeters)

Measurement Throughput Summary

Measurement throughput data is supplemental performance data.
Common condition for the measurement throughput data:

- Analyzer display turned off with: DISPlay:ENABle OFF, DISPlay:VISible OFF
- Number of traces = 1
- firmware version: A.11.00

Cycle time for measurement completion

	Sweep type: Auto System error correction: OFF				Sweep type: Stepped System error correction: ON			
	Number of Points							
	51	201	401	1601	51	201	401	1601
Start 800 MHz, stop 1 GHz, 500 kHz IF bandwidth								
Uncorrected	1.3	1.8	2.5	7.0	1.5	2.8	4.3	13
2-port cal	2.2	3.0	5.2	17	2.6	5.1	8.2	24
4-port cal	4.0	6.2	12	31	4.7	11	18	51
Start 800 MHz, stop 1 GHz, 1 kHz IF bandwidth								
Uncorrected	51	196	389	1546	51	196	389	1546
2-port cal	101	391	777	3092	101	391	777	3092
4-port cal	201	781	1554	6187	201	781	1554	6187
Start 100 kHz, stop 4.5 GHz, 500 kHz IF bandwidth								
Uncorrected	3.1	5.4	7.7	12	3.1	5.4	7.8	20
2-port cal	5.7	11	15	24	5.8	11	15	39
4-port cal	11	21	31	50	11	21	31	81

Unit: ms



Start 100 kHz, stop 4.5 GHz, 1 kHz IF bandwidth								
Uncorrected	53	199	393	1554	53	199	393	1554
2-port cal	104	396	784	3107	104	396	784	3107
4-port cal	207	792	1569	6217	207	792	1569	6217
Start 100 kHz, stop 9 GHz, 500 kHz IF bandwidth								
Uncorrected	3.8	6.1	8.4	18	3.8	6.1	8.4	20
2-port cal	7.0	12	17	35	7.0	12	17	40
4-port cal	14	23	33	73	14	23	34	83
Start 100 kHz, stop 9 GHz, 1 kHz IF bandwidth								
Uncorrected	53	199	393	1554	53	199	393	1554
2-port cal	105	397	785	3108	105	397	785	3108
4-port cal	210	794	1571	6219	210	794	1571	6219

Unit: ms

Cycle time vs. number of points

Condition: Start = 800 MHz, Stop = 1 GHz, 500 kHz IF bandwidth

Number of points	Sweep type: Auto System error correction: OFF	Sweep type: Stepped System error correction: ON
3	1.1	1.0
11	1.1	1.1
51	1.3	1.5
101	1.4	2.0
201	1.8	2.8
401	2.5	4.3
801	3.9	7.0
1601	7.0	13

Unit: ms

Cycle time vs. IF bandwidth

Condition: Frequency = 4 GHz, NOP = 201, system error correction: OFF

IF BW (Hz)	Cycle time (ms)	IF BW (Hz)	Cycle time (ms)	IF BW (Hz)	Cycle time (ms)	IF BW (Hz)	Cycle time (ms)	IF BW (Hz)	Cycle time (ms)	IF BW (Hz)	Cycle time (ms)
10	19299	100	1932	1000	195	10000	21	100000	3.1	1000000	1.8
15	12867	150	1288	1500	131	15000	14	150000	2.4	1500000	1.8
20	9651	200	967	2000	98	20000	11	200000	2.1		
30	6434	300	645	3000	66	30000	7.6	300000	1.9		
40	4826	400	484	4000	50	40000	6.0	400000	1.8		
50	3861	500	388	5000	40	50000	5.0	500000	1.8		
70	2736	700	275	7000	29	70000	3.9	700000	1.8		



Data transfer time (ms)¹

	Number of Points			
	51	201	401	1601
SCPI over GPIB²				
64-bit floating point	2.7	6.8	13	45
32-bit floating point	1.9	4.0	6.8	23
ASCII	6.1	21	37	143
SCPI over 1 Gbps LAN (Socket)²				
REAL 64	1.4	1.4	1.4	2.0
REAL 32	1.4	1.4	1.4	1.6
ASCII	4.3	13	23	86
SCPI over 1 Gbps LAN (SICL-LAN)²				
REAL 64	1.9	1.8	1.8	2.6
REAL 32	2.0	1.9	1.9	2.1
ASCII	2.8	4.3	6.4	20
SCPI over USB (SICL-USB)²				
REAL 64	2.3	2.5	2.5	3.0
REAL 32	2.3	2.3	2.5	2.7
ASCII	2.3	5.2	8.2	28
SCPI over GPIB/USB (82357B)				
REAL 64	5.9	9.5	15	44
REAL 32	5.3	7.1	9.6	25
ASCII	36	133	265	1061

1. Supplemental performance data. Data transfer time varies depending on the type of PC and control software.
2. Transferred LogMag S11 data, using :CALC{ch}:MEAS{tr}:DATA:FDAT?.



E5092A Configurable multiport test set

The section provides test input/output performance without calibration by the E5080A.

Table 46. Test set input/output performance

Description	Specification	Typical
Frequency range	50 MHz to 20 GHz	
Damage level		20 dBm, \pm 35 VDC

Table 47. Option E5092A-020 port performance

Description	Specification	Typical
Load match (selected port)		
SPDT switch¹		
50 MHz to 2 GHz	17 dB	
2 GHz to 4 GHz	11 dB	
4 GHz to 8 GHz	8 dB	
8 GHz to 10 GHz	7 dB	
10 GHz to 18 GHz	4 dB	
18 GHz to 20 GHz	4 dB	
SP4T switch²		
50 MHz to 2 GHz	17 dB	
2 GHz to 3 GHz	11 dB	
3 GHz to 8 GHz	8 dB	
8 GHz to 10 GHz	7 dB	
10 GHz to 18 GHz	4 dB	
18 GHz to 20 GHz	4 dB	
Load match (unselected port)		
SPDT switch¹		
50 MHz to 3 GHz	17 dB	
3 GHz to 10 GHz	11 dB	
10 GHz to 16 GHz	8 dB	
16 GHz to 18 GHz	6 dB	
18 GHz to 20 GHz	4 dB	
SP4T switch²		
50 MHz to 3 GHz	17 dB	
3 GHz to 10 GHz	11 dB	
10 GHz to 16 GHz	8 dB	
16 GHz to 18 GHz	6 dB	
18 GHz to 20 GHz	4 dB	
Load match (common port)		
SPDT switch¹		
50 MHz to 2 GHz	16 dB	
2 GHz to 4 GHz	11 dB	
4 GHz to 8 GHz	8 dB	
8 GHz to 10 GHz	7 dB	
10 GHz to 20 GHz	4 dB	
SP4T switch²		
50 MHz to 1.3 GHz	16 dB	
1.3 GHz to 4 GHz	11 dB	
4 GHz to 8 GHz	8 dB	
8 GHz to 10 GHz	7 dB	
10 GHz to 20 GHz	4 dB	

1. SPDT: Single-pole-double-throw switches. Applies to SW5, SW6, SW7, SW8, SW9 and SW10 in the E5092A. (See Figure 20.)

2. SP4T: Single-pole-four-throw switches. Applies to SW1, SW2, SW3 and SW4 in the E5092A. (See Figure 20.)



Table 48. Option E5092A-020 port performance (continued)

Description	Specification	Typical
Insertion loss		
SPDT switch¹		
50 MHz to 100 MHz	4 dB	
100 MHz to 2 GHz	3.5 dB	
2 GHz to 3 GHz	4.5 dB	
3 GHz to 4 GHz	5 dB	
4 GHz to 6 GHz	5.5 dB	
6 GHz to 8 GHz	7 dB	
8 GHz to 10 GHz	8 dB	
10 GHz to 14 GHz	8.5 dB	
14 GHz to 18 GHz	10 dB	
18 GHz to 20 GHz	11.5 dB	
SP4T switch²		
50 to 100 MHz	4 dB	
100 MHz to 2 GHz	3.5 dB	
2 GHz to 3 GHz	4.5 dB	
3 GHz to 4 GHz	5.5 dB	
4 GHz to 6 GHz	6 dB	
6 GHz to 8 GHz	7.5 dB	
8 GHz to 10 GHz	8.5 dB	
10 GHz to 14 GHz	9.5 dB	
14 GHz to 18 GHz	10.5 dB	
18 GHz to 20 GHz	12 dB	
Stability per switch		
Condition: Environment Temperature +23 °C ± 3 °C and Internal DC source: ≤ 100 mA (Sum of 4 channels), no heat source and no wall close to the unit.		
50 M to 4 GHz		0.003 dB/°C (SPD)
4 G to 12 GHz		0.005 dB/°C (SPD)
12 G to 20 GHz		0.008 dB/°C (SPD)
Condition: besides the above		
50 M to 4 GHz		0.007 dB/°C (SPD)
4 G to 12 GHz		0.012 dB/°C (SPD)
12 G to 20 GHz		0.017 dB/°C (SPD)
Isolation³		
50 MHz to 500 MHz	65 dB	
500 MHz to 1 GHz	80 dB	
1 GHz to 2 GHz	85 dB	
2 GHz to 6 GHz	90 dB	
6 GHz to 10 GHz	85 dB	
10 GHz to 18 GHz	75 dB	
18 GHz to 20 GHz	65 dB (Over arbitrarily test ports)	

1. SPDT: Single-pole-double-throw switches. Applies to SW5, SW6, SW7, SW8, SW9 and SW10 in the E5092A. (See Figure 20.)
2. SP4T: Single-pole-four-throw switches. Applies to SW1, SW2, SW3 and SW4 in the E5092A. (See Figure 20.)
3. This specification is defined when all ports are terminated with a 50 ohm load.



Table 49. Control line

Description	Specification	Typical
Number of groups	4 Group A: 8 bits Group B,C,D: 4 bits	
Input voltage range ¹	0 V to +5 V (positive input) –5 V to 0 V (negative input)	
Maximum current	Group A, B: 50 mA in total of each group Group C, D: 500 uA in total of each group	
Impedance		Group A, B: < 10 ohm Group C, D: < 200 ohm

Table 50. DC source

Description	Specification	Typical
Number of sources	4	
Output voltage range		0 V to +5.2 V (nominal) ²
Output voltage accuracy	± 3 % of setting (+1 V to +5 V) at 1 M ohm load impedance	
Voltage resolution		10 mV (nominal) ³
Maximum current	150 mA for each source	
Output impedance		< 5 ohm

Table 51. Operating storage environment

Description	General characteristics
Temperature	+5 °C to +40 °C
Humidity	20 to 80 % at wet bulb temperature < +29 °C (non-condensing)
Altitude	0 to 2,000m (0 to 6,561 feet)
Vibration	0.21 G max., 5 to 500 Hz

Table 52. Non-operating storage environment

Description	General characteristics
Temperature	–10 °C to +60 °C
Humidity	20 to 90 % at wet bulb temperature < +40 °C (non-condensing)
Altitude	0 to 4,572 m (0 to 15,000 feet)
Vibration	0.5 G max., 5 Hz to 500 Hz

Table 53. Front panel information

Description	General characteristics
RF connectors	SMA (female)
Test ports	38 ports
Control line	15-pin D-sub, female 25-pin D-sub, female

1. Input voltage will be clipped at about ± 5.2 V when over this range.
2. The output voltage can be set in this range.
3. The output voltage resolution becomes effective between 0 V to 5.2 V.



Table 54. Rear panel information

Description	General characteristics
USB port	Type B-receptacle, provide connection to the E5080A
Line power ¹	
Frequency	47 to 63 Hz
Voltage	90 to 132 VAC, or 198 to 264 VAC (automatically switched)
VA max	300 VA max.

1. 1A third-wire ground is required.

Table 55. Test set dimensions and block diagram

Description	General characteristics
Weight	
E5092A Option 020	9 kg

Dimensions

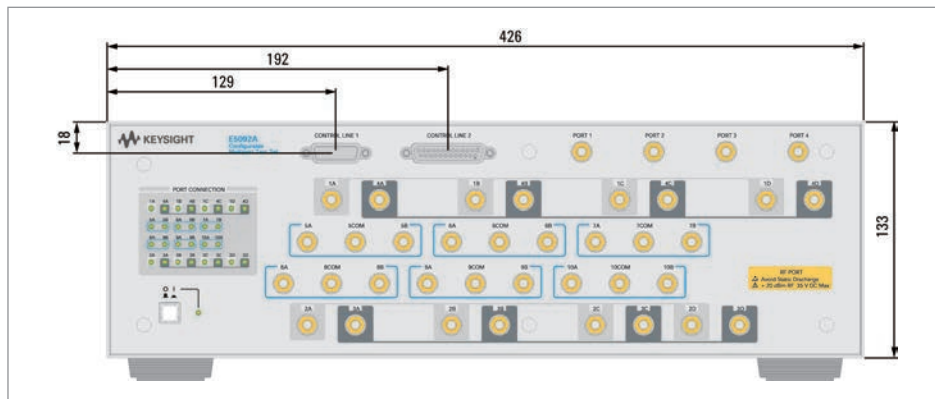

Figure 10. Dimensions (front view, with Option E5092A-020, in millimeters, nominal)

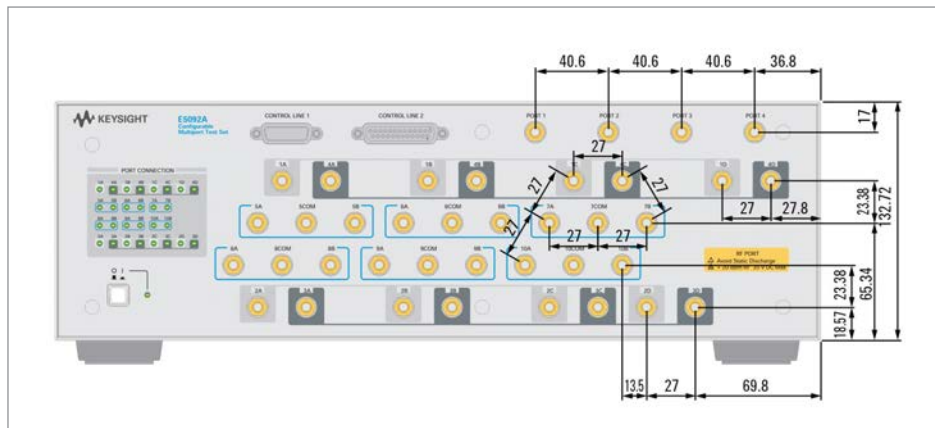

Figure 11. Dimensions (pitch between switches, with Option E5092A-020, in millimeters, nominal)



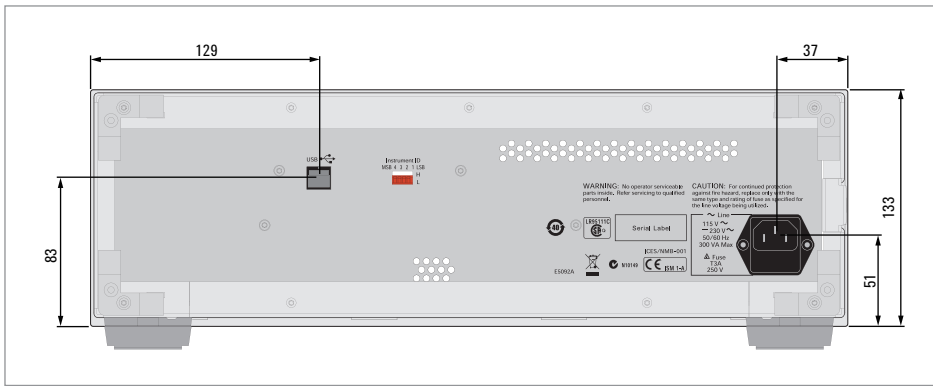

Figure 11. Dimensions (pitch between switches, with Option E5092A-020, in millimeters, nominal)

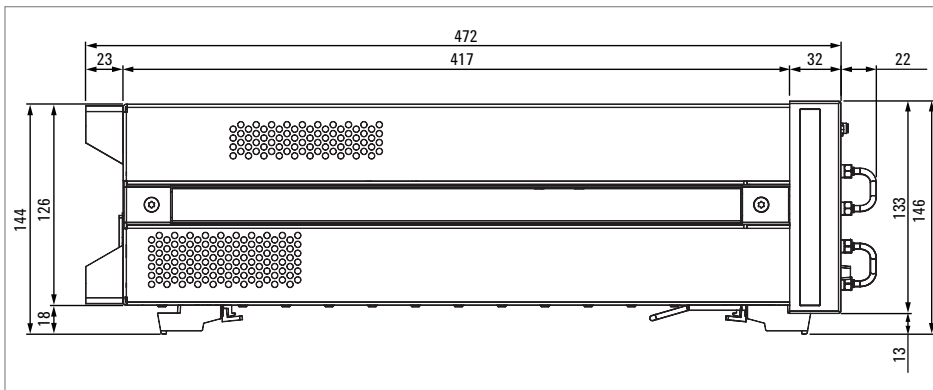

Figure 13. Dimensions (side view, with Option E5092A-020, in millimeters, nominal)

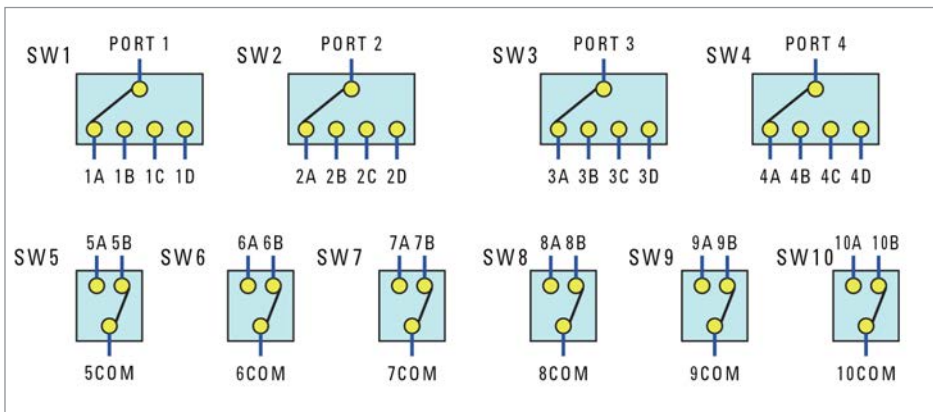

Figure 14. Switch configuration (E5092A-020)



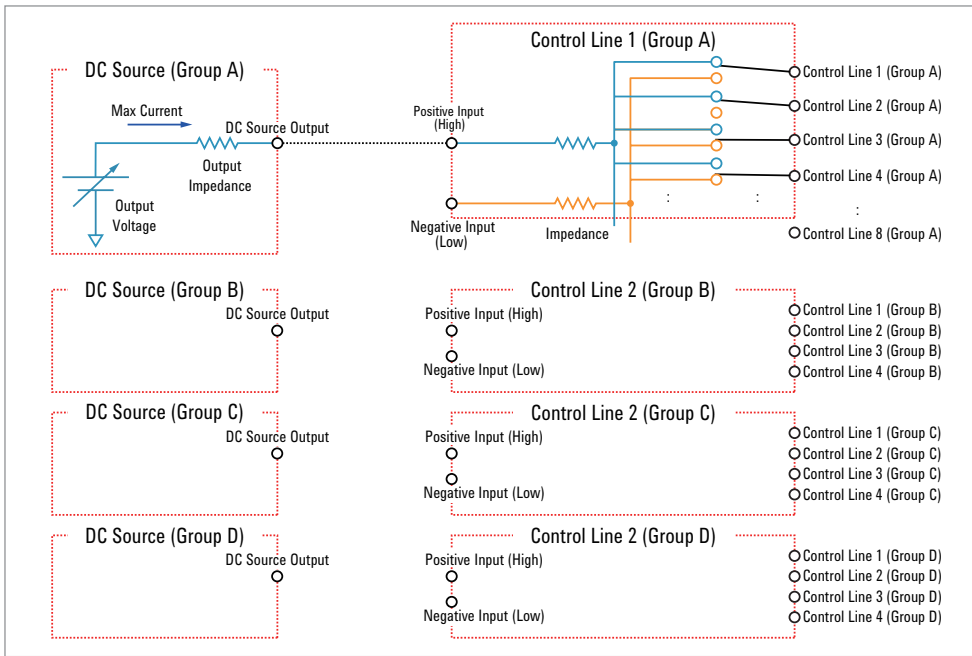

Figure 15. DC control line (E5092A-020)

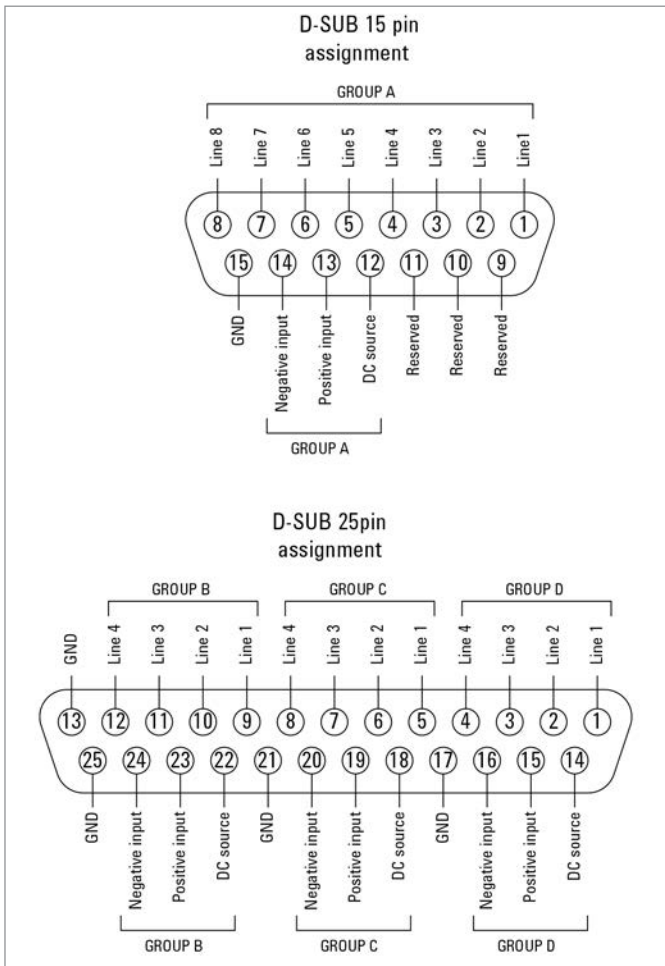

Figure 16. Control line pin assignment (E5092A-020)



Literature and Information

E5080A ENA Vector Network Analyzer Brochure, 5992-0290EN
E5080A ENA Vector Network Analyzer Data Sheet, 5992-0291EN
Keysight Network Analyzer Selection Guide, 5989-7603EN
Keysight RF & MW Test Accessories Catalog, 5989-8661EN

Web Resources

www.keysight.com/find/vna
www.keysight.com/find/ecal
www.keysight.com/find/mta
www.keysight.com/find/multiport
www.keysight.com/find/benchvue

myKeysight

myKeysight
www.keysight.com/find/mykeysight
 A personalized view into the information most relevant to you.

KEYSIGHT SERVICES

*Accelerate Technology Adoption.
 Lower costs.*

Keysight Services
www.keysight.com/find/service
 Our deep offering in design, test, and measurement services deploys an industry-leading array of people, processes, and tools. The result? We help you implement new technologies and engineer improved processes that lower costs.

Keysight Channel Partners
www.keysight.com/find/channelpartners
 Get the best of both worlds: Keysight's measurement expertise and product breadth, combined with channel partner convenience.

This data sheet contains a variety of typical and guaranteed performance data. This information supplied should not be interpreted as a complete list of circuit specifications. In this data sheet, the term typical refers to the 50th percentile performance. For additional information contact WPTC Marketing at 1-577-4211.

The product described in this data sheet is RoHS Compliant. See *RoHS Compliance* section for more details.

For more information on Keysight Technologies' products, applications or services, please contact your local Keysight office. The complete list is available at:
www.keysight.com/find/contactus

Americas

Canada	(877) 894 4414
Brazil	55 11 3351 7010
Mexico	001 800 254 2440
United States	(800) 829 4444

Asia Pacific

Australia	1 800 629 485
China	800 810 0189
Hong Kong	800 938 693
India	1 800 11 2626
Japan	0120 (421) 345
Korea	080 769 0800
Malaysia	1 800 888 848
Singapore	1 800 375 8100
Taiwan	0800 047 866
Other AP Countries	(65) 6375 8100

Europe & Middle East

Austria	0800 001122
Belgium	0800 58580
Finland	0800 523252
France	0805 980333
Germany	0800 6270999
Ireland	1800 832700
Israel	1 809 343051
Italy	800 599100
Luxembourg	+32 800 58580
Netherlands	0800 0233200
Russia	8800 5009286
Spain	800 000154
Sweden	0200 882255
Switzerland	0800 805353
	Opt. 1 (DE)
	Opt. 2 (FR)
	Opt. 3 (IT)
United Kingdom	0800 0260637

For other unlisted countries:
www.keysight.com/find/contactus
 (BP-9-7-17)

DEKRA Certified
ISO 9001 Quality Management System

www.keysight.com/go/quality
 Keysight Technologies, Inc.
 DEKRA Certified ISO 9001:2015
 Quality Management System

This information is subject to change without notice.
 © Keysight Technologies, 2018
 Published in USA, January 29, 2018
 5992-0291EN
www.keysight.com