

Agilent Technologies
E4402/7B Option HSB

User's and Service Guide Supplement

Agilent Technologies E4402/7B Option HSB

Spectrum Analyzer User's and Service Guide Supplement

Use this manual with the following document:

E4402B/7B ESA Manual Set



Agilent Technologies

Manufacturing Part Number: E4402-90080

Printed in USA

August 2004

© Copyright 2003, 2004 Agilent Technologies, Inc. All rights reserved.

Warranty Statement

THE MATERIAL CONTAINED IN THIS DOCUMENT IS PROVIDED “AS IS,” AND IS SUBJECT TO BEING CHANGED, WITHOUT NOTICE, IN FUTURE EDITIONS. FURTHER, TO THE MAXIMUM EXTENT PERMITTED BY APPLICABLE LAW, AGILENT DISCLAIMS ALL WARRANTIES, EITHER EXPRESS OR IMPLIED WITH REGARD TO THIS MANUAL AND ANY INFORMATION CONTAINED HEREIN, INCLUDING BUT NOT LIMITED TO THE IMPLIED WARRANTIES OF MERCHANTABILITY AND FITNESS FOR A PARTICULAR PURPOSE. AGILENT SHALL NOT BE LIABLE FOR ERRORS OR FOR INCIDENTAL OR CONSEQUENTIAL DAMAGES IN CONNECTION WITH THE FURNISHING, USE, OR PERFORMANCE OF THIS DOCUMENT OR ANY INFORMATION CONTAINED HEREIN. SHOULD AGILENT AND THE USER HAVE A SEPARATE WRITTEN AGREEMENT WITH WARRANTY TERMS COVERING THE MATERIAL IN THIS DOCUMENT THAT CONFLICT WITH THESE TERMS, THE WARRANTY TERMS IN THE SEPARATE AGREEMENT WILL CONTROL.

DFARS/Restricted Rights Notice

If software is for use in the performance of a U.S. Government prime contract or subcontract, Software is delivered and licensed as “Commercial computer software” as defined in DFAR 252.227-7014 (June 1995), or as a “commercial item” as defined in FAR 2.101(a) or as “Restricted computer software” as defined in FAR 52.227-19 (June 1987) or any equivalent agency regulation or contract clause. Use, duplication or disclosure of Software is subject to Agilent Technologies’ standard commercial license terms, and non-DOD Departments and Agencies of the U.S. Government will receive no greater than Restricted Rights as defined in FAR 52.227-19(c)(1-2) (June 1987). U.S. Government users will receive no greater than Limited Rights as defined in FAR 52.227-14 (June 1987) or DFAR 252.227-7015 (b)(2) (November 1995), as applicable in any technical data.

Safety Notes

The following safety notes are used throughout this document. Familiarize yourself with each of these notes and its meaning before performing any of the procedures in this document.

WARNING

Warning denotes a hazard. It calls attention to a procedure which, if not correctly performed or adhered to, could result in injury or loss of life. Do not proceed beyond a warning note until the indicated conditions are fully understood and met.

CAUTION

Caution denotes a hazard. It calls attention to a procedure that, if not correctly performed or adhered to, could result in damage to or destruction of the instrument. Do not proceed beyond a caution sign until the indicated conditions are fully understood and met.

Definitions

- Specifications describe the performance of parameters covered by the product warranty (temperature - 0 to 55 °C, unless otherwise noted.)
 - *Typical* describes additional product performance information that is not covered by the product warranty. It is performance beyond specification that 80% of the units exhibit with a 95% confidence level over the temperature range 20 to 30 °C. Typical performance does not include measurement uncertainty.
 - *Nominal* values indicate expected performance, or describe product performance that is useful in the application of the product, but is not covered by the product warranty.
-

Contents

Chapter 1

Description	10
Verifying the Shipment	10
Operation	11
Before You Begin	11
Connecting to the Spectrum Analyzer	11
Making Measurements	13
Performance Verification	15
Equipment Required	15
Repair Information	17
Block Diagram	20
Replaceable Parts	20

Chapter 2

Service and Safety Information	22
Introduction	22
Cleaning Instructions	22
Shipping Instructions	22
Before Applying Power	22
Warnings	23
Cautions	24
Instrument Markings	25
Contacting Agilent	26

Chapter 1

Description

The E4402/7B HSB provides an LO OUT between 2.1 GHz to 3.1 GHz at a power level of ≥ 5 dBm.

Verifying the Shipment

After the instrument has been unpacked, it is recommended that the original packaging materials are kept so they may be used if the instrument should need to be transported.

Inspect the instrument for any signs of damage that may have occurred during shipment. If your instrument appears to be damaged, see “Contacting Agilent” on page 26 for the nearest office.

Operation

The E4402/7B Option HSB Spectrum Analyzer and the Tektronics (Tek) 1405 TV Sideband Adapter are fully compatible. The operational range of the spectrum analyzer falls within the operating parameters of the Tek 1405 TV Sideband Adapter. Refer to the Tek 1405 instrument manual for specifications and operating parameters.

Before You Begin

Press the following keys on the spectrum analyzer:
[SYSTEM] > More > Show System

NOTE

The following typeface conventions are used throughout this document. Hardkeys are shown with brackets as follows:

- **[HARDKEY]** are labeled front panel keys
 - **SOFTKEYS** are unlabeled keys whose function is indicated on the instrument display.
-

Connecting to the Spectrum Analyzer

The following set-up is one example of how a typical measurement may be performed using the E4402/7B Spectrum Analyzer with the Option HSB. Refer to Table 1-1, “Material and Equipment Required,” for a list of equipment needed.

Table 1-1 **Material and Equipment Required**

Description	Agilent Part Number	Qty
Adapter Type-N (m) to BNC (f)	1250-0780	1
Cable SMA (m)	5062-6674	1
Cable BNC (m)	8120-2582	2
E4402/7B ESA with Option HSB	na	1
Modulator or Transmitter Under Test	na	1
Tektronics (Tek) 1405 TV Sideband Adapter	na	1
Adapter Coax (m) to BNC (f)	na	1

Operation

1. Connect one end of the SMA cable (5062-6674) to the Tek 1405 TV Sideband Adapter LO IN to the SMA connector labeled “2.1–3.1 GHz LO Out” on the rear panel of the E4402/7B Spectrum Analyzer. Refer to Figure 1-1.
2. Attach the BNC cable (8120-2582) from the Video Out on the rear of the Tek 1405 Sideband Adapter to the Video In on the transmitter or modulator under test.
3. Secure the appropriate adapters to the ends of the BNC cable (8120-2582) and attach to the 50 Ω RF Input of the E4402/7B Spectrum Analyzer and the other end to the output of the modulator.

CAUTION

A directional coupler or high power attenuator may be needed to keep the DUT output power from exceeding +30 dBm or 1 W max safe input.

Figure 1-1 E4402/7B Option HSB Test Hardware Setup

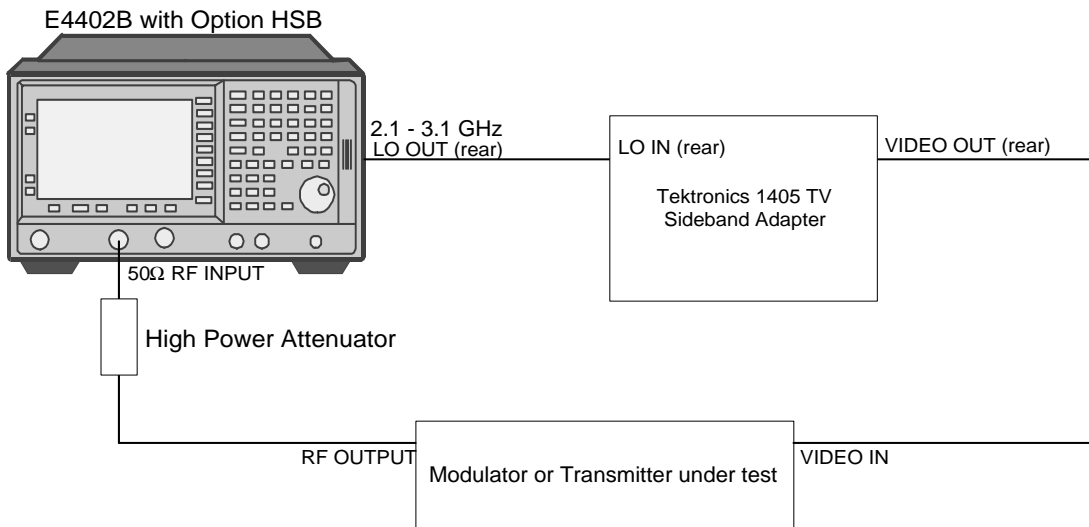

Making Measurements

The instructions describe the setup for a simple measurement that may be made using the equipment listed in Table 1-1 and the configuration in Figure 1-1, “E4402/7B Option HSB Test Hardware Setup”.

1. Turn **On** all of the equipment. Allow the equipment to warm up for the required specified time as indicated in each of the instrument operating manuals.
2. Turn **Off** the Auto Align routine before making your measurements. Perform the following keystrokes:
[System] > Alignments > Auto Align > Off
3. Select the desired channel on the modulator, or use the assigned transmitter frequency. Channel two (≈ 55.25 MHz) has been selected for this example.
4. Perform the following keystrokes:
[Frequency] > Start Freq > [52 MHz] > [Frequency] Stop Freq > [63 MHz].

After you have completed the setup, refer to Figure 1-2 for an example of the waveform on the screen of the E4402/7B.

Figure 1-2 Typical Signal After E4402/7B Setup

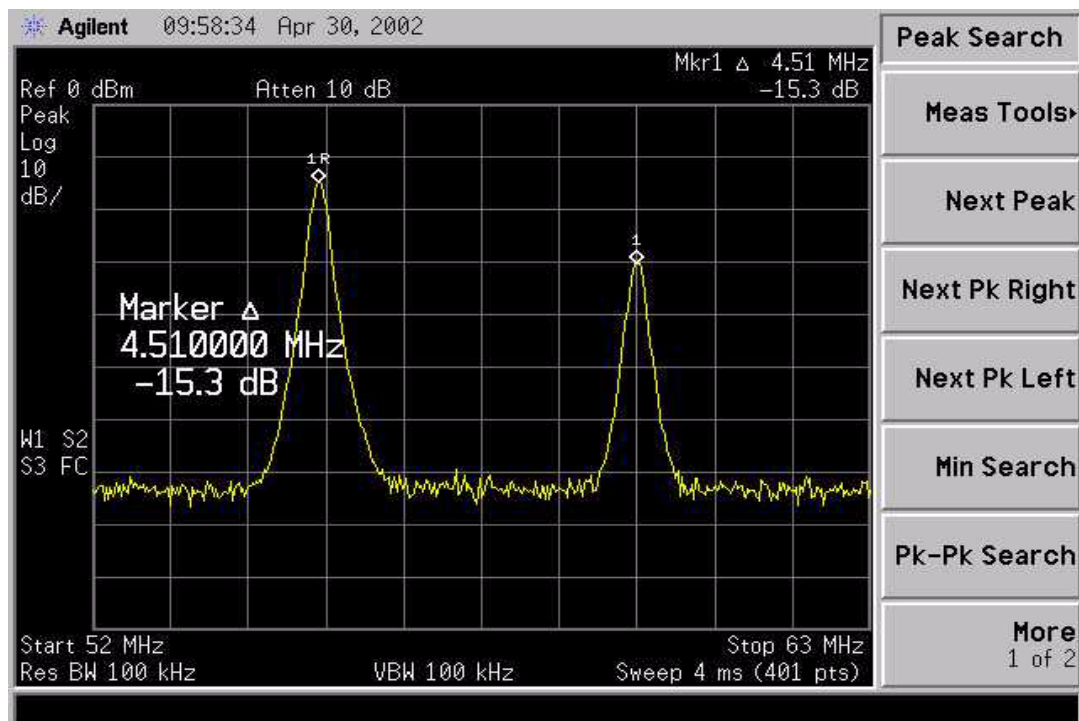

Operation

5. Slowly adjust the Tek 1405 course “Transmitter Frequency” knob to the desired frequency. Use the “Fine” adjust knob if more accuracy is desired. The waveform displayed on the E4402/7B Spectrum Analyzer will display the bandwidth of the transmitter or modulator under test, see Figure 1-3. Refer to the Tek 1405 documentation for more information on making measurements.

Figure 1-3 Example of a Video Signal

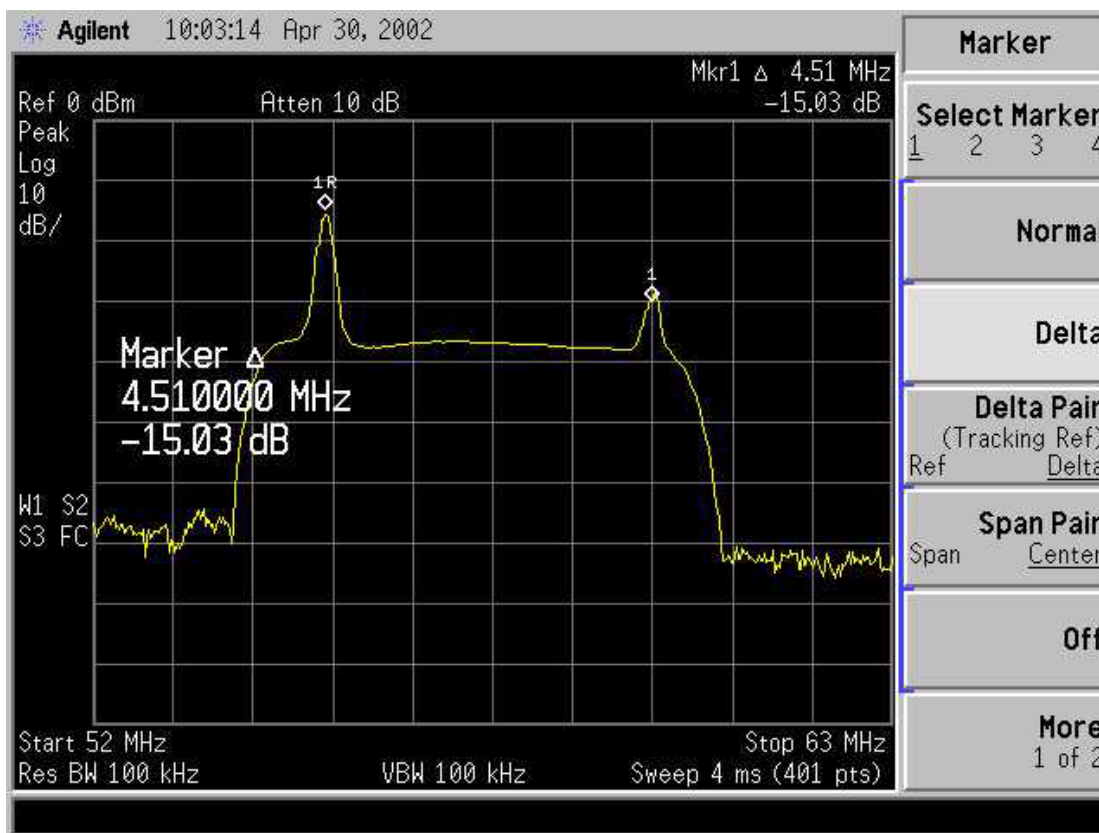

Performance Verification

The purpose of the electrical test is to verify the response of the HSB option card in the ESA. The HSB option card provides an output frequency range from 2.1 GHz to 3.1 GHz with a power level ≥ 5 dBm.

Equipment Required

- Spectrum Analyzer. Use a spectrum analyzer with a frequency range of > 4 GHz.
 - ESA Spectrum Analyzer containing Option HSB (DUT).
 - RF Cable (3.5 mm).
1. Turn on both spectrum analyzers and press **[Preset]**.
 2. Turn off the Auto Align function of the DUT and the test spectrum analyzer, if so equipped.
 3. Connect the HSB Output, on the rear of the ESA DUT, to the RF Input, on the spectrum analyzer using an RF cable and adapter, if required.
 4. Press **[Frequency]** on the ESA DUT and set the start frequency to 0 Hz and the stop frequency to 1.1 GHz.
 5. Press **[Frequency]** on the test spectrum analyzer and set the start frequency to 1.7 GHz and the stop frequency to 3.3 GHz.
 6. Set the RF level on the test spectrum analyzer to 30 dBm.
 7. Increase the test spectrum analyzer sweep time to approximately 20 seconds for improved display clarity.
 8. Leave all other ESA DUT and test spectrum analyzer settings autocoupled.
 9. Set the test spectrum analyzer markers 1 and 2 to frequencies of 2.1 GHz to 3.1 GHz, respectively.
 10. Press **[View Trace] > Max Hold** on the test spectrum analyzer.

- Verify that the test spectrum analyzer signal trace is ≥ 5 dBm between 2.1 GHz and 3.1 GHz. Refer to Figure 1.

Figure 1-4 Option HSB Trace Characteristics

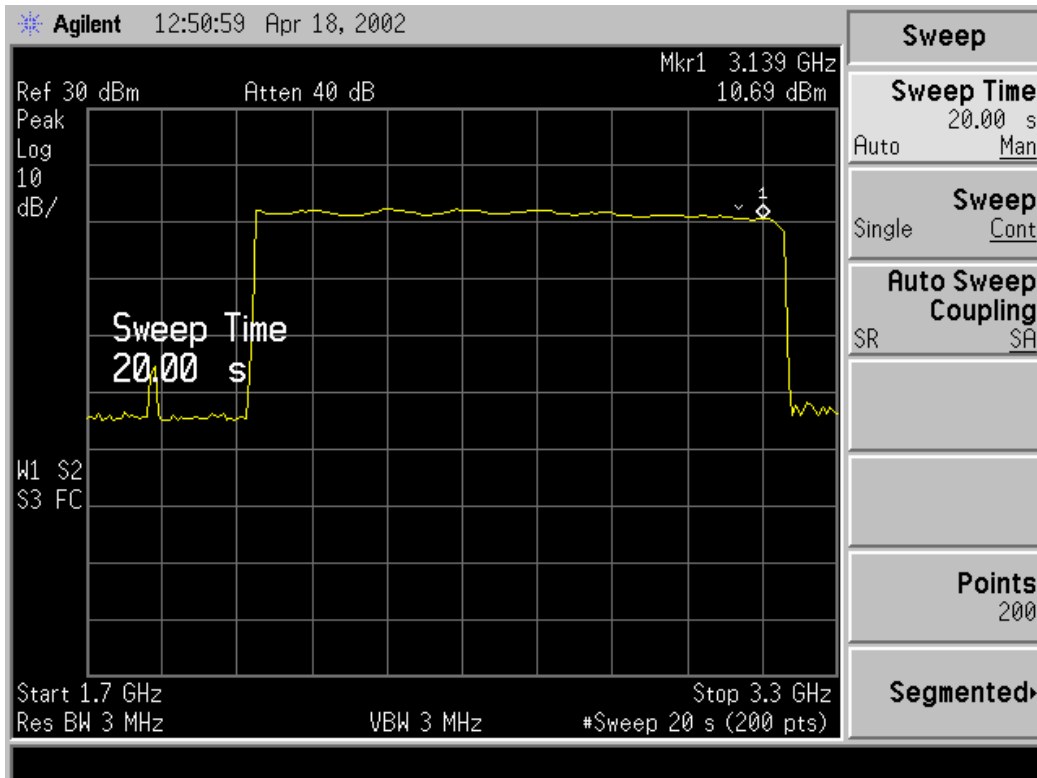

- Press **[Span]** > **Zero Span** on the ESA DUT.
- Press **[Center Frequency]** **[0 MHz]** on the ESA DUT.
- Press **[View/Trace]** > **Clear Write** on the test spectrum analyzer.
- Set the **[Marker]** on the test spectrum analyzer to 1.8214 GHz.
- Verify that the test spectrum analyzer signal trace is < -15 dBm at 1.8214 GHz. The HSB board LO signal must be attenuated sufficiently for proper sideband adapter operation.

Repair Information

The HSB can occupy Slot 5 or 6 and will appear to be empty. Note that Slot 6 actually contains the Option HSB. Verify that Option HSB has been installed by checking the serial tag on the rear panel of the instrument.

The following photographs show the replaceable assemblies. Refer to Table 1-1 on page 1-11 for a replaceable parts list.

Figure 1-5 LO Output (J15)

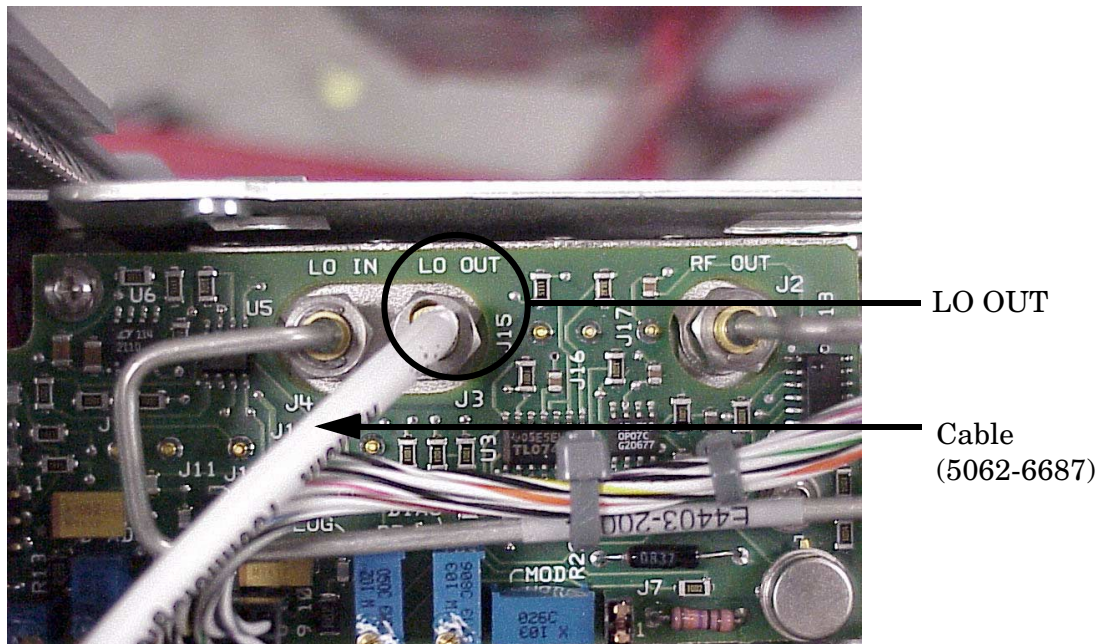

Figure 1-6 **Cable (J3)**

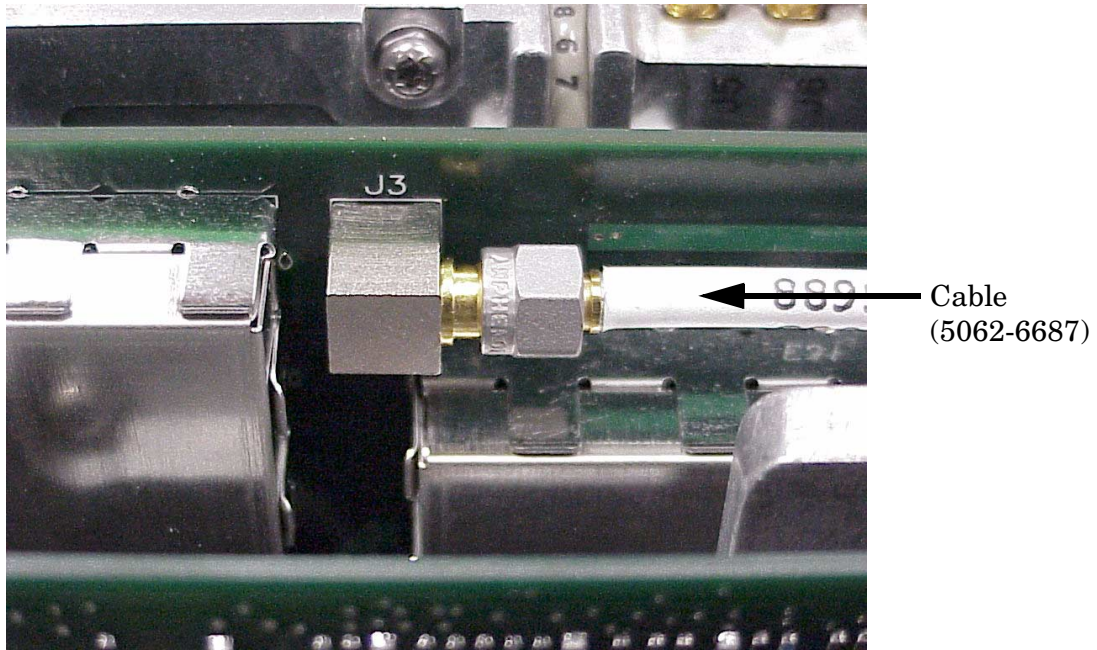
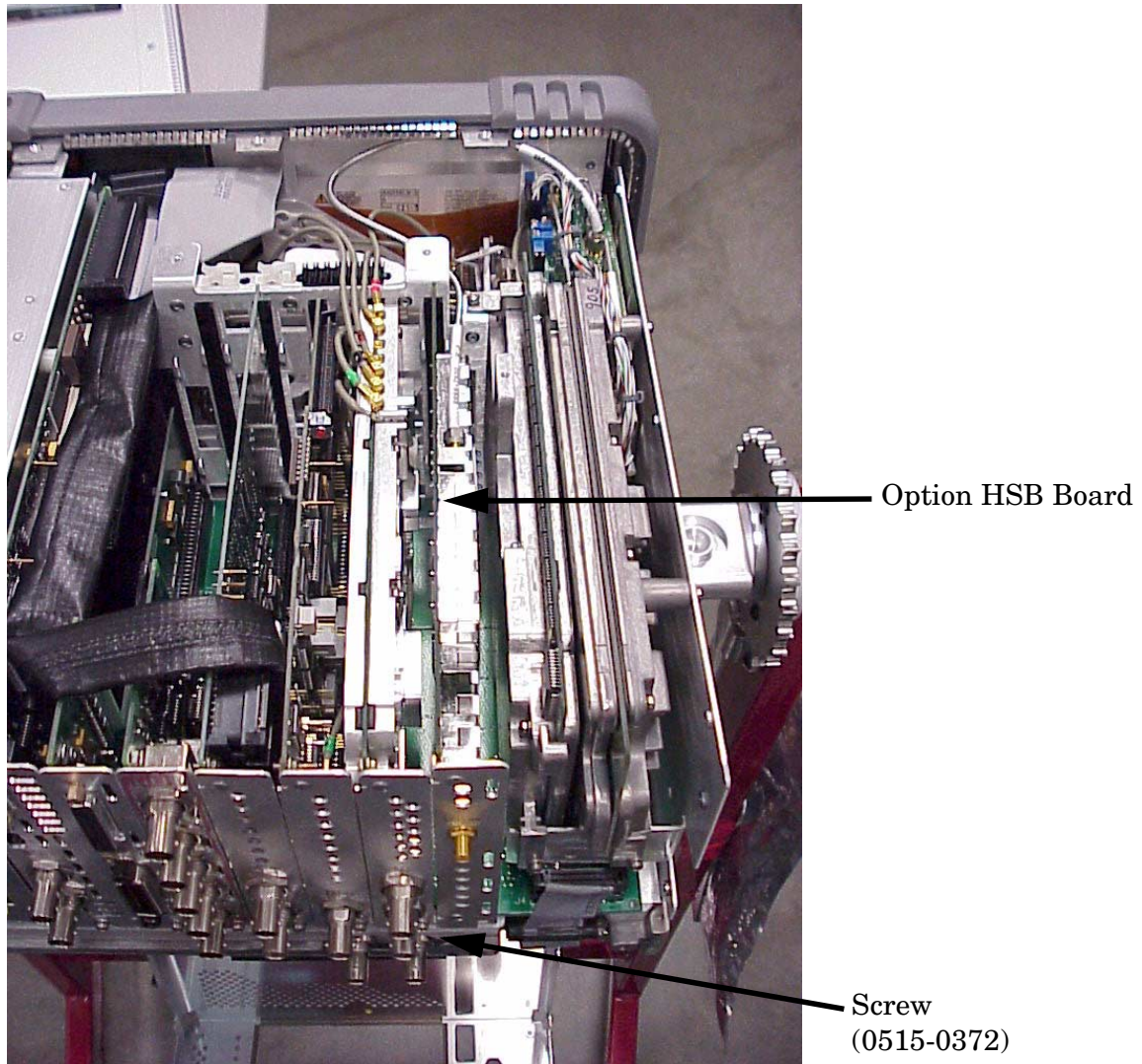

Figure 1-7 **Option HSB Board Location**



Block Diagram

Refer to Figure 1-8, “E4402/7B Option HSB Block Diagram”. The input to Side Band Adapter board assembly is connected to the Tracking Generator with the output connected to the rear panel.

Figure 1-8 E4402/7B Option HSB Block Diagram

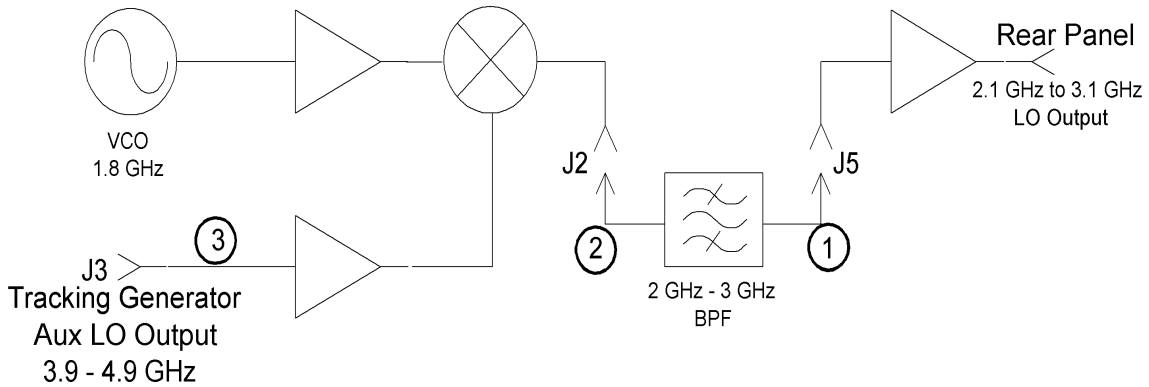

Replaceable Parts

Table 1-2 E440xB Option HSB Replaceable Parts

Description	Agilent Part Number	Qty
Screw (T-10 M3 x 8 mm)	0515-0372	1
Cable assembly, TG to J3 ¹	5062-6687	1
Board assembly, Side Band Adapter	E4407-60011	1

1. This cable is listed as “3” on the block diagram in Figure 1-8.

Chapter 2

Service and Safety Information

Introduction

Review this product and related documentation to familiarize yourself with safety markings and instructions before you operate the instrument. This product has been designed and tested in accordance with international standards.

NOTE

There are many other repair and calibration options available from the Agilent Technologies support organization. These options cover a range of service agreements with varying response times. Contact Agilent for additional information on available service agreements for this product. Refer to “Contacting Agilent” on page 26.

Cleaning Instructions

Clean the instrument cabinet using a damp cloth only.

Shipping Instructions

IMPORTANT

Agilent Technologies reserves the right to reformat or replace the internal hard disk drive in your analyzer as part of its repair. This will erase all user information stored on the hard disk. It is imperative, therefore, that you make a backup copy of your critical test data located on the analyzer’s hard disk before shipping it to Agilent for repair.

If you wish to send your network analyzer to Agilent Technologies for service or repair:

- Include a complete description of the service requested or of the failure and a description of any failed test and any error message.
- Ship the analyzer using the original or comparable antistatic packaging materials.
- Contact Agilent for instructions on where to ship your analyzer. Refer to “Contacting Agilent” on page 26.

Before Applying Power

Verify that the product is configured to match the available main power source as described in the input power configuration instructions in this manual. If this product is to be powered by autotransformer, make sure the common terminal is connected to the neutral (grounded) side of the ac power supply.

Warnings

WARNING **The WARNING notice denotes a hazard. It calls attention to a procedure, practice, or the like, which if not correctly performed or adhered to, could result in personal injury. Do not proceed beyond a WARNING notice until the indicated conditions are fully understood and met.**

Warnings applicable to this instrument are:

WARNING **No operator serviceable parts inside. Refer servicing to qualified personnel. To prevent electrical shock, do not remove covers.**

WARNING **If this instrument is not used as specified, the protection provided by the equipment could be impaired. This instrument must be used in a normal condition (in which all means for protection are intact) only.**

WARNING **For continued protection against fire hazard replace line fuse only with same type and rating:**

- **United States—F 3A/250V, Part Number 2110-0780**
- **Europe—F 3.15A/250V, Part Number 2110-0655**

The use of other fuses or material is prohibited.

WARNING **This is a Safety Class I product (provided with a protective earthing ground incorporated in the power cord). The mains plug shall be inserted only into a socket outlet provided with a protective earth contact. Any interruption of the protective conductor, inside or outside the instrument, is likely to make the instrument dangerous. Intentional interruption is prohibited.**

WARNING **The power cord is connected to internal capacitors that may retain dangerous electrical charges for 5 seconds after disconnecting the plug from its power supply.**

WARNING **These servicing instructions are for use by qualified personnel only. To avoid electrical shock, do not perform any servicing unless you are qualified to do so.**

Cautions

WARNING **The opening of covers or removal of parts is likely to expose dangerous voltages. Disconnect the instrument from all voltage sources while it is being opened.**

WARNING **This product is designed for use in Installation Category II and Pollution Degree 2 per IEC 1010 and 664 respectively.**

Cautions

CAUTION The CAUTION notice denotes a hazard. It calls attention to an operating procedure, practice, or the like, which if not correctly performed or adhered to, could result in damage to the product or loss of important data. Do not proceed beyond a CAUTION notice until the indicated conditions are fully understood and met.









Cautions applicable to this instrument are:

CAUTION Always use the three-prong ac power cord supplied with this instrument. Failure to ensure adequate earth grounding (by not using this cord) can cause instrument damage.

CAUTION This instrument has autoranging line voltage input; be sure the supply voltage is within the specified range.

CAUTION Ventilation Requirements: When installing the instrument in a cabinet, the convection into and out of the instrument must not be restricted. The ambient temperature (outside the cabinet) must be less than the maximum operating temperature of the instrument by 4° C for every 100 watts dissipated in the cabinet. If the total power dissipated in the cabinet is greater than 800 watts, forced convection must be used.

Instrument Markings

	When you see this symbol on your instrument, you should refer to the instrument's instruction manual for important information.
	This symbol indicates hazardous voltages.
	The laser radiation symbol is marked on products that have a laser output.
	This symbol indicates that the instrument requires alternating current (ac) input.
	The CE mark is a registered trademark of the European Community. If it is accompanied by a year, it indicates the year the design was proven.
	The CSA mark is a registered trademark of the Canadian Standards Association.
ISM1-A	This text indicates that the instrument is an Industrial Scientific and Medical Group 1 Class A product (CISPER 11, Clause 4).
	This symbol indicates that the power line switch is ON.
	This symbol indicates that the power line switch is OFF or in STANDBY position.
	This symbol indicates the product meets the Australian Standards.



**Safety
Earth
Ground**

This is a Safety Class I product (provided with a protective earthing terminal). An uninterruptible safety earth ground must be provided from the main power source to the product input wiring terminals, power cord, or supplied power cord set. Whenever it is likely that the protection has been impaired, the product must be made inoperative and secured against any unintended operation.

Contacting Agilent

By internet, phone, or fax, get assistance with all your test and measurement needs.

Online assistance: www.agilent.com/find/assist			
Americas			
Brazil (tel) (+55) 11 4197 3600 (fax) (+55) 11 4197 3800	Canada (tel) 877 894 4414 (fax) (+1) 905 282-6495	Mexico (tel) (+52) 55 5081 9469 (alt) 01800 5064 800 (fax) (+52) 55 5081 9467	United States (tel) 800 829 4444 (alt) (+1) 303 662 3998 (fax) 800 829 4433
Asia Pacific and Japan			
Australia (tel) 1800 629 485 (alt) 1800 143 243 (fax) 1800 142 134	China (tel) 800 810 0189 (alt) (+86) 10800 650 0021 (fax) 800 820 2816	Hong Kong (tel) 800 930 871 (alt) (+852) 3197 7889 (fax) (+852) 2 506 9233	India (tel) 1600 112 929 (fax) 000800 650 1101
Japan (tel) 0120 421 345 (alt) (+81) 426 56 7832 (fax) 0120 421 678	Malaysia (tel) 1800 888 848 (alt) 1800 828 848 (fax) 1800 801 664	Singapore (tel) 1800 375 8100 (alt) (+65) 6 375 8100 (fax) (+65) 6836 0252	South Korea (tel) 080 769 0800 (alt) (+82) 2 2004 5004 (fax) (+82) 2 2004 5115
Taiwan (tel) 0800 047 866 (alt) 00801 651 317 (fax) 0800 286 331	Thailand (tel) 1800 226 008 (alt) (+66) 2 268 1345 (fax) (+66) 2 661 3714		
Europe			
Austria (tel) 0820 87 44 11* (fax) 0820 87 44 22	Belgium (tel) (+32) (0)2 404 9340 (alt) (+32) (0)2 404 9000 (fax) (+32) (0)2 404 9395	Denmark (tel) (+45) 7013 1515 (alt) (+45) 7013 7313 (fax) (+45) 7013 1555	Finland (tel) (+358) 10 855 2100 (fax) (+358) 10 855 2923
France (tel) 0825 010 700* (alt) (+33) (0)1 6453 5623 (fax) 0825 010 701*	Germany (tel) 01805 24 6333* (alt) 01805 24 6330* (fax) 01805 24 6336*	Ireland (tel) (+353) (0)1 890 924 204 (alt) (+353) (0)1 890 924 206 (fax) (+353) (0)1 890 924 024	Israel (tel) (+972) 3 9288 500 (fax) (+972) 3 9288 501
Italy (tel) (+39) (0)2 9260 8484 (fax) (+39) (0)2 9544 1175	Luxemburg (tel) (+32) (0)2 404 9340 (alt) (+32) (0)2 404 9000 (fax) (+32) (0)2 404 9395	Netherlands (tel) (+31) (0)20 547 2111 (alt) (+31) (0)20 547 2000 (fax) (+31) (0)20 547 2190	Russia (tel) (+7) 095 797 3963 (alt) (+7) 095 797 3900 (fax) (+7) 095 797 3901
Spain (tel) (+34) 91 631 3300 (alt) (+34) 91 631 3000 (fax) (+34) 91 631 3301	Sweden (tel) 0200 88 22 55* (alt) (+46) (0)8 5064 8686 (fax) 020 120 2266*	Switzerland (French) (tel) 0800 80 5353 opt. 2* (alt) (+33) (0)1 6453 5623 (fax) (+41) (0)22 567 5313	Switzerland (German) (tel) 0800 80 5353 opt. 1* (alt) (+49) (0)7031 464 6333 (fax) (+41) (0)1 272 7373
Switzerland (Italian) (tel) 0800 80 5353 opt. 3* (alt) (+39) (0)2 9260 8484 (fax) (+41) (0)22 567 5314	United Kingdom (tel) (+44) (0)7004 666666 (alt) (+44) (0)7004 123123 (fax) (+44) (0)7004 444555		
(tel) = primary telephone number; (alt) = alternate telephone number; (fax) = FAX number; * = in country number			

Index

A

adapters needed, 11
agilent
 contacting, 26
 support, 22

B

block diagram, 20

C

cautions, 24
cleaning, 22
connections, 11
contacting agilent, 26

D

definitions
 nominal, 3
 specifications, 3
 typical, 3
description, 10

diagram, block, 20

E

equipment needed, 11
example video signal, 14

I

instrument markings, 25
introduction to safety, 22

K

key conventions, 11

L

LO power level, 10

M

markings, 25

O

operation, 11

P

parts, replaceable, 20
power level, LO, 10

R

replaceable parts, 20

S

service and safety, 22
shipment verification, 10
shipping instructions, 22
spectrum analyzer connections, 11
support
 organization, 22
symbols, 25

V

verifying shipment, 10
video signal, example, 14

W

warnings, 23