

# Keysight MultiScope

Hardware  
Configuration  
Guide

# Notices

© Keysight Technologies, Inc. 2013-2018

No part of this manual may be reproduced in any form or by any means (including electronic storage and retrieval or translation into a foreign language) without prior agreement and written consent from Keysight Technologies, Inc. as governed by United States and international copyright laws.

## Manual Part Number

N8822-97008

## Edition

Ninth edition, September 2018

Available in electronic format only

Published by:

Keysight Technologies, Inc.  
1900 Garden of the Gods Road  
Colorado Springs, CO 80907 USA

## Warranty

**The material contained in this document is provided “as is,” and is subject to being changed, without notice, in future editions. Further, to the maximum extent permitted by applicable law, Keysight disclaims all warranties, either express or implied, with regard to this manual and any information contained herein, including but not limited to the implied warranties of merchantability and fitness for a particular purpose. Keysight shall not be liable for errors or for incidental or consequential damages in connection with the furnishing, use, or performance of this document or of any information contained herein. Should Keysight and the user have a separate written agreement with warranty terms covering the material in this document that conflict with these terms, the warranty terms in the separate agreement shall control.**

## Technology Licenses

The hardware and/or software described in this document are furnished under a license and may be used or copied only in accordance with the terms of such license.

## U.S. Government Rights

The Software is "commercial computer software," as defined by Federal Acquisition Regulation ("FAR") 2.101. Pursuant to FAR 12.212 and 27.405-3 and Department of Defense FAR Supplement ("DFARS") 227.7202, the U.S. government acquires commercial computer software under the same terms by which the software is customarily provided to the public. Accordingly, Keysight provides the Software to U.S. government customers under its standard commercial license, which is embodied in its End User License Agreement (EULA), a copy of which can be found at [www.keysight.com/find/sweula](http://www.keysight.com/find/sweula). The license set forth in the EULA represents the exclusive authority by which the U.S. government may use, modify, distribute, or disclose the Software. The EULA and the license set forth therein, does not require or permit, among other things, that Keysight: (1) Furnish technical information related to commercial computer software or commercial computer software documentation that is not customarily provided to the public; or (2) Relinquish to, or otherwise provide, the government rights in excess of these rights customarily provided to the public to use, modify, reproduce, release, perform, display, or disclose commercial computer software or commercial computer software documentation. No additional government requirements beyond those set forth in the EULA shall apply, except to the extent that those terms, rights, or licenses are explicitly required from all providers of commercial computer software pursuant to the FAR and the DFARS and are set forth specifically in writing elsewhere in the EULA. Keysight shall be under no obligation to update, revise or otherwise modify the Software. With respect to any technical data as defined by FAR 2.101, pursuant to FAR 12.211 and 27.404.2 and DFARS 227.7102, the U.S. government acquires no greater

than Limited Rights as defined in FAR 27.401 or DFAR 227.7103-5 (c), as applicable in any technical data.

## Safety Notices

### CAUTION

A **CAUTION** notice denotes a hazard. It calls attention to an operating procedure, practice, or the like that, if not correctly performed or adhered to, could result in damage to the product or loss of important data. Do not proceed beyond a **CAUTION** notice until the indicated conditions are fully understood and met.

---

### WARNING

A **WARNING** notice denotes a hazard. It calls attention to an operating procedure, practice, or the like that, if not correctly performed or adhered to, could result in personal injury or death. Do not proceed beyond a **WARNING** notice until the indicated conditions are fully understood and met.

---

# MultiScope Hardware Configuration—At a Glance

You can connect multiple Infiniium oscilloscopes together to create an oscilloscope system with greater than 4 channels all the way up to a 40-channel system.

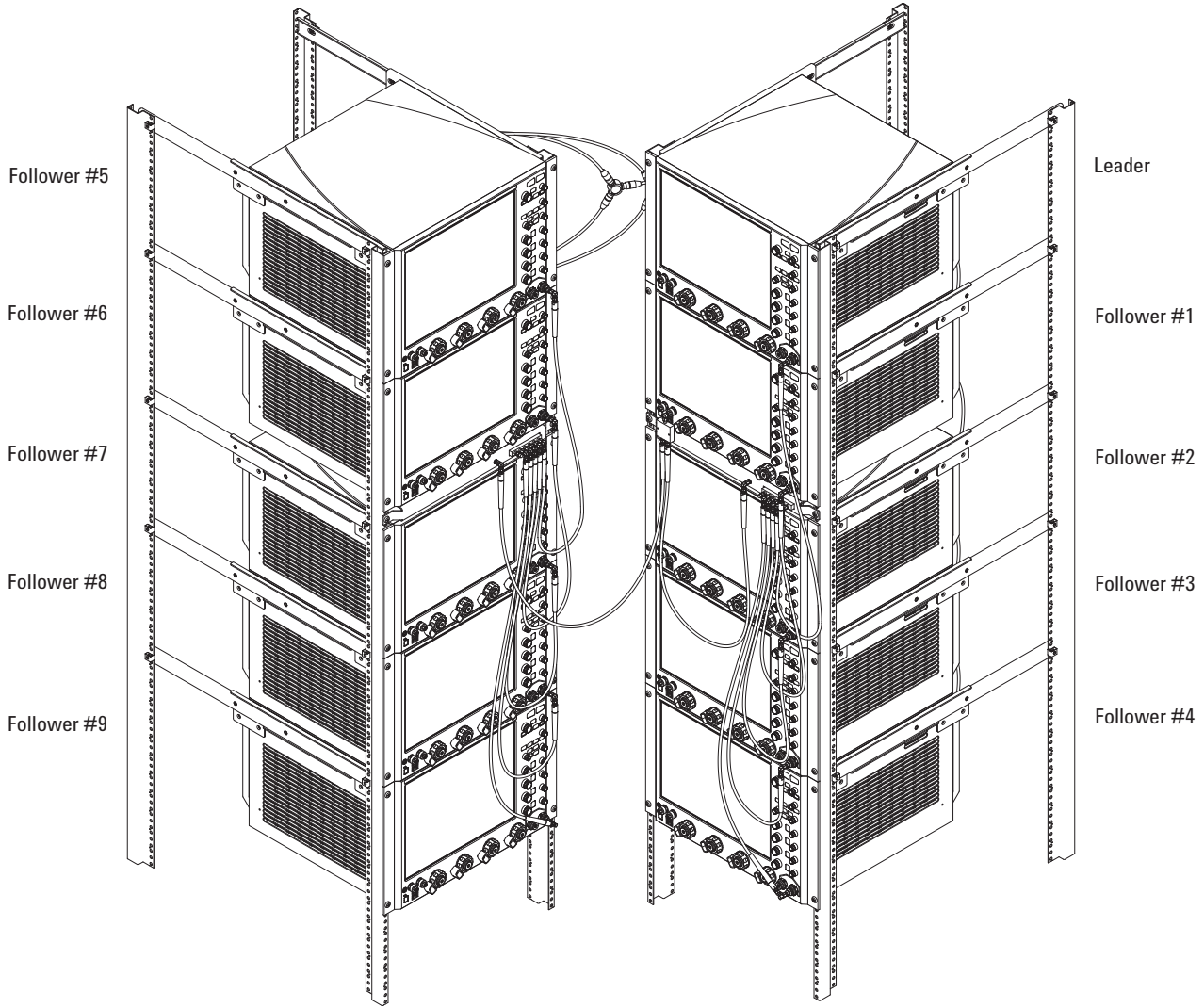

**Figure 1** 40-Channel, 33 GHz Oscilloscope System

**Oscilloscopes  
Required**

You can set up MultiScope systems made up of Infiniium Z-Series oscilloscopes or upgraded Infiniium 90000 Q-Series oscilloscopes. With these oscilloscopes:

- Each oscilloscope in 20, 25, or 33 GHz bandwidth systems adds four channels. Each oscilloscope in 50 GHz or 63 GHz bandwidth systems adds two channels (because the RealEdge inputs are used). You can connect up to ten oscilloscopes, up to five oscilloscopes per rack.

- The MultiScope system is synchronized using the **Cal Out** signal on the second (*follower #1*) oscilloscope, clock splitter power divider(s), and a synchronization port on all oscilloscopes. On oscilloscope models that include RealEdge channels, the unused inputs (that is, non-RealEdge channels in RealEdge mode) are used for synchronization. On oscilloscope models that do not include RealEdge channels, an optional **Sync In** channel input is used for synchronization.

You can also set up MultiScope systems made up of Infiniium V-Series or 90000 X-Series oscilloscopes, Infiniium S-Series, 9000 Series, or 90000A Series oscilloscopes.

### Expansion Accessories

As you configure MultiScope systems made up of Z-Series or 90000 Q-Series oscilloscopes, expansion accessories containing the necessary cables, adapters, and power dividers are required:

- N2104A Dual Infiniium Frame Channel Alignment Kit (Rackmount).
- N2105A Dual Infiniium Frame Channel Alignment Kit (Stackmount).
- N2106A Infiniium Frame Expansion Channel Alignment Kit (Expand One Frame).
- N2107A Infiniium Frame Expansion Kit (Expand One Rack).
- N2122A MultiScope Channel Deskew Kit (one recommended for each MultiScope system).

The N2104A, N2106A, and N2107A rackmount expansion accessories are set up so that you can expand your system one oscilloscope at a time.

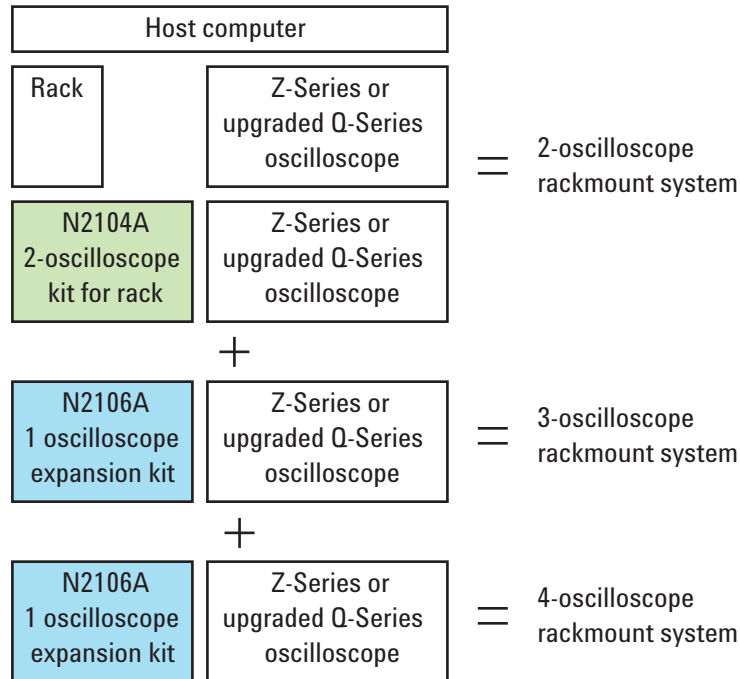

**Figure 2** Expansion Accessories Required for Four-Oscilloscope Rackmount System



For example, to set up a four-oscilloscope system, your configuration would include one N2104A kit (to go from one oscilloscope to two) and two N2106A kits (to go from two oscilloscopes to three and then from three oscilloscopes to four). See [Figure 2](#).

Expanding from a five-oscilloscope system to a six-oscilloscope system requires a second rack, so extra power dividers, adapters, and cables are required and included in the N2107A (Expand One Rack) kit.

The N2105A Infiniium Frame Channel Alignment Kit (Stackmount) is for two-oscilloscope systems that are not in a rack and will not be expanded.

For MultiScope systems made up of two V-Series, 90000 X-Series, S-Series, 9000 Series, or 90000A Series oscilloscopes, multi-frame cable kits are available:

- N2123A Multi-Frame Cable Kit for Two 90000 X-Series or V-Series Oscilloscopes.
- N2124A Multi-Frame Cable Kit for Two 9000A, 90000A, or S-Series Oscilloscopes.

**Not Included** MultiScope systems also require:

- Equipment rack(s).
- Rackmount kits for the oscilloscopes (N2759A for Z-Series or 90000 Q-Series).
- MultiScope control software.
- Remote interface connection between host computer and the each oscilloscope in the system (for controlling the individual oscilloscopes and moving captured data to the host computer).

Ethernet LAN and instrument USB are the most common interface options used.

### **MultiScope Control Software**

To control MultiScope systems and analyze captured data, you can use:

- Infiniium oscilloscope software on the Leader oscilloscope. MultiScope software is now included as a standard feature.
- D9010BSEO Infiniium Offline oscilloscope analysis software on a host computer. MultiScope software is now included as a standard feature.
- N8822A MATLAB time-synchronization software on a host computer.

This software allows time-synchronized acquisitions for systems of up to ten oscilloscopes with very low oscilloscope-to-oscilloscope jitter and drift. This software can be used to configure, capture, and store real-time voltage signals.

## In This Guide

This guide describes the equipment required to configure MultiScope systems and shows you how to set up and connect the equipment:

- [Chapter 1](#), “Z-Series or 90000 Q-Series MultiScope System Requirements,” starting on page 11.

Depending on the Z-Series or 90000 Q-Series oscilloscope bandwidths and number of channels required, you will use one of the configurations shown in the following table.

# of 20, 25, or 33 GHz Bandwidth Channels Required	# of 50 or 63 GHz Bandwidth Channels Required	Configuration Required	See:
5-8	3-4	2-oscilloscope configuration	<ul style="list-style-type: none"> <li>▪ <b>Chapter 3</b>, “Two-Oscilloscope Stackmount System, Z-Series or 90000 Q-Series,” starting on page 21 (that cannot be expanded later).</li> <li>▪ <b>Chapter 2</b>, “Two-Oscilloscope Rackmount System, Z-Series or 90000 Q-Series,” starting on page 15 (that can be expanded later).</li> </ul>
9-20	5-10	3-to-5-oscilloscope configuration (1 rack)	<b>Chapter 4</b> , “Three- to Five-Oscilloscope Rackmount Systems, Z-Series or 90000 Q-Series,” starting on page 29.
21-40	11-20	6-to-10-oscilloscope configuration (2 racks)	<b>Chapter 5</b> , “Six- to Ten-Oscilloscope Rackmount Systems, Z-Series or 90000 Q-Series,” starting on page 37.

For MultiScope systems made up of V-Series or 90000 X-Series oscilloscopes, see:

- **Chapter 6**, “Two-Oscilloscope System, V-Series or 90000 X-Series,” starting on page 47.
- **Chapter 7**, “Three- to Five-Oscilloscope Rackmount Systems, V-Series or 90000 X-Series,” starting on page 53.
- **Chapter 8**, “Six- to Ten-Oscilloscope Rackmount Systems, V-Series or 90000 X-Series,” starting on page 65.

For two-oscilloscope MultiScope systems made up of S-Series, 9000 Series, or 90000A Series oscilloscopes, see:

- **Chapter 9**, “Two-Oscilloscope System, S-Series, 9000 Series, or 90000A Series,” starting on page 79.

After you have set up and connected the MultiScope system, see:

- **Chapter 10**, “Next Steps,” starting on page 85.

- See Also**
- The *D9010BSEO Infiniium Offline Oscilloscope Analysis Software Online Help* for information on using the N8834A MultiScope software.
  - The *N8822A MATLAB Time Synchronization Software User's Guide* for information on using the software.

# Contents

MultiScope Hardware Configuration—At a Glance / 3

In This Guide / 5

## 1 Z-Series or 90000 Q-Series MultiScope System Requirements

Z-Series or 90000 Q-Series Oscilloscope Requirements / 12

Infiniium Z-Series Oscilloscopes / 12

Infiniium 90000 Q-Series Oscilloscopes / 12

Where is the Synchronization Port? / 13

Z-Series or 90000 Q-Series Oscilloscope Environmental Requirements / 13

Power Requirements / 13

Airflow/Cooling Requirements / 13

Z-Series or 90000 Q-Series Oscilloscope Rack Requirements / 14

## 2 Two-Oscilloscope Rackmount System, Z-Series or 90000 Q-Series

Expansion Equipment Required / 15

Mounting Oscilloscopes in Rack / 16

Connecting the Equipment / 17

Parts in the N2104A (Two in Rack) Expansion Kit / 17

Sync Signal Connections / 17

Trig Out and 100 MHz Out Connections / 18

Connecting the Oscilloscopes / 19

## 3 Two-Oscilloscope Stackmount System, Z-Series or 90000 Q-Series

Expansion Equipment Required / 21

Parts in the N2105A (Two in Stack) Expansion Kit / 22

Mounting Oscilloscopes in Stack / 23

Connecting the Oscilloscopes / 26

## 4 Three- to Five-Oscilloscope Rackmount Systems, Z-Series or 90000 Q-Series

Expansion Equipment Required / 30

Mounting Oscilloscopes in Rack / 31

Connecting the Equipment / 32

- Parts in the N2106A (Add One) Expansion Kit / 32
- Sync Signal Connections / 32
- Trig Out and 100 MHz Out Connections / 33
- Connecting the Follower #2 Through Follower #4 Oscilloscopes / 34

## 5 Six- to Ten-Oscilloscope Rackmount Systems, Z-Series or 90000 Q-Series

- Expansion Equipment Required / 38
- Mounting Oscilloscopes in Racks / 39
- Connecting the Equipment / 40
  - Parts in the N2107A (Five to Six) Expansion Kit / 40
  - Sync Signal Connections / 41
  - Trig Out and 100 MHz Out Connections / 42
  - Connecting the Follower #5 Oscilloscope / 43
  - Connecting the Follower #6 Through Follower #9 Oscilloscopes / 45

## 6 Two-Oscilloscope System, V-Series or 90000 X-Series

- V-Series or 90000 X-Series Oscilloscope System Requirements / 48
  - Parts in the N2123A Multi-Frame Cable Kit / 48
- Connections for Synchronization / 49
- Connections for Reference Clock Skew Calibration / Drift Correction / 50
- Sample Rate Selection and Available Channels / 51
- Next Steps / 51

## 7 Three- to Five-Oscilloscope Rackmount Systems, V-Series or 90000 X-Series

- Expansion Equipment Required / 54
- Mounting Oscilloscopes in Rack / 55
- Connecting the Equipment / 56
  - Parts in the 3VINRK (Three in Rack) Expansion Accessory Set / 56
  - Parts in the PLUS1V (Add One) Expansion Accessory Set / 56
  - Sync Signal Connections / 56
  - Trig Out Signal Connections / 58
  - 10 MHz In Signal Connections / 60
  - Connecting the Three Oscilloscopes / 62
  - Connecting the Follower #3 Through Follower #4 Oscilloscopes / 64

## 8 Six- to Ten-Oscilloscope Rackmount Systems, V-Series or 90000 X-Series

- Expansion Equipment Required / 66
- Mounting Oscilloscopes in Racks / 68

Connecting the Equipment	/ 69
Parts in the PLUSRK (Five to Six) Expansion Accessory Set	/ 69
Sync Signal Connections	/ 69
Trig Out Signal Connections	/ 71
10 MHz In Signal Connections	/ 73
Connecting the Follower #5 Oscilloscope	/ 75
Connecting the Follower #6 Through Follower #9 Oscilloscopes	/ 77

## 9 Two-Oscilloscope System, S-Series, 9000 Series, or 90000A Series

S-Series, 9000 Series, or 90000A Series Oscilloscope Requirements	/ 80
Parts in the N2124A Multi-Frame Cable Kit	/ 80
Connections for Synchronization	/ 81
Connections for Reference Clock Skew Calibration / Drift Correction	/ 82
Sample Rate Selection and Available Channels	/ 83
Next Steps	/ 83

## 10 Next Steps

Calibrate the Oscilloscopes in the MultiScope System	/ 85
Use MultiScope Control Software	/ 86
Infiniium Oscilloscope Software on the Leader Oscilloscope	/ 86
D9010BSEO Infiniium Offline Oscilloscope Analysis Software	/ 86
N8822A MATLAB Time-Synchronization Software	/ 87
Performing Channel Deskew	/ 88
Parts in the N2122A MultiScope Channel Deskew Kit	/ 88

## Index



# 1 Z-Series or 90000 Q-Series MultiScope System Requirements

Z-Series or 90000 Q-Series Oscilloscope Requirements / 12

Z-Series or 90000 Q-Series Oscilloscope Environmental Requirements / 13

Z-Series or 90000 Q-Series Oscilloscope Rack Requirements / 14

This chapter describes the requirements for MultiScope systems, including oscilloscopes, environmental, rack, and host computer.



## Z-Series or 90000 Q-Series Oscilloscope Requirements

To set up a MultiScope system with Z-Series or 90000 Q-Series oscilloscopes, certain options or upgrades may be required.

### Infiniium Z-Series Oscilloscopes

The Infiniium Z-Series oscilloscopes are:

- DSA/DSOZ204A Infiniium oscilloscope: 20 GHz, 80 GSa/s.
- DSA/DSOZ254A Infiniium oscilloscope: 25 GHz, 80 GSa/s.
- DSA/DSOZ334A Infiniium oscilloscope: 33 GHz, 80 GSa/s.
- DSA/DSOZ504A Infiniium oscilloscope: 50 GHz, 160 GSa/s.
- DSA/DSOZ634A Infiniium oscilloscope: 63 GHz, 160 GSa/s.

The 20, 25, or 33 GHz Z-Series oscilloscopes require a sync port (option DSOZ000-601 or N2109A upgrade) before they can be used in a multi-Infiniium oscilloscope system.

### Infiniium 90000 Q-Series Oscilloscopes

The Infiniium 90000 Q-Series oscilloscopes are:

- DSA/DSOX92004Q Infiniium oscilloscope: 20 GHz, 80 GSa/s.
- DSA/DSOX92504Q Infiniium oscilloscope: 25 GHz, 80 GSa/s.
- DSA/DSOX93304Q Infiniium oscilloscope: 33 GHz, 80 GSa/s.
- DSA/DSOX95004Q Infiniium oscilloscope: 50 GHz, 160 GSa/s.
- DSA/DSOX96204Q Infiniium oscilloscope: 63 GHz, 160 GSa/s.

#### **Required Upgrades**

The Infiniium 90000 Q-Series oscilloscopes require these upgrades:

- N2108A Infiniium 90000 Q-Series motherboard upgrade kit.

All 90000 Q-Series oscilloscope models require this upgrade before they can be used in a MultiScope system.

- N2109A add sync port to 20, 25, or 33 GHz models.

Only the 20, 25, or 33 GHz 90000 Q-Series oscilloscope models require this upgrade before they can be used in a MultiScope system.

## Where is the Synchronization Port?

On 30, 25, and 33 GHz models, the synchronization port is located at the bottom right corner of the front of the instrument, labeled **Sync In**.

On 50 and 63 GHz models, the location depends on whether:

- You want to use the oscilloscope's two 50 GHz or 63 GHz RealEdge inputs to acquire the signals under test.

In this case, use the 33 GHz channel 4 input as the synchronization port.

- You want to use the oscilloscope's four 33 GHz channel 1-4 inputs to acquire the signals under test.

In this case, use the oscilloscope's channel 3R RealEdge input as the synchronization port.

## Z-Series or 90000 Q-Series Oscilloscope Environmental Requirements

Oscilloscopes are sensitive measurement instruments, and some environmental conditions must be present to ensure that the oscilloscope delivers the best possible measurement accuracy.

### Power Requirements

**Table 1** Power Requirements for Each Oscilloscope

Power (for each oscilloscope)	100 - 240 VAC $\pm$ 10% at 50/60 Hz; Typical input power for models $\leq$ 33 GHz 1280 Watts Maximum input power for models $>$ 33 GHz 1350 Watts Well regulated power is required for 100-120 VAC operation
-------------------------------	-----------------------------------------------------------------------------------------------------------------------------------------------------------------------------------------------------------------------

Multiply these requirements by the number of oscilloscopes in your MultiScope system.

### Airflow/Cooling Requirements

Individually, in a stackmount configuration, or in a rack, Keysight Infiniium Z-Series and Q-Series oscilloscopes are qualified to operate in a *controlled office environment* from 5-40 °C.

The oscilloscope's performance characteristics are specified for operating temperatures within  $\pm$ 5 °C of the calibrated temperature. Temperature deviations exceeding  $\pm$ 5 °C of the previous calibration temperature require a new user calibration.

For proper airflow:

- You must provide 100 mm clearance on each side of the oscilloscopes and 39 mm of clearance on the back.
- Do not place the oscilloscopes side-by-side with other instruments blowing warm air.

An oscilloscope will shut down when its internal sensor detects the intake air is >40 °C.

- When using oscilloscopes in a rack:
  - Use a rack without sides.
  - Avoid rack-to-rack thermal interaction. In other words, do not place a rack side-by-side with another rack blowing warm air.

See also: **“Z-Series or 90000 Q-Series Oscilloscope Rack Requirements”** on page 14.

## Z-Series or 90000 Q-Series Oscilloscope Rack Requirements

Keysight recommends racks without sides.

### CAUTION

**Do not use racks with sides.**

**Keysight Infiniium Z-Series and Q-Series oscilloscopes have not been qualified in racks with sides. Active airflow would likely be needed but may not be sufficient for proper operation of the oscilloscope.**

---

You must provide 100 mm clearance on each side of a rack.

Do not place a rack side-by-side with another rack blowing warm air.

## 2 Two-Oscilloscope Rackmount System, Z-Series or 90000 Q-Series

Expansion Equipment Required / 15  
Mounting Oscilloscopes in Rack / 16  
Connecting the Equipment / 17

### Expansion Equipment Required

**Table 2** Equipment Required for Two-Oscilloscope Rackmount System

Model	Description	Quantity
N2104A	Dual Infiniium Frame Channel Alignment Kit (Rackmount)	1
N2759A (or DSOX90000-1CM)	Rackmount kit (or option)	2

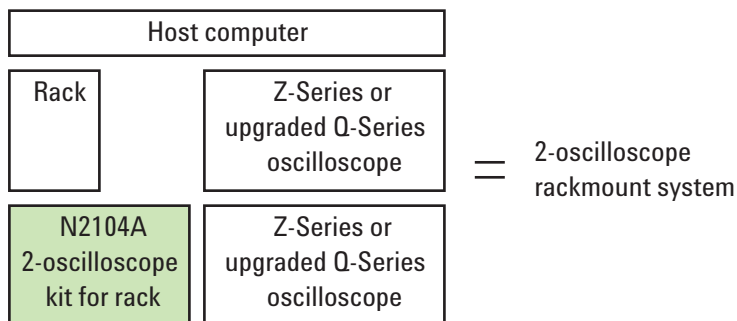

**Figure 3** Expansion Accessories Required for Two-Oscilloscope Rackmount System

## Mounting Oscilloscopes in Rack

Oscilloscopes take 7U of rack space and the power divider assembly takes 1U of rack space.

**NOTE**

Because of cable lengths, and to ease further oscilloscope expansion, it is recommended to place the oscilloscopes in the specified relative rack locations.

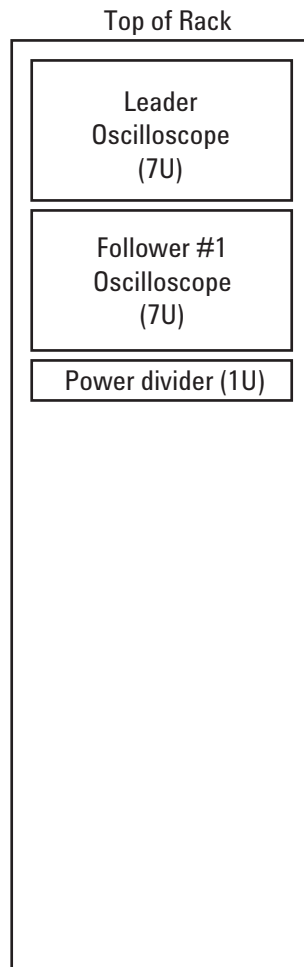
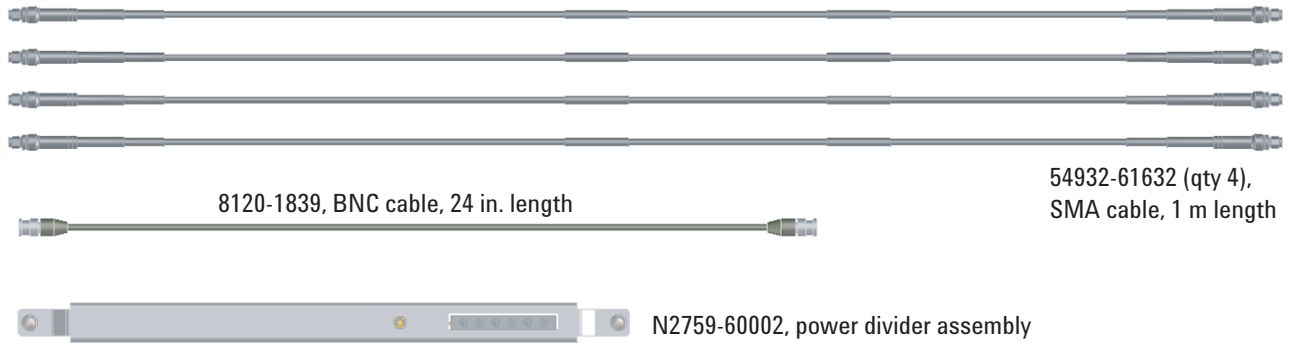





**Figure 4** Oscilloscope Locations in Rack

Using the instructions in the *Rackmount Kit User's Guide*, mount oscilloscopes in their designated rack locations.

## Connecting the Equipment

### Parts in the N2104A (Two in Rack) Expansion Kit



-  1250-2818 (qty 6), right angle male to female SMA adapter
-  1250-3745 (qty 4), 50 Ω SMA terminator
-  1250-3758 (qty 3), connector saver for Ch4 or Sync In input, 3.5 mm (f) to 3.5 mm (f)
-  1250-3782 (qty 2), connector saver for Ch3R RealEdge input, 2.4 mm (f) to 3.5 mm (f)

### Sync Signal Connections

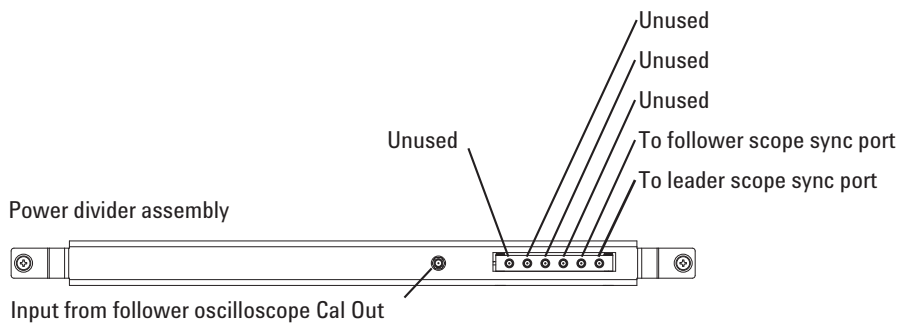

Place 1250-2818 adapters on all used inputs/outputs (including oscilloscope synchronization port inputs)

Place 1250-3745 terminators on all unused outputs

## Trig Out and 100 MHz Out Connections

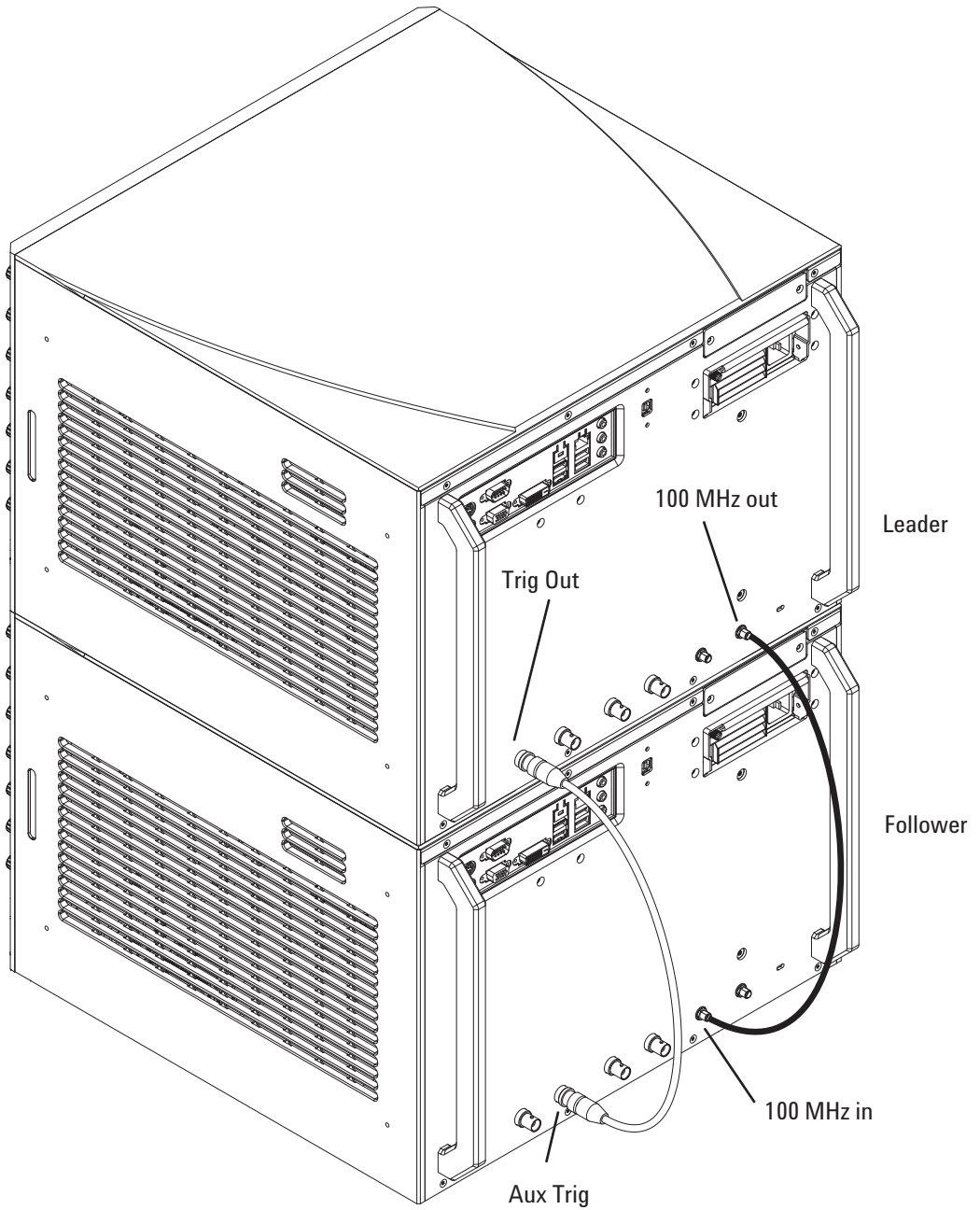



## Connecting the Oscilloscopes

Using the parts in a N2104A (two in rack) expansion kit, follow these instructions:

- 1 Mount the N2759-60002 power divider assembly in the designated rack location. See **“Mounting Oscilloscopes in Rack”** on page 16.
- 2 Make sure the synchronization port input on each oscilloscope has a connector saver:
  - Use the 1250-3758 adapter for the dedicated **Sync In** channel inputs or for the 33 GHz channel 4 inputs when used as the synchronization port in 50 GHz or 63 GHz bandwidth systems.
  - Use the 1250-3782 adapter when the channel 3R RealEdge inputs are used as the synchronization port on 50 GHz or 63 GHz bandwidth models configured in 20 GHz, 25 GHz, or 33 GHz bandwidth systems.
- 3 Connect the six right angle male to female SMA adapters (1250-2818) to:
  - The follower oscilloscope’s **Cal Out**.
  - The power divider assembly input.
  - The two right-most power divider assembly outputs (2 adapters).
  - Both oscilloscopes' synchronization port inputs (2 adapters).
- 4 Connect the four SMA 50  $\Omega$  terminators (1250-3745) to the four unused left-most power divider assembly outputs.
- 5 Connect the SMA cables between the power divider assembly output and the oscilloscopes' synchronization port inputs. See **“Sync Signal Connections”** on page 17.
- 6 Connect the BNC cable between the **Trig Out** and **Aux Trig** connectors. See **“Trig Out and 100 MHz Out Connections”** on page 18.
- 7 Connect an SMA cable between the **100 MHz Out** and **100 MHz In** connectors. See **“Trig Out and 100 MHz Out Connections”** on page 18.
- 8 Connect the oscilloscopes to the host computer through the desired remote interface connection (LAN, USB, etc.).
- 9 If these are the last oscilloscopes to be connected, see **Chapter 10**, “Next Steps,” starting on page 85.

2 Two-Oscilloscope Rackmount System, Z-Series or 90000 Q-Series

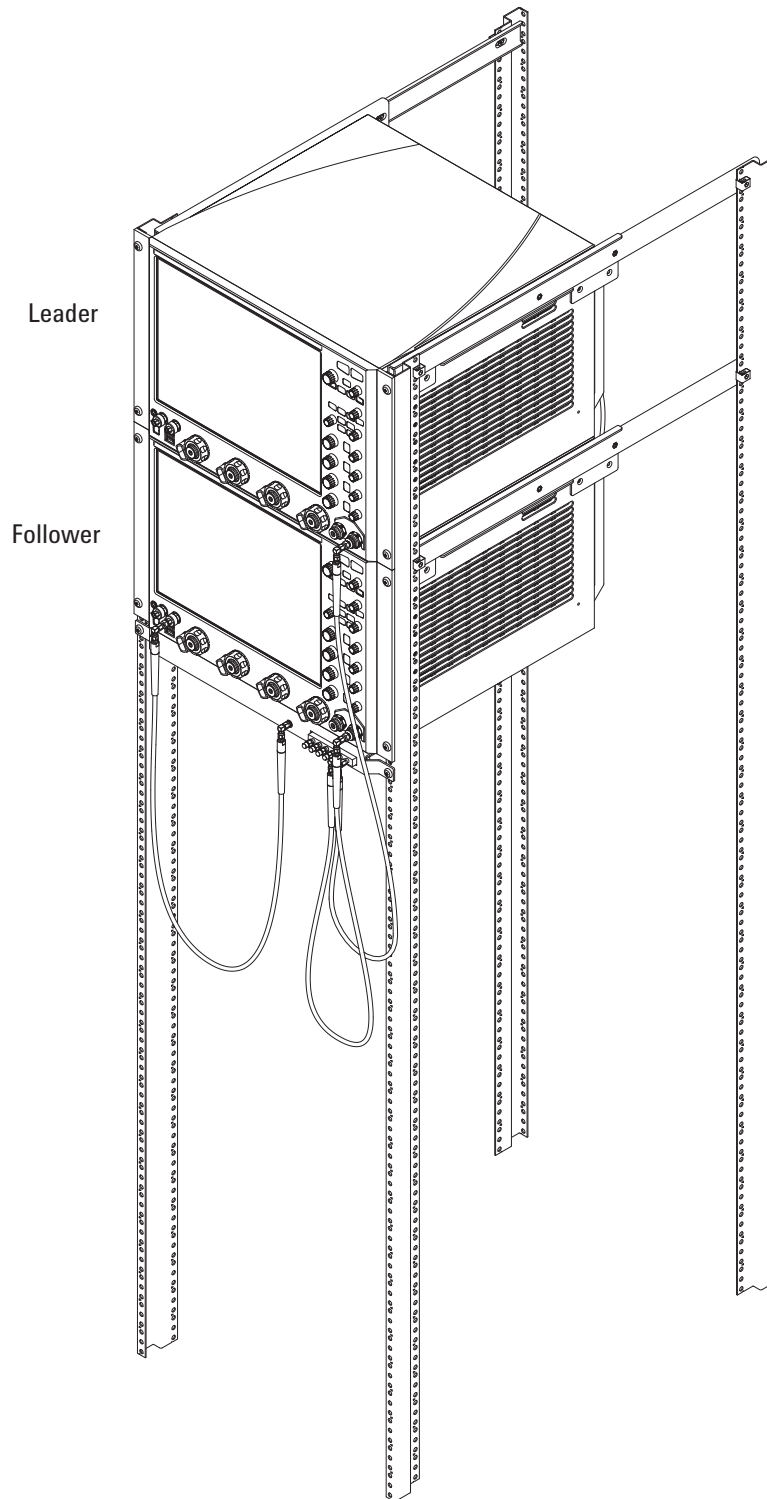

# 3 Two-Oscilloscope Stackmount System, Z-Series or 90000 Q-Series

Expansion Equipment Required / 21

Parts in the N2105A (Two in Stack) Expansion Kit / 22

Mounting Oscilloscopes in Stack / 23

Connecting the Oscilloscopes / 26

## Expansion Equipment Required

**Table 3** Equipment Required for Two-Oscilloscope Stackmount System

Model	Description	Quantity
N2105A	Dual Infiniium Frame Channel Alignment Kit (Stackmount)	1

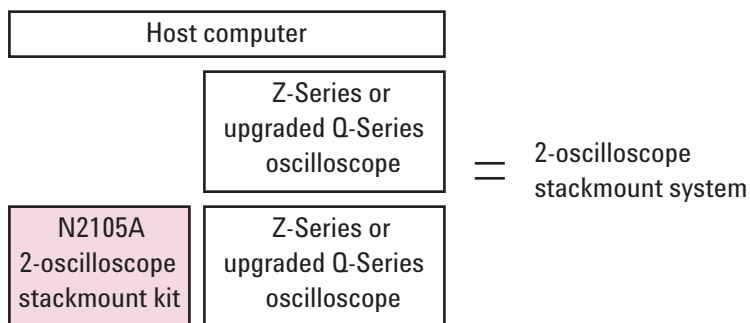

**Figure 5** Expansion Accessories Required for Two-Oscilloscope Stackmount System

## Parts in the N2105A (Two in Stack) Expansion Kit

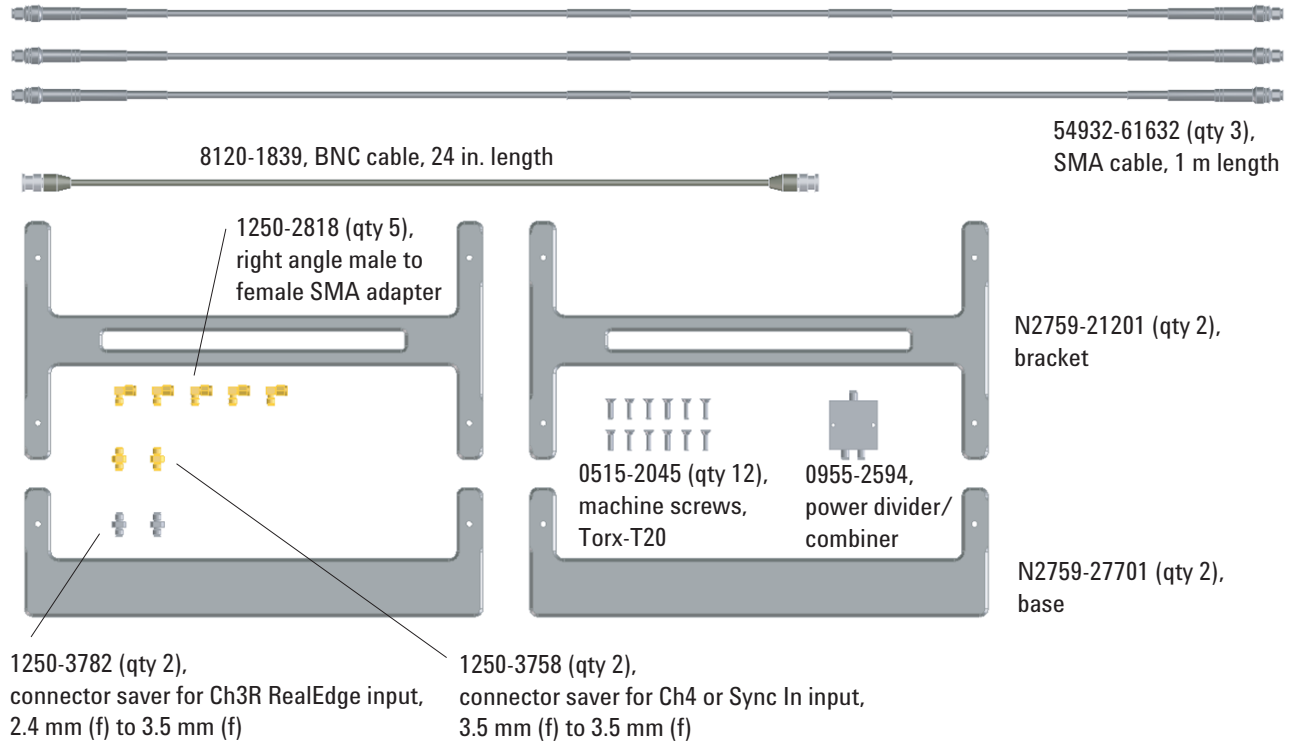

## Mounting Oscilloscopes in Stack

Just like a rackmount configuration, the top oscilloscope in the stack will be the leader oscilloscope, and the bottom oscilloscope will be the follower oscilloscope.

- 1** Remove the handles on the follower oscilloscope. (The removed screws will not be re-used.)
- 2** Connect the base pieces to the follower oscilloscope:
  - a** Attach one base piece, and the handle on top of it, using two of the supplied 0515-2045 machine screws.
  - b** Repeat on the other side.

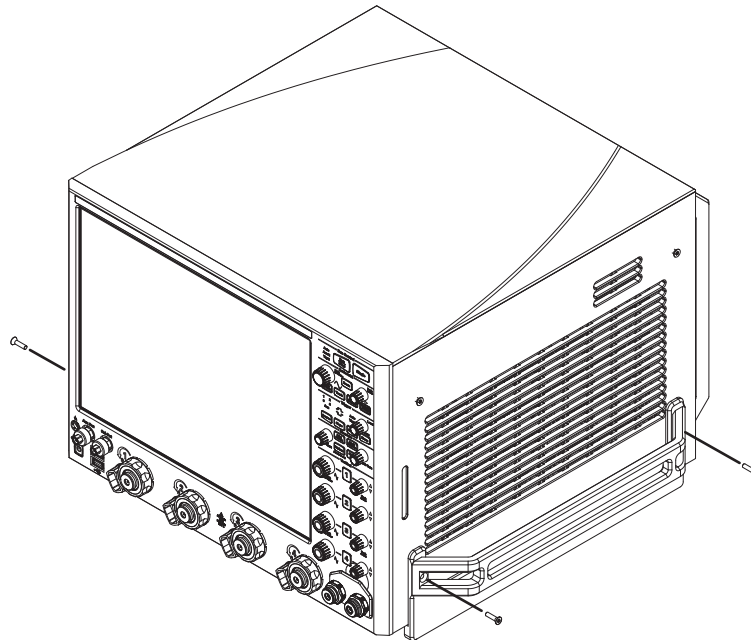

- 3 Connect the bracket pieces to the follower oscilloscope:
  - a Attach one bracket piece, and the handle on top of it, using two of the supplied 0515-2045 machine screws.
  - b Repeat on the other side.

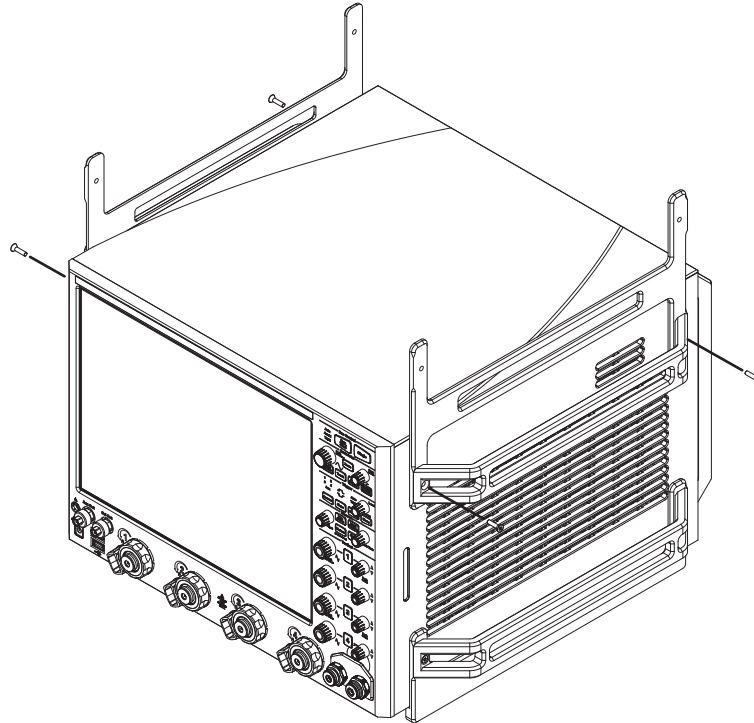

- 4 Remove the lower handles on the leader oscilloscope. (The removed screws will not be used again.)
- 5 Lift the leader oscilloscope on to the top of the follower oscilloscope.

**CAUTION**

Two people are required to lift the instrument.

- 6 Attach the bracket pieces, and the handles on top of them, to the second oscilloscope using four of the supplied 0515-2045 machine screws.

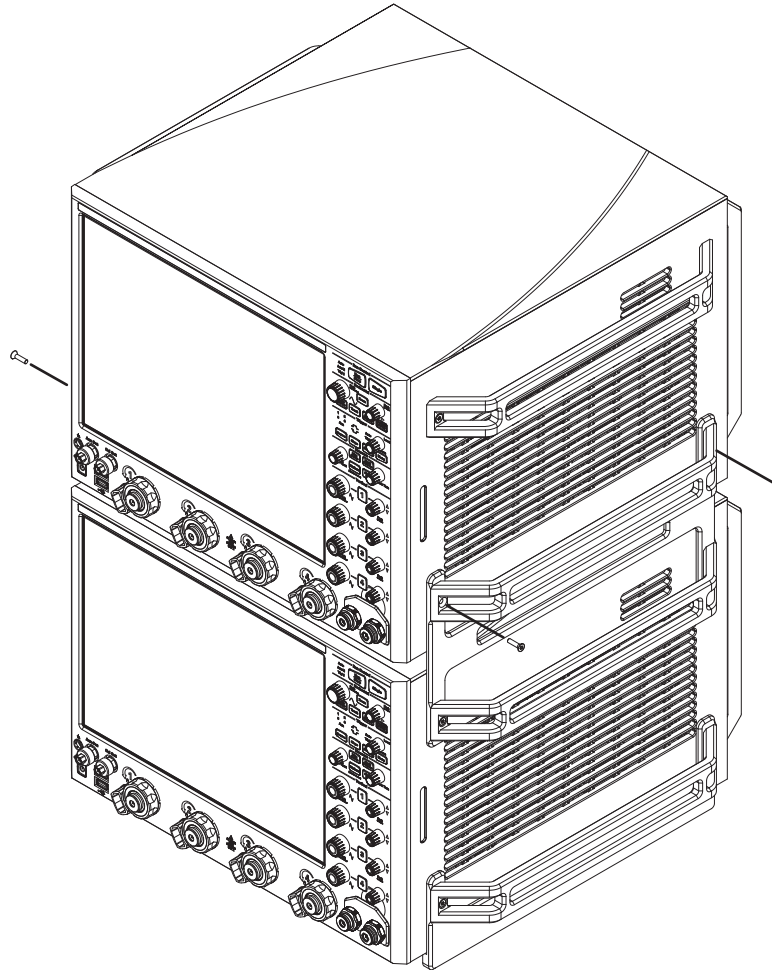



## Connecting the Oscilloscopes

Once you have mounted the oscilloscopes in a stack, make the connections between the instruments:

- 1** Make sure the synchronization port input on each oscilloscope has a connector saver:
  - Use the 1250-3758 adapter for the dedicated **Sync In** channel inputs or for the 33 GHz channel 4 inputs when used as the synchronization port in 50 GHz or 63 GHz bandwidth systems.
  - Use the 1250-3782 adapter when the channel 3R RealEdge inputs are used as the synchronization port on 50 GHz or 63 GHz bandwidth models configured in 20 GHz, 25 GHz, or 33 GHz bandwidth systems.
- 2** Connect the five right angle male to female SMA adapters (1250-2818) to:
  - The power divider/combiner (use 3 adapters).
  - Both oscilloscopes' synchronization port inputs (2 adapters).
- 3** Connect the power divider/combiner input (single connector side) to the follower oscilloscope's **Cal Out**.

- 4 Connect the SMA cables between the power divider outputs (two connector side) and the oscilloscopes' synchronization port inputs.

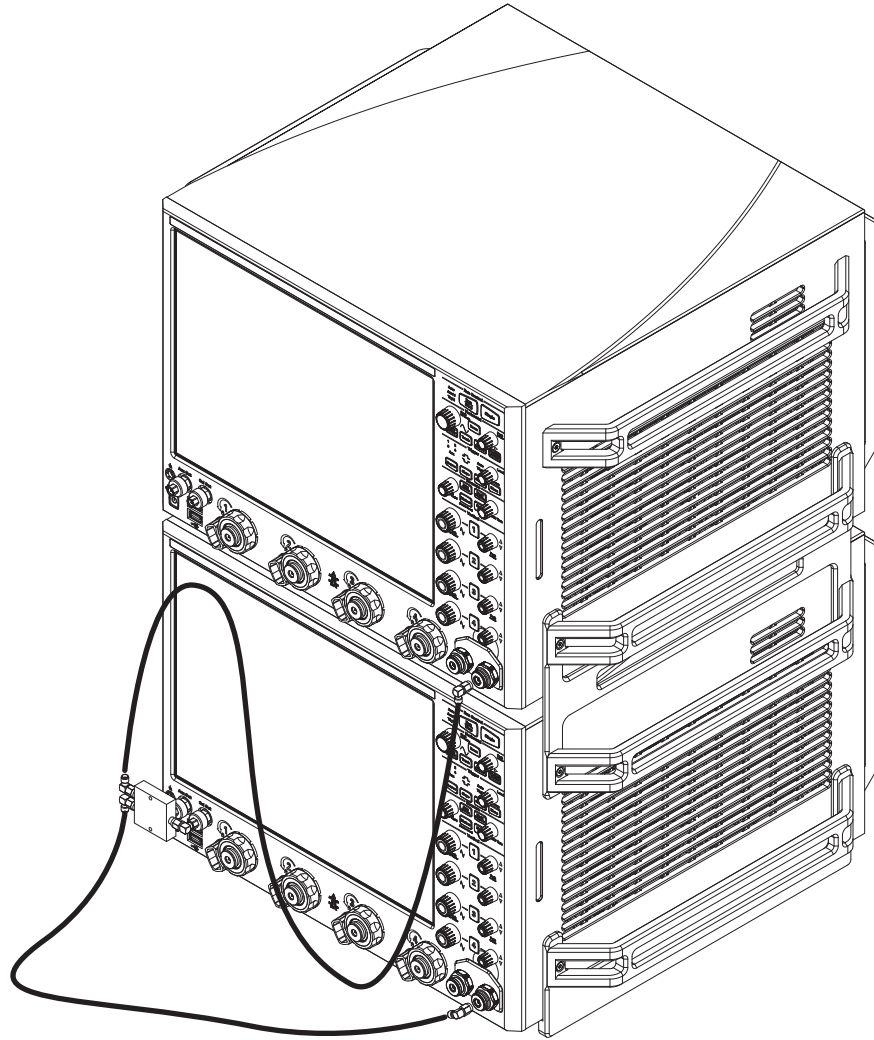

- 5 Connect the BNC cable between the **Trig Out** on the leader oscilloscope and **Aux Trig** on the follower oscilloscope.
- 6 Connect an SMA cable between the **100 MHz Out** on the leader oscilloscope and **100 MHz In** on the follower oscilloscope.

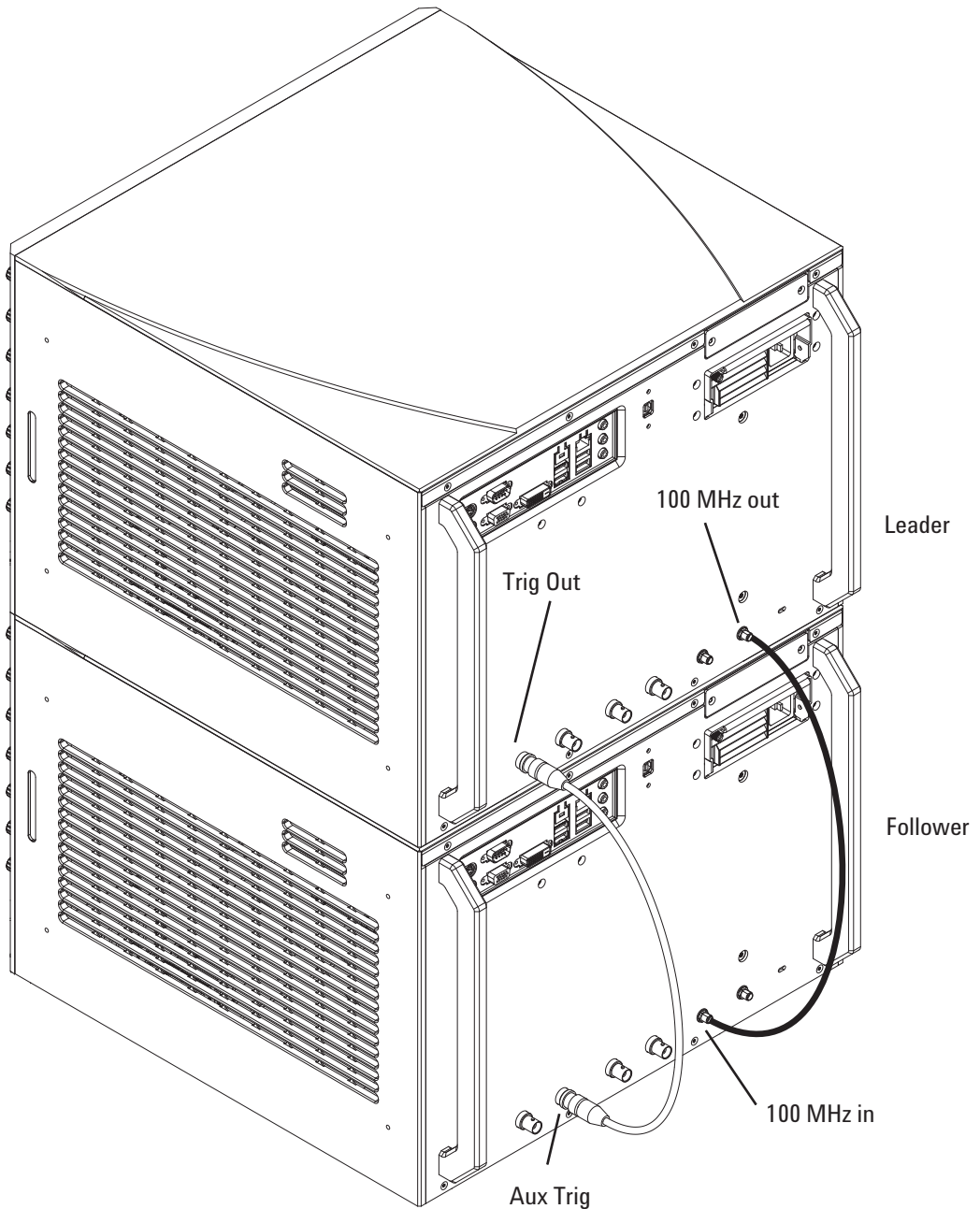

- 7 Connect the oscilloscopes to the host computer through the desired remote interface connection (LAN, USB, etc.).
- 8 See [Chapter 10](#), “Next Steps,” starting on page 85.

## 4 Three- to Five-Oscilloscope Rackmount Systems, Z-Series or 90000 Q-Series

Expansion Equipment Required / 30

Mounting Oscilloscopes in Rack / 31

Connecting the Equipment / 32

## Expansion Equipment Required

**Table 4** Equipment Required for 3-to-5-Oscilloscope Rackmount System

Model	Description	Quantity
N2104A	Dual Infiniium Frame Channel Alignment Kit (Rackmount)	1
N2106A	Infiniium Frame Expansion Channel Alignment Kit (Expand One Frame)	(# of scopes) - 2
N2759A (or DSOX90000-1CM)	Rackmount kit (or option)	(# of scopes)

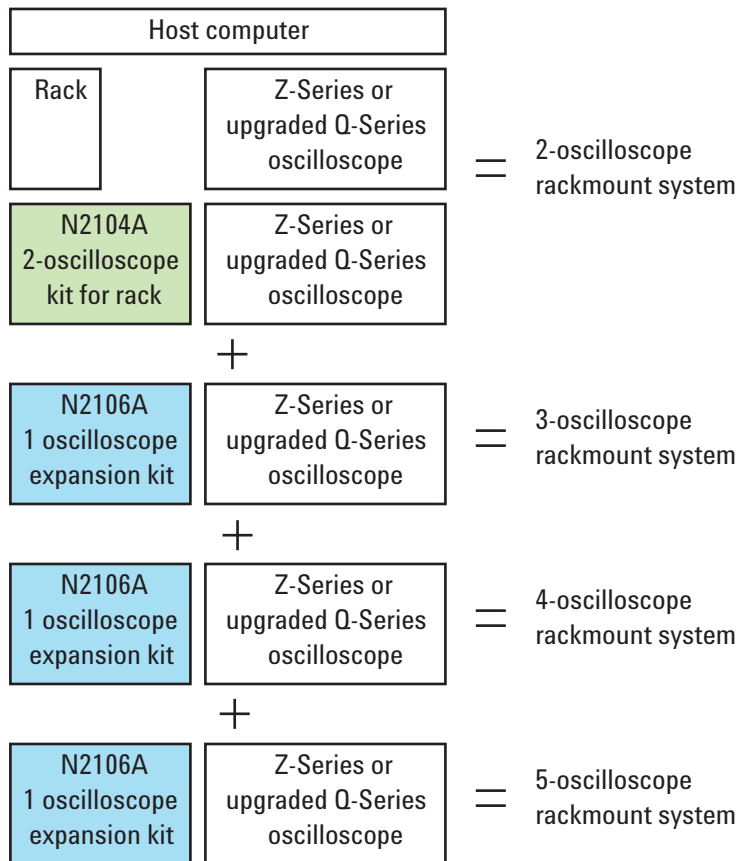

**Figure 6** Expansion Accessories Required for Three- to Five-Oscilloscope Rackmount System

## Mounting Oscilloscopes in Rack

Oscilloscopes take 7U of rack space and the power divider assembly takes 1U of rack space.

**NOTE**

Because of cable lengths, and to ease further oscilloscope expansion, it is recommended to place the oscilloscopes in the specified relative rack locations.

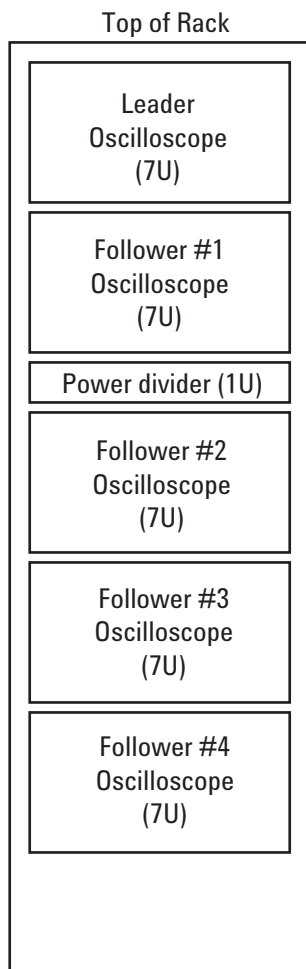
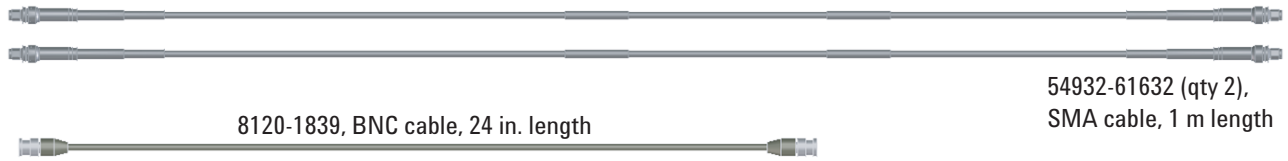

**Figure 7** Oscilloscope Locations in Rack

Using the instructions in the *Rackmount Kit User's Guide*, mount oscilloscopes in their designated rack locations.

## Connecting the Equipment

### Parts in the N2106A (Add One) Expansion Kit



- 1250-2818 (qty 2), right angle male to female SMA adapter
- 1250-3758, connector saver for Ch4 or Sync In input, 3.5 mm (f) to 3.5 mm (f)
- 1250-3782, connector saver for Ch3R RealEdge input, 2.4 mm (f) to 3.5 mm (f)

### Sync Signal Connections

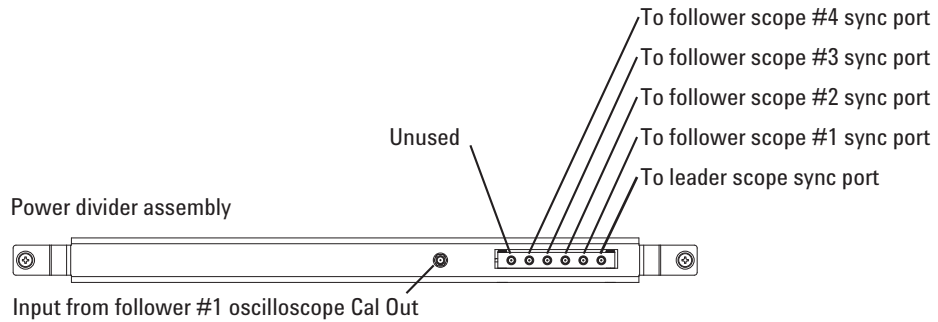

Place 1250-2818 adapters on all used inputs/outputs  
(including oscilloscope synchronization port inputs)

Place 1250-3745 terminators on all unused outputs



## Trig Out and 100 MHz Out Connections

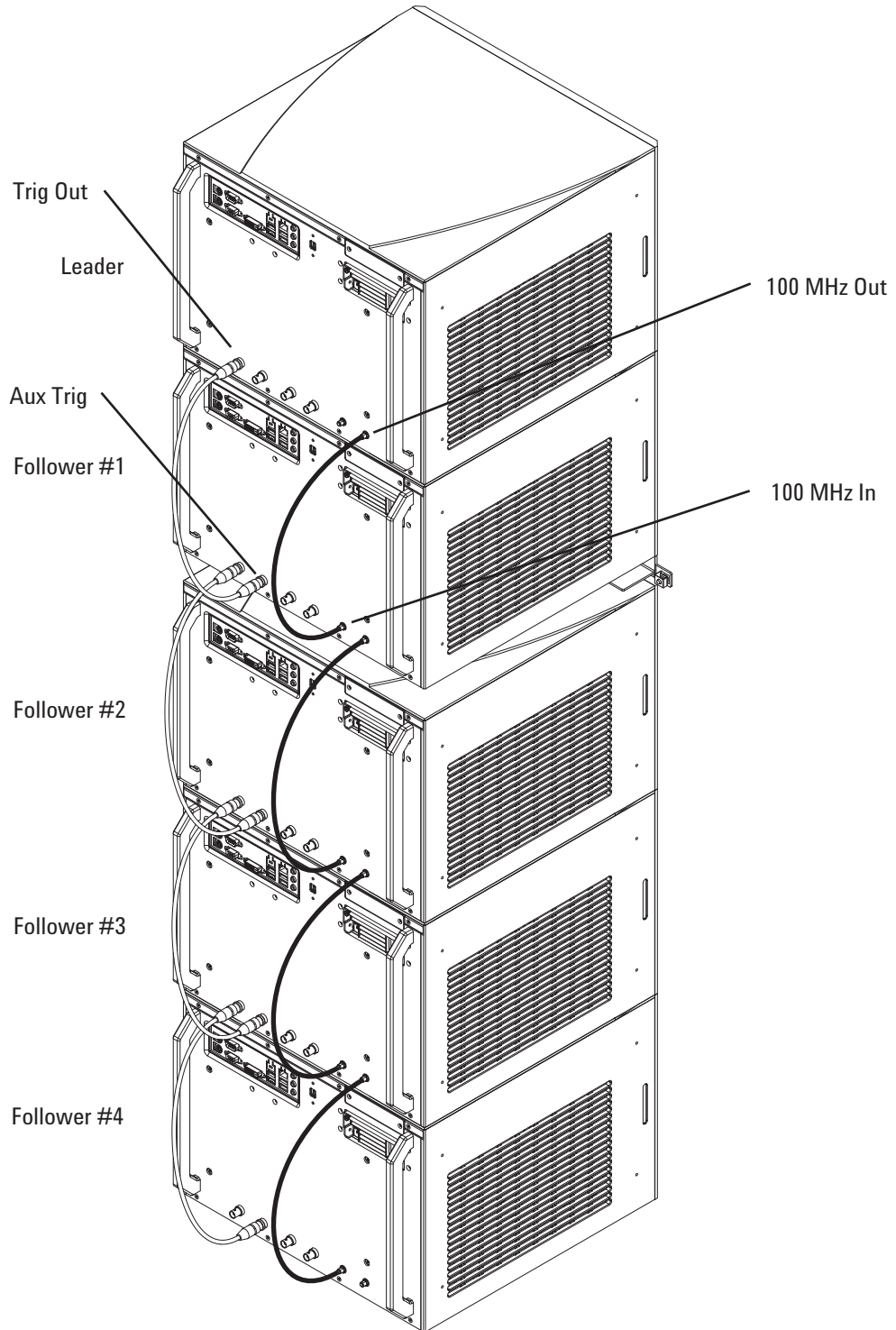

## Connecting the Follower #2 Through Follower #4 Oscilloscopes

Before connecting the follower #2 through follower #4 oscilloscopes, first follow the instructions for connecting a two-oscilloscope rackmount system in **“Connecting the Oscilloscopes”** on page 19.

Then, for each of the oscilloscopes from follower #2 to follower #4, using the parts in a N2106A (add one) expansion kit, follow these instructions:

- 1 Remove the SMA 50  $\Omega$  terminator (1250-3745) from the power divider output that will be used for the oscilloscope. See **“Sync Signal Connections”** on page 32.
- 2 Make sure the oscilloscope’s synchronization port input has a connector saver:
  - Use the 1250-3758 adapter for a dedicated **Sync In** channel input or for the 33 GHz channel 4 input when used as the synchronization port in 50 GHz or 63 GHz bandwidth systems.
  - Use the 1250-3782 adapter when the channel 3R RealEdge input is used as the synchronization port on 50 GHz or 63 GHz bandwidth models configured in 20 GHz, 25 GHz, or 33 GHz bandwidth systems.
- 3 Connect the two right angle male to female SMA adapters (1250-2818) to:
  - The power divider output that you just removed a terminator from.
  - The oscilloscope’s synchronization port input.
- 4 Connect the SMA cable between the power divider output and the oscilloscope’s synchronization port input.
- 5 Connect the BNC cable between the previous oscilloscope’s **Trig Out** connector to this oscilloscope’s **Aux Trig** connector. See **“Trig Out and 100 MHz Out Connections”** on page 33.
- 6 Connect an SMA cable between the previous oscilloscope’s **100 MHz Out** connector to this oscilloscope’s **100 MHz In** connector. See **“Trig Out and 100 MHz Out Connections”** on page 33.
- 7 Connect the oscilloscope to the host computer through the desired remote interface connection (LAN, USB, etc.).
- 8 If this is the last oscilloscope to be connected, see **Chapter 10**, “Next Steps,” starting on page 85.

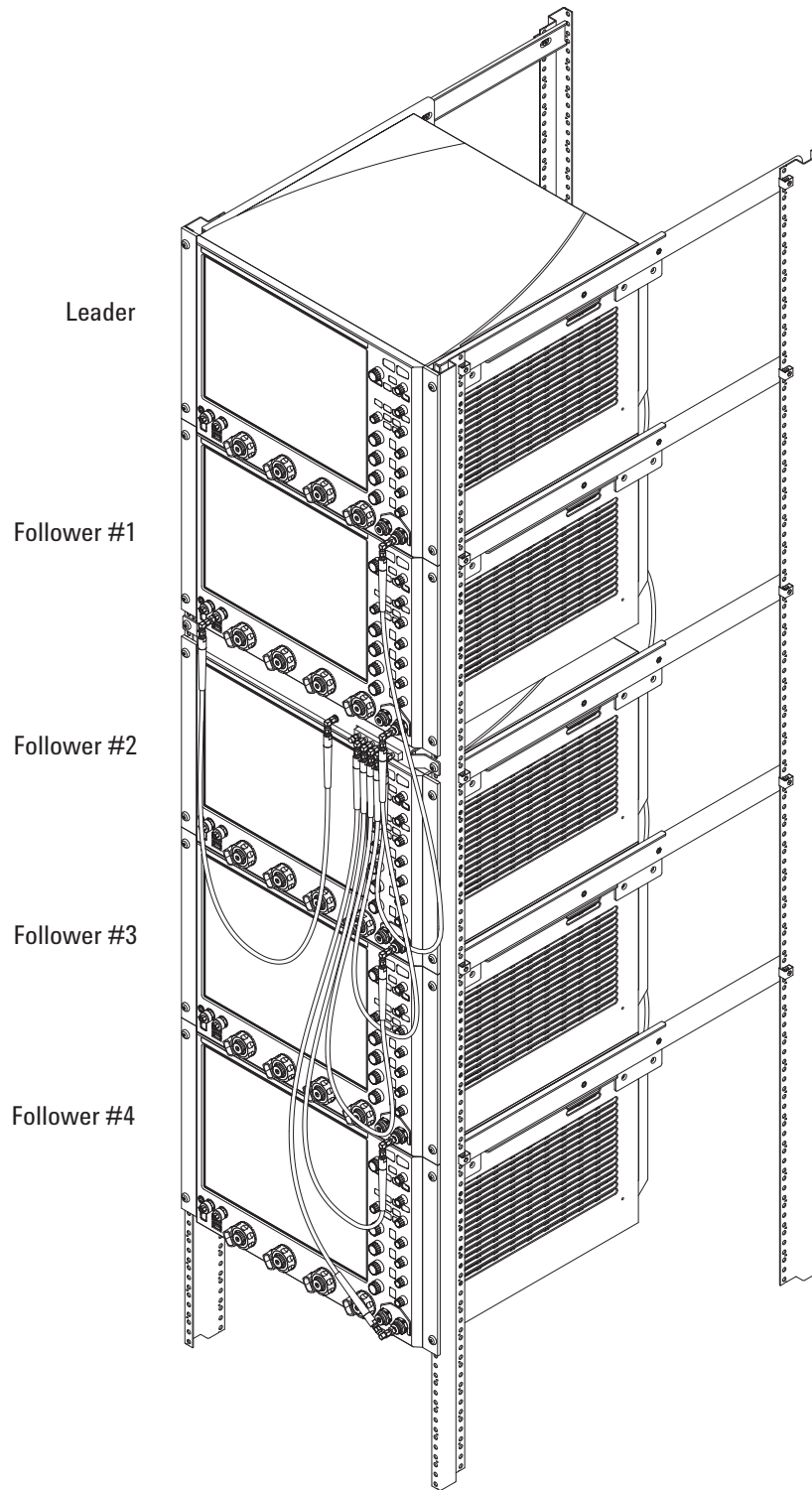

#### 4 Three- to Five-Oscilloscope Rackmount Systems, Z-Series or 90000 Q-Series

## 5 Six- to Ten-Oscilloscope Rackmount Systems, Z-Series or 90000 Q-Series

Expansion Equipment Required / 38

Mounting Oscilloscopes in Racks / 39

Connecting the Equipment / 40

## Expansion Equipment Required

**Table 5** Equipment Required for 6-to-10-Oscilloscope Rackmount System

Model	Description	Quantity
N2104A	Dual Infiniium Frame Channel Alignment Kit (Rackmount)	1
N2106A	Infiniium Frame Expansion Channel Alignment Kit (Expand One Frame)	(# of scopes) - 3
N2107A	Infiniium Frame Expansion Kit (Expand One Rack)	1
N2759A (or DSOX90000-1CM)	Rackmount kit (or option)	(# of scopes)

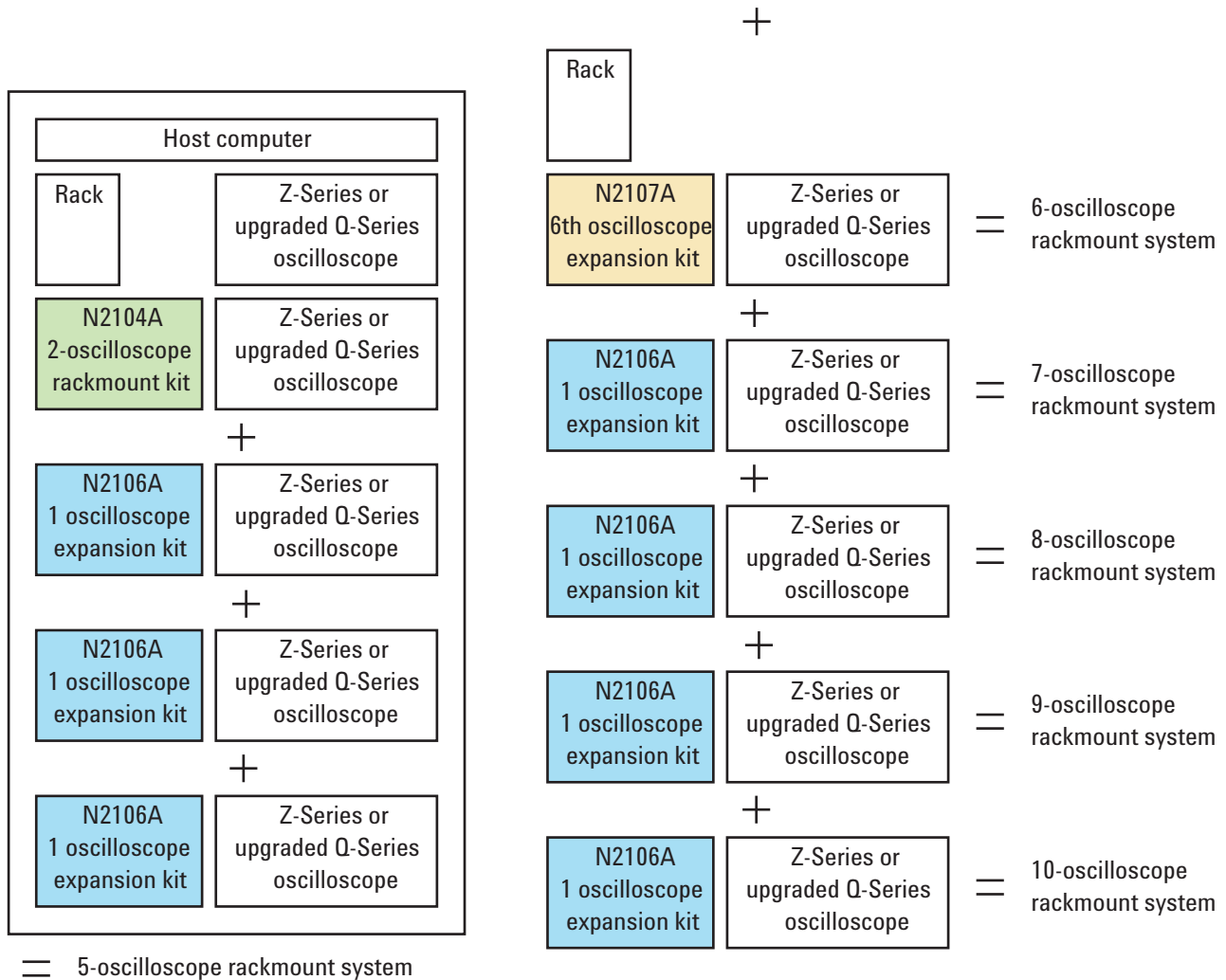

**Figure 8** Expansion Accessories Required for Six- to Ten-Oscilloscope Rackmount System

## Mounting Oscilloscopes in Racks

Oscilloscopes take 7U of rack space and the power divider assembly takes 1U of rack space.

### NOTE

Because of cable lengths, and to ease further oscilloscope expansion, it is recommended to place the oscilloscopes in the specified relative rack locations.

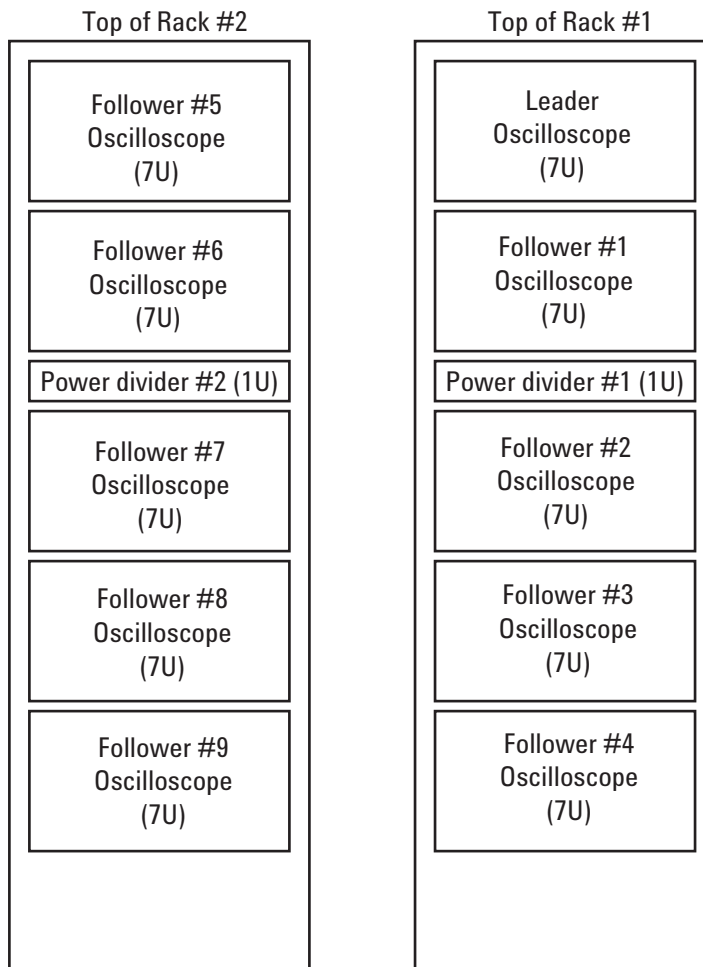
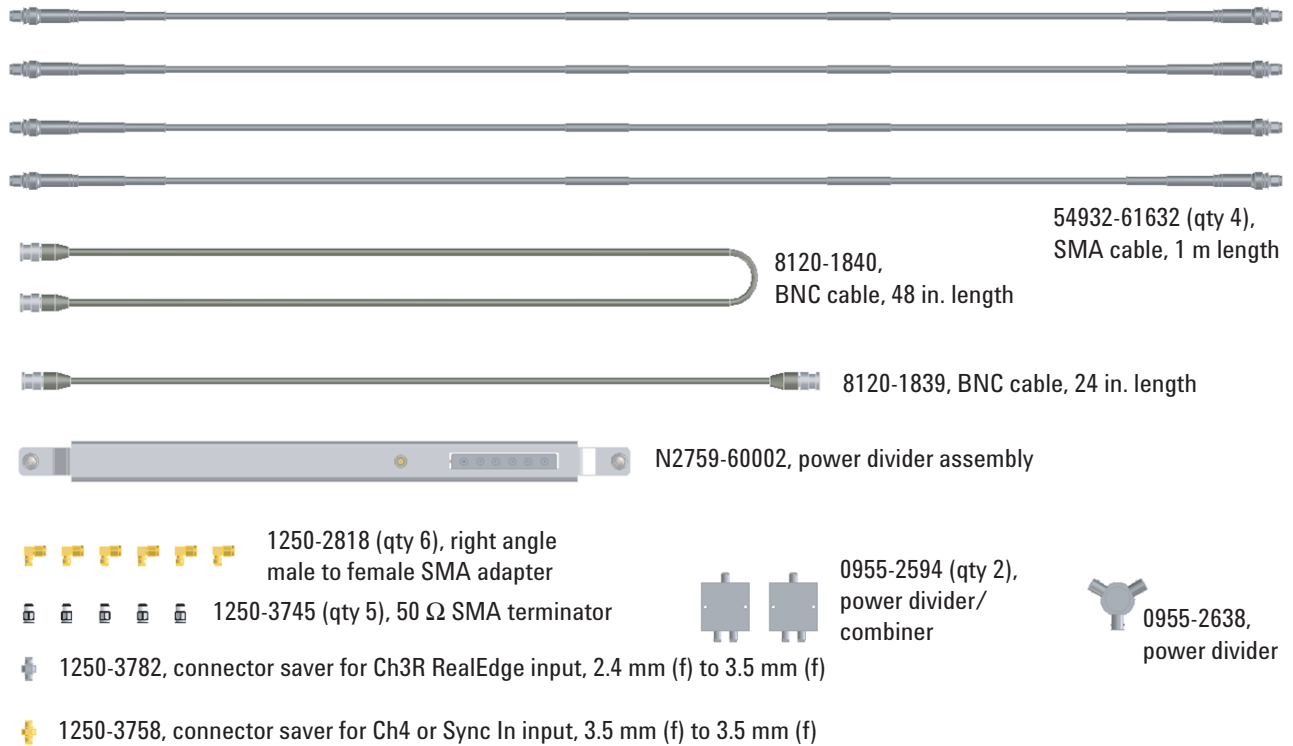

**Figure 9** Oscilloscope Locations in Racks

Using the instructions in the *Rackmount Kit User's Guide*, mount oscilloscopes in their designated rack locations.

## Connecting the Equipment

### Parts in the N2107A (Five to Six) Expansion Kit





## Sync Signal Connections

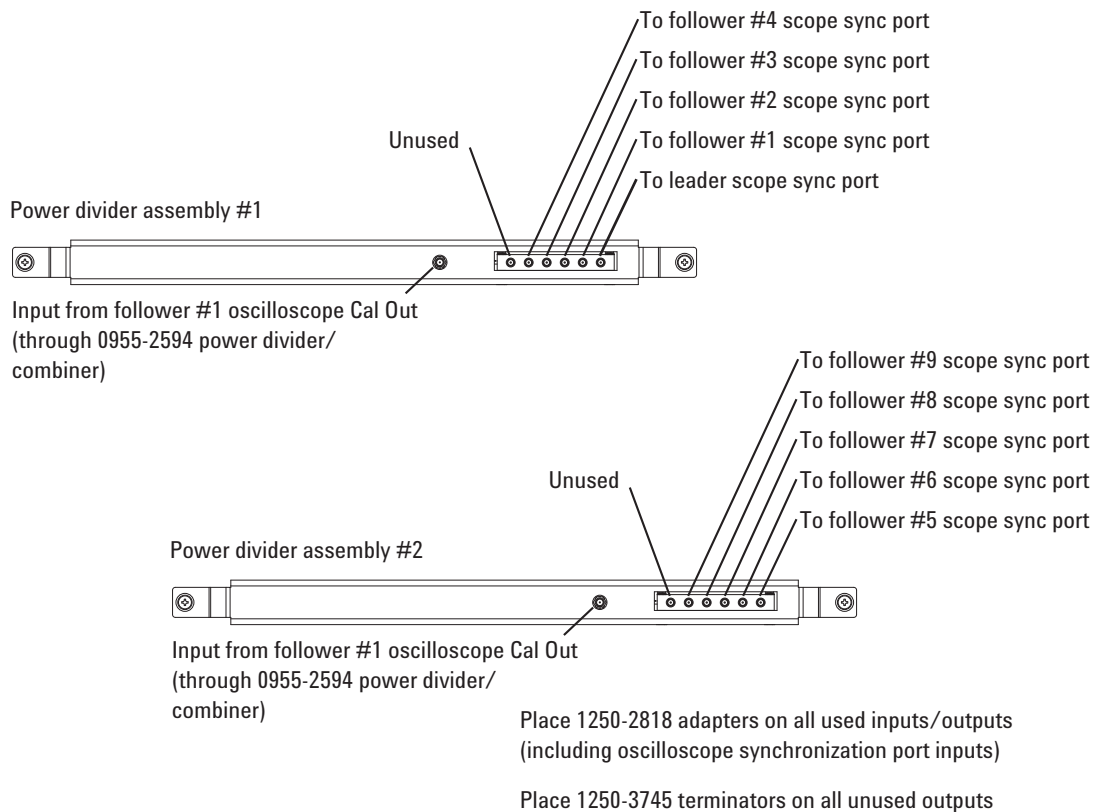

### Trig Out and 100 MHz Out Connections

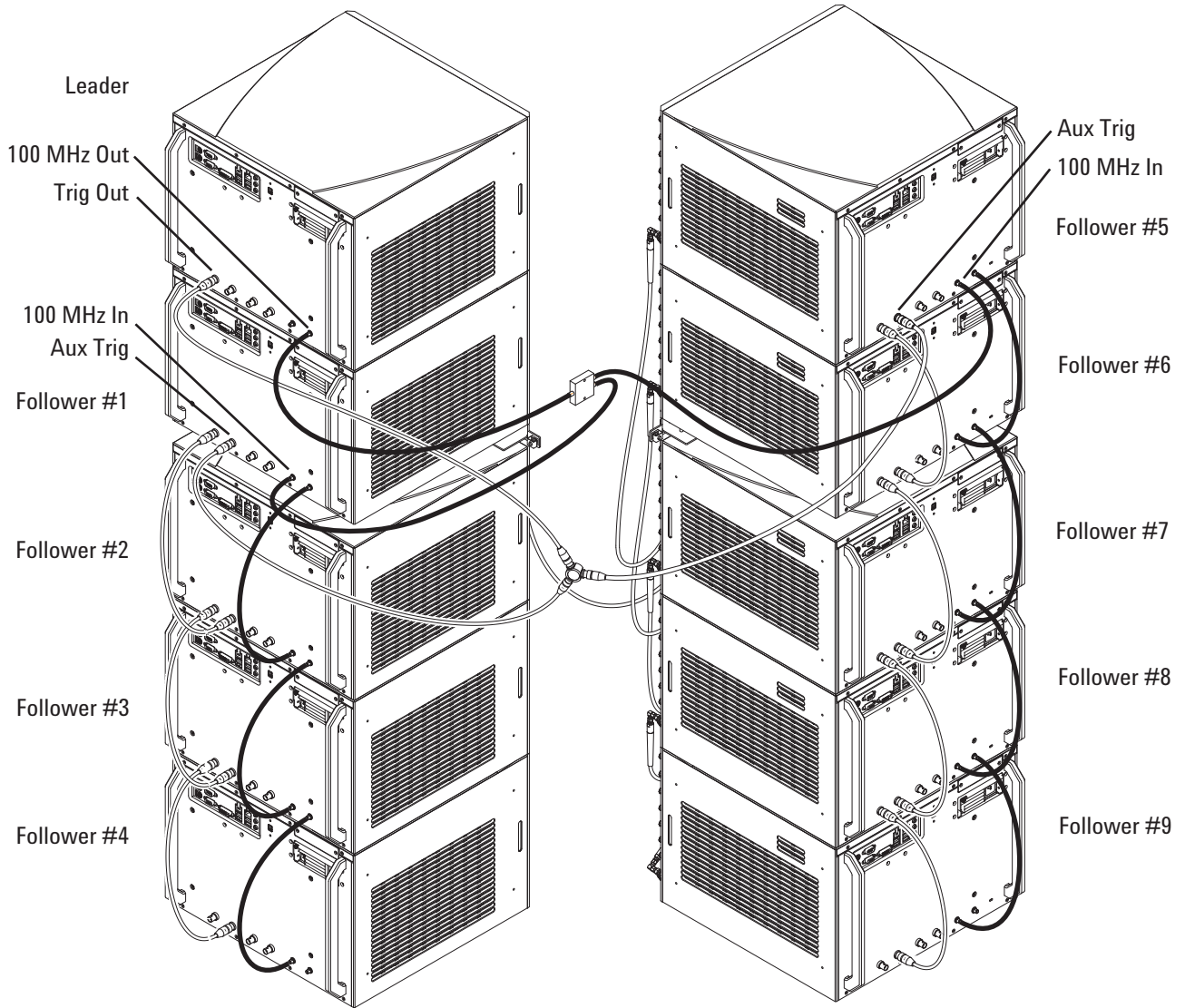

## Connecting the Follower #5 Oscilloscope

Before connecting the follower #5 oscilloscope, first follow the instructions for connecting a 3-to-5-oscilloscope rackmount system in **“Connecting the Follower #2 Through Follower #4 Oscilloscopes”** on page 34.

Then, for the follower #5 oscilloscope (in the second rack), using the parts in a N2107A (five to six) expansion kit, follow these instructions:

- 1 Mount the second N2759-60002 power divider assembly in the designated rack location. See **“Mounting Oscilloscopes in Racks”** on page 39.
- 2 Make sure the follower #5 oscilloscope’s synchronization port input has a connector saver:
  - Use the 1250-3758 adapter for a dedicated **Sync In** channel input or for the 33 GHz channel 4 input when used as the synchronization port in 50 GHz or 63 GHz bandwidth systems.
  - Use the 1250-3782 adapter when the channel 3R RealEdge input is used as the synchronization port on 50 GHz or 63 GHz bandwidth models configured in 20 GHz, 25 GHz, or 33 GHz bandwidth systems.
- 3 Connect three right angle male to female SMA adapters (1250-2818) to:
  - The power divider assembly input.
  - The power divider assembly’s right-most output.
  - The follower #5 oscilloscope’s synchronization port input.
- 4 Connect the five SMA 50  $\Omega$  terminators (1250-3745) to the five left-most power divider outputs.
- 5 Disconnect the SMA cable from the follower #1 oscilloscope’s **Cal Out** and place it on one of a 0955-2594 power divider/combiner outputs.
- 6 Connect the power divider/combiner input (single connector side) to the follower #1 oscilloscope’s **Cal Out**.
- 7 Connect one SMA cable between the power divider/combiner’s second output and the second power divider assembly’s input.
- 8 Connect the other SMA cable between the second power divider assembly’s output and the follower #5 oscilloscope’s synchronization port input.
- 9 Re-configure the leader oscilloscope’s **Trig Out** connections:
  - a Disconnect the BNC cable from the follower #1 oscilloscope’s **Aux Trig** connector.
  - b Connect the input of the 0955-2638 power divider to the cable you just disconnected.
  - c Connect one of the 24-in BNC cables between one of the power divider outputs and the follower #1 oscilloscope’s **Aux Trig**.
  - d Connect one of the 48-in BNC cables between the other power divider output and the follower #5 oscilloscope’s **Aux Trig**.

- 10 Re-configure the leader oscilloscope's **100 MHz Out** connections:
  - a Connect three right angle male to female SMA adapters (1250-2818) to the other 0955-2594 power divider/combiner's input and outputs.
  - b Disconnect the SMA cable from the follower #1 oscilloscope's **100 MHz In** connector.
  - c Connect the input of the power divider/combiner to the cable you just disconnected.
  - d Connect one of the SMA cables between one of the power divider/combiner outputs and the follower #1 oscilloscope's **100 MHz In**.
  - e Connect one of the SMA cables between the other power divider/combiner output and the follower #5 oscilloscope's **100 MHz In**.

See **"Trig Out and 100 MHz Out Connections"** on page 42.
- 11 Connect the oscilloscope to the host computer through the desired remote interface connection (LAN, USB, etc.).
- 12 If this is the last oscilloscope to be connected, see **Chapter 10**, "Next Steps," starting on page 85.

## Connecting the Follower #6 Through Follower #9 Oscilloscopes

Before connecting the follower #6 through follower #9 oscilloscopes, first follow the instructions for connecting a 6-oscilloscope rackmount system in **“Connecting the Follower #5 Oscilloscope”** on page 43.

Then, for each of the oscilloscopes from follower #6 to follower #9, using the parts in a N2106A (add one) expansion kit, follow these instructions:

- 1 Remove the SMA 50  $\Omega$  terminator (1250-3745) from the power divider output that will be used for the oscilloscope. See **“Sync Signal Connections”** on page 41.
- 2 Make sure the oscilloscope’s synchronization port input has a connector saver:
  - Use the 1250-3758 adapter for a dedicated **Sync In** channel input or for the 33 GHz channel 4 input when used as the synchronization port in 50 GHz or 63 GHz bandwidth systems.
  - Use the 1250-3782 adapter when the channel 3R RealEdge input is used as the synchronization port on 50 GHz or 63 GHz bandwidth models configured in 20 GHz, 25 GHz, or 33 GHz bandwidth systems.
- 3 Connect the two right angle male to female SMA adapters (1250-2818) to:
  - The power divider output that you just removed a terminator from.
  - The oscilloscope's synchronization port input.
- 4 Connect the SMA cable between the power divider output and the oscilloscope's synchronization port input.
- 5 Connect the BNC cable between the previous oscilloscope’s **Trig Out** connector to this oscilloscope’s **Aux Trig** connector. See **“Trig Out and 100 MHz Out Connections”** on page 42.
- 6 Connect an SMA cable between the previous oscilloscope’s **100 MHz Out** connector to this oscilloscope’s **100 MHz In** connector. See **“Trig Out and 100 MHz Out Connections”** on page 42.
- 7 Connect the oscilloscope to the host computer through the desired remote interface connection (LAN, USB, etc.).
- 8 If this is the last oscilloscope to be connected, see **Chapter 10**, “Next Steps,” starting on page 85.

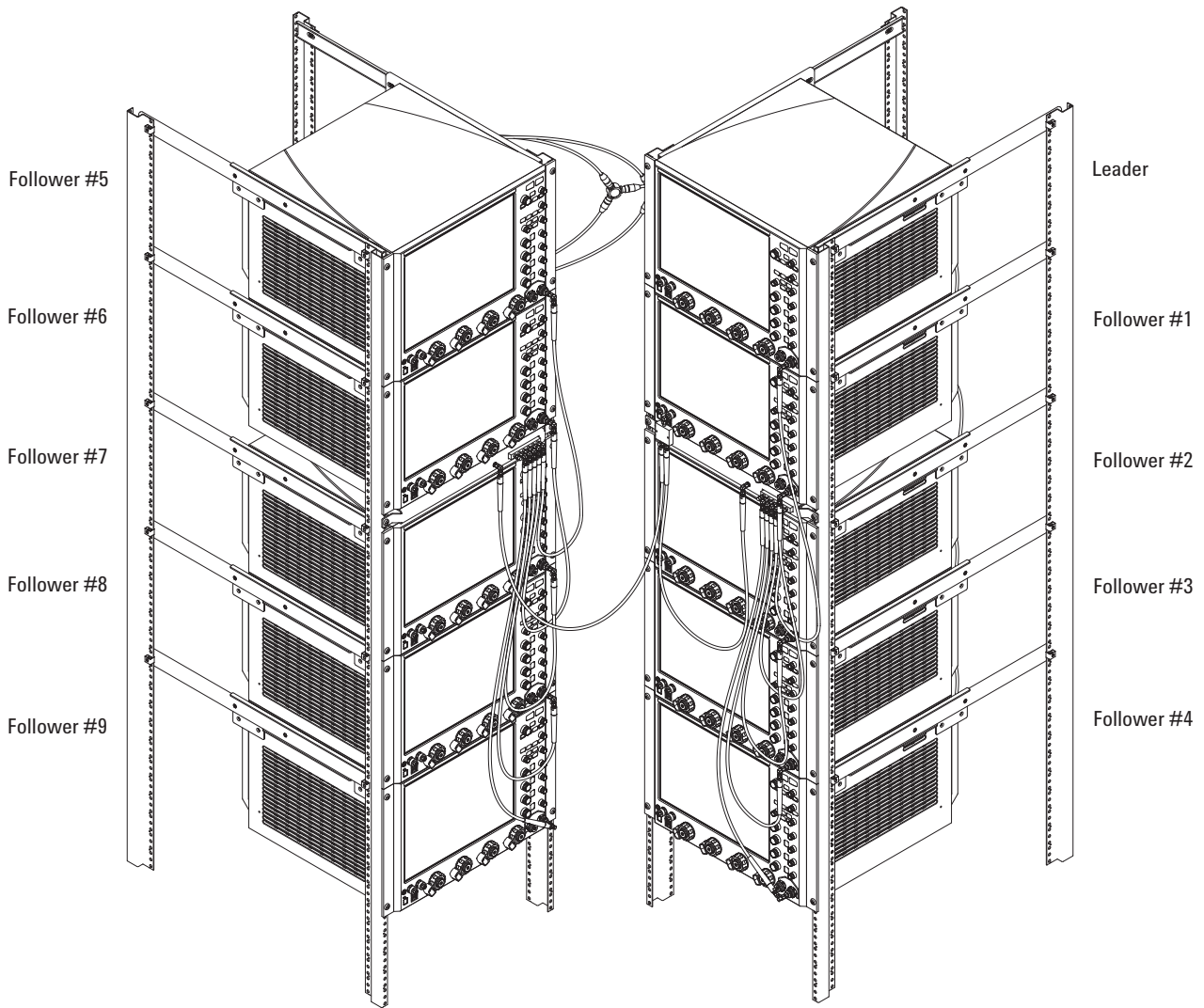

## 6 Two-Oscilloscope System, V-Series or 90000 X-Series

V-Series or 90000 X-Series Oscilloscope System Requirements / 48

Connections for Synchronization / 49

Connections for Reference Clock Skew Calibration / Drift Correction / 50

Sample Rate Selection and Available Channels / 51

This chapter describes how to configure two-oscilloscope MultiScope systems made up of V-Series or 90000 X-Series oscilloscopes.

## V-Series or 90000 X-Series Oscilloscope System Requirements

For two-oscilloscope MultiScope systems made up of V-Series or 90000 X-Series oscilloscopes, you can use the N2123A multi-frame cable kit.

Because of analysis software requirements, V-Series or 90000 X-Series oscilloscopes used in a MultiScope system must have the Windows 7 operating system.

Refer to your analysis software documentation for additional Infiniium application software version requirements.

### Parts in the N2123A Multi-Frame Cable Kit

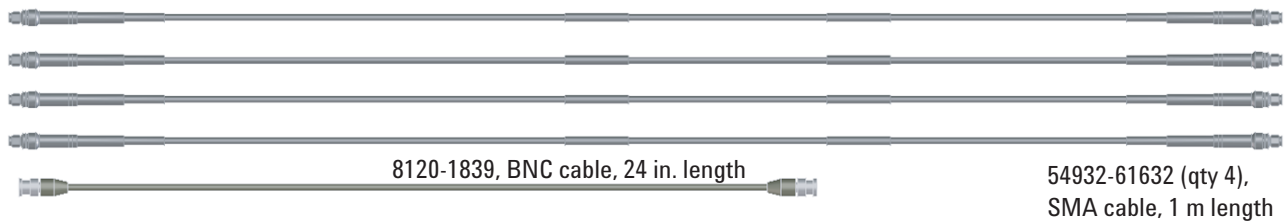

1250-2818 (qty 7), right angle male to female SMA adapter



1250-3758 (qty 2), connector saver for Ch4 input, 3.5 mm (f) to 3.5 mm (f)



1250-3347 (qty 2), adapter, press-on SMA (m) to SMA (f)



54855-67604 (qty 2), adapter, precision BNC (m) to 3.5 mm (f)



0955-2594,  
power divider/  
combiner



## Connections for Synchronization

The following two connections are required for synchronization.

- 1 Connect Trig Out from the Leader to Aux Trig on the Follower through a BNC cable.
- 2 Connect Ref Clk Out from the Leader to Ref Clk In on the Follower:
  - Connect the 10 MHz Out from the Leader to 10 MHz In on the Follower through a BNC cable.

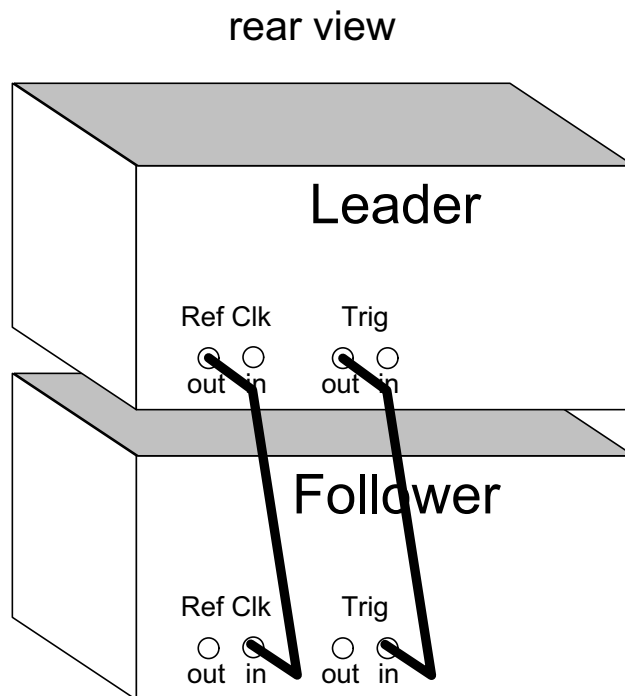

**Figure 10** Connections for synchronization

From the multi-frame cable kit, use these cables/adapters:

Connection	Use Cable/Adapters
Trig	8120-1839 BNC cable, 24 in. length
Ref Clk	54855-67604 (qty 2) precision BNC (m) to 3.5 mm (f) adapters 54932-61632 SMA cable, 1 m length

## Connections for Reference Clock Skew Calibration / Drift Correction

The following connections are required for reference clock skew calibration. These same connections are also required for the optional drift correction.

- 1 Connect the Follower's Cal Out signal to the channel 4 inputs on both oscilloscopes using high-quality SMA cables and a passive power splitter or divider.

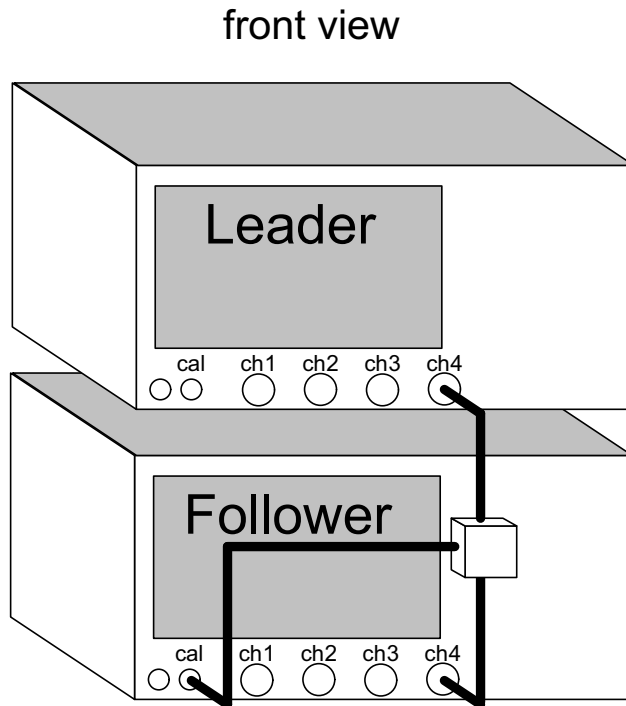

**Figure 11** Connections for reference clock skew calibration and drift correction

From the multi-frame cable kit, use these power dividers/cables/adapters:

Use Cable/Adapters/Power Divider	Notes
0955-2594 power divider/combiner	
1250-2818 (qty 5), right angle male to female SMA adapter	Use one to connect Cal Out to power divider input (in lieu of cable shown in preceding picture). Other adapters may be used on power divider outputs and Ch4 inputs.
54932-61632 (qty 2) SMA cable, 1 m length	Connect these between power divider outputs and Ch4 inputs.

## Sample Rate Selection and Available Channels

When using V-Series or 90000 X-Series oscilloscopes in a MultiScope system, the channel configuration has a higher precedence than the sample rate and will limit the sample rate as you turn on more channels (for example, full channel mode on a 90000 X-Series oscilloscope limits the sample rate to 40 GSa/s).

The maximum sample rate of these oscilloscopes is available only when no more than one channel of each pair is on (channels 1 and 2 are one pair, channels 3 and 4 are the other pair). When channel 4 is used as the synchronization input (for drift correction), channels 2 and 4 can never be used at the maximum sample rate.

Because the maximum sample rate of the oscilloscopes depends on the number of acquired channels, the Deskew Frames and Deskew Channels processes use the current maximum sample rate that is available when the deskew operation is initiated.

## Next Steps

Once connections are made, see [Chapter 10](#), “Next Steps,” starting on page 85.



# 7 Three- to Five-Oscilloscope Rackmount Systems, V-Series or 90000 X-Series

Expansion Equipment Required / 54

Mounting Oscilloscopes in Rack / 55

Connecting the Equipment / 56

## Expansion Equipment Required

**Table 6** Equipment Required for 3-to-5 V-Series or 90000 X-Series Oscilloscope Rackmount System

Model	Description	Quantity
33600A	Waveform generator (for 10 MHz clock)	1
3VINRK	Three Infiniium V-Series expansion accessory set (Rackmount)	1
PLUS1V	Infiniium V-Series expansion accessory set (Expand One Frame)	(# of scopes) - 3
N5470A	Rackmount kit (or option)	(# of scopes)

**NOTE**

The 3VINRK and PLUS1V accessory sets are not actual kit model numbers that can be ordered from Keysight. Instead, they are simply used to describe the accessories (cables, adapters, and other equipment) needed to connect three oscilloscopes or add one oscilloscope.

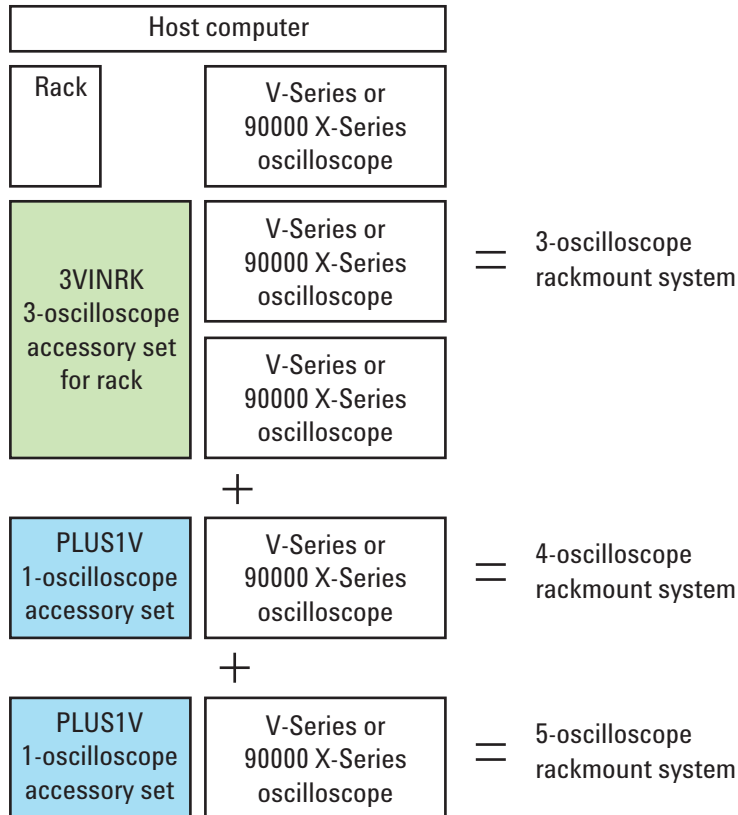

**Figure 12** Expansion Accessories Required for Three- to Five-Oscilloscope (V-Series or 90000 X-Series) Rackmount System

## Mounting Oscilloscopes in Rack

Oscilloscopes take 7U of rack space and the power divider assembly takes 1U of rack space.

**NOTE**

Because of cable lengths, and to ease further oscilloscope expansion, it is recommended to place the oscilloscopes in the specified relative rack locations.

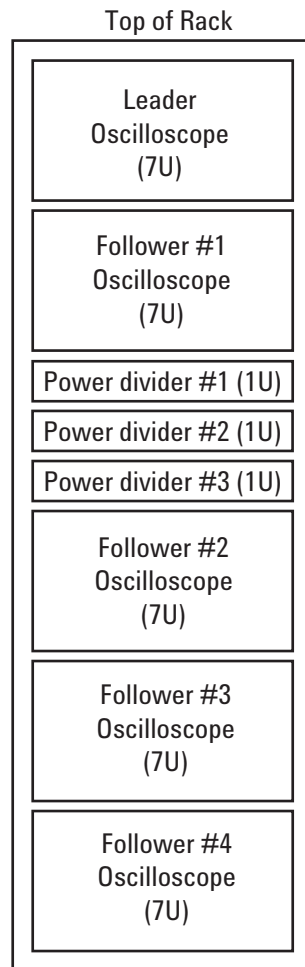

**Figure 13** Oscilloscope Locations in Rack

Using the instructions in the *Rackmount Kit User's Guide*, mount oscilloscopes in their designated rack locations.

## Connecting the Equipment

### Parts in the 3VINRK (Three in Rack) Expansion Accessory Set

Part number	Qty	Description
N2759-60002	3	Power divider assembly (1-6)
1250-2818	15	Right-angle male to female SMA adapter
1250-3745	13	50 $\Omega$ SMA terminator
1250-3758	4	Connector saver 3.5 mm (f)
54932-61632	11	SMA cable
1250-2015	7	BNC (m) to SMA (f) adapter, 50 $\Omega$

### Parts in the PLUS1V (Add One) Expansion Accessory Set

Part number	Qty	Description
1250-2818	4	Right-angle male to female SMA adapter
1250-3758	1	Connector saver 3.5 mm (f)
54932-61632	3	SMA cable
1250-2015	2	BNC (m) to SMA (f) adapter, 50 $\Omega$

## Sync Signal Connections

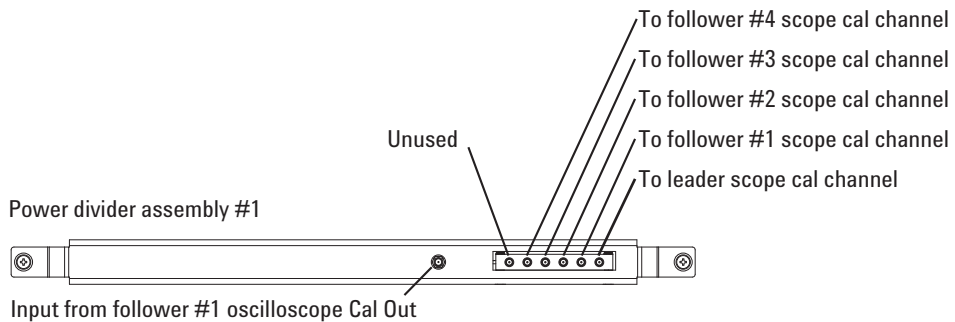

Place 1250-2818 adapters on all used inputs/outputs  
(including oscilloscope synchronization port inputs)

Place 1250-3745 terminators on all unused outputs



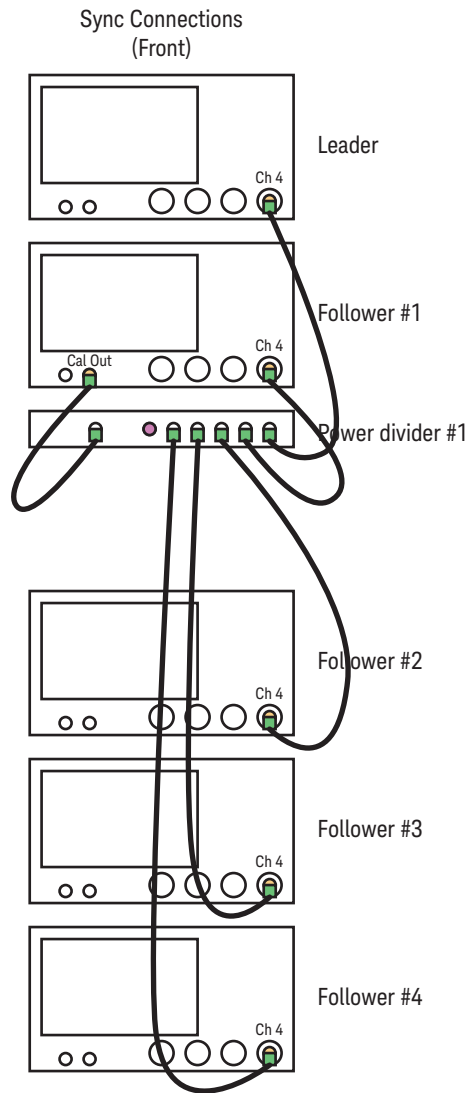

## Trig Out Signal Connections

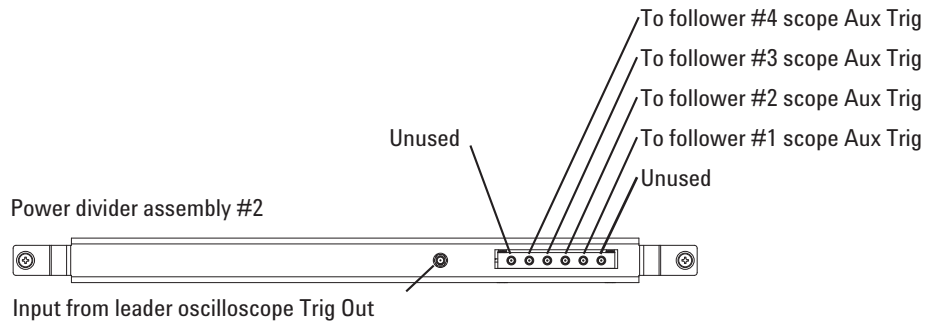

Place 1250-2818 adapters on all used inputs/outputs  
(including oscilloscope synchronization port inputs)

Place 1250-3745 terminators on all unused outputs

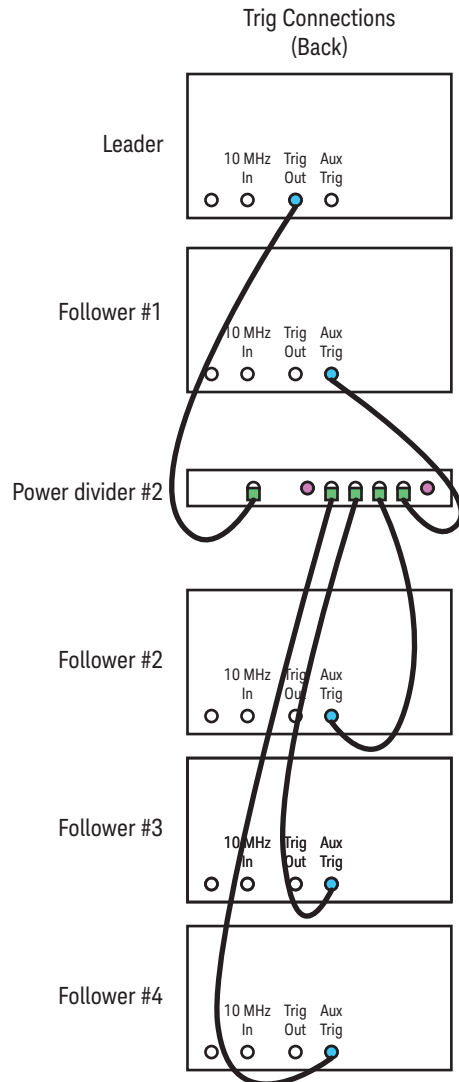

## 10 MHz In Signal Connections

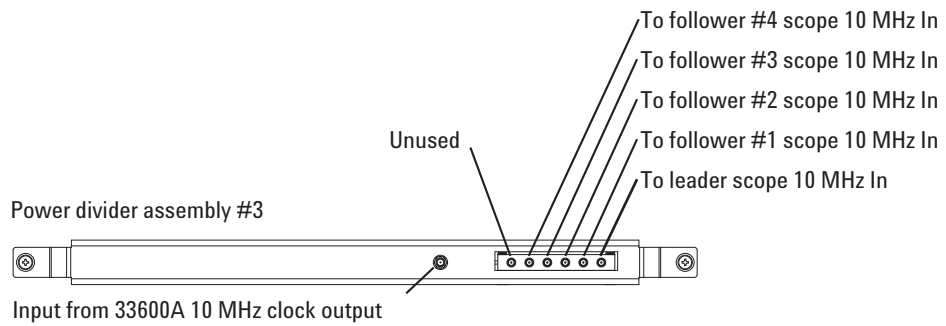

Place 1250-2818 adapters on all used inputs/outputs  
(including oscilloscope synchronization port inputs)

Place 1250-3745 terminators on all unused outputs

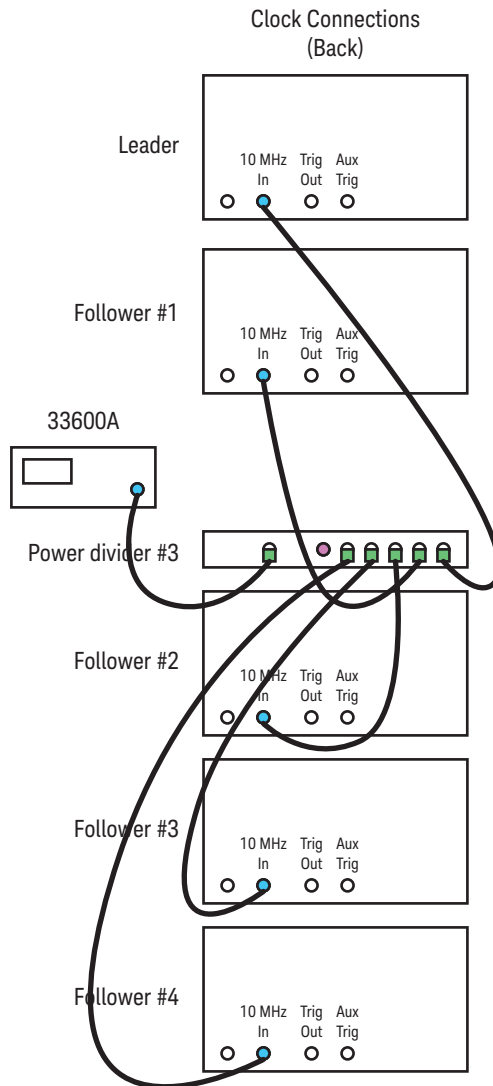

## Connecting the Three Oscilloscopes

Using the parts in a 3VINRK (three in rack) expansion set, follow these instructions:

- 1 Mount the first, second, and third N2759-60002 power divider assemblies in the designated rack location. See **"Mounting Oscilloscopes in Rack"** on page 55.
- 2 Make sure the synchronization port (channel 4, for example) input on each oscilloscope has a 1250-3758 connector saver.
- 3 Connect the 15 right angle male to female SMA adapters (1250-2818) to:
  - The follower oscilloscope's **Cal Out**.
  - The power divider assemblies' inputs (3 adapters).
  - The first power divider assembly's three right-most outputs (3 adapters).
  - The second power divider assembly's second and third outputs from the right (2 adapters).
  - The third power divider assembly's three right-most outputs (3 adapters).
  - The three oscilloscopes' synchronization port (channel 4, for example) inputs (3 adapters).
- 4 Connect 10 SMA 50  $\Omega$  terminators (1250-3745) to the unused power divider assembly outputs.
- 5 Connect the seven BNC (m) to SMA (f) adapters (1250-2015) to:
  - The leader oscilloscope's **Trig Out** output.
  - The follower #1 and follower #2 oscilloscopes' **Aux Trig** inputs (2 adapters).
  - The 33600A waveform generator's 10 MHz clock output.
  - The three oscilloscopes' **10 MHz In** inputs (3 adapters).
- 6 Connect an SMA cable between the follower #1 oscilloscope's **Cal Out** output and the first power divider assembly's input.
- 7 Connect SMA cables between the first power divider assembly outputs and the oscilloscopes' synchronization port (channel 4, for example) inputs. See **"Sync Signal Connections"** on page 56.
- 8 Connect an SMA cable between the leader oscilloscope's **Trig Out** output and the second power divider assembly's input.
- 9 Connect SMA cables between the second power divider assembly outputs and the follower #1 and follower #2 oscilloscopes' **Aux Trig** inputs. See **"Aux Trig Connections"** on page 57.
- 10 Connect an SMA cable between the 33600A waveform generator's 10 MHz clock output and the third power divider assembly's input.
- 11 Connect SMA cables between the third power divider assembly outputs and the oscilloscopes' **10 MHz In** inputs. See **"10 MHz In Signal Connections"** on page 60.

- 12** Connect the oscilloscopes to the host computer through the desired remote interface connection (LAN, USB, etc.).
- 13** If these are the last oscilloscopes to be connected, see **Chapter 10**, “Next Steps,” starting on page 85.

## Connecting the Follower #3 Through Follower #4 Oscilloscopes

Before connecting the follower #3 through follower #4 oscilloscopes, first follow the instructions for connecting a three-oscilloscope rackmount system in **“Connecting the Three Oscilloscopes”** on page 62.

Then, for each of the oscilloscopes from follower #3 to follower #4, using the parts in a PLUS1V (add one) expansion set, follow these instructions:

- 1 Remove the SMA 50  $\Omega$  terminators (1250-3745) from the power dividers' outputs that will be used for the oscilloscope. See **“Sync Signal Connections”** on page 56, **“”** on page 57, and **“10 MHz In Signal Connections”** on page 60.
- 2 Make sure the oscilloscope's synchronization port (channel 4, for example) input has a 1250-3758 connector saver.
- 3 Connect the four right angle male to female SMA adapters (1250-2818) to:
  - The power divider outputs that you just removed a terminator from (3).
  - The oscilloscope's synchronization port (channel 4, for example) input.
- 4 Connect the two BNC (m) to SMA (f) adapters (1250-2015) to:
  - The oscilloscope's **Aux Trig** input.
  - The oscilloscope's **10 MHz In** input.
- 5 Connect one SMA cable between the first power divider's output and the oscilloscope's synchronization port (channel 4, for example) input. See **“Sync Signal Connections”** on page 56.
- 6 Connect one SMA cable between the second power divider's output and the oscilloscope's **Aux Trig** input. See **“Trig Out Signal Connections”** on page 58.
- 7 Connect one SMA cable between the third power divider's output and the oscilloscope's **10 MHz In** input. See **“10 MHz In Signal Connections”** on page 60.
- 8 Connect the oscilloscope to the host computer through the desired remote interface connection (LAN, USB, etc.).
- 9 If this is the last oscilloscope to be connected, see **Chapter 10**, “Next Steps,” starting on page 85.



## 8 Six- to Ten-Oscilloscope Rackmount Systems, V-Series or 90000 X-Series

Expansion Equipment Required / 66

Mounting Oscilloscopes in Racks / 68

Connecting the Equipment / 69

## Expansion Equipment Required

**Table 7** Equipment Required for 6-to-10 V-Series or 90000 X-Series Oscilloscope Rackmount System

Model	Description	Quantity
33600A	Waveform generator (for 10 MHz clock)	1
3VINRK	Three Infiniium V-Series expansion accessory set (Rackmount)	1
PLUS1V	Infiniium V-Series expansion accessory set (Expand One Frame)	(# of scopes) - 4
PLUSRK	Infiniium V-Series expansion accessory set (Expand One Rack)	1
N5470A	Rackmount kit (or option)	(# of scopes)

### NOTE

The 3VINRK, PLUS1V, and PLUSRK accessory sets are not actual kit model numbers that can be ordered from Keysight. Instead, they are simply used to describe the accessories (cables, adapters, and other equipment) needed to connect three oscilloscopes, add one oscilloscope, or add one oscilloscope in a second rack.

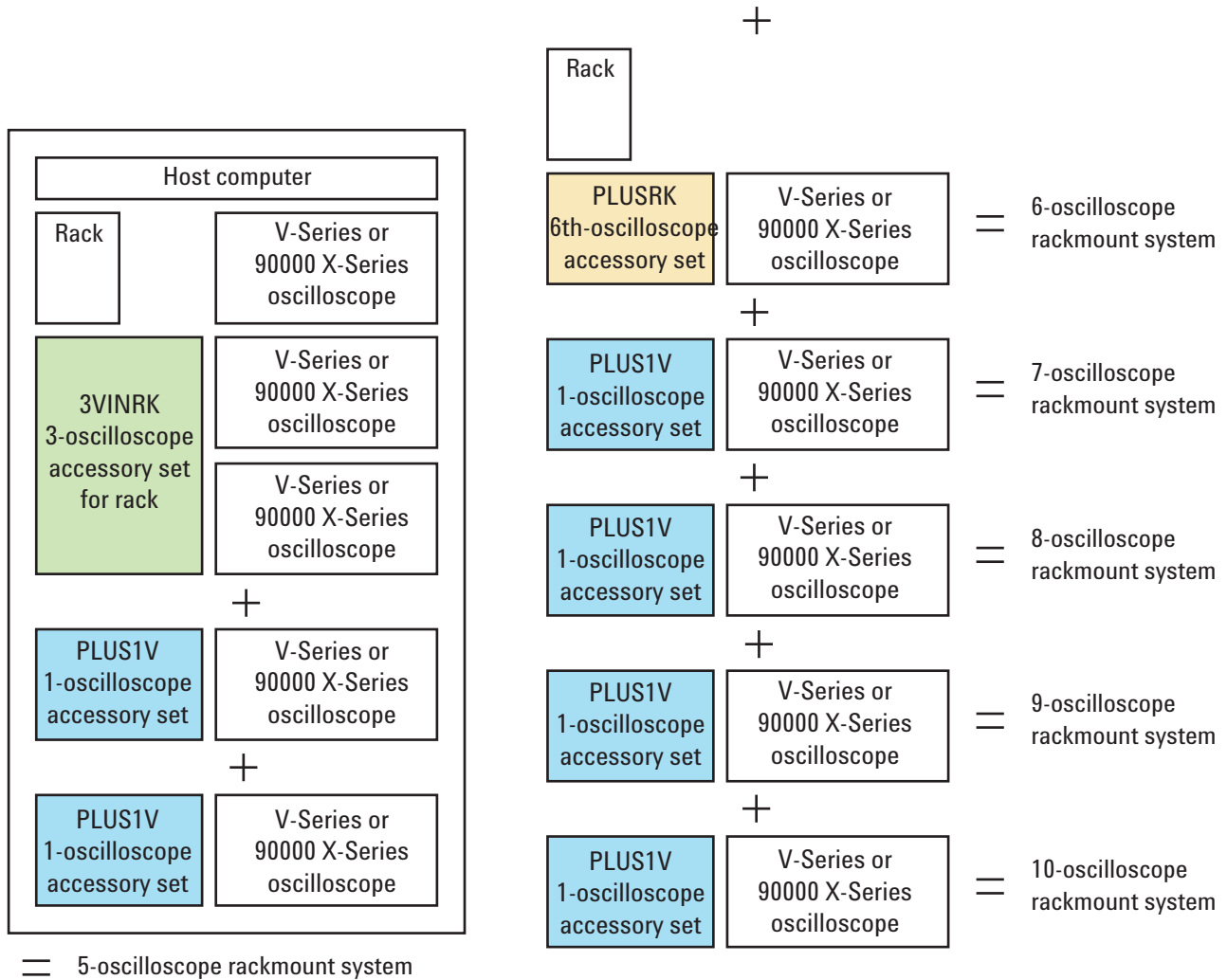

**Figure 14** Expansion Accessories Required for Six- to Ten-Oscilloscope (V-Series or 90000 X-Series) Rackmount System

## Mounting Oscilloscopes in Racks

Oscilloscopes take 7U of rack space and each power divider assembly takes 1U of rack space.

**NOTE**

Because of cable lengths, and to ease further oscilloscope expansion, it is recommended to place the oscilloscopes in the specified relative rack locations.

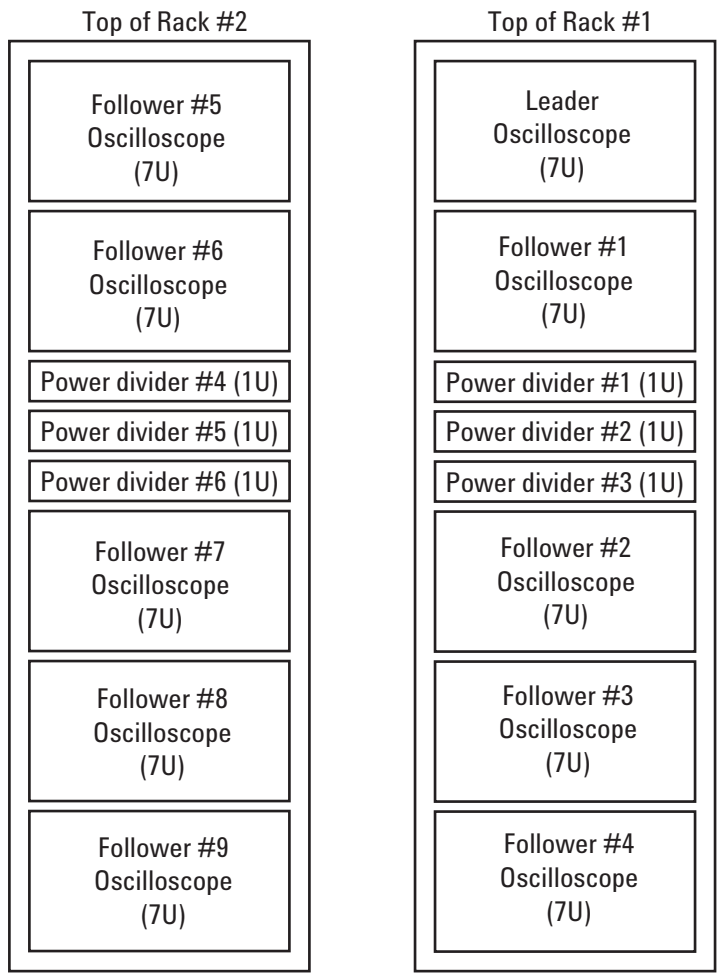

**Figure 15** Oscilloscope Locations in Racks

Using the instructions in the *Rackmount Kit User's Guide*, mount oscilloscopes in their designated rack locations.

## Connecting the Equipment

### Parts in the PLUSRK (Five to Six) Expansion Accessory Set

Part number	Qty	Description
N2759-60002	3	Power divider assembly (1-6)
0955-2594	3	Power divider/combiner (1-2)
1250-2818	7	Right-angle male to female SMA adapter
1250-3745	15	50 $\Omega$ SMA terminator
1250-3758	1	Connector saver 3.5 mm (f)
54932-61632	9	SMA cable
1250-2015	2	BNC (m) to SMA (f) adapter, 50 $\Omega$

### Sync Signal Connections

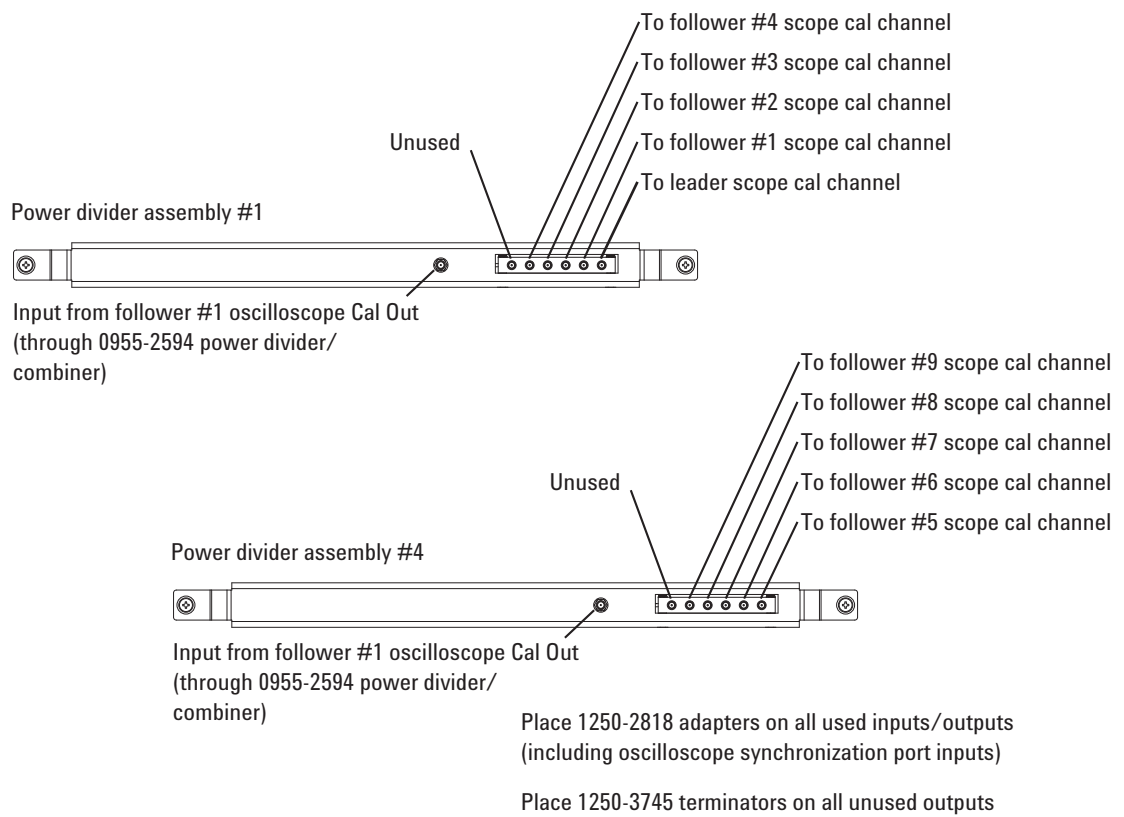

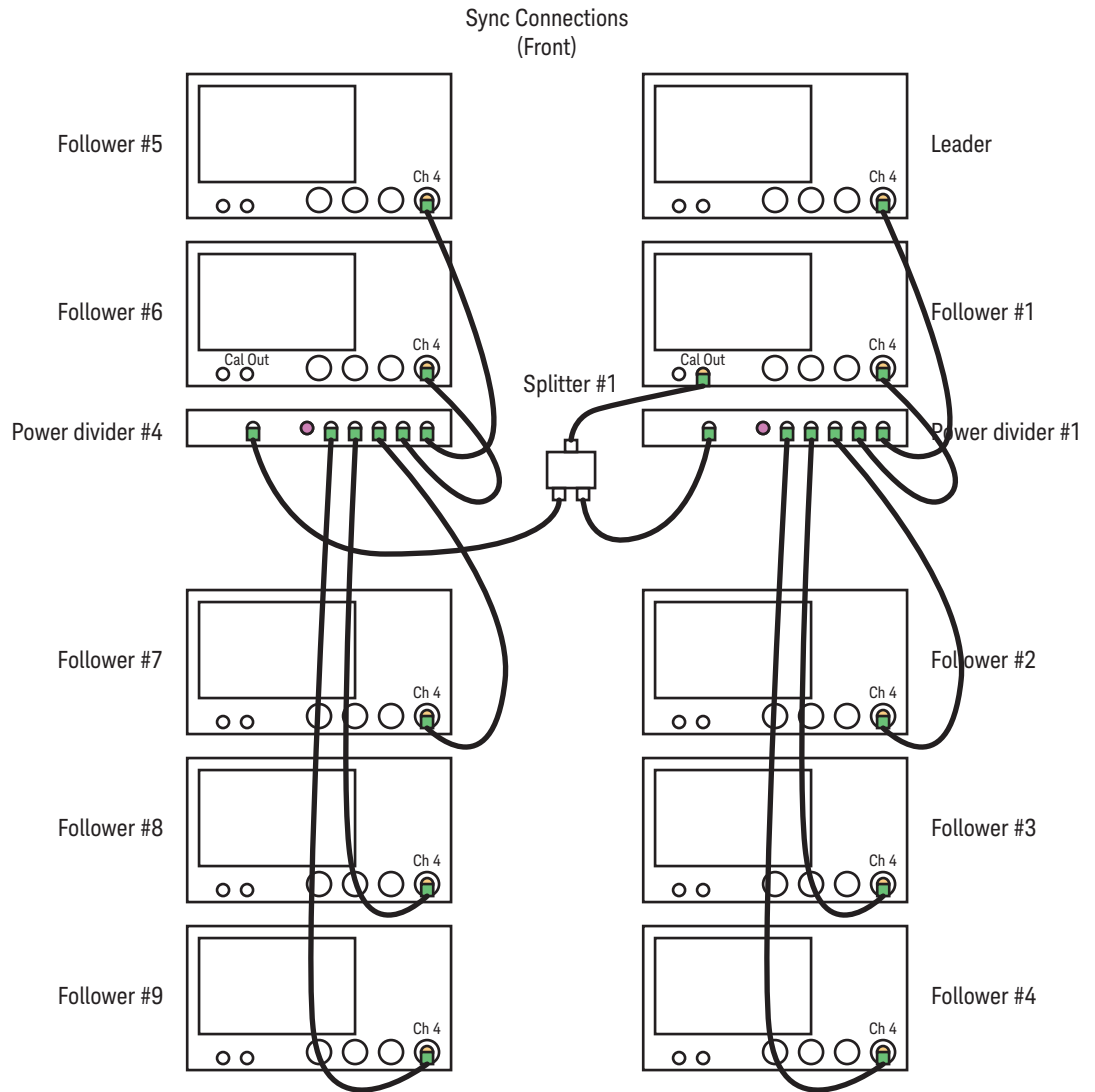

## Trig Out Signal Connections

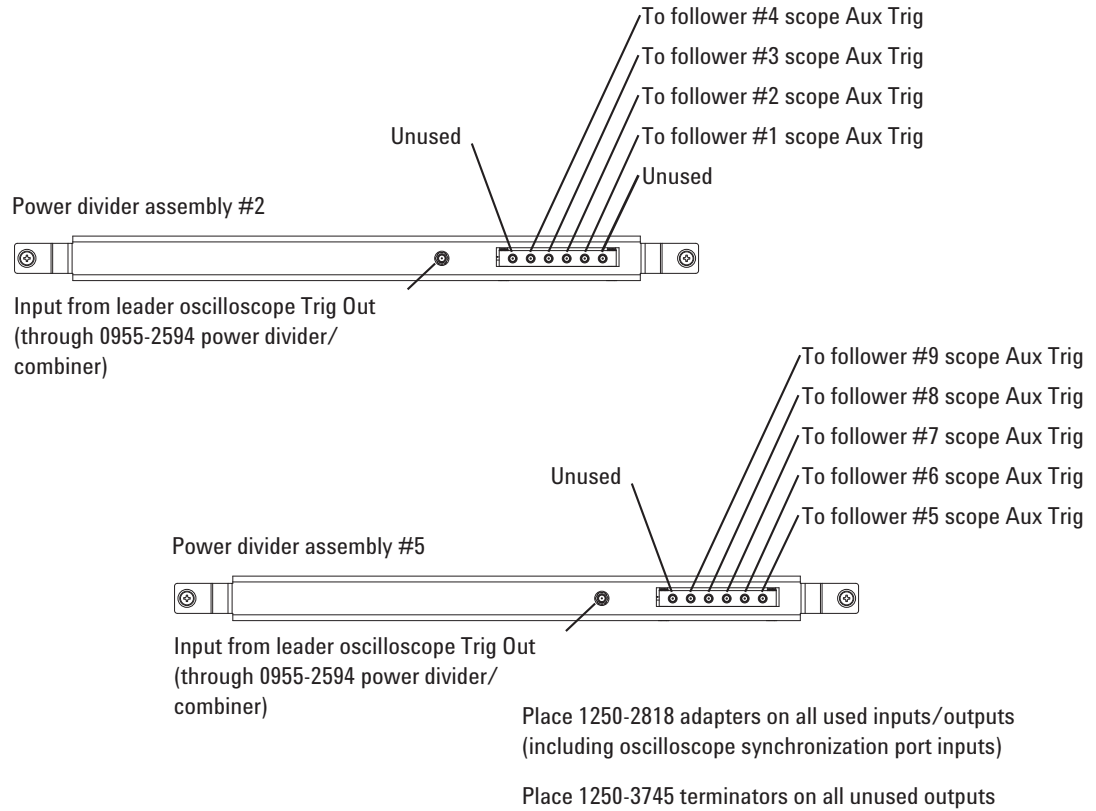

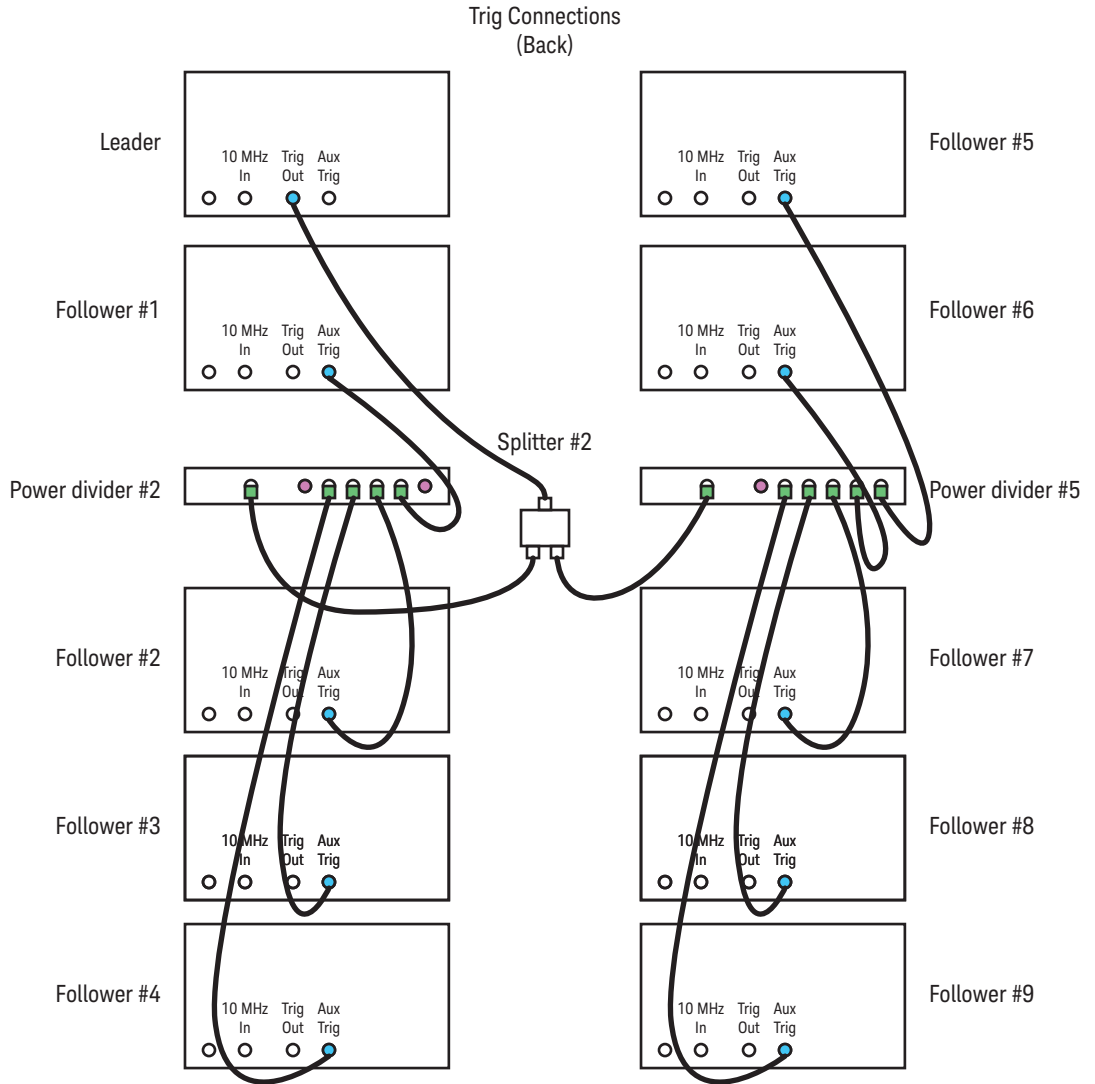



## 10 MHz In Signal Connections

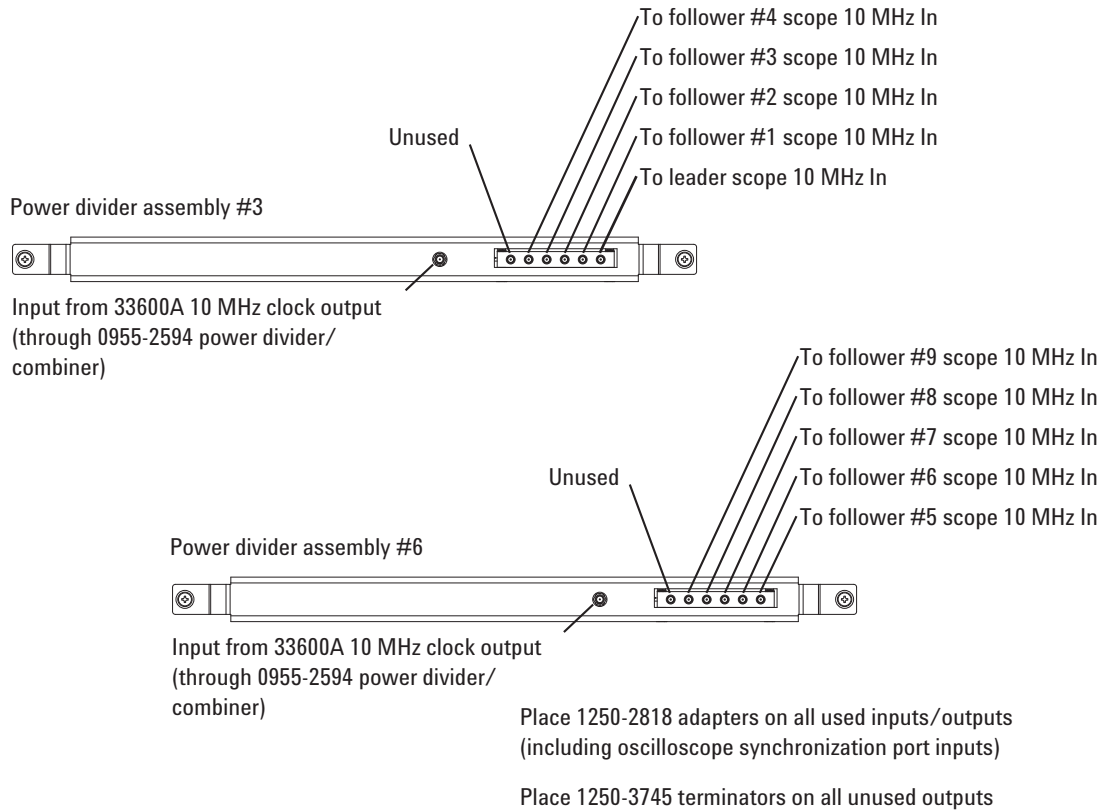

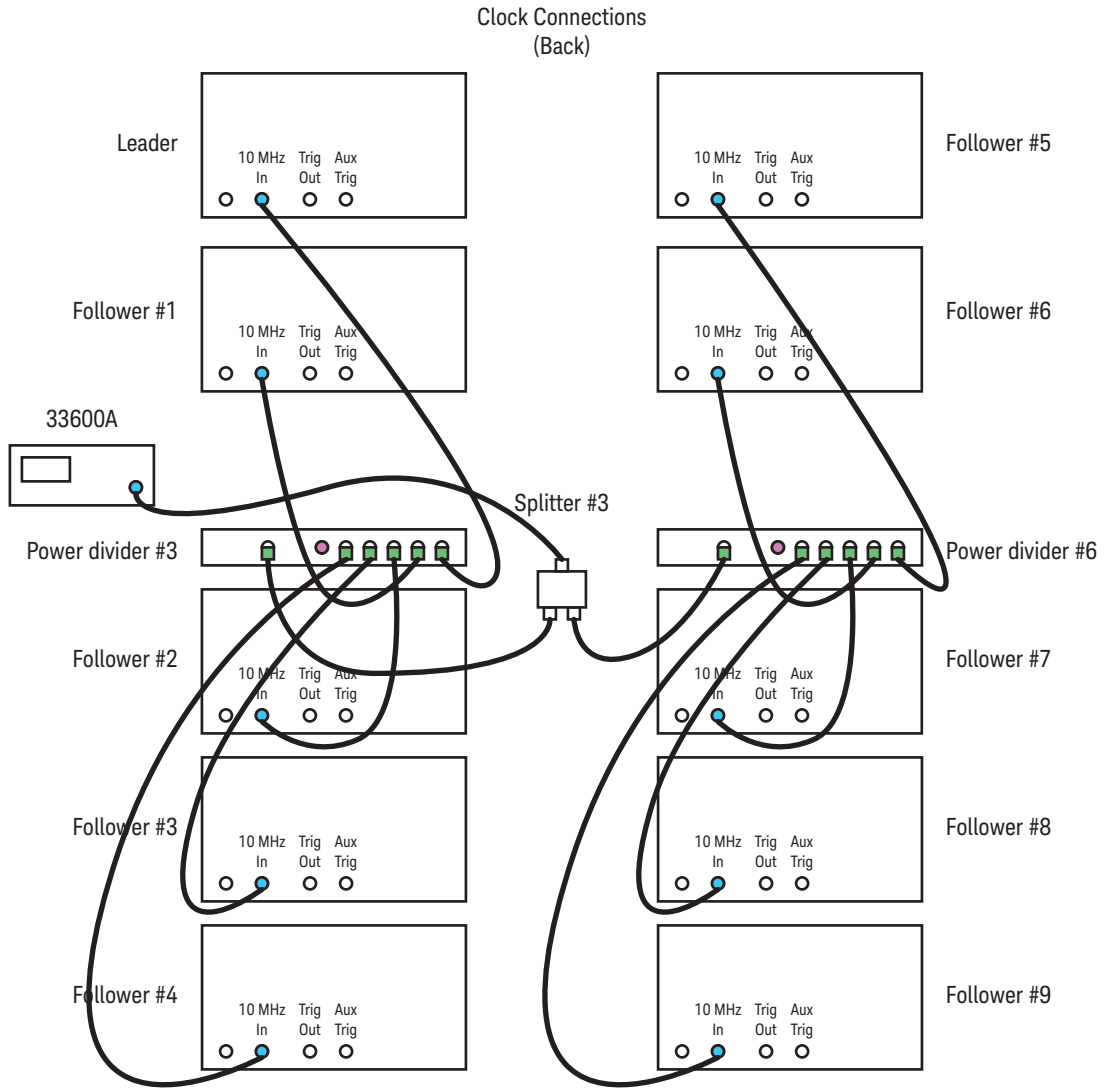

## Connecting the Follower #5 Oscilloscope

Before connecting the follower #5 oscilloscope, first follow the instructions for connecting a 3-to-5-oscilloscope rackmount system in **“Connecting the Follower #3 Through Follower #4 Oscilloscopes”** on page 64.

Then, for the follower #5 oscilloscope (in the second rack), using the parts in a PLUSRK (five to six) expansion set, follow these instructions:

- 1 Mount the fourth, fifth, and sixth N2759-60002 power divider assemblies in the designated rack location. See **“Mounting Oscilloscopes in Racks”** on page 68.
- 2 Make sure the follower #5 oscilloscope’s synchronization port (channel 4, for example) input has a 1250-3758 connector saver.
- 3 Connect seven right angle male to female SMA adapters (1250-2818) to:
  - The power divider assemblies’ inputs (3).
  - The power divider assemblies’ right-most outputs (3).
  - The follower #5 oscilloscope’s synchronization port (channel 4, for example) input.
- 4 Connect the 15 SMA 50  $\Omega$  terminators (1250-3745) to the power divider assemblies’ five left-most power divider outputs.
- 5 Connect the two BNC (m) to SMA (f) adapters (1250-2015) to:
  - The oscilloscope’s **Aux Trig** input.
  - The oscilloscope’s **10 MHz In** input.
- 6 Re-configure the follower #1 oscilloscope’s **Cal Out** connections:
  - a Disconnect the SMA cable from the follower #1 oscilloscope’s **Cal Out** and place it on one of a 0955-2594 power divider/combiner outputs.
  - b Connect the power divider/combiner input (single connector side) to the follower #1 oscilloscope’s **Cal Out**.
  - c Connect one SMA cable between the power divider/combiner’s second output and the fourth power divider assembly’s input.
  - d Connect the other SMA cable between the fourth power divider assembly’s output and the follower #5 oscilloscope’s synchronization port (channel 4, for example) input.

See **“Sync Signal Connections”** on page 69.

- 7 Re-configure the leader oscilloscope's **Trig Out** connections:
  - a Disconnect the SMA cable from the leader oscilloscope's **Trig Out** and place it on one of a 0955-2594 power divider/combiner outputs.
  - b Connect the power divider/combiner input (single connector side) to the leader oscilloscope's **Trig Out**.
  - c Connect one SMA cable between the power divider/combiner's second output and the fifth power divider assembly's input.
  - d Connect the other SMA cable between the fifth power divider assembly's output and the follower #5 oscilloscope's **Aux Trig** input.

See "**Trig Out Signal Connections**" on page 71.

- 8 Re-configure the 33600A waveform generator's 10 MHz clock connections:
  - a Disconnect the SMA cable from the 33600A's output and place it on one of a 0955-2594 power divider/combiner outputs.
  - b Connect the power divider/combiner input (single connector side) to the 33600A's output.
  - c Connect one SMA cable between the power divider/combiner's second output and the sixth power divider assembly's input.
  - d Connect the other SMA cable between the sixth power divider assembly's output and the follower #5 oscilloscope's **10 MHz In** input.

See "**10 MHz In Signal Connections**" on page 73.

- 9 Connect the oscilloscope to the host computer through the desired remote interface connection (LAN, USB, etc.).
- 10 If this is the last oscilloscope to be connected, see **Chapter 10**, "Next Steps," starting on page 85.

## Connecting the Follower #6 Through Follower #9 Oscilloscopes

Before connecting the follower #6 through follower #9 oscilloscopes, first follow the instructions for connecting a 6-oscilloscope rackmount system in **“Connecting the Follower #5 Oscilloscope”** on page 75.

Then, for each of the oscilloscopes from follower #6 to follower #9, using the parts in a PLUS1V (add one) expansion set, follow these instructions:

- 1 Remove the SMA 50  $\Omega$  terminators (1250-3745) from the power dividers' outputs that will be used for the oscilloscope. See **“Sync Signal Connections”** on page 69, **“Trig Out Signal Connections”** on page 71, and **“10 MHz In Signal Connections”** on page 73.
- 2 Make sure the oscilloscope's synchronization port (channel 4, for example) input has a 1250-3758 connector saver.
- 3 Connect the four right angle male to female SMA adapters (1250-2818) to:
  - The power divider outputs that you just removed a terminator from (3).
  - The oscilloscope's synchronization port (channel 4, for example) input.
- 4 Connect one SMA cable between the fourth power divider's output and the oscilloscope's synchronization port (channel 4, for example) input. See **“Sync Signal Connections”** on page 69.
- 5 Connect one SMA cable between the fifth power divider's output and the oscilloscope's **Aux Trig** input. See **“Trig Out Signal Connections”** on page 71.
- 6 Connect one SMA cable between the sixth power divider's output and the oscilloscope's **10 MHz In** input. See **“10 MHz In Signal Connections”** on page 73.
- 7 Connect the oscilloscope to the host computer through the desired remote interface connection (LAN, USB, etc.).
- 8 If this is the last oscilloscope to be connected, see **Chapter 10**, “Next Steps,” starting on page 85.



## 9 Two-Oscilloscope System, S-Series, 9000 Series, or 90000A Series

S-Series, 9000 Series, or 90000A Series Oscilloscope Requirements / 80

Connections for Synchronization / 81

Connections for Reference Clock Skew Calibration / Drift Correction / 82

Sample Rate Selection and Available Channels / 83

This chapter describes how to configure two-oscilloscope MultiScope systems made up of S-Series, 9000 Series, or 90000A Series oscilloscopes.

## S-Series, 9000 Series, or 90000A Series Oscilloscope Requirements

For two-oscilloscope MultiScope systems made up of S-Series, 9000 Series, or 90000A Series oscilloscopes, you can use the N2124A multi-frame cable kit.

Because of analysis software requirements, oscilloscopes used in a MultiScope system must have the Windows 7 operating system.

Refer to your analysis software documentation for additional Infiniium application software version requirements.

### Parts in the N2124A Multi-Frame Cable Kit

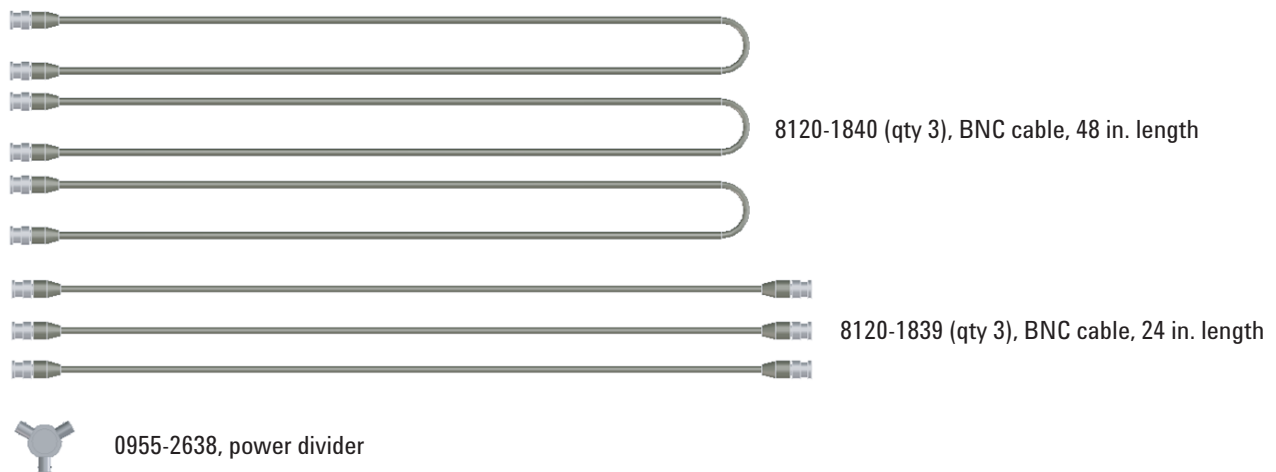



## Connections for Synchronization

The following two connections are required for synchronization.

- 1 Connect Trig Out from the Leader to Aux Trig on the Follower through a BNC cable.
- 2 Connect Ref Clk Out from the Leader to Ref Clk In on the Follower:
  - Connect the 10 MHz Out from the Leader to 10 MHz In on the Follower through a BNC cable.

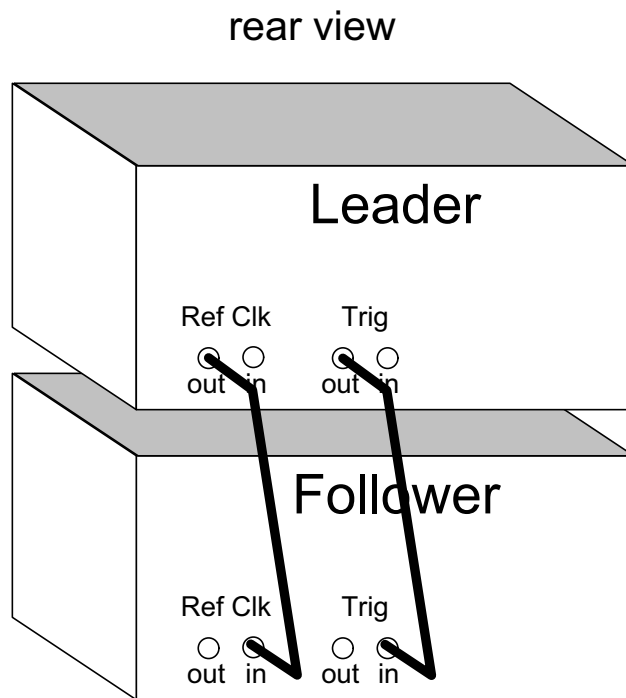

**Figure 16** Connections for synchronization

From the multi-frame cable kit, use these cables/adapters:

Connection	Use Cable/Adapters
Trig	8120-1840 BNC cable, 48 in. length
Ref Clk	8120-1840 BNC cable, 48 in. length

## Connections for Reference Clock Skew Calibration / Drift Correction

The following connections are required for reference clock skew calibration. These same connections are also required for the optional drift correction.

- 1 Connect the Follower's Aux Out signal to the channel 4 inputs on both oscilloscopes using BNC cables and a passive power splitter or divider.

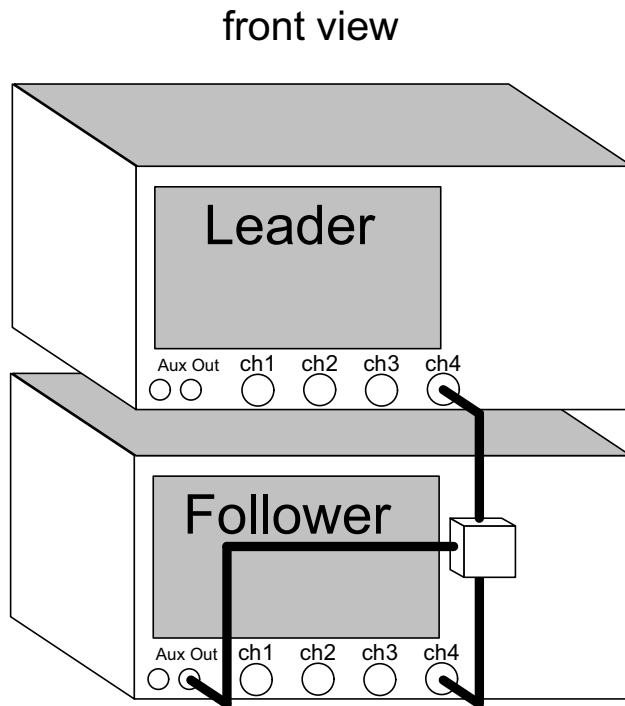

**Figure 17** Connections for reference clock skew calibration and drift correction

From the multi-frame cable kit, use these power dividers/cables/adapters:

Use Cable/Adapters/Power Divider	Notes
0955-2638, power divider	
8120-1839 (qty 3) BNC cable, 24 in. length	

## Sample Rate Selection and Available Channels

When using S-Series, 9000 Series, or 90000A Series oscilloscopes in a MultiScope system, the channel configuration has a higher precedence than the sample rate and will limit the sample rate as you turn on more channels (for example, full channel mode on a S-Series oscilloscope limits the sample rate to 10 GSa/s).

The maximum sample rate of these oscilloscopes is available only when no more than one channel of each pair is on (channels 1 and 2 are one pair, channels 3 and 4 are the other pair). When channel 4 is used as the synchronization input (for drift correction), channels 2 and 4 can never be used at the maximum sample rate.

Because the maximum sample rate of the oscilloscopes depends on the number of acquired channels, the Deskew Frames and Deskew Channels processes use the current maximum sample rate that is available when the deskew operation is initiated.

## Next Steps

Once connections are made, see [Chapter 10](#), “Next Steps,” starting on page 85.



# 10 Next Steps

Calibrate the Oscilloscopes in the MultiScope System / 85

Use MultiScope Control Software / 86

Performing Channel Deskew / 88

## Calibrate the Oscilloscopes in the MultiScope System

For best performance under any conditions, it is useful to verify the current operating temperature of the oscilloscopes in the rack(s) or stackmount configuration once the entire system has reached a stable thermal condition. The temperature deviation from the previous calibration is displayed in the Calibration dialog box of each oscilloscope.

If the inlet air temperature is not within the calibration temperature range, the oscilloscope will provide a visual warning on the screen.

The oscilloscopes are warranted to meet all specifications when the ambient temperature is  $\pm 5$  °C of the calibration temperature.

## Use MultiScope Control Software

After the MultiScope system hardware has been configured and you have performed each oscilloscope's calibration procedure, you can use MultiScope control software to make data acquisitions. Your options are:

- Infiniium oscilloscope software on the Leader oscilloscope. MultiScope software is now included as a standard feature.
- D9010BSEO Infiniium Offline oscilloscope analysis software on the host computer. MultiScope software is now included as a standard feature.
- N8822A MATLAB time-synchronization software on the host computer.

### Infiniium Oscilloscope Software on the Leader Oscilloscope

The MultiScope hosted instruments capability was introduced in the Infiniium software version 5.50, in the D9010BSEO Infiniium Offline oscilloscope analysis software only, and all Infiniium oscilloscopes in the MultiScope system were required to have the 5.50 (or higher) software installed.

Starting with Infiniium software version 5.60, the hosted instruments capability is now available from within an Infiniium oscilloscope (in the box) as well as from the Infiniium Offline software running on a PC. Connecting to and controlling multiple oscilloscopes from within an Infiniium oscilloscope has the following advantages:

- You have the full triggering capability of the Infiniium oscilloscope, including InfiniiScan. (From the Infiniium Offline software, you have only edge and glitch trigger modes.)
- No additional computer is required to run the Infiniium Offline software.
- No space for an additional computer is necessary.

Starting with Infiniium software version 6.30, MultiScope software is included as a standard feature.

Refer to the Infiniium oscilloscope software's *Online Help* for instructions on setting up and controlling the MultiScope system. In particular, note that, on the Leader oscilloscope, you must set up remote connections to the Follower oscilloscopes using the Keysight Connection Expert (which is part of the Keysight IO Libraries Suite).

### D9010BSEO Infiniium Offline Oscilloscope Analysis Software

The D9010BSEO Infiniium Offline oscilloscope analysis software lets you identify oscilloscopes in a MultiScope system, perform time-correlation calibration (including channel deskew, see **"Performing Channel Deskew"** on page 88), capture data, view waveforms, and perform analysis.

Refer to the D9010BSEO Infiniium Offline oscilloscope analysis software's *Online Help* for instructions on setting up and controlling the MultiScope system. In particular, note that, on the host computer, you must set up remote connections to the Leader and Follower oscilloscopes using the Keysight Connection Expert (which is part of the Keysight IO Libraries Suite).

### Host Computer Requirements

For the D9010BSEO Infiniium Offline oscilloscope analysis software, Keysight recommends a host computer with:

- A Windows 7 64-bit operating system with at least 8 GBytes of RAM and 25 GBytes of hard drive space.

## N8822A MATLAB Time-Synchronization Software

You can also use the N8822A MATLAB time-synchronization software on a host computer to identify oscilloscopes in a MultiScope system, perform time-correlation calibration (including channel deskew, see **"Performing Channel Deskew"** on page 88), capture data, and plot waveforms. This software is particularly useful if you want to perform analysis on the captured data using MATLAB.

### CAUTION

The N8822A MATLAB time-synchronization software does not support three to ten V-Series or 90000 X-Series MultiScope systems.

---

For more information, see the *User's Guide* that is included with the MATLAB time-synchronization software.

### Host Computer Requirements

For the N8822A MATLAB time-synchronization software, the host computer requirements are whatever is required by the MATLAB software. For best performance, Keysight recommends:

- A 64-bit operating system with at least 8 GBytes of RAM.
- The 64-bit version of MATLAB.

### NOTE

Note that any of the Infiniium oscilloscopes in the MultiScope system is also a Windows-based PC and can function as the host computer for MATLAB if desired.

---

## Performing Channel Deskew

Part of what the MultiScope control software provides is the ability to deskew measured waveforms. You can deskew signals between oscilloscope frames, and optionally, you can deskew the channels within an oscilloscope.

Performing channel deskew requires extra hardware:

- For MultiScope systems made up of Z-Series or 90000 Q-Series oscilloscopes, the extra hardware needed to perform channel deskew comes in the N2122A MultiScope channel deskew kit (see **“Parts in the N2122A MultiScope Channel Deskew Kit”** on page 88).

One of these kits is recommended for each MultiScope system.

- For MultiScope systems made up of V-Series or 90000 X-Series oscilloscopes, the extra hardware needed to perform channel deskew comes in the N2123A multi-frame cable kit (see **“Parts in the N2123A Multi-Frame Cable Kit”** on page 48).

The parts that were not used to connect the oscilloscopes are used for performing channel deskew.

- For MultiScope systems made up of S-Series, 9000 Series, or 90000A Series oscilloscopes, the extra hardware needed to perform channel deskew comes in the N2124A multi-frame cable kit (see **“Parts in the N2124A Multi-Frame Cable Kit”** on page 80).

The parts that were not used to connect the oscilloscopes are used for performing channel deskew.

### Parts in the N2122A MultiScope Channel Deskew Kit



  1250-2818 (qty 2), right angle male to female SMA adapter

54932-61632 (qty 2),  
SMA cable, 1 m length

 1250-3758 (qty 1), connector saver for Ch4 or Sync In input, 3.5 mm (f) to 3.5 mm (f)

  1250-3347 (qty 2), quick-connect adapter (for calibration)



# Index

## Numerics

33600A waveform generator (for 10 MHz clock), [54, 66](#)  
3VINRK three V-Series expansion accessory set (Rackmount), [54, 56, 66](#)  
9000 Series oscilloscopes, [79](#)  
90000 X-Series oscilloscopes, [47](#)  
90000A Series oscilloscopes, [79](#)

## A

airflow/cooling requirements, [13](#)  
at a glance, MultiScope configuration, [3](#)

## C

Cal Out signal, [4](#)  
calibrate oscilloscopes in system, [85](#)  
channels available, 9000 Series, [83](#)  
channels available, 90000 X-Series, [51](#)  
channels available, S-Series, [83](#)  
clearance for proper airflow, [14](#)  
clearance, rack, [14](#)  
computer (host), [5](#)  
computer (host), requirements, [87](#)  
Connection Expert, [86, 87](#)  
connections for ref clk skew calibration, 90000 X-Series oscilloscope, [50](#)  
connections for ref clk skew calibration, 90000A Series oscilloscope, [82](#)  
connections for ref clk skew calibration, S-Series oscilloscope, [82](#)  
connections for trig out/in and ref clk out/in, 90000 X-Series oscilloscope, [49](#)  
connections for trig out/in and ref clk out/in, 90000A Series oscilloscope, [81](#)  
connections for trig out/in and ref clk out/in, S-Series oscilloscope, [81](#)  
cooling/airflow requirements, [13](#)

## D

D9010BSEO Infiniium Offline oscilloscope analysis software, [5, 86](#)  
DSOX90000-1CM rackmount option, [15, 30, 38](#)

## E

environmental requirements, [13](#)  
equipment rack, [5](#)  
equipment required, 2 Z-Series or 90000 Q-Series oscilloscope rackmount, [15](#)  
equipment required, 2 Z-Series or 90000 Q-Series oscilloscope stackmount, [21](#)  
equipment required, 3-to-5 V-Series or 90000 X-Series oscilloscope rackmount, [54](#)  
equipment required, 3-to-5 Z-Series or 90000 Q-Series oscilloscope rackmount, [30](#)  
equipment required, 6-to-10 V-Series or 90000 X-Series oscilloscope rackmount, [66](#)  
equipment required, 6-to-10 Z-Series or 90000 Q-Series oscilloscope rackmount, [38](#)  
equipment, connecting, 2 Z-Series or 90000 Q-Series oscilloscope rackmount, [17](#)  
equipment, connecting, 3-to-5 V-Series or 90000 X-Series oscilloscope rackmount, [56](#)  
equipment, connecting, 3-to-5 Z-Series or 90000 Q-Series oscilloscope rackmount, [32](#)  
equipment, connecting, 6-to-10 V-Series or 90000 X-Series oscilloscope rackmount, [69](#)  
equipment, connecting, 6-to-10 Z-Series or 90000 Q-Series oscilloscope rackmount, [40](#)  
expansion accessories, [4](#)

## F

final steps, [85](#)  
follower oscilloscope, [4, 23](#)

## H

host computer, [5](#)  
host computer requirements, [87](#)

## I

in the box, MultiScope control software, [86](#)

Infiniium Q-Series oscilloscopes, [12](#)  
Infiniium Z-Series oscilloscopes, [12](#)  
intake air temperature, [14](#)  
IO Libraries Suite, [86, 87](#)

## L

leader oscilloscope, [23](#)

## M

MultiScope hardware configuration, [3](#)  
MultiScope, product overview, [3](#)

## N

N2104A Dual Infiniium Frame Channel Alignment Kit (Rackmount), [4, 15, 17, 30, 38](#)  
N2105A Dual Infiniium Frame Channel Alignment Kit (Stackmount), [4, 5, 21, 22](#)  
N2106A Infiniium Frame Expansion Channel Alignment Kit (Expand One Frame), [4, 30, 32, 38, 40](#)  
N2107A Infiniium Frame Expansion Kit (Expand One Rack), [4, 38](#)  
N2108A Infiniium 90000 Q-Series motherboard upgrade kit, [12](#)  
N2109A sync port upgrade, [12](#)  
N2122A MultiScope Channel Deskew Kit, [4, 88](#)  
N2123A Multi-Frame Cable Kit for Two 90000 X-Series or V-Series Oscilloscopes, [5, 48, 88](#)  
N2124A Multi-Frame Cable Kit for Two 9000A, 90000A, or S-Series Oscilloscopes, [5, 80, 88](#)  
N2759A rackmount kit, [15, 30, 38](#)  
N5470A rackmount kit, [54, 66](#)  
N8822A MATLAB time-synchronization software, [5, 87](#)

## P

parts in 3VINRK (three in rack) expansion accessory set, [56](#)

parts in N2104A (two in rack) expansion kit, [17](#)  
 parts in N2105A (two in stack) expansion kit, [22](#)  
 parts in N2106A (add one) expansion kit, [32](#)  
 parts in N2107A (five to six) expansion kit, [40](#)  
 parts in N2122A channel deskew kit, [88](#)  
 parts in PLUS1V (add one) expansion accessory set, [56](#)  
 parts in PLUSRK (five to six) expansion accessory set, [69](#)  
 PLUS1V V-Series expansion accessory set (Expand One Frame), [54](#), [56](#), [66](#)  
 PLUSRK V-Series expansion accessory set (Expand One Rack), [66](#), [69](#)  
 power requirements, [13](#)

## Q

Q-Series oscilloscopes, [12](#)

## R

rack requirements, [14](#)  
 rack without sides, [14](#)  
 rack, equipment, [5](#)  
 rackmount system, 2 Z-Series or 90000 Q-Series oscilloscope, [15](#)  
 rackmount system, 3-to-5 V-Series or 90000 X-Series oscilloscope, [53](#)  
 rackmount system, 3-to-5 Z-Series or 90000 Q-Series oscilloscope, [29](#)  
 rackmount system, 6-to-10 V-Series or 90000 X-Series oscilloscope, [65](#)  
 rackmount system, 6-to-10 Z-Series or 90000 Q-Series oscilloscope, [37](#)  
 rack-to-rack thermal interaction, [14](#)  
 requirements, 90000 X-Series oscilloscopes, [48](#)  
 requirements, airflow/cooling, [13](#)  
 requirements, environmental, [13](#)  
 requirements, host computer, [87](#)  
 requirements, power, [13](#)  
 requirements, rack, [14](#)

## S

sample rate selection, 90000 X-Series, [51](#)  
 sample rate selection, 90000A Series, [83](#)  
 sample rate selection, S-Series, [83](#)  
 six- to ten V-Series or 90000 X-Series oscilloscope rackmount system, [65](#)  
 six- to ten Z-Series or 90000 Q-Series oscilloscope rackmount system, [37](#)  
 S-Series oscilloscopes, [79](#)  
 stackmount (2 Z-Series or 90000 Q-Series oscilloscope) system, [21](#)

sync port on 50 GHz and 63 GHz models, [13](#)  
 sync signal connections, six to ten V-Series or 90000 X-Series in rack, [69](#), [71](#), [73](#)  
 sync signal connections, six to ten Z-Series or 90000 Q-Series in rack, [41](#)  
 sync signal connections, three to five V-Series or 90000 X-Series in rack, [56](#), [58](#), [59](#)  
 sync signal connections, three to five Z-Series or 90000 Q-Series in rack, [32](#)  
 sync signal connections, two Z-Series or 90000 Q-Series in rack, [17](#)  
 synchronization port, [4](#)

## T

temperature, operating environment, [13](#)  
 three- to five V-Series or 90000 X-Series oscilloscope rackmount system, [53](#)  
 three- to five Z-Series or 90000 Q-Series oscilloscope rackmount system, [29](#)  
 Trig Out and 10 MHz Out connections, six to ten Z-Series or 90000 Q-Series in rack, [42](#)  
 Trig Out and 10 MHz Out connections, three to five Z-Series or 90000 Q-Series in rack, [33](#)  
 Trig Out and 10 MHz Out connections, two Z-Series or 90000 Q-Series in rack, [18](#)  
 triggering capability, full, [86](#)  
 two Z-Series or 90000 Q-Series oscilloscope rackmount system, [15](#)  
 two Z-Series or 90000 Q-Series oscilloscope stackmount system, [21](#)

## V

V-Series oscilloscopes, [47](#)

## Z

Z-Series oscilloscopes, [12](#)