

# Keysight Technologies

## Infiniium V-Series Oscilloscopes

8 - 33 GHz

Data Sheet

“Achieve Clarity Faster”



## Achieve Clarity Faster with Infiniium V-Series Oscilloscopes

### Groundbreaking oscilloscope technology

Infiniium V-Series oscilloscopes incorporate innovative technology designed to deliver superior measurements. Whether you are testing multiple high-speed serial lanes or a massive parallel bus, the new 12.5 Gb/s, industry's longest 160-bit hardware serial trigger and world's fastest 20 GSa/s digital channels will provide timely validation and debug. Our oscilloscope's low-noise front end technology, advanced InfiniMax III/III+ Series probes and revolutionary voltage termination adapter provide up to 33 GHz performance with the industry's best signal integrity. Together with the broadest software solution coverage, the V-Series helps you achieve clarity faster in your design characterization to ensure your product ships on time.

### Fastest analysis and enhanced usability

We put the groundbreaking oscilloscope technology in an innovate industrial design frame with a standard 500 GB removable solid state drive and high-powered motherboard for fastest analysis, capacitive 12.1" display for multi-touch usability and USB 3.0 ports for fast data offload speed. Coupled with the next-generation Infiniium user interface, the V-Series makes displaying, analyzing and sharing information much easier. It is the first user interface to take advantage of multiple displays and touch screens. It features up to 8 waveform windows with up to 16 grids in each of them, allowing 128 simultaneous viewing spaces.

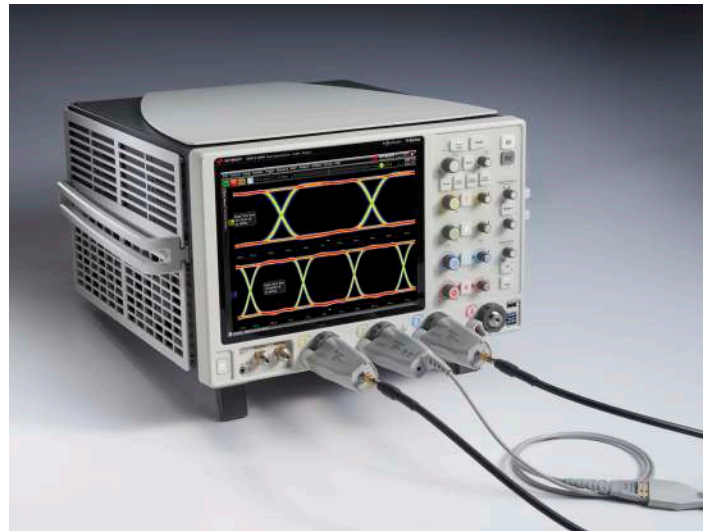

Infiniium V-Series' low-noise front end and the revolutionary voltage termination adapter provide the industry's best signal integrity.

Keysight's proprietary and custom front-end technology yields the industry's lowest noise floor and jitter measurement floor of real-time oscilloscope hardware available today.

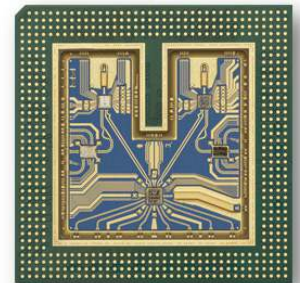

DSO models	DSA models	MSO models	Analog bandwidth		Sample rate		Max memory	Bandwidth upgradability
			2 channels	4 channels	2 channels	4 channels		
4 analog channels	4 analog channels	4 analog channels + 16 digital channels						
DSOV334A	DSAV334A	MSOV334A	33 GHz	16 GHz	80 GSa/s	40 GSa/s	2 Gpts	Yes. Each model is upgradable to each higher bandwidth step or the max bandwidth of 33 GHz.
DSOV254A	DSAV254A	MSOV254A	25 GHz	16 GHz	80 GSa/s	40 GSa/s	2 Gpts	
DSOV204A	DSAV204A	MSOV204A	20 GHz	16 GHz	80 GSa/s	40 GSa/s	2 Gpts	
DSOV164A	DSAV164A	MSOV164A	16 GHz	16 GHz	80 GSa/s	40 GSa/s	2 Gpts	
DSOV134A	DSAV134A	MSOV134A	13 GHz	13 GHz	80 GSa/s	40 GSa/s	2 Gpts	
DSOV084A	DSAV084A	MSOV084A	8 GHz	8 GHz	80 GSa/s	40 GSa/s	2 Gpts	

## Achieve Clarity Faster with Infiniium V-Series Oscilloscopes

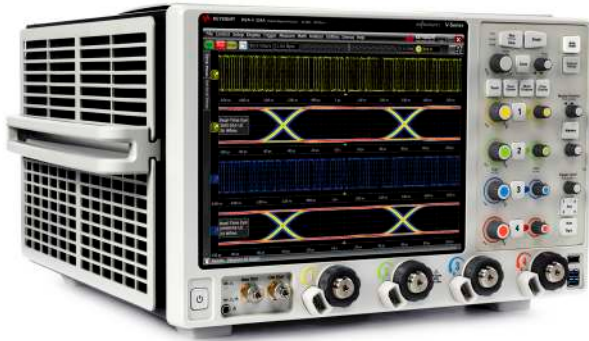

### Industry's best signal integrity for superior measurement accuracy

The Infiniium V-Series family has the best-in-class signal integrity real-time oscilloscopes in the industry, delivering the most margin for your design validation. They are ideal for spectral analysis of transients and wideband RF applications.

- True analog bandwidth to 33 GHz
- Lowest noise floor (2.10 mV at 50 mV/div, 33 GHz)
- Lowest intrinsic jitter (100 fs)
- Highest Effective Number Of Bits (ENOB) values in excess of 5.5
- Flattest frequency magnitude and phase response
- Spurious Free Dynamic Range (SFDR) exceeding 50 dBc

### Industry's most advanced probing system

The InfiniiMax III and III+ probing systems provide unmatched signal fidelity and bandwidth performance up to 30 GHz to meet today's high-speed signal probing requirements.

- Lowest noise and flattest frequency response
- Unique S-parameters stored in each probe, automatically downloaded to the scope for correction
- PrecisionProbe for most accurate correction to the probe tip
- InfiniiMode feature allows differential, single-ended and common mode measurements without probe reconnection
- First magnetically engaged probe for secure connection
- Lowest-noise active voltage termination adapter
- Industry's only bandwidth upgradable probes



### Industry's most comprehensive software solution

The V-Series has the deepest and broadest range of software solutions to accelerate understanding of your signal performance from fundamental analysis to debug and compliance.

- Analysis tools including jitter separation (Dual-Dirac, tail-fit, BUJ), eye-diagram, advanced de-embedding, FFE/CTLE/DFE equalizations and crosstalk analysis
- World's fastest digital channels, ideal for DDR4/LPDDR4 trigger and decode as well as parallel bus validation
- Debug with industry's longest 160-bit, 12.5 Gb/s hardware serial trigger, PRBS error detector and zone touch trigger
- Compliance software and technical expertise for high-speed standards (USB 3.1, PCIe Gen 4, HDMI 2.0, MIPI, Ethernet 100G, PAM-4, etc.) for highest measurement confidence

## Achieve Clarify Faster with the Best-in-class Infiniium V-Series Oscilloscopes

33 GHz true analog bandwidth and 80 GSa/s sample rate with ultra low-noise, intrinsic jitter and highest ENOB.

Find rare events with the industry's longest 160-bit, 12.5 Gb/s hardware serial trigger and PRBS error detector.

Increase your productivity with the next-generation Infiniium user interface, optimized for multiple displays and up to 128 simultaneous viewing spaces.

Enhance your visual and touch experience with a 12.1" XGA (1024 x 768) high resolution capacitive touch screen.

Identify anomalies easily with a 256-level intensity-graded or color-graded persistence display that provides a three-dimensional view of your signals.

Support remote control over Ethernet, GPIB and USB interfaces. Remote programming allows oscilloscope and software automation. LXI class C compliant, Web-interface and MATLAB enabled.

Correct insertion loss and skew of your test setup with PrecisionProbe. The oscilloscope generates an edge of 12 ps rise time to enable TDT calibration.

Capture the longest signal trace of up to 25 ms at 80 GSa/s sample rate using highest 2 Gpts of acquisition memory.



Trigger, analyze and debug your parallel bus with world's fastest digital channels. Decode cutting-edge DDR4 and LPDDR4 protocol memory buses.



External 10-MHz reference clock input and output for precise timebase synchronization with more than one oscilloscope, RF instruments or logic analyzers.

New industrial design and front panel layout that enhances user experience and operation of the oscilloscope.



Save Screen button provides quick access to capture oscilloscope waveform and analysis screenshots.

Customizable multipurpose key allows you to customize its function to make your favorite measurements, execute a script, save waveforms or load a setup.

Access the marker and change the positions quickly through the dedicated marker controls.

Quick access to fine control by pressing the horizontal and vertical knobs.

Five USB 3.0 host and device ports at the front and back panel for data offload speed. Additional USB 2.0 ports provide connectivity to your USB keyboard, mouse and other peripherals.

Threaded 3.5 mm RF connectors with convenient torque mechanism ensures the most reliable signal integrity and consistent 8 in. lbs. connection. The AutoProbe II interface provides a robust interface for the InfiniiMax III and III+ probing system.

Standard 500 GB removable solid state drive improves processing speed and enhances data security. 1 TB storage option is available.

## Industry's Best Signal Integrity

### Groundbreaking Oscilloscope Technology for Highest Measurement Accuracy

Whether you are deploying emerging high-speed bus technology, identifying spectral content of wideband RF signals or analyzing transient physical phenomena, you need the truest representation of your signal under test. Keysight invests in leading-edge technology to bring you the highest real-time oscilloscope measurement accuracy available today.

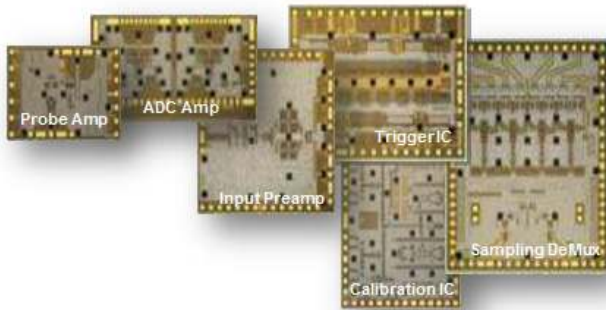

Keysight utilizes a proprietary Indium Phosphide (InP) integrated circuit process to design the key technology blocks to deliver high-bandwidth performance, ultra-low noise and high-voltage signal input. This process is used in the pre-amplifier, trigger, sampling, ADC and probe amplifier integrated circuit design. Not only does this mean you are purchasing the best oscilloscope on the market today, but you can also count on technology leadership from Keysight in the future.

Indium Phosphide Integrated Circuits

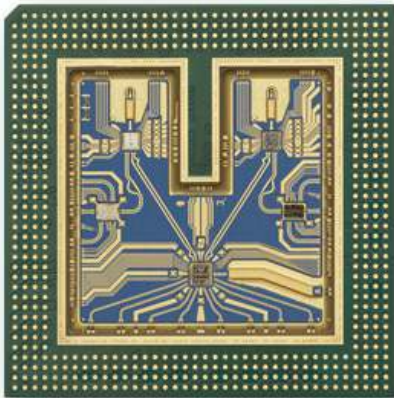

Infiniium V-Series' front-end multi-chip module integrates the pre-amplifier, trigger and sampling technology blocks using a proprietary cutting-edge packaging technology. Based on fine-line microcircuit processes and extensive experience with RF design, Keysight developed a front-end that provides excellent high-frequency electrical properties along with superior heat dissipation. The unique technology includes a quasi-coaxial path in the packaging to ensure signal shielding and delivers a high-speed clock to the sampler chip for the most accurate sampling time base.

Front-end multi-chip module



Acquisition board

All technology blocks, including the front-end, Analog-to-Digital Converter (ADC), memory controller, digital channels and hardware serial trigger, are meticulously laid out on the acquisition board with outstanding noise and coupling isolation. Time scale accuracy of 0.1 parts per million after calibration is achieved through precise clock synchronization and distribution, as well as the use of a 10-MHz Oven-Controlled Crystal Oscillator (OCXO) with  $\pm 0.1$  ppm of accuracy.

# Industry's Best Signal Integrity

## Superior measurements

Oscilloscope bandwidth allows signal rise times to be more accurately depicted. The oscilloscope noise floor directly impacts the y-axis voltage placement of each signal data point. The V-Series combines superiority in these characteristics with extremely low sample clock jitter (<100 fs). This ensures the lowest possible contribution to jitter measurements. In addition, the V-Series has the industry's deepest memory of up to 2 Gpts, allowing you to resolve low frequency jitter components in a single measurement.



Ultra-low noise at 33-GHz full bandwidth (2.10 mV at 50 mV/div).



Jitter measurement floor of less than 100 fs (80 fs with 30 GHz input sine wave).

Keysight's oscilloscopes are constantly improving in measurement accuracy. The latest innovation is an improved calibration routine that better aligns the sample points of the analog-to-digital converter. The improved calibration results in higher Spurious Free Dynamic Range (SFDR) and Effective Number of Bits (ENOB). The SFDR is improved as much as 15 dBc depending on the carrier frequency. Higher SFDR is ideal for making RF and optical measurements where spectral purity is of the utmost importance. Improved SFDR and ENOB also means better jitter performance. Ultimately this means the V-Series now features the highest SFDR and ENOB of any oscilloscope on the market.



Improved calibration increases the spurious free dynamic range by up to 15 dBc.



## Industry's Fastest Mixed Signal Oscilloscope

World's fastest 20 GSa/s digital channels, delivering best analog and digital performance

Today's designs require access to complex triggers and multiple instruments. A mixed signal oscilloscope (MSO) integrates traditional analog channels with 16 digital channels, providing up to 20 channels you can use at once. Keysight MSOs seamlessly integrate the familiar controls of an oscilloscope with the additional digital data acquisition and pattern recognition of a logic analyzer. You can trigger across any combination of analog and digital channels, as well as decode the acquired data. The MSO has the ability to label each individual channel as part of a bus for decoding, saving hours of manual work. With the fastest 20 GSa/s sample rate, it provides superior insight into low-speed serial and high-speed parallel bus interfaces.

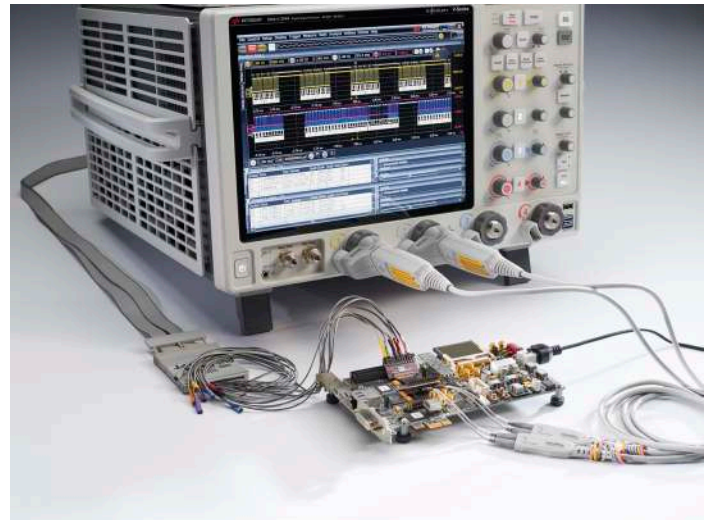

DDR3 test setup with mixed signal oscilloscope.

MSO optimized for DDR/LPDDR2, 3 and 4 protocol triggering and decode

The MSO is specially targeted at DDR/LPDDR2, 3 and 4 memory technologies, simplifying the complicated task of triggering, analyzing and debugging the parallel buses. The additional digital channels mean you can probe at the various command signals to easily trigger on the different DDR commands such as read, write, activate, precharge and more. DDR triggering makes read and write separation easy, providing fast electrical characterization, real-time eye analysis and timing measurements. The DDR protocol decoder can decipher the DDR packets and provide a time-aligned listing window to search for specific packet information.

All of the above features come standard with the MSO. The MSO is fully compatible with Keysight's 90-pin logic analysis connectors, making it easy to connect to your devices.

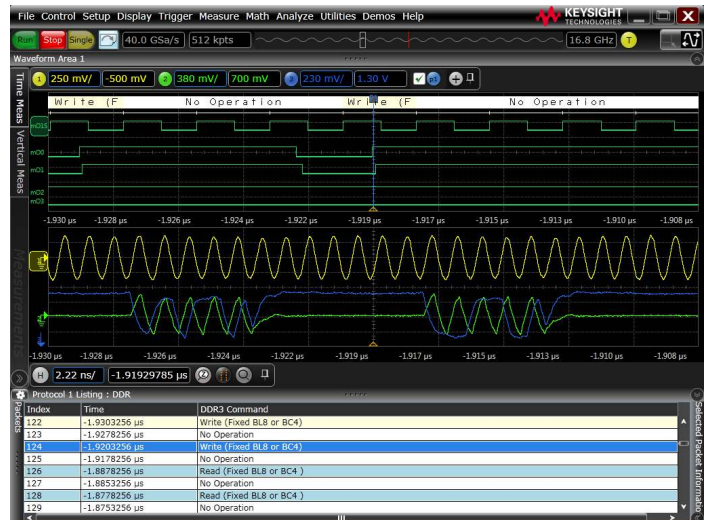

DDR3 protocol decode and write command trigger.

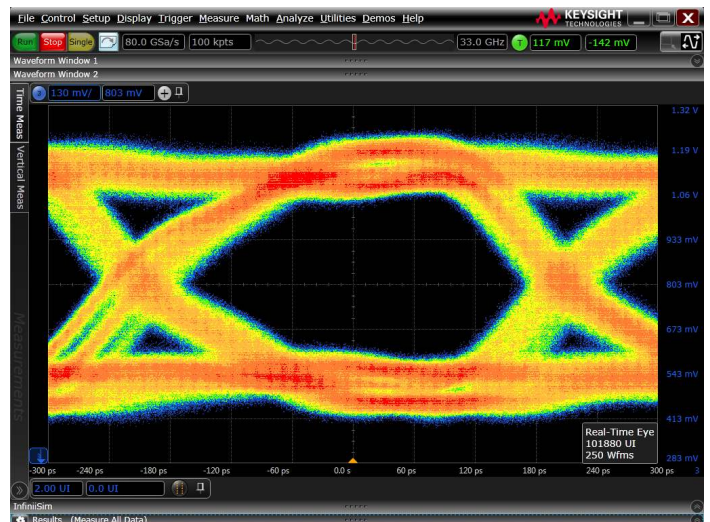

DDR3 write data burst eye-diagram analysis.





## Industry's Leading Hardware Serial Trigger

### Industry's only 12.5 Gb/s hardware serial trigger with SSC tracking at oscilloscope channel

The Infiniium V-Series hardware serial trigger's speed covers most common high-speed serial bus rates starting from 480 Mb/s up to 12.5 Gb/s, which include USB 2.0, USB 3.1, PCI Express Gen 3, HDMI 2.0 and SAS-3 applications. Most of these applications also support Spread Spectrum Clocking (SSC) where the high-speed signal is modulated, and the V-Series' hardware serial trigger is able to track the SSC at the oscilloscope input channel or with the use of an external reference clock input. The hardware serial trigger will recover and generate a sub-rate clock when locked to the signal.



External reference clock input is one of the methods to enable SSC tracking by the hardware serial trigger.

### Industry's first PRBS error detector

The PRBS error detector can trigger and display the bit error of the PRBS-7, 15, 23 and 31 signals. It identifies the error when the pattern does not match the expected PRBS pattern that has been set in the oscilloscope. When the next error happens, the oscilloscope will replace the display with the next bit error. This allows you to discover if the error is related to the bit pattern, which is related to Inter-Symbol Interference (ISI). The hardware serial trigger provides an eyescan plot to show the signal quality of the signal received.

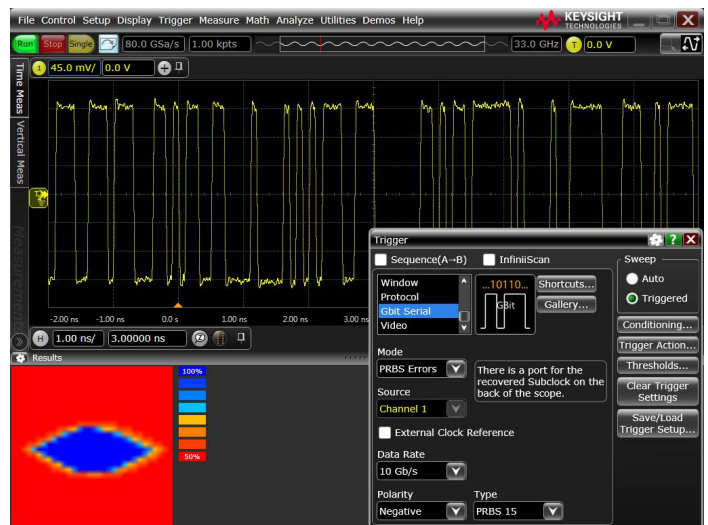

PRBS error detector triggers on a bit error in the PRBS-15 signal. An eyescan plot (bottom left) is provided to show the quality of the signal received by the hardware serial trigger. The hardware serial trigger works when there is enough eye opening (blue area) to discern the bit value.

### Use with InfiniiScan's software serial trigger for up to 240-bit sequence trigger

The hardware serial trigger can be combined with InfiniiScan's software event trigger to provide a two-stage trigger for up to 240-bit sequence. This is particularly powerful for the V-Series with its deep acquisition memory (up to 2 Gpts), providing long trace capture of 25 ms at the high resolution sampling rate of 80 GSa/s. The hardware first finds the 160-bit event condition and then uses InfiniiScan for an additional 80-bit event trigger. The InfiniiScan event trigger is not limited to bit sequence search. Other search functions such as zone touch trigger allow you to visually draw zones on the oscilloscope display as a second stage trigger.

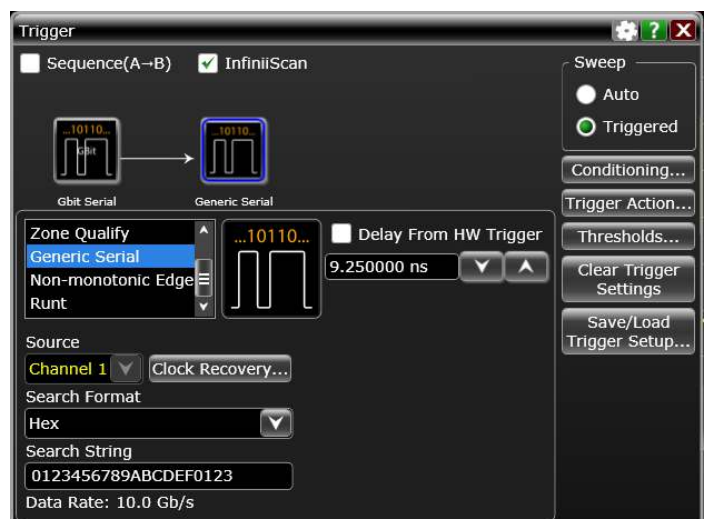

Hardware serial trigger and InfiniiScan's software serial trigger provide up to 240-bit sequence trigger.





## Industry's Most Advanced Probing System

### Industry's lowest-noise active voltage termination adapter

The N7010A active termination adapter provides a low noise single-ended cabled measurement solution with 50  $\Omega$  voltage termination ( $V_{\text{TERM}}$ ) up to 30 GHz bandwidth. The adapter is optimized for low amplitude signal measurements with its high signal-to-noise-ratio and low noise performance. The range of the  $V_{\text{TERM}}$  can be set to  $\pm 4$  V, which is ideal for applications such as HDMI, DisplayPort, MHL and MIPI M-PHY, which require voltage termination. The adapter is compatible with 2.92 mm, 3.5 mm and SMA connectors, as well as a SMP connector when an adapter is used.



N7010A active termination adapter provides a low noise single-ended cabled measurement solution with 50  $\Omega$  voltage termination ( $V_{\text{TERM}}$ ) up to 30 GHz bandwidth.

### Industry's first magnetically-engaged probe head and tip

The N2848A/49A QuickTip offers the industry's first magnetically-engaged probe head and tip for a quick and secure connection. The N2848A QuickTip probe head quickly snaps to the N2849A probe tip, utilizing magnets to connect to the two sides of the differential signal and ground. Multiple N2849A probe tips can be installed on a board or device, allowing quick and reliable measurement of many probe points. The QuickTip supports InfiniiMode probing when used with the InfiniiMax III+ probe amplifier and supports differential probing with the InfiniiMax III probe amplifier.

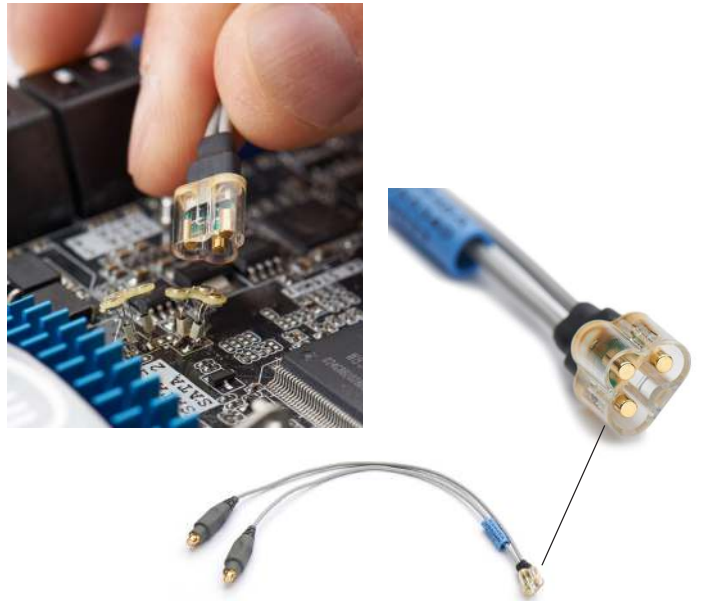

The N2848A/49A is the industry's first magnetically-engaged probe head and tip for a quick and secure connection.

For more information about InfiniiMax III and III+ probes matching the performance of your Infiniium oscilloscope, see the InfiniiMax III and III+ probes and accessories data sheet with the Keysight publication number 5990-5653EN.

## Industry's Most Advanced Probing System

Turn your V-Series into a Time-Domain Transmission (TDT) instrument to quickly characterize and compensate any probes, cables or measurement setup.

PrecisionProbe technology turns your oscilloscope into the ultimate characterization tool. It provides quick characterization of your entire measurement setup (including probes, cables and switches) without the need for extra equipment. PrecisionProbe takes advantage of the Infiniium V-Series' 12 ps edge to characterize and compensate for loss on the measurement system.

PrecisionProbe compensation technology:

- Creates custom probe transfer function ( $V_{out} / V_{in}$ )
- Characterizes probed system transfer function ( $V_{out} / V_{in} = V_{out} / V_{src}$ )
- Removes unwanted cable insertion loss (S21)

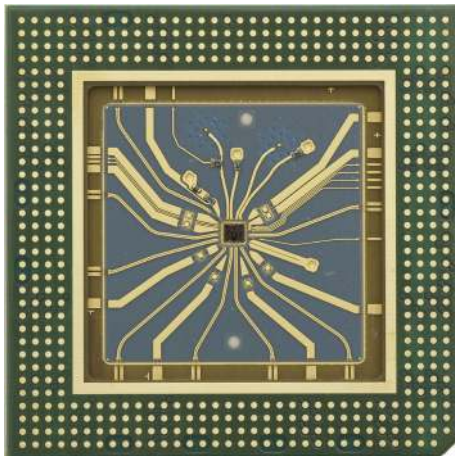

Keysight uses Indium Phosphide process to produce a 12 ps edge step response, ideal for characterizing cable and probe frequency response.



The magnitude and phase response of a cable corrected using PrecisionProbe.

Now every probe and cable in the system can have the exact same frequency response without measurement variation caused by probe or cable difference. You can properly characterize custom probes as well.

When you combine InfiniMax III and III+ probes with switches between the amplifier and the probe head, PrecisionProbe allows full correction for each probe's path. For increased accuracy, PrecisionProbe Advanced with faster edge (6 ps) is available.

### PCIe Gen 3 measurement improvement with PrecisionProbe

Root complex	Eye height with standard calibration	Eye height with PrecisionProbe	Margin improvements
5 GT/s	306.6 mV	348.33 mV	13.6%
8 GT/s	96.82 mV	106.01 mV	9.4%

## Industry's Most Comprehensive Software

The most advanced waveform transformation software helps you render (embed/de-embed) waveforms anywhere in your design.

The InfiniiSim waveform transformation toolset provides the most flexible and accurate means to render waveforms anywhere in your design. The highly-configurable system modeling enables you to de-embed the effects of unwanted channel elements, embed waveforms with channel models, view waveforms in physically improbable locations and compensate for loading of probes and other circuit elements.

### Hardware-accelerated rendering

The Infiniium V-Series renders the waveform in real time through the oscilloscope hardware so it does not increase processing time. Rendered waveforms are obtained quickly, which saves you much time compared to processing done in software.

### Circuit models to define your setup

The InfiniiSim waveform transformation toolset provides a graphical user interface for you to define your measurement system, including an arbitrarily complex system. Select from the application preset for different topologies. Define the circuit blocks with open, through, RLC circuit or S-parameter files.

### Model reflections

With the InfiniiSim waveform transformation toolset, you can transform signals with confidence, whether you are inserting or removing channel elements or relocating the measurement point. InfiniiSim lets you model up to 27 different elements or S-parameters at once, as well as the interaction between them. InfiniiSim is the only toolset with the ability to model more than one element including reflection model. The V-Series provides its own input reflection ( $S_{11}$ ) in all modeling.

### Model your system with as much detail as you need

InfiniiSim features the model setup that best matches your design. Whether it is a simple single-element model or an advanced general-purpose model with up to 27 elements in the link, you can perfectly model your design and simulate the exact probing point you want.

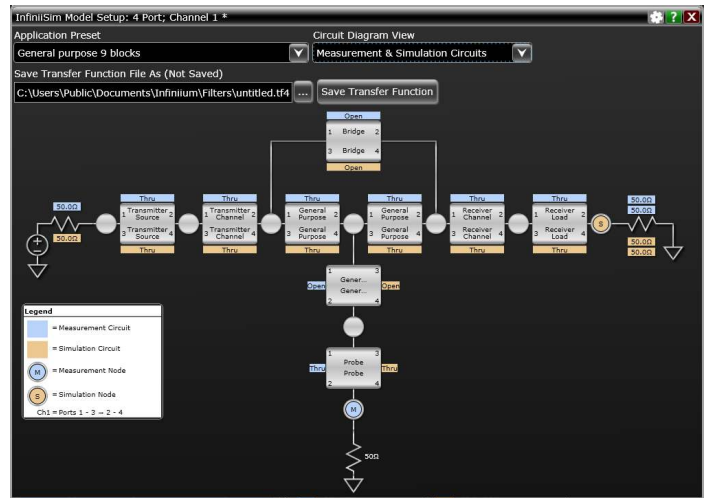

InfiniiSim allows embedding and de-embedding of up to 27 different elements or S-parameter models at once to meet your most demanding requirements.



InfiniiSim renders the waveform through hardware acceleration.



## Industry's Most Comprehensive Software

### Open tightly shut eyes with equalization

Serial data equalization for the Infiniium V-Series provides fast and accurate equalization using Feed-Forward Equalization (FFE), Continuous Time Linear Equalization (CTLE) and Decision Feedback Equalization (DFE) modeling in real time. The tool allows you to use a combination of the equalization, which is found in actual designs.

Serial data equalization software allows you to input your own equalizer settings and tap values that are used in your design, allowing you to simulate the eye opening in your receiver. If you prefer, the software can find the optimal tap values for you as well, which you can use as reference for your designs.

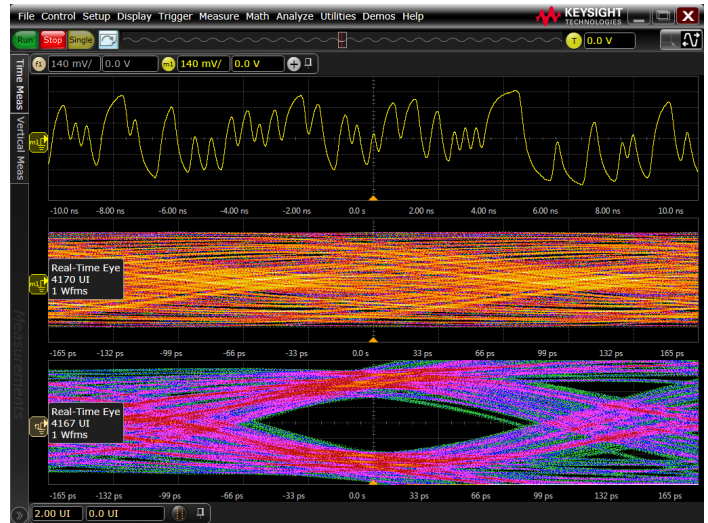

Serial data equalization opens the closed eye using CTLE and DFE methods.

### Powerful and flexible software trigger

The InfiniiScan software is a powerful tool for identifying signal integrity issues that hardware triggering is unable to find in your design. This innovative tool scans through thousands of acquired waveforms per second to help you isolate signal anomalies, saving you time and improving your designs. It includes an 80-bit sequence trigger to find events of interest.

InfiniiScan's zone touch trigger allows you to draw up to eight "must intersect" or "must not intersect" zones on the oscilloscope display to visually determine the event-identify condition. If you can see the event of interest on the screen, the zone touch trigger can be used to quickly and easily isolate it, saving significantly more time than complicated hardware triggers. Other triggers include non-monotonic edge, measurement limit search, runt and pulse width.

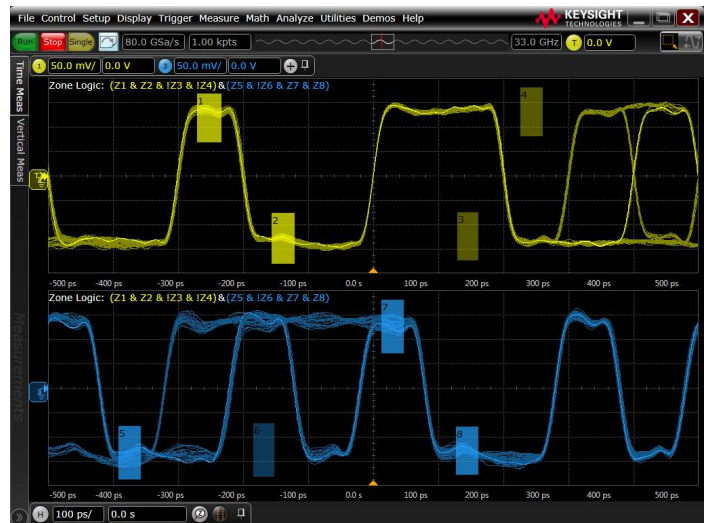

Draw up to eight "must intersect" or "must not intersect" zones to trigger on a specific event and condition.

## Industry's Most Comprehensive Software

### Gain insight into the causes of signal jitter to ensure your design has high reliability

With faster edge speeds and shrinking data-valid windows in today's high-speed digital designs, insight into the causes of jitter has become critical for success. Using EZJIT and EZJIT Plus jitter analysis software, the Infiniium V-Series helps you identify and quantify jitter components that affect the reliability of your design. Time correlation of jitter to the real-time signal makes it easy to trace jitter components to their sources. Additional compliance presets and a setup wizard simplify and automate RJ/DJ separation for testing against industry standards. EZJIT Plus automatically detects embedded clock frequencies and repetitive data patterns on the oscilloscope inputs and calculates the level of Data-Dependent Jitter (DDJ) that contributes to the Total Jitter (TJ) by each transition in the pattern, a feature unique to Infiniium oscilloscopes.

### Real-time eye and clock recovery

Serial Data Analysis (SDA) software provides flexible clock recovery including 1st- and 2nd-order PLL, explicit and constant clock. With a stable clock, you can look at real-time eyes of transition and non-transition bits. V-Series oscilloscopes with SDA software also provide a unique view of bits preceding an eye.

### Measurement trends and jitter spectrum

The EZJIT tool helps you quickly analyze the causes of jitter. Measurement trends allow you to see deeper views of factors affecting measurements. Jitter spectrum is a fast method to find the causes of jitter. The trend also allows you to characterize Spread Spectrum Clock (SSC) if it meets frequency and modulation deviation requirements.

### Two ways to separate jitter

EZJIT Plus comes with two ways to separate jitter: the industry-standard spectral method and the emerging tail-fit method. Both methods allow for simple separation of RJ and DJ, but the tail-fit method provides jitter separation in the unique case of non-symmetrical histograms and Aperiodic Bounded Uncorrelated Jitter (ABUJ).

### Unique RJ/DJ threshold view

EZJIT Plus also provides a unique spectral view of the jitter spectrum with the threshold drawn on the chart. The spectral view provides insight into the decision point of the separation and allows for narrow or wide, tail-fit or Dual-Dirac.

### Tools to determine the correct settings

SDA, EZJIT and EZJIT Plus come with an array of visual tools to make analyzing the data simple and ensure that the correct settings are chosen for difficult design decisions. For example, the improved bathtub curve is a helpful visual tool to determine which jitter separation method best fits the data.



Extract measurement trend from the signal for SSC characterization.



Multiple jitter analysis plots for enhanced visualization.

## Industry's Most Comprehensive Software

Discover signal anomalies in the amplitude noise domain of the waveform



Noise analysis with EZJIT Complete software for insight into the sources of noise in the signal.

### More than your standard jitter package

To efficiently determine root cause for any type of signal degradation in the amplitude domain, you must first determine whether the problem is caused by random or deterministic sources. To accomplish this task, EZJIT Complete takes analysis techniques used in the time domain (jitter analysis) and extends them into the amplitude domain.

### More than just an eye contour

EZJIT Complete is an in-depth view into impairments related to signal levels – either logic ones or logic zeroes – deviating from their ideal positions. Existing eye-diagram tools simply provide a view of an eye contour but do not provide real measurement data other than nice graphics and eye contour.

EZJIT Complete uses separation techniques to allow each bit to be examined to determine correlated effects, as well as make multiple measurements on individual bits to determine uncorrelated effects. Use FFTs to analyze the frequency domain and extract random components. Dual-Dirac modeling techniques are also carried from the jitter domain and used in the interference domain.

### Key measurements

With EZJIT Complete, the V-Series oscilloscopes offer the following unique noise measurements:

- Total Interference (TI)
- Deterministic Interference (DI)
- Random Noise (RN)
- Periodic Interference (PI)
- Inter-Symbol Interference (ISI)
- Relative Intensity Noise (RIN - dBm or dB/Hz)
- Q-factor



## Industry's Most Comprehensive Software

Use your PC to view and analyze data away from your oscilloscope

Now you can do additional signal viewing and analysis away from your oscilloscope and target system. Capture waveforms on your oscilloscope, save them to a file, and recall the waveforms into Keysight's Infiniium Offline application on your PC.

View and analyze anywhere your PC goes

Take advantage of the large, high-resolution screens and multiple displays found in your office. Use familiar oscilloscope controls to quickly navigate and zoom in to any event of interest. Use auto measurements and functions for additional insight.

Share scope measurements more easily across your team

You can share entire data records instead of being limited exclusively to static screen shots. Collaborate with team members who work in different locations.

Create more useful documentation

Add up to 100 bookmark annotations and up to 20 simultaneous measurements on the oscilloscope display. Use features such as "right-click" and "cut-and-paste" to move screen images into applications, without ever having to save the image to a file.

Access all advanced analysis capabilities

Infiniium Offline includes a variety of upgrade options including serial decode upgrades for a variety of serial buses, jitter analysis and serial data analysis found in your oscilloscope.



Infiniium Offline software supports a wide array of Infiniium applications.

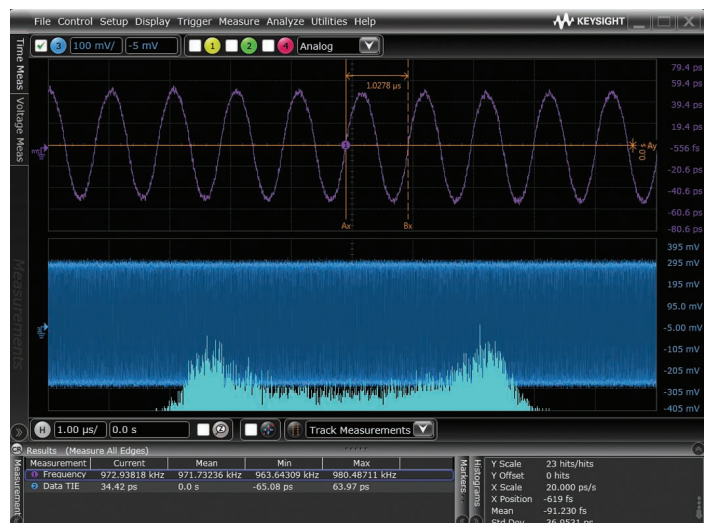

Use Infiniium Offline to find signal anomalies such as power supply coupling.



Peak search capability makes Infiniium Offline a frequency domain tool.

## Industry's Most Comprehensive Software

### Enhanced frequency and time domain measurements

#### Enhanced FFTs view

The Infiniium V-Series allows you to see frequency domain and time domain at the same time. The standard spectral viewer includes FFT controls such as start/stop, center frequency/span and resolution bandwidth (RBW). Readout includes power and frequency axis annotation and a peak table.



Peak readouts in the FFT plot.

#### Gated measurements and FFTs

The V-Series supports gated math and analysis including FFTs. Use any of the standard 16 independent gates to narrow measurements and FFT computations to a specific time window. Drag the gate in the time domain, and see time correlated FFT measurements for specified time periods. The example at the right shows two simultaneous FFTs.

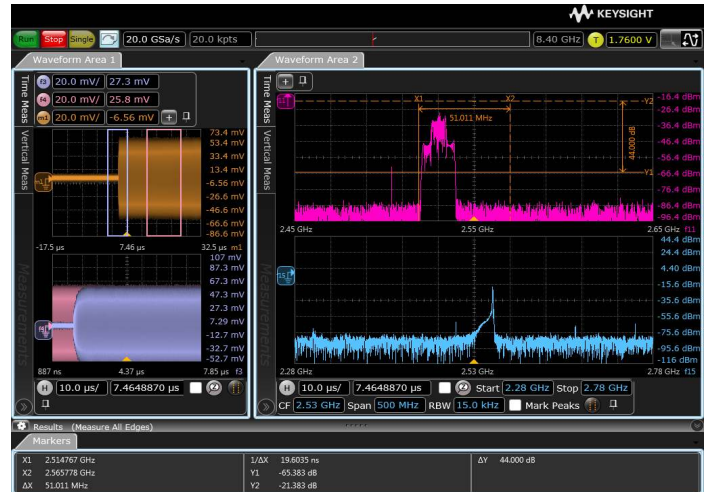

Perform measurements in the area of interest through the gated function.

#### Envelope measurements and AM demodulation

Envelope measurement tracks the outline and AM demodulation of a burst signal. This is required for applications such as Near-Field Communication (NFC) and wireless charging applications. Add measurements such as rise time to the envelope function for characterization of the burst signal.

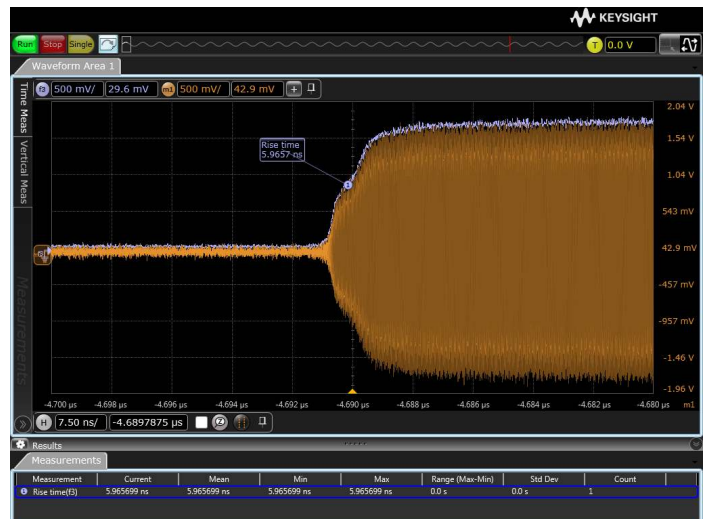

Envelope detection of signal burst.

## Industry's Most Comprehensive Software

### Compliance applications with deep standard technical expertise

Today's demanding environment means you have less time to understand the details of the technologies you are testing. You also have less time to develop test automation software to increase measurement throughput and decrease time to market.

Keysight's compliance applications and expertise save you time and resources with measurement automation. Compliance applications are certified to test to the exact specifications of each technology standard. If a test passes on the V-Series in your lab, you can be assured that it will pass in test labs and plugfests worldwide. Keysight experts are on multiple technology boards and industry standards committees, and they help to define compliance requirements.

Setup wizards combined with intelligent test filtering give you confidence that you are running the right tests. Comprehensive HTML reports with visual documentation and pass/fail results guarantee that critical information is retained. Check the V-Series ordering configuration for supported standards.

### Test customization and switch automation

The N5467B user-defined application's add-in provides you with the ability to add additional tests, instrument control and device control into the existing compliance applications. The compliance applications can be controlled via the remote programming interface (standard feature) for test automation.

Compliance applications on the V-Series support a switch matrix, making testing simpler by automating test for each lane of a multi-lane bus. Typical testing requires reconnecting the oscilloscope each time you switch a lane, which increases test time and possible inaccuracies. The V-Series solves this problem by supporting a switch matrix through its compliance test. Simply connect the switch to the oscilloscope and all the lanes, and then press run to complete full testing of your entire device. The compliance application fully supports PrecisionProbe and InfiniiSim software, giving you the ability to characterize and normalize every switch path to the device under test.

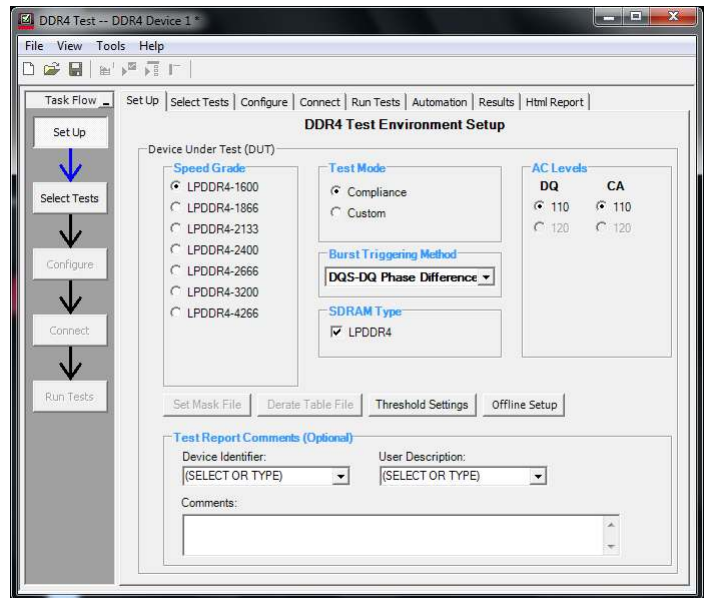

DDR4 and LPDDR4 compliance application providing full electrical and timing characterization based on JEDEC specification.



Test automation for multilane interface testing with no compromise on accuracy, which reduces test time and effort. An Infiniium 90000 X-Series oscilloscope is shown above.



## Industry's Most Comprehensive Software

### Decodes more than 20 protocol standards

The Infiniium V-Series oscilloscopes come with more than 20 protocol decoders for decoding high-speed serial bus and low-speed serial interface protocols. The list includes the industry's only 64b/66b decoder used by Ethernet 10GBase-KR standard and multilane MIPI decode. The V-Series protocol decoders feature time-correlated markers that let you easily move between the listing window and the waveform. It generates CRC value from the payload and compares the value with the embedded CRC to verify if any bit error has occurred. Once an error is detected, you can further debug the problem, whether it is caused by physical or protocol issues.

Multiple protocol decoders can be used at the same time with analog and digital channels. They feature search and trigger capability that lets you scan through the waveform to find the trigger condition that interests you. Protocol decoders are available in the Infiniium Offline tool as well. Check the V-Series ordering configuration for supported protocols.

### Combine V-Series and MATLAB for even more analysis

Enhance the V-Series with a seamless gateway to powerful MATLAB analysis functionality. User-defined function software adds new analysis capabilities to the V-Series beyond traditional math/analysis features. Now you have the freedom to develop your own math functions or filters using MATLAB and its signal processing toolbox. With a seamless integration to MATLAB, the V-Series allows you to display your math and analysis functions live on the oscilloscope screen, just like any other scope-standard functions.

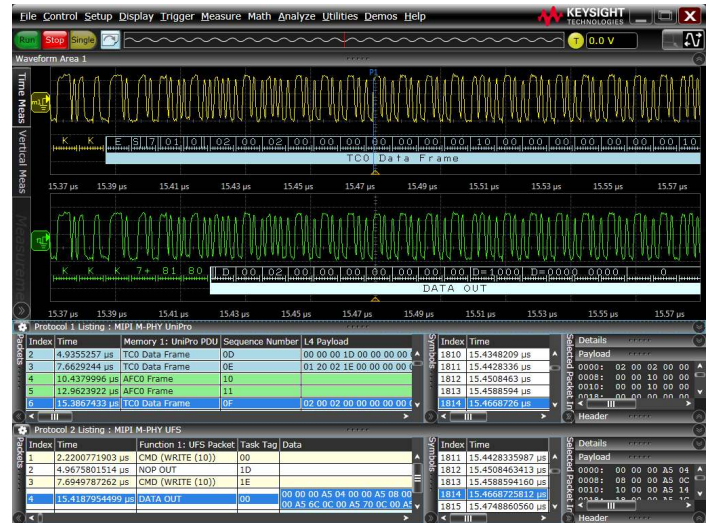

Packet decode and CRC verification through the oscilloscope MIPI UniPro and UFS protocol decoders.

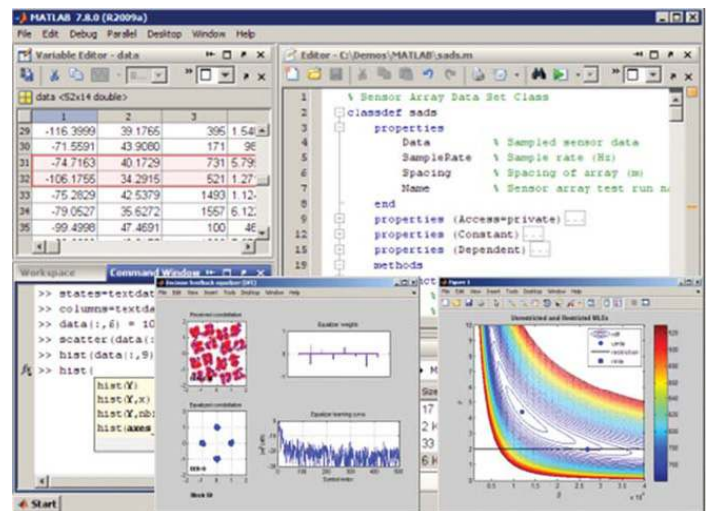

Seamless integration of oscilloscope and MATLAB software enhances the analysis capability.

## Achieve Clarify Faster - Frequency Domain Performance

### Wideband and multi-channel FFT measurements

For frequency domain measurements that require you to see more than 500 MHz of signal spectral bandwidth and multiple FFTs simultaneously, the V-Series offers wider bandwidth than spectrum analyzers and comes standard with 4 ports (channels) per instrument.

The V-Series enables users to make wideband measurements up to 33 GHz and up to 16 simultaneous FFTs. You can analyze even higher bandwidth signals by combining the V-Series with a down converter circuit.

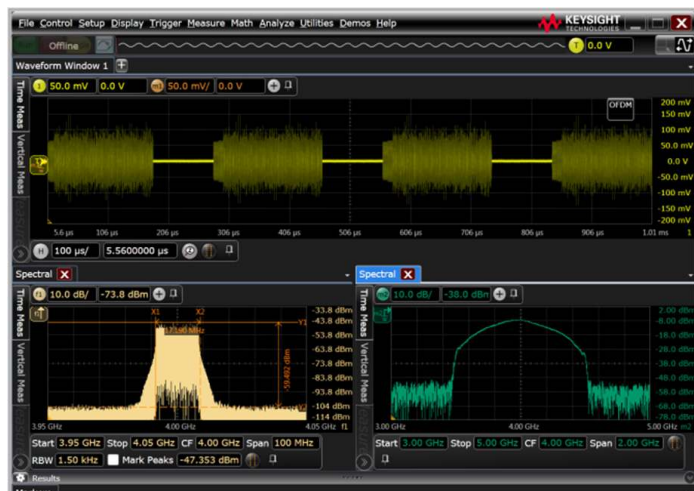
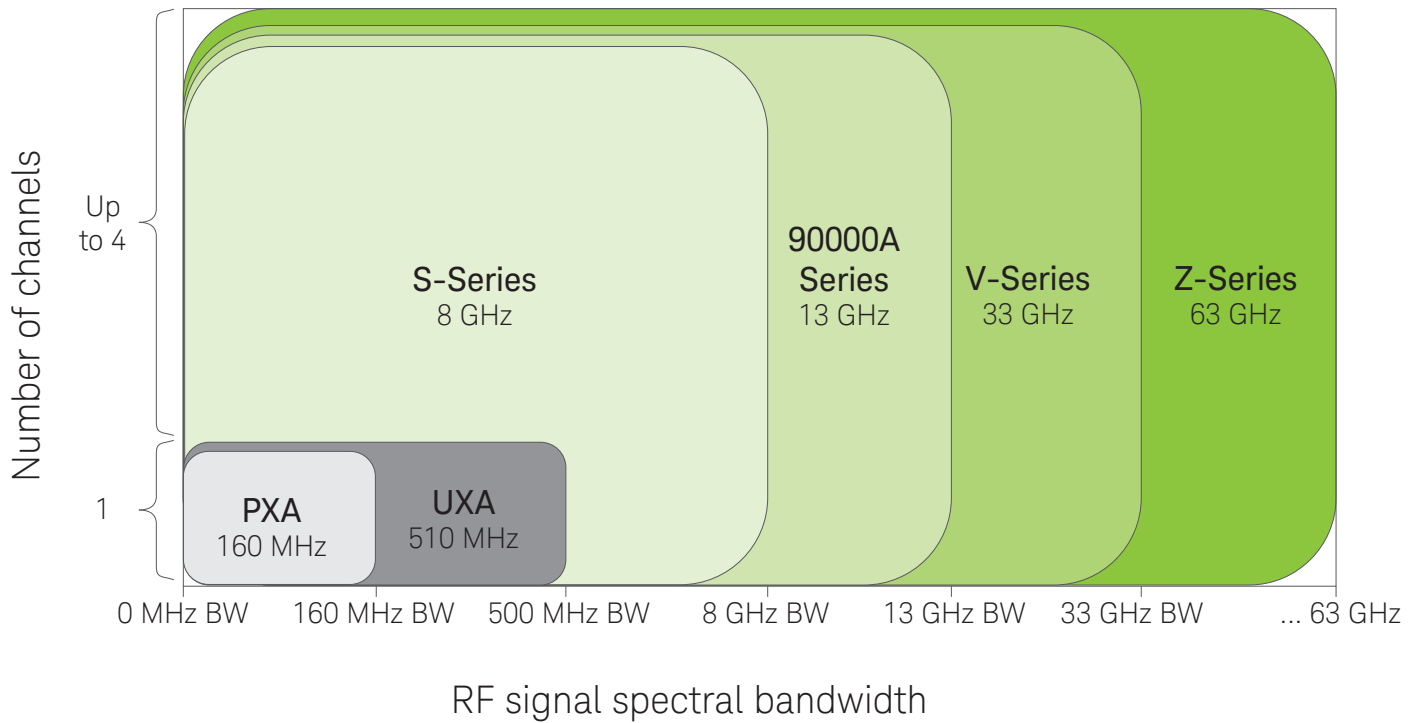

Use Infiniium capture and analysis of radar bursts as shown in this orthogonal frequency-division multiplexing (OFDM) example.

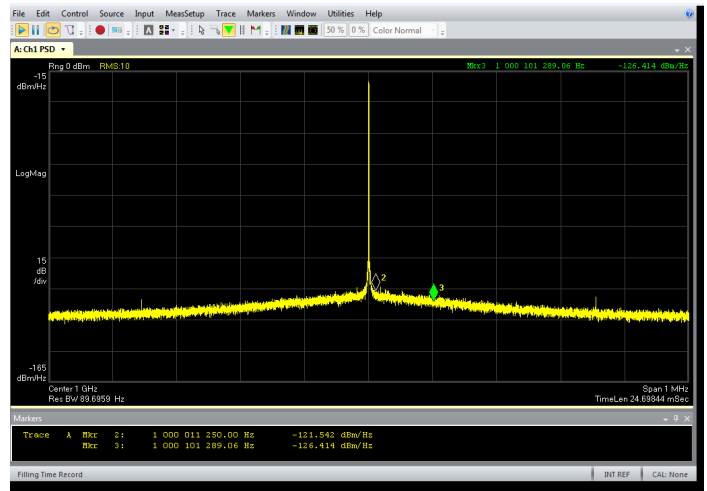

Using data acquired from V-Series, VSA shows phase noise of -125 dBc/Hz at 10 kHz and -131 dBc/Hz at 100 kHz.

## Achieve Clarify Faster - Frequency Domain Performance

Trying to interpret traditional oscilloscope time-domain specifications can be challenging when trying to determine if a specific scope can be recommended for RF, uW and mmW measurements. With correction filters, low-noise front end and spurious free dynamic range calibration, the V-Series oscilloscopes can be used for wideband frequency domain applications.

<b>V-Series typical values (tested at 33 GHz bandwidth, 1 channel on one scope unless noted)</b>	
<b>Sensitivity / noise density</b> (1 mV/div; -38 dBm range) Power spectral density measurement at 1.0001 GHz, 1.0001 GHz center frequency, 500 kHz span, and 3 kHz RBW	-159 dBm/Hz
<b>Noise figure</b> (derived from measurement above)	+15 dB
<b>Signal-to-noise ratio / dynamic range</b> (-1 dBm, 1 GHz input carrier, 0 dBm scope input range) 1 GHz center frequency, 100 MHz span, 1 kHz RBW, measurement at +20 MHz from center	+111 dB
<b>Absolute amplitude accuracy</b> (0 to 30 GHz)	± 0.5 dB
<b>Deviation from linear phase</b> (0 to 33 GHz)	± 3 deg
<b>Phase noise (at 1 GHz)</b> 10 kHz offset 100 kHz offset	-125 dBc/Hz -131 dBc/Hz
<b>EVM</b> (802.121 2.4 GHz carrier, 20 MHz wide, 64 QAM)	-47 dB (0.47%)
<b>Spurious responses (-4.6 dBm input signal, -4 dBm input range)</b> <b>Spurious Free Dynamic Range (SFDR)</b> 1 GHz, -4.6 dBm signal present at input, FFT = 5 GHz span, 3 GHz center, 100 kHz RBW	+67 dB
<b>2nd harmonic distortion</b> 1 GHz input, -4.6 dBm, 5 GHz span, 3 GHz center, 100 kHz RBW	-21 dB; 1.2 VSWR -51 dBc
<b>3rd harmonic distortion</b> 1 GHz input, -4.6 dBm, 5 GHz span, 3 GHz center, 100 kHz RBW	-51 dBc
<b>Two-tone Third-Order Intermodulation distortion (TOI)</b> -6.6 dBm input tones, 2.435 GHz and 2.439 GHz, 2 MHz separation, 2.437 GHz center frequency, 10 MHz span, 100 kHz RBW, 8 dBm range	+28 dB
<b>Input match (<math>S_{11}</math>)</b> (< 50 mV/div, 0-30 GHz, no attenuation) (≥ 50 mV/div, 0-30 GHz, no attenuation)	-15 dB; 1.4 VSWR -21 dB; 1.2 VSWR

Typical frequency domain characteristics for the Infiniium V-Series (not guaranteed, subject to change).

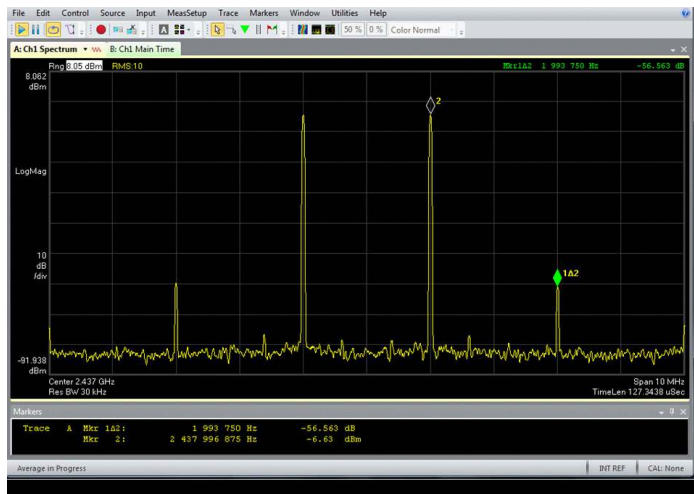

Using data acquired from the V-Series, VSA shows an excellent Third Order Intercept (TOI) value of 28 dB.

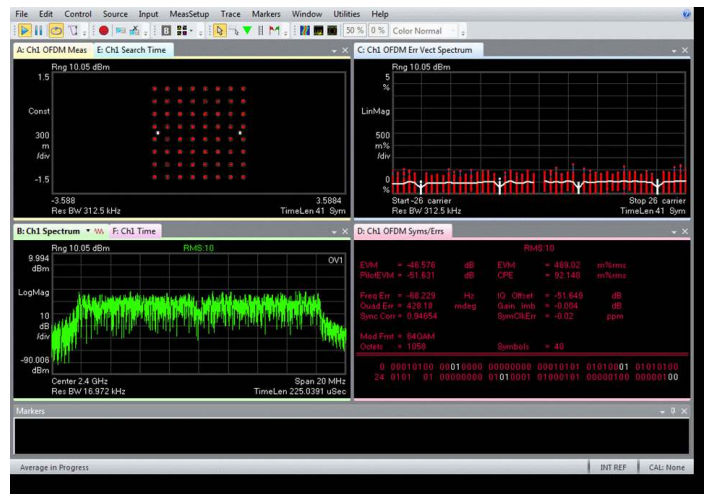

Using data acquired from the V-Series, VSA shows an Error Vector Magnitude (EVM) for IEEE 802.11 QAM 64 of 0.47%.



## Most Advanced Platform

Standard features on V-Series platform for the most advanced oscilloscope

### Fast, reliable and secure storage

The V-Series features 500 GB removable SSD for

- Fast boot-up time
- Increased reliability
- Easy removal for secure environments

### Powerful CPU and motherboard

V-Series includes an Intel Core i5 quad core processor with 16 GB of DDR3 RAM for fast computations, even with advanced math and deep memory. The I/O ports on the oscilloscope include

- Ethernet 10/100/1000 Base-T
- 4 USB 3.0 host ports (2 in front, 2 at the back)
- 1 USB 3.0 device port (1 at the back)
- 3 USB 2.0 host ports (1 in front, 2 at the back)
- DisplayPort and VGA video out. Drivers support up to two simultaneous displays



Standard 500 GB removable SSD for fast boot up, increased reliability and enhanced security.

### Fast data offload

For applications that require digitized waveforms to be offloaded, the V-Series has fastest offload interfaces.

- USB 3.0 for up to 200 MB/s data offload
- Ethernet 1000Base-T for up to 80 MB/s offload



Five USB 3.0 ports provide fast data offload.

### Touch-screen innovation

V-Series oscilloscopes incorporate a capacitive touch screen. In addition, Infiniium software includes a large number of touch-friendly enhancements including handles, enlarged touch fields when touch is enabled, and gestures (multi-touch).

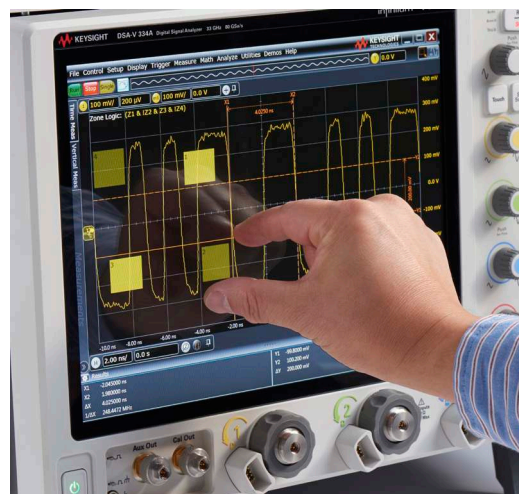

Capacitive touch and touch-friendly user interface enhances the oscilloscope usability.

## Keysight Infiniium Oscilloscope Portfolio

Keysight's Infiniium oscilloscope lineup includes bandwidths from 500 MHz to 63 GHz. Use the following selection guide to determine which best matches your specific needs. All Infiniium real-time oscilloscopes feature the following:

- Industry's best signal integrity for each family series
- Industry's most advanced probing system
- Industry's most comprehensive software solutions



Infiniium Series	S-Series	90000A Series	V-Series	Z-Series
Available bandwidths	500 MHz, 1 GHz, 2.5 GHz, 4 GHz, 6 GHz, 8GHz	2.5 GHz, 4 GHz, 6 GHz, 8 GHz, 12 GHz, 13 GHz	8 GHz, 13 GHz, 16 GHz, 20 GHz, 25 GHz, 33 GHz	20 GHz, 25 GHz, 33 GHz, 50 GHz, 63 GHz
Maximum upgradable bandwidth	8 GHz	13 GHz	33 GHz	63 GHz
Maximum sample rate	20 GSa/s	40 GSa/s	80 GSa/s	160 GSa/s
Maximum memory (2-channel)	800 Mpts	1 Gpts	2 Gpts	2 Gpts
Standard memory (2-channel)	100 Mpts	40 Mpts	100 Mpts	100 Mpts
Standard memory (4-channel)	50 Mpts	20 Mpts	50 Mpts	50 Mpts
Channel inputs	50 $\Omega$ and 1 M $\Omega$	50 $\Omega$	50 $\Omega$	50 $\Omega$
Connector type	Precision BNC	Precision BNC	3.5 mm	3.5 mm (33 GHz input) 1.85 mm (>33 GHz input)
Connector mate	BNC	BNC	SMA, 2.92 mm	SMA, 2.92 mm (33 GHz input) 2.4 mm (>33 GHz input)
MSO models	Yes	No	Yes <sup>2</sup>	No
Hardware serial trigger option	No	No	Yes <sup>1,2</sup>	No
Supported InfiniiMax probe series	InfiniiMax I InfiniiMax II InfiniiMax III+	InfiniiMax I InfiniiMax II InfiniiMax III+	InfiniiMax III/III+ InfiniiMax I/II with N5442A adapter	InfiniiMax III/III+ InfiniiMax I/II with N5442A adapter

1. Trigger at a maximum 160-bit sequence or sixteen 8b/10b symbols. Works only on channel 1.

2. Either MSO or hardware serial trigger option can be added to the oscilloscope.

## Infiniium V-Series Ordering Configuration

Get the most out of your oscilloscope investment by choosing options and software for your most common tasks. Configure your Infiniium V-Series oscilloscope in three easy steps.

### 1. Choose your oscilloscope, memory and options

#### Oscilloscope main frame

Oscilloscope models <sup>1</sup>			Analog bandwidth		Sample rate	
DSO models (4 analog channels)	DSA models (4 analog channels) <sup>2</sup>	MSO models (4 analog channels + 16 digital channels)	2 channel	4 channel	2 channel	4 channel
DSOV334A	DSAV334A	MSOV334A	33 GHz	16 GHz	80 GSa/s	40 GSa/s
DSOV254A	DSAV254A	MSOV254A	25 GHz	16 GHz	80 GSa/s	40 GSa/s
DSOV204A	DSAV204A	MSOV204A	20 GHz	16 GHz	80 GSa/s	40 GSa/s
DSOV164A	DSAV164A	MSOV164A	16 GHz	16 GHz	80 GSa/s	40 GSa/s
DSOV134A	DSAV134A	MSOV134A	13 GHz	13 GHz	80 GSa/s	40 GSa/s
DSOV084A	DSAV084A	MSOV084A	8 GHz	8 GHz	80 GSa/s	40 GSa/s

All models come with power cord, keyboard, mouse, calibration cable, ESD wrist strap and (5) coax adapters<sup>3</sup>.

#### Oscilloscope memory depth<sup>4</sup>

Acquisition memory depth upgrade	Option number on new oscilloscope
50 Mpts/channel memory	Standard
100 Mpts/channel memory upgrade <sup>5</sup>	DSOV000-100
200 Mpts/channel memory upgrade	DSOV000-200
500 Mpts/channel memory upgrade	DSOV000-500
1 Gpts/channel memory upgrade	DSOV000-01G
2 Gpts/channel memory upgrade	DSOV000-02G

#### Options

Description	Option number on new oscilloscope
Hardware serial trigger <sup>6</sup>	DSOV000-810
MSO with additional 16 digital channels <sup>6</sup>	Standard on MSO models
1 TB removable Solid State Drive (SSD) with Windows 7	DSOV000-801
GPIB card-interface	DSOV000-805
Performance verification and deskew fixture	DSOV000-808
Stack mount kit option for stacking two frames	N2117A
Rack mount kit	N5470A
ANSI Z540 compliant calibration	DSOV000-A6J
Calibration + uncertainties + guardbanding (accredited)	DSOV000-AMG

- All models ship standard with 3-year warranty.
- DSA models come standard with 100 Mpts/channel, EZJIT Complete and Serial Data Analysis.
- Oscilloscope 8, 13 and 16 GHz models come with adapters rated to 25 GHz (part number 1250-3758). All other models come with adapter rated to 35 GHz (part number 5061-5311).
- Memory depth per channel when 4 channels are turned on.
- DSA models come with 100 Mpts/channel standard.
- Either MSO or hardware serial trigger option can be added to the oscilloscope. Upgrade is not available when the oscilloscope already has the MSO or hardware serial trigger installed.



## Infiniium V-Series Ordering Configuration (continued)

### 2. Choose your probes and accessories

#### Analog probes and accessories

Description	Model number
30 GHz InfiniiMax III probe amplifier	N2803A
25 GHz InfiniiMax III probe amplifier	N2802A
20 GHz InfiniiMax III probe amplifier	N2801A
16 GHz InfiniiMax III probe amplifier	N2800A
20 GHz InfiniiMax III+ probe amplifier <sup>1</sup>	N7000A
16 GHz InfiniiMax III+ probe amplifier <sup>1</sup>	N7001A
13 GHz InfiniiMax III+ probe amplifier <sup>1</sup>	N7002A
8 GHz InfiniiMax III+ probe amplifier <sup>1</sup>	N7003A
QuickTip probe head <sup>2</sup>	N2848A
QuickTip probe tip (set of 4) <sup>2</sup>	N2849A
16 GHz solder-in probe head	N5441A
26 GHz solder-in probe head <sup>2</sup>	N2836A
ZIF probe head	N5439A
450 $\Omega$ ZIF tip replacement (set of 5)	N5440A
250 $\Omega$ ZIF tip replacement (set of 5)	N5447A
25 GHz PC board ZIF tip	N2838A
Browser (hand held) probe head	N5445A
Browser tip replacement (set of 4)	N5476A
3.5 mm/2.92 mm/SMA probe head <sup>2</sup>	N5444A
30 GHz voltage termination adapter	N7010A
Performance verification and deskew fixture	N5443A
Precision BNC adapter (50 ohm)	N5442A
Sampling scope adapter	N5477A
2.92 mm head flex cable	N5448A
High impedance probe adapter (includes one passive probe)	N5449A

For more information about Keysight's InfiniiMax III and III+ probing system, view the data sheet with the Keysight publication number 5990-5653EN.

1. With InfiniiMode technology, allowing you to switch to differential, single-ended, and common mode without adjusting probe tip connections.
2. Probe head that supports InfiniiMode connections.

#### MSO probes and accessories

Description	Model number
Single-ended flying lead set	E5382B
Single-ended soft touch connectorless probe	E5390A
1/2 size soft touch connectorless probe	E5398A
Differential soft touch probe	E5387A
Differential flying leads	E5381A

The MSO is compatible with all Keysight 90-pin cable connectors. The N2815A MSO/LA cable comes standard with MSO models or MSO upgrade.

## Infiniium V-Series Ordering Configuration (continued)

### 3. Choose your measurement-specific software

#### Measurement and analysis software

Description	License type		
	Fixed	Floating	
	Factory-installed on new oscilloscope or user-installed on existing oscilloscope	User-installed transportable license	Server-based license
EZJIT Complete jitter analysis	N8823A-1FP	N8823A-1TP	N5435A-067
EZJIT Plus jitter analysis	N5400A-1FP	N5400A-1TP	N5435A-001
EZJIT jitter analysis	E2681A-1FP	E2681A-1TP	N5435A-002
Frequency domain analysis	N8832A-001	-	-
High-speed SDA and clock recovery	E2688A-1FP	E2688A-1TP	N5435A-003
InfiniiScan software triggering	N5414B-1FP	N5414B-1TP	N5435A-004
InfiniiSim advanced signal de-embedding	N5465A-1FP	N5465A-1TP	N5435A-027
InfiniiSim basic signal de-embedding	N5465A-3FP	N5465A-3TP	N5435A-026
MATLAB - Basic digital analysis	N8831A-001	-	-
MATLAB - Standard digital analysis	N8831A-002	-	-
MultiScope combining up to 10 oscilloscopes <sup>1,2</sup>	N8822A-1FP	N8822A-1TP	-
PrecisionProbe calibration	N2809A-1FP	N2809A-1TP	N5435A-044
Serial data equalization	N5461A-1FP	N5461A-1TP	N5435A-025
Spectrum visualizer	64996A-1FP	64996A-1TP	-
User-defined function	N5430A-1FP	N5430A-1TP	N5435A-005

1. Requires MATLAB (Option N8831A) software. The multi-channel waveforms are digitized directly into the MATLAB environment.

2. Scope models must be either the V-Series or 90000 X-Series.

## Infiniium V-Series Ordering Configuration (continued)

### 3. Choose your measurement-specific software (continued)

#### Compliance test and validation software

Description	License type		
BroadR-Reach	N6467A-1FP	N6467A-1TP	N5435A-062
DDR1 and LPDDR1	U7233A-1FP	U7233A-1TP	N5435A-021
DDR2 and LPDDR2	N5413B-1FP	N5413B-1TP	N5435A-037
DDR3 and LPDDR3	U7231B-1FP	U7231B-1TP	N5435A-053
DDR4 and LPDDR4	N6462A-1FP	N6462A-1TP	N5435A-056
DisplayPort 1.2	U7232C-1FP	U7232C-1TP	N5435A-041
eDP 1.4	N6469A-1FP	N6469A-1TP	N5435A-083
eMMC	N6465A-1FP	N6465A-1TP	N5435A-061
Ethernet + EEE 10/100/1000Base-T	N5392B-1FP	N5392B-1TP	N5435A-060
Ethernet 10GBase-T	U7236A-1FP	U7236A-1TP	N5435A-023
Ethernet 10GBase-KR	N8814B-1FP	N8814B-1TP	N5435A-059
Ethernet 100GBase-CR10	N8828A-1FP	N8828A-1FP	N5435A-078
Ethernet 100GBase-CR4	N8830A-1FP	N8830A-1FP	N5435A-080
Ethernet 100GBase-KR4	N8829A-1FP	N8829A-1FP	N5435A-079
GDDR5	U7245A-1FP	U7245A-1TP	-
HDMI 2.0	N5399C-1FP	N5399C-1TP	N5435A-070
MHL 3.0	N6460B-1FP	N6460B-1TP	N5435A-078
MIPI D-PHY	U7238C-1FP	U7238C-1TP	N5435A-022
MIPI M-PHY	U7249C-1FP	U7249C-1TP	N5435A-043
MOST	N6466A-1FP	N6466A-1TP	N5435A-068
PCI Express Gen 3	N5393D-1FP	N5393D-1TP	N5435A-040
SAS-3	N5412D-1FP	N5412D-1TP	N5435A-073
SATA Gen 3	N5411B-1FP	N5411B-1TP	N5435A-028
SFP+	N6468A-1FP	N6468A-1TP	N5435A-074
USB 2.0	N5416A-1FP	N5416A-1TP	N5435A-017
USB 3.1	U7243B-1FP	U7243B-1TP	N5435A-075
USB HSIC	U7248A-1FP	U7248A-1TP	N5435A-042
UHS-I	U7246A-1FP	U7246A-1TP	-
UHS-II	N6461A-1FP	N6461A-1TP	N5435A-052
User-defined application	N5467B-1FP	N5467B-1TP	N5435A-058
Thunderbolt	N6463B-1FP	N6463B-1TP	N5435A-057
XAUI	N5431A-1FP	N5431A-1TP	N5435A-018



## Infiniium V-Series Ordering Configuration (continued)

### 3. Choose your measurement-specific software (continued)

#### Protocol decode software

8b/10b (generic)	_1	_1	_1
64b/66b (10GBase-KR)	N8815A-1FP	N8815A-1TP	N5435A-045
CAN/LIN/FlexRay	N8803A-1FP	N8803A-1TP	N5435A-033
DDR2/3/4 and LPDDR2/3/4	_2	_2	_2
I <sup>2</sup> C/SPI	N5391A-1FP	N5391A-1TP	N5435A-006
JTAG	N8817A-1FP	N8817A-1TP	N5435A-038
MIPI CSI-3	N8820A-1FP	N8820A-1TP	N5435A-065
MIPI DigRF v4	N8807A-1FP	N8807A-1TP	N5435A-047
MIPI D-PHY	N8802A-1FP	N8802A-1TP	N5435A-036
MIPI LLI	N8809A-1FP	N8809A-1TP	N5435A-049
MIPI RFFE	N8824A-1FP	N8824A-1TP	N5435A-072
MIPI UFS	N8818A-1FP	N8818A-1TP	N5435A-063
MIPI UniPro	N8808A-1FP	N8808A-1TP	N5435A-048
PCIe 1 and 2	N5463A-1FP	N5463A-1TP	N5435A-032
PCIe 3	N8816A-1FP	N8816A-1TP	N5435A-046
RS-232/UART	N5462A-1FP	N5462A-1TP	N5435A-031
SATA	N8801A-1FP	N8801A-1TP	N5435A-035
SSIC	N8819A-1FP	N8819A-1TP	N5435A-064
SVID	N8812A-1FP	N8812A-1TP	N5435A-054
USB 2.0	N5464A-1FP	N5464A-1TP	N5435A-034
USB 3.0	N8805A-1FP	N8805A-1TP	N5435A-071

1. Standard on DSA models or with high-speed SDA option.

2. Standard on MSO models or with MSO upgrade.

## Ordering Configuration

### Upgrade your existing oscilloscope

#### Bandwidth upgrades

Description	Option number
Bandwidth upgrade to 13 GHz	DSOV13GBW
Bandwidth upgrade to 16 GHz	DSOV16GBW
Bandwidth upgrade to 20 GHz <sup>2</sup>	DSOV20GBWU
Bandwidth upgrade to 25 GHz <sup>2</sup>	DSOV25GBWU
Bandwidth upgrade to 33 GHz <sup>2</sup>	DSOV33GBWU

#### Memory upgrades

Description	Option number
50 Mpts/channel to 100 Mpts/channel memory upgrade	N2810A-100
100 Mpts/channel to 200 Mpts/channel memory upgrade	N2810A-200
200 Mpts/channel to 500 Mpts/channel memory upgrade	N2810A-500
500 Mpts/channel to 1 Gpts/channel memory upgrade	N2810A-01G
1 Gpts/channel to 2 Gpts/channel memory upgrade	N2810A-02G

#### Other upgrades

Description	Option number
Hardware serial trigger upgrade <sup>1,2</sup>	N2119AU
MSO upgrade <sup>1,2</sup>	N2118AU
Additional 500 GB removable Solid State Drive (SSD) with Windows 7	N2110A-500
Additional 1 TB removable Solid State Drive (SSD) with Windows 7	N2110A-01T
GPIB card-interface	82351B
Performance verification and deskew fixture	N5443A
Stack mount kit option for stacking two frames	N2117A
Rack mount	N5470A

1. Either MSO or hardware serial trigger option can be added to the oscilloscope. Upgrade is not available when the oscilloscope already has the MSO or hardware serial trigger installed.
2. Return to Keysight service center is required to perform upgrade.

## Infiniium V-Series Performance Characteristics

### Vertical

DSO/DSA/MSO models	V084A	V134A	V164A	V204A	V254A	V334A
<b>Vertical - oscilloscope channels</b>						
Input channels	DSO/DSA models - 4 analog MSO models - 4 analog + 16 digital					
Analog bandwidth (-3dB)						
2 channel*	8 GHz	13 GHz	16 GHz	20 GHz	25 GHz	32 GHz
2 channel (typical)	8.4 GHz	13.6 GHz	16.8 GHz	21 GHz	26.2 GHz	33 GHz
4 channel (typical)	8.4 GHz	13.6 GHz	16.8 GHz	16.8 GHz	16.8 GHz	16.8 GHz
Rise time/fall time						
10 - 90% <sup>4</sup>	55.0 ps	33.8 ps	27.5 ps	22.0 ps	17.6 ps	13.3 ps
20 - 80% <sup>5</sup>	38.9 ps	23.9 ps	19.4 ps	15.6 ps	12.4 ps	9.4 ps
Input impedance <sup>1</sup>	50 Ω, ± 3%					
Input sensitivity <sup>2</sup>	1 mV/div to 1 V/div					
Full scale hardware sensitivity	60 mV to 8 V (oscilloscope only) 60 mV to 1.2 V (oscilloscope with N7010A voltage termination adapter)					
Input coupling	DC					
Vertical resolution <sup>2,3</sup>	8 bits, ≥ 12 bits with high-resolution mode or averaging					
Channel-to-channel isolation (any two channels with equal V/div settings)	DC to 16 GHz: 40 dB > 16 GHz: 35 dB					
DC gain accuracy* <sup>1,2,3</sup>	± 2% of full scale at full resolution channel scale (± 2.5% for ≤ 5 mV/div)					
Maximum input voltage	± 5 V					
Offset range	<b>Vertical sensitivity</b>	<b>Available offset (oscilloscope only)</b>		<b>Available offset (oscilloscope with N7010A voltage termination adapter)</b>		
	0 mV/div to 50 mV/div	± 0.4 V		± 4 V		
	> 50 mV/div to 100 mV/div	± 0.7 V		± 4 V		
	> 200 mV/div to 500 mV/div	± 1.2 V		± 4 V		
	> 500 mV/div	± 2.4 V		± 4 V		
Offset accuracy*	≤ 3.5 V: ± (2% of channel offset + 1% of full scale + 1 mV)					
Dynamic range	± 4 div from center screen					
DC voltage measurement accuracy	Dual cursor: ± [(DC gain accuracy) + (resolution)] Single cursor: ± [(DC gain accuracy) + (offset accuracy) + (resolution/2)]					

\* Denotes warranted specifications, all others are typical. Specifications are valid after 30-minute warm up period and ± 5% from oscilloscope firmware calibration temperature.

1. Input impedance is valid when V/div scaling is adjusted to show all waveform vertical values within scope display.
2. Full scale is defined as eight vertical divisions. Magnification is used below 7.5 mV/div. Below 7.5 mV/div, full scale is defined as 60 mV/div. The major scale settings are 1 mV/div, 2 mV/div, 5 mV/div, 10 mV/div, 20 mV/div, 50 mV/div, 100 mV/div, 200 mV/div, 500 mV/div and 1V/div.
3. Vertical resolution for 8 bits = 0.4% of full scale, for 12 bits = 0.024% of full scale.
4. Calculation based on  $T_r = 0.44/BW$ .
5. Calculation based on  $T_r = 0.31/BW$ .



## Infiniium V-Series Performance Characteristics (continued)

<b>RMS noise floor (oscilloscope only)</b>	<b>V084A</b>	<b>V134A</b>	<b>V164A</b>	<b>V204A</b>	<b>V254A</b>	<b>V334A</b>
<b>Vertical setting (mVrms)</b>	<b>8 GHz</b>	<b>13 GHz</b>	<b>16 GHz</b>	<b>20 GHz</b>	<b>25 GHz</b>	<b>33 GHz</b>
5 mV/div	0.21 mV	0.27 mV	0.31 mV	0.37 mV	0.45 mV	0.58 mV
10 mV/div	0.23 mV	0.28 mV	0.36 mV	0.42 mV	0.49 mV	0.60 mV
20 mV/div	0.46 mV	0.57 mV	0.65 mV	0.74 mV	0.83 mV	1.04 mV
50 mV/div	1.04 mV	1.09 mV	1.32 mV	1.54 mV	1.73 mV	2.09 mV
100 mV/div	1.92 mV	2.30 mV	2.63 mV	3.02 mV	3.39 mV	3.98 mV
200 mV/div	4.39 mV	5.52 mV	6.14 mV	6.92 mV	8.16 mV	9.88 mV
500mV/div	10.07 mV	12.42 mV	13.68 mV	15.05 mV	17.08 mV	20.25 mV
1 V/div	18.47 mV	21.36 mV	26.12 mV	30.15 mV	34.36 mV	39.35 mV
<b>RMS noise floor (with N7010A voltage termination adapter)</b>						
<b>Vertical setting (mVrms)</b>	<b>8 GHz</b>	<b>13 GHz</b>	<b>16 GHz</b>	<b>20 GHz</b>	<b>25 GHz</b>	<b>30 GHz</b>
5 mV/div	0.28 mV	0.41 mV	0.44 mV	0.51 mV	0.65 mV	0.84 mV
10 mV/div	0.30 mV	0.42 mV	0.48 mV	0.57 mV	0.70 mV	0.86 mV
20 mV/div	0.54 mV	0.74 mV	0.84 mV	0.99 mV	1.20 mV	1.48 mV
50 mV/div	1.21 mV	1.64 mV	1.86 mV	2.18 mV	2.64 mV	3.21 mV
100 mV/div	2.42 mV	3.25 mV	3.68 mV	4.30 mV	5.16 mV	6.21 mV
200 mV/div	4.84 mV	6.48 mV	7.33 mV	8.53 mV	10.18 mV	12.18 mV
500 mV/div	12.16 mV	16.39 mV	18.64 mV	21.89 mV	26.42 mV	32.06 mV
1 V/div	24.21 mV	32.50 mV	36.80 mV	42.99 mV	51.55 mV	61.98 mV
<b>Vertical - digital channels</b>	<b>On all MSO models</b>					
Input channels	16 digital channels					
Threshold groupings	Two individual threshold settings (1 for channels 0-7 and 1 for channels 8-15)					
Threshold selections	TTL (1.4 V), CMOS (2.5 V), ECL (-1.3 V), PECL (3.7 V), custom ( $\pm 3.75$ V in 10 mV increments)					
Maximum input voltage	$\pm 40$ V peak CAT I					
Threshold accuracy	$\pm (100$ mV + 3% of threshold setting)					
Input dynamic range	$\pm 10$ V about threshold					
Minimum input voltage swing	400 mV peak-to-peak					
Input impedance (flying leads)	100 k $\Omega$ $\pm$ 2% (~8 pF) at probe tip					
Resolution	1 bit					
Analog bandwidth	3 GHz (depends on probing)					

## Infiniium V-Series Performance Characteristics (continued)

### Horizontal

<b>Horizontal - oscilloscope channels</b>			
Main time base range	2 ps/div to 20 s/div real time		
Main time base delay range	0 s ± 200 s real time		
Resolution	1 ps		
Reference position	Left, center, right		
Zoom time base range	1 ps/div to current main time scale setting		
Oscilloscope channel deskew	± 1 ms range, 10 fs resolution		
Time scale accuracy*	± [0.1 ppm (immediately after calibration) ± 0.1 ppm/year (aging)]		
Delta-time measurement accuracy			
Absolute, averaging disabled	$\pm 5 \cdot \sqrt{2 \cdot (\text{Noise}/(\text{Slew Rate}))^2 + (\text{Intrinsic Jitter})^2} + \text{Time Scale Accuracy} \cdot \text{Reading}$ sec peak		
Absolute, ≥ 256 averages	$\pm 0.35 \cdot \sqrt{2 \cdot (\text{Noise}/(\text{Slew Rate}))^2 + (\text{Intrinsic Jitter})^2} + \text{Time Scale Accuracy} \cdot \text{Reading}$ sec peak		
Intrinsic jitter	<b>Acquired time range</b>	<b>Internal timebase reference</b>	<b>External timebase reference</b>
	≤ 1 ms	100 fs rms	100 fs rms
	> 1 ms to ≤ 10 ms	200 fs rms	200 fs rms
	> 10 ms to ≤ 100 ms	500 fs rms	200 fs rms
	> 100 ms to ≤ 1 s	2 ps rms	500 fs rms
Jitter measurement floor			
Time interval error	$\sqrt{(\text{Noise}/(\text{Slew Rate}))^2 + (\text{Intrinsic Jitter})^2}$ sec peak		
Periodic jitter	$\sqrt{2} \cdot \sqrt{(\text{Noise}/(\text{Slew Rate}))^2 + (\text{Intrinsic Jitter})^2}$ sec peak		
Cycle-cycle jitter	$\sqrt{3} \cdot \sqrt{(\text{Noise}/(\text{Slew Rate}))^2 + (\text{Intrinsic Jitter})^2}$ sec peak		

\* Denotes warranted specifications, all others are typical. Specifications are valid after 30-minute warm up period and ± 5% from oscilloscope firmware calibration temperature.

## Infiniium V-Series Performance Characteristics (continued)

### Acquisition

Acquisition - oscilloscope channels	V084A	V134A	V164A	V204A	V254A	V334A
Maximum real-time sample rate						
2 channels	80 GSa/s	80 GSa/s	80 GSa/s	80 GSa/s	80 GSa/s	80 GSa/s
4 channels	40 GSa/s	40 GSa/s	40 GSa/s	40 GSa/s	40 GSa/s	40 GSa/s
Memory depth per channel	<b>4 channels</b>			<b>2 channels</b>		
Standard	50 Mpts			100 Mpts		
Option 100 (standard on DSA model)	100 Mpts			200 Mpts		
Option 200	200 Mpts			500 Mpts		
Option 500	500 Mpts			1 Gpts		
Option 01G	1 Gpts			1 Gpts		
Option 02G	2 Gpts			2 Gpts		
Maximum acquired time at highest real-time resolution	<b>40 GSa/s</b>			<b>80 GSa/s</b>		
Standard	1.25 ms			1.25 ms		
Option 100 (standard on DSA model)	2.5 ms			2.5 ms		
Option 200	5 ms			5 ms		
Option 500	12.5 ms			12.5 ms		
Option 01G	25 ms			12.5 ms		
Option 02G	50 ms			25 ms		
Maximum waveform update rate	> 400,000 waveforms per second (when in segmented memory mode)					

### Sampling modes - oscilloscope channels

Real-time	Successive single shot acquisitions
Real-time with averaging	Averages are selectable from 2 to 65,534
Real-time with peak detect	80 GSa/s in 2-channel mode, 40 GSa/s in 4-channel mode
Real-time with hi-resolution	Real-time boxcar averaging reduces random noise and increases resolution
Gaussian magnitude, linear phase	Slow filter roll off while maintaining linear phase
Roll mode	Scrolls sequential waveform points across the display in a right-to-left rolling motion. Works at sample rates up to 10 MSa/s with a maximum record length of 40 Mpts
Segmented memory	Captures bursting signals at maximum sample rate without consuming memory during periods of inactivity. Number of segments (up to 524,288 with Option 02G) Maximum time between triggers is 562,950 seconds Re-arm time: 2.5 $\mu$ s Maximum memory depth (up to 4 Gpts in 2-channel mode with Option 02G)
Filters - Sin(x)/x interpolation	On/off selectable FIR digital filter. Digital signal process adds points between acquired data points to enhance measurement accuracy and waveform display

### Acquisition - digital channels

Maximum real-time sample rate	10 GSa/s with 16 channels, 20 GSa/s with 8 channels
Maximum memory depth per channel	Up to 1 Gpts
Minimum width glitch detection	50 ps

## Infiniium V-Series Performance Characteristics (continued)

### Trigger

<b>Trigger - oscilloscope channels</b>	
Trigger sources	Channel 1, channel 2, channel 3, channel 4, and aux
Sensitivity	Internal low: 2.0 div p-p for 0 to 22 GHz Internal high: 0.3 div p-p for 0 to 18 GHz, 1.0 div p-p for > 18 to 22 GHz Auxiliary: 2.5 GHz
Edge trigger bandwidth	> 20 GHz
Minimum pulse width trigger	
Hardware	250 ps
Software (InfiniiScan)	40 ps
Level range	
Internal	$\pm 4$ div from center screen or $\pm 4$ V, whichever is smaller
Auxiliary	$\pm 5$ V, also limit input signal to $\pm 5$ V
Sweep modes	Auto (continuous), triggered, single, segmented
Display jitter (with jitter-free on)	< 100 fs rms
Trigger holdoff range	100 ns to 10 s
Trigger qualification (and qualifier)	Single and multiple channels may be logically qualified with any other trigger mode
Trigger actions	Specify an action to occur (and the frequency of the action) when a trigger conditions occurs. Actions include email on trigger and execute "multipurpose" user setting
Trigger sequences	Three stage trigger sequences including two-stage hardware (find event (A) and trigger event (B)) and one-stage InfiniiScan software trigger. Supports all hardware trigger modes except "edge then edge" and "video" and "Gbit serial." Supports "delay (by time)" and "reset (by time or event)" between two hardware sequences. The minimum latency between "find event (A)" and "trigger event (B)" is 3 ns
<b>Trigger - digital channels MSO models</b>	
Threshold range (user defined)	$\pm 3.75$ V in 10 mV increments
Threshold accuracy	$\pm (100\text{mV} + 3\%$ of threshold setting)
Protocol triggering	All MSO models come standard with protocol trigger for DDR, LPDDR, DDR2, LPDDR2, DDR3, LPDDR3, DDR4 and LPDDR4



## Infiniium V-Series Performance Characteristics (continued)

### Trigger (continued)

Trigger mode - hardware	
Edge (analog and digital)	Triggers on a specified slope (rising, falling or alternating between rising and falling) and voltage level on any channel or auxiliary trigger
Edge transition (analog)	Triggers on rising and falling edges that cross two voltage levels in > or < the amount of time specified. Edge transition setting from 250 ps
Edge then edge (time) (analog and digital)	The trigger is qualified by an edge. After a specified time delay between 10 ns to 10 s, a rising or falling edge on any one selected input will generate the trigger
Edge then edge (event) (analog and digital)	The trigger is qualified by an edge. After a specified delay between 1 to 16,000,000 rising or falling edges, another rising or falling edge on any one selected input will generate the trigger
Glitch (analog and digital)	Trigger on glitches narrower than the other pulses in your waveform by specifying a width less than your narrowest pulse and a polarity. Trigger on glitches as narrow as 125 ps (analog only). Glitch range settings from 250 ps to 10 s
Pulse width (analog and digital)	Triggers on a pulse width that is wider or narrower than the other pulses in your waveform by specifying a pulse width and a polarity. Trigger on pulse widths as narrow as 125 ps (analog only). Pulse width range settings from 250 ps to 10 s. Trigger point can be "end of pulse" to "time out"
Runt (analog)	Triggers on a pulse that crosses one threshold but fails to cross a second threshold before crossing the first again. Can be time qualified with minimum setting of 250 ps
Timeout (analog and digital)	Triggers when a channel stays high, low or unchanged for too long. Timeout settings from 250 ps to 10 s
Pattern (analog and digital)	Triggers when a specified logical combination of the channels is entered, existed or present for a specified period of time or is within a specified time range or times out. Each channel can have a value of high (H), low (L) or don't care (X)
State (analog and digital)	Pattern trigger clocked by rising, falling or alternating between rising and falling edge of one channel
Setup and hold (analog)	Trigger on setup, hold or setup and hold violations in your circuit. Requires a clock and data signal on any two inputs (except aux or line) channels as trigger sources. Setup and/or hold time must then be specified
Window (analog)	Triggers on an event associated with a window defined by two-user adjustable thresholds. Event can be window "entered," "exited," "inside (time qualified)" or "outside (time qualified)" voltage range. Trigger point can be "cross window boundary" or "time out." Time qualify range from 250 ps to 10 s
Gbit serial (analog) <sup>1</sup>	Triggers on bit patterns at rates from 480 Mb/s to 12.5 Gb/s Generic mode - Trigger up to 160-bit sequence of arbitrary NRZ data (high, low, don't care) 8b/10b mode - Trigger up to 10 "K" and "D" code symbols. Alignment character is K28.5 (either disparity) PRBS errors mode - Count accumulated bits and errors, and trigger bit error for PRBS 7, 15, 23 and 31
Video (analog)	Triggers from negative sync composite video, field 1, field 2 or alternating fields for interlaced systems, any field, specified line or any line for interlaced or non-interlaced systems. Support NTSC, PAL-M (525/60), PAL, SECAM (625/50), EDTV (480p/60), EDTV (576p/50), HDTV (720p/60), HDTV (720p/50), HDTV (1080i/60), HDTV (1080i/50), HDTV (1080p/60), HDTV (1080p/50), HDTV (1080p/30), HDTV (1080p/25), HDTV (1080p/24) and user-defined formats

1. Models with hardware serial trigger option.

## Infiniium V-Series Performance Characteristics (continued)

### Trigger (continued)

#### Trigger mode - software

##### InfiniiScan event identification software

Zone qualify	Software triggers on the user-defined zones on screen. Zones can be specified as either “must intersect” or “must not intersect.” Up to eight zones can be defined across multiple channels
Generic serial	Software triggers on NRZ-encoded data up to 80-bit pattern. Support multiple clock data recovery methods including constant frequency, 1st-order PLL, 2nd-order PLL, explicit clock, explicit 1st-order PLL, explicit 2nd-order PLL, Fibre Channel, FlexRay receiver, FlexRay transmitter (requires E2688A except for the constant frequency clock data recovery mode)
Measurement limit	Software triggers on the results of the measurement values. For example, when the “pulse width” measurement is turned on, InfiniiScan measurement software triggers on a glitch as narrow as 40 ps. When the “time interval error (TIE)” is measured, InfiniiScan can trigger on a specific TIE value
Non-monotonic edge	Software triggers on the non-monotonic edge. The non-monotonic edge is specified by setting a hysteresis value
Runt	Software triggers on a pulse that crosses one threshold but fails to cross a second threshold before crossing the first again. Unlike hardware runt trigger, InfiniiScan runt trigger can be further qualified via a hysteresis value
Protocol	Require specified protocol option (I <sup>2</sup> C, SPI, CAN, LIN, RS-232/UART, SVID, USB, PCIe, SATA, SAS, MIPI, Ethernet, 10G-KR, DVI/HDMI, XAUI and generic 8b/10b)

## Infiniium V-Series Performance Characteristics (continued)

### Measurements and math

Oscilloscope measurements	
Number of measurements	20 simultaneous measurements (can be made on either main, zoom or gated region)
Measurement update rate	> 50,000 measurement/sec (one measurement turned on) > 250,000 measurement/sec (10 measurements turned on)
Measurement access	
Drop down measurement list	Measurement menu access to all measurements
Multipurpose	Front panel button activates up to 10 pre-selected or up to 10 user-defined measurements
Drag-and-drop measurement toolbar	Measurement toolbar with common measurement icons that can be dragged and dropped onto the displayed waveforms
Measurement modes	
Statistics	Displays the current, mean, minimum, maximum, range (max-min), standard deviation, count, edge, direction, meas window, icon x and icon y
Histograms	
Source	Waveform or measurement
Orientation	Vertical (for timing and jitter measurements) or horizontal (noise and amplitude change) modes, regions are defined using waveform markers
Measurements	Mean, standard deviation, mean $\pm$ 1, 2, and 3 sigma, median, mode, peak-to-peak, min, max, total hits, peak (area of most hits), X scale hits and X offset hits
Marker modes	Manual markers, track waveform data, track measurements and delta marker values can be displayed
Waveform measurements	
Voltage (analog)	Peak-to-peak, minimum, maximum, average, RMS, amplitude, base, top, overshoot, preshoot, V overshoot, V preshoot, upper, middle, lower, crossing point voltage, pulse top, pulse base, pulse amplitude
Time (analog)	Rise time, fall time, period, frequency, positive width, negative width, duty cycle, Tmin, Tmax, Tvolt, channel-to-channel delta time, channel-to-channel phase, count pulses, burst width, burst period, burst interval, setup time, hold time, edge-edge, edge time, slew rate
Time (digital)	Period, frequency, positive width, negative width, duty cycle, delta time
Clock (analog)	Period, frequency, duty cycle, clock, phase, TIE <sup>1</sup> , N-period <sup>1</sup> , period-period <sup>1</sup> , + width to + width <sup>1</sup> , - width to - width <sup>1</sup> , duty cycle to duty cycle
Data (analog)	Setup time, hold time, time interval error <sup>1</sup> , unit interval, noise, N-UI, UI-UI, data rate, clock recovery rate, DDPWS, de-emphasis
Mixed (analog)	Area, slew rate
Frequency domain (analog)	FFT frequency, FFT magnitude, FFT delta frequency, FFT delta magnitude, peak detect mode, amplitude modulation
Eye (analog)	Eye height, eye width, eye jitter, crossing %, Q factor, duty cycle distortion
Level qualification	Any channels that are not involved in a measurement can be used to level-qualify all timing measurements

1. Requires EZJIT Plus (Option N5400A) or EZJIT Complete (Option N8823A) software.

## Infiniium V-Series Performance Characteristics (continued)

### Measurements and math (continued)

Oscilloscope measurements	
Eye-diagram measurements <sup>1</sup>	Eye height, eye width, eye jitter, crossing percentage, Q factor and duty-cycle distortion
Jitter analysis measurements <sup>2</sup>	
Clock	Time interval error, N-period, period to period, + width to + width, - width to - width, and duty cycle to duty cycle
Data	Random Jitter (RJ), Deterministic Jitter (DJ), Aperiodic Bounded Uncorrelated Jitter (ABUJ), Periodic Jitter (PJ), Data Dependent Jitter (DDJ), Duty Cycle Distortion (DCD), Intersymbol Interference (ISI)
Jitter separation	Spectral method (RJ narrow and wide), tailfit
RJ setting	Ability to fix random jitter (RJ) for crosstalk measurements
Mask testing	Allows pass/fail testing to user-defined or Keysight-supplied waveform templates. Automask lets you create a mask template from a captured waveform and define a tolerance range in time/voltage or screen divisions. Test modes (run until) include test forever, test to specified time or event limit, and stop on failure. Executes "multipurpose" user setting on failure. "Unfold real-time eye" feature will allow individual bit errors to be observed by unfolding a real-time eye when clock recovery is on. Communications mask test kit option provides a set of ITU-T G.703, ANSI T1.102 and IEEE 802.3 industry-standard masks for compliance testing
Math functions	
Waveform math	
Number of functions	Up to 16 independent functions
Number of gating functions	Up to 16 horizontal measurement gates (any function can be used as a gate)
Math source	Any combination of channels, memories or other functions
Hardware accelerated math	Differential and common mode (analog)
Operators	Absolute value, add, AM demodulation, average, Butterworth <sup>1</sup> , common mode, delay, differentiate, divide, envelope, FFT magnitude, FFT phase, FIR <sup>1</sup> , gating, high pass filter, histogram, integrate, invert, LFE <sup>1</sup> , low pass filter (4th-order Bessel Thompson filter), magnify, max, meas trend, min, multiply, RT Eye <sup>1</sup> , smoothing, SqrtSumOfSquare <sup>1</sup> , square, square root, subtract, versus, chart (MSO models) and user-defined function <sup>3,4</sup>
FFT	
Frequency range	DC to 40 GHz (at 80 GSa/s) or 20 GHz (at 40 GSa/s)
Frequency resolution	Resolution = sample rate/memory depth
Window modes	Hanning, flattop, rectangular, Blackman-Harris, Hamming
Number of FFTs	Display up to 16 FFTs, each in their own grid with up to eight in their own waveform area
Peak mode	Choose peak callouts to display peak values on the screen

1. Requires Serial Data Analysis (Option E2688A) software.

2. Requires EZJIT Plus (Option N5400A) or EZJIT Complete (Option N8823A) software.

3. Requires MATLAB (Option N8831A) software.

4. Requires user-defined function (Option N5430A) software.



## Infiniium V-Series Performance Characteristics (continued)

### Display, computer system, I/O ports and file types

<b>Display</b>	
Display	12.1-inch color XGA TFT-LCD with capacitive touch screen
Intensity grayscale	256-level intensity-graded display
Resolution XGA	1024 pixels horizontally x 768 pixels vertically
Annotation	Up to 100 bookmarks can be inserted into the waveform window. Each can float or be tied to a specific waveform
Grids	Up to 16 waveform grids, each with 8-bit vertical resolution
Waveform windows	Up to eight individual waveform windows, allowing up to 128 viewing spaces
Waveform styles	Connected dots, dots, infinite persistence, variable persistence, color-graded infinite persistence. Includes up to 256 levels of intensity-graded waveforms
<b>Computer system and peripherals</b>	
Operating system	Windows 7 64-bit
CPU	Intel Core i5-3550S quad core CPU at 3.00 GHz
PC system memory	16 GB DDR3 RAM
Storage drive	Standard 500 GB removable SSD (Solid State Drive) Optional 1 TB removable SSD (Option 801)
Peripherals	Optical USB mouse and compact keyboard supplied. All Infiniium models support any Windows-compatible input device with a USB interface
LXI compliance	LXI class C

## Infiniium V-Series Performance Characteristics (continued)

### Display, computer system, I/O ports and file types (continued)

I/O ports	
Ethernet (LAN)	RJ-45 connector, supports 10Base-T, 100Base-T, and 1000Base-T. Enables Web-enabled remote control, email on trigger, data/file transfers and network printing
USB	8 total ports Front panel: Two USB 3.0 host ports and one USB 2.0 host port Back panel: Two USB 3.0 host ports, one USB 3.0 device port and two USB 2.0 ports USB 3.0 port supports up to 200 MB/s data offload
External display	Two ports: One DisplayPort and one VGA video out Drivers support up to two simultaneous displays
GPIB	IEEE-488 digital communication bus for instrument control
Oscilloscope ports	
Auxiliary out	100 MHz, square wave, PRBS 2 <sup>7</sup> -1, PRBS 2 <sup>15</sup> -1, PRBS 2 <sup>23</sup> -1 and PRBS 2 <sup>31</sup> -1
Calibration out	DC ( $\pm 2.4$ V), 100 MHz, square wave, PRBS 2 <sup>7</sup> -1, PRBS 2 <sup>15</sup> -1, PRBS 2 <sup>23</sup> -1 and PRBS 2 <sup>31</sup> -1
Trigger out	Peak-to-peak amplitude into 50 $\Omega$ : 2.4 V, offset: 0 V
Time base reference output	Peak-to-peak amplitude into 50 $\Omega$ : 750 mV, offset: 0 V when derived from the internal reference Signal amplitude follows reference input when derived from external reference
Time base external reference input (impedance into 50 $\Omega$ )	Amplitude: 178 mV peak to 1 V peak Frequency: 10 MHz $\pm 5$ ppm high-quality sine wave or square wave
Auxiliary trigger in	External trigger input
Digital channels connector <sup>1</sup>	Digital channel inputs
Pattern generator <sup>2</sup>	Demo pattern output from the hardware serial trigger Peak-to-peak amplitude into 50 $\Omega$ : 400 mV, offset: 400 mV
Reference clock in <sup>2</sup>	External clock reference input to the hardware serial trigger Peak-to-peak amplitude: 0.8 V - 3.6 V. Voltage range: -0.1 V to 3.7 V Clock rise and fall time (10 - 90%): 1 ns or faster
Recovered clock out <sup>2</sup>	Sub-rate clock output generated by the hardware serial trigger Peak-to-peak amplitude into 50 $\Omega$ : 1 V, offset: 0 V
File types	
Analog waveform	Compressed internal format (*.wfm (200 Mpts)) Comma-separated values (*.csv (2 Gpts)) Tab separated values (*.tsv (2 Gpts)) Public binary format (*.bin (500 Mpts)) Y value file (*.txt (2 Gpts)) Hierarchical data file (*.h5 (2 Gpts)) Composite setup and data file (*.osc (2 Gpts))
Digital waveform	Hierarchical data file (*.h5 (2 Gpts)) composite setup and data file (*.osc (2 Gpts))
Images	BMP, PNG, TIFF, GIF or JPEG

1. MSO models only.

2. Models with hardware serial trigger option.

## Infiniium V-Series Performance Characteristics (continued)

### General and environmental

General characteristics	
Temperature	Operating: 5 to +40 °C Non-operating: -40 to +65 °C
Humidity	Operating: up to 95% relative humidity (non-condensing) at +40 °C Non-operating: up to 90% relative humidity at +65 °C
Altitude	Operating: up to 4,000 meters (12,000 feet) Non-operating: up to 15,300 meters (50,000 feet)
Vibration	Operating random vibration 5-500 Hz, 10 minutes per axis, 0.21 g(rms) Non-operating random vibration 5-500 Hz, 10 minutes per axis, 2.0 g(rms); resonant search 5-500 Hz Swept sine, 1 octave/minute sweep rate, (0.50 g), 5 minute resonant dwell at 4 resonances per axis
Power	100 - 240 VAC at 50/60 Hz; input power 800 Watts
Weight	Frame: 52.2 lbs. (23.7 kg); shipping: 71.7 lbs. (32.5 kg)
Dimensions (with feet retracted)	Height: 10.5 in (26.6 cm); width: 17.2 in (43.6 cm); depth: 19.4 in (49.2 cm)
Safety	IEC 61010-1:2010/EN 61010-1 3rd Edition CAN / CSA22.2 No. 61010-1-12 UL Std. 61010-1 (3rd Edition)
Pollution degree	2
Installation category	2
Measurement category	1
Environment	For indoor use only

**myKeysight**

**myKeysight**

[www.keysight.com/find/mykeysight](http://www.keysight.com/find/mykeysight)

A personalized view into the information most relevant to you.



[www.axiestandard.org](http://www.axiestandard.org)

AdvancedTCA® Extensions for Instrumentation and Test (AXIe) is an open standard that extends the AdvancedTCA for general purpose and semiconductor test. Keysight is a founding member of the AXIe consortium. ATCA®, AdvancedTCA®, and the ATCA logo are registered US trademarks of the PCI Industrial Computer Manufacturers Group.



[www.lxistandard.org](http://www.lxistandard.org)

LAN eXtensions for Instruments puts the power of Ethernet and the Web inside your test systems. Keysight is a founding member of the LXI consortium.



[www.pxisa.org](http://www.pxisa.org)

PCI eXtensions for Instrumentation (PXI) modular instrumentation delivers a rugged, PC-based high-performance measurement and automation system.



**Three-Year Warranty**

[www.keysight.com/find/ThreeYearWarranty](http://www.keysight.com/find/ThreeYearWarranty)

Keysight's commitment to superior product quality and lower total cost of ownership. The only test and measurement company with three-year warranty standard on all instruments, worldwide.



**Keysight Assurance Plans**

[www.keysight.com/find/AssurancePlans](http://www.keysight.com/find/AssurancePlans)

Up to five years of protection and no budgetary surprises to ensure your instruments are operating to specification so you can rely on accurate measurements.



[www.keysight.com/go/quality](http://www.keysight.com/go/quality)

Keysight Technologies, Inc.  
DEKRA Certified ISO 9001:2008  
Quality Management System

**Keysight Channel Partners**

[www.keysight.com/find/channelpartners](http://www.keysight.com/find/channelpartners)

Get the best of both worlds: Keysight's measurement expertise and product breadth, combined with channel partner convenience.

[www.keysight.com/find/V-Series](http://www.keysight.com/find/V-Series)

For more information on Keysight Technologies' products, applications or services, please contact your local Keysight office. The complete list is available at: [www.keysight.com/find/contactus](http://www.keysight.com/find/contactus)

**Americas**

Canada	(877) 894 4414
Brazil	55 11 3351 7010
Mexico	001 800 254 2440
United States	(800) 829 4444

**Asia Pacific**

Australia	1 800 629 485
China	800 810 0189
Hong Kong	800 938 693
India	1 800 112 929
Japan	0120 (421) 345
Korea	080 769 0800
Malaysia	1 800 888 848
Singapore	1 800 375 8100
Taiwan	0800 047 866
Other AP Countries	(65) 6375 8100

**Europe & Middle East**

Austria	0800 001122
Belgium	0800 58580
Finland	0800 523252
France	0805 980333
Germany	0800 6270999
Ireland	1800 832700
Israel	1 809 343051
Italy	800 599100
Luxembourg	+32 800 58580
Netherlands	0800 0233200
Russia	8800 5009286
Spain	800 000154
Sweden	0200 882255
Switzerland	0800 805353
	Opt. 1 (DE)
	Opt. 2 (FR)
	Opt. 3 (IT)
United Kingdom	0800 0260637

For other unlisted countries:  
[www.keysight.com/find/contactus](http://www.keysight.com/find/contactus)  
(BP-09-23-14)

