

# Agilent PNA Microwave Network Analyzers

## Data Sheet

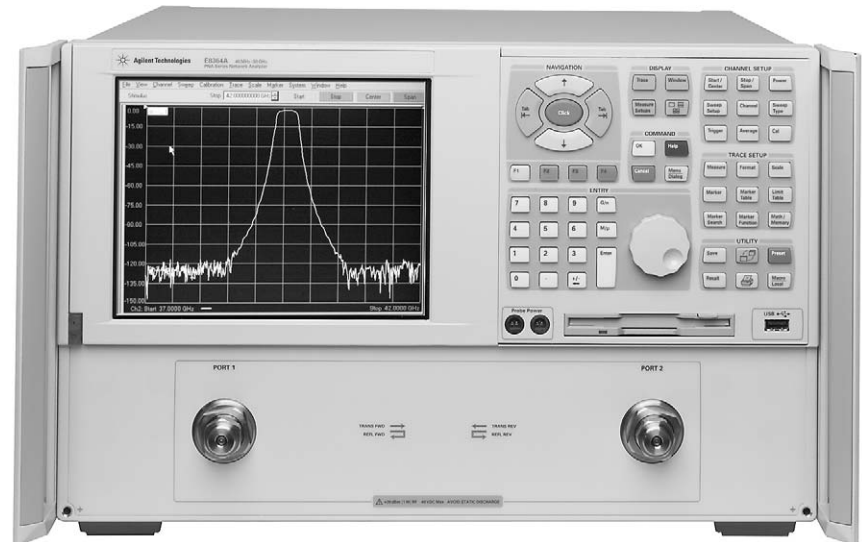

This document describes the performance and features of the Agilent Technologies PNA microwave network analyzers:

**E8362B**      **10 MHz to 20 GHz**

**E8363B**      **10 MHz to 40 GHz**

**E8364B**      **10 MHz to 50 GHz**

**E8361A**      **10 MHz to 67 GHz**

**Note:**

For the complete and most current instrument, calibration kit and connector specifications, refer to the online Help file in the "manuals" library on our web site:  
**<http://na.tm.agilent.com/pna>**



**Agilent Technologies**

## Some Definitions

All specifications and characteristics apply over a 25 °C  $\pm$ 5 °C range (unless otherwise stated) and 90 minutes after the instrument has been turned on.

**Calibration:** The process of measuring known standards to characterize a network analyzer's systematic (repeatable) errors.

**Characteristic (char.):** A performance parameter that the product is expected to meet before it leaves the factory, but that is not verified in the field and is not covered by the product warranty. A characteristic includes the same guardbands as a specification.

**Corrected (residual):** Indicates performance after error correction (calibration). It is determined by the quality of calibration standards and how well "known" they are, plus system repeatability, stability, and noise.

**Nominal (nom.):** A general, descriptive term that does not imply a level of performance. It is not covered by the product warranty.

**Specification (spec.):** Warranted performance. Specifications include guardbands to account for the expected statistical performance distribution, measurement uncertainties, and changes in performance due to environmental conditions.

**Standard:** When referring to the analyzer, this includes no options unless noted otherwise.

**Typical (typ.):** Expected performance of an average unit, which does not include guardbands. It is not covered by the product warranty.

**Uncorrected (raw):** Indicates instrument performance without error correction. The uncorrected performance affects the stability of a calibration.

# Table of Contents

## **E8362/3/4B**

|  |    |
|--|----|
| Corrected system performance .....                           | 4  |
| System dynamic range .....                                   | 4  |
| Receiver dynamic range .....                                 | 6  |
| Corrected system performance<br>with 2.4 mm connectors ..... | 7  |
| Corrected system performance<br>with 3.5 mm connectors ..... | 9  |
| Uncorrected system performance .....                         | 11 |
| Test port output .....                                       | 13 |
| Test port input .....  | 15 |

## **E8361A**

|   |    |
|---|----|
| Corrected system performance .....                            | 20 |
| System dynamic range .....                                    | 20 |
| Corrected system performance<br>with 1.85 mm connectors ..... | 21 |
| Corrected system performance<br>with 2.4 mm connectors .....  | 29 |
| Uncorrected system performance .....                          | 33 |
| Test port output .....  | 36 |
| Test port input .....   | 38 |

## **Microwave PNA Series**

|  |    |
|--|----|
| General information .....  | 47 |
| Measurement throughput summary .....                             | 50 |
| Cycle time vs. IF bandwidth .....                                | 50 |
| Cycle time vs. number of points .....                            | 50 |
| Cycle time .....   | 50 |
| Data transfer time .....   | 51 |
| Frequency Converter Application (Option 083)<br>Cycle Time ..... | 52 |
| Measurement capabilities .....                                   | 53 |
| Source control .....   | 53 |
| Trace functions .....  | 53 |
| Automation .....   | 54 |
| Data accuracy enhancement .....                                  | 55 |
| Storage .....  | 55 |
| System capabilities .....  | 56 |
| PNA Series simplified test set block diagram .....               | 58 |
| Ordering guide for PNA Series<br>Network analyzers .....         | 60 |
| Test port cable specifications .....                             | 61 |
| Information resources .....                                      | 63 |

# E8362/3/4B

## Corrected system performance

The specifications in this section apply for measurements made with the Agilent E8362/3/4B PNA Series microwave network analyzer with the following conditions:

- 10 Hz IF bandwidth
- no averaging applied to data
- isolation calibration with an averaging factor of 8

**Note:** Samples of uncertainty curves are included in this Data Sheet. Please download our free uncertainty calculator ([www.agilent.com/find/na\\_calculator](http://www.agilent.com/find/na_calculator)) to generate the curves for your setup.

## System dynamic range<sup>1</sup>

| Description  | Specification (dB)<br>at test port <sup>2</sup> | Typical (dB) at direct<br>receiver access input <sup>3</sup> | Supplemental information                     |
|--|---|--|--|
| <b>Dynamic range</b>   |   |  |  |
| <b>Standard configuration and standard power range (E8362/3/4B)</b>            |   |  |  |
| 10 to 45 MHz <sup>4</sup>  | 79  | N/A  |  |
| 45 to 500 MHz <sup>5</sup>   | 94  | N/A  |  |
| 500 MHz to 2 GHz   | 119   | N/A  |  |
| 2 to 10 GHz  | 122   | N/A  |  |
| 10 to 20 GHz   | 123   | N/A  |  |
| 20 to 30 GHz   | 114   | N/A  |  |
| 30 to 40 GHz   | 110   | N/A  |  |
| 40 to 45 GHz   | 109   | N/A  |  |
| 45 to 50 GHz   | 104   | N/A  |  |
| <b>Extended configuration and standard power range (E8362/3/4B-Option 014)</b> |   |  |  |
| 10 to 45 MHz <sup>4</sup>  | 79  | 129  |  |
| 45 to 500 MHz <sup>5</sup>   | 94  | 132  |  |
| 500 MHz to 2 GHz   | 119   | 138  |  |
| 2 to 10 GHz  | 122   | 137  |  |
| 10 to 20 GHz   | 121   | 136  |  |
| 20 to 30 GHz   | 111   | 123  | } Option 016 degrades<br>performance by 2 dB |
| 30 to 40 GHz   | 107   | 119  |  |
| 40 to 45 GHz   | 105   | 116  |  |
| 45 to 50 GHz   | 100   | 111  |  |

1. The system dynamic range is calculated as the difference between the noise floor and the source maximum output power. System dynamic range is a specification when the source is set to port 1, and a characteristic when the source is set to port 2. The effective dynamic range must take measurement uncertainties and interfering signals into account.
2. The test port system dynamic range is calculated as the difference between the test port noise floor and the source maximum output power. The effective dynamic range must take measurement uncertainties and interfering signals into account.
3. The direct receiver access input system dynamic range is calculated as the difference between the direct receiver access input noise floor and the source

- maximum output power. The effective dynamic range must take measurement uncertainties and interfering signals into account. This set-up should only be used when the receiver input will never exceed its damage level. When the analyzer is in segment sweep mode, the analyzer can have pre-defined frequency segments which will output a higher power level when the extended dynamic range is required (i.e. devices with high insertion loss), and reduced power when receiver damage may occur (i.e. devices with low insertion loss). The extended range is only available in one-path transmission measurements.
4. Typical performance.
  5. May be limited to 100 dB at particular frequencies below 500 MHz due to spurious receiver residuals. Methods are available to regain the full dynamic range.

# E8362/3/4B

## Corrected system performance *continued*

### System dynamic range<sup>1</sup>

| Description  | Specification (dB)<br>at test port <sup>2</sup> | Typical (dB) at direct<br>receiver access input <sup>3</sup> | Supplemental information                     |
|--|---|--|--|
| <b>Dynamic range</b>   |   |  |  |
| <b>Standard configuration and extended power range and bias-tees (E8362/3/4B-Option UNL)</b>                   |   |  |  |
| 10 to 45 MHz <sup>4</sup>  | 79  | N/A  |  |
| 45 to 500 MHz <sup>5</sup>   | 92  | N/A  |  |
| 500 MHz to 2 GHz   | 117   | N/A  |  |
| 2 to 10 GHz  | 120   | N/A  |  |
| 10 to 20 GHz   | 121   | N/A  |  |
| 20 to 30 GHz   | 112   | N/A  | } Option 016 degrades<br>performance by 2 dB |
| 30 to 40 GHz   | 108   | N/A  |  |
| 40 to 45 GHz   | 105   | N/A  |  |
| 45 to 50 GHz   | 99  | N/A  |  |
| <b>Configurable test set and extended power range and bias-tees<br/>(E8362/3/4B-Option UNL and Option 014)</b> |   |  |  |
| 10 to 45 MHz <sup>4</sup>  | 79  | 129  |  |
| 45 to 500 MHz <sup>5, 6</sup>  | 92  | 130  |  |
| 500 MHz to 2 GHz <sup>6</sup>  | 117   | 136  |  |
| 2 to 10 GHz <sup>6</sup>   | 120   | 135  |  |
| 10 to 20 GHz <sup>7</sup>  | 119   | 134  |  |
| 20 to 30 GHz   | 109   | 121  | } Option 016 degrades<br>performance by 2 dB |
| 30 to 40 GHz   | 105   | 117  |  |
| 40 to 45 GHz   | 101   | 112  |  |
| 45 to 50 GHz   | 95  | 106  |  |

1. The system dynamic range is calculated as the difference between the noise floor and the source maximum output power. System dynamic range is a specification when the source is set to port 1, and a characteristic when the source is set to port 2. The effective dynamic range must take measurement uncertainties and interfering signals into account.
2. The test port system dynamic range is calculated as the difference between the test port noise floor and the source maximum output power. The effective dynamic range must take measurement uncertainties and interfering signals into account.
3. The direct receiver access input system dynamic range is calculated as the difference between the direct receiver access input noise floor and the source maximum output power. The effective dynamic range must take measurement uncertainties and interfering signals into account. This set-up should only be used

when the receiver input will never exceed its damage level. When the analyzer is in segment sweep mode, the analyzer can have pre-defined frequency segments which will output a higher power level when the extended dynamic range is required (i.e. devices with high insertion loss), and reduced power when receiver damage may occur (i.e. devices with low insertion loss). The extended range is only available in one-path transmission measurements.

4. Typical performance.
5. May be limited to 100 dB at particular frequencies below 500 MHz due to spurious receiver residuals. Methods are available to regain the full dynamic range.
6. E8362B only: Option H11 decreases value by 1 dB.
7. E8362B only: Option H11 decreases value by 2 dB.

# E8362/3/4B

## Receiver dynamic range<sup>1</sup>

| Description  | Specification (dB)<br>at test port <sup>2</sup> | Typical (dB) at direct<br>receiver access input <sup>3</sup> | Supplemental information                |
|--|---|--|---|
| <b>Dynamic range</b>   |   |  |   |
| <b>Standard configuration and standard power range (E8362/3/4B) or standard configuration and extended power range and bias-tees (E8362/3/4B-Option UNL)</b>                         |   |  |   |
| 10 to 45 MHz <sup>4</sup>  | 82  | N/A  |   |
| 45 to 500 MHz <sup>5</sup>   | 94  | N/A  |   |
| 500 MHz to 2 GHz   | 119   | N/A  |   |
| 2 to 10 GHz  | 122   | N/A  |   |
| 10 to 20 GHz   | 125   | N/A  |   |
| 20 to 30 GHz   | 114   | N/A  | Option 016 degrades performance by 2 dB |
| 30 to 40 GHz   | 111   | N/A  | Option 016 degrades performance by 2 dB |
| 40 to 50 GHz   | 111   | N/A  | Option 016 degrades performance by 2 dB |
| <b>Configurable test set and standard power range (E8362/3/4B Option 014) or configurable test set and extended power range and bias-tees (E8362/3/4B-Option 014 and Option UNL)</b> |   |  |   |
| 10 to 45 MHz <sup>4</sup>  | 82  | 132  |   |
| 45 to 500 MHz <sup>5</sup>   | 94  | 132  |   |
| 500 MHz to 2 GHz   | 119   | 138  |   |
| 2 to 10 GHz  | 122   | 137  |   |
| 10 to 20 GHz   | 124   | 139  |   |
| 20 to 40 GHz   | 113   | 125  | Option 016 degrades performance by 2 dB |
| 40 to 45 GHz   | 110   | 122  | Option 016 degrades performance by 2 dB |
| 45 to 50 GHz   | 109   | 120  | Option 016 degrades performance by 2 dB |

1. The receiver dynamic range is calculated as the difference between the noise floor and the receiver maximum input level. The effective dynamic range must take measurement uncertainties and interfering signals into account.
2. The test port receiver dynamic range is calculated as the difference between the test port noise floor and the receiver maximum input level. The effective dynamic range must take measurement uncertainties and interfering signals into account.
3. The direct receiver access input receiver dynamic range is calculated as the difference between the direct receiver access input noise floor and the receiver maximum input level. The effective dynamic range must take measurement uncertainties and interfering signals into account. This set-up should only be used

when the receiver input will never exceed its compression or damage level. When the analyzer is in segment sweep mode, the analyzer can have pre-defined frequency segments which will output a higher power level when the extended dynamic range is required (i.e. devices with high insertion loss), and reduced power when compression or receiver damage may occur (i.e. devices with low insertion loss). The extended range is only available in one-path transmission measurements.

4. Typical performance.
5. May be degraded by 10 dB at particular frequencies (multiples of 5 MHz) below 500 MHz due to spurious receiver residuals. Methods are available to regain the full dynamic range.

# E8362/3/4B

## Corrected system performance with 2.4 mm connectors

### Standard configuration and standard power range (E8363/4B)

Applies to E8363/4B PNA Series analyzer, 85056A (2.4 mm) calibration kit, 85133F flexible test port cable set, and a full two-port calibration. (Specifications apply over environmental temperature of  $23\text{ }^{\circ}\text{C} \pm 3\text{ }^{\circ}\text{C}$ , with less than  $1\text{ }^{\circ}\text{C}$  deviation from calibration temperature.)

| Description           | Specification (dB)                   |                                      |                                      |                                      |
|-----------------------|--------------------------------------|--------------------------------------|--------------------------------------|--------------------------------------|
|                       | 45 MHz to 2 GHz                      | 2 to 20 GHz                          | 20 to 40 GHz                         | 40 to 50 GHz                         |
| Directivity           | 42                                   | 42                                   | 38                                   | 36                                   |
| Source match          | 41                                   | 38                                   | 33                                   | 31                                   |
| Load match            | 42                                   | 42                                   | 37                                   | 35                                   |
| Reflection tracking   | $\pm 0.001 (+0.02/^{\circ}\text{C})$ | $\pm 0.008 (+0.02/^{\circ}\text{C})$ | $\pm 0.020 (+0.02/^{\circ}\text{C})$ | $\pm 0.027 (+0.03/^{\circ}\text{C})$ |
| Transmission tracking | $\pm 0.01 (+0.02/^{\circ}\text{C})$  | $\pm 0.049 (+0.02/^{\circ}\text{C})$ | $\pm 0.105 (+0.02/^{\circ}\text{C})$ | $\pm 0.17 (+0.03/^{\circ}\text{C})$  |

### Transmission uncertainty (specifications)

#### Magnitude

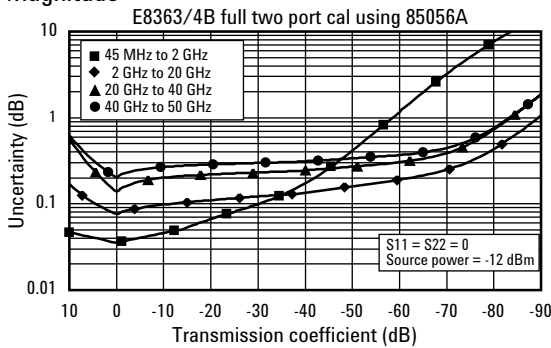

#### Phase

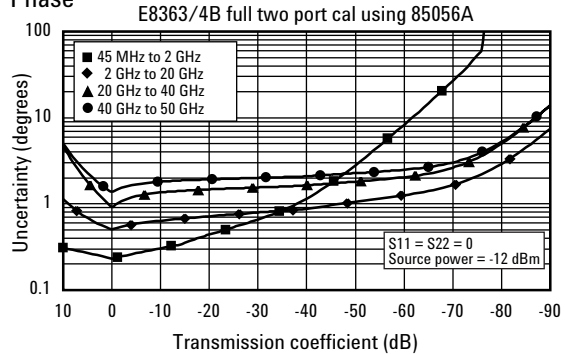

### Reflection uncertainty (specifications)

#### Magnitude

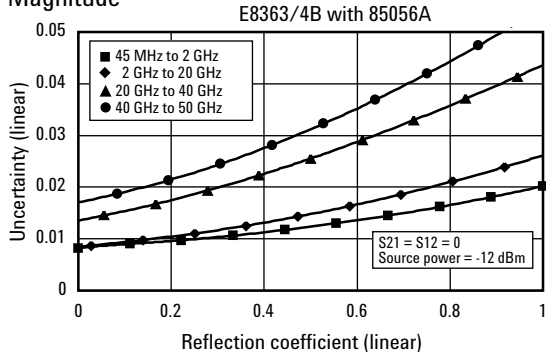

#### Phase

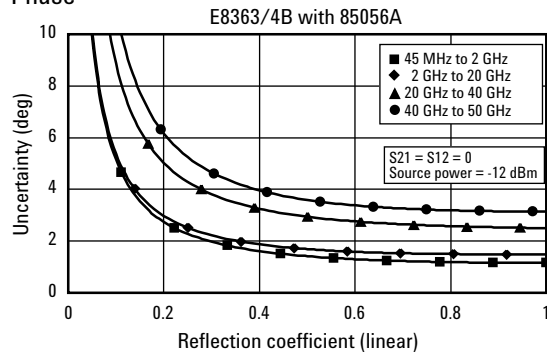

1. Typical performance.

# E8362/3/4B

## Corrected system performance with 2.4 mm connectors *continued*

### Fully Optioned (E8363/4B-Option 014/UNL/080/081/016)

Applies to E8363/4B PNA Series analyzer, 85056A (2.4 mm) calibration kit, 85133F flexible test port cable set, and a full two-port calibration. (Specifications apply over environmental temperature of 23 °C ±3 °C, with less than 1 °C deviation from calibration temperature.)

| Description           | Specification (dB) |                   |                   |                   |
|-----------------------|--------------------|-------------------|-------------------|-------------------|
|                       | 45 MHz to 2 GHz    | 2 to 20 GHz       | 20 to 40 GHz      | 40 to 50 GHz      |
| Directivity           | 42                 | 42                | 38                | 36                |
| Source match          | 41                 | 38                | 33                | 31                |
| Load match            | 42                 | 42                | 37                | 35                |
| Reflection tracking   | ±0.001 (+0.02/°C)  | ±0.008 (+0.02/°C) | ±0.020 (+0.02/°C) | ±0.027 (+0.03/°C) |
| Transmission tracking | ±0.019 (+0.02/°C)  | ±0.053 (+0.02/°C) | ±0.109 (+0.02/°C) | ±0.182 (+0.03/°C) |

### Transmission uncertainty (specifications)

#### Magnitude

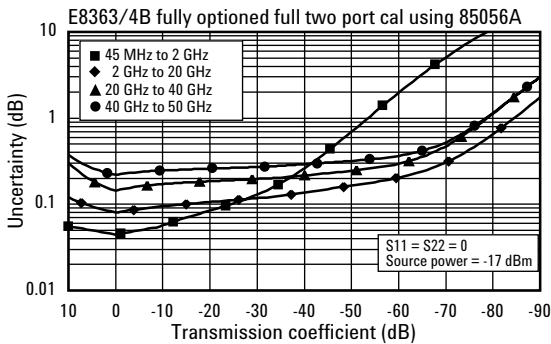

#### Phase

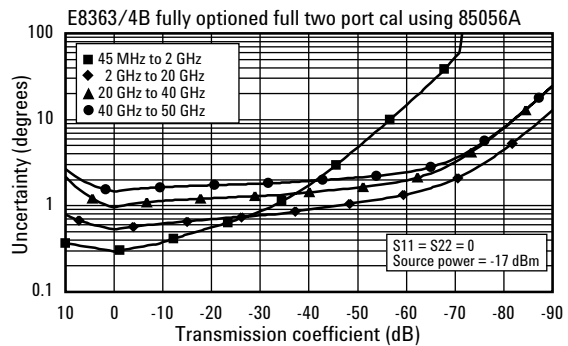

### Reflection uncertainty (specifications)

#### Magnitude

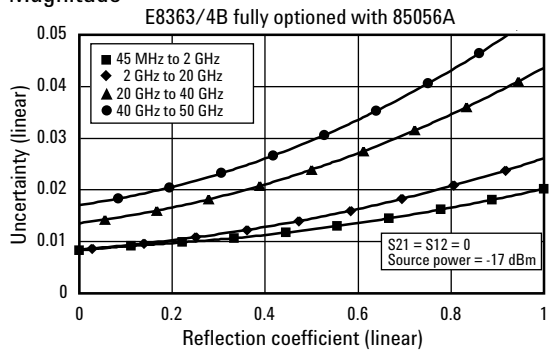

#### Phase

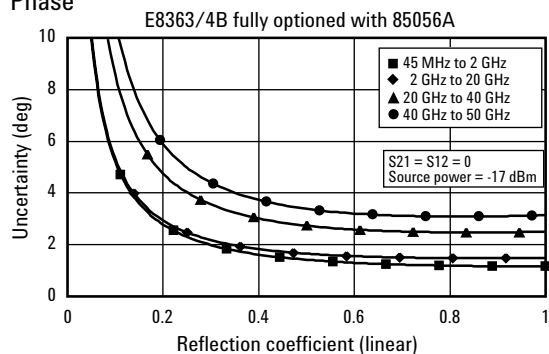

1. Typical performance.



# E8362/3/4B

## Corrected system performance with 3.5 mm connectors

### Standard configuration and standard power range (E8362B)

Applies to E8362B PNA Series analyzer, 85052B (3.5 mm) calibration kit, 85131F flexible test port cable set, and a full two-port calibration. (Specifications apply over environmental temperature of 23 °C ±3 °C, with less than 1 °C deviation from calibration temperature.)

| Description           | Specification (dB) |                   |                   |
|-----------------------|--------------------|-------------------|-------------------|
|                       | 45 MHz to 2 GHz    | 2 to 20 GHz       | 2 to 26.5 GHz     |
| Directivity           | 48                 | 44                | 44                |
| Source match          | 40                 | 31                | 31                |
| Load match            | 48                 | 44                | 44                |
| Reflection tracking   | ±0.003 (+0.02/°C)  | ±0.006 (+0.02/°C) | ±0.006 (+0.03/°C) |
| Transmission tracking | ±0.009 (+0.02/°C)  | ±0.088 (+0.02/°C) | ±0.104 (+0.03/°C) |

### Transmission uncertainty (specifications)

#### Magnitude

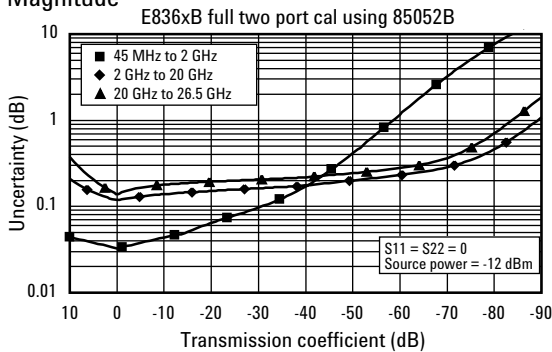

#### Phase

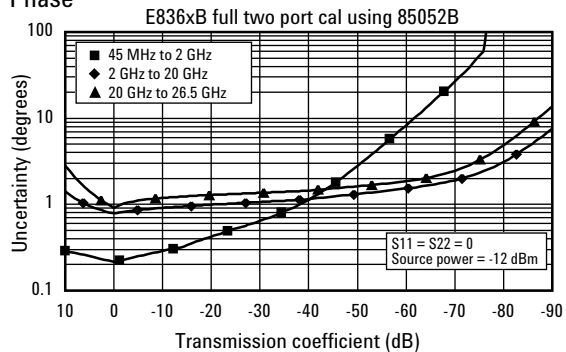

### Reflection uncertainty (specifications)

#### Magnitude

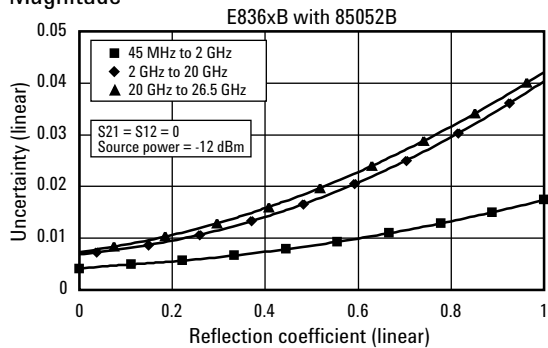

#### Phase

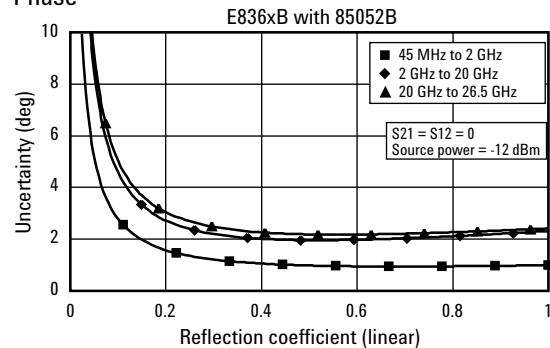

1. Typical performance.

# E8362/3/4B

## Corrected system performance with 3.5 mm connectors *continued*

### Fully Optioned (E8362B-Option 014/UNL/080/081/016)

Applies to E8362B PNA Series analyzer, 85052B (3.5 mm) calibration kit, 85131F flexible test port cable set, and a full two-port calibration. (Specifications apply over environmental temperature of 23 °C ±3 °C, with less than 1 °C deviation from calibration temperature.)

| Description           | Specification (dB) |                   |                   |
|-----------------------|--------------------|-------------------|-------------------|
|                       | 45 MHz to 2 GHz    | 2 to 20 GHz       | 20 to 26.5 GHz    |
| Directivity           | 48                 | 44                | 44                |
| Source match          | 40                 | 31                | 31                |
| Load match            | 48                 | 44                | 44                |
| Reflection tracking   | ±0.003 (+0.02/°C)  | ±0.006 (+0.02/°C) | ±0.006 (+0.03/°C) |
| Transmission tracking | ±0.017 (+0.02/°C)  | ±0.091 (+0.02/°C) | ±0.106 (+0.03/°C) |

### Transmission uncertainty (specifications)

#### Magnitude

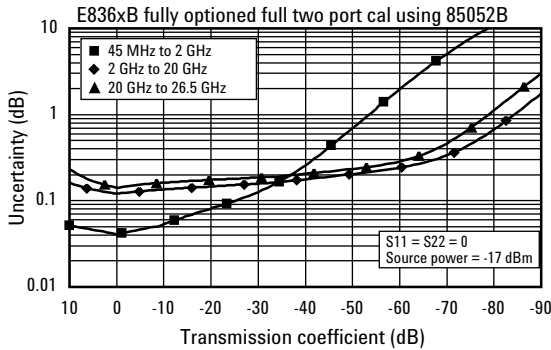

#### Phase

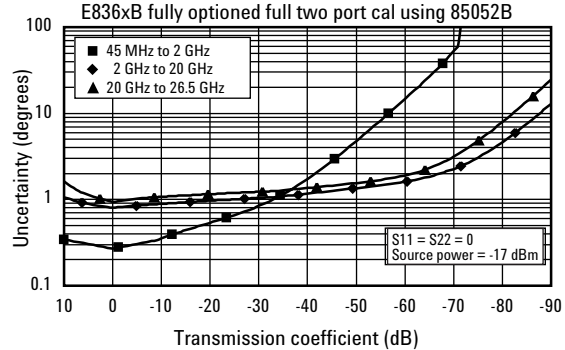

### Reflection uncertainty (specifications)

#### Magnitude

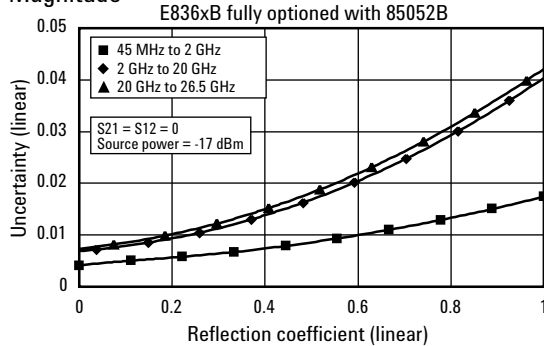

#### Phase

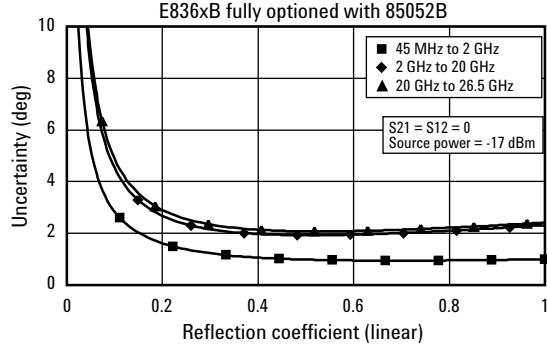

1. Typical performance.

# E8362/3/4B

## Uncorrected system performance<sup>1</sup>

| Description   | Specification | Supplemental information |
|---|---------------|--------------------------|
| <b>Directivity</b>                                    |               | Typical:                 |
| 10 to 45 MHz <sup>2</sup>                             | 23 dB         | 23 dB                    |
| 45 MHz to 2 GHz                                       | 24 dB         | 29 dB                    |
| 2 to 10 GHz   | 22 dB         | 25 dB                    |
| 10 to 20 GHz  | 16 dB         | 20 dB                    |
| 20 to 40 GHz  | 16 dB         | 20 dB                    |
| 40 to 45 GHz  | 15 dB         | 18 dB                    |
| 45 to 50 GHz  | 13 dB         | 18 dB                    |
| <b>Source match - standard</b>                        |               | Typical:                 |
| 10 to 45 MHz <sup>2</sup>                             | 11 dB         | 12 dB                    |
| 45 MHz to 2 GHz                                       | 23 dB         | 27 dB                    |
| 2 to 10 GHz   | 16 dB         | 19 dB                    |
| 10 to 20 GHz  | 14 dB         | 19 dB                    |
| 20 to 40 GHz  | 10 dB         | 14 dB                    |
| 40 to 45 GHz  | 9 dB          | 13.5 dB                  |
| 45 to 50 GHz  | 7.5 dB        | 10 dB                    |
| <b>Source match - Option UNL, 014, or UNL and 014</b> |               | Typical:                 |
| 10 to 45 MHz <sup>2</sup>                             | 11 dB         | 12 dB                    |
| 45 MHz to 2 GHz                                       | 18 dB         | 22.5 dB                  |
| 2 to 10 GHz   | 14 dB         | 18 dB                    |
| 10 to 20 GHz  | 12 dB         | 15 dB                    |
| 20 to 40 GHz  | 9 dB          | 11 dB                    |
| 40 to 45 GHz  | 8 dB          | 13 dB                    |
| 45 to 50 GHz  | 6 dB          | 9 dB                     |
| <b>Load match - standard</b>                          |               | Typical:                 |
| 10 to 45 MHz <sup>2</sup>                             | 11 dB         | 12 dB                    |
| 45 MHz to 2 GHz                                       | 23 dB         | 29 dB                    |
| 2 to 10 GHz   | 14 dB         | 16 dB                    |
| 10 to 20 GHz  | 10 dB         | 12 dB                    |
| 20 GHz to 40 GHz                                      | 9 dB          | 12 dB                    |
| 40 to 45 GHz  | 9 dB          | 13 dB                    |
| 45 to 50 GHz  | 8 dB          | 10 dB                    |
| <b>Load match - Option UNL, 014, or UNL and 014</b>   |               | Typical:                 |
| 10 to 45 MHz <sup>2</sup>                             | 11 dB         | 12 dB                    |
| 45 MHz to 2 GHz                                       | 17 dB         | 21.5 dB                  |
| 2 to 10 GHz   | 13 dB         | 16.5 dB                  |
| 10 to 20 GHz  | 10 dB         | 13 dB                    |
| 20 to 40 GHz  | 9 dB          | 11 dB                    |
| 40 to 45 GHz  | 9 dB          | 13 dB                    |
| 45 to 50 GHz  | 7 dB          | 9.5 dB                   |
| <b>Reflection tracking</b>                            |               | Typical:                 |
| 10 to 45 MHz <sup>2</sup>                             |               | ±1.5 dB                  |
| 45 MHz to 20 GHz                                      |               | ±1.5 dB                  |
| 20 to 40 GHz  |               | ±1.5 dB                  |
| 40 to 50 GHz  |               | ±2.0 dB                  |
| <b>Transmission tracking<sup>3</sup></b>              |               | Typical:                 |
| 10 to 45 MHz <sup>2</sup>                             |               | ±3.0 dB                  |
| 45 MHz to 2 GHz                                       |               | ±1.5 dB                  |
| 2 to 10 GHz   |               | ±2.0 dB                  |
| 10 to 20 GHz  |               | ±2.5 dB                  |
| 20 to 40 GHz  |               | ±3.5 dB                  |
| 40 to 45 GHz  |               | ±4.0 dB                  |
| 45 to 50 GHz  |               | ±4.5 dB                  |

1. Specifications apply over environment temperature of 23 °C ±3 °C, with less than 1 °C deviation from the calibration temperature.

2. Typical performance.

3. Transmission tracking performance is strongly dependent on cable used. These typical specifications are based on the use of an Agilent through cable, part number 85133-60016.

# E8362/3/4B

## Uncorrected system performance<sup>1</sup> *continued*

| Description                                       | Specification | Supplemental information |
|---|---------------|--------------------------|
| <b>Crosstalk<sup>1</sup> - standard</b>           |               |                          |
| 10 to 45 MHz <sup>2</sup>                         | 65 dB         |                          |
| 45 MHz to 1 GHz                                   | 85 dB         |                          |
| 1 to 2 GHz  | 100 dB        |                          |
| 2 to 20 GHz                                       | 110 dB        |                          |
| 20 to 40 GHz                                      | 108 dB        |                          |
| 40 to 45 GHz                                      | 105 dB        |                          |
| 45 to 50 GHz                                      | 100 dB        |                          |
| <b>Crosstalk<sup>1</sup> - Option UNL or 014</b>  |               |                          |
| 10 to 45 MHz <sup>2</sup>                         | 65 dB         |                          |
| 45 MHz to 1 GHz                                   | 85 dB         |                          |
| 1 to 2 GHz  | 100 dB        |                          |
| 2 to 20 GHz                                       | 109 dB        |                          |
| 20 to 40 GHz                                      | 106 dB        |                          |
| 40 to 45 GHz                                      | 103 dB        |                          |
| 45 to 50 GHz                                      | 98 dB         |                          |
| <b>Crosstalk<sup>1</sup> - Option UNL and 014</b> |               |                          |
| 10 to 45 MHz <sup>2</sup>                         | 65 dB         |                          |
| 45 MHz to 1 GHz                                   | 85 dB         |                          |
| 1 to 2 GHz  | 98 dB         |                          |
| 2 to 10 GHz                                       | 108 dB        |                          |
| 10 to 20 GHz                                      | 107 dB        |                          |
| 20 to 40 GHz                                      | 104 dB        |                          |
| 40 to 45 GHz                                      | 100 dB        |                          |
| 45 to 50 GHz                                      | 95 dB         |                          |
| <b>Crosstalk - Option 080 enabled<sup>3</sup></b> |               | Typical:                 |
| 10 to 45 MHz                                      |               | 65 dB                    |
| 45 MHz to 1 GHz                                   |               | 85 dB                    |
| 1 to 2 GHz  |               | 100 dB                   |
| 2 to 10 GHz                                       |               | 109 dB                   |
| 10 to 20 GHz                                      |               | 110 dB                   |
| 20 to 40 GHz                                      |               | 106 dB                   |
| 40 to 45 GHz                                      |               | 103 dB                   |
| 45 to 50 GHz                                      |               | 98 dB                    |

1. Measurement conditions: Normalized to a thru, measured with two shorts, 10 Hz IF bandwidth, averaging factor of 16, alternate mode, source power set to the lesser of the maximum power out or the maximum receiver power.

2. Typical performance.

3. 0 Hz offset.

# E8362/3/4B

## Test port output

| Description                               | Specification                |                      |                      |                            | Supplemental information  |
|---|------------------------------|----------------------|----------------------|----------------------------|---|
|   | Standard                     | 014                  | UNL                  | UNL and 014                |   |
| <b>Frequency range</b>                    |                              |                      |                      |                            |   |
| E8362B                                    | ----- 10 MHz to 20 GHz ----- |                      |                      |                            |   |
| E8363B                                    | ----- 10 MHz to 40 GHz ----- |                      |                      |                            |   |
| E8364B                                    | ----- 10 MHz to 50 GHz ----- |                      |                      |                            |   |
| <b>Nominal power <sup>2</sup></b>         |                              |                      |                      |                            |   |
| E8362B                                    | 0 dBm                        | -5 dBm               | -5 dBm               | -5 dBm                     |   |
| E8363/4B                                  | -12 dBm                      | -17 dBm              | -17 dBm              | -17 dBm                    |   |
| <b>Frequency resolution</b>               | 1 Hz                         | 1 Hz                 | 1 Hz                 | 1 Hz                       |   |
| <b>CW accuracy</b>                        | ± 1ppm                       | ± 1ppm               | ± 1ppm               | ± 1ppm                     |   |
| <b>Frequency stability</b>                |                              |                      |                      |                            | ±1 ppm, 0 to 40 °C, typical<br>±0.2 ppm/yr, typical   |
| <b>Power level accuracy <sup>1</sup></b>  |                              |                      |                      |                            |   |
| 10 to 45 MHz <sup>3</sup>                 | ±2.0 dB                      | ±2.0 dB              | ±2.0 dB              | ±2.0 dB                    | Variation from nominal power in range 0 (step attenuator at 0 dB).                                    |
| 45 MHz to 10 GHz                          | ±1.5 dB                      | ±1.5 dB              | ±1.5 dB              | ±1.5 dB                    |   |
| 10 to 20 GHz                              | ±2.0 dB                      | ±2.0 dB              | ±2.0 dB              | ±2.0 dB                    |   |
| 20 to 40 GHz                              | ±3.0 dB                      | ±3.0 dB              | ±3.0 dB              | ±3.0 dB                    |   |
| 40 to 45 GHz                              | ±3.0 dB                      | ±3.5 dB              | ±3.0 dB              | ±3.5 dB                    |   |
| 45 to 50 GHz                              | ±3.0 dB                      | ±4.0 dB              | ±3.0 dB              | ±4.0 dB                    |   |
| <b>Power level linearity <sup>6</sup></b> |                              |                      |                      |                            |   |
| 10 to 45 MHz <sup>3</sup>                 | ±1.0 dB <sup>4</sup>         | ±1.0 dB <sup>4</sup> | ±1.0 dB <sup>4</sup> | ±1.0 dB <sup>4</sup>       | Test reference is at the nominal power level (step attenuator at 0 dB).                               |
| 45 MHz to 20 GHz                          | ±1.0 dB <sup>4</sup>         | ±1.0 dB <sup>4</sup> | ±1.0 dB <sup>4</sup> | ±1.0 dB <sup>4</sup>       |   |
| 20 to 40 GHz                              | ±1.0 dB <sup>4</sup>         | ±1.0 dB <sup>4</sup> | ±1.0 dB <sup>4</sup> | ±1.0 dB <sup>4</sup>       |   |
| 40 to 50 GHz                              | ±1.0 dB <sup>4</sup>         | ±1.0 dB <sup>4</sup> | ±1.0 dB <sup>4</sup> | ±1.0 dB <sup>4</sup>       |   |
| <b>Power range <sup>1, 5, 7</sup></b>     |                              |                      |                      |                            |   |
| 10 to 45 MHz <sup>3</sup>                 | -25 to +2 dB                 | -25 to +2 dBm        | -87 to +2 dBm        | -87 to +2 dBm              |   |
| 45 MHz to 10 GHz                          | -25 to +5 dB                 | -25 to +5 dBm        | -87 to +3 dBm        | -87 to +3 dBm <sup>8</sup> |   |
| 10 to 20 GHz                              | -24 to +3 dB                 | -25 to +2 dBm        | -86 to +1 dBm        | -87 to 0 dBm <sup>9</sup>  |   |
| 20 to 30 GHz                              | -23 to 0 dBm                 | -25 to -2 dBm        | -85 to -2 dBm        | -87 to -4 dBm              |   |
| 30 to 40 GHz                              | -23 to -4 dBm                | -25 to -6 dBm        | -85 to -6 dBm        | -87 to -8 dBm              |   |
| 40 to 45 GHz                              | -25 to -5 dBm                | -27 to -7 dBm        | -87 to -9 dBm        | -87 to -11 dBm             |   |
| 45 to 50 GHz                              | -25 to -10 dBm               | -27 to -12 dBm       | -87 to -15 dBm       | -87 to -17 dBm             |   |
| <b>Power sweep range (ALC)</b>            |                              |                      |                      |                            |   |
| 10 to 45 MHz <sup>3</sup>                 | 27 dB                        | 27 dB                | 29 dB                | 29 dB                      | ALC range starts at maximum leveled output power and decreases by power level indicated in the table. |
| 45 MHz to 10 GHz                          | 30 dB                        | 30 dB                | 30 dB                | 30 dB <sup>10</sup>        |   |
| 10 to 20 GHz                              | 27 dB                        | 27 dB                | 27 dB                | 27 dB <sup>11</sup>        |   |
| 20 to 30 GHz                              | 23 dB                        | 23 dB                | 23 dB                | 23 dB                      |   |
| 30 to 40 GHz                              | 19 dB                        | 19 dB                | 19 dB                | 19 dB                      |   |
| 40 to 45 GHz                              | 20 dB                        | 20 dB                | 18 dB                | 16 dB                      |   |
| 45 to 50 GHz                              | 15 dB                        | 15 dB                | 12 dB                | 10 dB                      |   |
| <b>Power resolution</b>                   | 0.01 dB                      | 0.01 dB              | 0.01 dB              | 0.01 dB                    |   |

- Test port output is a specification when the source is set to port 1 and a characteristic when the source is set to port 2.
- Preset power.
- Typical performance.
- ±1.5 dB for power ≤ -23 dBm.
- Power to which the source can be set and phase lock is assured.
- Power level linearity is a specification when the source is set to port 1 and a typical when the source is set to port 2.
- Test port power is specified into nominal 50 ohms.
- Option H11 decreases maximum power level by 1 dB.
- Option H11 decreases maximum power level by 2 dB.
- Option H11 decreases power level by 1 dB.
- Option H11 decreases power level by 2 dB.

# E8362/3/4B

## Test port output *continued*

| Description  | Specification | Supplemental information                      |
|--|---------------|---|
| <b>Phase noise</b> (1 kHz offset from center frequency, nominal power at test port)                        |               |   |
| 10 MHz to 10 GHz   |               | -60 dBc typical                               |
| 10 GHz to 20 GHz   |               | -55 dBc typical                               |
| 20 GHz to 50 GHz   |               | -50 dBc typical                               |
| <b>Phase noise</b> (1 kHz offset from center frequency, nominal power at test port) – Option 080 enabled   |               |   |
| 10 MHz to 10 GHz   |               | -60 dBc typical                               |
| 10 GHz to 20 GHz   |               | -60 dBc typical                               |
| 20 GHz to 50 GHz   |               | -50 dBc typical                               |
| <b>Phase noise</b> (10 kHz offset from center frequency, nominal power at test port)                       |               |   |
| 10 to 45 MHz   |               | -70 dBc typical                               |
| 45 MHz to 10 GHz   |               | -70 dBc typical                               |
| 10 to 20 GHz   |               | -65 dBc typical                               |
| 20 to 40 GHz   |               | -55 dBc typical                               |
| 40 to 50 GHz   |               | -55 dBc typical                               |
| <b>Phase noise</b> (10 kHz offset from center frequency, nominal power at test port) – Option 080 enabled  |               |   |
| 10 to 45 MHz   |               | -70 dBc typical                               |
| 45 MHz to 10 GHz   |               | -70 dBc typical                               |
| 10 to 20 GHz   |               | -65 dBc typical                               |
| 20 to 40 GHz   |               | -55 dBc typical                               |
| 40 to 50 GHz   |               | -55 dBc typical                               |
| <b>Phase noise</b> (100 kHz offset from center frequency, nominal power at test port)                      |               |   |
| 10 MHz to 10 GHz   |               | -60 dBc typical                               |
| 10 GHz to 20 GHz   |               | -55 dBc typical                               |
| 20 GHz to 50 GHz   |               | -50 dBc typical                               |
| <b>Phase noise</b> (100 kHz offset from center frequency, nominal power at test port) – Option 080 enabled |               |   |
| 10 MHz to 10 GHz   |               | -75 dBc typical                               |
| 10 GHz to 20 GHz   |               | -70 dBc typical                               |
| 20 GHz to 50 GHz   |               | -65 dBc typical                               |
| <b>Phase noise</b> (1 MHz offset from center frequency, nominal power at test port)                        |               |   |
| 10 MHz to 10 GHz   |               | -106 dBc typical                              |
| 10 GHz to 20 GHz   |               | -103 dBc typical                              |
| 20 GHz to 50 GHz   |               | -90 dBc typical                               |
| <b>Phase noise</b> (1 MHz offset from center frequency, nominal power at test port) – Option 080 enabled   |               |   |
| 10 MHz to 10 GHz   |               | -103 dBc typical                              |
| 10 GHz to 20 GHz   |               | -97 dBc typical                               |
| 20 GHz to 50 GHz   |               | -85 dBc typical                               |
| <b>Harmonics (2nd or 3rd)</b>  |               | -23 dBc typical, in power range 0             |
| <b>Non-harmonic spurious (at nominal output power)</b>   |               |   |
| 10 to 45 MHz   |               | -50 dBc typical, for offset frequency > 1 kHz |
| 45 MHz to 20 GHz   |               | -50 dBc typical, for offset frequency > 1 kHz |
| 20 to 40 GHz   |               | -30 dBc typical, for offset frequency > 1 kHz |
| 40 to 50 GHz   |               | -30 dBc typical, for offset frequency > 1 kHz |

1. Source output performance on port 1 only. Port 2 output performance is typical, except for power level accuracy which is characteristic.

# E8362/3/4B

## Test port input

| Description   | Specification |            |            |             | Supplemental information                |
|---|---------------|------------|------------|-------------|---|
|   | Standard      | 014        | UNL        | UNL and 014 |   |
| <b>Test port noise floor <sup>1</sup></b>                                     |               |            |            |             |   |
| 10 Hz IF bandwidth  |               |            |            |             |   |
| 10 to 45 MHz <sup>2</sup>   | < -77 dBm     | < -77 dBm  | < -77 dBm  | < -77 dBm   |   |
| 45 to 500 MHz <sup>3</sup>  | < -89 dBm     | < -89 dBm  | < -89 dBm  | < -89 dBm   |   |
| 500 MHz to 2 GHz  | < -114 dBm    | < -114 dBm | < -114 dBm | < -114 dBm  |   |
| 2 to 10 GHz   | < -117 dBm    | < -117 dBm | < -117 dBm | < -117 dBm  |   |
| 10 to 20 GHz  | < -120 dBm    | < -119 dBm | < -120 dBm | < -119 dBm  |   |
| 20 to 40 GHz  | < -114 dBm    | < -113 dBm | < -114 dBm | < -113 dBm  | Option 016 degrades performance by 2 dB |
| 40 to 50 GHz  | < -114 dBm    | < -112 dBm | < -114 dBm | < -112 dBm  | Option 016 degrades performance by 2 dB |
| 1 kHz IF bandwidth  |               |            |            |             |   |
| 10 to 45 MHz <sup>2</sup>   | < -57 dBm     | < -57 dBm  | < -57 dBm  | < -57 dBm   |   |
| 45 to 500 MHz <sup>3</sup>  | < -69 dBm     | < -69 dBm  | < -69 dBm  | < -69 dBm   |   |
| 500 MHz to 2 GHz  | < -94 dBm     | < -94 dBm  | < -94 dBm  | < -94 dBm   |   |
| 2 to 10 GHz   | < -97 dBm     | < -97 dBm  | < -97 dBm  | < -97 dBm   |   |
| 10 to 20 GHz  | < -100 dBm    | < -99 dBm  | < -100 dBm | < -99 dBm   |   |
| 20 to 40 GHz  | < -94 dBm     | < -93 dBm  | < -94 dBm  | < -93 dBm   | Option 016 degrades performance by 2 dB |
| 40 to 50 GHz  | < -94 dBm     | < -92 dBm  | < -94 dBm  | < -92 dBm   | Option 016 degrades performance by 2 dB |
| <b>Test port noise floor <sup>1,2</sup> - Option 080 enabled <sup>4</sup></b> |               |            |            |             |   |
| 10 Hz IF bandwidth  |               |            |            |             |   |
| 10 to 45 MHz <sup>2</sup>   | < -77 dBm     | < -77 dBm  | < -77 dBm  | < -77 dBm   |   |
| 45 to 500 MHz <sup>3</sup>  | < -88 dBm     | < -88 dBm  | < -88 dBm  | < -88 dBm   |   |
| 500 MHz to 2 GHz  | < -113 dBm    | < -113 dBm | < -113 dBm | < -113 dBm  |   |
| 2 to 10 GHz   | < -116 dBm    | < -116 dBm | < -116 dBm | < -116 dBm  |   |
| 10 to 20 GHz  | < -118 dBm    | < -118 dBm | < -118 dBm | < -118 dBm  |   |
| 20 to 40 GHz  | < -112 dBm    | < -112 dBm | < -112 dBm | < -112 dBm  | Option 016 degrades performance by 2 dB |
| 40 to 50 GHz  | < -111 dBm    | < -111 dBm | < -111 dBm | < -111 dBm  | Option 016 degrades performance by 2 dB |
| 1 kHz IF bandwidth  |               |            |            |             |   |
| 10 to 45 MHz <sup>2</sup>   | < -57 dBm     | < -57 dBm  | < -57 dBm  | < -57 dBm   |   |
| 45 to 500 MHz <sup>3</sup>  | < -68 dBm     | < -68 dBm  | < -68 dBm  | < -68 dBm   |   |
| 500 MHz to 2 GHz  | < -93 dBm     | < -93 dBm  | < -93 dBm  | < -93 dBm   |   |
| 2 to 10 GHz   | < -96 dBm     | < -96 dBm  | < -96 dBm  | < -96 dBm   |   |
| 10 to 20 GHz  | < -98 dBm     | < -98 dBm  | < -98 dBm  | < -98 dBm   |   |
| 20 to 40 GHz  | < -92 dBm     | < -92 dBm  | < -92 dBm  | < -92 dBm   | Option 016 degrades performance by 2 dB |
| 40 to 50 GHz  | < -91 dBm     | < -91 dBm  | < -91 dBm  | < -91 dBm   | Option 016 degrades performance by 2 dB |
| <b>Direct receiver access input noise floor <sup>1,2</sup></b>                |               |            |            |             |   |
| 10 Hz IF bandwidth  |               |            |            |             |   |
| 10 to 45 MHz  |               | < -127 dBm |            | < -127 dBm  |   |
| 45 to 500 MHz   |               | < -127 dBm |            | < -127 dBm  |   |
| 500 MHz to 2 GHz  |               | < -133 dBm |            | < -133 dBm  |   |
| 2 to 10 GHz   |               | < -132 dBm |            | < -132 dBm  |   |
| 10 to 20 GHz  |               | < -134 dBm |            | < -134 dBm  |   |
| 20 to 40 GHz  |               | < -125 dBm |            | < -125 dBm  | Option 016 degrades performance by 2 dB |
| 40 to 50 GHz  |               | < -123 dBm |            | < -123 dBm  | Option 016 degrades performance by 2 dB |
| 1 kHz IF bandwidth  |               |            |            |             |   |
| 10 to 45 MHz  |               | < -107 dBm |            | < -107 dBm  |   |
| 45 to 500 MHz   |               | < -107 dBm |            | < -107 dBm  |   |
| 500 MHz to 2 GHz  |               | < -113 dBm |            | < -113 dBm  |   |
| 2 to 10 GHz   |               | < -112 dBm |            | < -112 dBm  |   |
| 10 to 20 GHz  |               | < -114 dBm |            | < -114 dBm  |   |
| 20 to 40 GHz  |               | < -105 dBm |            | < -105 dBm  | Option 016 degrades performance by 2 dB |
| 40 to 50 GHz  |               | < -103 dBm |            | < -103 dBm  | Option 016 degrades performance by 2 dB |

1. Total average (rms) noise power calculated as mean value of a linear magnitude trace expressed in dBm.

2. Typical performance.

3. Noise floor may be degraded by 10 dB at particular frequencies (multiples of 5 MHz) due to spurious receiver residuals.

4. 0 Hz offset.

# E8362/3/4B

## Test port input *continued*

| Description  | Specification   |             | Supplemental information                |
|--|---|-------------|---|
|  | Standard, 014, UNL  | UNL and 014 |   |
| <b>Direct receiver access input noise floor<sup>1,2</sup> - Option 080 enabled<sup>4</sup></b> |   |             |   |
| 10 Hz IF bandwidth   |   |             |   |
| 10 to 45 MHz   | < -127 dBm  | < -127 dBm  |   |
| 45 to 500 MHz <sup>3</sup>   | < -126 dBm  | < -126 dBm  |   |
| 500 MHz to 2 GHz   | < -132 dBm  | < -132 dBm  |   |
| 2 to 10 GHz  | < -131 dBm  | < -131 dBm  |   |
| 10 to 20 GHz   | < -133 dBm  | < -133 dBm  |   |
| 20 to 40 GHz   | < -124 dBm  | < -124 dBm  | Option 016 degrades performance by 2 dB |
| 40 to 50 GHz   | < -122 dBm  | < -122 dBm  | Option 016 degrades performance by 2 dB |
| 1 kHz IF bandwidth   |   |             |   |
| 10 to 45 MHz   | < -107 dBm  | < -107 dBm  |   |
| 45 to 500 MHz <sup>3</sup>   | < -106 dBm  | < -106 dBm  |   |
| 500 MHz to 2 GHz   | < -112 dBm  | < -112 dBm  |   |
| 2 to 10 GHz  | < -111 dBm  | < -111 dBm  |   |
| 10 to 20 GHz   | < -113 dBm  | < -113 dBm  |   |
| 20 to 40 GHz   | < -104 dBm  | < -104 dBm  | Option 016 degrades performance by 2 dB |
| 40 to 50 GHz   | < -102 dBm  | < -102 dBm  | Option 016 degrades performance by 2 dB |
| <b>Receiver compression level (measured at test ports)</b>                                     |   |             |   |
| 10 MHz to 20 GHz   | -----  < 0.1 dB at -5 dBm <sup>5</sup> and < 0.45 dB at +5 dBm    |             |   |
| 20 to 30 GHz   | -----  < 0.1 dB at -9.5 dBm <sup>5</sup> and < 0.45 dB at 0 dBm   |             |   |
| 30 to 40 GHz   | -----  < 0.1 dB at -12.5 dBm <sup>5</sup> and < 0.45 dB at -3 dBm |             |   |
| 40 to 50 GHz   | -----  < 0.1 dB at -12.5 dBm <sup>5</sup> and < 0.45 dB at -3 dBm |             |   |
| <b>System compression level</b>  | max output power  |             | See dynamic accuracy chart              |
| <b>Third order intercept – Tone spacing from 100 kHz to 5 MHz</b>                              |   |             |   |
|  |   |             | Typical:                                |
| 10 to 150 MHz  |   |             | +33 dBm                                 |
| 150 to 300 MHz   |   |             | +34 dBm                                 |
| 300 to 500 MHz   |   |             | +30 dBm                                 |
| 500 MHz to 20 GHz  |   |             | +24 dBm                                 |
| 20 to 40 GHz   |   |             | +18 dBm                                 |
| 40 to 50 GHz   |   |             | +15 dBm                                 |
| <b>Third order intercept – Tone spacing from 5 MHz to 20 MHz</b>                               |   |             |   |
|  |   |             | Typical:                                |
| 10 to 500 MHz  |   |             | +20 dBm                                 |
| 500 MHz to 20 GHz  |   |             | +20 dBm                                 |
| 20 to 40 GHz   |   |             | +16 dBm                                 |
| 40 to 50 GHz   |   |             | +15 dBm                                 |
| <b>Third order intercept – Tone spacing from 20 MHz to 50 MHz</b>                              |   |             |   |
|  |   |             | Typical:                                |
| 10 to 500 MHz  |   |             | +26 dBm                                 |
| 500 MHz to 20 GHz  |   |             | +26 dBm                                 |
| 20 to 40 GHz   |   |             | +20 dBm                                 |
| 40 to 50 GHz   |   |             | +19 dBm                                 |

1. Total average (rms) noise power calculated as mean value of a linear magnitude trace expressed in dBm.
2. Typical performance.
3. Noise floor may be degraded by 10 dB at particular frequencies (multiples of 5 MHz) due to spurious receiver residuals.

4. 0 Hz offset.
5. This compression level comes from the dynamic accuracy curve with -30 dB reference test port power.



# E8362/3/4B

## Test port input *continued*

| Description  | Specification |                |          |             | Supplemental information  |
|--|---------------|----------------|----------|-------------|---|
|  | Standard      | 014            | UNL      | UNL and 014 |   |
| <b>Trace noise magnitude</b>                                     |               |                |          |             |   |
| 10 to 45 MHz <sup>1</sup>  | -----         | < 0.050 dB rms | -----    |             | 1 kHz IF bandwidth<br>Ratio measurement, nominal power at test port   |
| 45 to 500 MHz <sup>2</sup>                                       | -----         | < 0.010 dB rms | -----    |             |   |
| 500 MHz to 20 GHz  | -----         | < 0.006 dB rms | -----    |             |   |
| 20 to 40 GHz   | -----         | < 0.006 dB rms | -----    |             |   |
| 40 to 50 GHz   | -----         | < 0.006 dB rms | -----    |             |   |
| <b>Trace noise magnitude – Option 080 enabled<sup>1, 4</sup></b> |               |                |          |             |   |
| 10 to 45 MHz <sup>1</sup>  | -----         | < 0.060 dB rms | -----    |             | 1 kHz IF bandwidth<br>Ratio measurement, nominal power at test port   |
| 45 to 500 MHz <sup>2</sup>                                       | -----         | < 0.010 dB rms | -----    |             |   |
| 500 MHz to 20 GHz  | -----         | < 0.006 dB rms | -----    |             |   |
| 20 to 40 GHz   | -----         | < 0.007 dB rms | -----    |             |   |
| 40 to 50 GHz   | -----         | < 0.008 dB rms | -----    |             |   |
| <b>Trace noise phase</b>   |               |                |          |             |   |
| 10 to 45 MHz <sup>1</sup>  | -----         | < 0.350° rms   | -----    |             | 1 kHz IF bandwidth<br>Ratio measurement, nominal power at test port   |
| 45 to 500 MHz <sup>2</sup>                                       | -----         | < 0.100° rms   | -----    |             |   |
| 500 MHz to 20 GHz  | -----         | < 0.060° rms   | -----    |             |   |
| 20 to 40 GHz   | -----         | < 0.100° rms   | -----    |             |   |
| 40 to 50 GHz   | -----         | < 0.100° rms   | -----    |             |   |
| <b>Trace noise phase – Option 080 enabled<sup>1, 4</sup></b>     |               |                |          |             |   |
| 10 to 45 MHz <sup>1</sup>  | -----         | < 0.350° rms   | -----    |             | 1 kHz IF bandwidth<br>Ratio measurement, nominal power at test port   |
| 45 to 500 MHz <sup>2</sup>                                       | -----         | < 0.100° rms   | -----    |             |   |
| 500 MHz to 20 GHz  | -----         | < 0.060° rms   | -----    |             |   |
| 20 to 40 GHz   | -----         | < 0.100° rms   | -----    |             |   |
| 40 to 50 GHz   | -----         | < 0.100° rms   | -----    |             |   |
| <b>Reference level magnitude</b>                                 |               |                |          |             |   |
| Range  | ±200 dB       | ±200 dB        | ±200 dB  | ±200 dB     |   |
| Resolution   | 0.001 dB      | 0.001 dB       | 0.001 dB | 0.001 dB    |   |
| <b>Reference level phase</b>                                     |               |                |          |             |   |
| Range  | ±500°         | ±500°          | ±500°    | ±500°       |   |
| Resolution   | 0.01°         | 0.01°          | 0.01°    | 0.01°       |   |
| <b>Stability magnitude<sup>3</sup></b>                           |               |                |          |             |   |
| 10 to 45 MHz   |               |                |          |             | Typical ratio measurement:<br>Measured at the test port<br>±0.05 dB/°C<br>±0.02 dB/°C<br>±0.03 dB/°C<br>±0.04 dB/°C   |
| 45 MHz to 20 GHz   |               |                |          |             |   |
| 20 to 40 GHz   |               |                |          |             |   |
| 40 to 50 GHz   |               |                |          |             |   |
| <b>Stability phase<sup>3</sup></b>                               |               |                |          |             |   |
| 10 to 45 MHz   |               |                |          |             | Typical ratio measurement:<br>Measured at the test port<br>±0.5°/°C<br>±0.2°/°C<br>±0.5°/°C<br>±0.8°/°C   |
| 45 MHz to 20 GHz   |               |                |          |             |   |
| 20 to 40 GHz   |               |                |          |             |   |
| 40 to 50 GHz   |               |                |          |             |   |
| <b>Damage input level</b>  |               |                |          |             |   |
| Test port 1 and 2  |               |                |          |             | 30 dBm or ±40 VDC, typical<br>15 dBm or ±15 VDC, typical<br>15 dBm or ±15 VDC, typical<br>30 dBm or ±40 VDC, typical<br>30 dBm or ±7 VDC, typical<br>20 dBm or ±15 VDC, typical<br>20 dBm or 0 VDC, typical |
| R1, R2 in  |               |                |          |             |   |
| A, B in  |               |                |          |             |   |
| Coupler thru (Option 014 or UNL and 014)                         |               |                |          |             |   |
| Coupler arm (Option 014 or UNL and 014)                          |               |                |          |             |   |
| Source out (reference)   |               |                |          |             |   |
| Source out (test ports)  |               |                |          |             |   |

1. Typical performance.

2. Trace noise magnitude may be degraded to 20 mdB rms at harmonic frequencies of the first IF (8.33 MHz) below 80 MHz.

3. Stability is defined as a ratio measurement measured at the test port.

4. 0 Hz offset.

# E8362/3/4B

## Test port input *continued*

### Group delay<sup>1</sup>

| Description           | Specification | Supplemental information (typical)  |
|-----------------------|---------------|---|
| Aperture (selectable) |               | (frequency span)/(number of points – 1)   |
| Maximum aperture      |               | 20% of frequency span   |
| Range                 |               | 0.5 x (1/minimum aperture)  |
| Maximum delay         |               | Limited to measuring no more than 180° of phase change within the minimum aperture. |

The following graph shows characteristic group delay accuracy with type-N full 2-port calibration and a 10 Hz IF bandwidth. Insertion loss is assumed to be less than 2 dB and electrical length to be 10 m.

### Group delay (typical)

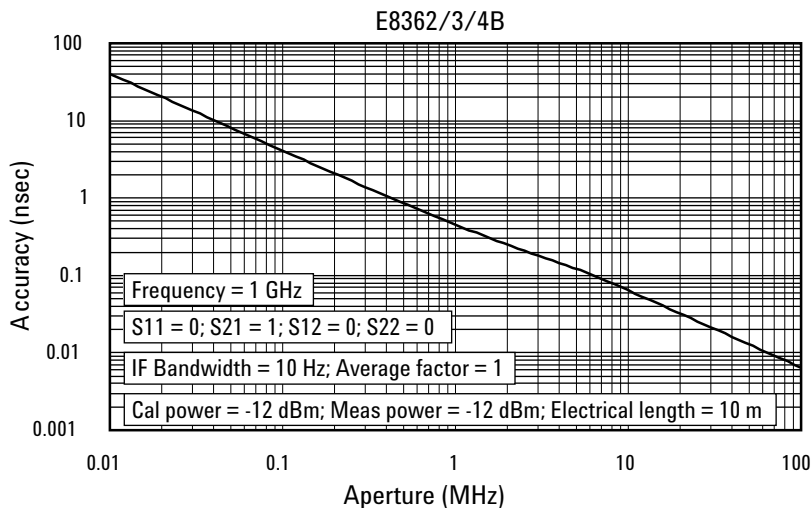

In general, the following formula can be used to determine the accuracy, in seconds, of a specific group delay measurement:

$$\pm \text{Phase accuracy (deg)} / [360 \times \text{Aperture (Hz)}]$$

Depending on the aperture and device length, the phase accuracy used is either incremental phase accuracy or worse case phase accuracy.

1. Group delay is computed by measuring the phase change within a specified frequency step (determined by the frequency span and the number of points per sweep).

# E8362/3/4B

## Test port input *continued*

### Dynamic accuracy (specifications)<sup>1</sup>

Applies to input ports 1 and 2, accuracy of the test port input power reading relative to the reference

input power level. Also applies to the following conditions:

- IF bandwidth = 10 Hz

Magnitude

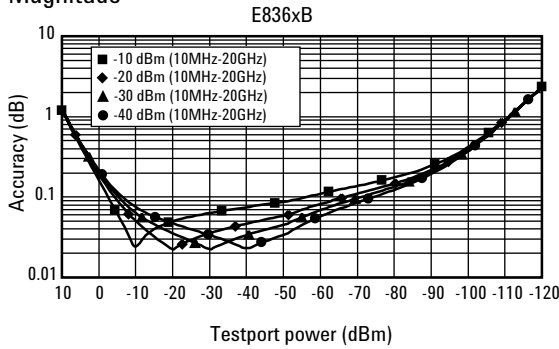

Phase

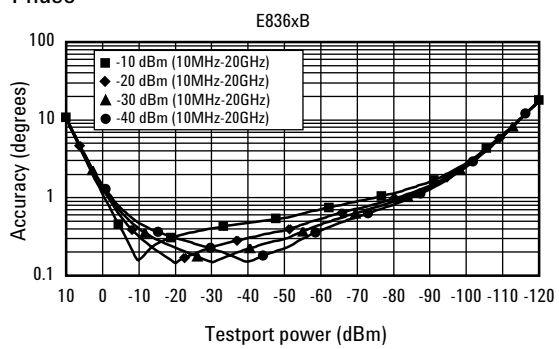

Magnitude

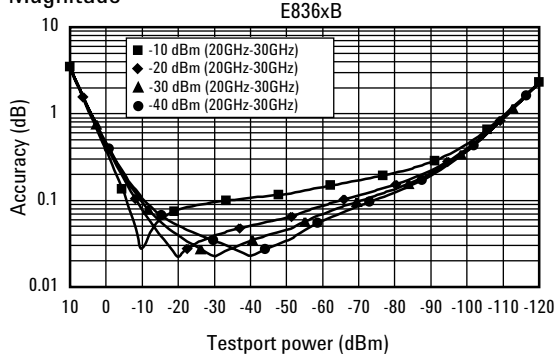

Phase

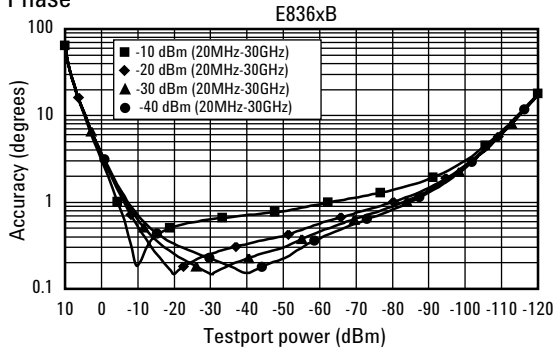

Magnitude

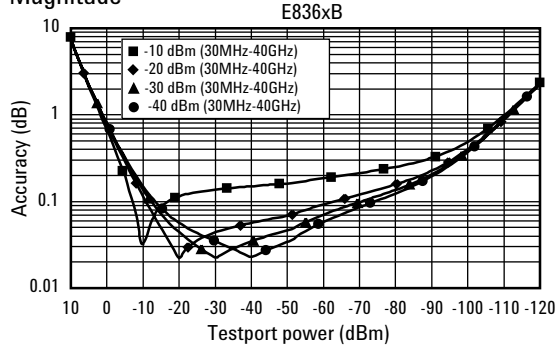

Phase

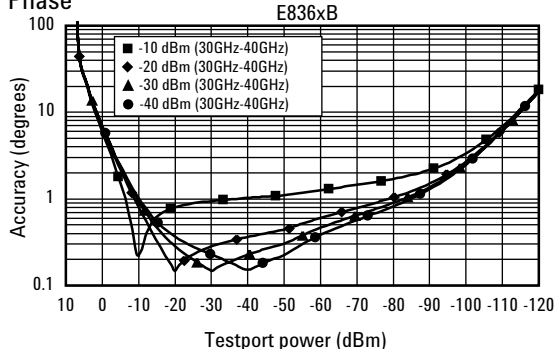

Magnitude

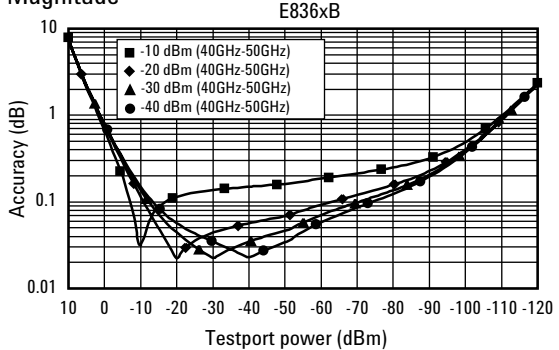

Phase

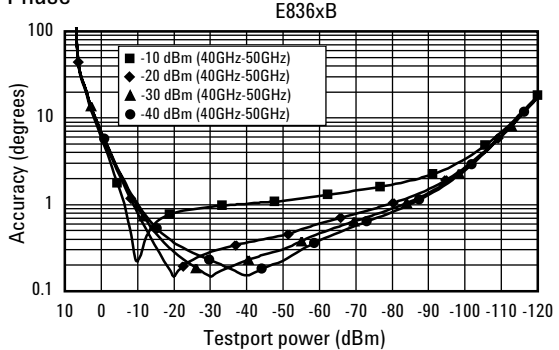

1. Dynamic accuracy is verified with the following measurements: compression over frequency, IF linearity at a single frequency of 1.195 GHz and a reference level of -20 dBm for an input power range of 0 to -120 dBm.

# E8361A

## Corrected system performance

The specifications in this section apply for measurements made with the Agilent E8361A PNA Series microwave network analyzer with the following conditions:

- 10 Hz IF bandwidth
- no averaging applied to data

### System dynamic range<sup>1</sup>

| Description  | Specification (dB)<br>at test port <sup>2</sup> | Typical (dB) at direct<br>receiver access input <sup>3</sup> | Supplemental<br>information               |
|--|---|--|---|
| <b>Dynamic range</b>   |   |  |   |
| <b>Standard configuration (E8361A)</b>   |   |  |   |
| 10 to 45 MHz <sup>4</sup>  | 61  | N/A  |   |
| 45 to 500 MHz <sup>5</sup>   | 87  | N/A  |   |
| 500 MHz to 750 MHz   | 112   | N/A  |   |
| 750 MHz to 2 GHz   | 111   | N/A  |   |
| 2 to 10 GHz  | 111   | N/A  |   |
| 10 to 24 GHz   | 114   | N/A  |   |
| 24 to 30 GHz   | 103   | N/A  |   |
| 30 to 40 GHz   | 104   | N/A  |   |
| 40 to 45 GHz   | 96  | N/A  |   |
| 45 to 50 GHz   | 100   | N/A  |   |
| 50 to 60 GHz   | 97  | N/A  |   |
| 60 to 67 GHz   | 94  | N/A  |   |
| 67 to 70 GHz <sup>4</sup>  | 94  | N/A  |   |
| <b>Configurable test set (E8361A - Option 014 or Option 014 and 080)</b>   |   |  |   |
| 10 to 45 MHz <sup>4</sup>  | 61  | 99   |   |
| 45 to 500 MHz <sup>5</sup>   | 87  | 102  |   |
| 500 MHz to 750 MHz   | 112   | 125.5  |   |
| 750 MHz to 2 GHz   | 111   | 125.5  |   |
| 2 to 10 GHz  | 111   | 125  |   |
| 10 to 24 GHz   | 112   | 128  |   |
| 24 to 30 GHz   | 101   | 117.5  | } Option 016 degrades performance by 2 dB |
| 30 to 40 GHz   | 102   | 115  |   |
| 40 to 45 GHz   | 94  | 109  |   |
| 45 to 50 GHz   | 98  | 110.5  |   |
| 50 to 60 GHz   | 95  | 107  | } Option 016 degrades performance by 3 dB |
| 60 to 67 GHz   | 90  | 101  |   |
| 67 to 70 GHz <sup>4</sup>  | 90  | 100  |   |
| <b>Configurable test set with extended power range (E8361A - Option 014 and UNL or Options 014, UNL and 080)</b> |   |  |   |
| 10 to 45 MHz <sup>4</sup>  | 61  | 99   |   |
| 45 to 500 MHz  | 87  | 102  |   |
| 500 MHz to 750 MHz   | 112   | 125.5  |   |
| 750 MHz to 2 GHz   | 111   | 124  |   |
| 2 to 10 GHz  | 111   | 124  |   |
| 10 to 24 GHz   | 112   | 125  |   |
| 24 to 30 GHz   | 101   | 114.5  | } Option 016 degrades performance by 2 dB |
| 30 to 40 GHz   | 99  | 112  |   |
| 40 to 45 GHz   | 92  | 105  |   |
| 45 to 50 GHz   | 94  | 106.5  |   |
| 50 to 60 GHz   | 91  | 103  | } Option 016 degrades performance by 3 dB |
| 60 to 67 GHz   | 84  | 95   |   |
| 67 to 70 GHz <sup>4</sup>  | 84  | 94   |   |

1. The system dynamic range is calculated as the difference between the noise floor and the source maximum output power. System dynamic range is a specification when the source is set to port 1, and a characteristic when the source is set to port 2. The effective dynamic range must take measurement uncertainties and interfering signals into account, as well as the insertion loss resulting from a thru cable connected between port 1 and port 2.
2. The test port system dynamic range is calculated as the difference between the test port noise floor and the source maximum output power. The effective dynamic range must take measurement uncertainties and interfering signals into account, as well as the insertion loss resulting from a thru cable connected between port 1 and port 2.
3. The direct receiver access input system dynamic range is calculated as the difference between the direct receiver access input noise floor and the source maximum output power. The effective dynamic range must take measurement uncertainties and interfering signals into account. This set-up should only be used when the receiver input will never exceed its damage level. When the analyzer is in segment sweep mode, the analyzer can have pre-defined frequency segments which will output a higher power level when the extended dynamic range is required (i.e. devices with high insertion loss), and reduced power when receiver damage may occur (i.e. devices with low insertion loss). The extended range is only available in one-path transmission measurements.
4. Typical performance.
5. May be limited to 100 dB at particular frequencies below 500 MHz due to spurious receiver residuals. Methods are available to regain the full dynamic range.

# E8361A

## Corrected system performance with 1.85 mm connectors

### Standard configuration and standard power range

Applies to E8361A PNA Series analyzer, N4694A (1.85 mm) ECal electronic calibration module, N4697E/F flexible test port cable set, and a full two-port calibration. (Specifications apply over environmental temperature of 23 °C ±3 °C, with less than 1 °C deviation from calibration temperature.)

| Description           | Specification (dB)            |                   |                   |                   |
|-----------------------|-------------------------------|-------------------|-------------------|-------------------|
|                       | 10 MHz to 40 MHz <sup>1</sup> | 40 MHz to 2 GHz   | 2 to 20 GHz       | 20 to 30 GHz      |
| Directivity           | 33                            | 33                | 50                | 46                |
| Source match          | 25                            | 25                | 39                | 35                |
| Load match            | 25                            | 25                | 38                | 34                |
| Reflection tracking   | ±0.50 (+0.02/°C)              | ±0.05 (+0.02/°C)  | ±0.040 (+0.02/°C) | ±0.05 (+0.02/°C)  |
| Transmission tracking | ±0.152 (+0.02/°C)             | ±0.152 (+0.02/°C) | ±0.050 (+0.02/°C) | ±0.069 (+0.02/°C) |

### Transmission uncertainty (specifications)

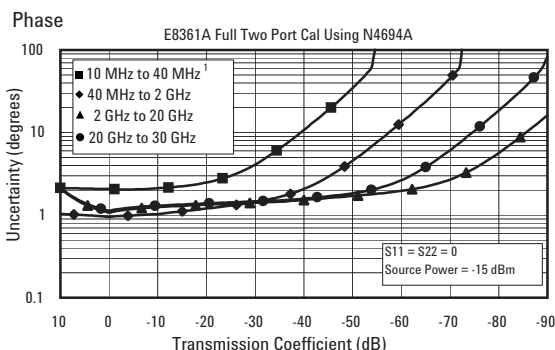
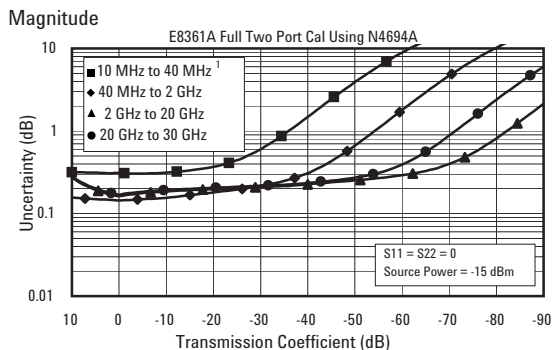

### Reflection uncertainty (specifications)

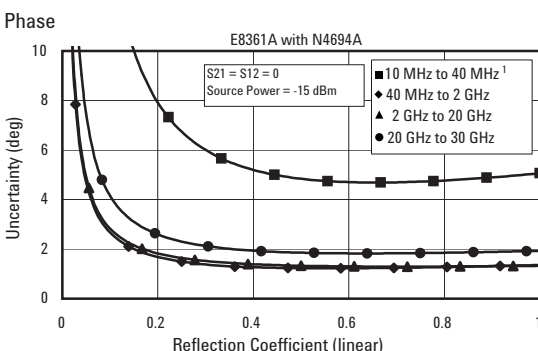
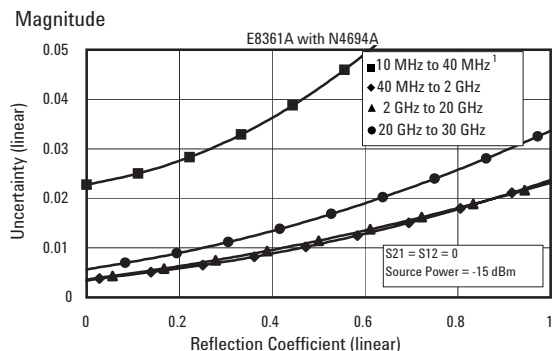

1. Typical performance.

# E8361A

## Corrected system performance with 1.85 mm connectors *continued*

### Standard configuration and standard power range (E8361A)

Applies to E8361A PNA Series analyzer, N4694A  
 (1.85 mm) ECal electronic calibration module, N4697E/F  
 flexible test port cable set, and a full two-port calibration.  
 (Specifications apply over environmental temperature  
 of 23 °C ±3 °C, with less than 1 °C deviation from  
 calibration temperature.)

| Description           | Specification (dB) |                   |                   |                   |
|-----------------------|--------------------|-------------------|-------------------|-------------------|
|                       | 30 GHz to 40 GHz   | 40 to 50 GHz      | 50 to 60 GHz      | 60 to 67 GHz      |
| Directivity           | 44                 | 42                | 41                | 38                |
| Source match          | 34                 | 33                | 30                | 27                |
| Load match            | 33                 | 32                | 29                | 26                |
| Reflection tracking   | ±0.060 (+0.02/°C)  | ±0.070 (+0.02/°C) | ±0.080 (+0.02/°C) | ±0.090 (+0.03/°C) |
| Transmission tracking | ±0.087 (+0.02/°C)  | ±0.102 (+0.02/°C) | ±0.121 (+0.02/°C) | ±0.147 (+0.03/°C) |

### Transmission uncertainty (specifications)

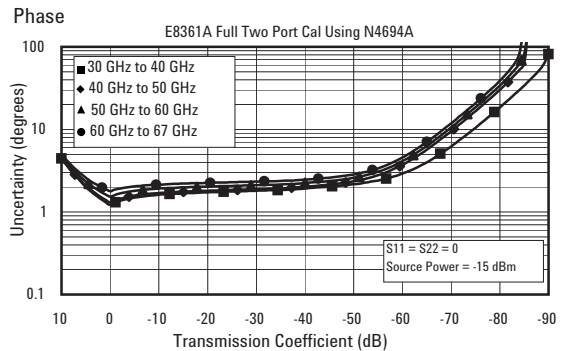
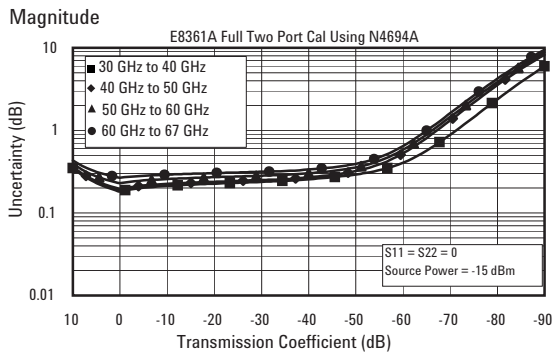

### Reflection uncertainty (specifications)

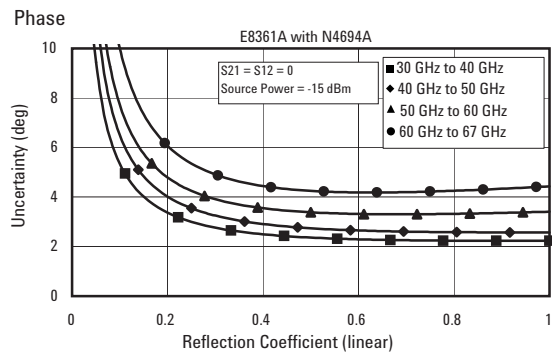
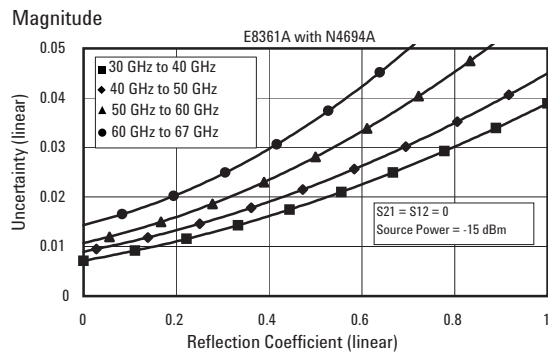

# E8361A

## Corrected system performance with 1.85 mm connectors *continued*

### Fully optioned (E8361A with options 014/UNL/080/081/016)

Applies to E8361A PNA Series analyzer, N4694A (1.85 mm) ECal electronic calibration module, N4697F flexible test port cable set, and a full two-port calibration. (Specifications apply over environmental temperature of 23 °C ±3 °C, with less than 1 °C deviation from calibration temperature.)

| Description           | Specification (dB)            |                   |                   |                   |
|-----------------------|-------------------------------|-------------------|-------------------|-------------------|
|                       | 10 MHz to 40 MHz <sup>1</sup> | 40 MHz to 2 GHz   | 2 to 20 GHz       | 20 to 30 GHz      |
| Directivity           | 33                            | 33                | 50                | 46                |
| Source match          | 25                            | 25                | 39                | 35                |
| Load match            | 25                            | 25                | 37                | 34                |
| Reflection tracking   | ±0.050 (+0.02/°C)             | ±0.050 (+0.02/°C) | ±0.040 (+0.02/°C) | ±0.050 (+0.02/°C) |
| Transmission tracking | ±0.146 (+0.02/°C)             | ±0.146 (+0.02/°C) | ±0.054 (+0.02/°C) | ±0.068 (+0.02/°C) |

### Transmission uncertainty (specifications)

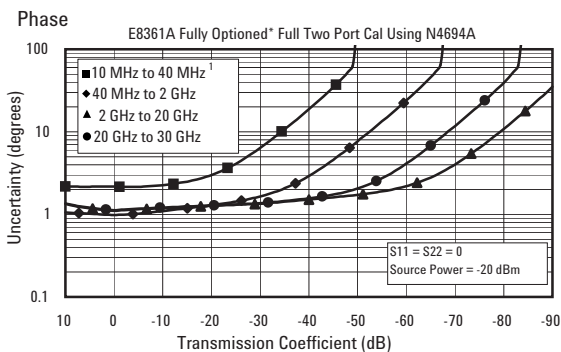
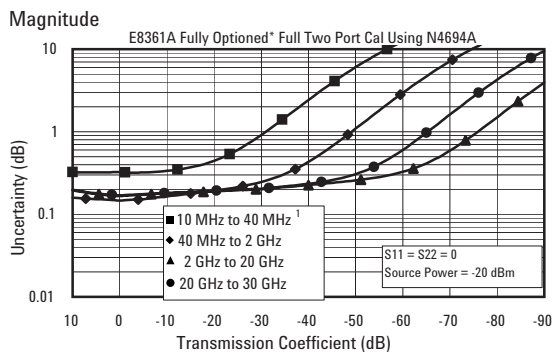

### Reflection uncertainty (specifications)

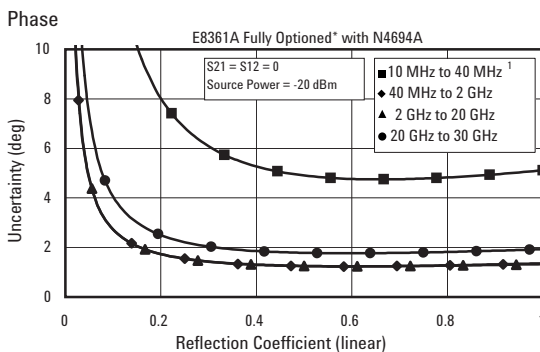
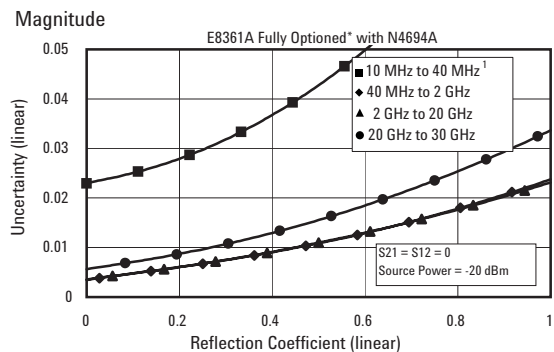

1. Typical performance.

\* Configurable Test Set, Extended Power Range and Bias-Tees, Receiver Attenuators, Frequency Offset Mode, and Reference Channel Transfer Switch (Option 014, UNL, 016, 080 and 081).

# E8361A

## Corrected system performance with 1.85 mm connectors *continued*

### Fully optioned (E8361A with options 014/UNL/080/081/016)

Applies to E8361A PNA Series analyzer, N4694A (1.85 mm) ECal electronic calibration module, 85133F flexible test port cable set, and a full two-port calibration. (Specifications apply over environmental temperature of 23 °C ±3 °C, with less than 1 °C deviation from calibration temperature.)

| Description           | Specification (dB) |                   |                   |                   |
|-----------------------|--------------------|-------------------|-------------------|-------------------|
|                       | 30 to 40 GHz       | 40 to 50 GHz      | 50 to 60 GHz      | 60 to 67 GHz      |
| Directivity           | 44                 | 42                | 41                | 38                |
| Source match          | 34                 | 33                | 30                | 27                |
| Load match            | 33                 | 32                | 29                | 26                |
| Reflection tracking   | ±0.060 (+0.02/°C)  | ±0.070 (+0.02/°C) | ±0.080 (+0.02/°C) | ±0.090 (+0.03/°C) |
| Transmission tracking | ±0.082 (+0.02/°C)  | ±0.097 (+0.02/°C) | ±0.112 (+0.02/°C) | ±0.144 (+0.03/°C) |

### Transmission uncertainty (specifications)

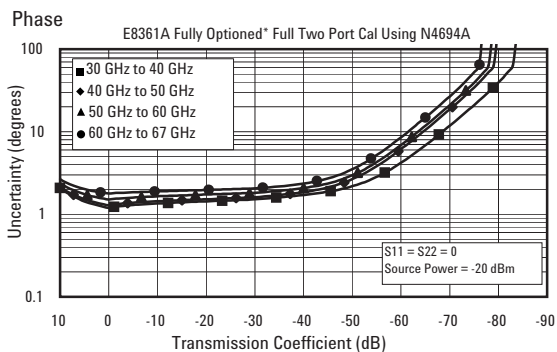
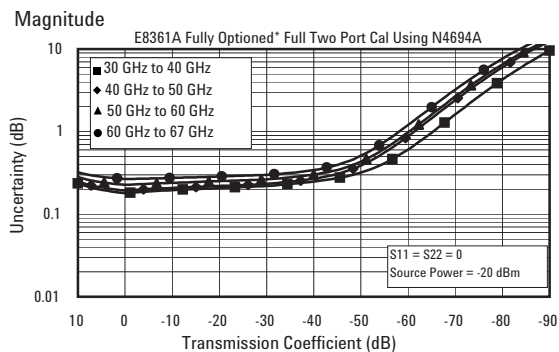

### Reflection uncertainty (specifications)

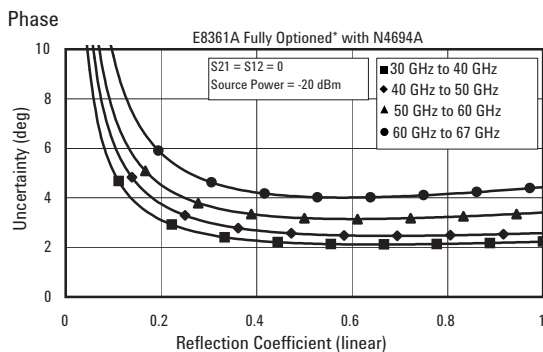
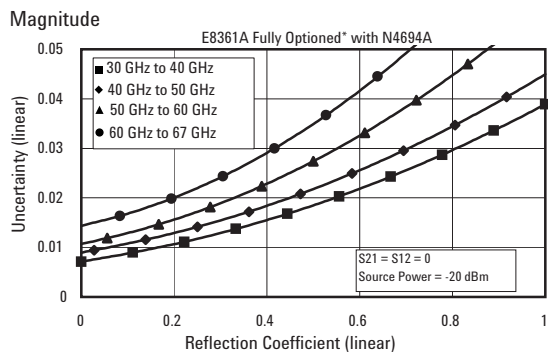

\* Configurable Test Set, Extended Power Range and Bias-Tees, Receiver Attenuators, Frequency Offset Mode, and Reference Channel Transfer Switch (Option 014, UNL, 016, 080 and 081).



# E8361A

## Corrected system performance with 1.85 mm connectors *continued*

### Standard configuration and standard power range (E8361A)

Applies to E8361A PNA Series analyzer, 85058B (1.85 mm) calibration kit, N4697F flexible test port cable set, and a full two-port calibration. (Specifications apply over environmental temperature of 23 °C ±3 °C, with less than 1 °C deviation from calibration temperature.)

| Description           | Specification (dB)            |                   |                   |                   |
|-----------------------|-------------------------------|-------------------|-------------------|-------------------|
|                       | 10 MHz to 45 MHz <sup>1</sup> | 45 MHz to 2 GHz   | 2 to 10 GHz       | 10 to 20 GHz      |
| Directivity           | 35                            | 35                | 41                | 38                |
| Source match          | 34                            | 34                | 44                | 40                |
| Load match            | 34                            | 35                | 41                | 37                |
| Reflection tracking   | ±0.019 (+0.02/°C)             | ±0.019 (+0.02/°C) | ±0.010 (+0.02/°C) | ±0.033 (+0.02/°C) |
| Transmission tracking | ±0.164 (+0.02/°C)             | ±0.081 (+0.02/°C) | ±0.036 (+0.02/°C) | ±0.063 (+0.02/°C) |

### Transmission uncertainty (specifications)

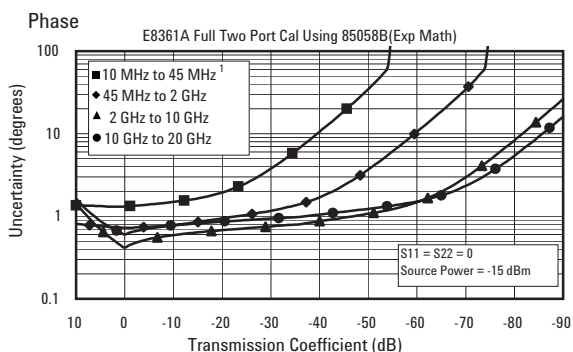
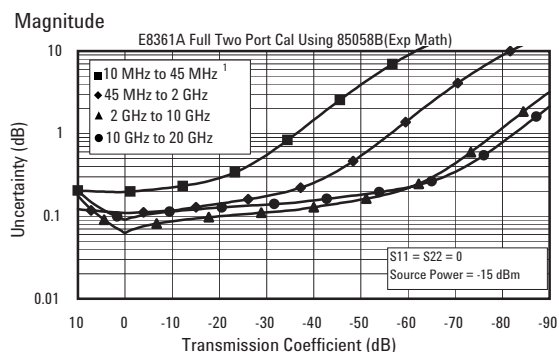

### Reflection uncertainty (specifications)

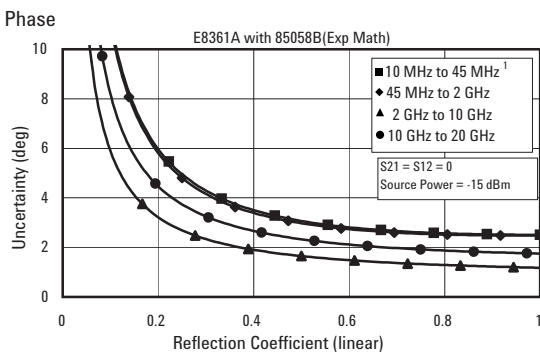
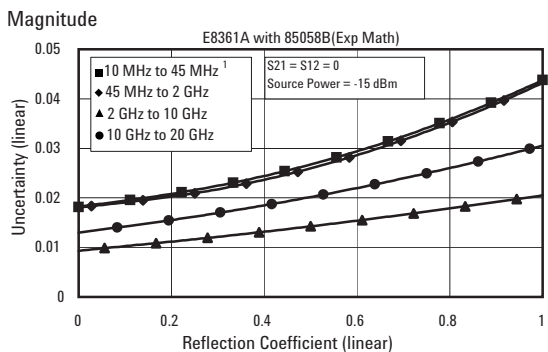

1. Typical performance.

# E8361A

## Corrected system performance with 1.85 mm connectors *continued*

### Standard configuration and standard power range (E8361A)

Applies to E8361A PNA Series analyzer, 85058B (1.85 mm) calibration kit, N4697F flexible test port cable set, and a full two-port calibration. (Specifications apply over environmental temperature of 23 °C ±3 °C, with less than 1 °C deviation from calibration temperature.)

| Description           | Specification (dB) |                   |                   |                   |
|-----------------------|--------------------|-------------------|-------------------|-------------------|
|                       | 20 to 35 GHz       | 35 to 50 GHz      | 50 to 60 GHz      | 60 to 67 GHz      |
| Directivity           | 37                 | 37                | 34                | 34                |
| Source match          | 41                 | 42                | 40                | 40                |
| Load match            | 36                 | 36                | 33                | 33                |
| Reflection tracking   | ±0.033 (+0.02/°C)  | ±0.020 (+0.02/°C) | ±0.030 (+0.02/°C) | ±0.030 (+0.03/°C) |
| Transmission tracking | ±0.097 (+0.02/°C)  | ±0.091 (+0.02/°C) | ±0.140 (+0.02/°C) | ±0.145 (+0.03/°C) |

### Transmission uncertainty (specifications)

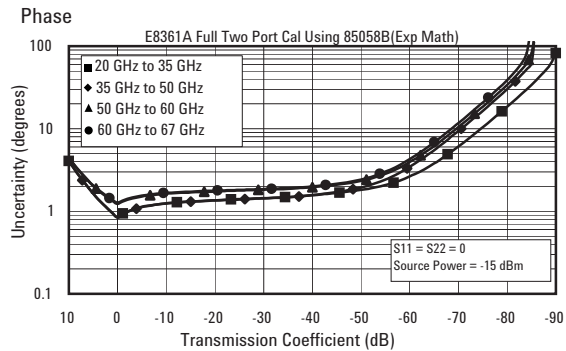
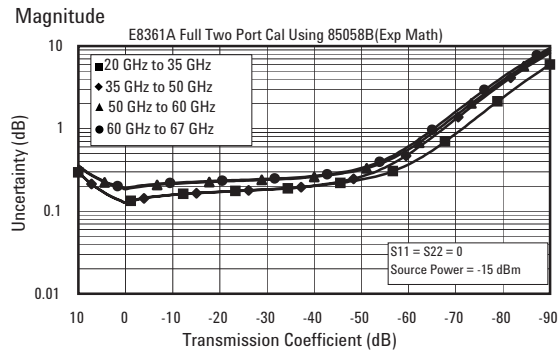

### Reflection uncertainty (specifications)

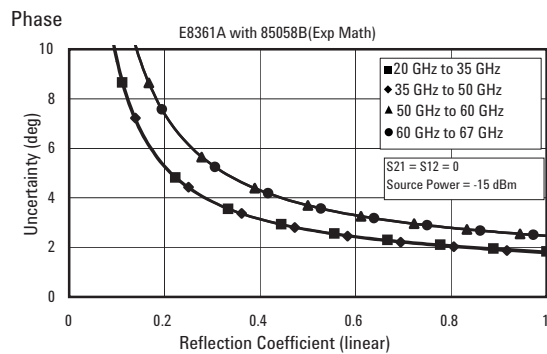
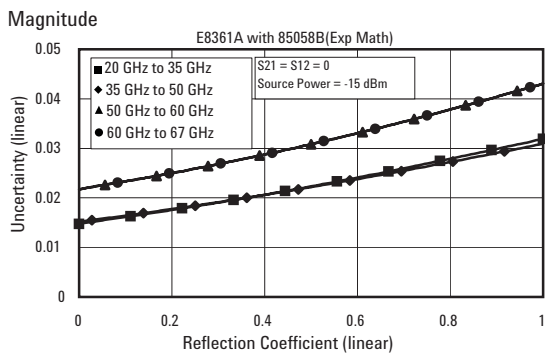

# E8361A

## Corrected system performance with 1.85 mm connectors *continued*

### Fully optioned (E8361A with options 014/UNL/080/081/016)

Applies to E8361A PNA Series analyzer, 85058B (1.85 mm) calibration kit, N4697F flexible test port cable set, and a full two-port calibration. (Specifications apply over environmental temperature of 23 °C ±3 °C, with less than 1 °C deviation from calibration temperature.)

| Description           | Specification (dB)            |                   |                   |                   |
|-----------------------|-------------------------------|-------------------|-------------------|-------------------|
|                       | 10 MHz to 45 MHz <sup>1</sup> | 45 MHz to 2 GHz   | 2 to 10 GHz       | 10 to 20 GHz      |
| Directivity           | 35                            | 35                | 41                | 38                |
| Source match          | 34                            | 34                | 44                | 40                |
| Load match            | 34                            | 35                | 41                | 37                |
| Reflection tracking   | ±0.019 (+0.02/°C)             | ±0.019 (+0.02/°C) | ±0.010 (+0.02/°C) | ±0.033 (+0.02/°C) |
| Transmission tracking | ±0.177 (+0.02/°C)             | ±0.093 (+0.02/°C) | ±0.053 (+0.02/°C) | ±0.096 (+0.02/°C) |

### Transmission uncertainty (specifications)

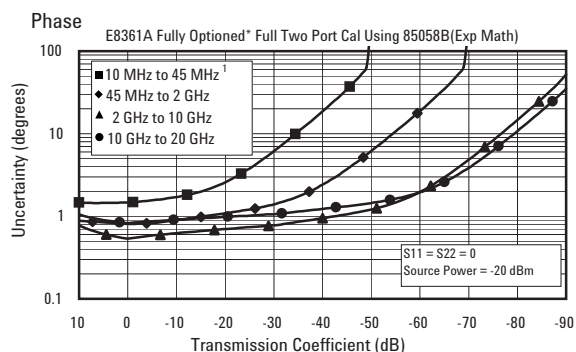
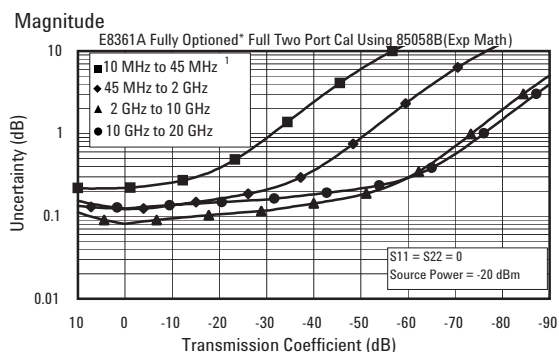

### Reflection uncertainty (specifications)

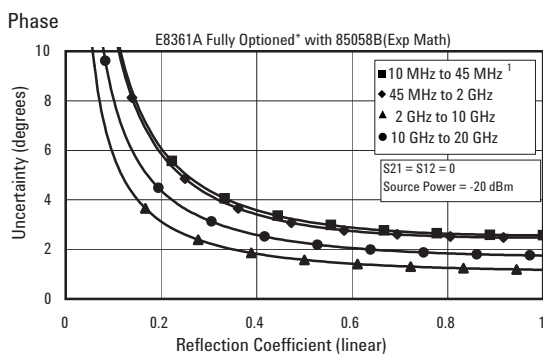
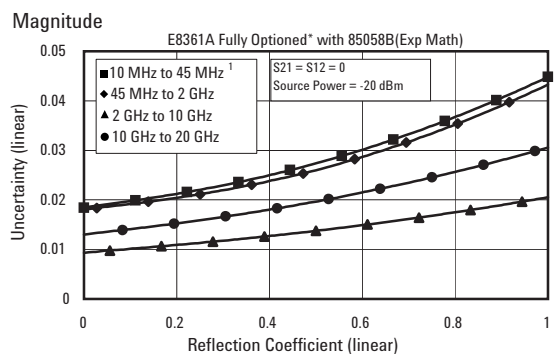

1. Typical performance.

\* Configurable Test Set, Extended Power Range and Bias-Tees, Receiver Attenuators, Frequency Offset Mode, and Reference Channel Transfer Switch (Option 014, UNL, 016, 080 and 081).

# E8361A

## Corrected system performance with 1.85 mm connectors *continued*

### Fully optioned (E8361A with options 014/UNL/080/081/016)

Applies to E8361A PNA Series analyzer, 85058B (1.85 mm) calibration kit, N4697F flexible test port cable set, and a full two-port calibration. (Specifications apply over environmental temperature of 23 °C ±3 °C, with less than 1 °C deviation from calibration temperature.)

| Description           | Specification (dB) |                   |                   |                   |
|-----------------------|--------------------|-------------------|-------------------|-------------------|
|                       | 20 to 35 GHz       | 35 to 50 GHz      | 50 to 60 GHz      | 60 to 67 GHz      |
| Directivity           | 37                 | 37                | 34                | 34                |
| Source match          | 41                 | 42                | 40                | 40                |
| Load match            | 36                 | 36                | 33                | 33                |
| Reflection tracking   | ±0.033 (+0.02/°C)  | ±0.020 (+0.02/°C) | ±0.030 (+0.02/°C) | ±0.030 (+0.03/°C) |
| Transmission tracking | ±0.084 (+0.02/°C)  | ±0.079 (+0.02/°C) | ±0.119 (+0.02/°C) | ±0.137 (+0.03/°C) |

### Transmission uncertainty (specifications)

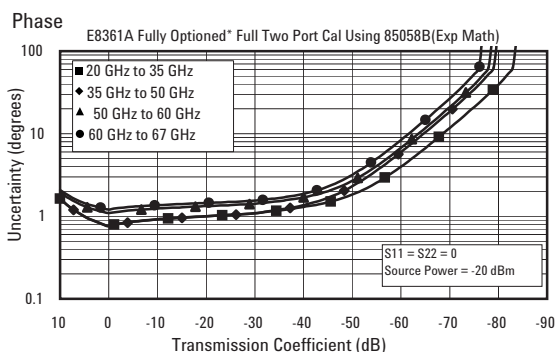
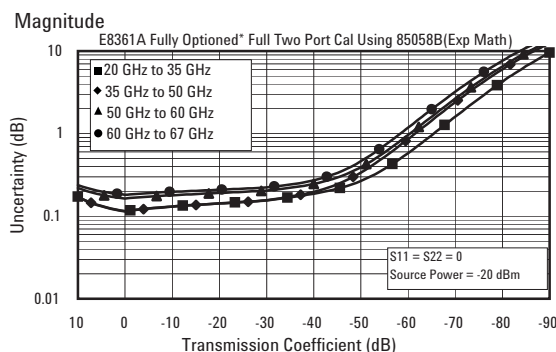

### Reflection uncertainty (specifications)

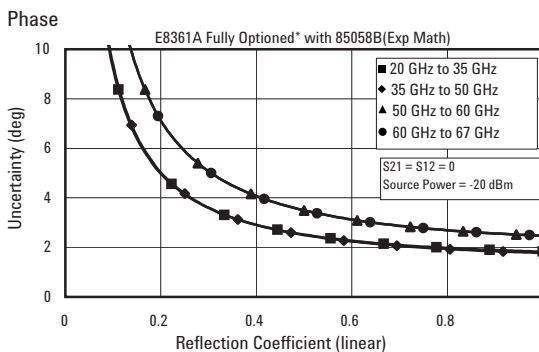
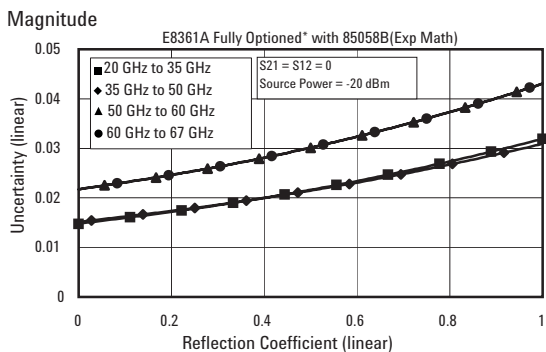

\* Configurable Test Set, Extended Power Range and Bias-Tees, Receiver Attenuators, Frequency Offset Mode, and Reference Channel Transfer Switch (Option 014, UNL, 016, 080 and 081).

# E8361A

## Corrected system performance with 2.4 mm connectors

### Standard configuration and standard power range (E8361A)

Applies to E8361A PNA Series analyzer, N4693A (2.4 mm) ECal electronic calibration module, 85133F flexible test port cable set, and a full two-port calibration. (Specifications apply over environmental temperature of 23 °C ±3 °C, with less than 1 °C deviation from calibration temperature.)

| Description           | Specification (dB) |                   |                   |                   |
|-----------------------|--------------------|-------------------|-------------------|-------------------|
|                       | 45 MHz to 2 GHz    | 2 GHz to 20 GHz   | 20 to 40 GHz      | 40 to 50 GHz      |
| Directivity           | 55                 | 49                | 43                | 41                |
| Source match          | 46                 | 42                | 35                | 30                |
| Load match            | 43                 | 41                | 37                | 36                |
| Reflection tracking   | ±0.030 (+0.02/°C)  | ±0.040 (+0.02/°C) | ±0.060 (+0.02/°C) | ±0.080 (+0.03/°C) |
| Transmission tracking | ±0.059 (+0.02/°C)  | ±0.079 (+0.02/°C) | ±0.110 (+0.02/°C) | ±0.125 (+0.03/°C) |

### Transmission uncertainty (specifications)

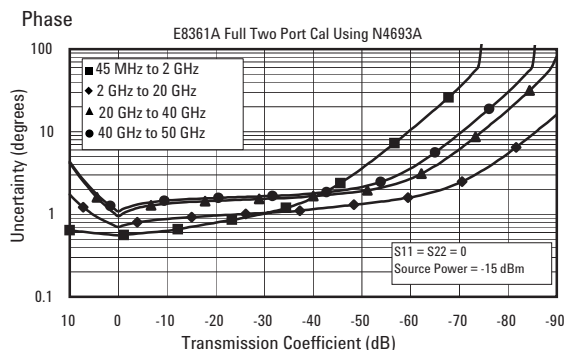
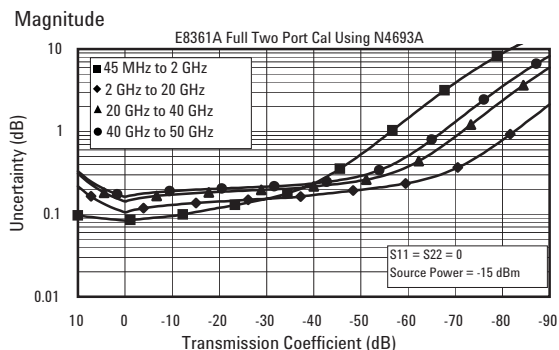

### Reflection uncertainty (specifications)

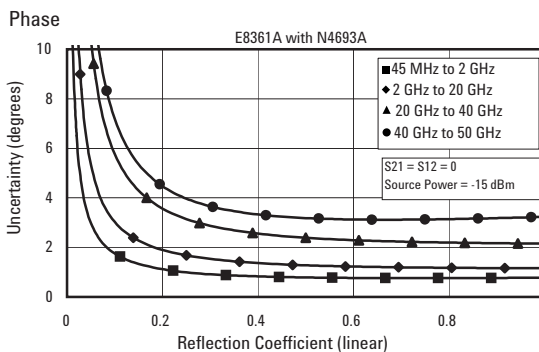
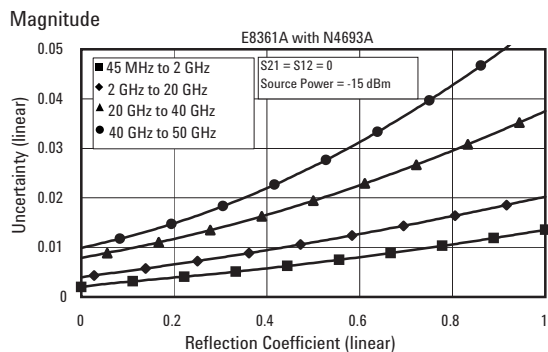

# E8361A

## Corrected system performance with 2.4 mm connectors *continued*

### Fully optioned (E8361A with options 014/UNL/080/081/016)

Applies to E8361A PNA Series analyzer, N4693A (2.4 mm) ECal electronic calibration module, 85133F flexible test port cable set, and a full two-port calibration. (Specifications apply over environmental temperature of 23 °C ±3 °C, with less than 1 °C deviation from calibration temperature.)

| Description           | Specification (dB) |                   |                   |                   |
|-----------------------|--------------------|-------------------|-------------------|-------------------|
|                       | 45 MHz to 2 GHz    | 2 GHz to 20 GHz   | 20 to 40 GHz      | 40 to 50 GHz      |
| Directivity           | 55                 | 49                | 43                | 41                |
| Source match          | 46                 | 42                | 35                | 30                |
| Load match            | 43                 | 41                | 37                | 36                |
| Reflection tracking   | ±0.030 (+0.02/°C)  | ±0.040 (+0.02/°C) | ±0.060 (+0.02/°C) | ±0.080 (+0.03/°C) |
| Transmission tracking | ±0.060 (+0.02/°C)  | ±0.082 (+0.02/°C) | ±0.106 (+0.02/°C) | ±0.121 (+0.03/°C) |

### Transmission uncertainty (specifications)

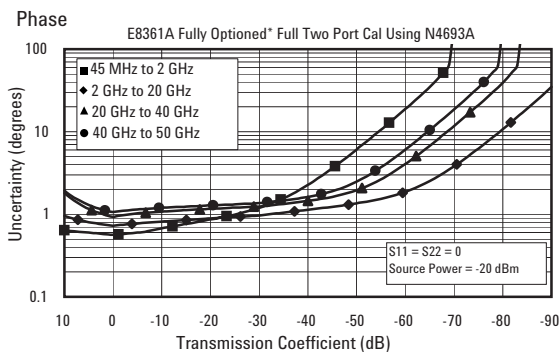
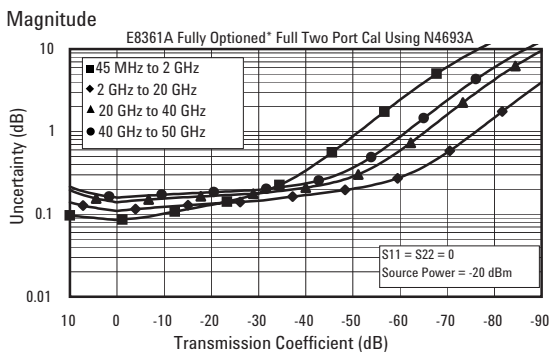

### Reflection uncertainty (specifications)

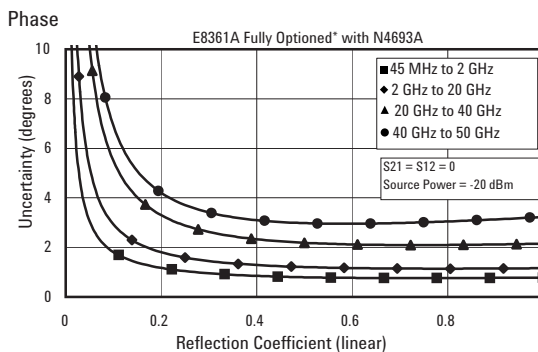
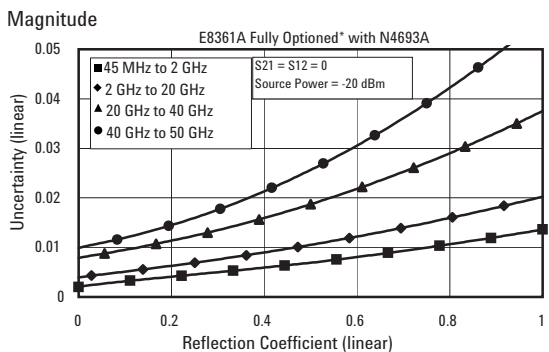

\* Configurable Test Set, Extended Power Range and Bias-Tees, Receiver Attenuators, Frequency Offset Mode, and Reference Channel Transfer Switch (Option 014, UNL, 016, 080 and 081).

# E8361A

## Corrected system performance with 2.4 mm connectors *continued*

### Standard configuration and standard power range (E8361A)

Applies to E8361A PNA Series analyzer, 85056A (2.4 mm) calibration kit, 85133F flexible test port cable set, and a full two-port calibration. (Specifications apply over environmental temperature of 23 °C ±3 °C, with less than 1 °C deviation from calibration temperature.)

| Description           | Specification (dB) |                   |                   |                   |
|-----------------------|--------------------|-------------------|-------------------|-------------------|
|                       | 45 MHz to 2 GHz    | 2 GHz to 20 GHz   | 20 to 40 GHz      | 40 to 50 GHz      |
| Directivity           | 42                 | 42                | 38                | 36                |
| Source match          | 41                 | 38                | 33                | 31                |
| Load match            | 42                 | 42                | 37                | 35                |
| Reflection tracking   | ±0.001 (+0.02/°C)  | ±0.008 (+0.02/°C) | ±0.020 (+0.02/°C) | ±0.027 (+0.03/°C) |
| Transmission tracking | ±0.035 (+0.02/°C)  | ±0.060 (+0.02/°C) | ±0.146 (+0.02/°C) | ±0.181 (+0.03/°C) |

### Transmission uncertainty (specifications)

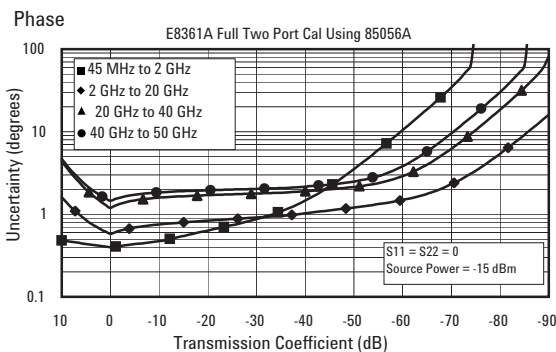
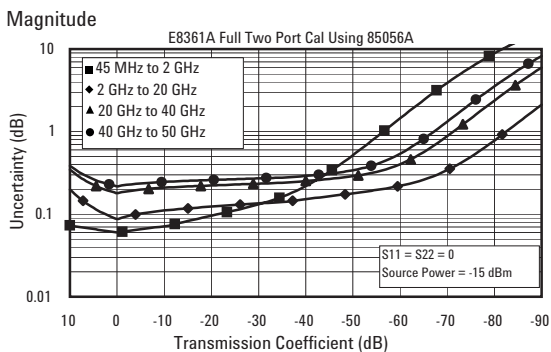

### Reflection uncertainty (specifications)

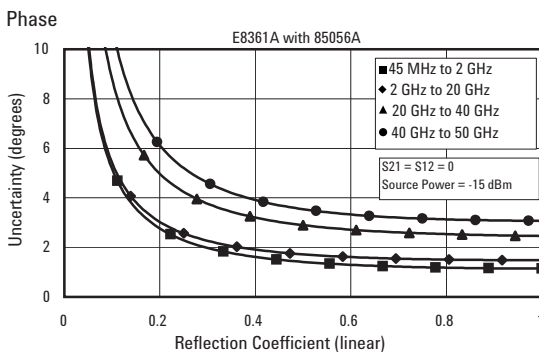
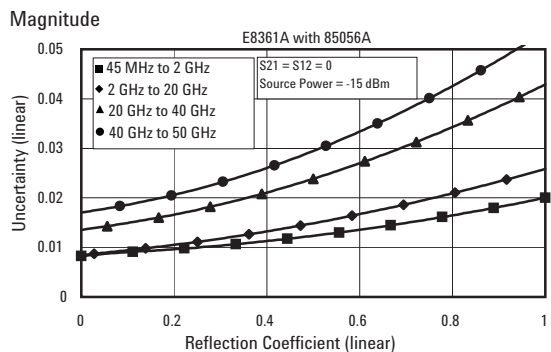

1. Typical performance.

# E8361A

## Corrected system performance with 2.4 mm connectors *continued*

### Fully optioned (E8361A with options 014/UNL/080/081/016)

Applies to E8361A PNA Series analyzer, 85056A (2.4 mm) calibration kit, 85133F flexible test port cable set, and a full two-port calibration. (Specifications apply over environmental temperature of 23 °C ±3 °C, with less than 1 °C deviation from calibration temperature.)

| Description           | Specification (dB) |                   |                   |                   |
|-----------------------|--------------------|-------------------|-------------------|-------------------|
|                       | 45 MHz to 2 GHz    | 2 GHz to 20 GHz   | 20 to 40 GHz      | 40 to 50 GHz      |
| Directivity           | 42                 | 42                | 38                | 36                |
| Source match          | 41                 | 38                | 33                | 31                |
| Load match            | 42                 | 41                | 37                | 35                |
| Reflection tracking   | ±0.001 (+0.02/°C)  | ±0.008 (+0.02/°C) | ±0.020 (+0.02/°C) | ±0.027 (+0.03/°C) |
| Transmission tracking | ±0.040 (+0.02/°C)  | ±0.086 (+0.02/°C) | ±0.123 (+0.02/°C) | ±0.155 (+0.03/°C) |

### Transmission uncertainty (specifications)

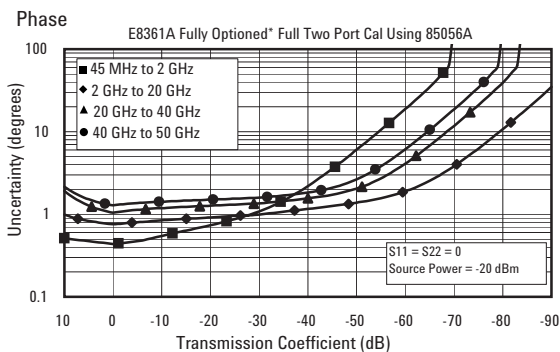
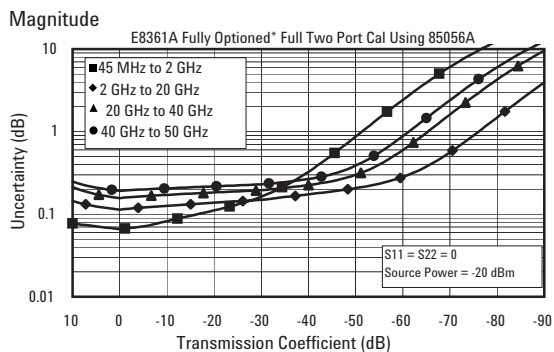

### Reflection uncertainty (specifications)

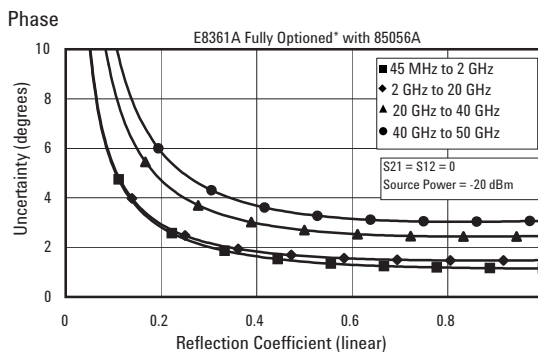
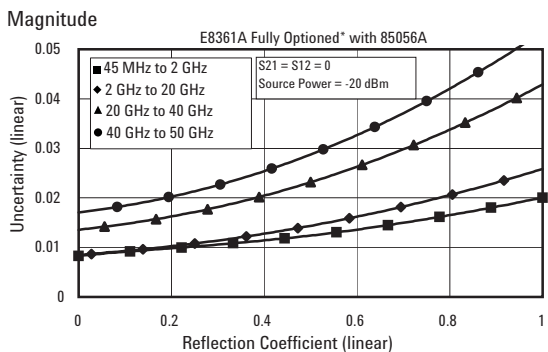

\* Configurable Test Set, Extended Power Range and Bias-Tees, Receiver Attenuators, Frequency Offset Mode, and Reference Channel Transfer Switch (Option 014, UNL, 016, 080 and 081).



# E8361A

## Uncorrected system performance<sup>1</sup>

| Description                              | Specification | Typical |
|--|---------------|---------|
| <b>Directivity</b>                       |               |         |
| 10 to 45 MHz <sup>2</sup>                | 22 dB         | 22 dB   |
| 45 MHz to 2 GHz                          | 24 dB         | 27 dB   |
| 2 to 10 GHz                              | 20 dB         | 24 dB   |
| 10 to 20 GHz                             | 16 dB         | 20 dB   |
| 20 to 30 GHz                             | 14 dB         | 17 dB   |
| 30 to 50 GHz                             | 13 dB         | 17 dB   |
| 50 to 60 GHz                             | 13 dB         | 17 dB   |
| 60 to 67 GHz                             | 10 dB         | 18 dB   |
| 67 to 70 GHz <sup>2</sup>                | 14 dB         | 14 dB   |
| <b>Source match - standard</b>           |               |         |
| 10 to 45 MHz <sup>2</sup>                | 7 dB          | 7 dB    |
| 45 MHz to 2 GHz                          | 18 dB         | 23 dB   |
| 2 to 10 GHz                              | 14 dB         | 18 dB   |
| 10 to 20 GHz                             | 12 dB         | 15 dB   |
| 20 to 30 GHz                             | 8 dB          | 11.5 dB |
| 30 to 40 GHz                             | 7.5 dB        | 10 dB   |
| 40 to 45 GHz                             | 8 dB          | 11 dB   |
| 45 to 50 GHz                             | 7 dB          | 10 dB   |
| 50 to 60 GHz                             | 6 dB          | 8.5 dB  |
| 60 to 67 GHz                             | 5.5 dB        | 7.5 dB  |
| 67 to 70 GHz <sup>2</sup>                | 7.5 dB        | 7.5 dB  |
| <b>Source match - Option 014</b>         |               |         |
| 10 to 45 MHz <sup>2</sup>                | 7 dB          | 7 dB    |
| 45 MHz to 2 GHz                          | 17 dB         | 21 dB   |
| 2 to 10 GHz                              | 12 dB         | 17 dB   |
| 10 to 20 GHz                             | 11 dB         | 14 dB   |
| 20 to 30 GHz                             | 10 dB         | 13 dB   |
| 30 to 40 GHz                             | 8.5 dB        | 11 dB   |
| 40 to 45 GHz                             | 8.5 dB        | 11 dB   |
| 45 to 50 GHz                             | 8.5 dB        | 11.5 dB |
| 50 to 60 GHz                             | 6.5 dB        | 9 dB    |
| 60 to 67 GHz                             | 6 dB          | 8.5 dB  |
| 67 to 70 GHz <sup>2</sup>                | 8.5 dB        | 8.5 dB  |
| <b>Source match - Option 014 and UNL</b> |               |         |
| 10 to 45 MHz <sup>2</sup>                | 5 dB          | 5 dB    |
| 45 MHz to 2 GHz                          | 15 dB         | 20 dB   |
| 2 to 10 GHz                              | 9 dB          | 13 dB   |
| 10 to 20 GHz                             | 7.5 dB        | 10.5 dB |
| 20 to 30 GHz                             | 8.5 dB        | 11 dB   |
| 30 to 40 GHz                             | 8 dB          | 11 dB   |
| 40 to 45 GHz                             | 8.5 dB        | 12 dB   |
| 45 to 50 GHz                             | 8 dB          | 12 dB   |
| 50 to 60 GHz                             | 7 dB          | 11 dB   |
| 60 to 67 GHz                             | 6 dB          | 10 dB   |
| 67 to 70 GHz <sup>2</sup>                | 10 dB         | 10 dB   |
| <b>Load match - standard</b>             |               |         |
| 10 to 45 MHz <sup>2</sup>                | 5.5 dB        | 5.5 dB  |
| 45 MHz to 2 GHz                          | 9 dB          | 10 dB   |
| 2 to 10 GHz                              | 9 dB          | 11 dB   |
| 10 to 20 GHz                             | 8.5 dB        | 10 dB   |
| 20 to 30 GHz                             | 7 dB          | 9 dB    |
| 30 to 40 GHz                             | 6 dB          | 8 dB    |
| 40 to 45 GHz                             | 6.5 dB        | 9 dB    |
| 45 to 50 GHz                             | 6.5 dB        | 8.5 dB  |
| 50 to 60 GHz                             | 5.5 dB        | 7.5 dB  |
| 60 to 67 GHz                             | 5.5 dB        | 7.5 dB  |
| 67 to 70 GHz <sup>2</sup>                | 5 dB          | 5 dB    |

1. Specifications apply over environment temperature of 23 °C ± 3 °C, with less than 1 °C deviation from the calibration temperature.

2. Typical performance.

# E8361A

## Uncorrected system performance<sup>1</sup> *continued*

| Description                            | Specification | Typical |
|--|---------------|---------|
| <b>Load match - Option 014</b>         |               |         |
| 10 to 45 MHz <sup>2</sup>              | 5.5 dB        | 5.5 dB  |
| 45 MHz to 2 GHz                        | 8.5 dB        | 10 dB   |
| 2 to 10 GHz                            | 8 dB          | 10 dB   |
| 10 to 20 GHz                           | 8 dB          | 10 dB   |
| 20 to 30 GHz                           | 7.5 dB        | 10 dB   |
| 30 to 40 GHz                           | 7 dB          | 9.5 dB  |
| 40 to 45 GHz                           | 7.5 dB        | 9.5 dB  |
| 45 to 50 GHz                           | 7.5 dB        | 10 dB   |
| 50 to 60 GHz                           | 6 dB          | 8.5 dB  |
| 60 to 67 GHz                           | 6 dB          | 8.5 dB  |
| 67 to 70 GHz <sup>2</sup>              | 5 dB          | 5 dB    |
| <b>Load match - Option 014 and UNL</b> |               |         |
| 10 to 45 MHz <sup>2</sup>              | 6 dB          | 6 dB    |
| 45 MHz to 2 GHz                        | 8.5 dB        | 10 dB   |
| 2 to 10 GHz                            | 7 dB          | 9 dB    |
| 10 to 20 GHz                           | 6 dB          | 9 dB    |
| 20 to 30 GHz                           | 7.5 dB        | 11 dB   |
| 30 to 40 GHz                           | 8 dB          | 11.5 dB |
| 40 to 45 GHz                           | 8 dB          | 12 dB   |
| 45 to 50 GHz                           | 8 dB          | 12 dB   |
| 50 to 60 GHz                           | 7.5 dB        | 11.5 dB |
| 60 to 67 GHz                           | 6 dB          | 10 dB   |
| 67 to 70 GHz <sup>2</sup>              | 13 dB         | 13 dB   |

1. Specifications apply over environment temperature of 23 °C ± 3 °C, with less than 1 °C deviation from the calibration temperature.

2. Typical performance.

# E8361A

## Uncorrected system performance<sup>1</sup> *continued*

| Description                               | Specification | Supplemental information   |
|---|---------------|--|
| <b>Reflection tracking</b>                |               | Typical:   |
| 10 to 45 MHz                              |               | ±1.5 dB  |
| 45 MHz to 20 GHz                          |               | ±1.5 dB  |
| 20 to 40 GHz                              |               | ±2.0 dB  |
| 40 to 50 GHz                              |               | ±2.0 dB  |
| 50 to 67 GHz                              |               | ±3.0 dB  |
| 67 to 70 GHz                              |               | ±4.5 dB  |
| <b>Transmission tracking<sup>3</sup></b>  |               | Typical:   |
| 10 to 45 MHz                              |               | ±1.5 dB  |
| 45 MHz to 20 GHz                          |               | ±1.5 dB  |
| 20 to 40 GHz                              |               | ±2.0 dB  |
| 40 to 50 GHz                              |               | ±2.0 dB  |
| 50 to 67 GHz                              |               | ±3.0 dB  |
| 67 to 70 GHz                              |               | ±4.5 dB  |
| <b>Crosstalk<sup>4</sup> - standard</b>   |               |  |
| 10 to 45 MHz <sup>2</sup>                 | 63 dB         |  |
| 45 to 500 MHz                             | 87 dB         |  |
| 500 MHz to 2 GHz                          | 110 dB        |  |
| 2 to 10 GHz                               | 105 dB        |  |
| 10 to 24 GHz                              | 111 dB        |  |
| 24 to 30 GHz                              | 106 dB        |  |
| 30 to 40 GHz                              | 104 dB        |  |
| 40 to 45 GHz                              | 98 dB         |  |
| 45 to 50 GHz                              | 100 dB        |  |
| 50 to 60 GHz                              | 97 dB         |  |
| 60 to 67 GHz                              | 94 dB         |  |
| 67 to 70 GHz <sup>2</sup>                 | 94 dB         |  |
| <b>Crosstalk<sup>4</sup> - Option 014</b> |               | Typical (for Option 080 enabled <sup>5</sup> )                         |
| 10 to 45 MHz <sup>2</sup>                 | 63 dB         | 63 dB  |
| 45 to 500 MHz                             | 87 dB         | 87 dB  |
| 500 MHz to 2 GHz                          | 110 dB        | 110 dB   |
| 2 to 10 GHz                               | 105 dB        | 105 dB   |
| 10 to 24 GHz                              | 111 dB        | 111 dB   |
| 24 to 30 GHz                              | 104 dB        | 104 dB   |
| 30 to 40 GHz                              | 102 dB        | 102 dB   |
| 40 to 45 GHz                              | 96 dB         | 96 dB  |
| 45 to 50 GHz                              | 98 dB         | 98 dB  |
| 50 to 60 GHz                              | 95 dB         | 95 dB  |
| 60 to 67 GHz                              | 90 dB         | 90 dB  |
| 67 to 70 GHz <sup>2</sup>                 | 90 dB         | 90 dB  |
| <b>Crosstalk - Option 014 and UNL</b>     |               | Typical (for Option UNL and Option 014 with 080 enabled <sup>5</sup> ) |
| 10 to 45 MHz <sup>2</sup>                 | 63 dB         | 63 dB  |
| 45 to 500 MHz                             | 87 dB         | 87 dB  |
| 500 MHz to 2 GHz                          | 110 dB        | 110 dB   |
| 2 to 10 GHz                               | 104 dB        | 104 dB   |
| 10 to 24 GHz                              | 108 dB        | 108 dB   |
| 24 to 30 GHz                              | 101 dB        | 101 dB   |
| 30 to 40 GHz                              | 99 dB         | 99 dB  |
| 40 to 45 GHz                              | 92 dB         | 92 dB  |
| 45 to 50 GHz                              | 94 dB         | 94 dB  |
| 50 to 60 GHz                              | 91 dB         | 91 dB  |
| 60 to 67 GHz                              | 84 dB         | 84 dB  |
| 67 to 70 GHz <sup>2</sup>                 | 84 dB         | 84 dB  |

1. Specifications apply over environment temperature of 23 °C ± 3 °C, with less than 1 °C deviation from the calibration temperature.  
 2. Typical performance.  
 3. Transmission tracking performance noted here is normalized to the insertion loss characteristics of the cable used, so that the indicated performance is independent of cable used.

4. Measurement conditions: Normalized to a thru, measured with two shorts, 10-Hz IF bandwidth, averaging factor of 16, alternate mode, source power set to the lesser of the maximum power out or the maximum receiver power.  
 5. 0 Hz offset.

# E8361A

## Test port output

| Description  | Specification Standard | Option 014                                | Option UNL and Option 014 | Supplemental information   |
|--|------------------------|---|---------------------------|--|
| <b>Frequency range</b><br>E8361A   |                        | 10 MHz to 67 GHz (Operation up to 70 GHz) |                           |  |
| <b>Nominal power</b> <sup>1</sup>  | -15 dBm                | -15 dBm                                   | -17 dBm                   |  |
| <b>Frequency resolution</b>  | 1 Hz                   | 1 Hz                                      | 1 Hz                      |  |
| <b>CW accuracy</b>   | ± 1 ppm                | ± 1 ppm                                   | ± 1 ppm                   |  |
| <b>Frequency stability</b>   |                        |   |                           | ± 0.05 ppm -10 to 70 °C, typical<br>±0.1 ppm/yr maximum, typical                             |
| <b>Power level accuracy</b> <sup>2</sup>   |                        |   |                           |  |
| 10 to 45 MHz <sup>3</sup>  | ±1.5 dB                | ±1.5 dB                                   | ±1.5 dB                   | Variation from nominal power in range 0  |
| 45 MHz to 10 GHz   | ±1.5 dB                | ±1.5 dB                                   | ±1.5 dB                   |  |
| 10 to 20 GHz   | ±1.5 dB                | ±1.5 dB                                   | ±2.0 dB                   |  |
| 20 to 30 GHz   | ±2.0 dB                | ±2.0 dB                                   | ±2.5 dB                   |  |
| 30 to 40 GHz   | ±3.0 dB                | ±3.0 dB                                   | ±3.0 dB                   |  |
| 40 to 45 GHz   | ±3.0 dB                | ±3.0 dB                                   | ±3.0 dB                   |  |
| 45 to 50 GHz   | ±3.5 dB                | ±3.5 dB                                   | ±3.5 dB                   |  |
| 50 to 60 GHz   | ±4.0 dB                | ±4.0 dB                                   | ±4.0 dB                   |  |
| 60 to 67 GHz   | ±4.0 dB                | ±4.0 dB                                   | ±4.5 dB                   |  |
| 67 to 70 GHz <sup>3</sup>  | ±4.0 dB                | ±4.0 dB                                   | ±4.5 dB                   |  |
| <b>Power level linearity</b> <sup>4</sup>  |                        |   |                           |  |
| 10 to 45 MHz <sup>3</sup>  | ±1.0 dB <sup>5</sup>   | ±1.0 dB <sup>5</sup>                      | ±1.0 dB <sup>5</sup>      | For power ≤ -5 dBm<br>Test reference is at the nominal power level (step attenuator at 0 dB) |
| 45 MHz to 67 GHz   | ±1.0 dB <sup>5</sup>   | ±1.0 dB <sup>5</sup>                      | ±1.0 dB <sup>5</sup>      |  |
| 67 to 70 GHz <sup>3</sup>  | ±1.0 dB <sup>5</sup>   | ±1.0 dB <sup>5</sup>                      | ±1.0 dB <sup>5</sup>      |  |
| <b>Power range</b> <sup>2, 6, 7</sup>  |                        |   |                           |  |
| <b>Note:</b> If the power is set above maximum specified leveled power, the test port output signal may show non-linear effects that are dependent on the DUT. |                        |   |                           |  |
| 10 to 45 MHz <sup>3</sup>  | -25 to -9 dBm          | -25 to -9 dBm                             | -75 to -9 dBm             |  |
| 45 to 500 MHz  | -25 to -3 dBm          | -25 to -3 dBm                             | -75 to -3 dBm             |  |
| 500 to 750 MHz   | -25 to 0 dBm           | -25 to 0 dBm                              | -75 to 0 dBm              |  |
| 750 MHz to 10 GHz  | -27 to -1 dBm          | -27 to -1 dBm                             | -77 to -1 dBm             |  |
| 10 to 30 GHz   | -27 to -2 dBm          | -27 to -3 dBm                             | -77 to -3 dBm             |  |
| 30 to 40 GHz   | -27 to -1 dBm          | -27 to -2 dBm                             | -77 to -5 dBm             |  |
| 40 to 45 GHz   | -27 to -7 dBm          | -27 to -8 dBm                             | -77 to -10 dBm            |  |
| 45 to 50 GHz   | -27 to -1 dBm          | -27 to -2 dBm                             | -77 to -6 dBm             |  |
| 50 to 60 GHz   | -27 to -3 dBm          | -27 to -4 dBm                             | -77 to -8 dBm             |  |
| 60 to 67 GHz   | -27 to -5 dBm          | -27 to -7 dBm                             | -77 to -13 dBm            |  |
| 67 to 70 GHz <sup>3</sup>  | -27 to -5 dBm          | -27 to -7 dBm                             | -77 to -13 dBm            |  |
| <b>Power sweep range (ALC)</b>   |                        |   |                           |  |
| 10 to 45 MHz <sup>3</sup>  | 16 dB                  | 16 dB                                     | 16 dB                     | ALC range starts at maximum leveled output power and decreases by the dB amount specified    |
| 45 to 500 MHz  | 22 dB                  | 22 dB                                     | 22 dB                     |  |
| 500 to 750 MHz   | 25 dB                  | 25 dB                                     | 25 dB                     |  |
| 750 MHz to 10 GHz  | 26 dB                  | 26 dB                                     | 26 dB                     |  |
| 10 to 30 GHz   | 25 dB                  | 24 dB                                     | 24 dB                     |  |
| 30 to 40 GHz   | 26 dB                  | 25 dB                                     | 22 dB                     |  |
| 40 to 45 GHz   | 20 dB                  | 19 dB                                     | 17 dB                     |  |
| 45 to 50 GHz   | 26 dB                  | 25 dB                                     | 21 dB                     |  |
| 50 to 60 GHz   | 24 dB                  | 23 dB                                     | 19 dB                     |  |
| 60 to 67 GHz   | 22 dB                  | 20 dB                                     | 14 dB                     |  |
| 67 to 70 GHz <sup>3</sup>  | 22 dB                  | 20 dB                                     | 14 dB                     |  |
| <b>Power resolution</b>  | 0.01 dB                | 0.01 dB                                   |                           |  |

1. Preset power.

2. Test port output is a specification when the source is set to port 1, and a characteristic when the source is set to port 2.

3. Typical performance.

4. Power level linearity is a specification when the source is set to port 1, and a typical when the source is set to port 2.

5. ±1.6 dB for power > -5 dBm.

6. Power to which the source can be set and phase lock is assured.

7. Test port is specified into a nominal 50 Ω.

# E8361A

## Test port output *continued*

| Description   | Specification | Supplemental information                         |
|---|---------------|--|
| <b>Phase noise (10 kHz offset from center frequency, nominal power at test port)</b>                |               |  |
| 10 MHz to 45 MHz  |               | 80 dBc typical                                   |
| 45 MHz to 10 GHz  |               | 70 dBc typical                                   |
| 10 to 24 GHz  |               | 60 dBc typical                                   |
| 24 to 70 GHz  |               | 55 dBc typical                                   |
| <b>Phase noise (10 kHz from center frequency, nominal power at test port) – Option 080 enabled</b>  |               |  |
| 10 to 45 MHz  |               | 80 dBc, typical                                  |
| 45 MHz to 10 GHz  |               | 70 dBc, typical                                  |
| 10 to 24 GHz  |               | 60 dBc, typical                                  |
| 24 to 70 GHz  |               | 55 dBc, typical                                  |
| <b>Phase noise (100 kHz from center frequency, nominal power at test port)</b>                      |               |  |
| 10 to 45 MHz  |               | 90 dBc, typical                                  |
| 45 MHz to 10 GHz  |               | 90 dBc, typical                                  |
| 10 to 24 GHz  |               | 85 dBc, typical                                  |
| 24 to 70 GHz  |               | 75 dBc, typical                                  |
| <b>Phase noise (100 kHz from center frequency, nominal power at test port) – Option 080 enabled</b> |               |  |
| 10 to 45 MHz  |               | 85 dBc, typical                                  |
| 45 MHz to 10 GHz  |               | 80 dBc, typical                                  |
| 10 to 24 GHz  |               | 70 dBc, typical                                  |
| 24 to 70 GHz  |               | 60 dBc, typical                                  |
| <b>Phase noise (1 MHz from center frequency, nominal power at test port)</b>                        |               |  |
| 10 to 45 MHz  |               | 115 dBc, typical                                 |
| 45 MHz to 10 GHz  |               | 110 dBc, typical                                 |
| 10 to 24 GHz  |               | 105 dBc, typical                                 |
| 24 to 70 GHz  |               | 95 dBc, typical                                  |
| <b>Phase noise (1 MHz from center frequency, nominal power at test port) – Option 080 enabled</b>   |               |  |
| 10 to 45 MHz  |               | 110 dBc, typical                                 |
| 45 MHz to 10 GHz  |               | 105 dBc, typical                                 |
| 10 to 24 GHz  |               | 95 dBc, typical                                  |
| 24 to 70 GHz  |               | 85 dBc, typical                                  |
| <b>Harmonics (2nd or 3rd)</b>   |               |  |
| 10 to 500 MHz   |               | 10 dBc typical, in power                         |
| 500 MHz to 10 GHz   |               | 15 dBc typical, in power                         |
| 10 to 24 GHz  |               | 23 dBc typical, in power                         |
| 24 to 50 GHz  |               | 16 dBc typical, in power                         |
| 50 to 60 GHz  |               | 13 dBc typical, in power                         |
| 60 to 70 GHz  |               | 19 dBc typical, in power                         |
| <b>Non-harmonic spurious (at nominal output power)</b>  |               |  |
| 10 MHz to 20 GHz  |               | -50 dBc typical, for offset<br>frequency > 1 kHz |
| 20 MHz to 70 GHz  |               | -30 dBc typical, for offset<br>frequency > 1 kHz |

# E8361A

## Test port input

| Description  | Specification Standard | Option 014 or Option UNL and 014 | Option 016 | Supplemental information                |
|--|------------------------|----------------------------------|------------|---|
| <b>Test port noise floor <sup>1</sup></b>  |                        |                                  |            | <b>080 enabled,<sup>5</sup> typical</b> |
| <b>10 Hz IF bandwidth</b>  |                        |                                  |            |   |
| 10 to 45 MHz <sup>3</sup>  | < -70 dBm              | < -70 dBm                        | < -70 dBm  | < -70 dBm                               |
| 45 to 500 MHz <sup>2, 4</sup>  | < -90 dBm              | < -90 dBm                        | < -90 dBm  | < -90 dBm                               |
| 500 MHz to 2 GHz   | < -112 dBm             | < -112 dBm                       | < -112 dBm | < -112 dBm                              |
| 2 to 10 GHz  | < -112 dBm             | < -112 dBm                       | < -112 dBm | < -112 dBm                              |
| 10 to 24 GHz   | < -116 dBm             | < -115 dBm                       | < -115 dBm | < -115 dBm                              |
| 24 to 30 GHz   | < -105 dBm             | < -104 dBm                       | < -102 dBm | < -104 dBm                              |
| 30 to 40 GHz   | < -105 dBm             | < -104 dBm                       | < -102 dBm | < -104 dBm                              |
| 40 to 45 GHz   | < -103 dBm             | < -102 dBm                       | < -100 dBm | < -102 dBm                              |
| 45 to 50 GHz   | < -101 dBm             | < -100 dBm                       | < -98 dBm  | < -100 dBm                              |
| 50 to 60 GHz   | < -100 dBm             | < -99 dBm                        | < -97 dBm  | < -99 dBm                               |
| 60 to 67 GHz   | < -99 dBm              | < -97 dBm                        | < -94 dBm  | < -97 dBm                               |
| 67 to 70 GHz <sup>3</sup>  | < -99 dBm              | < -97 dBm                        | < -94 dBm  | < -97 dBm                               |
| <div style="display: flex; align-items: center;"> <div style="flex: 1;"> <p style="margin: 0;">} Option 016 degrades performance by 2 dB.</p> <p style="margin: 0;">} Option 016 degrades performance by 3 dB.</p> </div> </div> |                        |                                  |            |   |
| <b>1 kHz IF bandwidth</b>  |                        |                                  |            |   |
| 10 to 45 MHz <sup>3</sup>  | < -50 dBm              | < -50 dBm                        | < -50 dBm  | < -50 dBm                               |
| 45 to 500 MHz <sup>2, 4</sup>  | < -70 dBm              | < -70 dBm                        | < -70 dBm  | < -70 dBm                               |
| 500 MHz to 2 GHz   | < -92 dBm              | < -92 dBm                        | < -92 dBm  | < -92 dBm                               |
| 2 to 10 GHz  | < -92 dBm              | < -92 dBm                        | < -92 dBm  | < -92 dBm                               |
| 10 to 24 GHz   | < -96 dBm              | < -95 dBm                        | < -95 dBm  | < -95 dBm                               |
| 24 to 30 GHz   | < -85 dBm              | < -84 dBm                        | < -82 dBm  | < -84 dBm                               |
| 30 to 40 GHz   | < -85 dBm              | < -84 dBm                        | < -82 dBm  | < -84 dBm                               |
| 40 to 45 GHz   | < -83 dBm              | < -82 dBm                        | < -80 dBm  | < -82 dBm                               |
| 45 to 50 GHz   | < -81 dBm              | < -80 dBm                        | < -78 dBm  | < -80 dBm                               |
| 50 to 60 GHz   | < -80 dBm              | < -79 dBm                        | < -77 dBm  | < -79 dBm                               |
| 60 to 67 GHz   | < -79 dBm              | < -77 dBm                        | < -74 dBm  | < -77 dBm                               |
| 67 to 70 GHz <sup>3</sup>  | < -79 dBm              | < -77 dBm                        | < -74 dBm  | < -77 dBm                               |
| <div style="display: flex; align-items: center;"> <div style="flex: 1;"> <p style="margin: 0;">} Option 016 degrades performance by 2 dB.</p> <p style="margin: 0;">} Option 016 degrades performance by 3 dB.</p> </div> </div> |                        |                                  |            |   |

1. Total average (rms) noise power calculated as mean value of a linear magnitude trace expressed in dBm.

2. Noise floor may be degraded by 10 dB at particular frequencies (multiples of 5 MHz) due to spurious receiver residuals.

3. Typical performance.

4. Specified value is for worst-case noise floor at 45 MHz.

5. 0 Hz offset.

# E8361A

## Test port input *continued*

| Description   | Specification Standard | Option 014 or Option 014 and UNL (typ.) | Supplemental information  |
|---|------------------------|---|---|
| <b>Direct receiver access input noise floor<sup>1</sup></b> |                        |   |   |
| 10 Hz IF bandwidth  |                        |   |   |
| 10 to 45 MHz <sup>2</sup>                                   |                        | < -106 dBm                              | Online Help also includes the category "Direct receiver access input noise floor, Option 080 enabled" |
| 45 to 500 MHz <sup>4,5</sup>                                |                        | < -105 dBm                              |   |
| 500 MHz to 2 GHz  |                        | < -125.5 dBm                            |   |
| 2 to 10 GHz   |                        | < -125 dBm                              |   |
| 10 to 24 GHz  |                        | < -128 dBm                              |   |
| 24 to 30 GHz  |                        | < -117.5 dBm                            |   |
| 30 to 40 GHz  |                        | < -117 dBm                              |   |
| 40 to 45 GHz  |                        | < -115 dBm                              |   |
| 45 to 50 GHz  |                        | < -112.5 dBm                            |   |
| 50 to 60 GHz  |                        | < -111 dBm                              |   |
| 60 to 67 GHz  |                        | < -108 dBm                              | Option 016 degrades performance by 3 dB.  |
| 67 to 70 GHz <sup>2</sup>                                   |                        | < -107 dBm                              |   |
| 1 kHz IF bandwidth  |                        |   |   |
| 10 to 45 MHz <sup>2</sup>                                   |                        | < -86 dBm                               | Option 016 degrades performance by 2 dB.  |
| 45 to 500 MHz <sup>4,5</sup>                                |                        | < -85 dBm                               |   |
| 500 MHz to 2 GHz  |                        | < -105.5 dBm                            |   |
| 2 to 10 GHz   |                        | < -105 dBm                              |   |
| 10 to 24 GHz  |                        | < -108 dBm                              |   |
| 24 to 30 GHz  |                        | < -97.5 dBm                             |   |
| 30 to 40 GHz  |                        | < -97 dBm                               |   |
| 40 to 45 GHz  |                        | < -95 dBm                               |   |
| 45 to 50 GHz  |                        | < -92.5 dBm                             |   |
| 50 to 60 GHz  |                        | < -91 dBm                               |   |
| 60 to 67 GHz  |                        | < -88 dBm                               | Option 016 degrades performance by 3 dB.  |
| 67 to 70 GHz <sup>2</sup>                                   |                        | < -87 dBm                               |   |

| Description   | Specification  |  |  | Supplemental  |
|---|--|--|--|---|
| Receiver compression level (measured at Test Ports) |  |  |  |   |
|   | Specifications   |  |  | Supplemental Information  |
|   | Standard   | Option 014   | Option 014 and UNL   | Typical   |
| 10 to 45 MHz <sup>2,3</sup>                         | negligible   | negligible   | negligible   | negligible  |
| 45 to 500 MHz <sup>3,6</sup>                        | <0.1 dB at -9.5 dBm <sup>7</sup><br>and <0.25 dB at -3 dBm   | <0.1 dB at -9.5 dBm <sup>7</sup><br>and <0.25 dB at -3 dBm | <0.1 dB at -9.5 dBm <sup>7</sup><br>and <0.25 dB at -3 dBm | <0.1 dB at +0.5 dBm <sup>7</sup><br>and <0.25 dB at +8 dBm              |
| 500 MHz to 5 GHz                                    | <0.1 dB at -8 dBm <sup>7</sup><br>and <0.25 dB at -1 dBm     | <0.1 dB at -8 dBm <sup>7</sup><br>and <0.25 dB at -1 dBm   | <0.1 dB at -7 dBm <sup>7</sup><br>and <0.25 dB at 0 dBm    | <0.1 dB at -4 dBm <sup>7</sup><br>and <0.25 dB at +3 dBm                |
| 5 to 30 GHz   | <0.1 dB at -8.5 dBm <sup>7</sup><br>and <0.25 dB at -2 dBm   | <0.1 dB at -8.5 dBm <sup>7</sup><br>and <0.25 dB at -2 dBm | <0.1 dB at -6 dBm <sup>7</sup><br>and <0.25 dB at +1 dBm   | <0.1 dB at -1 dBm <sup>7</sup><br>and <0.25 dB at +6 dBm                |
| 30 to 67 GHz  | < 0.1 dB at -10.5 dBm <sup>7</sup><br>and <0.15 dB at -7 dBm | < 0.1 dB at -8 dBm <sup>7</sup><br>and <0.15 dB at -4 dBm  | <0.1 dB at -9.5 dBm <sup>7</sup><br>and <0.15 dB at -6 dBm | <0.1 dB at -2 dBm <sup>7,8</sup><br>and <0.15 dB at +2 dBm <sup>8</sup> |
| 67 to 70 GHz <sup>2</sup>                           |  |  |  | <0.1 dB at -2 dBm <sup>7,8</sup><br>and <0.15 dB at +2 dBm <sup>8</sup> |

- Total average (rms) noise power calculated as mean value of a linear magnitude trace expressed in dBm.
- Typical performance.
- Coupler roll-off will reduce compression to a negligible level below 500 MHz.
- Noise floor may be degraded by 10 dB at particular frequencies (multiples of 5 MHz) due to spurious receiver residuals.

- Specified value is for worst-case noise floor at 45 MHz.
- Specified value is for worst-case compression at 500 MHz.
- This compression level comes from the dynamic accuracy curve with -30 dBm reference test port power.
- Option 016 degrades performance by 3 dB.

# E8361A

## Test port input *continued*

| Description   | Specification<br>Standard or Option 014 | Option UNL<br>and Option 014 | Supplemental<br>information  |
|---|---|------------------------------|--|
| <b>Third Order Intercept<sup>1</sup> – Tone spacing from 100 kHz to 5 MHz</b> |   |                              |  |
| 10 to 500 MHz   |   |                              | Typical:<br>+30 dBm  |
| 500 MHz to 24 GHz   |   |                              | +24 dBm  |
| 24 to 40 GHz  |   |                              | +23 dBm  |
| 40 to 50 GHz  |   |                              | +24 dBm  |
| 50 to 67 GHz  |   |                              | +26 dBm  |
| <b>Third Order Intercept<sup>1</sup> – Tone spacing from 5 MHz to 20 MHz</b>  |   |                              |  |
| 10 to 500 MHz   |   |                              | Typical:<br>Not applicable   |
| 500 MHz to 24 GHz   |   |                              | +20 dBm  |
| 24 to 40 GHz  |   |                              | +20 dBm  |
| 40 to 50 GHz  |   |                              | +22 dBm  |
| 50 to 67 GHz  |   |                              | +24 dBm  |
| <b>Third Order Intercept<sup>1</sup> – Tone spacing from 20 MHz to 50 MHz</b> |   |                              |  |
| 10 to 500 MHz   |   |                              | Typical:<br>Not applicable   |
| 500 MHz to 24 GHz   |   |                              | +26 dBm  |
| 24 to 40 GHz  |   |                              | +24 dBm  |
| 40 to 50 GHz  |   |                              | +25 dBm  |
| 50 to 67 GHz  |   |                              | +27 dBm  |
| <b>System compression level – at maximum leveled output power</b>             |   |                              |  |
| See Dynamic Accuracy Chart  |   |                              |  |
| <b>Trace noise magnitude</b>  |   |                              |  |
| 10 to 45 MHz <sup>2</sup>   | < 0.150 dB rms                          | < 0.150 dB rms               | 1 kHz IF bandwidth<br>ratio measurement, nominal<br>power at test port |
| 45 to 500 MHz <sup>4, 5</sup>   | < 0.010 dB rms                          | < 0.010 dB rms               |  |
| 500 MHz to 24 GHz   | < 0.006 dB rms                          | < 0.006 dB rms               |  |
| 24 to 67 GHz  | < 0.006 dB rms                          | < 0.009 dB rms               |  |
| 67 to 70 GHz <sup>2</sup>   | < 0.006 dB rms                          | < 0.009 dB rms               |  |
| <b>Trace noise magnitude<sup>2</sup> – Option 080 enabled<sup>3</sup></b>     |   |                              |  |
| 10 to 45 MHz  | < 0.150 dB rms                          | < 0.150 dB rms               | 1 kHz IF bandwidth<br>ratio measurement, nominal<br>power at test port |
| 45 to 500 MHz <sup>4, 5</sup>   | < 0.010 dB rms                          | < 0.010 dB rms               |  |
| 500 MHz to 24 GHz   | < 0.006 dB rms                          | < 0.006 dB rms               |  |
| 24 to 67 GHz  | < 0.009 dB rms                          | < 0.012 dB rms               |  |
| 67 to 70 GHz  | < 0.009 dB rms                          | < 0.012 dB rms               |  |
| <b>Trace noise phase</b>  |   |                              |  |
| 10 to 45 MHz <sup>2</sup>   | < 0.800° rms                            | < 0.800° rms                 | 1 kHz IF bandwidth<br>ratio measurement, nominal<br>power at test port |
| 45 to 500 MHz <sup>5</sup>  | < 0.100° rms                            | < 0.100° rms                 |  |
| 500 MHz to 24 GHz   | < 0.060° rms                            | < 0.060° rms                 |  |
| 24 to 67 GHz  | < 0.100° rms                            | < 0.100° rms                 |  |
| 67 to 70 GHz <sup>2</sup>   | < 0.100° rms                            | < 0.100° rms                 |  |
| <b>Trace noise phase<sup>2</sup> – Option 080 enabled<sup>3</sup></b>         |   |                              |  |
| 10 to 45 MHz  | < 0.800° rms                            | < 0.800° rms                 | 1 kHz IF bandwidth<br>ratio measurement, nominal<br>power at test port |
| 45 to 500 MHz <sup>5</sup>  | < 0.100° rms                            | < 0.100° rms                 |  |
| 500 MHz to 24 GHz   | < 0.060° rms                            | < 0.060° rms                 |  |
| 24 to 67 GHz  | < 0.100° rms                            | < 0.100° rms                 |  |
| 67 to 70 GHz  | < 0.100° rms                            | < 0.100° rms                 |  |

1. Third order intercept is a typical specification that applies while the network analyzer receiver is in its linear range.

2. Typical performance.

3. 0 Hz offset.

4. Trace noise magnitude may be degraded to 20 dB rms at harmonic frequencies of the first IF (8.33 MHz) below 80 MHz.

5. Specified value is for worst-case noise floor at 45 MHz.



# E8361A

## Test port input *continued*

| Description                             | Specification<br>Standard | Option 014 | Supplemental<br>information                             |
|---|---------------------------|------------|---|
| <b>Reference level magnitude</b>        |                           |            |   |
| Range                                   | ±500 dB                   | ±500 dB    |   |
| Resolution                              | 0.001 dB                  | 0.001 dB   |   |
| <b>Reference level phase</b>            |                           |            |   |
| Range                                   | ±500°                     | ±500°      |   |
| Resolution                              | 0.01°                     | 0.01°      |   |
| <b>Stability magnitude <sup>1</sup></b> |                           |            | Typical ratio measurement:<br>Measured at the test port |
| 10 to 45 MHz                            |                           |            | ±0.05 dB/°C   |
| 45 MHz to 20 GHz                        |                           |            | ±0.02 dB/°C   |
| 20 to 40 GHz                            |                           |            | ±0.02 dB/°C   |
| 40 to 50 GHz                            |                           |            | ±0.02 dB/°C   |
| 50 to 70 GHz                            |                           |            | ±0.04 dB/°C   |
| <b>Stability phase <sup>1</sup></b>     |                           |            | Typical ratio measurement:<br>Measured at the test port |
| 10 to 45 MHz                            |                           |            | ±0.5°/°C  |
| 45 MHz to 20 GHz                        |                           |            | ±0.2°/°C  |
| 20 to 40 GHz                            |                           |            | ±0.5°/°C  |
| 40 to 50 GHz                            |                           |            | ±0.8°/°C  |
| 50 to 70 GHz                            |                           |            | ±0.8°/°C  |
| <b>Damage input level</b>               |                           |            |   |
| Test port 1 and 2                       |                           |            | +27 dBm or ±40 VDC, typical                             |
| R1, R2 in                               |                           |            | +15 dBm or ±15 VDC, typical                             |
| A, B in                                 |                           |            | +15 dBm or ±7 VDC, typical                              |
| Coupler thru (Option 014)               |                           |            | +27 dBm or ±40 VDC, typical                             |
| Coupler arm (Option 014)                |                           |            | +30 dBm or ±7 VDC, typical                              |
| Source out (reference)                  |                           |            | +15 dBm or ±15 VDC, typical                             |
| Source out (test ports)                 |                           |            | +27 dBm or ±5 VDC, typical                              |

1. Stability is defined as a ratio measurement measured at the test port.

# E8361A

## Test port input *continued*

### Group delay <sup>1</sup>

| Description           | Specification | Supplemental information (typical)  |
|-----------------------|---------------|---|
| Aperture (selectable) |               | (frequency span)/(number of points – 1)   |
| Maximum aperture      |               | 20% of frequency span   |
| Range                 |               | 0.5 x (1/minimum aperture)  |
| Maximum delay         |               | Limited to measuring no more than 180° of phase change within the minimum aperture. |

The following graph shows characteristic group delay accuracy with type-N full 2-port calibration and a 10 Hz IF bandwidth. Insertion loss is assumed to be less than 2 dB and electrical length to be 10 m.

### Group delay (typical)

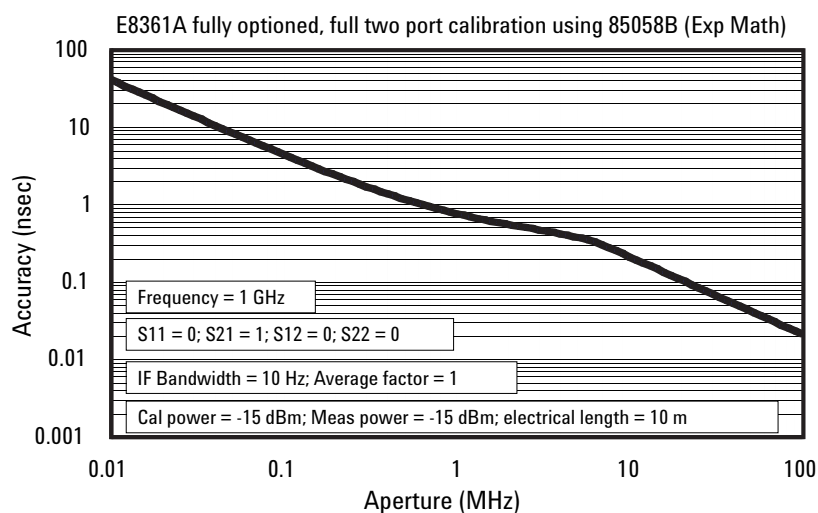

In general, the following formula can be used to determine the accuracy, in seconds, of a specific group delay measurement:

$$\pm \text{Phase accuracy (deg)} / [360 \times \text{Aperture (Hz)}]$$

Depending on the aperture and device length, the phase accuracy used is either incremental phase accuracy or worse case phase accuracy.

<sup>1</sup> Group delay is computed by measuring the phase change within a specified frequency step (determined by the frequency span and the number of points per sweep).

# E8361A

## Test port input *continued*

### Dynamic accuracy (specification)<sup>1</sup>

Applies to input ports 1 and 2, accuracy of the test port input power reading relative to the reference input power level. Also applies to the following conditions:

- IF bandwidth = 10 Hz

**Note:** If the power is set above maximum specified leveled power, the test port output signal may show non-linear effects that are dependent on the DUT.

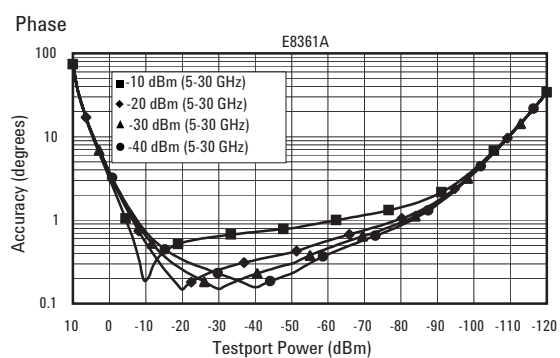
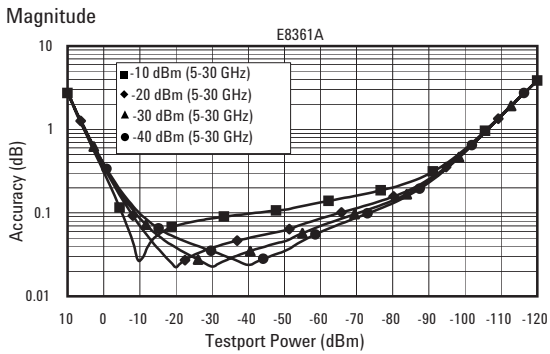
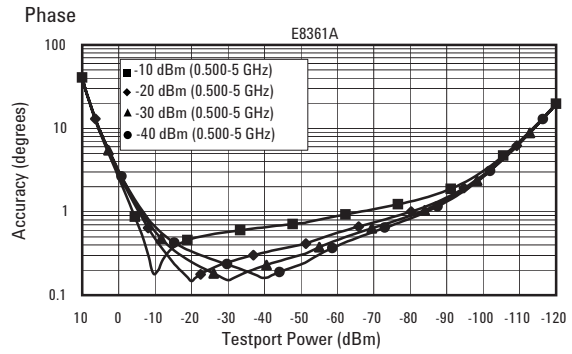
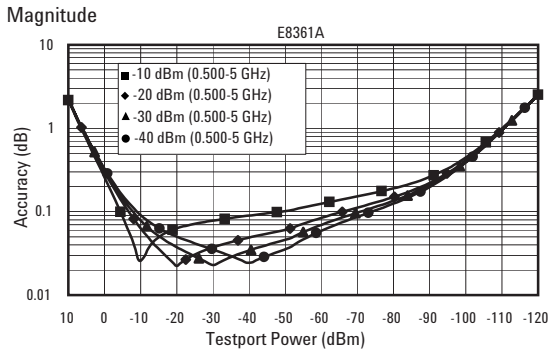
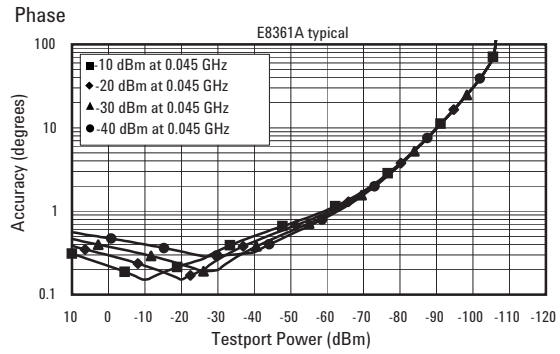
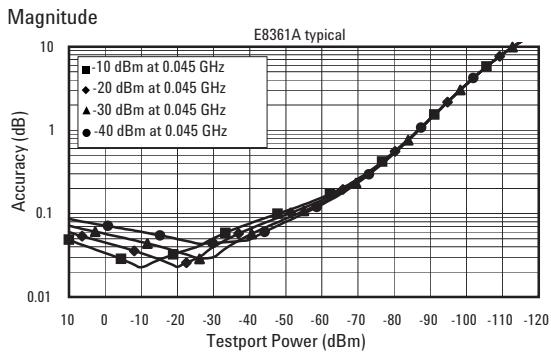

1. Dynamic accuracy is verified with the following measurements: compression over frequency, IF linearity at a single frequency of 1.195 GHz and a reference level of -20 dBm for an input power range of 0 to -120 dBm.

# E8361A

## Test port input *continued*

### Dynamic accuracy (specification)<sup>1</sup>

Applies to input ports 1 and 2, accuracy of the test port input power reading relative to the reference input power level. Also applies to the following conditions:

- IF bandwidth = 10 Hz

**Note:** If the power is set above maximum specified leveled power, the test port output signal may show non-linear effects that are dependent on the DUT.

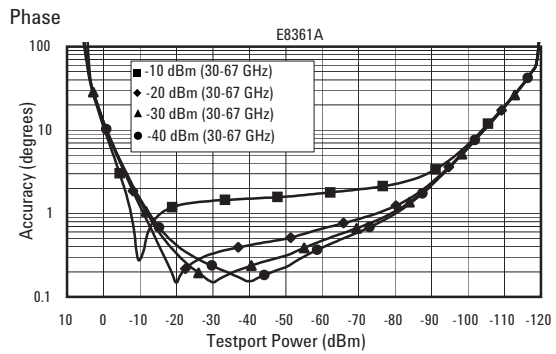
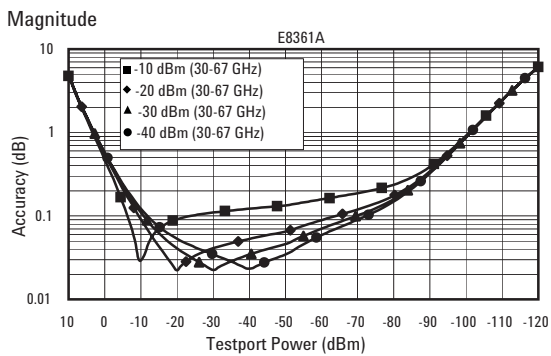

1. Dynamic accuracy is verified with the following measurements: compression over frequency, IF linearity at a single frequency of 1.195 GHz and a reference level of -20 dBm for an input power range of 0 to -120 dBm.

# E8361A

## Test port input *continued*

### Dynamic accuracy (specification)<sup>1</sup>

Applies to input ports 1 and 2, accuracy of the test port input power reading relative to the reference input power level. Also applies to the following conditions:

- IF bandwidth = 10 Hz

**Note:** If the power is set above maximum specified leveled power, the test port output signal may show non-linear effects that are dependent on the DUT.

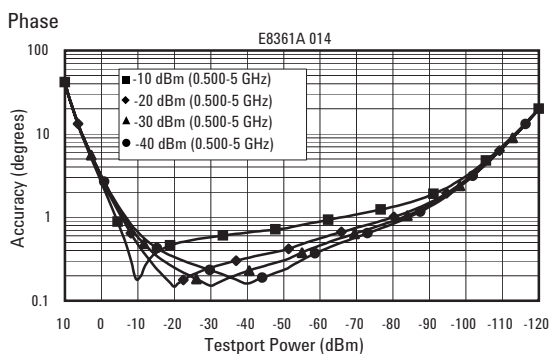
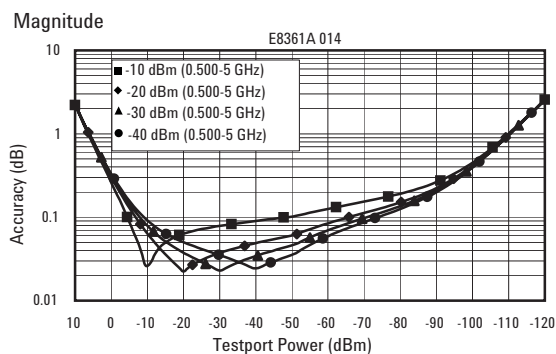

1. Dynamic accuracy is verified with the following measurements: compression over frequency, IF linearity at a single frequency of 1.195 GHz and a reference level of -20 dBm for an input power range of 0 to -120 dBm.

# E8361A

## Test port input *continued*

### Dynamic accuracy (specification)<sup>1</sup>

Applies to input ports 1 and 2, accuracy of the test port input power reading relative to the reference input power level. Also applies to the following conditions:

- IF bandwidth = 10 Hz

**Note:** If the power is set above maximum specified leveled power, the test port output signal may show non-linear effects that are dependent on the DUT.

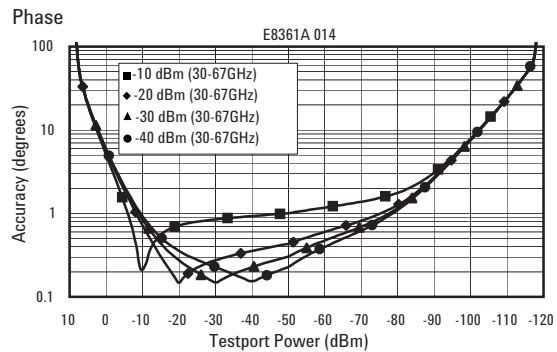
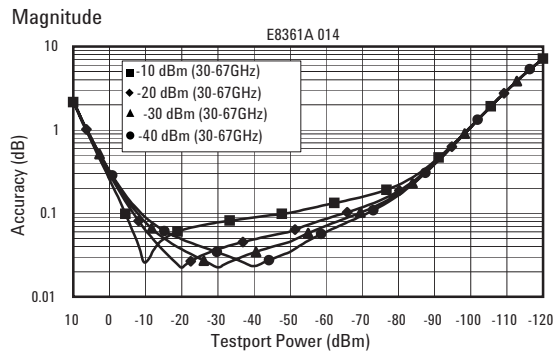
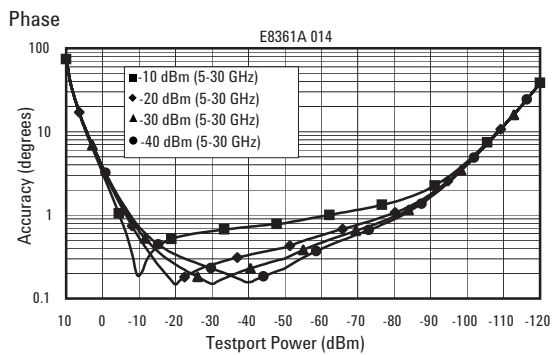
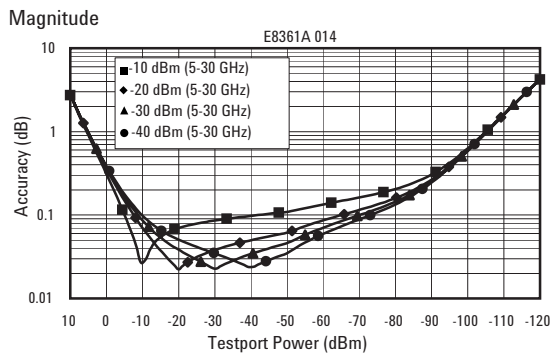

1. Dynamic accuracy is verified with the following measurements: compression over frequency, IF linearity at a single frequency of 1.195 GHz and a reference level of -20 dBm for an input power range of 0 to -120 dBm.

# Microwave PNA Series

## General information

| Description   | Supplemental information  |
|---|---|
| <b>System IF bandwidth range</b>                    | 1 Hz to 40 kHz, nominal   |
| <b>RF connectors</b>                                |   |
| E8362B  | 3.5 mm (male), 50 $\Omega$ , (nominal), center pin recession flush to .002 in. (characteristic)   |
| E8363/4B  | 2.4 mm (male), 50 $\Omega$ , (nominal), center pin recession flush to .002 in. (characteristic)   |
| E8361A  | 1.85 mm (male), 50 $\Omega$ , (nominal), center pin recession flush to .002 in. (characteristic)  |
| <b>Display</b>                                      | 8.4 in diagonal color active matrix LCD; 640 (horizontal) x 480 (vertical) resolution; 59.83 Hz vertical refresh rate; 31.41 Hz horizontal refresh rate   |
| <b>Display range</b>                                |   |
| Magnitude   | $\pm 200$ dB (at 20 dB/div), max  |
| Phase   | $\pm 500^\circ$ , max   |
| Polar   | 10 pico units, min; 1000 units, max   |
| <b>Display resolution</b>                           |   |
| Magnitude   | 0.001 dB/div, min   |
| Phase   | 0.01 $^\circ$ /div, min   |
| <b>Marker resolution</b>                            |   |
| Magnitude   | 0.001 dB, min   |
| Phase   | 0.01 $^\circ$ , min   |
| Polar   | 0.01 mUnit, min; 0.01 $^\circ$ , min  |
| <b>CPU</b>  | Intel <sup>®</sup> 500 MHz Pentium <sup>®</sup> III   |
| <b>Line power</b> (A third-wire ground is required) |   |
| Frequency   | 50/60/400 Hz  |
| Voltage   | 120/240 VAC (Power supply is auto switching.)   |
| Max   | 500 Watts   |
| <b>General environmental</b>                        |   |
| RFI/EMI susceptibility                              | Defined by CISPR Pub. 11, Group 1, Class A, and IEC 50082-1   |
| ESD   | Minimize using static-safe work procedures and an antistatic bench mat  |
| Dust  | Minimize for optimum reliability  |
| <b>Operating environment</b>                        |   |
| Temperature   | 0 $^\circ$ C to +40 $^\circ$ C; Instrument powers up, phase locks, and displays no error messages within this temperature range. (Except for 'source unlevelled' error message that may occur at temperature outside the specified performance temperature range of 25 $^\circ$ C, $\pm 5$ $^\circ$ C.) |
| Error-corrected temperature range                   | System specifications valid from 23 $^\circ$ C, $\pm 3$ $^\circ$ C, with less than 1 $^\circ$ C deviation from the calibration temperature  |
| Humidity  | 5 to 95% at +40 $^\circ$ C  |
| Altitude  | 0 to 4500 m (14,760 ft)   |

# Microwave PNA Series

## General information *continued*

| Description   | Supplemental information            |                    |                    |
|---|-------------------------------------|--------------------|--------------------|
| <b>Non-operating storage environment</b>                                    |                                     |                    |                    |
| Temperature   | -40 °C to +70 °C                    |                    |                    |
| Humidity  | 0 to 90% at +65 °C (non-condensing) |                    |                    |
| Altitude  | 0 to 15,240 m (50,000 ft)           |                    |                    |
| <b>Cabinet dimensions</b>   |                                     |                    |                    |
|   | <b>Height</b>                       | <b>Width</b>       | <b>Depth</b>       |
| Excluding front and rear panel hardware and feet                            | 267 mm<br>10.50 in                  | 426 mm<br>16.75 in | 427 mm<br>16.80 in |
| As shipped - includes front panel connectors, rear panel bumpers, and feet. | 280 mm<br>11.00 in                  | 435 mm<br>17.10 in | 470 mm<br>18.50 in |
| As shipped plus handles   | 280 mm<br>11.00 in                  | 458 mm<br>18.00 in | 501 mm<br>19.70 in |
| As shipped plus rack mount flanges  | 280 mm<br>11.00 in                  | 483 mm<br>19.00 in | 470 mm<br>18.50 in |
| As shipped plus handles and rack mount flanges                              | 280 mm<br>11.00 in                  | 483 mm<br>19.00 in | 501 mm<br>19.70 in |
| <b>Weight</b>   |                                     |                    |                    |
| Net   | 29 kg (64 lb), nom.                 |                    |                    |
| Shipping  | 36 kg (80 lb), nom.                 |                    |                    |



# Microwave PNA Series

## Rear panel

| Description                                      | Supplemental information   |
|--|--|
| <b>External trigger rear panel I/O (typical)</b> |  |
| <b>Trigger input</b>                             |  |
| Function   | Measurement of next point, next channel, or next group of channels                         |
| Source   | Aux I/O (pin 19) or I/O 1 (BNC (f) connector)  |
| Signal levels                                    | TTL-compatible   |
| Input impedance                                  | 5 k $\Omega$ nominal   |
| Minimum trigger width                            | 1 $\mu$ s  |
| Trigger modes                                    | High or low level; positive or negative edge   |
| Trigger delay range                              | 0 to 1 sec   |
| Trigger delay resolution                         | 6 $\mu$ s (IF bandwidth $\geq$ 15 kHz) or 6.2 $\mu$ s (IF bandwidth <15 kHz)               |
| <b>Trigger output</b>                            |  |
| Function   | Generate pulse before or after measurement<br>(only active when trigger type is external)  |
| Source   | I/O 2 (BNC (f) connector)  |
| Signal levels                                    | TTL-compatible   |
| Trigger polarity                                 | Positive or negative edge  |
| Pulse width                                      | 1 $\mu$ s  |
| <b>Option H11 rear panel I/O (typical)</b>       |  |
| <b>External IF inputs</b>                        |  |
| Function   | Allows use of external IF signals from remote mixers, bypassing the PNA's first converters |
| Connectors                                       | BNC (f), for B, R2, R1, A receivers  |
| Input frequency                                  | 8.33 MHz   |
| Input impedance                                  | 50 $\Omega$ nominal  |
| RF damage level                                  | -20 dBm  |
| DC damage level                                  | 25 Volts   |
| 0.1 dB compression point                         | -27 dBm  |
| <b>Test Set Drivers</b>                          |  |
| Function   | Used for driving remote mixers   |
| Connectors                                       | SMA (f) for RF and LO outputs  |
| RF, LO output frequency range                    | 1.7 to 20 GHz  |
| RF output power levels                           | +5 dBm to -16 dBm, depending on frequency <sup>1</sup>                                     |
| LO output power levels                           | -7 dBm to -16 dBm, depending on frequency  |
| <b>Pulse inputs (IF gates)<sup>2</sup></b>       |  |
| Function   | Internal receiver gates used for point-in-pulse and pulse-profile measurements             |
| Connectors                                       | BNC (f), for B, R2, R1, A receivers  |
| Input impedance                                  | 1 k $\Omega$ nominal   |
| Minimum pulse width                              | 20 ns for less than 1 dB deviation from theoretical performance <sup>3</sup>               |
| DC damage level                                  | 5.5 Volts  |
| Signal levels                                    | TTL; 0 V (off), +5 V (on) nominal  |

1. Measured at -5 dBm test port power.

2. Pulse input connectors are operational only with Option H08 (Pulsed Measurement Capability) enabled.

3. Based on deviation from signal reduction equation:

$$\text{Signal Reduction (dB)} = 20\log_{10}(\text{Duty\_cycle}) = 20\log_{10}(\text{pulse\_width}/\text{pulse\_repetition\_interval}).$$

Measured at pulse repetition frequency of 1 MHz.

# Microwave PNA Series

## Rear panel *continued*

| Description   | Supplemental information   |
|---|--|
| <b>10 MHz reference in</b><br>Input frequency<br>Input power<br>Input impedance                                 | 10 MHz $\pm$ 10 ppm, typ.<br>-15 dBm to +20 dBm, typ.<br>200 $\Omega$ , nom.   |
| <b>10 MHz reference out</b><br>Output frequency<br>Signal type<br>Output power<br>Output impedance<br>Harmonics | 10 MHz $\pm$ 10 ppm, typ.<br>Sine wave, typ.<br>10 dB $\pm$ 4 dB into 50 $\Omega$ , typ.<br>50 $\Omega$ , nom.<br>< -40 dBc, typ.  |
| <b>VGA video output</b>   | 15-pin mini D-Sub; Drives VGA compatible monitors  |
| <b>GPIB</b>   | Type D-24, 24-pin; female compatible with IEEE-488   |
| <b>Parallel port (LPT1)</b>   | 25-pin D-sub miniature connector; provides connection to printers or any other parallel port peripheral  |
| <b>Serial port (COM1)</b>   | 9-pin D-Sub; male compatible with RS-232   |
| <b>USB port</b><br><br>Contact 1<br>Contact 2<br>Contact 3<br>Contact 4   | 1 port on front panel and 5 ports on rear panel, universal serial bus jack, Type-A configuration (4 contacts inline, contact 1 on left); female<br>Vcc: 4.75 to 5.25 VDC, 500 mA max<br>-Data<br>+Data<br>Ground |
| <b>LAN</b>  | 10/100 BaseT Ethernet; 8-pin configuration auto selects between the two data rates   |
| <b>Test set I/O</b>   | 25-pin D-sub; available for external test set control  |
| <b>Handler I/O</b>  | 36-pin, parallel I/O port; all input/output signals are default set to negative logic; can be reset to positive logic via GPIB command   |
| <b>Auxiliary I/O</b>  | 25-pin D-sub male connector; analog and digital I/O  |
| <b>Bias tee inputs</b><br>Connectors<br>Maximum voltage<br>Maximum current<br>Fuse                              | BNC (f), for port 1 and port 2<br>$\pm$ 40 V DC<br>$\pm$ 200 mA with no degradation of RF specifications<br>500 mA, bi-pin style   |

# Microwave PNA Series

## Measurement throughput summary

### Cycle time vs. IF bandwidth<sup>1</sup>

Instrument state: preset condition, 201 points, CF = 28 GHz, Span = 100 MHz, correction off. Add 21 ms for display on. Cycle time includes sweep and re-trace time.

| IF bandwidth (Hz) | Cycle time (ms) | Cycle time (ms)<br>Option 080 enabled |
|-------------------|-----------------|---------------------------------------|
| 40,000            | 11              | 100                                   |
| 35,000            | 12              | 101                                   |
| 30,000            | 13              | 102                                   |
| 20,000            | 16              | 106                                   |
| 10,000            | 30              | 127                                   |
| 7,000             | 38              | 138                                   |
| 5,000             | 50              | 152                                   |
| 3,000             | 74              | 182                                   |
| 1,000             | 274             | 326                                   |
| 300               | 694             | 782                                   |
| 100               | 1905            | 2054                                  |
| 30                | 6091            | 6355                                  |
| 10                | 17916           | 18372                                 |

### Cycle time vs. number of points<sup>1</sup>

Instrument state: preset condition, 35 kHz IF bandwidth, CF = 28 GHz, Span = 100 MHz, correction off. Add 21 ms for display on. Cycle time includes sweep and re-trace time.

| Number of points | Cycle time (ms) |
|------------------|-----------------|
| 3                | 6               |
| 11               | 6               |
| 51               | 7               |
| 101              | 9               |
| 201              | 12              |
| 401              | 18              |
| 801              | 30              |
| 1601             | 55              |
| 16,001           | 497             |

### Cycle time (ms)<sup>1,2</sup>

|   | Number of points |     |      |        |
|---|------------------|-----|------|--------|
|   | 201              | 401 | 1601 | 16,001 |
| <b>Start 28 GHz, stop 30 GHz, IFBW = 35 kHz</b> |                  |     |      |        |
| Uncorrected and one-port cal                    | 12               | 19  | 55   | 503    |
| Two-port cal                                    | 29               | 44  | 124  | 1112   |
| <b>Start 10 MHz, stop 10 GHz, IFBW = 35 kHz</b> |                  |     |      |        |
| Uncorrected and one-port cal                    | 86               | 93  | 121  | 583    |
| Two-port cal                                    | 179              | 199 | 267  | 1301   |
| <b>Start 10 MHz, stop 20 GHz, IFBW = 35 kHz</b> |                  |     |      |        |
| Uncorrected and one-port cal                    | 126              | 130 | 153  | 597    |
| Two-port cal                                    | 264              | 275 | 335  | 1321   |
| <b>Start 10 MHz, stop 40 GHz, IFBW = 35 kHz</b> |                  |     |      |        |
| Uncorrected and one-port cal                    | 185              | 190 | 213  | 621    |
| Two-port cal                                    | 382              | 401 | 459  | 1374   |
| <b>Start 10 MHz, stop 50 GHz, IFBW = 35 kHz</b> |                  |     |      |        |
| Uncorrected and one-port cal                    | 210              | 216 | 243  | 643    |
| Two-port cal                                    | 436              | 450 | 522  | 1405   |
| <b>Start 10 MHz, stop 67 GHz, IFBW = 35 kHz</b> |                  |     |      |        |
| Uncorrected                                     | 244              | 254 | 300  | 645    |
| Corrected                                       | 502              | 524 | 591  | 1423   |

1. Typical performance.

2. Includes sweep time, retrace time and band-crossing time. Analyzer display turned off with DISPLAY:ENABLE OFF. Add 21 ms for display on. Data for one trace (S11) measurement.

3. Option 010 only. Analyzer display turned off with DISPLAY:ENABLE OFF. Add 21 ms for display on.

**Frequency Converter Application (Option 083) cycle time for fixed-IF measurements (s)<sup>1</sup>**

|   | Number of points |     |     |
|---|------------------|-----|-----|
|   | 101              | 201 | 401 |
| <b>Stimulus start = 1 GHz, stop = 11 GHz, IFBW = 35 kHz</b> |                  |     |     |
| <b>Response = 70 MHz, trace = SC21, cal = SMC_2P</b>        |                  |     |     |
| Hardware trigger  | 8.5              | 17  | 34  |
| Software trigger  | 31               | 62  | 124 |

**Data transfer time (ms)<sup>2</sup>**

|  | Number of points |     |      |        |
|--|------------------|-----|------|--------|
|  | 201              | 401 | 1601 | 16,001 |
| <b>SCPI over GPIB</b>                          |                  |     |      |        |
| <b>(program executed on external PC)</b>       |                  |     |      |        |
| 32-bit floating point                          | 7                | 12  | 43   | 435    |
| 64-bit floating point                          | 12               | 22  | 84   | 856    |
| ASCII  | 64               | 124 | 489  | 5054   |
| <b>SCPI (program executed in the analyzer)</b> |                  |     |      |        |
| 32-bit floating point                          | 1                | 2   | 3    | 30     |
| 64-bit floating point                          | 2                | 2   | 4    | 40     |
| ASCII  | 29               | 56  | 222  | 2220   |
| <b>COM (program executed in the analyzer)</b>  |                  |     |      |        |
| 32-bit floating point                          | 1                | 1   | 1    | 6      |
| Variant type                                   | 1                | 2   | 6    | 68     |
| <b>DCOM over LAN</b>                           |                  |     |      |        |
| <b>(program executed on external PC)</b>       |                  |     |      |        |
| 32-bit floating point                          | 1                | 1   | 2    | 121    |
| Variant type                                   | 3                | 6   | 19   | 939    |

1. Typical performance, using an Agilent PSG (E8257D) signal generator for the external LO source.

2. Typical performance.

# Microwave PNA Series

## Measurement capabilities

### Number of measurement channels

Thirty-two independent measurement channels. A measurement channel is coupled to stimulus settings including frequency, IF bandwidth, power level, and number of points.

### Number of display windows

Up to 16 display windows. Each window can be sized and re-arranged. Up to four measurement channels can be displayed per window.

### Number of traces

Up to four active traces and four memory traces per window. Measurement traces include S-parameters, as well as relative and absolute power measurements.

### Measurement choices

S11, S21, S12, S22, A/R1, A/R2, A/B, B/R1, B/R2, B/A, R1/A, R1/B, R1/R2, R2/A, R2/B, R2/R1, A, B, R1, R2

### Formats

Log or linear magnitude, SWR, phase, group delay, real and imaginary, Smith chart, polar.

### Data markers

Ten independent markers per trace. Reference marker available for delta marker operation. Marker formats include log or linear magnitude, phase, real, imaginary, SWR, delay,  $R + jX$ , and  $G + jB$ .

### Marker functions

#### *Marker search*

Maximum value, minimum value, target, next peak, peak right, peak left, target, and bandwidth with user-defined target values

#### *Marker-to functions*

Set start, stop, and center to active marker stimulus value; set reference to active marker response value; set electrical delay to active marker phase response value.

#### *Trace statistics*

Calculates and displays mean, standard deviation and peak-to-peak deviation of the data trace.

#### *Tracking*

Performs new search continuously or on demand.

## Source control

### Measured number of points per sweep

User definable from 2 to 16,001.

### Sweep type

Linear, CW (single frequency), power or segment sweep.

### Segment sweep

Define up to 101 different, sub-sweep frequency ranges in any combination of start-stop sweep modes. Set number of points, test port power levels, IF bandwidth, and dwell time independently for each segment.

### Sweep trigger

Set to continuous, hold, single, or group sweep with internal or external trigger.

### Power

Power slope can be set in dBm/GHz. Control the test port signal by setting the internal attenuator of the test set over a 60-dB range.

## Trace functions

### Display data

Display current measurement data, memory data, or current measurement with measurement and memory data simultaneously.

### Trace math

Vector addition, subtraction, multiplication or division of current linear measurement values and memory data.

### Display annotations

Start/stop, center/span, or CW frequency, scale/div, reference level, marker data, warning and caution messages, trace status, and pass/fail indication.

### Title

Add custom titles (50 characters maximum) to the display. Titles will be printed when making hardcopies of displayed measurements.

### Autoscale

Automatically selects scale resolution and reference value to center the trace.

### Electrical delay

Offset measured phase or group delay by a defined amount of electrical delay, in seconds.

### Phase offset

Offset measured phase or group delay by a defined amount in degrees.

# Microwave PNA Series

## Automation

|          | GPIB | LAN | Internal |
|----------|------|-----|----------|
| SCPI     | X    | X   | X        |
| COM/DCOM |      | X   | X        |

### Methods

#### *Controlling via internal analyzer execution*

Write applications that can be executed from within the analyzer via COM (component object model) or SCPI standard-interface commands. These applications can be developed in a variety of languages, including Visual Basic, Visual C++, Agilent VEE, or LabView™ programming languages.

#### *Controlling via GPIB*

The GPIB interface operates to IEEE 488.2 and SCPI standard-interface commands. The analyzer can either be the system controller, or talker/listener.

#### *Controlling via LAN*

The built-in LAN interface and firmware support data transfer and control via direct connection to a 10 Base-T network.

### SICL/LAN Interface

The analyzer's support for SICL (standard instrument control library) over the LAN provides control of the network analyzer using a variety of computing platforms, I/O interfaces, and operating systems. With SICL/LAN, the analyzer is controlled remotely over the LAN with the same methods used for a local analyzer connected directly to the computer via a GPIB interface.

### DCOM Interface

The analyzer's support for DCOM (distributed component object model) over the LAN provides control of the network analyzer using a variety of platforms. DCOM acts as an interface to the analyzer for external applications. With DCOM, applications can be developed or executed from an external computer. During development, the application can interface to the analyzer over the LAN through the DCOM interface. Once development is completed, the application can be distributed to the analyzer and interfaced using COM.

# Microwave PNA Series

## Data accuracy enhancement

### Measurement calibration

Measurement calibration significantly reduces measurement uncertainty due to errors caused by system directivity, source and load match, tracking and crosstalk. Full two-port calibration removes all the systematic errors to obtain the most accurate measurements.

### Calibration types available

#### *Frequency response*

Simultaneous magnitude and phase correction of frequency response errors for either reflection or transmission measurements.

#### *Response and isolation*

Compensates for frequency response and directivity (reflection) or frequency response and crosstalk errors.

#### *One-port calibration*

Uses test set port 1 or port 2 to correct for directivity, frequency response and source match errors.

#### *Two-port calibration*

Compensates for directivity, source match, reflection frequency response, load match, transmission frequency response and crosstalk. Crosstalk calibration can be omitted.

#### *Mixer Calibration*

Scalar-mixer calibration:

Scalar-mixer calibration corrects the conversion loss for input port source match, output port load match, absolute input or source power, and absolute output or receiver power. Scalar-mixer calibrations also corrects the input match measurements (S11) for input port directivity, frequency response and source match at the input frequencies and corrects the output match measurement (S22) for output directivity, frequency response and source match at the output frequencies.

Vector-mixer calibration:

At the input frequencies of the mixer, the vector-mixer calibration compensates for directivity, source match, and reflection frequency response. At the output frequencies of the mixer, the vector-mixer calibration compensates for directivity, load match, and reflection frequency response. Frequency-translated transmission response is compensated by using a characterized calibration mixer. The characterization of the calibration mixer is part of the calibration process.

#### *TRL/TRM calibration*

Compensates for directivity, reflection and transmission frequency response and crosstalk in both forward and reverse directions. Provides the highest accuracy for both coaxial and non-coaxial environments, such as on-wafer probing, in-fixture or waveguide measurements.

### Interpolated error correction

With any type of accuracy enhancement applied, interpolated mode recalculates the error coefficients when the test frequencies are changed. The number of points can be increased or decreased and the start/stop frequencies can be changed, but the resulting frequency range must be within the original calibration frequency. System performance is not specified for measurements with interpolated error correction applied.

#### *Velocity factor*

Enters the velocity factor to calculate the equivalent electrical length.

#### *Reference plane extension*

Redefine the plane-of-measurement reference to other than port 1 or port 2.

## Storage

### Internal hard disk drive

Store and recall binary instrument states and calibration data on 10 GB, minimum, internal hard drive. Instrument data can also be saved in ASCII (including S2P) format. All files are MS-DOS®-compatible. Instrument states include all control settings, active limit lines, active list frequency tables, memory trace data.

### Disk drive

Instrument data, instrument states, and calibration data can be stored on internal 3.5-in, 1.4 MB floppy disk in MS-DOS-compatible format.

### Data hardcopy

Printouts of instrument data are directly produced on any printer with the appropriate Windows® 2000 printer driver. The analyzer provides USB, Centronics (parallel), serial and LAN interfaces.

# Microwave PNA Series

## System capabilities

### Familiar graphical user interface

The PNA Series employs a graphical user interface based on Windows 2000. There are two fundamental ways to operate the instrument manually: you can use a hardkey interface, or use drop-down menus driven from a mouse (or another standard USB pointing device). Hardkey navigation brings up active toolbars that perform most of the operations required to configure and view measurements. Front-panel navigation keys allow for use of the instrument without a mouse. In addition, mouse-driven pull-down menus provide easy access to both standard and advanced features. Both methods employ dialog boxes to display all the choices needed to make measurement set-ups.

### Built-in information system

Embedded documentation provides measurement assistance in five different languages (English, Chinese, French, German, Japanese, and Spanish). A thorough index of help topics and context-sensitive help is available from dialog boxes.

### Limit lines

Define test limit lines that appear on the display for go/no go testing. Lines may be any combination of horizontal, sloping lines, or discrete data points.

### Time-domain (Option 010)

With the time-domain option, data from transmission or reflection measurements in the frequency domain are converted to the time domain using a Fourier transformation technique (chirp Z) and presented on the display. The time-domain response shows the measured parameter value versus time. Markers may also be displayed in electrical length (or physical length if the relative propagation velocity is entered).

### 4-port measurement application (Option 550)

Enables full 4-port error correction and differential measurements on a 2-port network analyzer. External test set must be connected. User installable.

### Time stimulus modes

Two types of time excitation stimulus waveforms can be simulated during the transformations, a step and an impulse.

### Low-pass step

This stimulus, similar to a traditional time-domain reflectometer (TDR) stimulus waveform, is used to measure low-pass devices. The frequency-domain data should extend from DC (extrapolated value) to a higher value. The step response is typically used for reflection measurements only.

### Low-pass impulse

This stimulus is also used to measure low-pass devices. The impulse response can be used for reflection or transmission measurements.

### Bandpass impulse

The bandpass impulse stimulates a pulsed RF signal (with an impulse envelope) and is used to measure the time-domain response of band-limited devices. The start and stop frequencies are selectable by the user to any values within the limits of the test set used. Bandpass time-domain responses are useful for both reflection and transmission measurements.

### Time-domain range

The "alias-free" range over which the display is free of response repetition depends on the frequency span and the number of points. Range, in nanoseconds, is determined by:  $\text{Time-domain range} = (\text{number of points} - 1) / \text{frequency span [in GHz]}$

### Range resolution

The time resolution of a time-domain response is related to range as follows:  $\text{Range resolution} = \text{time span} / (\text{number of points} - 1)$

### Windows

The windowing function can be used to modify (filter) the frequency-domain data and thereby reduce over-shoot and ringing in the time-domain response. Kaiser Beta windows are available.

### Gating

The gating function can be used to selectively remove reflection or transmission time-domain responses. In converting back to the frequency-domain the effects of the responses outside the gate are removed.

### Configurable test set (Option 014)

With the configurable test set option, front panel access loops are provided to the signal path between the source output and coupler input.

### Extended dynamic range configuration

Reverse the signal path in the coupler and bypass the loss typically associated with the coupled arm. Change the port 2 switch and coupler jumper configurations to increase the forward measurement dynamic range. When making full two-port error corrected measurements, the reverse dynamic range is degraded by 12 to 15 dB.



#### *High power measurement configuration*

Add external power amplifier(s) between the source output and coupler input to provide up to +30 dBm of power at the test port(s). Full two-port error correction measurements possible. When the DUT output is expected to be greater than +30 dBm, measure directly at the B input and use an external fixed or step attenuator to prevent damage to the receiver. For measurements greater than +30 dBm, add external components such as couplers, attenuators, and isolators.

#### **Extended power range and bias-tees (Option UNL)**

Adds two 60 dB step attenuators (50 dB for E8361A) and two bias-tees. A step attenuator and bias-tee set is inserted between the source and test port one and another set between the source and test port two.

#### **Frequency-offset (Option 080)**

This option enables the PNA Series microwave network analyzers to set the source frequency independently from where the receivers are tuned. This ability is important for two general classes of devices: mixers (and converters) and amplifiers. For frequency-translating devices like mixers or converters, frequency-offset capability is necessary for conversion loss/gain measurements (both amplitude and phase), since, by definition, the input and output frequency of the DUT are different. For amplifier measurements, frequency offset capability is required to measure amplifier harmonics or when using the internal source as one of the stimuli of an IMD measurement. Option 080 provides a very basic user interface. The user may enter multiplier and offset values to describe how the instrument's receivers track the source frequency. While flexible, the user interface requires the user to calculate the correct values. The frequency-converter application (Option 083) provides a much more intuitive and easy-to-use user interface, designed specifically for mixer and converter measurements.

#### **Reference channel switch (Option 081)**

Option 081 adds a solid-state internal RF transfer switch in the R1 reference-receiver path. The switch allows the instrument to easily switch between standard S-parameter (non-frequency-offset) measurements and frequency-offset measurements such as relative phase or absolute group delay that require an external reference mixer. The user can set the switch manually or remotely, but it is best used with the frequency-converter application (Option 083), where it is controlled automatically during the vector-mixer calibration procedure.

**IF Access (Option H11)**

Provides hardware to enable antenna, point-in-pulse, and pulse-profile measurements, as well as broadband millimeter-wave measurements to 110 GHz, and banded millimeter-wave measurements to 325 GHz. For each of the microwave PNA's measurement receivers, IF gates (enabled with pulsed-RF measurement capability Option H08) and external IF inputs are added. In addition, access to the PNA's internal RF and LO sources is provided for remote-mixing applications. For basic antenna measurements, only Option H11 is necessary. Pulsed-antenna applications also require the pulsed-measurement capability (Option H08). Millimeter-wave measurements also require an N5260A millimeter-wave test set controller.

**Pulsed-RF measurement capability (Option H08)**

Provides software to set up and control pulsed-RF measurements with point-in-pulse and pulse-profile capability. The software sets the coefficients of the PNA's digital-IF filter to null out unwanted spectral components, enables the IF gates provided with IF access (Option H11), and controls the Agilent 81110A family of pulse generators. The software can be run on the PNA or an external computer, and a ".dll" file containing the IF-filter algorithm is included for automated pulsed-RF testing.

**Frequency-converter application (Option 083)**

The frequency-converter application adds an intuitive and easy-to-use user interface, advanced calibration choices that provide exceptional amplitude and phase accuracy, and control of external signal sources for use as local oscillators. A graphical set-up dialog box lets you quickly set up the instrument for single or dual conversion devices. This set-up screen also helps you calculate and choose where mixing and image products will fall.

**Add receiver attenuator (Option 016)**

A 35 dB attenuator with 5 dB steps (50 dB attenuator with 10 dB steps for E8361A only) is added between both test ports and their corresponding receiver. See page 53 for a basic block diagram.

**Extended memory (Option 022)**

More RAM is added for a total of 512 MB.

**Commercial calibration certificate with test data (Option UK6)**

Complete set of measurements which tests unit to manufacturer's published specifications. Includes calibration label, calibration certificate, and data report. Conforms to ISO 9001.

**ISO 17025 compliant calibration (Option 1A7)**

Complete set of measurements which tests unit to manufacturer's published specifications. Includes calibration label, ISO 17025 calibration certificate, and data report, measurement uncertainties and guardbands on all customer specifications. Conforms to ISO 17025 and ISO 9001.

**ANSI Z540 compliant calibration (Option A6J)**

Complete set of measurements which tests unit to manufacturer's published specifications. Includes pre and post-adjustment data with measurement uncertainty information compliant to the ANSI/NCSL Z540 standard.

*Supplemental performance*

Minimum reference channel input level (Option 080 disabled): -35 dBm

# Microwave PNA Series

## Simplified test set block diagram

Standard power range

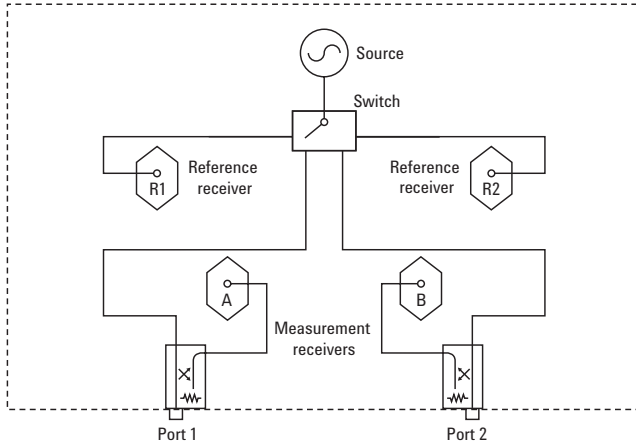

Extended power range and bias-tees (Option UNL)

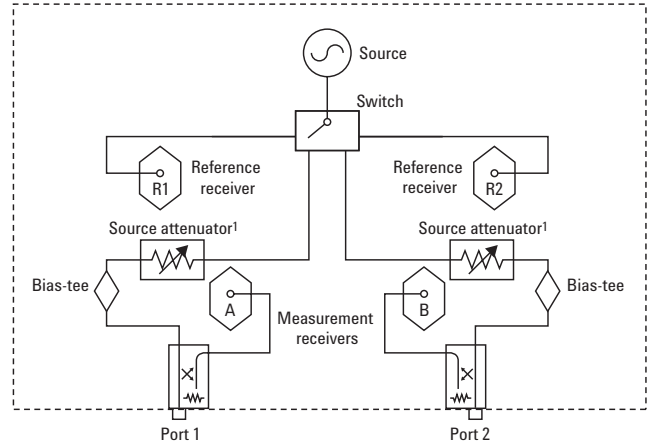

Configuration test set (Option 014)

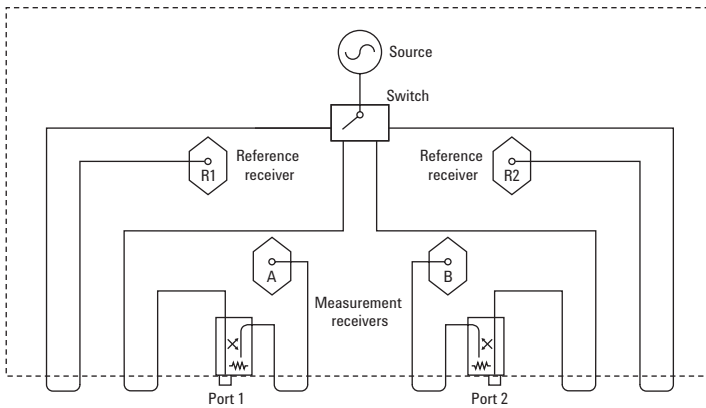

Configurable test set with extended power range and bias-tees (Option UNL and 014)

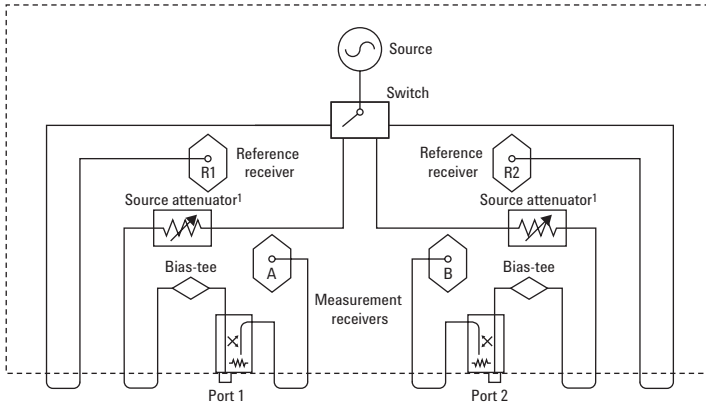

1. Source attenuator for E8362/3/4B is 60 dB in 10 dB steps. Source attenuator for E8361A is 50 dB in 10 dB steps.

**Fully optioned (Options 014, UNL, 016, 080, 081)**

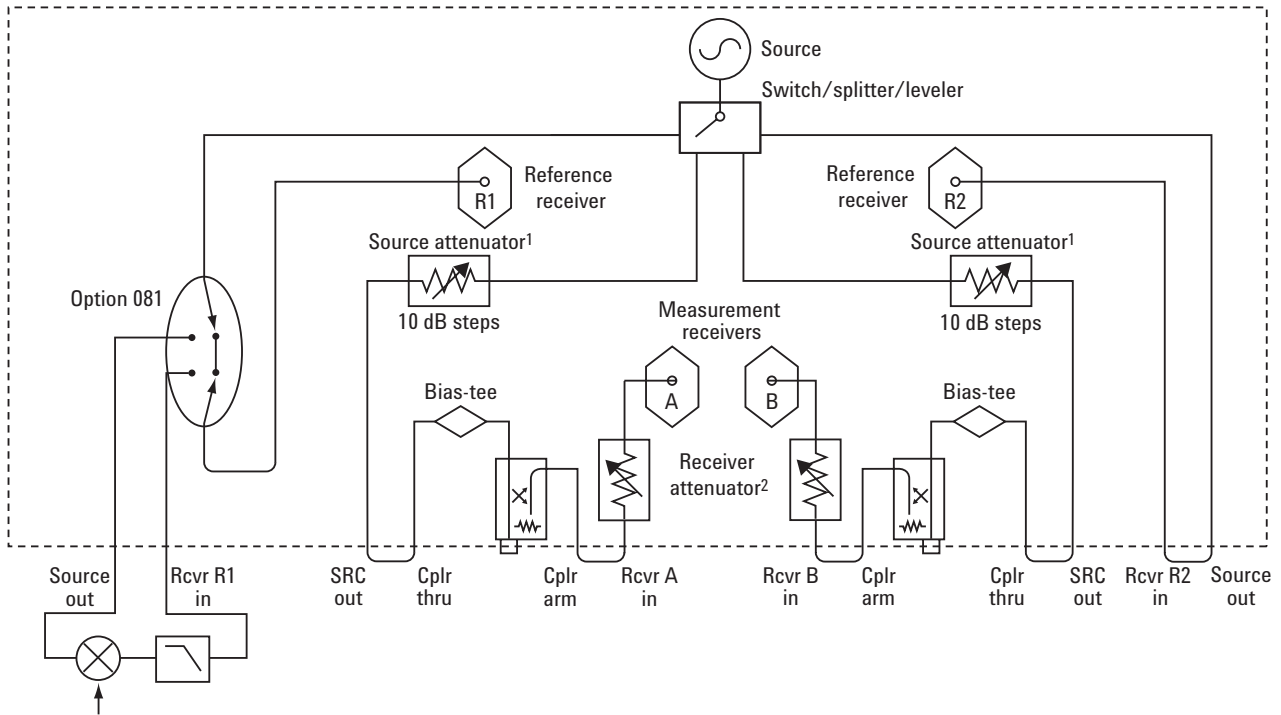

**Fully optioned pulse, antenna, or mm-wave configuration (Options 014, UNL, 016, 080, 081, H11)**

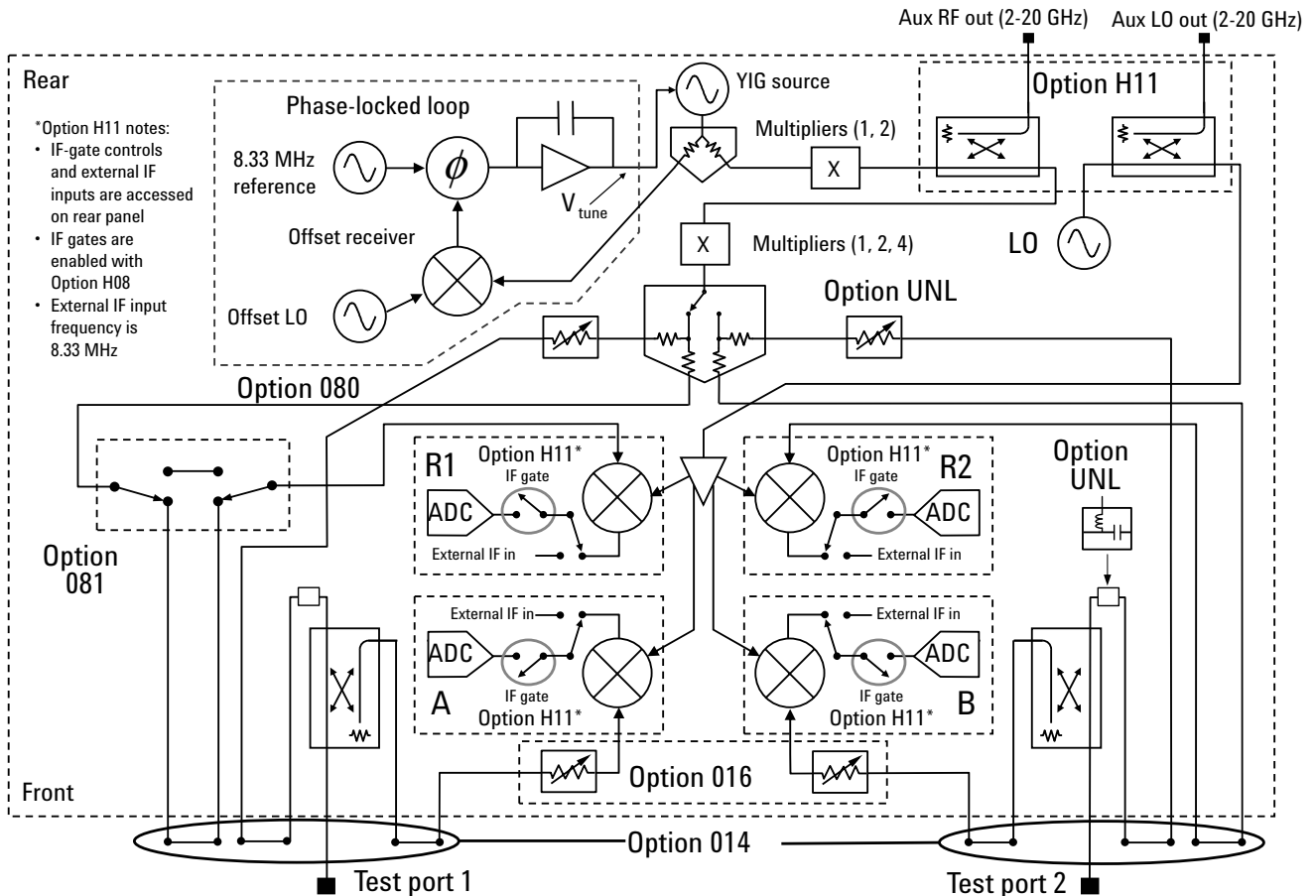

1. Source attenuator for E8362/3/4B is 60 dB in 10 dB steps. Source attenuator for E8361A is 50 dB in 10 dB steps.  
 2. Receiver attenuator for E8362/3/4B is 35 dB in 5 dB steps. Receiver attenuator for E8361A is 50 dB in 10 dB steps.

# Ordering guide for PNA series

## Network analyzers

This guide is intended to assist you in the ordering process. For detailed ordering information, refer to the *PNA Series Microwave Network Analyzer Configuration Guide* (literature number 5988-7989EN).

### PNA Series microwave network analyzers<sup>1</sup>

|        |                  |
|--------|------------------|
| E8362B | 10 MHz to 20 GHz |
| E8363B | 10 MHz to 40 GHz |
| E8364B | 10 MHz to 50 GHz |
| E8361A | 10 MHz to 67 GHz |

## Options

To add options to a product, order the corresponding item number.

| Description   | For E8362B item number | For E8363B item number | For E8364B item number | For E8361A <sup>2</sup> item number | Additional information   |
|---|------------------------|------------------------|------------------------|-------------------------------------|--|
| <b>Test set</b>   |                        |                        |                        |                                     |  |
| Option 014 • Configurable test set                              | E8362B-014             | E8363B-014             | E8364B-014             | E8361A-014                          |  |
| <b>Power configuration</b>                                      |                        |                        |                        |                                     |  |
| Option UNL • Extended power range and bias-tees                 | E8362B-UNL             | E8364B-UNL             | E8364B-UNL             | E8361A-UNL                          | E8361A only, requires 014  |
| Option 016 • Add receiver attenuators                           | E8362A-016             | E8364A-016             | E8364A-016             | E8361A-016                          | E8361A only, requires 014 and UNL  |
| <b>CPU RAM</b>  |                        |                        |                        |                                     |  |
| Option 022 • Extended memory                                    | E8362A-022             | E8364A-022             | E8364A-022             | E8361A-022                          |  |
| <b>Non-linear measurements</b>                                  |                        |                        |                        |                                     |  |
| Option 080 • Frequency offset                                   | E8362A-080             | E8364A-080             | E8364A-080             | E8361A-080                          | Requires 014   |
| Option 081 • Reference receiver switch                          | E8362A-081             | E8364A-081             | E8364A-081             | E8361A-081                          | Requires 014, 080  |
| Option 083 • Frequency-converter measurement application        | E8362A-083             | E8364A-083             | E8364A-083             | E8361A-083                          | Requires 014, 080, and 081 (E8361A only requires 014, 080) includes GPIB to USB interface (82357A) |
| Option H11 • IF access (for antenna and pulsed-RF measurements) | E8362B-H11             | E8363B-H11             | E8364B-H11             | E8361A-H11                          | Requires 014, 080, 081, and UNL  |
| Option H08 • Pulsed-RF measurement capability                   | E8362B-H08             | E8363B-H08             | E8364B-H08             | E8361A-H08                          |  |
| <b>Measurement features</b>                                     |                        |                        |                        |                                     |  |
| Option 010 • Time-domain capability                             | E8362A-010             | E8363A-010             | E8364A-010             | E8361A-010                          |  |
| Option 550 <sup>3</sup> • 4-port measurement application        | E8362B-550             | E8363B-550             | E8364B-550             | E8361A-550                          |  |
| <b>Accessories</b>  |                        |                        |                        |                                     |  |
| Option 1CM • Rack mount kit without handles                     | E8362A-1CM             | E8363A-1CM             | E8364A-1CM             | E8361A-1CM                          |  |
| Option 1CP • Rack mount kit with handles                        | E8362A-1CP             | E8363A-1CP             | E8364A-1CP             | E8361A-1CP                          |  |
| N4688A • USB CD R/W drive                                       | N4688A                 | N4688A                 | N4688A                 | N4688A                              |  |
| N4689A • USB Hub  | N4689A                 | N4689A                 | N4689A                 | N4689A                              |  |
| <b>Calibration documentation</b>                                |                        |                        |                        |                                     |  |
| Option 1A7 • ISO 17025 compliant calibration                    | E8362B-1A7             | E8363B-1A7             | E8364B-1A7             | Available soon                      |  |
| Option UK6 • Commercial calibration certificate with test data  | E8362A-UK6             | E8363A-UK6             | E8364A-UK6             | E8361A-UK6                          |  |
| Option A6J • ANSI Z540 compliant calibration                    | E8362B-A6J             | E8363B-A6J             | E8364B-A6J             | E8361A-A6J                          |  |

**Note:** Item numbers may not correspond to product model number. For example, to order the time-domain option on the E8362B, the correct item number to order is E8362A-010.

## Warranty and service

One and three year warranty and service plans are available at the time of instrument purchase. The N5250A microwave 110 GHz system carries a full one-year on-site warranty (where available).

## Calibration

Three year calibration plans are available at time of instrument purchase.

1. Not all models are available in all countries.  
 2. E8361AH11 enables E8361A to cover 10 MHz to 110 GHz frequency range.  
 3. External test set must be connected.

# Test port cable specifications

|   | Connector Type<br>(Test port to device)             | Frequency<br>(GHz) | Length <sup>2</sup><br>cm (inch) | Return<br>loss | Insertion loss<br>(dB) (f in GHz)               | Stability <sup>1,2</sup><br>±magnitude | ±Phase<br>(degrees) |
|---|---|--------------------|----------------------------------|----------------|---|--|---------------------|
| <b>Single cables for 8719 and 8720 (3.5 mm)</b> |   |                    |                                  |                |   |  |                     |
| 85131C semi-rigid cable                         | 3.5 mm <sup>3</sup> to PSC-3.5 mm (f)               | DC to 26.5         | 81 (32)                          | ≥17 dB         | 0.43 √f +0.3<br>(2.5 dB at f <sub>max</sub> )   | <0.06 dB                               | 0.16 (f) +0.5       |
| 85131E flexible cable                           | 3.5 mm <sup>3</sup> to PSC-3.5 mm (f)               | DC to 26.5         | 96.5 (38)                        | ≥16 dB         | 0.35 √f +0.3<br>(2.1 dB at f <sub>max</sub> )   | <0.22 dB                               | 0.16 (f) +0.8       |
| 85132C semi-rigid cable                         | 3.5 mm <sup>3</sup> to 7 mm                         | DC to 18           | 81 (32)                          | ≥17 dB         | 0.35 √f +0.3<br>(1.8 dB at f <sub>max</sub> )   | <0.06 dB                               | 0.16 (f) +0.5       |
| 85132E flexible cable                           | 3.5 mm <sup>3</sup> to 7 mm                         | DC to 18           | 97.2 (38.25)                     | ≥17 dB         | 0.35 √f +0.3<br>(1.8 dB at f <sub>max</sub> )   | <0.22 dB                               | 0.16 (f) +0.8       |
| <b>Cable sets for 8719 and 8720 (3.5 mm)</b>    |   |                    |                                  |                |   |  |                     |
| 85131D semi-rigid cable set                     | 3.5mm <sup>3</sup> to PSC-3.5 mm (f) or 3.5 mm (m)  | DC to 26.5         | 53 (21)                          | ≥16 dB         | 0.30 √f +0.2<br>(1.8 dB at f <sub>max</sub> )   | <0.06 dB                               | 0.16 (f) +0.5       |
| 85131F flexible cable set                       | 3.5 mm <sup>3</sup> to PSC-3.5 mm (f) or 3.5 mm (m) | DC to 26.5         | 53 (21)                          | ≥16 dB         | 0.25 √f +0.2<br>(1.5 dB at f <sub>max</sub> )   | <0.12 dB                               | 0.13 (f) +0.5       |
| 85132D semi-rigid cable set                     | 3.5 mm <sup>3</sup> to 7 mm                         | DC to 18           | 53 (21)                          | ≥17 dB         | 0.25 √f +0.2<br>(1.3 dB at f <sub>max</sub> )   | <0.06 dB                               | 0.16 (f) +0.5       |
| 85132F flexible cable set                       | 3.5 mm <sup>3</sup> to 7 mm                         | DC to 18           | 53 (21)                          | ≥17 dB         | 0.25 √f +0.2<br>(1.3 dB at f <sub>max</sub> )   | <0.12 dB                               | 0.13 (f) +0.5       |
| <b>Single cables for 8722 (2.4 mm)</b>          |   |                    |                                  |                |   |  |                     |
| 85133C semi-rigid cable                         | 2.4 mm <sup>3</sup> to PSC-2.4 mm (f)               | DC to 50           | 81 (32)                          | ≥15 dB         | 0.84 √f +0.3<br>(5.6 dB at f <sub>max</sub> )   | <0.06 dB                               | 0.18 (f)            |
| 85133E flexible cable                           | 2.4 mm <sup>3</sup> to PSC-2.4 mm (f)               | DC to 50           | 113 (44)                         | ≥12.5 dB       | 0.58 √f +0.35<br>(4.45 dB at f <sub>max</sub> ) | <0.25 dB                               | 0.8 +0.16 (f)       |
| 85134C semi-rigid cable                         | 2.4 mm <sup>3</sup> to PSC-3.5 mm (f)               | DC to 26.5         | 81 (32)                          | ≥16 dB         | 0.46 √f +0.3<br>(2.7 dB at f <sub>max</sub> )   | <0.06 dB                               | 0.18 (f)            |
| 85134E flexible cable                           | 2.4 mm <sup>3</sup> to PSC-3.5 mm (f)               | DC to 26.5         | 97.2 (38.25)                     | ≥16 dB         | 0.46 √f +0.3<br>(2.7 dB at f <sub>max</sub> )   | <0.22 dB                               | 0.16 (f) +0.8       |
| 85135C semi-rigid cable                         | 2.4 mm <sup>3</sup> to 7 mm                         | DC to 18           | 81 (32)                          | ≥17 dB         | 0.46 √f +0.3<br>(2.25 dB at f <sub>max</sub> )  | <0.06 dB                               | 0.18 (f)            |
| 85135E flexible cable                           | 2.4 mm <sup>3</sup> to 7 mm                         | DC to 18           | 97.2 (38.25)                     | ≥17 dB         | 0.46 √f +0.3<br>(2.25 dB at f <sub>max</sub> )  | <0.22 dB                               | 0.16 (f) +0.8       |

1. Phase stability of semi-rigid/flexible cables is specified with a 90-degree bend and a 4"/3" radius.

2. Cable length and stability are supplemental characteristics.

3. Special rugged female connector specifically for connecting to the network analyzer test port. Does not mate with a standard male connector.

# Test port cable specifications *continued*

|   | Connector Type<br>(Test port to device)                   | Frequency<br>(GHz) | Length <sup>2</sup><br>cm (inch) | Return<br>loss | Insertion loss<br>(dB) (f in GHz)               | Stability <sup>1,2</sup><br>±magnitude | ±Phase<br>(degrees) |
|---|---|--------------------|----------------------------------|----------------|---|--|---------------------|
| <b>Cable sets for<br/>8722D (2.4 mm)</b>  |   |                    |                                  |                |   |  |                     |
| 85133D semi-rigid cable set               | 2.4 mm <sup>3</sup> to<br>PSC-2.4 mm (f) or<br>2.4 mm (m) | DC to 50           | 53 (21)                          | ≥15 dB         | 0.55 √f +0.2<br>(3.7 dB at f <sub>max</sub> )   | <0.06 dB                               | 0.16 (f)            |
| 85133F flexible cable set                 | 2.4 mm <sup>3</sup> to<br>PSC-2.4 mm (f) or<br>2.4 mm (m) | DC to 50           | 72 (28)                          | ≥12.5 dB       | 0.48 √f +0.25<br>(3.64 dB at f <sub>max</sub> ) | <0.17 dB                               | 0.8 + 0.16 (f)      |
| 85134D semi-rigid cable set               | 2.4 mm <sup>3</sup> to<br>PSC-3.5 mm (f) or<br>3.5 mm (m) | DC to 26.5         | 53 (21)                          | ≥16 dB         | 0.31 √f +0.2<br>(1.8 dB at f <sub>max</sub> )   | <0.06 dB                               | 0.18 (f)            |
| 85134F flexible cable set                 | 2.4 mm <sup>3</sup> to<br>PSC-3.5 mm (f) or<br>3.5 mm (m) | DC to 26.5         | 53 (21)                          | ≥16 dB         | 0.31 √f +0.2<br>(1.8B dB at f <sub>max</sub> )  | <0.12 dB                               | 0.13 (f) +0.5       |
| 85135D semi-rigid cable set               | 2.4 mm <sup>3</sup> to 7mm                                | DC to 18           | 53 (21)                          | ≥17 dB         | 0.31 √f +0.2<br>(1.5 dB at f <sub>max</sub> )   | <0.06 dB                               | 0.18 (f)            |
| 85135F flexible cable set                 | 2.4 mm <sup>3</sup> to 7 mm                               | DC to 18           | 62.9 (24.75)                     | ≥17 dB         | 0.31 √f +0.2<br>(1.5 dB at f <sub>max</sub> )   | <0.12 dB                               | 0.13 (f) +0.5       |
| <b>Single cable for<br/>PNA (1.85 mm)</b> |   |                    |                                  |                |   |  |                     |
| N4697E flexible cable                     | 1.85 mm <sup>3</sup> to<br>1.85 mm (f)                    | DC to 67           | 96.5 (38)                        | ≥15 dB         | 1.9 dB/ft at 65 GHz                             | <0.1 dB                                | <0.5° (f) + 0.09°   |
| <b>Cable set for<br/>PNA (1.85 mm)</b>    |   |                    |                                  |                |   |  |                     |
| N4697F flexible cable                     | 1.85 mm <sup>3</sup> to<br>1.85 mm (f)                    | DC to 67           | 72 (28)                          | ≥ 15 dB        | 1.9 dB/ft at 65 GHz                             | <0.06 dB                               | <0.5° (f) + 0.04°   |

1. Phase stability of semi-rigid/flexible cables is specified with a 90-degree bend and a 4"/3" radius.

2. Cable length and stability are supplemental characteristics.

3. Special rugged female connector specifically for connecting to the network analyzer test port. Does not mate with a standard male connector.

# Information resources

## Literature

*PNA Series RF and Microwave Network Analyzers Brochure*, literature number 5968-8472E

*PNA Series Microwave Network Analyzer Configuration Guide*, literature number 5988-7989EN

## Web

PNA Series: [www.agilent.com/find/pna](http://www.agilent.com/find/pna)

ECal electronic calibration:  
[www.agilent.com/find/ecal](http://www.agilent.com/find/ecal)

Application and product resources:  
[www.agilent.com/find/test](http://www.agilent.com/find/test)

Test and measurement accessories:  
[www.agilent.com/find/accessories](http://www.agilent.com/find/accessories)



## Agilent Email Updates

[www.agilent.com/find/emailupdates](http://www.agilent.com/find/emailupdates)  
Get the latest information on the products and applications you select.



## Agilent Direct

[www.agilent.com/find/agilentdirect](http://www.agilent.com/find/agilentdirect)  
Quickly choose and use your test equipment solutions with confidence.

## www.agilent.com

### Agilent Technologies' Test and Measurement Support, Services, and Assistance

Agilent Technologies aims to maximize the value you receive, while minimizing your risk and problems. We strive to ensure that you get the test and measurement capabilities you paid for and obtain the support you need. Our extensive support resources and services can help you choose the right Agilent products for your applications and apply them successfully. Every instrument and system we sell has a global warranty. Two concepts underlie Agilent's overall support policy: "Our Promise" and "Your Advantage."

### Our Promise

Our Promise means your Agilent test and measurement equipment will meet its advertised performance and functionality. When you are choosing new equipment, we will help you with product information, including realistic performance specifications and practical recommendations from experienced test engineers. When you receive your new Agilent equipment, we can help verify that it works properly and help with initial product operation.

### Your Advantage

Your Advantage means that Agilent offers a wide range of additional expert test and measurement services, which you can purchase according to your unique technical and business needs. Solve problems efficiently and gain a competitive edge by contracting with us for calibration, extra-cost upgrades, out-of-warranty repairs, and onsite education and training, as well as design, system integration, project management, and other professional engineering services. Experienced Agilent engineers and technicians worldwide can help you maximize your productivity, optimize the return on investment of your Agilent instruments and systems, and obtain dependable measurement accuracy for the life of those products.



## Agilent Open

### [www.agilent.com/find/open](http://www.agilent.com/find/open)

Agilent Open simplifies the process of connecting and programming test systems to help engineers design, validate and manufacture electronic products. Agilent offers open connectivity for a broad range of system-ready instruments, open industry software, PC-standard I/O and global support, which are combined to more easily integrate test system development.

**For more information on Agilent Technologies' products, applications or services, please contact your local Agilent office.**

### Phone or Fax

#### United States:

(tel) 800 829 4444  
(fax) 800 829 4433

#### Canada:

(tel) 877 894 4414  
(fax) 800 746 4866

#### China:

(tel) 800 810 0189  
(fax) 800 820 2816

#### Europe:

(tel) 31 20 547 2111

#### Japan:

(tel) (81) 426 56 7832  
(fax) (81) 426 56 7840

#### Korea:

(tel) (080) 769 0800  
(fax) (080)769 0900

#### Latin America:

(tel) (305) 269 7500

#### Taiwan:

(tel) 0800 047 866  
(fax) 0800 286 331

#### Other Asia Pacific

#### Countries:

(tel) (65) 6375 8100  
(fax) (65) 6755 0042

Email: [tm\\_ap@agilent.com](mailto:tm_ap@agilent.com)

Contacts revised: 05/27/05

**The complete list is available at:**  
[www.agilent.com/find/contactus](http://www.agilent.com/find/contactus)

Product specifications and descriptions in this document subject to change without notice.

© Agilent Technologies, Inc. 1999, 2000, 2004, 2005, 2006  
Printed in USA, June 8, 2006  
5988-7988EN

Microsoft®, Windows® and MS-DOS® are U.S. registered trademarks of Microsoft Corporation.

National Instrument™ and LabView™ are trademarks of National Instruments Corporation.

Intel® and Pentium® are US registered trademarks of Intel Corporation.



**Agilent Technologies**