

Keysight 81150A and 81160A Pulse Function Arbitrary Noise Generator

User's Guide

NOTICE: This document contains references to Agilent Technologies. Agilent's former Test and Measurement business has become Keysight Technologies. For more information, go to www.keysight.com.



Notices

© Keysight Technologies 2011, 2014

No part of this manual may be reproduced in any form or by any means (including electronic storage and retrieval or translation into a foreign language) without prior agreement and written consent from Keysight Technologies as governed by United States and international copyright laws.

Manual Part Number

81160-91020

Edition

Edition 2.0, August 2014

Printed in Germany

Keysight Technologies, Deutschland GmbH

Herrenberger Str. 130

71034 Böblingen, Germany

For Assistance and Support

<http://www.keysight.com/find/assist>

Warranty

The material contained in this document is provided “as is,” and is subject to being changed, without notice, in future editions. Further, to the maximum extent permitted by applicable law, Keysight disclaims all warranties, either express or implied, with regard to this manual and any information contained herein, including but not limited to the implied warranties of merchantability and fitness for a particular purpose. Keysight shall not be liable for errors or for incidental or consequential damages in connection with the furnishing, use, or performance of this document or of any information contained herein. Should Keysight and the user have a separate written agreement with warranty terms covering the material in this document that conflict with these terms, the warranty terms in the separate agreement shall control.

Technology Licenses

The hardware and/or software described in this document are furnished under a license and may be used or copied only in accordance with the terms of such license.

Restricted Rights Legend

If software is for use in the performance of a U.S. Government prime contract or subcontract, Software is delivered and licensed as “Commercial computer software” as defined in DFAR 252.227-7014 (June 1995), or as a “commercial item” as defined in FAR 2.101(a) or as “Restricted computer software” as defined in FAR 52.227-19 (June 1987) or any equivalent agency regulation or contract clause. Use, duplication or disclosure of Software is subject to Keysight Technologies’ standard commercial license terms, and non-DOD Departments and Agencies of the U.S. Government will receive no greater than Restricted Rights as defined in FAR 52.227-19(c)(1-2) (June 1987). U.S. Government users will receive no greater than Limited Rights as defined in FAR 52.227-14 (June 1987) or DFAR 252.227-7015 (b)(2) (November 1995), as applicable in any technical data.

Safety Notices

CAUTION

A **CAUTION** notice denotes a hazard. It calls attention to an operating procedure, practice, or the like that, if not correctly performed or adhered to, could result in damage to the product or loss of important data. Do not proceed beyond a **CAUTION** notice until the indicated conditions are fully understood and met.

WARNING

A **WARNING** notice denotes a hazard. It calls attention to an operating procedure, practice, or the like that, if not correctly performed or adhered to, could result in personal injury or death. Do not proceed beyond a **WARNING** notice until the indicated conditions are fully understood and met.

Safety Summary

General Safety Precautions

The following general safety precautions must be observed during all phases of operation of this instrument. Failure to comply with these precautions or with specific warnings elsewhere in this manual violates safety standards of design, manufacture, and intended use of the instrument.

Keysight Technologies assumes no liability for the customer's failure to comply with these requirements.

Before operation, review the instrument and manual for safety markings and instructions. You must follow these to ensure safe operation and to maintain the instrument in safe condition.

General

This product is a Safety Class 1 instrument (provided with a protective earth terminal). The protective features of this product may be impaired if it is used in a manner not specified in the operation instructions.

All Light Emitting Diodes (LEDs) used in this product are Class 1 LEDs as per IEC 60825-1.

Environment Conditions

This instrument is intended for indoor use in an installation category II, pollution degree 2 environment. It is designed to operate at a maximum relative humidity of 95% and at altitudes of up to 2000 meters.

Refer to the specifications tables for the ac mains voltage requirements and ambient operating temperature range.

Before Applying Power

Verify that all safety precautions are taken. The power cable inlet of the instrument serves as a device to disconnect from the mains in case of hazard. The instrument must be positioned so that the operator can easily access the power cable inlet. When the instrument is rack mounted the rack must be provided with an easily accessible mains switch.

Ground the Instrument

To minimize shock hazard, the instrument chassis and cover must be connected to an electrical protective earth ground. The instrument must be connected to the ac power mains through a grounded power cable, with the ground wire firmly connected to an electrical ground (safety ground) at the power outlet. Any interruption of the protective (grounding) conductor or disconnection of the protective earth terminal will cause a potential shock hazard that could result in personal injury.

Do Not Operate in an Explosive Atmosphere

Do not operate the instrument in the presence of flammable gases or fumes.

Do Not Remove the Instrument Cover

Operating personnel must not remove instrument covers. Component replacement and internal adjustments must be made only by qualified personnel.

Instruments that appear damaged or defective should be made inoperative and secured against unintended operation until they can be repaired by qualified service personnel.

Safety Symbols on Instruments



Indicates warning or caution. If you see this symbol on a product, you must refer to the manuals for specific Warning or Caution information to avoid personal injury or damage to the product.



Notice for European Community: This product complies with the relevant European legal Directives: EMC Directive 89/336/EEC and Low Voltage Directive 73/23/EEC.



General Recycling Mark for plastic parts used in the product.



Safety requirements for electrical equipment for measurement, control, and laboratory use CAN/CSA C22.2 No. 1010.1 (1993) UL 3101, 3111 (First Editions). This equipment has also been evaluated to IEC 61010 edition 1 including amendments 1 and 2.



Conformity Mark of the Australian ACA for EMC compliance.

Environmental Information

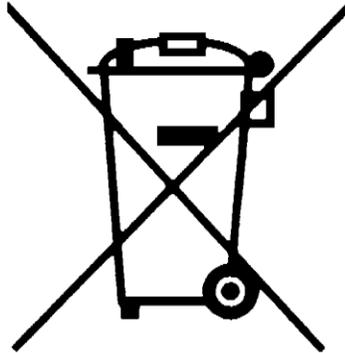

This product complies with the WEEE Directive (2002/96/EC) marketing requirements. The affixed label indicates that you must not discard this electrical/electronic product in domestic household waste.

Product category: With reference to the equipment types in the WEEE Directive Annexure I, this product is classed as a "Monitoring and Control instrumentation" product.

Do not dispose in domestic household waste.

To return unwanted products, contact your local Keysight office, or see

www.keysight.com/environment/product/
for more information.

Contents

Contents	6
1 Introduction	13
2 Front-Panel Menu Operation	17
2.1 The Front Panel.....	19
2.2 Help is Available	24
2.3 The Front-Panel Display at a Glance.....	25
2.3.1 Menu Mode.....	25
2.3.2 Graph Mode.....	26
2.4 The Front-Panel Number Entry.....	27
2.5 The Rear Panel.....	28
2.6 Preparing the 81150A / 81160A for Use.....	30
2.7 Using the Built-in Help System.....	31
2.8 Selecting the Mode of Operation	32
2.9 Selecting Trigger Mode and Source.....	33
2.10 Selecting the Waveform.....	37
2.11 Selecting the Advanced Mode.....	40
2.11.1 Modulation	40
2.11.2 Burst.....	41
2.11.3 Sweep.....	42
2.12 Setting the Output Frequency.....	43
2.13 Setting the Output Amplitude.....	45
2.13.1 Converting the amplitude from one unit to another.....	47
2.14 Selecting Delay.....	48
2.15 Selecting DC Volts	50
2.16 Setting a DC Offset Voltage	51
2.17 Setting the Duty Cycle of a Square Wave	53
2.18 Setting the High-Level and Low-Level Values	54
2.19 Configuring a Pulse Waveform.....	55
2.20 Setting up a Pattern.....	57

2.21	Viewing a Waveform Graph	59
2.22	Outputting a Stored Arbitrary Waveform	60
2.23	Selecting the Output Termination	62
2.24	Outputting a Modulated Waveform	64
2.25	Outputting an FSK Waveform	67
2.26	Outputting a PWM Waveform	70
2.27	Outputting a Frequency Sweep	72
2.28	Outputting a Burst Waveform	75
2.29	Triggering a Sweep or Burst	78
2.30	Storing the Instrument State	79
2.31	Configuring the Remote Interface	82
2.31.1	GPIB Configuration	82
2.31.2	USB Configuration	83
2.31.3	LAN Configuration	84
2.32	Resetting the 81150A / 81160A	89
3	Features and Functions	90
3.1	Trigger Mode	92
3.1.1	Arming Source	94
3.1.2	Arming Slope	96
3.1.3	Internal Trigger Period/Frequency	97
3.2	Output Configuration	99
3.2.1	Output Function	99
3.2.2	Output Frequency	101
3.2.3	Output Amplitude	104
3.2.4	DC Offset Voltage	107
3.2.5	Output Units	109
3.2.6	Load Impedance	110
3.2.7	Output Source Impedance	111
3.2.8	Voltage Autoranging	112
3.2.9	Amplifier Type Selection	113
3.2.10	Digital Channel Addition	114
3.2.11	Voltage Limits	115
3.2.12	Duty Cycle (Square Waves)	116
3.2.13	Symmetry (Ramp Waves)	118

3.2.14	Output Control	119
3.2.15	Parameter Coupling.....	120
3.2.16	Polarity.....	124
3.2.17	Strobe Output.....	125
3.2.18	Trigger Output.....	126
3.2.19	Sync Output.....	127
3.3	Input Configuration.....	129
3.3.1	External In Parameters.....	130
3.3.2	Modulation In Parameters.....	134
3.3.3	Reference Clock.....	139
3.4	Pulse Waveforms.....	141
3.4.1	Pulse Period	142
3.4.2	Pulse Width.....	143
3.4.3	Leading Edge/Trailing Edge	145
3.5	Pattern Capabilities.....	148
3.5.1	Pattern Mode	149
3.5.2	Pattern Source	150
3.5.3	Configuring the External Pattern Source.....	152
3.5.4	Selecting a Pattern.....	159
3.5.5	Creating, Editing and Storing a Pattern	161
3.5.6	Bitshape Selection.....	168
3.5.7	Creating, Editing and Storing a Bitshape.....	170
3.5.8	Triggered and Gated Patterns.....	176
3.6	Noise.....	178
3.7	Amplitude Modulation (AM).....	180
3.7.1	Selecting AM Modulation.....	181
3.7.2	Carrier Waveform Shape.....	182
3.7.3	Carrier Frequency.....	183
3.7.4	Modulating Waveform Shape.....	184
3.7.5	Modulating Waveform Frequency.....	185
3.7.6	Modulating Depth.....	186
3.7.7	DSSC (Double Sideband Suppressed Carrier Mode)	188
3.7.8	Modulating Source	190
3.8	Frequency Modulation (FM).....	191
3.8.1	Selecting FM Modulation.....	192
3.8.2	Carrier Waveform Shape.....	193

3.8.3	Carrier Frequency.....	194
3.8.4	Modulating Waveform Shape.....	195
3.8.5	Modulating Waveform Frequency.....	196
3.8.6	Peak Frequency Deviation.....	197
3.8.7	Modulating Source	198
3.9	Phase Modulation (PM)	199
3.9.1	Selecting PM Modulation	200
3.9.2	Carrier Waveform Shape.....	201
3.9.3	Carrier Frequency.....	202
3.9.4	Modulating Waveform Shape.....	203
3.9.5	Modulating Waveform Frequency.....	204
3.9.6	Phase Deviation.....	205
3.9.7	Modulating Source	206
3.10	Frequency-Shift Keying (FSK) Modulation.....	207
3.10.1	Selecting FSK Modulation	208
3.10.2	Carrier Waveform Shape.....	209
3.10.3	FSK Carrier Frequency.....	210
3.10.4	FSK "Hop" Frequency.....	211
3.10.5	FSK Rate	212
3.10.6	FSK Source	213
3.11	Pulse Width Modulation (PWM).....	214
3.11.1	Selecting PWM Modulation	215
3.11.2	Pulse Waveform	216
3.11.3	Pulse Period	217
3.11.4	Modulating Waveform Shape.....	218
3.11.5	Modulating Waveform Frequency.....	219
3.11.6	Width Deviation.....	220
3.11.7	Duty Cycle Deviation	221
3.11.8	Modulating Source	224
3.12	Frequency Sweep.....	225
3.12.1	Selecting a Sweep.....	227
3.12.2	Start Frequency and Stop Frequency.....	228
3.12.3	Center Frequency and Frequency Span.....	229
3.12.4	Idle Frequency.....	231
3.12.5	Sweep Type.....	232
3.12.6	Sweep Time.....	234
3.12.7	Marker Frequency.....	235

3.12.8	Triggered/Gated Sweep.....	236
3.13	Burst Mode.....	238
3.13.1	Selecting a Burst.....	239
3.13.2	Continuous Burst Mode.....	240
3.13.3	Triggered Burst Mode.....	241
3.13.4	Gated Burst Mode.....	242
3.13.5	Burst Count.....	243
3.13.6	Burst Phase.....	244
3.14	Arbitrary Waveforms.....	245
3.14.1	Creating and Storing an Arbitrary Waveform.....	246
3.14.2	Managing Stored Waveforms.....	253
3.14.3	Additional Information on Arbitrary Waveforms.....	256
3.15	System-Related Operations.....	257
3.15.1	Instrument State Storage.....	258
3.15.2	Export/Import State.....	261
3.15.3	Error Conditions.....	263
3.15.4	Beeper Control.....	265
3.15.5	Display Brightness.....	266
3.15.6	Display Control.....	267
3.15.7	Time.....	269
3.15.8	Date.....	270
3.15.9	Firmware Revision Query.....	271
3.15.10	SCPI Language Version Query.....	272
3.16	Remote Interface Configuration.....	273
3.16.1	GPIB Address.....	274
3.16.2	DHCP/Auto-IP On/Off (LAN).....	275
3.16.3	IP Address (LAN).....	276
3.16.4	Subnet Mask (LAN).....	277
3.16.5	Default Gateway (LAN).....	278
3.16.6	Host Name.....	279
3.16.7	Domain Name (LAN).....	280
3.16.8	DNS Server (LAN).....	281
3.16.9	WINS Server (LAN).....	282
3.16.10	Current Configuration (LAN).....	284
3.17	Software Update.....	286
3.18	Installing Licenses.....	288

3.19	Diagnostics/Calibration Overview.....	290
3.20	Security.....	293
3.21	Factory Default Settings.....	294
4	Remote Programming Reference	299
4.1	Keysight 81150A / 81160A Remote Control.....	299
4.1.1	Programming Recommendations.....	300
4.2	81150A / 81160A SCPI Command Summary	302
4.3	Common Command Summary	315
4.4	81150A / 81160A SCPI Instrument Command List Format.....	317
4.5	81150A / 81160A SCPI Instrument Elements Name.....	318
4.5.1	APPLY Commands	319
4.5.2	Arbitrary Waveform Commands.....	329
4.5.3	Burst Commands	352
4.5.4	Level Commands.....	361
4.5.5	Modulation Commands.....	371
4.5.6	Channel Command	414
4.5.7	Output Commands.....	416
4.5.8	Output Function Commands.....	431
4.5.9	Reference Clock Commands.....	465
4.5.10	Non-Volatile Storage Commands.....	468
4.5.11	Status Reporting Commands.....	482
4.5.12	Sweep Commands.....	488
4.5.13	System-Related Commands.....	499
4.5.14	Display Commands.....	520
4.5.15	Triggering Commands.....	524
4.5.16	Pattern Related Commands.....	536
4.6	Common Command List.....	573
4.7	Status Model.....	576
4.7.1	Status register structure.....	578
4.7.2	Status Byte Register.....	579
4.7.3	STATus Commands	580
4.7.4	STATus Questionable Data Register command subsystem	580
4.8	Programming Basics.....	583
4.8.1	Before you begin.....	583
4.8.2	Application Programs.....	587

5	Error Messages.....	595
6	Application Programs.....	597
7	Tutorial.....	599
7.1	Direct Digital Synthesis.....	600
7.2	Creating Arbitrary Waveforms.....	604
7.3	Pulse Waveform Generation.....	607
7.4	Pattern Generation.....	609
7.4.1	Multi-Level Pattern Definitions.....	610
7.4.2	Pattern Types and Sequencing Capabilities.....	612
7.4.3	Trigger Modes.....	613
7.4.4	Defining the Shape of a Bit.....	614
7.4.5	External Patterns.....	618
7.5	Noise Generation.....	620
7.5.1	Limitations of User-defined Noise Distributions.....	622
7.6	Trigger Modes.....	624
7.7	External In to Trigger Out Timing.....	627
7.8	Signal Imperfections.....	629
7.9	Output Amplitude Control.....	631
7.10	Attributes of AC Signals.....	634
7.11	Modulation.....	637
7.12	Frequency Sweep.....	644
7.13	Burst.....	647
7.14	Channel Addition.....	649
7.15	Coupling between Channels.....	651
A	Appendix.....	653
A.1	Coupled Parameters when channel coupling is on.....	653
A.2	Pulse Parameter Definitions.....	656
A.3	Keysight 81150A / 81160A in comparison with other Keysight instruments.....	663
A.3.1	Keysight 81110A/81104A/81101A instrument family.....	663
A.3.2	Keysight 33220A.....	665
A.4	Preparing a USB Flash Drive using Windows Vista®.....	668

1 Introduction

**Keysight
Technologies’
81150A / 81160A
Pulse Function
Arbitrary Noise
Generator**

The Keysight Technologies 81150A and 81160A is a Pulse Pattern and Function Arbitrary Noise Generator with built-in arbitrary waveform and pulse capabilities

Its combination of bench-top and system features makes this Pulse Function Arbitrary Noise Generator a versatile solution for your testing requirements now and in the future.

**Features and
Benefits**

- 81150A: 1 μ Hz-120 MHz pulse generation with variable rise/fall time
- 81150A: 1 μ Hz-240 MHz sine waveform outputs
- 81160A: 1 μ Hz-330 MHz pulse generation with variable rise/fall time
- 81160A: 1 μ Hz-500 MHz sine waveform outputs
- Pulse, sine, square, ramp, noise and arbitrary waveforms
- FM, AM, PM, FSK, PWM modulation capability
- One or two channels
- 81150A: 14-bit, 2GSa/s, 512 KSa deep arbitrary waveform memory per channel
- 81160A: 14-bit, 2.5GSa/s, up to 256 KSa deep arbitrary waveform memory per channel
- USB, GPIB and LAN connectivity.
- Glitch free change of timing parameters delay, frequency, transition time, width, duty cycle
- LXI class C compliant

Benchtop Testing

The 81150A / 81160A features a graphic display showing all pulse parameters at a glance. The cursor keys and the modify knob allow fast and simple operation.

The user interface is designed to minimize the time invested in getting familiar with the instrument. After familiarization, the instrument supports quick setups of signals. This leaves you free to concentrate on the measurement task and testing of the DUT.

What's inside this Manual This manual provides detailed information about the following:

- Front-Panel Menu Operation
- Features and Functions
- Remote Programming Reference
- Error Messages
- Application Programs
- Tutorial

Purpose of this Manual The purpose of this manual is to enable you to install, initialize, and start the 81150A / 81160A and to understand the front-panel menu features of the 81150A / 81160A.

Who should read this Manual This manual is intended for testers and Engineers who will be using the 81150A / 81160A to test other devices.

How this document is organized This section provides information on the chapters, and their content.

Navigating this manual

Topic	What information does it contain?
Introduction	Introduces the 81150A / 81160A, defines the purpose and intended audience of this manual; explains how information is organized in this manual.
Front-Panel Menu Operation	Introduces you to the Front-Panel Menu and describes some of the menu features of the 81150A / 81160A Pulse Pattern and Function Arbitrary Noise Generator.
Features and Functions	Gives a detailed description of the 81150A / 81160A's capabilities and operation. You will find this section useful when you are operating the 81150A / 81160A from the front panel or over the remote interface.

Topic	What information does it contain?
Remote Programming Reference	Contains reference information to help you program the 81150A / 81160A over the remote interface.
Error Messages	Describes the error reporting model that is used by the 81150A / 81160A.
Application Programs	Describes the various types of programming examples available for the 81150A / 81160A and where to find them.
Tutorial	Gives an overview of the internal operations of the 81150A / 81160A.

Terms and conventions used in this manual

The following table lists the terms and conventions used in this manual:

Conventions

The icon...	Indicates...
	A note or important information.
	A tip
	A caution or warning
	Notes within a table

Acronyms used in this manual

The following table lists the acronyms and abbreviations used in this manual:

Acronyms used in this Document

Acronym	Explanation
DHCP	Dynamic Host Configuration Protocol
DNS	Domain Name Service
DUT	Device Under Test

Appendix

References

The **Getting Started Guide** along with this manual forms a part of the 81150A and 81160A product documentation suite.

2 Front-Panel Menu Operation

Introduction

This section introduces the front-panel menu and describes the menu features of the 81150A / 81160A Pulse Pattern and Function Arbitrary Noise Generator.

**What's inside this
Chapter**

The following topics are discussed in this section:

- The Front Panel
- Help is Available
- The Front-Panel Display at a Glance
 - Menu Mode
 - Graph Mode
- The Front-Panel Number Entry
- The Rear Panel
- Preparing the 81150A / 81160A for Use
- Using the Built-in Help System
- Selecting the Mode of Operation
- Selecting Trigger Mode
- Selecting the Waveform
- Selecting the Advanced Mode
- Setting the Output Frequency
- Setting the Output Amplitude
- Selecting Delay
- Selecting DC Volts
- Setting a DC Offset Voltage
- Setting the Duty Cycle of a Square Wave
- Setting the High-Level and Low-Level Values
- Configuring a Pulse Waveform
- Setting up a Pattern
- Viewing a Waveform Graph
- Outputting a Stored Arbitrary Waveform
- Selecting the Output Termination
- Outputting a Modulated Waveform
- Outputting an FSK Waveform
- Outputting a PWM Waveform
- Outputting a Frequency Sweep
- Outputting a Burst Waveform
- Triggering a Sweep or Burst
- Storing the Instrument State
- Configuring the Remote Interface
- Resetting the 81150A / 81160A

2.1 The Front Panel

Introduction

The instrument is mainly operated from the front panel, when used for benchtop testing.

This section explains the Keys, Functions, Inputs/Outputs and Controls, seen on the Front Panel of the 81150A / 81160A.

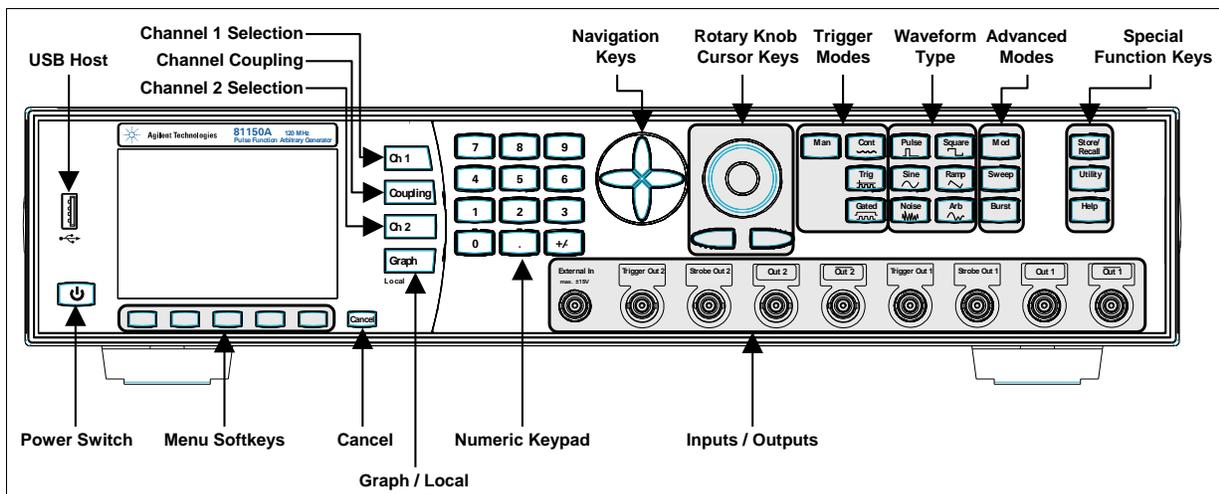

Front Panel of the 81150A

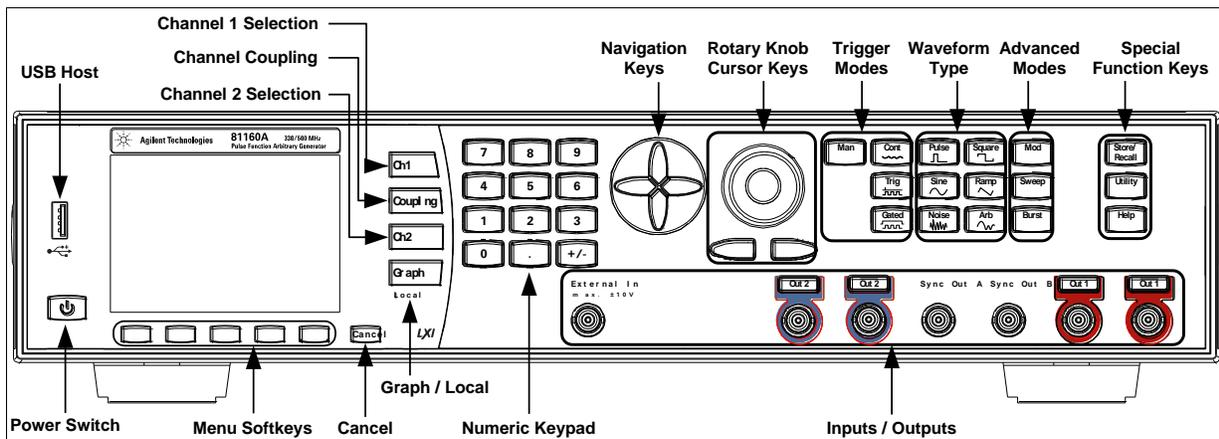

Front Panel of the 81160A

Power Switch The front panel switch is used to switch on and off the instrument. When the front panel switch is off, the instrument is in standby mode. The instrument is disconnected from the AC line power only by disconnecting the power cord.

USB The Front Panel contains a USB host connector. It is intended to connect USB drives to store instrument states and waveforms on an external memory.

Menu Softkeys The five keys below the main display screen are called softkeys (software-controlled keys). The current function of each softkey is indicated in the corresponding box on the display.

Some softkeys hold additional symbols to indicate that they provide extended functionality.

- **Yellow Triangles:**  These are visible on the five softkeys on the Front Panel. The yellow triangles indicate that there are more choices further, and keep pressing to view the available options.
- **White Rectangles:**  Indicate that by pressing them, you can enter into another screen.

The following examples explain the above-mentioned points:



Pressing this softkey will toggle between Frequency and Period representation.



Pressing this softkey will open the output configuration screen.

More Key Pressing the **MORE** key switches to the next layer of softkeys on the current screen.

Cancel

Pressing the **Cancel** key cancels the selection/input and helps you exit out of a screen. But the functionality of exiting out of a screen is limited to a few screens, like selecting an Arbitrary waveform.

Ch 1**Coupling****Ch 2**

The 81150A / 81160A consists of two channels and operates in two different modes of operation:

Coupling off: The two channels operate entirely independent. Frequency generation for both channels is based on same clock reference.

Coupling on: The frequency, trigger mode, waveform type and advanced mode are identical for both channels. The delay between the channels is specified.

A modulation input (for AM, FM, PM, FSK, PWM) for each channel is provided on the back-panel. In the two channel version each channel can modulate the other channel.

Refer to the Appendix for a list of all coupled parameters.

Graph

Press the **Graph** key to view a graphical representation of the waveform. Press it again to exit from that mode.

Not every screen has a graphical representation, e.g. like the Trigger Mode Screen.

**Numeric Keypad,
Cursor Keys,
Rotary Knob**

These keys are used to select and modify parameters when operating the instrument.

Use the numeric keypad to enter numbers and the menu softkeys to select units.

Use the Rotary knob and cursor keys to modify the displayed number.

Inputs/Outputs

The major inputs and outputs of the instrument are available at the front panel:

- The external input (**EXTERNAL IN**) can be used to connect an external arming source (triggered or gated modes).
- The trigger signal (**TRIGGER OUT**) marks the start of the pulse period or of parts of a pattern (see Mode/Trigger Screen.). You can set the output levels according to the used technology (TTL and ECL) or enter test-specific values. Trigger Out is available as a physical BNC connector at the 81150A. For the 81160A, a 'Logical Trigger Signal' is generated for channel 1 and channel 2 internally and is routed to the physical BNC connector Sync Out A and/or Sync Out B using a configurable switch matrix.
- The strobe signal (**STROBE OUT**) marks beginning and end of a burst in Burst mode. Strobe Out is available as a physical BNC connector at the 81150A. For the 81160A, a 'Logical Strobe Signal' is generated for channel one and channel 2 internally and is routed to the physical BNC connector Sync Out A and/or Sync Out B using a configurable switch matrix.
- 81160A only: The sync signal (**SYNC OUT**) outputs the 'Logical Trigger Signal' and/or the 'Logical Strobe Signal' at the front panel BNC connector. The instrument offers full flexibility how 'Logical Trigger Signal' and/or 'Logical Strobe Signal' is routed to Sync Out A and/or Sync Out B.
- The **OUTPUT** connectors provide the signal output (normal and inverted) and the indicators show the current state of the output (on or off).

Special Function Keys

The instrument provides the following special function keys:

- Man
- Store/Recall
- Help

The function of each of these keys is explained below.



In triggered or gated mode, the **MAN** key can be used to manually arm and/or trigger the instrument.

Trigger Modes

The trigger modes are explained below in subsequent sections:

- Continuous
- External Triggered
- External Gated
- Internal Triggered
- Manual

See Selecting Trigger Mode section for more details.

Waveform Types

The standard waveforms include: Pulse, Sine, Noise, Square, Ramp and Arbitrary.

The predefined arbitrary waveforms include: Exponential rise, exponential fall, $\sin(x)/x$, cardiac, gaussian, haversine, negative ramp, and DC.

Advanced modes of Operation

There are three advanced modes of operation available:

- Modulation: Selects the modulation type from AM, FM, PM, FSK, PWM.
- Sweep: For frequency sweeps.
- Burst: Repeats selected waveform n times.

The following sections provide more details on the modulation types.



The **Store/Recall** key can be used to store to/recall from 1 to 4 individual settings in the instrument memory. In the internal memory location 0 there is a default setting stored.



The **Utility** key enables you to enable/disable DC mode, change the Output Setup, and also contains information about the I/O Interfaces and the system settings of the 81150A / 81160A.



The **Help** key provides access to the instrument's integrated help or in warning or error state, access to Warning/Error Report screen.

2.2 Help is Available

Introduction Whenever you are in doubt or the instrument signals warnings or errors, press the **Help** key.



Pressing the **Help** key opens the 'Main Help Page'. This main help page is the table of contents of the integrated help system which lists all the help topics. You can obtain information by selecting the corresponding link and then by pressing the **Follow Link** softkey.

Warnings and Errors If there are warnings or errors pending (indicated by a flashing W or E on the screen), pressing the **Help** key displays a list of the current messages. Using the Error Queue and Warning softkeys, you can toggle between both lists. For more information on warnings and errors, see Warnings and Errors.

Exit Help To exit Help, press the **Help** key again, or press any other parameter screen key, e.g. Pulse, Sine, etc.

2.3 The Front-Panel Display at a Glance

Introduction This section explains the Menu and the Graph mode as seen on the Front Panel of the 81150A / 81160A.

2.3.1 Menu Mode

Introduction This section explains the Menu as seen on the Front Panel of the 81150A / 81160A.

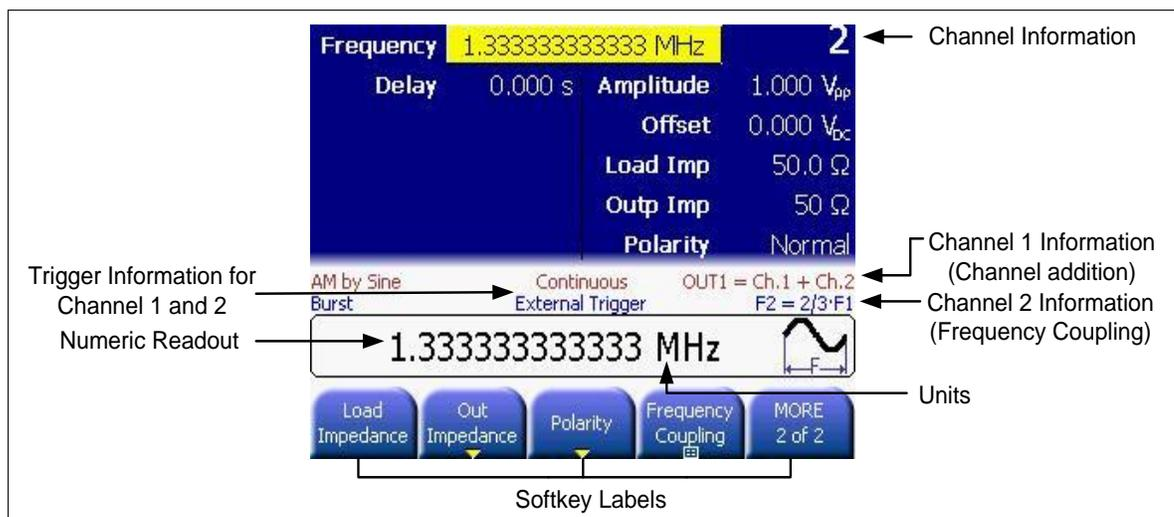

2.3.2 Graph Mode

Introduction

To enter the Graph mode, press the **Graph** key.

To exit, press the **Graph** key again.

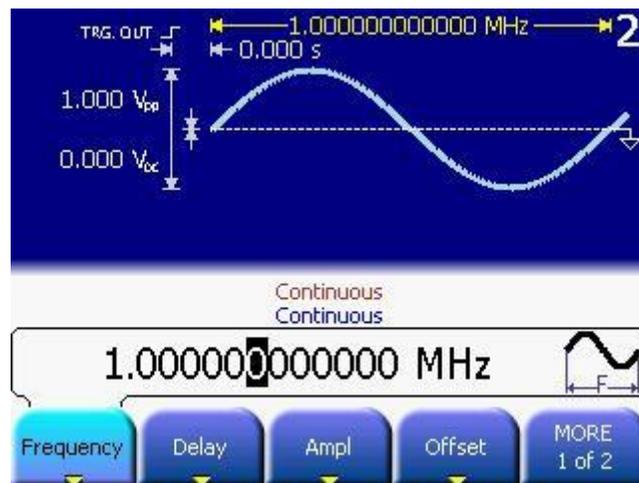

- Not all screens have a graphical representation.
 - The trigger mode screen will always be in textual mode, even if graph mode is enabled.
-

2.4 The Front-Panel Number Entry

Entering/modifying numbers You can enter numbers or modify the displayed number from the front-panel using one of the following two methods:

- Rotary Knob + Arrow Keys
- Numeric keypad + softkeys

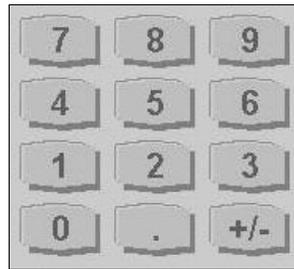

For selecting units Use the numeric keypad and menu softkeys to select the units.



- The left/right arrows below the Rotary Knob are used to move left and right to select the digit to be modified on a given screen.
 - When setting the cursor to the 'exponent field' the exponent can be changed via the Rotary Knob (only if the resulting number does fall within the allowed range)
 - The cursor position is remembered when the cursor is placed on the leftmost digit and the value is decreased from 1 to 0. In this case the cursor changes it's color to green for some seconds and the cursor position will be set back to the previous one when incrementing the value again. For example, select the frequency to be edited and set the cursor to the leftmost digit and then decrement the value by turning the Rotary Knob counter clockwise. The cursor will move one digit to the right when the digit would go from 1 to 0 and changes it's color to green. When incrementing while the cursor is green, it will jump back to the initial digit when crossing the 0 to 1 border.
 - The left arrow key can be used to delete the digit left to the input cursor when entering values with the numeric keypad.
-

2.5 The Rear Panel

Introduction

The rear panel contains:

- GP-IB connector
- USB device connector
- LAN connector

These three are used for remote control of the instrument.

- Channel 1 Modulation In
- Channel 2 Modulation In
- 10 MHz Clock Ref-In
- 10 MHz Clock Ref-Out

A USB Host Connector is used to connect external USB storage device for storing instrument settings or software updates.

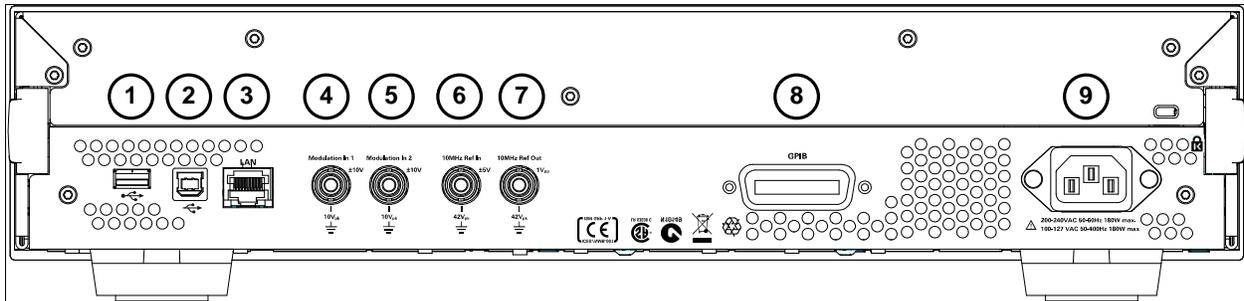

Rear panel of the 81150A

- 1** USB Interface Connector (Host type for external mass memory)
- 2** USB Interface Connector (device type for remote programming)
- 3** LAN Interface Connector
- 4** Channel 1 External Modulation Input Terminal
- 5** Channel 2 External Modulation Input Terminal
- 6** External 10 MHz Reference Input Terminal
- 7** 10 MHz Reference output Terminal
- 8** GPIB Interface Connector
- 9** Power

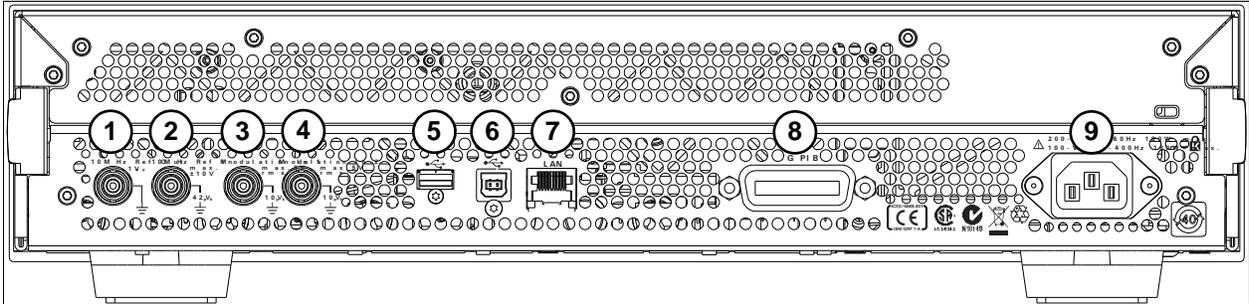

Rear panel of the 81160A

- 1** 10 MHz Reference Output Terminal
 - 2** External 10 MHz Reference Input Terminal
 - 3** Channel 1 External Modulation Input Terminal
 - 4** Channel 2 External Modulation Input Terminal
 - 5** USB Interface Connector (Host type for external mass memory)
 - 6** USB Interface Connector (device type for remote programming)
 - 7** LAN Interface Connector
 - 8** GPIB Interface Connector
 - 9** Power
-

2.6 Preparing the 81150A / 81160A for Use

Check the List of supplied items

Before preparing the 81150A / 81160A for use, check the list of supplied items, given below:

- One Power Cord
 - USB Cable
 - Product CD
 - This User's Guide (if ordered in printed version)
 - Getting Started Guide (if ordered in printed version)
 - Certificate of Calibration
 - Keysight Automation Ready CD
-

Connect the Power Cord and turn on the 81150A / 81160A

The instrument runs a short power-on self test, which takes about 45-50 seconds. The 81150A / 81160A powers up in the sine wave function at 1 MHz with an amplitude of 1 Vpp (into a 50Ω termination) or the power-down setting. At power-on, the Output connector is disabled. To enable the Output connector, press the **output** key.

If the 81150A / 81160A does not turn on....

Steps:

- Verify that the power cord is firmly connected to the power receptacle on the rear panel (the power-line voltage is automatically sensed at power-on).
 - You should also make sure that the 81150A / 81160A is connected to a power source that is energized.
 - Then, verify that the 81150A / 81160A is turned on.
-



If the power-on tests fail, the instrument automatically switches to the diagnostics screen and displays the power on messages.

2.7 Using the Built-in Help System

Introduction

The built-in help system is designed to provide context-sensitive assistance on any front-panel key or menu softkey. A list of help topics is also available to assist you with several front-panel operations.

To view the help information for a function key

Steps:

- Press and hold down the key. If the message contains more information than will fit on the display, press the up/down keys or turn the knob to view the remaining information.
 - Press the **Help** key to exit Help.
-

To view the list of topics

Steps:

- Press the **Help** key to view the list of available help topics.
 - To scroll through the list, press the up/down arrow keys or rotate the knob. Select any topic using the **Previous Link** and **Next Link** keys, and press **Follow link** to obtain details on the selected topic.
 - Press the **Help** key to exit Help.
-

To view the help information for displayed messages

Whenever a limit is exceeded or any other invalid configuration is found, the 81150A / 81160A will display a message. For example, if you enter a value that exceeds the frequency limit for the selected function, a message will be displayed. The built-in help system shows all active messages.

Steps:

- Press the **Help** key. Upon doing this, you will see an error or warning is active (red or yellow text scrolling on the display and a red E or orange W indicator blinking in the input line). The instrument will automatically switch to the error or warning screen.
 - Press the **Help** key to exit Help.
-

2.8 Selecting the Mode of Operation

Introduction

The Mode of operation consists of the following four components:

- Coupling between Ch1 & Ch2
- Trigger Mode
- Waveform Type
- Advanced Modes

These are further explained below:

Coupling between Ch1 & Ch2

There are two output channels available for the Keysight 81150A / 81160A. The 2 channel version operates in two different modes of operation:

Coupling off: The two channels operate entirely independent. Frequency generation for both channels is based on the same clock reference.

Coupling on: The frequency, trigger mode, waveform type and advanced mode are identical for both channels. The delay between the channels is specified.

Refer to the Appendix for a list of all coupled parameters.



The Trigger Mode, Waveform Type and the Advanced Modes are explained in the following sections.

2.9 Selecting Trigger Mode and Source

Introduction

The source of a trigger event can be **Internal**, **External**, or **Manual**. The default is **External**.

The following trigger modes are explained below:

- Continuous
- External Triggered
- External Gated
- Internal Triggered
- Manual

The following table explains the functionality of the 81150A / 81160A.

Appendix

Trigger Mode	Continuous						
Function	Pulse	Square	Sine	Ramp	Noise	Arb	DC
Arming Source	Not Applicable						
Advanced Mode	None Burst Sweep Modulation						

Trigger Mode	Triggered						
Function	Pulse	Square	Sine	Ramp	Noise	Arb	
Arming Source	MAN Key External-In Internal						
Advanced Mode	None Burst Sweep						

Trigger Mode	Gated						
Function	Pulse	Square	Sine	Ramp	Noise	Arb	
Arming Source	MAN Key External-In						
Advanced Mode	None Burst Sweep						

Continuous

Continuous starts the next waveform cycle immediately after the previous one has finished.

This is used for a continuous waveform, burst, sweep or modulation. The external input is not used in continuous mode.

External Triggered Triggered generates exactly one 'signal' when the trigger condition is met. In the external trigger mode, the 81150A / 81160A will accept a hardware trigger applied to the front-panel **External In** connector. The 81150A / 81160A initiates one sweep or outputs one burst each time **External In** receives a pulse with the specified edge.

To select the external source, follow these steps:

- Press the  key on the front panel.
- Press **Source** softkey to select **External In** as the source. Upon pressing the **Source** softkey while the highlight is on the trigger source, the instrument allows you to choose one of the available trigger sources. The value can also be changed by turning the Rotary Knob.

To specify whether the 81150A / 81160A triggers on the rising or falling edge, follow these steps:

- Press the  key on the front panel.
- Select the desired edge by pressing the **Ext-In Sense** softkey.
- Change the value either by pressing the softkey or by turning the knob.

External Gated Gated starts the generation of 'signals' as long as the gate is active. The active level (high or low) at **External In** enables waveforms, bursts or sweeps. The last waveform, burst or sweep is always completed.

Internal Triggered In internal triggered mode, the instrument triggers a single waveform cycle, sweep or burst at an adjustable trigger rate.

E.g. generate a pulse every 250ms

This mode is enabled by pressing the  key on the front panel and then setting source to **Internal**. As soon as Source is set to **Internal**, the trigger frequency/period can be adjusted by navigating to **Int Freq** or **Int. Period** (depends on which of the two is currently active). Switching between **Int Freq** and **Int Period** is done by navigating to the internal trigger frequency/period and then pressing the corresponding softkey.

Manual

In the manual trigger mode, you can manually trigger the 81150A / 81160A by pressing the front panel  key. The 81150A / 81160A initiates one waveform cycle, sweep or outputs one burst for each time you press or release the key. The  key is illuminated while the 81150A / 81160A is waiting for a manual trigger.

Front Panel Operation

To set the Trigger Mode, do the following:

- Press the corresponding key on the Front-Panel.
 - For selecting the arming source, press the Front panel key for the desired trigger mode, press the **Source** softkey or navigate to Source using the navigation keys.
 - Then change the selection.
-

2.10 Selecting the Waveform

Introduction

The 81150A / 81160A can output six standard waveforms including:

- Pulse
- Sine
- Square
- Ramp
- Noise
- Arbitrary

You can also select one of the seven built-in arbitrary waveforms or create your own custom waveforms.

You can internally modulate any of the standard waveforms (except pulse and noise and DC) and also arbitrary waveforms using AM, FM, PM or FSK.

Pulse Waveform Characteristics

A pulse is defined by the following parameters:

- Amplitude/Offset or High-Level/Low-Level
 - Period or Frequency (not applicable for triggered pulses)
 - Width in seconds or Duty Cycle or Trailing delay in seconds
 - Delay in seconds
 - Delay as percentage of the period (not applicable for triggered pulses)
 - Delay as phase in degree (not applicable for triggered pulses)
 - Leading edge transition time in seconds
 - Leading edge transition time in percent of width
 - Trailing edge transition time in seconds
 - Trailing edge transition time in percent of width
 - Polarity
 - Source Impedance
 - Load Impedance
-

**Pattern
Characteristics**

Patterns are defined by the following parameters:

- Internal or external pattern source
 - PRBS patterns and user defined patterns
 - NRZ formatting and Arbitrary Bit Waveform
 - Pattern Mode - On/Off
 - Patterns are also characterized by 2, 3 or 4 different levels per bit
 - Adjustable loop offset, allowing emulation of initialization preamble and looped test pattern
 - External pattern source allows re-timing and re-shaping of externally provided data stream
-

**Sine Wave
Characteristics**

A sine wave is defined by the following parameters:

- Amplitude/Offset or High/Low Level
 - Period or Frequency
 - Delay in seconds
 - Delay in percent of period
 - Delay as phase in degree
 - Polarity
 - Source Impedance
 - Load Impedance
-

**Square Wave
Characteristics**

A square wave is defined by the following parameters:

- Amplitude/Offset or High-Level/Low-Level
- Period or Frequency
- Duty Cycle
- Delay in seconds
- Delay as percentage of the period
- Delay as phase in degree
- Polarity
- Source Impedance
- Load Impedance

The instrument will always generate the fastest possible transition times when generating square waves.

**Ramp Wave
Characteristics**

A ramp is defined by the following parameters:

- Amplitude/Offset or High/Low Level
 - Period or Frequency
 - Delay in seconds
 - Delay in percent of period
 - Delay as phase in degree
 - Symmetry point in percent of period.
 - Polarity
 - Source Impedance
 - Load Impedance
-

**Noise Wave
Characteristics**

Noise is defined by the following parameters:

- Amplitude/Offset or High/Low Level
 - Probability Density Function (PDF)
 - Source Impedance
 - Load Impedance
-

**Arbitrary Wave
Characteristics**

Arbitrary waveforms are defined by the following parameters:

- Amplitude/Offset or High/Low Level
- Period or Frequency
- Delay in seconds
- Delay in percent of period
- Delay as phase in degree
- Source Impedance
- Load Impedance

81150A: Arbitrary waveforms can have up to 512k samples. The local waveform editor allows to create and edit waveforms with up to 16k samples.

81160A: Arbitrary waveforms can have up to 256k samples (1 channel) / 128k samples (2 channels). The local waveform editor allows to create and edit waveforms with up to 16k samples.

2.11 Selecting the Advanced Mode

Introduction

There are three advanced modes of operation available:

- Modulation
- Burst
- Sweep

These advanced modes are further explained below.

2.11.1 Modulation

Introduction

The following types of modulation are available:

- AM
 - FM
 - PM
 - FSK
 - PWM
-

To select Modulation

Refer to Chapter 3, Features and Functions to understand how to select any of these modulations.



- The 81150A / 81160A will allow only one modulation mode to be enabled at a time. For example, you cannot enable AM and FM at the same time. When you enable AM, the previous modulation mode is turned off.
 - The 81150A / 81160A will not allow any advanced mode to be enabled with another advanced mode on the same channel.
-

2.11.2 Burst

Introduction You can configure the 81150A / 81160A to output a waveform with a specified number of pulses/waveform cycles, called a burst. You can output the burst at a rate determined by the internal rate generator or the signal level on the Front Panel **External In** connector.

A burst can be initiated either by:

- An Internal Immediate event, which triggers a continuous burst.
- A trigger source, which triggers a triggered burst.
- An active gate, which enables a gated burst.

Select the function and amplitude for the burst For burst waveforms, you can select sine, square, ramp, pulse, or arbitrary waveforms.

Burst mode cannot be used when using DC or noise.

Select the burst mode

- Press  and specify the **#Cycles** and the **Start Phase** softkeys to set the desired values.
- The Start Phase defines the phase at which signal generation starts. The allowed range is -360° to $+360^\circ$. It is only applicable to Sine and Arb waveforms.

 Refer to Outputting a Burst Waveform for details.

2.11.3 Sweep

Introduction In the frequency sweep mode, the 81150A / 81160A “**steps**” from the start frequency to the stop frequency at a sweep rate which you specify. The 81150A / 81160A can produce a frequency sweep for sine, square, ramp, or arbitrary waveforms (pulse, noise, and dc are not allowed).

To select a Sweep Press  to output a sweep using the present settings for frequency, output amplitude, and offset. Enable sweep *before* setting up any of the other sweep parameters.



The 81150A / 81160A will not allow the sweep mode to be enabled at the same time when burst or any modulation mode is enabled. When you enable sweep, the burst or modulation mode is turned off.

2.12 Setting the Output Frequency

Introduction

At power-on, normally, the instrument outputs the same setting as before power-down. The default frequency is 1 MHz and the default amplitude is 1 V_{pp}.

When you change functions, the same frequency is used if the present value is valid for the new function.

The following steps show you how to change the frequency.

Press the “Frequency” softkey

To set the waveform frequency, press the **Frequency** softkey. Pressing the frequency softkey when Frequency is already selected, will toggle to Period. The current selection is highlighted as shown in the image below.

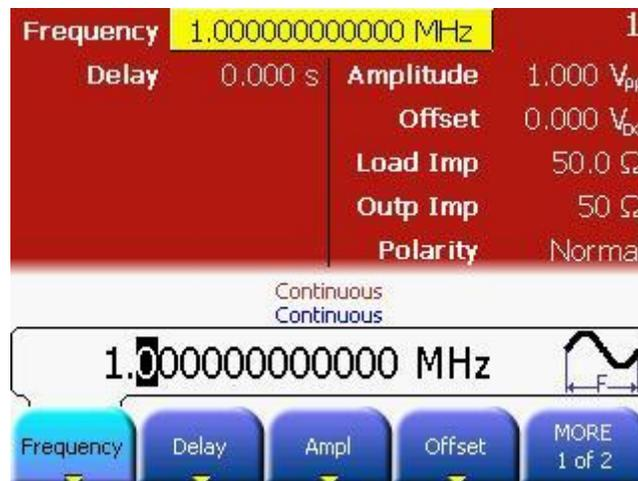

Enter the magnitude of the desired frequency

Using the numeric keypad, enter the desired value, say 1.2

Select the desired units

Select and press the softkey that corresponds to the desired units. Press the **More** softkey to view more units available for the current selection. When you select the units, the 81150A / 81160A outputs a waveform with the displayed frequency (if the output is enabled).

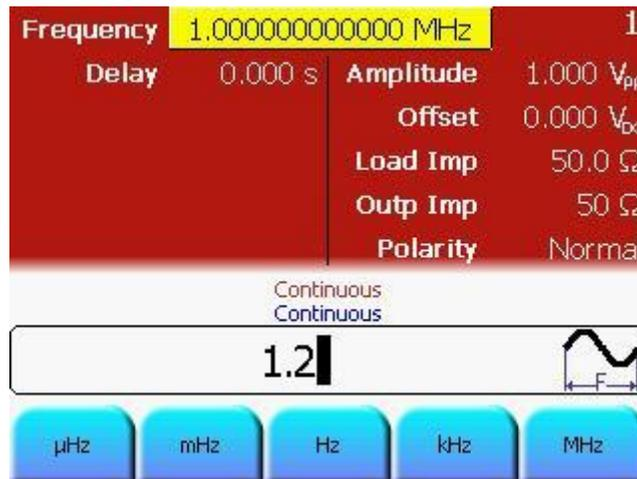

- You can also enter the desired value using the knob and cursor keys.
- You can also change the exponent by setting the input cursor to the exponent field and turning the Rotary Knob. To do this, use the left/right key to place the cursor on the exponent you wish to change.

2.13 Setting the Output Amplitude

Introduction

At power-on, normally, the instrument outputs the same setting as before power-down.

When you change functions, the same amplitude is used if the present value is valid for the new function.

The following steps show you how to change the amplitude:

Press the “Ampl” softkey

To set the amplitude using a high level and low level, press the **Ampl** softkey.

- This will offer the level representations and units that can be chosen for the output levels.
- Choose the appropriate option from the given choices.
- Press **More** to go to the units screen. Choose from the given units, by pressing that unit itself.

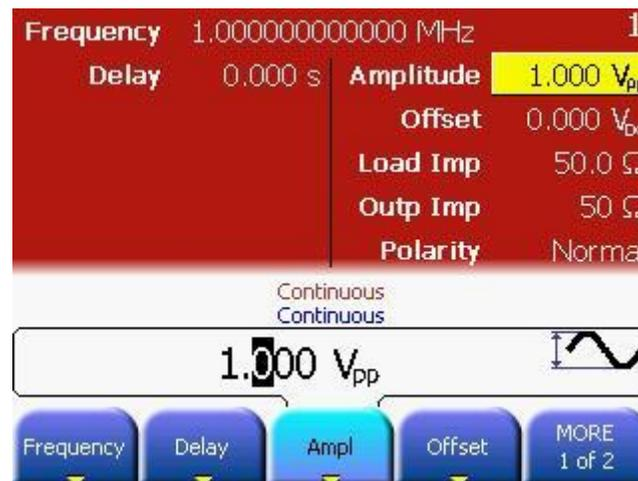

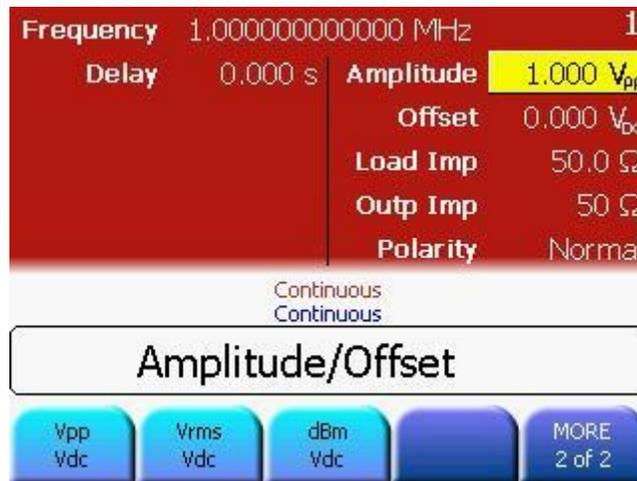
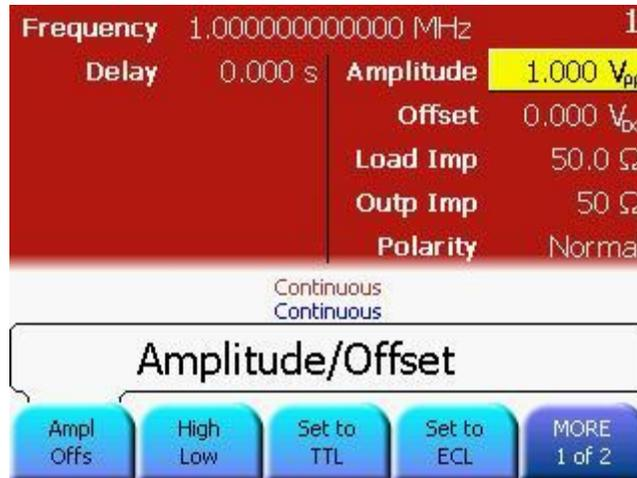

Enter the magnitude of the desired amplitude

Using the numeric keypad, enter the desired value.

Select the desired units

Select and press the softkey that corresponds to the desired units. When you select the units, the 81150A / 81160A outputs a waveform with the displayed amplitude (if the output is enabled). *For this example, press mVrms.*

2.13.1 Converting the amplitude from one unit to another

Introduction You can easily convert the displayed amplitude from one unit to another.

For example, the following steps show you how to convert the amplitude from Vrms to Vpp.

Enter the numeric entry mode To switch between different representations, press the amplitude, offset, high level, low level softkey and then choose the different representation. You can choose between High/Low, Ampl/Offs.

Select the new units Steps:

- Press **Ampl** softkey and then press the **MORE** softkey.
- This brings you to another menu layer where you can choose between Vpp/Vdc, Vrms/Vdc, dBm/Vdc that will be used when Ampl/Offs is selected. The same softkey menu provides easy application of TTL and ECL level settings.

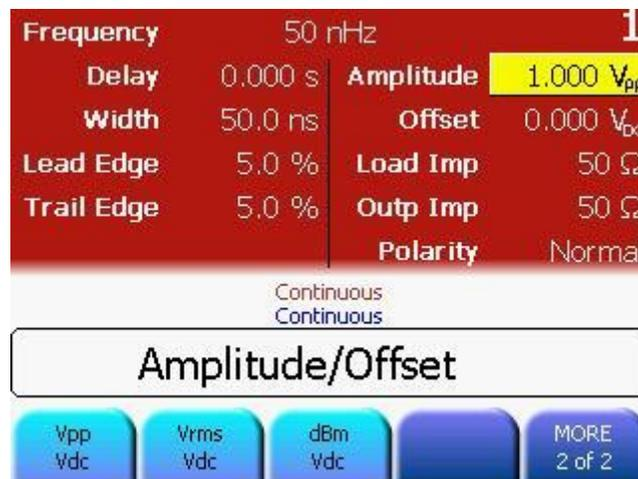

2.14 Selecting Delay

Introduction

The time between the start of a period until the start of the waveform is called the delay. The start of a period is defined when the delay is set to 0ns. It can be measured between the Trigger Out and Out Connector.

Delay Format

Delay has the following format:

- Abs. Delay
- % of Period
- Phase

To select Delay

Steps:

- Press the **Delay** softkey.
- This will show the available choices for the delay format.

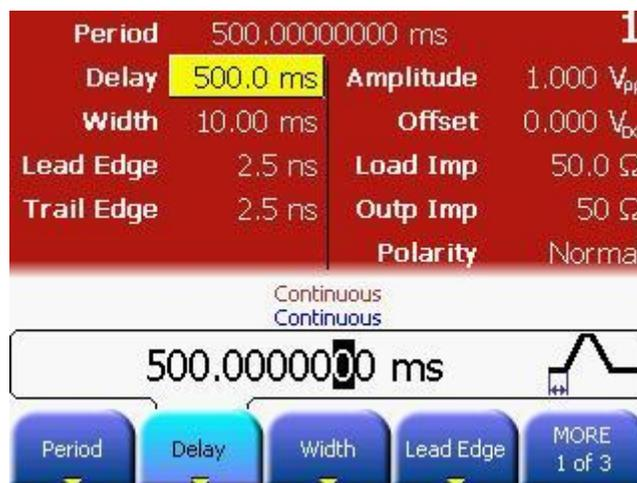

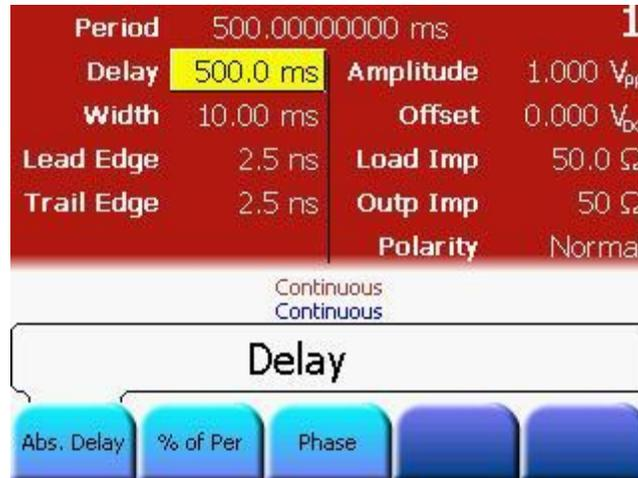

Abs. Delay Defines the time between the start of a period until the start of the waveform in units of seconds.

% of Per Defines the time between the start of a period till the start of the waveform as a percentage of the period.

Phase Defines the time between the start of a period till the start of the waveform in degrees (1/360 of the period).

 Selecting any of the delay formats will take you back to the main screen.

2.15 Selecting DC Volts

Introduction

You can select the "DC Volts" feature from the "Utility" menu, and then set a constant dc voltage as an "Offset" value. As an example, let us set "DC Volts" = -1.5 Vdc.

To select DC Volts

Steps:

- Press  and then press the **DC Mode** softkey.
- Press the **DC** softkey to toggle between DC mode off and on. When DC mode is being turned off, then the instrument will switch back to the parameter screen of the waveform being generated.

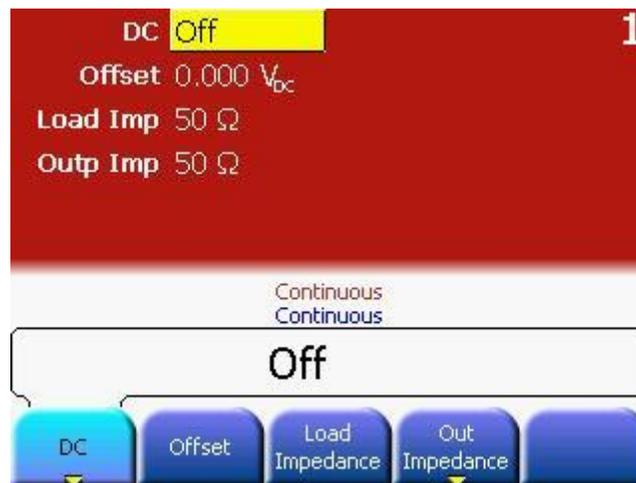

2.16 Setting a DC Offset Voltage

Introduction At power-on, normally, the instrument outputs the same setting as before power-down.
The following steps show you how to change the offset.

Press the “Offset” softkey

Steps:

- Press the **Offset** softkey to select the DC offset voltage. Enter the desired voltage level as an “**Offset**” (as shown in the image below)

When you change functions, the same offset is used if the present value is valid for the new function.

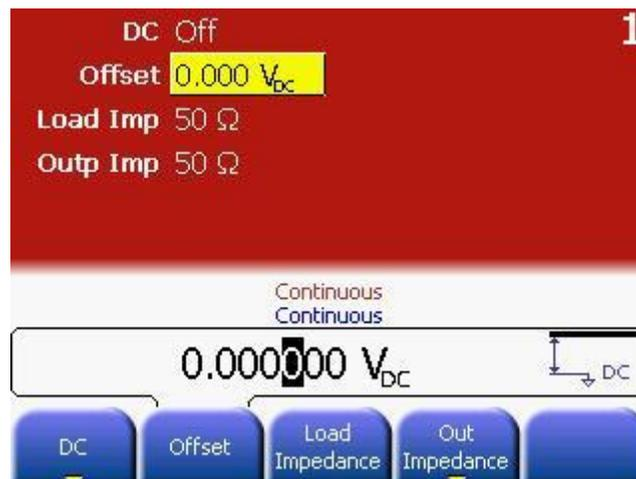

Enter the magnitude of the desired offset

Using the numeric keypad, enter the value “-1.5” (as shown in the image below).

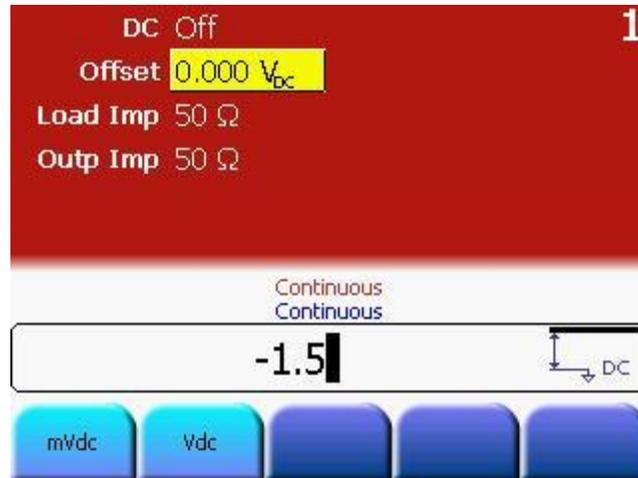

Select the desired units

Select and press the softkey that corresponds to the desired units. You can choose from **mVdc** or **Vdc**. When you select the units, the 81150A / 81160A outputs the waveform with the displayed offset (if the output is enabled). For this example, press **Vdc**.

2.17 Setting the Duty Cycle of a Square Wave

Introduction At power-on, normally, the instrument outputs the same setting as before power-down.
The duty cycle is limited by the minimum pulse width of W_{min} .
This means the duty cycle can get as low as $(100\% * W_{min}/period)$ and as high as $(100\% * (1 - W_{min}/period))$

81150A: Where W_{min} is either 4.1ns or 10ns depending on the selected amplifier (See section Amplifier Type Selection).

81160A: Where W_{min} is 1.5ns.

The following steps show you how to change the duty cycle to 30%.

Select the square wave function

Press the  key and then set the desired output frequency to any value up to 120 MHz for the 81150A (330 MHz for the 81160A).

Press the “Duty Cycle” softkey

The duty cycle represents the amount of time per cycle that the square wave is at a high level.

Enter the desired duty cycle

Using the numeric keypad or the knob, select a duty cycle value of “30”. The 81150A / 81160A adjusts the duty cycle immediately and outputs a square wave with the specified value (if the output is enabled).

2.18 Setting the High-Level and Low-Level Values

Introduction

You can specify a signal by setting its amplitude and dc offset values. Another way to set the limits of a signal is to specify its high-level (maximum) and low-level (minimum) values. This is typically convenient for digital applications.

In the following example, let us set the high-level to 1.0 V and the low-level to 0.0 V.

To Set the High-Level and Low-Level Values

Steps:

- Press the **Ampl** softkey to select **Ampl**.
 - Press the softkey again to toggle to show the different representations of the output voltages.
 - Press the High Low softkey to select High level and Low level
 - Both the Ampl and Offset softkeys toggle together, to **High** and **Low**, respectively.
 - Set the **High** Level value using the numeric keypad or the knob.
 - Press the **Low** Level softkey and set the value using the numeric keypad or the knob.
-



These settings (high-level = "1.0 V" and low-level = "0.0 V") are equivalent to setting an amplitude of "1.0 Vpp" and an offset of "500 mVdc".

2.19 Configuring a Pulse Waveform

Introduction

You can configure the 81150A / 81160A to output a pulse waveform with variable pulse width and edge time.

The following steps show you how to configure a 500 ms pulse waveform with a pulse width of 10 ms and edge times of 50 ns.

Pulses do not have period/frequency when being triggered and burst is off. In all other cases, a pulse does have a period/frequency like other waveforms.

Select the pulse function

Press the  key to select the pulse function and output a pulse waveform with the default parameters. This is only true if the instrument is currently using the default setting.

Set the pulse period

Press the **Frequency** softkey to toggle to Period. Set the Pulse period to 500 ms.

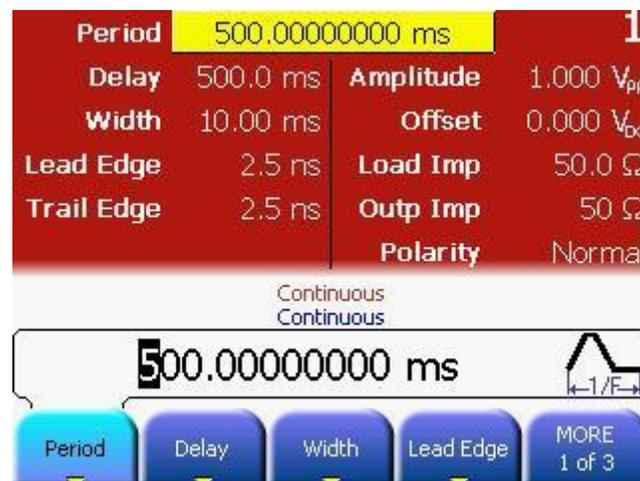

Set the pulse width Press the **Width** softkey and then set the pulse width to 10 ms. The pulse width represents the start of leading edge to start of trailing edge.

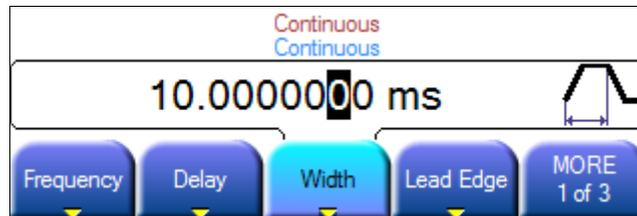

Set the edge time for both edges Press the **Lead Edge** and **Trail Edge** softkeys and then set the edge time for both the rising and falling edges to 50 ns. The edge time represents the time from the 10% threshold to the 90% threshold of each edge.

2.20 Setting up a Pattern

Introduction

The pattern functionality can be accessed on the local user interface through the **Pattern Setup** key on the pulse screen.

Press the "Pattern Setup" key

Press the  key to select the Pulse function.

- Press the **Pattern Setup** softkey shown in the image below.

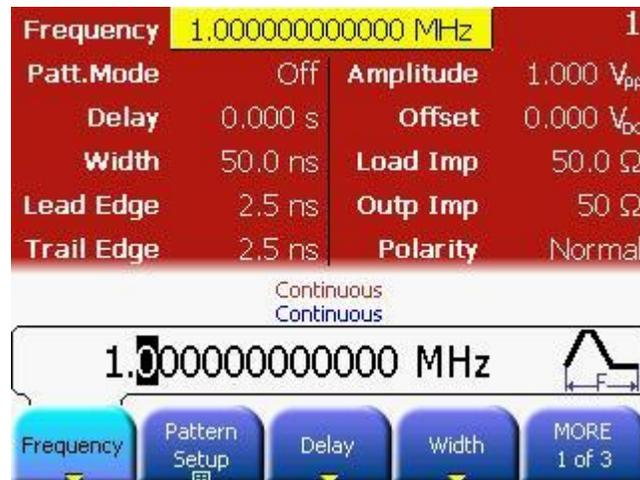

- This will show the Pattern Setup screen as shown in the following image.



Pattern Mode

- Press the **Select Pattern** softkey to select from the available built-in PRBS patterns or user defined patterns.
- Use the Rotary Knob or up/down Arrow keys to select.

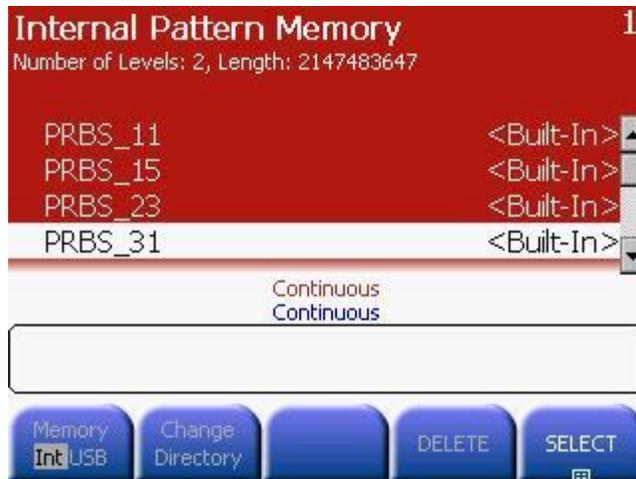

2.21 Viewing a Waveform Graph

Introduction

In the Graph Mode, you can view a graphical representation of the current waveform parameters. The softkeys are listed in the same order as in the normal display mode, and they perform the same function.

However, only one label, **Frequency** or **Period** is displayed for each softkey at one time.

Enable the Graph Mode

Press the  key to enable the Graph Mode.

Select the desired parameter

To select a specific parameter, note the softkey labels at the bottom of the display. For example, to select delay, press the **Delay** softkey.

- As in the normal display mode, you can edit numbers using either the numeric keypad or the knob and cursor keys.
- The parameter which is selected using the softkey highlights the same value in the graph diagram also. For e.g., if you select Period, then the value of Period will be highlighted in the graph.
- To exit the Graph Mode, press  again.

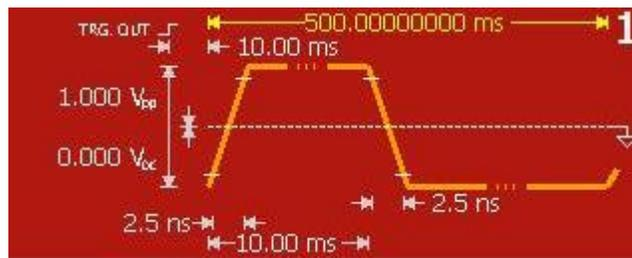

The  key also serves as a **Local** key to restore front-panel control after remote interface operations.

2.22 Outputting a Stored Arbitrary Waveform

Introduction

There are seven built-in arbitrary waveforms stored in the non-volatile memory.

The following steps show you how to output the built-in “exponential fall” waveform from the front panel.

Select the arbitrary waveform function



When you press the  key to select the arbitrary waveform function, the 81150A / 81160A displays the currently used waveform in the textual screens indicating which waveform is currently selected (the default is “exponential rise”).

Select the active waveform

Steps:

- Press the **MORE** softkey twice.
- This brings you to a screen which has **Select Waveform** softkey on it.
- Press the **Select Waveform** softkey and select from the given options. Choose the desired waveform and press select. Confirm your choice by pressing **Yes**.

The 81150A / 81160A has a graphical browser to select the waveform to be used. This waveform can either be a predefined one, or a user defined one (from VOLATILE memory or a stored waveform from NON-VOLATILE memory). It is also possible to import a waveform from a USB stick into VOLATILE memory.

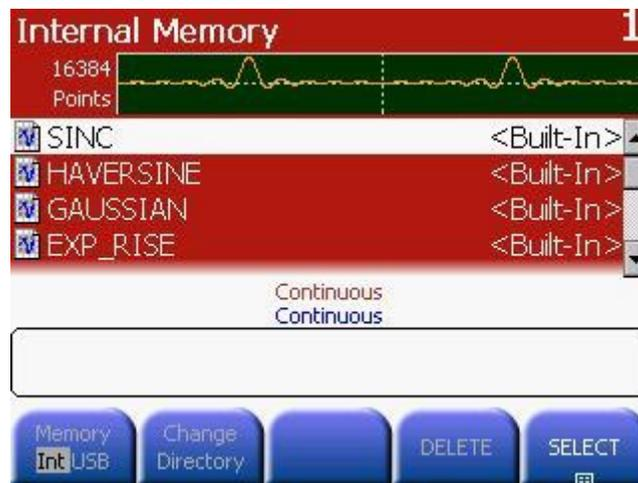
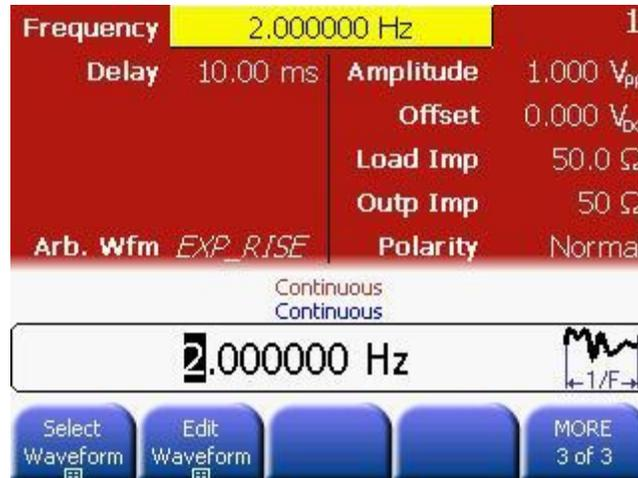

For information on creating a custom arbitrary waveform, refer to [Creating and Storing an Arbitrary Waveform](#).

2.23 Selecting the Output Termination

Introduction

The Keysight 81150A has a selectable series output impedance of either 50 ohms or 5 ohms to the front-panel output connector. If the actual load impedance is different than the value specified, the displayed amplitude and offset levels will be incorrect. The load impedance setting is simply provided as a convenience to ensure that the displayed voltage matches the expected load.



The Keysight 81160A has a fixed series output impedance of 50 ohms to the front-panel output connector.

Press any waveform screen

Press any of the waveform screens, i.e. Pulse, Sine, Square, Ramp, Noise or Arb to adjust the output and load impedance.

Navigate the menu to set the output termination

Press the **Load Impedance** and **Out Impedance** softkeys to set the desired values.

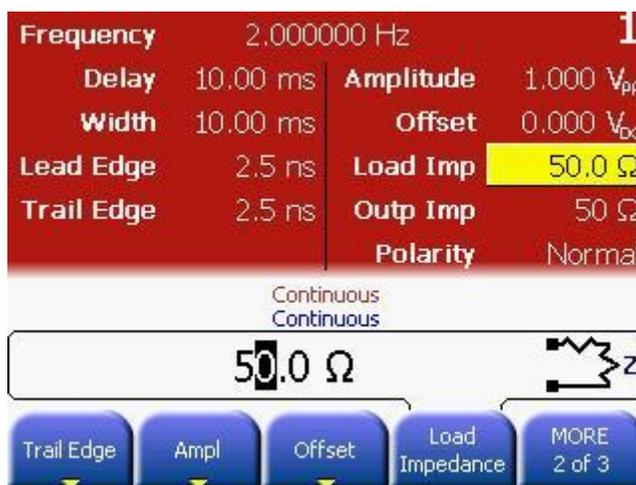

Select the output amplifier type and ranging

Press the  key and then select the **Output Setup** softkey.

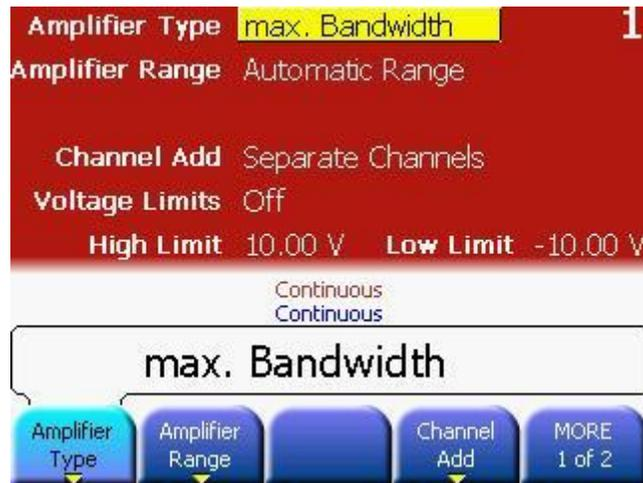

Select Amplifier Type and Range

For **Amplifier Type**, choose from max Amplitude or max Bandwidth.
 For **Amplifier Range**, choose from Hold, Auto or Auto Once.
 Refer to the Amplifier Type Selection section for more information.



The **Amplifier Type** selection is available for the 81150A, only.

2.24 Outputting a Modulated Waveform

Introduction

A modulated waveform consists of a carrier and a modulating waveform. In AM (amplitude modulation), the amplitude of the carrier is varied by the amplitude of the modulating waveform.

For this example, you will output an AM waveform with 80% modulation depth. The carrier will be a 5 kHz sine wave and the modulating waveform will be a 200 Hz sine wave.

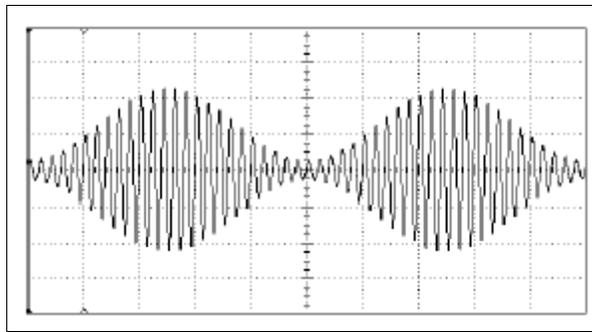

Select the function, frequency, and amplitude of the carrier

Press  and then press the **Frequency**, **Ampl**, and **Offset** softkeys to configure the carrier waveform. *For this example, select a 5 kHz sine wave with an amplitude of 5 Vpp.*

Select AM

Press  and then select "AM" using the **Type** softkey. Notice that a status message "AM by Sine" is shown in the status line. The status line is located between the parameters section of the screen and the input field.

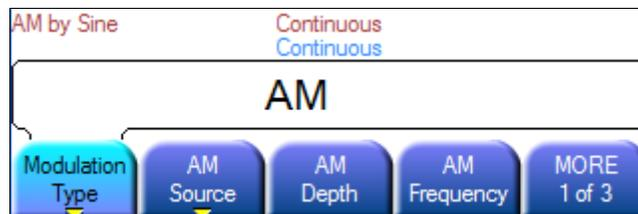

Set the modulation depth Press the **AM Depth** softkey and then set the value to 80% using the numeric keypad or the knob and cursor keys.

Set the modulating frequency Press the **AM Frequency** softkey and then set the value to 200 Hz using the numeric keypad or the knob and cursor keys.

Select the modulating waveform shape Press **More** and then press the **AM Shape** softkey to select the shape of the modulating waveform. For this example, select a sine wave. At this point, the 81150A / 81160A outputs an AM waveform with the specified modulation parameters (if the output is enabled).

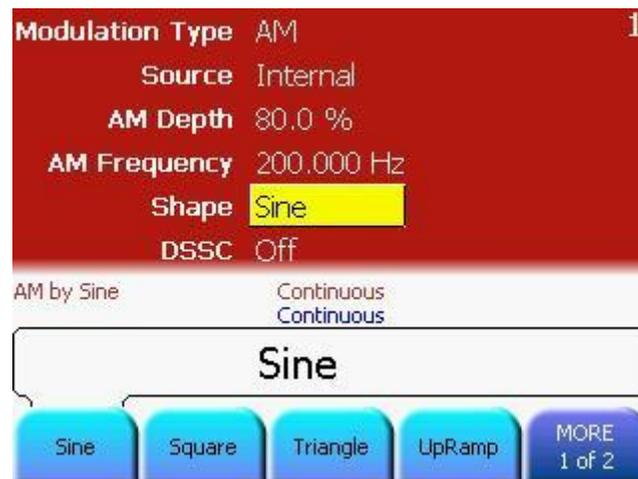
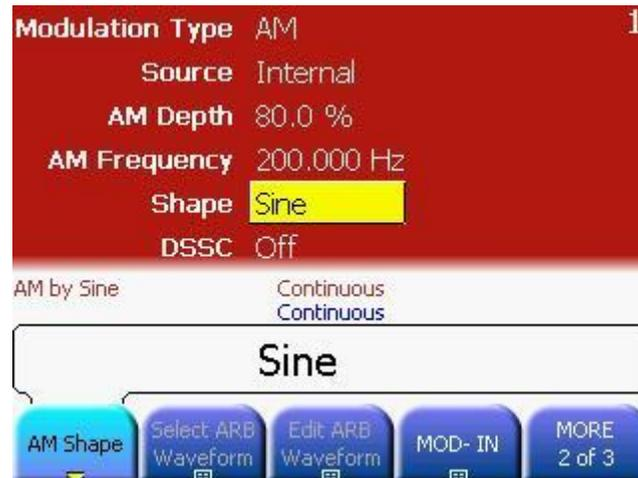

View the waveform

Press  to view the waveform parameters.

To turn off the Graph Mode, press  again.

2.25 Outputting an FSK Waveform

Introduction

You can configure the 81150A / 81160A to “shift” its output frequency between two preset values using FSK modulation. The rate at which the output shifts between the two frequencies (called the “carrier frequency” and the “hop frequency”) is determined by the internal rate generator or the signal level on the rear-panel **Modulation In** connector. (There is one Modulation In connector for each channel.)

For this example, you will set the “carrier” frequency to 3 kHz and the “hop” frequency to 500 Hz, with an FSK rate of 100 Hz.

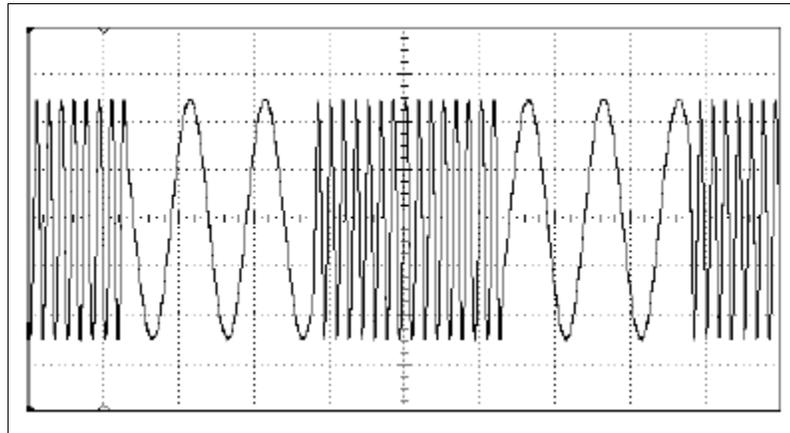

Select the function, frequency, and amplitude of the carrier

Press  and then press the **Frequency**, **Ampl**, and **Offset** softkeys to configure the carrier waveform.

For this example, select a 3 kHz sine wave with an amplitude of 5 Vpp.

Select FSK

Press  and then select FSK using the **Modulation Type** softkey.

Notice that a status message *FSK, Internal* is shown in the status line. This message is applicable for all waveforms.

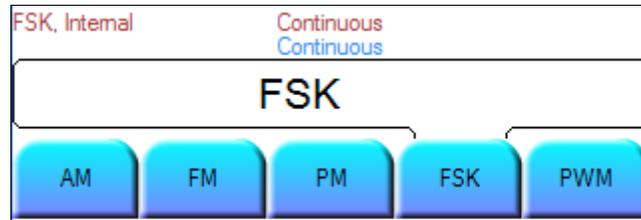

Set the “hop” frequency

Press the **Hop Freq** softkey and then set the value to 500 Hz using the numeric keypad or the knob and arrow keys.

Set the FSK “shift” rate

Press the **FSK Rate** softkey and then set the value to 100 Hz using the numeric keypad or the knob and arrow keys.

At this point, the 81150A / 81160A outputs an FSK waveform (if the output is enabled).

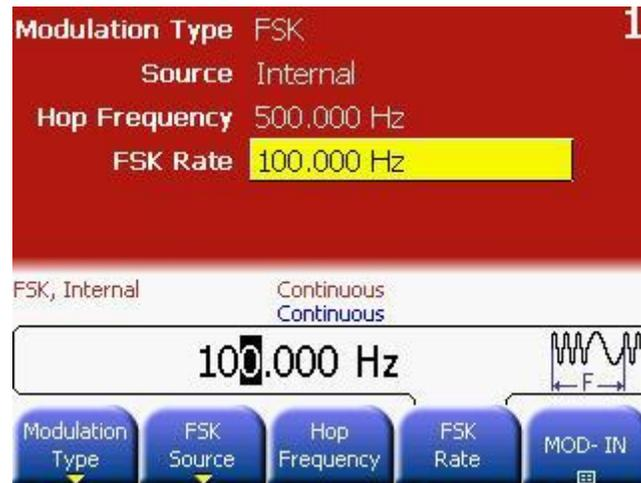

View the waveform

Press **Graph** to view the waveform parameters.

To turn off the Graph Mode, press **Graph** again.

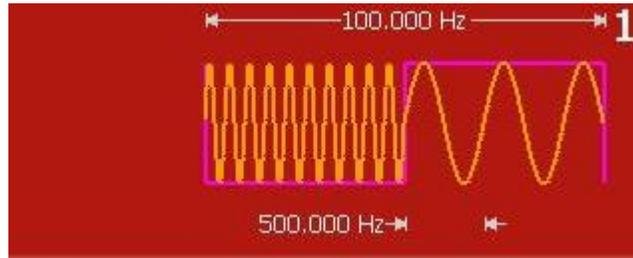

2.26 Outputting a PWM Waveform

Introduction

You can configure the 81150A / 81160A to output a pulse width modulated (PWM) waveform. The Keysight 81150A / 81160A provides PWM for pulse carrier waveforms, and PWM is the only type of modulation supported for pulse waveforms. In PWM, the pulse width or duty cycle of the carrier waveform is varied according to the modulating waveform. You can specify either a pulse width and width deviation, or a pulse duty cycle and duty cycle deviation, the deviation to be controlled by the modulating waveform.

For this example, you will specify a pulse width and pulse width deviation for a 1 kHz pulse waveform with a 100 Hz sine wave modulating waveform.

Select the carrier waveform parameters

Press  and then press the **Frequency**, **Delay**, **Ampl**, **Offset**, **Width**, and **Lead Edge** and **Trail Edge** softkeys to configure the carrier waveform.

For this example, select a 1 kHz pulse waveform with an amplitude of 1 Vpp, a 0 V offset, a pulse width of 500 μ s, and a lead edge of 70 ns and trail edge of 20 ns.

Select PWM

Press  (PWM is the only modulation type for **Pulse**). Notice that a status message "PWM by Sine" is shown in the status line.

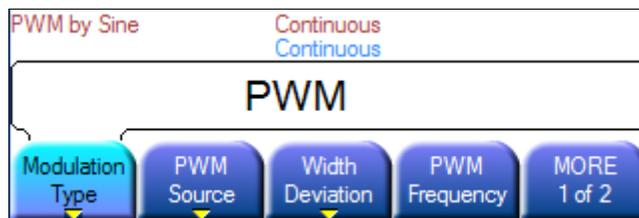

Set the width deviation Press the **Width Deviation** softkey and set the value to 400 μs using the numeric keypad or the knob and cursor keys.

Set the modulating frequency Press the **PWM Frequency** softkey and then set the value to 5 Hz using the numeric keypad or the knob and cursor keys.

Select the modulating waveform shape Press the **PWM Shape** softkey to select the shape of the modulating waveform. For this example, select a sine wave.
At this point, the 81150A / 81160A outputs a PWM waveform with the specified modulation parameters (if the output is enabled).

View the waveform Press **Graph** to view the waveform and parameters.
To turn off the Graph Mode, press **Graph** again.

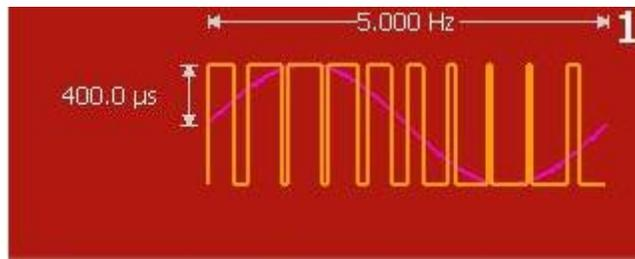

To really view the PWM waveform, you would need to output it to an oscilloscope. If you do this, you will see how the pulse width varies, in this case, from 100 to 900 μs . At a modulation frequency of 5 Hz, the deviation is quite visible.

2.27 Outputting a Frequency Sweep

Introduction

In the frequency sweep mode, the 81150A / 81160A “steps” from the *start frequency* to the *stop frequency* at a *sweep rate* which you specify. You can sweep up or down in frequency, and with either linear or logarithmic spacing.

For this example, you will output a swept sine wave from 50 Hz to 5 kHz. You will not change the other parameters from their default settings: internal sweep trigger, linear spacing, and 1 second sweep time.

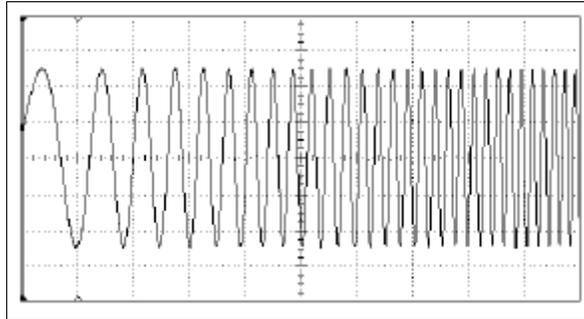

Select the function and amplitude for the sweep

For sweeps, you can select sine, square, ramp, or arbitrary waveforms (pulse, noise, and dc are not allowed). For this example, select a sine wave with an amplitude of 5 Vpp.

Select the sweep mode

Press  and then verify that the linear sweep mode is currently selected. Notice that a status message “*Linear Sweep*” is shown in the status line.

Set the start frequency

Press the **Start Frequency** softkey and then set the value to 50 Hz using the numeric keypad or the knob and cursor keys.



Set the stop frequency

Press the **Stop Frequency** softkey and then set the value to 5 kHz using the numeric keypad or the knob and cursor keys.

At this point, the 81150A / 81160A outputs a continuous sweep from 50 Hz to 5 kHz (if the output is enabled).





If desired, you can set the frequency boundaries of the sweep using a center frequency and frequency span. These parameters are similar to the start frequency and stop frequency and are included to give you added flexibility. To achieve the same results, set the center frequency to 2.525 kHz and the frequency span to 4.950 kHz.

View the waveform

Press  to view the waveform parameters.

To turn off the Graph Mode, press  again.

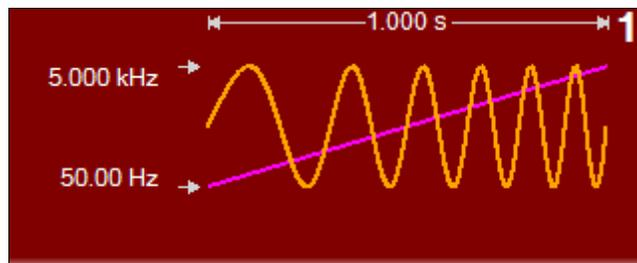

- You can generate a single frequency sweep by pressing the  key, but only if triggered mode is active.
- The 81150A / 81160A can also have gated sweeps. In this case it will start a new sweep as long as the gate is active. If the gate is getting inactive while a sweep is generated, this sweep will be finished. For more information, see "Triggering a Sweep or Burst".

2.28 Outputting a Burst Waveform

Introduction

You can configure the 81150A / 81160A to output a waveform with a specified number of cycles, called a *burst*. You can output the burst at a rate determined by the internal rate generator or the signal level on the Front Panel **External In**.

For this example, you will output a three-cycle sine wave with a 20 ms burst period. You will not change the other parameters from their default settings: internal burst source and 0 degree starting phase.

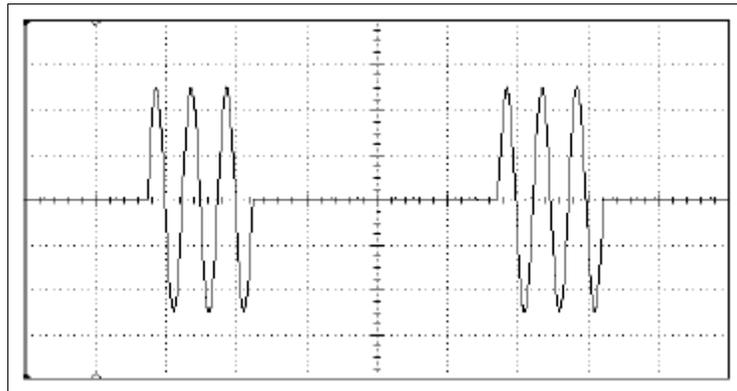

Select the burst mode

Press  to enable or disable burst mode. Notice that a status message *Burst* is shown in the status line.

Set the burst count

Press the **#Cycles** softkey and then set the count to "3" using the numeric keypad or knob.

Start Phase

Defines the start phase of the waveform that is bursted. The start phase is only available for sinewave, and arb waveforms. Noise and DC do not have a period and thus no phase information. Square, ramp and pulse is generated in a way that does not allow the use of a start phase.

The Start Phase can vary between -360° to 360° .

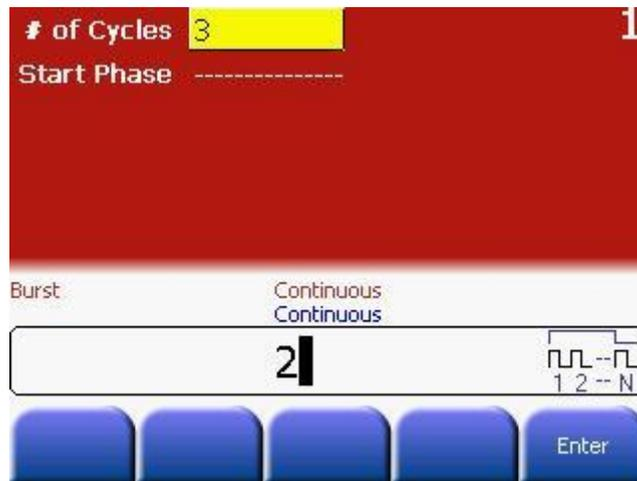

Set the period/frequency

Steps:

- Set the period/frequency of the sinewave to 2 ms.
- Enable triggered mode.
- Select Internal trigger source.
- Set the internal frequency to 50 Hz or the internal period to 20 ms.

View the waveform Press to view the waveform parameters.

To turn off the Graph Mode, press **Graph** again.

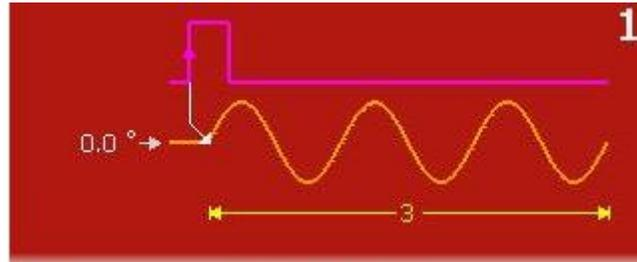

You can generate a single burst (with the specified count) by pressing the **Man** key. For more information, see “Triggering a Sweep or Burst”.

You can also use an external gate signal to either turn the burst signal “on” or “off” based on the external signal applied to the Front panel **External In** connector. For more information, see Burst Mode.

2.29 Triggering a Sweep or Burst

Introduction

There are 3 different trigger/gate sources:

- External (this is default)
- Internal (this is the programmable timebase)
- Manual (this is the key on the front panel or the *TRG command on the remote interface).

You can issue triggers from the front panel for sweeps and bursts using a manual trigger or an internal trigger.

Internal or “automatic triggering”

Internal or “automatic” triggering is enabled with the default settings of the 81150A / 81160A. In this mode, the 81150A / 81160A outputs continuously when the sweep or burst mode is selected.

When using the “automatic” triggering, the ‘Cont’ key is illuminated on the Front Panel.

Gated Sweep or Burst

Bursts or sweeps are enabled by (Gated by) an active level at the selected arming source:

- External Input (External Signal) gated while high or low or both.
 - Man key on Front Panel, gated while pressed or released or both.
-

Triggered Sweep or Burst

A burst or a sweep is triggered by an active edge at the selected arming source.

- Internal, select the triggering period.
 - External Input (External Signal) triggered by rising or falling or both edges.
 - Man key on Front Panel, triggered by press or release or both.
-

2.30 Storing the Instrument State

Introduction

You can store the instrument state in one of four non-volatile storage locations. A fifth storage location automatically holds the power-down configuration of the instrument. When power is restored, the instrument can automatically return to its state before power-down.

Select the desired storage location

Press  and then select the **Store State** softkey.

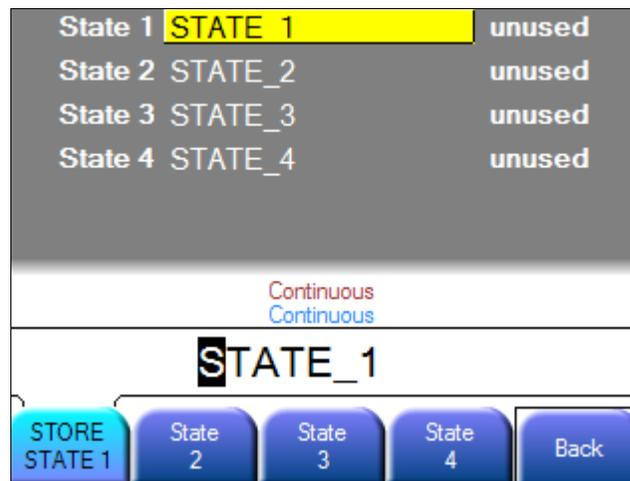

Select a custom name for the selected location

If desired, you can assign a custom name to each of the four locations.

- The name can contain up to 12 characters. The first character must be a letter but the remaining characters can be letters, numbers, or the underscore character (“_”), and “.”.
- To add additional characters, keep pressing the right-cursor key unless it reaches the place where you want to insert a character. Then, turn the knob to obtain the desired character.
- To delete all characters to the right of the cursor position, press .
- To use numbers and “.” in the name, you can enter them directly from the numeric keypad.

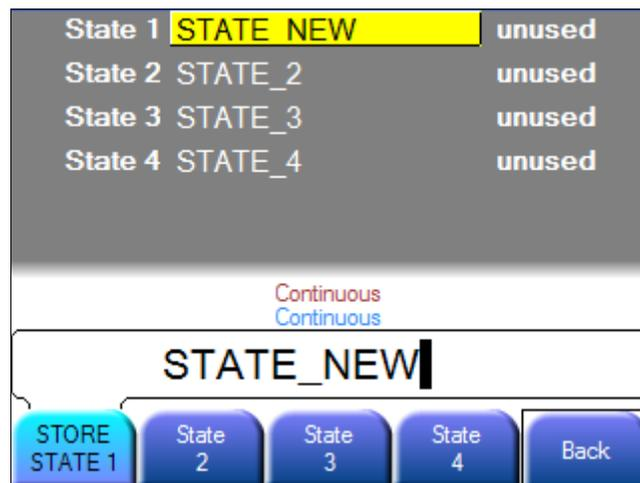

Store the instrument state

Press the **STORE STATE** softkey. The softkeys for each of these states, i.e., state 1 to 4 has two meanings:

- Select the state to store to.
- When being selected, the text on the softkey changes to ‘STORE STATE x’, where x is 1, 2, 3 or 4. Pressing this softkey actually performs the ‘store operation’. This will be confirmed with a scrolling text in the status line (Stored instrument state to location x).

The instrument stores the selected function, frequency, amplitude, dc offset, duty cycle, symmetry, as well as any modulation parameters in use. The instrument does not store volatile waveforms created in the arbitrary waveform function.



If you delete an arbitrary waveform from non-volatile memory after storing the instrument state, the waveform data is lost and the instrument will not output the waveform when the state is recalled. The built-in “exponential rise” waveform is output in place of the deleted waveform.

When power is turned off, the instrument automatically stores its power-down state. You can configure the instrument to automatically recall the power-down state when power is restored.

2.31 Configuring the Remote Interface

Introduction

This section gives information on configuring the 81150A / 81160A for remote interface communication. For information on the SCPI commands available to program the 81150A / 81160A over the remote interface, refer to chapter 4.

The Keysight 81150A / 81160A supports remote interface communication using a choice of three interfaces: GPIB, USB, and LAN, explained below. All three interfaces are "live" at power up. The instructions that follow explain how to configure your remote interface from the instrument front panel.



The CD-ROM provided with your instrument contains connectivity software to enable communications over these interfaces. Refer to the instructions provided on the CD-ROM to install this software on your PC.

2.31.1 GPIB Configuration

Introduction

Each device on the GPIB interface must have a unique address. The address is stored in the *non-volatile* memory and *does not change* when power has been off or after a remote interface reset.

Follow these steps to set the GPIB address:

Select the "I/O"
menu

Press  and then press the **I/O Interfaces** softkey.

Select the GPIB address

Use the knob and cursor keys or the numeric keypad to select a **GPIB address** in the range 0 through 31 (the factory default is “10”). The GPIB address is shown on the front-panel display at power-on.

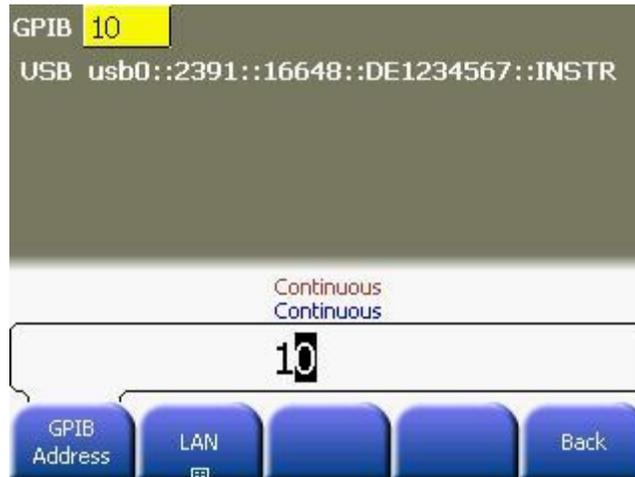
**Exit the menu**

Press the **Enter** softkey to enter the GPIB address and exit.



Your computer’s GPIB interface card has its own address. Be sure to avoid using the computer’s address for any instrument on the interface bus.

2.31.2 USB Configuration

Introduction

The USB interface requires no front panel configuration parameters. Just connect your Keysight 81150A / 81160A to your PC using a standard USB cable and the interface will self configure.

2.31.3 LAN Configuration

Introduction

There are several parameters that you may need to set to establish network communication using the LAN interface. Primarily, you will need to establish an IP address. You may need to contact your network administrator for help in establishing communication with the LAN interface.

Follow these steps to set the LAN address:

Select the "I/O" Interfaces menu

Press  and then press the **I/O Interfaces** softkey.

Select the "LAN" menu

Press the **LAN** softkey.

From this menu, you can select **IP Setup** to set an IP address and related parameters, **DNS Setup** to configure DNS.

The **Current Config** is always displayed on the LAN screen.

- LAN RESET does reset the LAN configuration back to DHCP/Auto-IP and enables the web server.



Establish an “IP Setup”

To use the Keysight 81150A / 81160A on the network, you must first establish an IP setup, including an IP address, and possibly a subnet mask and gateway address. Press the **IP Setup** softkey. By default, **DHCP/Auto-IP** (Dynamic Host Configuration Protocol) is set to **On**.

**With DHCP/Auto-IP On, IP address will automatically be set**

With **DHCP/Auto-IP On**, an IP address will automatically be set by DHCP/Auto-IP when you connect the Keysight 81150A / 81160A to the network, provided the DHCP server is found and is able to do so. DHCP also automatically deals with the subnet mask and gateway address, if required.

This is typically the easiest way to establish LAN communication for your instrument. All you need to do is leave **DHCP/Auto-IP On**.

However, if you cannot establish communication by means of DHCP/Auto-IP, you will need to manually set an IP address, and a subnet mask and gateway address if they are in use.

To establish an IP setup, follow these steps:

Set the “IP Address”

Press the softkey to select **DHCP/Auto-IP Off**. The manual selection softkeys appear and the current IP address is displayed.



Contact your network administrator for the IP address to use. All IP addresses take the form "nnn.nnn.nnn.nnn" where each "nnn" is a byte value in the range 000 through 255. You can enter a new IP address using the numeric keypad (not the knob). Just type in the numbers and the period delimiters using the keypad. Use the left cursor key as a backspace key.

Set the "Subnet Mask"

The subnet mask is required if your network has been divided into subnets. Ask your network administrator whether a subnet mask is needed, and for the correct mask. Press the **Subnet Mask** softkey and enter the subnet mask in the IP address format (using the keypad).

Set the "Default Gateway"

The gateway address is the address of a gateway, which is a device that connects two networks. Ask your network administrator whether a gateway is in use and for the correct address. Press the **Default Gateway** softkey and enter the gateway address in the IP address format (using the keypad).

Exit the "IP Setup" menu

Press **Back** to return to the "LAN" menu.

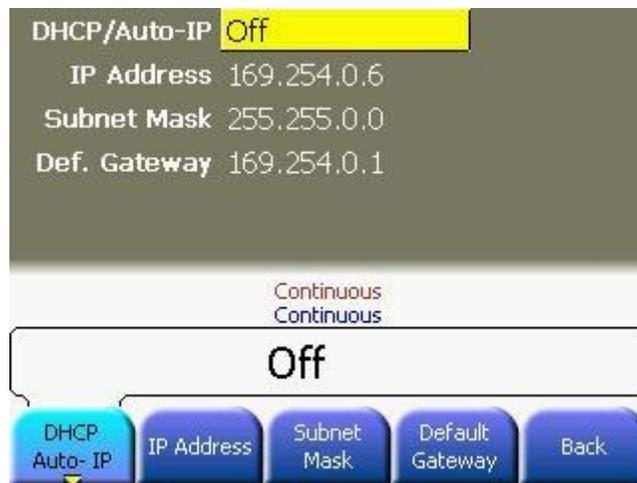

Configure the “DNS Setup” (optional)

DNS (Domain Name Service) is an Internet service that translates domain names into IP addresses. Ask your network administrator whether DNS is in use, and if it is, ask for the host name and DNS server address to use.

Steps:

- Start at the “LAN” menu.
- Press the **DNS Setup** softkey to display the “Host Name” field.

**Set the “Host Name”**

Steps:

- Press the **Host Name** softkey and enter the host name. The host name is the host portion of the domain name, which is translated into an IP address. The host name is entered as a string using the knob and cursor keys to select and change characters. The host name may include letters, numbers, and dashes (“-”). You can use the keypad for the numeric characters only.
- Press  to delete all characters to the right of the cursor position.

Set the “Domain Name”

The Domain Name cannot be changed. But, the name that was detected by the Operating System is displayed for information.

Set the “DNS Server” address

Press the **DNS Server** softkey and enter the address of the DNS server (there are two DNS Server addresses) in the IP address format (using the keypad).

Set the “WINS Server” address

Press the **WINS Server** softkey and enter the address of the WINS server (there are two WINS Server addresses) in the IP address format (using the keypad).

Exit the “DNS Setup” menu

Press the **Back** softkey to return to the previous screen. This will bring you back to the LAN menu.

Exit the menu

Press the  key to directly enter from the LAN menu. Else, keep pressing the **Back** key unless you reach the required screen.

2.32 Resetting the 81150A / 81160A

Introduction

To reset the instrument to its factory default state, press  and then select the **Set to Defaults** softkey. Press **YES** to confirm the operation.

The **Set to Defaults** functionality will program the instrument's default setting. This is related to the electrical signals that are generated at the instruments output connectors.

The **Set to Defaults** does not affect system settings like GPIB address, LAN configuration, and Display brightness. In short everything that has nothing to do with the BNC connectors.

There is another mechanism that will reset everything. This is called **SECURE ALL** and can be found under Utility/System/Security.

SECURE ALL does a full format of every NON-VOLATILE storage in the instrument:

- Set the instrument's default setting (just like 'Set to Defaults')
- It erases all settings and waveforms that are stored on the instruments internal memory
- It resets all system settings like LAN, GPIB address.

SECURE ALL brings the instrument back to the 'delivery state', and takes some time (several minutes) in doing this.

For a complete listing of the instrument's power-on and reset conditions, see "Factory Default Settings".

3 Features and Functions

Introduction This section makes it easy to look up all the details about a particular feature of the 81150A / 81160A. Whether you are operating the 81150A / 81160A from the front panel or over the remote interface, this chapter will be useful.

What's inside this Chapter This section contains the following sections:

- Trigger Mode
- Output Configuration
- Input Configuration
- Pulse Waveforms
- Pattern Capabilities
- Noise
- Amplitude Modulation (AM)
- Frequency Modulation (FM)
- Phase Modulation (PM)
- Frequency-Shift Keying (FSK) Modulation
- Pulse Width Modulation (PWM)
- Frequency Sweep
- Burst Mode
- Arbitrary Waveforms
 - Creating and Storing an Arbitrary Waveform
 - Managing Stored Waveforms
 - Additional Information on Arbitrary Waveforms
- System-Related Operations
- Remote Interface Configuration
- Software Update
- Installing Licenses
- Diagnostics/Calibration Overview
- Security
- Factory Default Settings



Some knowledge of the front-panel menus will be helpful before you read this section. If you have not already read chapter 2, “Front-Panel Menu Operation,” starting on page 13, you may want to read it now. Chapter 4, “Remote Programming Reference,” starting on page 289, lists the syntax for the SCPI commands available to program the 81150A / 81160A.

**Conventions used
for SCPI command
syntax**

Throughout this manual, the following conventions are used for SCPI command syntax for remote interface programming:

- Square brackets ([]) indicate optional keywords or parameters.
 - Braces ({ }) enclose parameters within a command string.
 - Triangle brackets (< >) enclose parameters for which you must substitute a value.
 - A vertical bar (|) separates multiple parameter choices.
-

3.1 Trigger Mode

Introduction The Keysight 81150A / 81160A allows you to control the signal generation in several ways. One of the most important ways is selecting a trigger mode.

Triggering means start of the signal generation and it does not take place until all ARM conditions are met.

There are three different trigger modes available:

- Continuous
- Triggered
- Gated

These are explained in the following sections.

Continuous Trigger Mode In this mode, the instrument continuously generates the output signal. The next waveform cycle, burst or sweep starts immediately after the previous one is finished. There is not gap or distance between two consecutive 'cycles'.

In this mode, no arming/triggering is used.

Triggered In this mode, the instrument generates exactly one waveform cycle, burst or sweep on the active edge of the trigger signal. If a seconds trigger event occurs before the current cycle (waveform, burst or sweep) is finished, then the trigger event will be ignored.

The Triggered mode cannot be used with modulation.

The cycle to be triggered must have a 'duration' (the waveform must have a dedicated beginning and end, which is not true for DC).

Noise has a special characteristic. Although it does not have a duration, it is still allowed to be triggered.

Gated

The gated mode is very closely related to the Triggered mode. The instrument continuously generates the selected waveform, sweep, or burst while the selected gate is still active.

If the gate is getting inactive, the current cycle will be finished.

If the gate is getting active again while the previous cycle is being finished, then there will be no discontinuity at the outputs.

Front Panel Operation

Press the , , or the  key to select the desired trigger mode. Pressing the illuminated key on the Front Panel will show the Trigger Mode screen.

Remote Interface Operation

To select continuous mode:

```
:ARM:SOURce {IMMediate}
```

To select triggered mode:

```
:ARM:SOURce {INTernal2|EXTernal|MANual}
```

```
:ARM:SOURce {EDGE}
```

To select gated mode:

```
:ARM:SOURce {EXTernal|MANual}
```

```
:ARM:SENSe {LEVEl}
```

3.1.1 Arming Source

Introduction

The following sources are available:

- External In
 - Internal
 - Man
-

External In

This input allows to define the decision in a ± 10 V for 81150A (± 5 V for 81160A) voltage window. The input signal is referenced to chassis ground.

81150A: The input impedance may be set to either 50 Ω or 10 k Ω .

81160A: The input impedance may be set to either 50 Ω or 1 k Ω .

Internal

Each channel of the Keysight 81150A / 81160A contains its own internal trigger event generator. The frequency of the trigger event may be adjusted as required for the specific application.

The Internal trigger generator cannot be used to generate the gate signal.

Man

The Man key on the front panel may be used to generate the trigger event or gate signal manually. When receiving the *TRG command, the instrument will emulate a press and release event of the Man key.

Front Panel Operation

Press the  or  key on the front panel to reach the Trigger Mode screen.

Choose the appropriate Source as shown below.

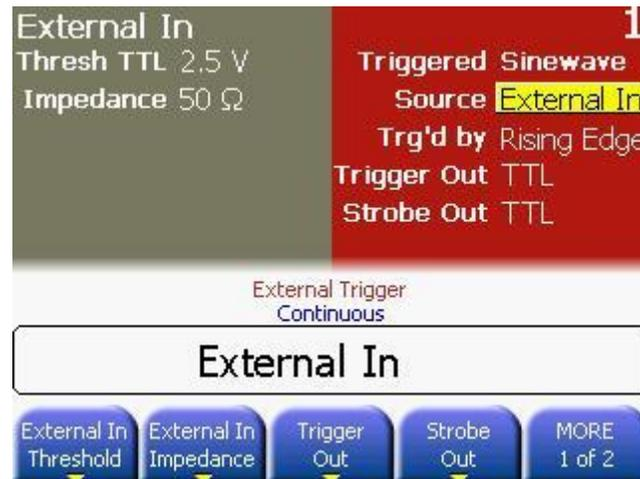

The screenshots above are taken from the 81150A. The 81160A offers additional functionality described in chapter 3.3.1 “External In Parameters”.

Remote Interface Operation :ARM:SOURce {INTernal2|EXTernal|MANual}



Selecting the source of the arming signal is related to setting the triggering mode of the instrument. See section 3.1 for more details.

3.1.2 Arming Slope

Introduction Trigger events can be generated on the rising edge, the falling edge, or on both edges of the selected arming signal.

Front Panel Operation On the Trigger Mode screen, press the **Trig'd by** or **Gated by** softkey. You can also use the navigation keys to select the **Trig'd by** or **Gated by** key. Choose the appropriate option from the given options as shown below.

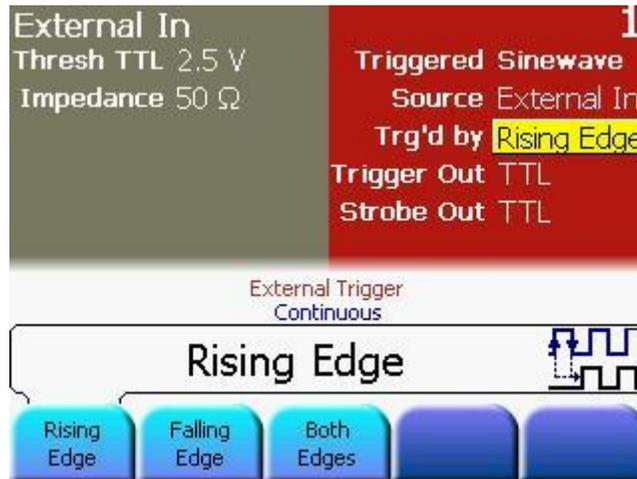

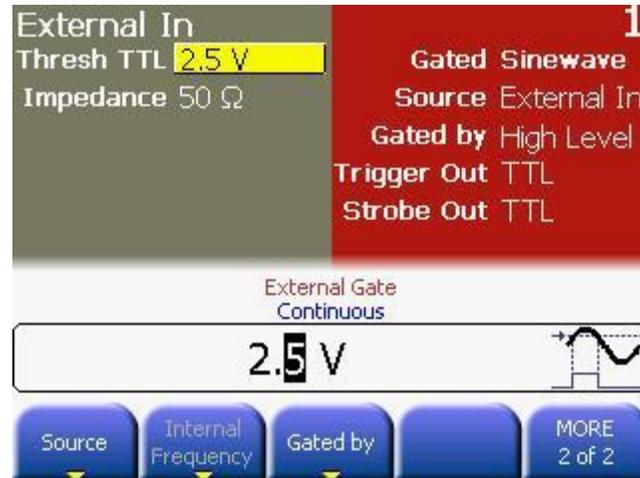

The screenshots above are taken from the 81150A. The 81160A offers additional functionality described in chapter 3.3.1 “External In Parameters”.

Remote Interface Operation :ARM:SLOPe {POSitive|NEGative|EITHer}

3.1.3 Internal Trigger Period/Frequency

Introduction The internal trigger period/frequency defines the time between two trigger events if the trigger source is set to Internal.

Characteristics

- Trigger Frequency 81150A: 1 μ Hz to 120 MHz (default 100 kHz)
- Trigger Frequency 81160A: 1 μ Hz to 330 MHz (default 100 kHz)
- Trigger Period 81150A: 8.3333 ns to 1000000s (default 10 μ s)
- Trigger Period 81160A: 3.03 ns to 1000000s (default 10 μ s)
- The trigger period setting is used only when *Internal* triggering is enabled. The trigger period is ignored when manual or external triggering is enabled (or when the *gated* mode is selected).
- It *is not* possible to specify a trigger period which is too short for the 81150A / 81160A to output with the specified burst count and frequency (see below).
Trigger Period > Burst Count x Waveform Period
- It *is not* possible to specify a trigger period which is too short for the 81150A / 81160A to output with the specified sweep time.
Trigger Period > Sweep Time

**Front Panel
Operation**

To set the trigger period, press the **Internal Period** or **Internal Frequency** softkey and then use the knob or numeric keypad to enter the period.

**Remote Interface
Operation**

:ARM:FREQuency[1|2] {<frequency>|MINimum|MAXimum}
:ARM:PERiod[1|2] {<seconds>|MINimum|MAXimum}

3.2 Output Configuration

Introduction This section contains information to help you configure the 81150A / 81160A for outputting waveforms. You may never have to change some of the parameters discussed here, but they are provided to give you the flexibility you might need.

3.2.1 Output Function

Introduction The 81150A / 81160A can output five standard waveforms (sine, square, ramp, pulse, and noise), plus dc. You can also select one of six built-in arbitrary waveforms or create your own custom waveforms. You can internally modulate sine, square, ramp, and arbitrary waveforms using AM, FM, PM, or FSK. You can also modulate pulse using PWM. Linear or logarithmic frequency sweeping is available for sine, square, ramp, and arbitrary waveforms. You can generate a burst waveform using any of the standard or arbitrary waveforms (but not dc and noise). The default function is sine wave.

Table Description The table below shows which output functions are allowed with modulation, sweep, and burst. Each “•” indicates a valid combination.
If you change to a function that is not allowed with modulation, sweep, or burst, then the modulation or mode is turned off.

	Sine	Square	Ramp	Pulse	Pattern	Noise	DC	Arb
AM, FM, PM Carrier	•	•	•		•			•
FSK Carrier	•	•	•					•
PWM Carrier				•				
Sweep Mode	•	•	•					•
Burst Mode	•	•	•	•	•			•

Front Panel Operation

Press  to output the arbitrary waveform currently selected. To view the other arbitrary waveform choices, press the **Select Waveform** softkey.

To select *dc volts* from the front panel, press  and then select the **DC Mode** and then the **DC** softkey to enable/disable DC. Press the **Offset** softkey to enter the desired offset voltage level.

Remote Interface Operation

The following function is used to configure the output remotely:
:FUNCTION[1|2] {SINusoid|SQUare|RAMP|PULSe|NOISE|DC|USER}



You can also use the APPLY command to select the function, frequency, amplitude, and offset with a single command.

3.2.2 Output Frequency

Introduction The output frequency range depends on the function selected, as shown in the table below. *The default frequency is 1 MHz for all functions.*

Function	Minimum Frequency	Maximum Frequency
Sine	1 μ Hz	81150A: 240 MHz 81160A: 500 MHz
Square	1 μ Hz	81150A: 120 MHz 81160A: 330 MHz
Ramp	1 μ Hz	81150A: 5 MHz 81160A: 20 MHz
Pulse	1 μ Hz	81150A: 120 MHz 81160A: 330 MHz
Pattern	1 μ Hz	81150A: 120 MHz (10 MHz for external patterns) 81160A: 660 MHz (10 MHz for external patterns)
Noise, DC	Not Applicable	Not Applicable
Arbs	1 μ Hz	81150A: 120 MHz 81160A: 330 MHz

Burst Limitations The maximum frequency when doing burst is 120 MHz for the 81150A (330 MHz for the 81160A). This frequency limit applies additionally to the functions max frequency limit. Practically, this is only relevant for sine waves, since all other waveforms have a maximum frequency of 120 MHz for the 81150A (330 MHz for the 81160A).

Trigger Limitations When using triggered mode, the maximum frequency of the waveform is limited to 120 MHz for the 81150A (330 MHz for the 81160A).
The trigger events may not occur faster than the duration of the waveform being triggered. This limits the maximum trigger rate to 120 MHz for the 81150A (330 MHz for the 81160A).

Duty Cycle Limitations

For square and pulse waveforms, the 81150A / 81160A may not be able to use the full range of duty cycle values at higher frequencies as shown below:

Duty cycle is limited by minimum width specification.

The high phase and the low phase of the square, or pulse wave may not be less than W_{min} .

The limits for the duty cycle are calculated from this restriction:

- $D_{cycMin} = 100\% * W_{min}/period$
- $D_{cycMax} = 100\% * (1 - W_{min}/period)$

81150A: Where W_{min} is either 4.1ns or 10ns depending on the selected amplifier (See section Amplifier Type Selection).

81160A: Where W_{min} is 1.5ns.

Front Panel Operation

To set the output frequency, press the **Frequency** softkey for the selected function. Then use the knob or numeric keypad to enter the desired frequency. To set the waveform period instead, press the **Frequency** softkey again to toggle to the Period softkey.

Remote Interface Operation

The following function is used to configure the output frequency remotely:

```
:FREQuency [1 | 2] {<frequency> | MINimum | MAXimum}
```

You can also use the APPLy command to select the function, frequency, amplitude, and offset with a single command.

3.2.3 Output Amplitude

Introduction The default amplitude is 1 Vpp (into 50 ohms) for all functions.

Offset Voltage Limitations The relationship between output amplitude and offset voltage is shown below. V_{max} is the maximum peak voltage for the selected output termination (5 volts for a 50 Ω load or 10 volts for a high-impedance load).

$$V_{pp} = V_{max} - V_{min}$$

Or

$$V_{pp} = 2 * |V_{max} - V_{offset}|$$

Limits due to Output Termination If you change the output termination setting, the values do not get adjusted and an error message indicates potential problems with level settings. But, if the new termination does result in voltages that can be done with the 81150A / 81160A, then the values that are displayed on the front panel will be applied at the output. The 81150A / 81160A tries to keep the programmed levels when the termination changes. If this is not possible, then an error message is displayed.

The load impedance can be set to values 0.3 Ω to 1 M Ω . There is no dedicated 'high impedance' setting.

Do's and Dont's You can set the output amplitude in Vpp, Vrms, or dBm. For more information, see "Output Units".

Arbitrary Waveform Limitations

For arbitrary waveforms, the maximum amplitude will be limited if the waveform data points do not span the full range of the output DAC (Digital-to-Analog Converter). For example, the built-in "Sinc" waveform does not use the full range of values between ± 1 and therefore its maximum amplitude is limited to 6.087 Vpp (into 50 ohms) for 81150A.



- While changing amplitude, you may notice a momentary disruption in the output waveform at certain voltages due to switching of the output attenuators. The amplitude is controlled, however, so the output voltage will never exceed the current setting while switching ranges. To prevent this disruption in the output, you can disable the voltage autoranging feature as described in the Voltage Autoranging section.
- You can also set the amplitude (with an associated offset voltage) by specifying a high level and low level. For example, if you set the high level to +2 volts and the low level to -3 volts, the resulting amplitude is 5 Vpp (with an offset voltage of -500 mV).
- For dc volts, the output level is actually controlled by setting the offset voltage. You can set the dc level to any value between ± 5 Vdc into 50 ohms or ± 10 Vdc into a high impedance circuit. *See "DC Offset Voltage" on the following page for more information.*
- ☞ The available Range for 81150A is:
 - ± 5 V into 50 Ω (± 10 V into 1 M Ω) for the max. bandwidth amplifier.
 - ± 10 V into 50 Ω (± 20 V into 1 M Ω) for the max. amplitude amplifier
- ☞ The available Range for 81160A is:
 - ± 5 V into 50 Ω (± 10 V into 1 M Ω)

Front Panel Operation

- To set the output amplitude, press the **Ampl** softkey for the selected function. Then use the knob or numeric keypad to enter the desired amplitude. To set the amplitude using a high level and low level, press the **Ampl** softkey again to toggle to the **High** and **Low** softkeys.
 - To select dc volts, press  and then select the **DC Mode** softkey. Press the **Offset** softkey to set the desired offset voltage level.
-

**Remote Interface
Operation**

The following function is used to configure the output amplitude remotely:

```
:VOLTage[1|2] {<NR3>|MINimum|MAXimum}
```

Or, you can set the amplitude by specifying a high level and low level using the following commands.

```
:VOLTage[1|2]:HIGH {<volts>|MINimum|MAXimum}
```

```
:VOLTage[1|2]:LOW {<volts>|MINimum|MAXimum}
```



You can also use the APPLY command to select the function, frequency, amplitude, and offset with a single command.

3.2.4 DC Offset Voltage

Introduction The default offset is 0 volts for all functions.

Limits due to Amplitude The relationship between offset voltage and output amplitude is shown below. V_{\max} is the maximum peak voltage for the selected output termination (5 volts for a 50 Ω load or 10 volts for a high-impedance load).

$$|V_{\text{Offset}}| \leq V_{\max} - \frac{V_{PP}}{2}$$

Limits due to Output Termination The offset limits are determined by the current output termination setting. The 81150A / 81160A keeps the configured voltages. However, if this is not possible, it shows an error message.

Arbitrary Waveform Limitations For arbitrary waveforms, the maximum offset and amplitude will be limited if the waveform data points do not span the full range of the output DAC (Digital-to-Analog Converter). For example, the built-in "Sinc" waveform does not use the full range of values between ± 1 and therefore its maximum offset is limited to 4.95 volts (into 50 ohms).

You can also set the offset by specifying a high level and low level. For example, if you set the high level to +2 volts and the low level to -3 volts, the resulting amplitude is 5 Vpp (with an offset voltage of -500 mV).

For dc volts, the output level is actually controlled by setting the offset voltage. You can set the dc level to any value between ± 5 Vdc into 50 ohms or ± 10 Vdc into high impedance circuit (1 M Ω).

**Front-Panel
Operation**

- To set the dc offset, press the **Offset** softkey for the selected function. Then use the knob or numeric keypad to enter the desired offset. To set the offset using a high level and low level, press the **Offset** softkey again to toggle to the **High** and **Low** softkeys.
- To select *dc volts*, press  and then select the DC On softkey. Press the Offset softkey to set the desired offset voltage level.

**Remote Interface
Operation**

The following function is used to configure the DC Offset Voltage remotely:

```
:VOLTage[1|2]:OFFSet{<volts>|MINimum|MAXimum}
```

Or, you can set the offset by specifying a high level and low level using the following commands.

```
:VOLTage[1|2]:HIGH {<volts>|MINimum|MAXimum}
```

```
:VOLTage[1|2]:LOW {<volts>|MINimum|MAXimum}
```

You can also use the APPLy command to select the function, frequency, amplitude, and offset with a single command.

3.2.5 Output Units

Introduction	Applies to output amplitude only. At power-on, the units for output amplitude are volts peak-to-peak.
<hr/>	
Output Units	Vpp, Vrms, or dBm. The default is Vpp. The unit setting is stored in <i>volatile</i> memory. The units are set to “Vpp” when power has been <i>off</i> or after a remote interface reset (provided the Power On state is set to “default”).
<hr/>	
Characteristics	The 81150A / 81160A uses the current units selection for both front panel and remote interface operations. For example, if you select “VRMS” from the remote interface, the units are displayed as “VRMS” on the front panel.
<hr/>	
Front-Panel Operation	Use the numeric keypad to enter the desired magnitude and then press the appropriate softkey to select the units. You can also convert from one unit to another from the front panel. Press the Ampl Softkey. Then select the desired unit as described in section 2.13.1.
<hr/>	
Remote Interface Operation	The following function is used to configure the output amplitude remotely: :VOLTage[1 2] {VPP VRMS DBM}
<hr/>	

3.2.6 Load Impedance

Introduction *Applies to output amplitude and offset voltage only.* The Keysight 81150A has a selectable series output impedance of 50 Ω or 5 Ω to the front-panel *Output* connector. The Keysight 81160A has a fix series output impedance of 50 Ω. If the actual load impedance is different than the value specified, the displayed amplitude and offset levels will be incorrect.

- Load Impedance Characteristics**
- 0.3 Ω to 10M Ω. The default is 50 Ω.
 - The load impedance is stored in volatile memory; the load impedance is set to 50 Ω (default value), when power has been off or after a remote interface reset (assuming the Power On is set to “default”)
 - If you specify a 50 Ω termination but are actually terminating into an open circuit, the actual output will be *twice* the value specified. For example, if you set the offset to 100 mVdc (and specify a 50 Ω load) but are terminating the output into an open circuit, the actual offset will be 200 mVdc.
-

Front-Panel Operation Load impedance is available on the function screens.

Remote Interface Operation The following function is used to configure the Load Impedance remotely:

```
:OUTPut [1 | 2] : IMPedance : EXTernal { <ohms> | MINimum | MAXimum }
```

3.2.7 Output Source Impedance

Introduction	<p>81150A: An impedance of 50 Ω, 5 Ω is selectable.</p> <p>81160A: The output source impedance is 50 Ω fix.</p>
<hr/>	
Source Impedance Characteristics	<p>The source impedance is stored in volatile memory; it is set to 50 Ω (default value), when power has been off or after a remote interface reset (assuming Power On is set to “default”).</p>
<hr/>	
Front Panel Operation	<p>Output Impedance can be found on the Pulse, Sine, Square, Ramp, Arb, Noise, DC screens.</p>
<hr/>	
Remote Interface Operation	<p>The following function is used to configure the output source impedance remotely (81150A, only):</p> <pre data-bbox="535 1121 1372 1150">:OUTput [1 2]:IMPedance {<ohms> MINimum MAXimum}</pre>
<hr/>	

3.2.8 Voltage Autoranging

Introduction Autoranging is enabled by default and the 81150A / 81160A automatically selects the optimal settings for the output amplifier and attenuators. With autoranging disabled, the 81150A / 81160A uses the current amplifier and attenuator settings.

Voltage Autoranging characteristics You can disable autoranging to eliminate momentary disruptions caused by switching of the attenuators while changing amplitude. *However, turning autoranging off has side effects:*

- The amplitude and offset accuracy and resolution (as well as waveform fidelity) may be adversely affected when reducing the amplitude below a range change that would occur with autoranging on.
- You may not be able to achieve the minimum amplitude that is available with autoranging on.

Front-Panel Operation Press  and select the **Output Setup** softkey. Then press the **Amplifier Range** softkey again to toggle between the "Auto", "Hold" and "Auto Once" selections.

Remote Interface Operation The following function is used to configure the voltage autoranging remotely:

```
:VOLTage[1|2]:RANGe:AUTO {ON|OFF|ONCE}
```

The APPLy command overrides the voltage autorange setting and automatically enables autoranging.

3.2.9 Amplifier Type Selection



The Amplifier Type Selection applies to the 81150A only. The 81160A has one type of amplifier. See the data sheet for the output amplifier specifications of the 81160A.

Introduction

There are two different amplifiers available for each channel inside the 81150A. One amplifier is optimized for high bandwidth, but provides a smaller output voltage window. The second one is optimized for high output voltage, but has a lower bandwidth.

	Max. Bandwidth	Max. Amplitude
Max. Frequency	240 MHz	50 MHz
Max. Amplitude (50Ω into 50Ω)	5 Vpp (if frequency is ≤ 120 MHz)	10 Vpp
	3 Vpp (if frequency is > 120 MHz)	
Voltage Window (50Ω into 50Ω)	±5 V	±10 V
Min. Transition Time	2.5 ns	7.5 ns
Min. Width	4.1 ns	10 ns



The amplifier selection applies additional limitations to available voltage range, frequency, transition time, and width/duty cycle.

Front Panel Operation



Press the key and then select the **Output Setup** softkey.

Press the Amplifier Type and use the knob or the softkey to set the desired value.

Remote Interface Operation

```
:OUTPut [1|2]:ROUTE {HIVoltage|HIBandwith}
```

3.2.10 Digital Channel Addition

Introduction If the instrument is equipped with 2 output modules, channel 2 can be added to channel 1 internally. The maximum output voltage remains unchanged. In this case, the second channel outputs the unchanged waveform of channel two.

The resulting voltages at the output of channel 1 are:

$$\text{High Level} = \text{High Level 1} + \text{High Level 2}$$

$$\text{Low Level} = \text{Low Level 1} + \text{Low Level 2}$$

Characteristics Channel addition is performed internally in the digital data generation (before the DAC) and simply adds the two digital values of both channels in order to calculate the digital value which is fed to the DAC of channel 1.

Front panel Operation

Press the  key, **Output Setup** softkey and then **Channel Add** softkey. Choose from Separate Channels or Added at Output 1.

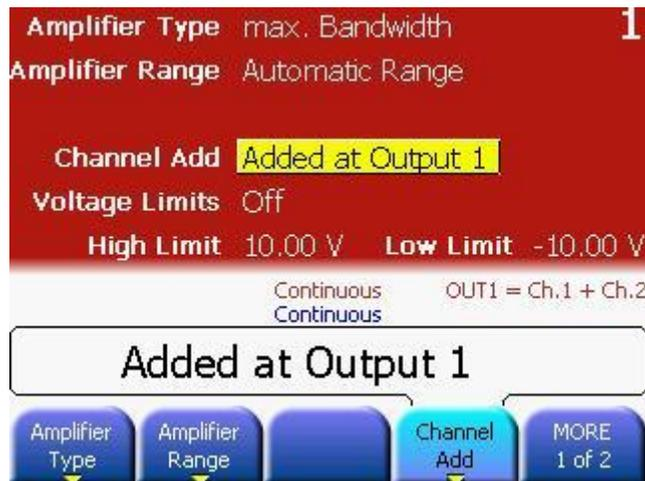

Remote Interface Operation :CHANnel:MATH {OFF|PLUS}

3.2.11 Voltage Limits

Introduction The voltage limits, limits the range that can be set by software but does not apply some kind of programmable hardware limits in the amplifier.

Charactersitics Use the voltage limits for the level parameters to prevent accidental damage of the device under test.
After you switch on the limits, the level parameters on the function screens cannot be adjusted outside the range specified as voltage limits if the output is switched on.

Front Panel Operation

Press the  key, **Output Setup** and then **Voltage Limits** softkey. To enable/disable the Voltage Limits, press the **Voltage Limits** softkey again. High Volt Limit is used to set the maximum allowed voltage. Low Volt Limit is used to set the minimum allowed voltage.



Remote Interface Operation

```
:VOLTage[1|2]:LIMit:STATE {OFF|ON}
:VOLTage[1|2]:LIMit{<voltage>}MINimum|MAXimum}
:VOLTage[1|2]LIMit:LOW {<voltage>|MINimum|MAXimum}
```

3.2.12 Duty Cycle (Square Waves)

Introduction

The duty cycle of a square wave represents the amount of time per cycle that the square wave is at a *high level* (assuming that the waveform is not inverted).

(See Pulse Waveforms for information about duty cycle for pulse waveforms).

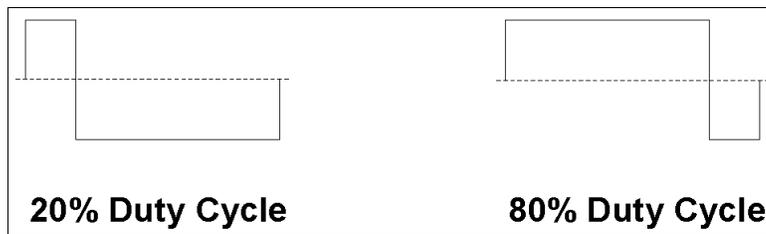

Duty Cycle Characteristics

- The duty cycle is limited by the minimum pulse width of W_{min} . This means the duty cycle can get as low as $(100\% * W_{min}/period)$ and as high as $(100\% * (1 - W_{min}/period))$
81150A: Where W_{min} is either 4.1ns or 10ns depending on the selected amplifier (See section Amplifier Type Selection).
81160A: Where W_{min} is 1.5 ns.
- The duty cycle is stored in *volatile* memory; the duty cycle is set to 50% (the default) when power has been off or after a remote interface reset (assuming the Power On state is set to "default")
- The duty cycle setting is remembered when you change from square wave to another function. When you return to the square function, the previous duty cycle is used.
- In square mode the leading and trailing edge are both at the minimum setting (fastest possible transition time).



The duty cycle setting does not apply to a square waveform used as the modulating waveform for AM, FM, PM or PWM. A 50% duty cycle is always used for a modulating square waveform. The duty cycle setting applies only to a square waveform carrier.

**Front-Panel
Operation**

After selecting the square wave function, press the **Duty Cycle** softkey. Then use the knob or numeric keypad to enter the desired duty cycle.

**Remote Interface
Operation**

The following function is used to configure the duty cycle remotely:

```
:FUNCTION[1|2]:SQUare:DCYCl{<percentage>|  
MINimum|MAXimum}
```

The APPLy command automatically sets the duty cycle to 50%.

3.2.13 Symmetry (Ramp Waves)

Introduction

Applies to ramp waves only.

Symmetry represents the amount of time per cycle that the ramp wave is *rising* (assuming that the waveform is not inverted).

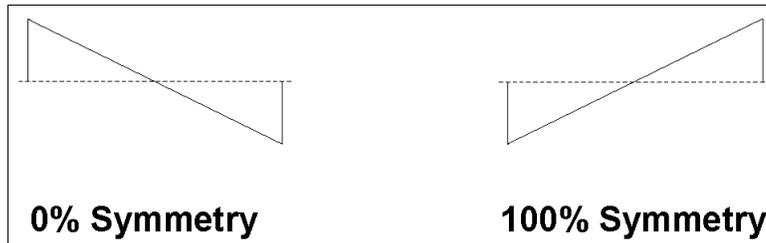

Symmetry Characteristics

- The symmetry is stored in *volatile* memory; the symmetry is set to 100% (the default) when power has been off or after a remote interface reset (assuming the Power On state is set to “default”).
- The symmetry setting is remembered when you change from ramp wave to another function. When you return to the ramp function, the previous symmetry is used.
- If you select a ramp waveform as the modulating waveform for AM, FM, PM, or PWM, the symmetry setting does not apply.

Front-Panel Operation

After selecting the ramp function, press the **Symmetry** softkey. Then use the knob or numeric keypad to enter the desired symmetry.

Remote Interface Operation

The following function is used to configure the symmetry remotely:

```
:FUNCTION[1|2]:RAMP:SYMMetry{<percentage>|
MINimum|MAXimum}
```

The APPLY command automatically sets the symmetry to 100%.

3.2.14 Output Control

Introduction	You can disable or enable the front-panel <i>Output</i> connector. By default, the output is disabled at power on to protect other equipment. When enabled, the Output key is illuminated.
<hr/>	
Output Control characteristics	If an excessive external voltage is applied to the front-panel <i>Output</i> connector, an error message will be displayed and the output will be disabled. To re-enable the output, remove the overload from the <i>Output</i> connector and press both the Output keys (for normal and inverted output) for the respective channel to enable the output.
<hr/>	
Front-Panel Operation	Press both, the normal and the inverted Output keys to enable or disable the output.
<hr/>	
Remote Interface Operation	<p>The following function is used to configure the output control remotely:</p> <pre>:OUTput [1 2] {0 1 OFF ON}</pre> <pre>:OUTPut [1 2]:COMplement {0 1 OFF ON}</pre> <p>The APPLy command overrides the current setting and automatically enables the <i>Output</i> connector.</p>
<hr/>	
	In case of an overload condition, both outputs of the channel (Normal and Inverted) will be turned off.
<hr/>	

3.2.15 Parameter Coupling

Introduction

The 2 channels of the Keysight 81150A / 81160A can work as 2 completely independent instruments that use some shared resources like External-In, Man key and Clock Reference.

For applications that require some locking of the two channels, the 81150A / 81160A provides two means of synchronization.

- **Frequency Coupling:** The frequency of channel 2 is automatically set to an adjustable ratio of channel 1.
 - **Channel Coupling:** The frequency and phase of channel 1 and 2 are locked. The 81150A / 81160A works as a 2 channel instrument with only one timing system for both channels.
-

Frequency Coupling

Introduction

For a 2 channel instrument, the frequency of the 2 channels can be coupled to keep a user defined frequency ratio. This can be used to automatically adjust the frequency of channel 2 whenever the frequency of channel 1 changes.

Characteristics

- Enables or disables frequency coupling mode on channel 2. If frequency coupling mode is enabled, the frequency on channel 2 will be calculated as followed:

$$f_2 = \text{FreqMult} * f_1 / \text{FreqDiv}$$

- It is no longer possible to enter the frequency on channel 2 directly if frequency divider mode is enabled.
 - The frequency coupling settings will be ignored if sweep is enabled.
 - The frequency multiplier and divider settings do not apply to the FSK Hop Frequency.
 - The phase relation between channel 1 and channel 2 is not specified even if the frequency of channel 1 is identical to the frequency of channel 2.
-

Front Panel Operation

This can be found on the Pulse, Sine, Square, Ramp, and Arb screens. The Frequency Multiplier and Frequency Divider will be enabled only when the Frequency Coupling State is enabled.

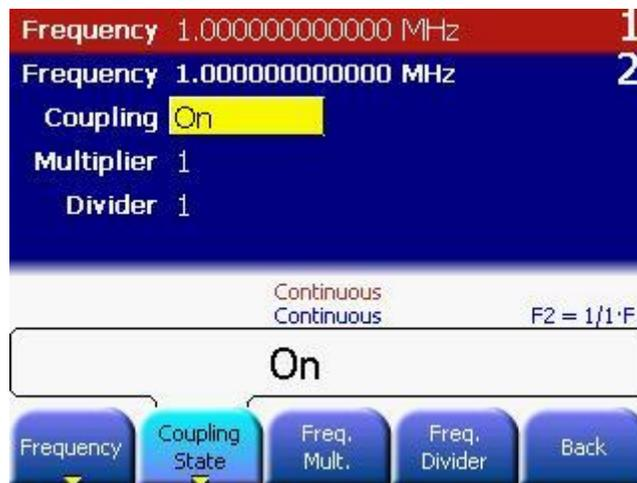
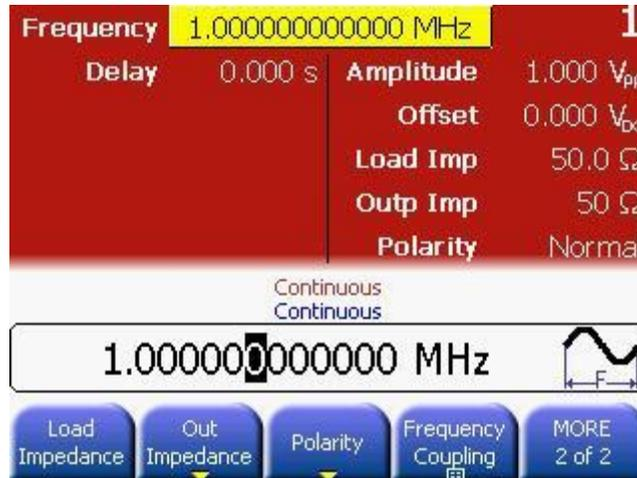

Remote Interface Operation

The following function is used to configure Frequency Coupling remotely:

```
:TRACk:FREQUency {ON|OFF}
```

The following functions are used to configure the frequency of channel 1 and channel 2.

```
:TRACk:FREQUency:DIVider {<divider>}
```

```
:TRACk:FREQUency {<multiplier>}
```

The allowed range for divider and multiplier are 1-255. But are limited by the currently active frequency limits of channel 2.

Channel Coupling

Introduction The Keysight 81150A / 81160A allows to use the two channels completely independent, or in a frequency and phase locked mode.

Characteristics In the Channel Coupling mode, the frequency and phase of both the channels are locked. Locking the output frequency and phase of both channels does have a noticeable effect on most of the major modes of operation.

Therefore, as a result of coupling, the output function, and all other parameters like, burst, sweep, and modulation are also kept identical on both channels.

Refer to the Appendix for complete list of coupled parameters and Tutorial for more details.

Front Panel Operation Press the **Ch 1** and **Ch 2** key to select the channel that defines the setting that will be used when enabling channel coupling.

Then press the **Coupling** key to enable channel coupling.

Remote Interface Operation The following function is used to configure Channel Coupling remotely:

```
:TRACk:CHANnel [1|2] {ON|OFF}
```

3.2.16 Polarity

Introduction In the normal mode (default), the waveform goes positive during the first part of the cycle. In the inverted mode, the waveform goes negative during the first part of the cycle.

Waveform Polarity characteristics

- As shown in the examples below, the waveform is inverted relative to the offset voltage. Any offset voltage present will remain unchanged when the waveform is inverted.
- When a waveform is inverted, the Trigger Out and Strobe Out signal associated with the waveform is not inverted.

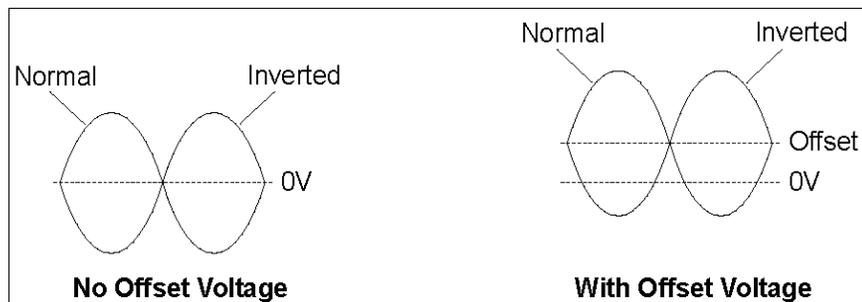

Front-Panel Operation

Polarity is available on the Function screens. Press the **Polarity** softkey again to toggle between Normal and Inverted Polarity.

Remote Interface Operation

The following function is used to configure the waveform polarity remotely:

```
:OUTPut[1|2]:POLarity {NORMal|INVerted}
```

3.2.17 Strobe Output

Introduction **81150A:** One strobe output for each channel is provided on the front-panel. The strobe output signal provides different meanings depending on the mode of operation.

81160A: The 'Logical Strobe Signal' is an internally generated signal that can be routed to the BNC connector of Sync Out A or Sync Out B. For the two channel instrument, the 'Logical Strobe Signal' is generated for both, channel 1 and channel 2. See chapter 3.2.19 'Sync Output' for more details.

-
- Mode of Operation**
- **If no advanced mode is selected**, the strobe output is a constant "Low Level".
 - **If Burst mode is enabled**, the strobe output provides a signal indicating the duration of a burst. The Strobe Out signal marks the start and the end of each burst of waveforms generated. The rising edge of the Strobe Out signal is synchronized to the start of the first waveform period in a burst. The falling edge is synchronized to the start of the last waveform period in the burst.
 - **In sweep mode**, the strobe output is a square waveform with 50% duty cycle. The strobe signal goes high at the beginning of the sweep.
 - **In sweep mode with frequency marker ON**, the Strobe Out Singal goes high at the beginning of the sweep and goes low at the marker frequency.
 - **If modulation is enabled** (AM, FM, FSK, PM, PWM), the Strobe Out Singal is the analog modulation waveform.

Front Panel Operation

The Strobe Out Level can be selected on the Trigger/Mode screen. To display the Trigger/Mode screen press either the , , or  key (depending on the trigger mode being used).

Then, press the **Strobe Out** softkey to choose from TTL/ECL/±2V at Strobe Out.

Remote Interface Operation :OUTPut [1|2]:STRobe:VOLTagE {TTL|ECL|SYM4vpp}

3.2.18 Trigger Output

Introduction **81150A:** One trigger output for each channel is provided on the front-panel.

81160A: The 'Logical Trigger Signal' is an internally generated signal that can be routed to the BNC connector of Sync Out A or Sync Out B. For the two channel instrument, the 'Logical Trigger Signal' is generated for both, channel 1 and channel 2. See chapter 3.2.19 'Sync Output' for more details.

Mode of Operation **If modulation is enabled** (AM, FM, PM, PWM), the Trigger Output has the frequency of the unmodulated carrier waveform with 50% duty cycle. For FSK modulation the Trigger Output outputs the same frequency as the data output – it alternates between the two frequencies.

If noise is selected the Trigger Output is constant Low if the trigger mode is continuous or gated. If the trigger mode is triggered, then Trigger-Out will generate a 4.16 ns for 81150A (1.5 ns for 81160A) pulse when the noise generation is being reset to the start of the noise sequence.

For all other modes of operation the trigger signal (Trigger Out) marks the start of each waveform period.

Front Panel Operation

The Trigger Out Level can be selected on the Trigger/Mode screen.

To display the Trigger/Mode screen press either the , , or  key (depending on the trigger mode being used).

Then, press the **Trigger Out** softkey to choose from TTL/ECL at Trigger Out.

Remote Interface Operation :OUTPut [1|2]:TRIGger:VOLTagE {TTL|ECL}

3.2.19 Sync Output

Introduction The Sync Outputs exist on the 81160A, only. The 81150A has one Trigger Output per channel and one Strobe Outputs per channel.
For the one channel instrument as well as the two channel instrument of 81160A two high speed Sync Out A and Sync Out B outputs are provided at the front panel.

Mode of Operation The Sync Output signals can be configured very flexible by an internal switch matrix to output the 'Logical Trigger Signal' functionality or 'Logical Strobe Signal' functionality according to the following switch matrix:

81160A-001 (1 channel instrument)

Output at BNC Connector	Internal Logical Signal
Sync Out A source:	None, Logical Trigger Signal Channel 1, Logical Strobe Signal Channel 1
Sync Out B source:	None, Logical Trigger Signal Channel 1, Logical Strobe Signal Channel 1

⇒ **Note:** It is e.g. possible, that the Logical Trigger Signal 1 functionality is routed simultaneously to Sync Out A and Sync Out B.

81160A-002 (2 channel instrument)

Output at BNC Connector	Internal Logical Signal
Sync Out A source:	None, Logical Trigger Signal Channel 1, Logical Strobe Signal Channel 1, Logical Trigger Signal Channel 2, Logical Strobe Signal Channel 2
Sync Out B source:	None, Logical Trigger Signal Channel 1, Logical Strobe Signal Channel 1, Logical Trigger Signal Channel 2, Logical Strobe Signal Channel 2

⇒ **Note:** It is e.g. possible, that the Logical Trigger Signal Channel 1 functionality is routed simultaneously to Sync Out A and Sync Out B.

Front Panel Operation

Press one of the trigger mode keys ( ,  , or ) to display the Trigger Mode Screen.

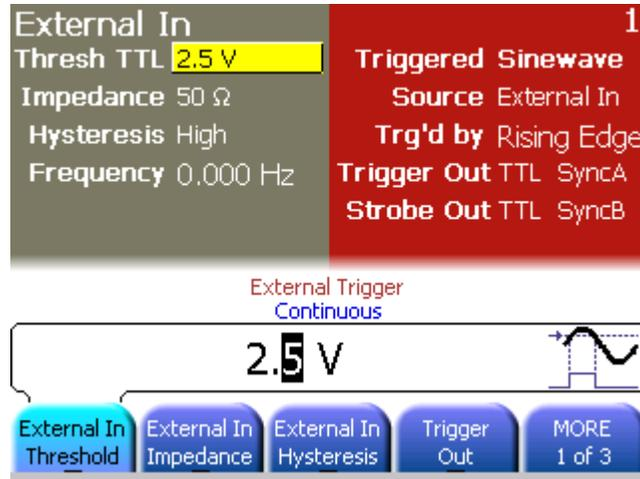

The settings above indicate that 'Logical Trigger Signal 1' is routed to Sync A. 'Logical Strobe Signal 1' is routed to Sync B. Sync A and Sync B output levels are set to TTL.

Remote Interface Operation

```
:OUTput [1|2]:TRIGger:ROUte[?] {NONE | SYNA | SYNB | SYAB}
:OUTput [1|2]:STRobe:ROUte[?] {NONE | SYNA | SYNB | SYAB}
```

3.3 Input Configuration

Introduction

This section contains information on the following parameters:

- External In Parameters
 - Threshold Voltage
 - Input Impedance
 - Modulation In Parameters
 - Input Voltage Range
 - Input Impedance
 - FSK Threshold Voltage
 - Reference Clock
-

3.3.1 External In Parameters

Introduction

The External In Parameters contain the following:

- 81150A and 81160A: Threshold Voltage
- 81150A and 81160A: Input Impedance
- 81160A only: Hysteresis
- 81160A only: Frequency

Front Panel Operation

Press one of the trigger mode keys ( ,  , or ) to display the Trigger Mode Screen.

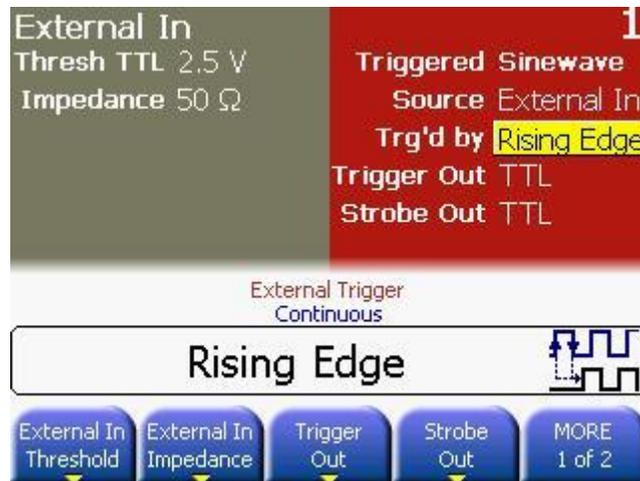

Trigger Mode Screen of the 81150A

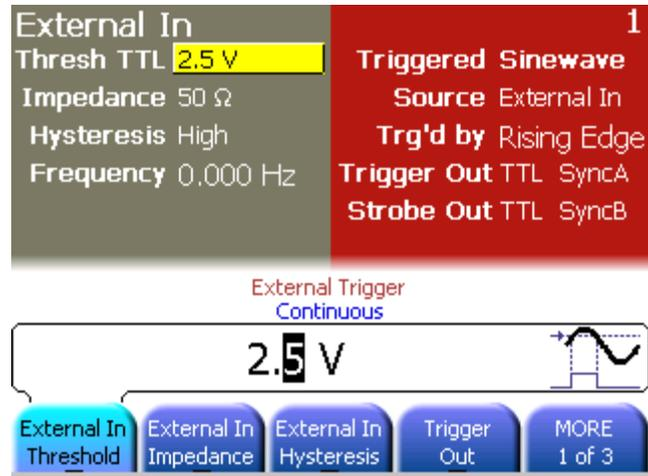

Trigger Mode Screen of the 81160A

Threshold Voltage

Introduction

The External In Threshold Voltage defines the threshold voltage that is used to detect signals at the External-In Connector. The Threshold can be set to any voltage in the range of -10 V to $+10$ V for the 81150A (-5 V to $+5$ V for the 81160A).

Front Panel Operation Press the **External In Threshold** softkey to select from the pre-defined threshold settings (TTL or ECL). Use the numeric keypad or the rotary knob to select any other threshold voltage.

Remote Interface Operation :ARM:LEVel <threshold voltage>

Input Impedance

Introduction **81150A:** The Input Impedance of the External In connector can be set to 50 Ω or 10 k Ω .
81160A: The Input Impedance of the External In connector can be set to 50 Ω or 1 k Ω .

Front Panel Operation Press the **External In Impedance** softkey to select the Input Impedance.

Remote Interface Operation :ARM:IMPedance <input impedance>
The value will be rounded to the allowed settings.

Hysteresis

Introduction 81160A only: The Hysteresis of the External In connector can be set to High or Low. Select 'High' for Input signals that have slow transition times and that may be noisy. Select 'Low' for input signals with fast transitions.

Front Panel Operation Press the **Hysteresis** softkey to select the Hysteresis.

Remote Interface Operation :ARM[:SEquence][:START][:LAYer]:HYSTeresis [LOW | HIGH]

Frequency

Introduction 81160A only: The frequency applied to External In is measured.

Remote Interface Operation :ARM[:SEquence][:START][:LAYer]:EFREquency?/qonly/[NR3]

3.3.2 Modulation In Parameters

Introduction The Modulation In Parameters are all located on the MOD-IN screen. To show the MOD-IN screen, press the **MOD-IN** softkey on any of the modulation screens.

Modulation-In Parameters The Modulation-In connector has the following parameters:

- 81150A only: Input Voltage Range
- 81150A and 81160A: Input Impedance
- 81150A and 81160A: FSK Threshold Voltage

These are explained below.

Input Voltage Range

Introduction **81150A only:** When selecting external modulation source, the Input Voltage Range defines the full scale of the modulation signal. It can be selected between $\pm 2.5V$ and $\pm 5V$.

81160A: The input voltage range is $\pm 2.5V$ fix.

**Front Panel
Operation**

- Press the **MOD-IN** softkey to go to the **Modulation In** screen.
- Press the **Input Range** softkey.

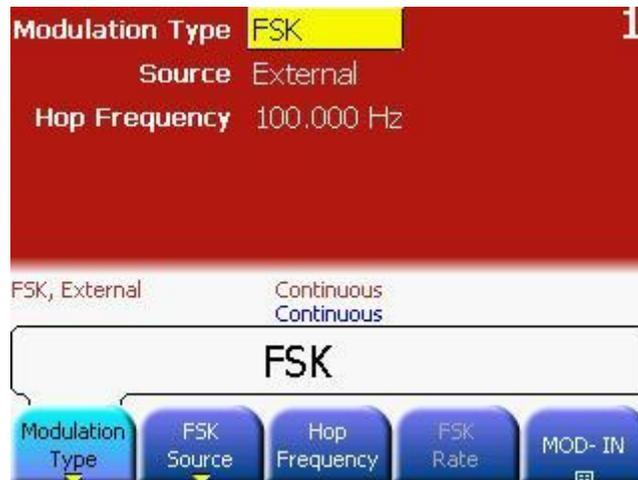

**Remote Interface
Operation**

```

:AM[1|2]:EXtErnal:RANGe {<volts>|MINimum|MAXimum}
:FM[1|2]:EXtErnal:RANGe {<volts>|MINimum|MAXimum}
:PM[1|2]:EXtErnal:RANGe {<volts>|MINimum|MAXimum}
:PWM[1|2]:EXtErnal:RANGe {<volts>|MINimum|MAXimum}
:FSK[1|2]:EXtErnal:RANGe {<volts>|MINimum|MAXimum}
    
```

Input Impedance

Introduction When selecting external modulation source, impedance of the Modulation-In connector can be selected between 50 Ω and 10 k Ω .

Front Panel Operation Press the **MOD-IN** softkey to go to the **Modulation In** screen.
Press the **Impedance** softkey.



Remote Interface Operation

```

:FSKey[1|2]:EXTernal:IMPedance{<ohms>|MINimum|
MAXimum}
:AM[1|2]:EXTernal:IMPedance{<ohms>|MINimum|
MAXimum}
:FM[1|2]:EXTernal:IMPedance{<ohms>|MINimum|
MAXimum}
:PM[1|2]:EXTernal:IMPedance{<ohms>|MINimum|
MAXimum}
:PWM[1|2]:EXTernal:IMPedance{<ohms>|MINimum|
MAXimum}
:FSK[1|2]:EXTernal:IMPedance{<ohms>|MINimum|
MAXimum}
    
```

FSK Threshold Voltage

Introduction

The Modulation-In Threshold defines the signal level at which the FSK will shift to the hop frequency.

- If the signal levels are less than the Modulation-In Threshold, then the output signal will have the Carrier Frequency
- If the signal levels are more than the Modulation-In Threshold, then the output signal will have the Hop Frequency
- The allowed range is $\pm 5V$ for the 81150A ($\pm 2.5V$ for the 81160A); and is limited by Modulation-In Input Range.

Front Panel Operation

After selecting the modulation function, press the **Modulation Type** softkey to select FSK.

Then, press the **MOD-IN** softkey.

Press **Threshold** softkey. Select from TTL, ECL or Variable.



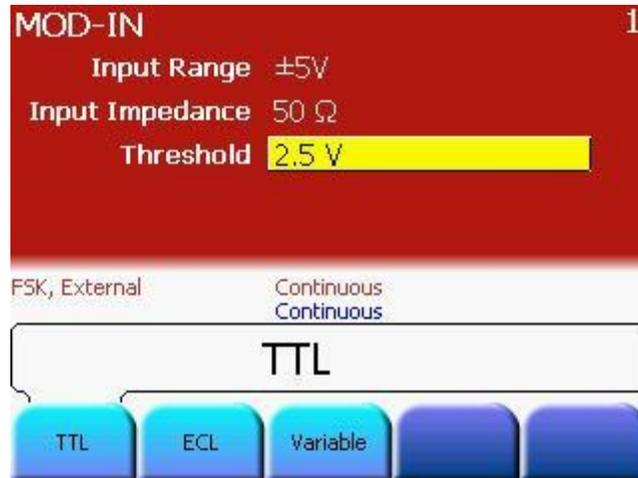

Remote Interface Operation :FSKey[1|2]:EXTernal:LEVel{<volts>|MINimum|MAXimum}

3.3.3 Reference Clock

Introduction

The Reference Clock defines the time base from which all other timing parameters are derived. There are two modes available:

- Manual mode – In this mode, you can select the Reference Clock yourself.
- Automatic Mode – In this mode, the instrument will select the External Clock Reference whenever it detects one.

The source for the Reference Clock can be

- Internal – Selects the Internal 10 MHz clock.
- Ext 10 MHz Ref In – Selects the *10 MHz Ref In* at the Rear Panel.

Characteristics

- The *10 MHz Ref Out* connector at the rear Panel provides the reference clock signal that is currently selected.
 - The PLL state indicates whether the internal PLL is locked or unlocked. This is also reflected in the Questionable Data Register. Refer to the Remote Interface Reference for more information.
-

**Front Panel
Operation**

Press , and then **Reference Clock** softkey.

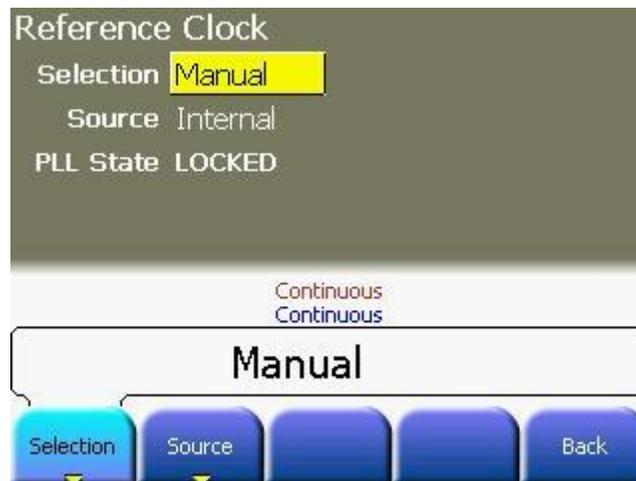

**Remote Interface
Operation** :ROSCillator:SOURce {INTernal|EXTernal}
 :ROSCillator:SOURce:AUTO {ON|OFF}

3.4 Pulse Waveforms

Introduction

A pulse waveform consists of a period, a pulse width, a rising edge, and a falling edge. This is shown in the following figure.

In pulse mode, it is possible to adjust the transition times of the pulse (leading and trailing edge settings).

Pulse Width refers to the start of leading edge to start of trailing edge.

In this format, the pulse-width is independent of changes in pulse period and delay.

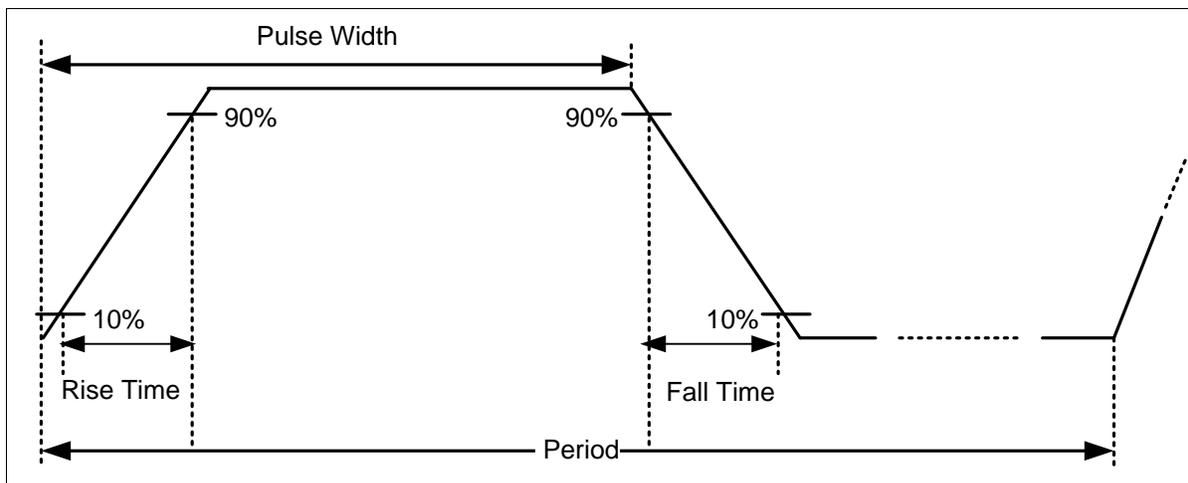

3.4.1 Pulse Period

Introduction The pulse period defines the time between two consecutive pulses from the start of the leading edge to the start of the next leading edge.
It can be set as either period or frequency.
The pulse period will be ignored for triggered pulses.

Pulse Period Characteristics

- **81150A:** Pulse period limits: 8.33 ns to 1000000 s.
- **81160A:** Pulse period limits: 3.03 ns to 1000000 s.
- Pulse frequency limits: 1 μ Hz to 120 MHz for 81150A. 1 μ Hz to 330 MHz for 81160A
- The default value is 1 μ s/1MHz.
- The specified period must be greater than the sum of the pulse width and the edge time as shown below.
Period \geq Pulse Width + (1.6x Edge Time)

Front-Panel Operation After selecting the pulse function, press the **Frequency** softkey again to toggle to the **Period** softkey. Then use the knob or numeric keypad to enter the desired pulse period.

Remote Interface Operation The following function is used to configure the Pulse Period remotely:

```
:PULSe:PERiod[1|2] {<seconds>|MINimum|MAXimum}
:PULSe:FREQuency[1|2] {<frequency>|MINimum|
MAXimum}
```

3.4.2 Pulse Width

Introduction	<p>Pulse Width refers to the start of leading edge to start of trailing edge. In this format, the pulse-width is independent of changes in pulse period and delay.</p> <p>The Pulse Width can be specified as:</p> <ul style="list-style-type: none"> • Width in seconds • Duty Cycle (percentage of period) • Trail Delay
<hr/>	
Pulse Width Characteristics	<ul style="list-style-type: none"> • Pulse width: W_{min} to 950000s (see restrictions below). The default pulse width is 50ns. • The Pulse width is limited by the minimum possible width of W_{min}. • Pulse Width $\geq W_{min}$ • Pulse Width \leq Period – W_{min} <p>81150A: Where W_{min} is either 4.1ns or 10ns depending on the selected amplifier (See section Amplifier Type Selection).</p> <p>81160A: Where W_{min} is 1.5 ns.</p>
<hr/>	
Front-Panel Operation	<p>After selecting the pulse function, press the Width/Duty Cycle/Trailing Delay softkey. Then use the knob or numeric keypad to enter the desired pulse width.</p>
<hr/>	
Width in Seconds	<p>The absolute pulse width measured from the start of the leading edge to the start of the trailing edge. In this format, the pulse width is independent of changes in pulse period and delay.</p>
<hr/>	
Duty Cycle	<p>The duty cycle is the pulse width measured from the start of the leading edge to the start of the trailing edge expressed as a percentage of the period. In this format, if you adjust the period, the absolute width is adjusted to maintain the duty cycle.</p>
<hr/>	

Trail Delay

The trailing delay is the absolute delay from the start of the pulse period to the start of the trailing edge. In this format the trailing edge remains fixed relative to the start of the pulse period if you adjust the pulse-delay (leading-edge delay) or the pulse period.

Remote Interface Operation

The following function is used to configure the Pulse Width remotely:

```
:PULSe:WIDTh[1|2] {<seconds>|MINimum|MAXimum}  
:PULSe:DCYCLe[1|2] {<percent>|MINimum|MAXimum}  
:PULSe:TDELay[1|2] {<seconds>|MINimum|MAXimum}  
:PULSe:HOLD[1|2] {WIDTh|DCYCLe|TDELay}  
:FUNction[1|2]:PULSe:WIDTh{<seconds>|MINimum|  
MAXimum}  
:FUNction[1|2]:PULSe:DCYCLe{<percent>|MINimum|  
MAXimum}  
:FUNction[1|2]:PULSe:TDELay{<seconds>|MINimum|  
MAXimum}  
:FUNction[1|2]:PULSe:HOLD {WIDTh|DCYCLe|TDELay}
```

3.4.3 Leading Edge/Trailing Edge

Introduction The edge time sets each edge transition time (rising and falling) of the pulse. For each transition, the edge time represents the time from the 10% threshold to the 90% threshold.

- Characteristics**
- **81150A:** Edge time: 2.5 ns to 1000 s (see restrictions below). The default edge time is 2.5 ns.
 - **81150A:** The minimum edge time is limited to 7.5 ns. If the amplifier type is set to “max. Amplitude.”
 - **81160A:** Edge time: 1.0 ns to 1000 s. The default edge time is 1.0 ns.
 - Lead Edge and Trail Edge may be specified in seconds or % of period.
 - Trail Edge can be configured to follow the leading edge.
-

Front-Panel Operation After selecting the pulse function, press the **Lead Edge/Trail Edge** softkeys. Then use the knob or numeric keypad to enter the desired edge time.

**Remote Interface
Operation**

The following function is used to configure the **Leading Edge** remotely:

```
:PULSe:TRANSition[1|2]{<seconds  
or  
percentage>|MINimum|MAXimum}
```

```
:FUNction[1|2]:PULSe:TRANSition{<secondso  
or  
percentage>|MINimum|MAXimum}
```

The following function is used to configure the **Trailing Edge** remotely:

```
:PULSe:TRANSition[1|2]:TRAILing{<seconds  
or  
percentage>|MINimum|MAXimum}
```

```
:PULSe:TRANSition[1|2]:TRAILing:AUTO{OFF|ON|ONCE}
```

```
:FUNction[1|2]:PULSe:TRANSition:TRAILing:AUTO  
{OFF|ON|ONCE}
```

It is used to set the automatic coupling of the pulse-trailing-edge transition time to the leading-edge transition time.

- **ON:** The trailing-edge transition time is automatically set to the same value as the leading edge and is updated automatically each time the leading-edge transition time changes.
- **OFF:** The trailing-edge/leading-edge transition time is independently programmable.
- **ONCE:** The trailing-edge transition time is set ONCE to the same value as the leading edge.

The following function is used to set the unit for the remote programming of the leading and trailing edge times.

```
:PULSe:TRANSition[1|2]:UNIT {S|SEC|PCT}
```

The following function is used to set the coupling between transition times and the pulse width.

```
:PULSe:TRANSition[1|2]:HOLD {TIME|WRATIO}
```



- Pattern capability is an extension of Pulse functionality.
 - The standard pulse parameters (frequency, period, leading edge, amplitude, offset, high level, low level, load impedance, output impedance and polarity) with the exception of width and trailing edge are valid for pattern mode also. This is further explained in the following sections.
-

3.5 Pattern Capabilities

Introduction

A Pattern is a digital data stream that is stored in volatile or non-volatile memory, generated algorithmically or provided by an external data source for re-timing and re-shaping.

- Multi-level patterns, using 2, 3 or 4 different levels, allowing support for serial protocols that require electrical idle signaling in the data streams.
- 81150A: Up to 16 Mbit long memory 2- level based patterns. Up to 8 Msymbols long memory based 3- and 4-level patterns.
- 81160A, 1 channel: Up to 4 Mbit long memory 2- level based patterns. Up to 2 Msymbols long memory based 3- and 4-level patterns.
- 81160A, 2 channels: Up to 2 Mbit long memory 2- level based patterns. Up to 1 Msymbols long memory based 3- and 4-level patterns.
- Support for algorithmic PRBS patterns
- Support of one adjustable loop, allowing easy integration of initialization sequences into the data stream before the actual test pattern.
- In triggered and gated mode, the pattern can be either controlled on a per block or per bit basis.
- NRZ formatting or arbitrary bit shapes.
- User definable bit shapes allow emulation of real world signal shapes that include over- and undershoot, ringing or distorted level transitions.

Front Panel Operation

After selecting the pulse function, press the **Pattern Setup** softkey. This will show the Pattern Setup screen. Then, press the desirable softkey to change the parameters.

3.5.1 Pattern Mode

Introduction This parameter enables the pattern mode. The Pattern Mode can be set to On/Off.

Front Panel Operation After selecting the **Pattern Setup** softkey, press the **Pattern Mode** softkey to enable or disable pattern mode.

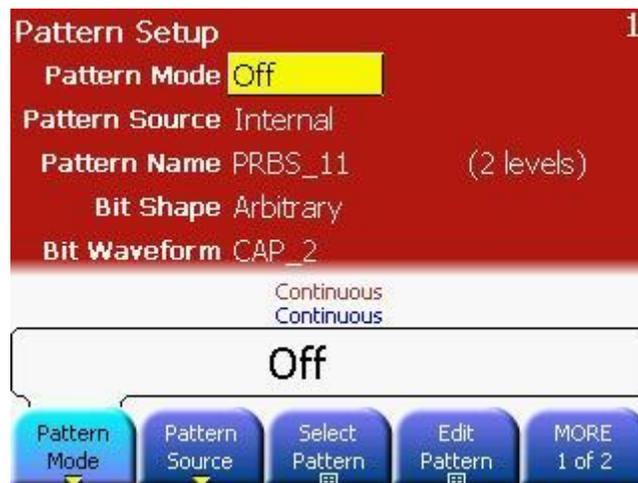

Remote Interface Operation :DIGital[1|2] {ON|OFF}

3.5.2 Pattern Source

Introduction

The pattern source can be Internal/External.

When selecting the internal pattern source, the 81150A / 81160A does generate the pattern internally either algorithmically or from memory. Additionally it is possible to provide an externally generated data stream at MOD-IN for re-shaping by the 81150A / 81160A. To do this, select the external pattern source.

For details on external pattern, refer to the External Patterns section.

Front Panel Operation

After selecting the **Pattern Setup** softkey, press the **Pattern Source** softkey.

- The Pattern Source can be Internal or External.
- If the Pattern Source is Internal, one of the built-in or user-defined patterns or a PRBS can be selected.
- If the Pattern Source is External, the pattern data is supplied on the MOD-IN connector on the rear-panel of the 81150A / 81160A.

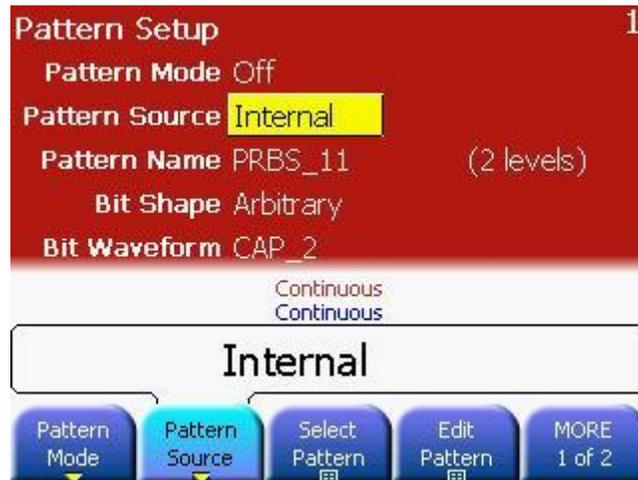

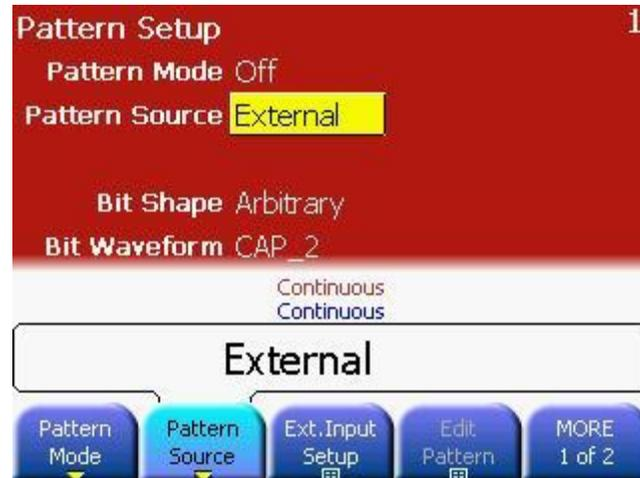

Remote Interface Operation :DIGital[1|2]:SOURce {INTernal|EXTernal}

3.5.3 Configuring the External Pattern Source

Introduction

External patterns are provided at the MOD-IN connector of the rear panel. In external or 'pass-through' pattern mode, the 81150A / 81160A can be used to re-time and re-shape and externally provide data stream according to the configured data rate, output levels, number of levels and formatting settings like any internal generated pattern.

Front Panel Operation

After selecting External Pattern Source, press the **Ext. Input Setup** softkey.

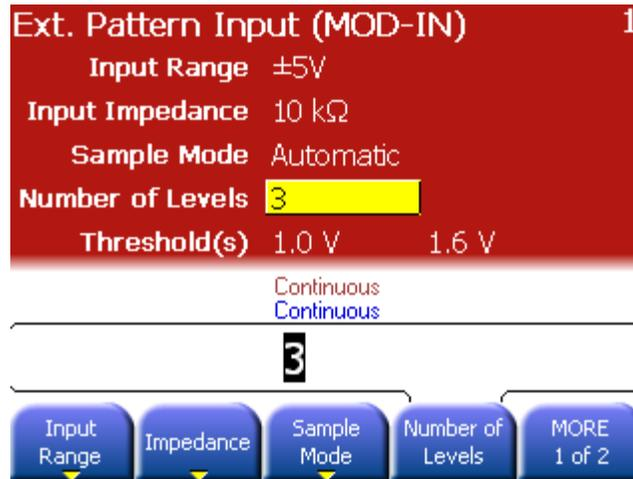

Input Voltage Range

Introduction When selecting external pattern source, the Input Voltage Range defines the full scale of the pattern signal. It can be selected between $\pm 2.5V$ and $\pm 5V$ for the 81150A (is fix $\pm 2.5V$ for the 81160A).

Front Panel Operation

- On the pattern mode screen press the **Ext. Input Setup** softkey.
- 81150A only: Press the **Input Range** softkey.

Remote Interface Operation :DIGital[1|2]:SOURce:EXTernal:RANGe
{<volts>|MINimum|MAXimum}

Input Impedance

Introduction When selecting external pattern source, the impedance of the Modulation-In connector can be selected between 50Ω and $10 k\Omega$.

Front Panel Operation

- On the pattern mode screen press the **Ext. Input Setup** softkey.
- Press the **Impedance** softkey.

Remote Interface Operation :DIGital[1|2]:SOURce:EXTernal:IMPedance
{<volts>|MINimum|MAXimum}

Sample Mode

Introduction

The sample mode defines how the 81150A / 81160A is sampling the externally provided data stream. In fixed sampling mode there is a fix relation between the sampling time and the rising edge of the TRIGGER-OUT signal. In automatic sampling mode, the 81150A / 81160A is searching for an initial transition and then samples at the configured data rate. Transition search is being restarted after a certain time of inactivity at the input.

Considerations for Sampling Mode and Frequency

In external (or pass-through) pattern mode, the following considerations with respect to sampling mode and frequency should be taken into account:

- If you can control the data rate of your external data pattern source, use the 81150A / 81160A “Trigger Out” signal to drive the clock input of your external pattern source. Set the 81150A / 81160A frequency to the desired data rate and use “Fixed” sampling mode. This gives you the greatest flexibility in creating ideal and distorted signals. You can use NRZ with adjustable transition times or arbitrary bitshapes and add AM or PM modulation to create jitter and noise on the output signal.
- If your external pattern source delivers a continuously running clock signal together with the data signal and you want the 81150A / 81160A to follow exactly that external clock, then consider using “Triggered” mode (with the external clock signal connected to “External-In”) and “Fixed” sampling. If you use arbitrary bitshapes, the 81150A / 81160A frequency setting determines the duration of a bitshape. The bit rate is determined by the external clock. Modulation is not available in this case.
- If you cannot control the data rate of your external pattern source and your pattern source does not deliver a continuously running clock signal, set the 81150A / 81160A to “Continuous” Mode with “Automatic” sampling. Set the 81150A / 81160A frequency approximately to the data rate of your external pattern source. In order for the 81150A / 81160A to correctly pass that pattern through, it is necessary that the data pattern occasionally contains sequences of 8 or more identical bits (or 8 or more unit intervals of electrical idle in case of 3-level patterns). This allows the 81150A / 81160A to adjust its sampling point. Sequences of identical bits might be stretched or shortened depending on the relationship of pattern frequency and 81150A / 81160A frequency, but bit sequences in between idles are passed through correctly. This mode is intended for packet-oriented serial data transmissions such as FlexRay or CAN. You can use NRZ or arbitrary bitshapes as well as AM or PM modulation in this case, but you have to be aware that there is no fixed delay through the 81150A / 81160A in “Automatic” sampling mode.
- Depending on your application, you can choose the 81150A / 81160A frequency to be significantly higher (e.g. 10 times) the data rate of your external pattern signal. In this case, you have a sampling uncertainty (e.g. 1/10 of a unit interval), but you have a reduced delay and you can still adjust amplitude/offset of the re-generated signal. Transition time adjustment or arbitrary bitshapes are limited to one period of the 81150A / 81160A frequency (e.g. 1/10 of a unit interval).

-
- | | |
|------------------------------|---|
| Front Panel Operation | <ul style="list-style-type: none">• On the pattern mode screen press the Ext. Input Setup softkey.• Press the Sample Mode softkey. |
|------------------------------|---|
-

Remote Interface Operation	<code>:DIGital[1 2]:SOURce:EXTernal:SAMPLing {AUTO FIXed}</code>
-----------------------------------	--

Number of Levels

Introduction	Defines the number of levels that have to be detected in the provided external pattern signal. Allowed values are 2 and 3 levels.
---------------------	---

- | | |
|------------------------------|---|
| Front Panel Operation | <ul style="list-style-type: none">• On the pattern mode screen press the Ext. Input Setup softkey.• Press the Number of Levels softkey.• Enter the number of levels using the numerical keypad, or turn the rotary knob to select the desired number of levels. |
|------------------------------|---|
-

Remote Interface Operation	<code>:DIGital[1 2]:NLEVELs{<number of levels> MINimum MAXimum}</code>
-----------------------------------	--

Lower Threshold Voltage

Introduction

The lower threshold voltage defines the voltage level at which a sample is considered being a logical '0'. If the voltage at MOD-IN is less or equal to the lower threshold voltage, then the external provided bit is considered being '0'. This is true for 2-level and 3-level signals. In case of 2 level signals, a voltage level above the lower threshold is considered being a logical '1'.

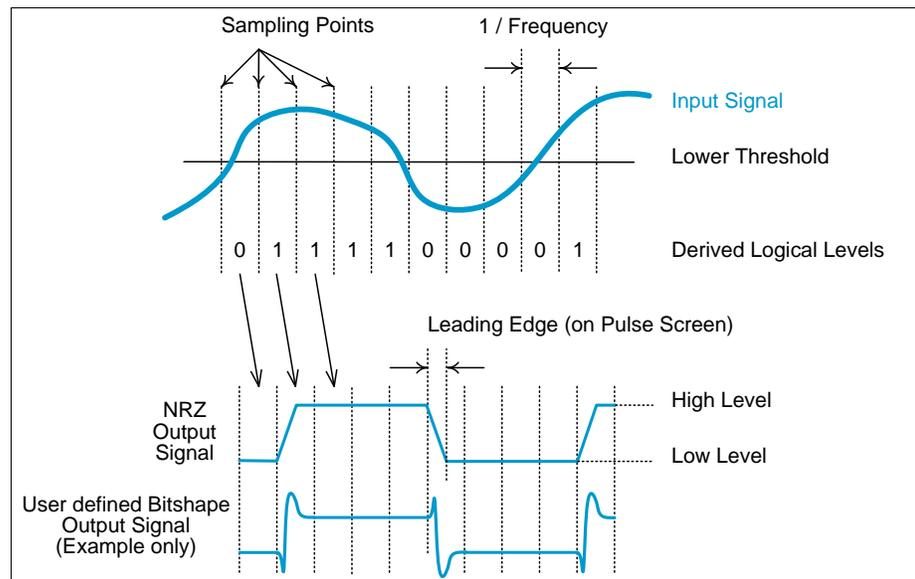

Front Panel Operation

- On the pattern mode screen press the **Ext. Input Setup** softkey.
- Press the **Number of Levels** softkey.
- Enter the number of levels using the numerical keypad, or turn the rotary knob to select the desired number of levels.

Remote Interface Operation

```
:DIGital[1|2]:SOURCE:EXTERNAL:THReshold
{<volts>|MINimum|MAXimum}
```

Upper Threshold Voltage

Introduction

The upper threshold voltage defines the voltage level at which a sample is considered being a logical '1'. If the voltage at MOD-IN is above the upper threshold voltage, then the external provided bit is considered being '1'. If the voltage is above the lower threshold, but less than or equal to the upper threshold, then the bit is considered being an idle symbol (will result in the programmed offset voltage at the output). The upper threshold is only used for 3-level signals.

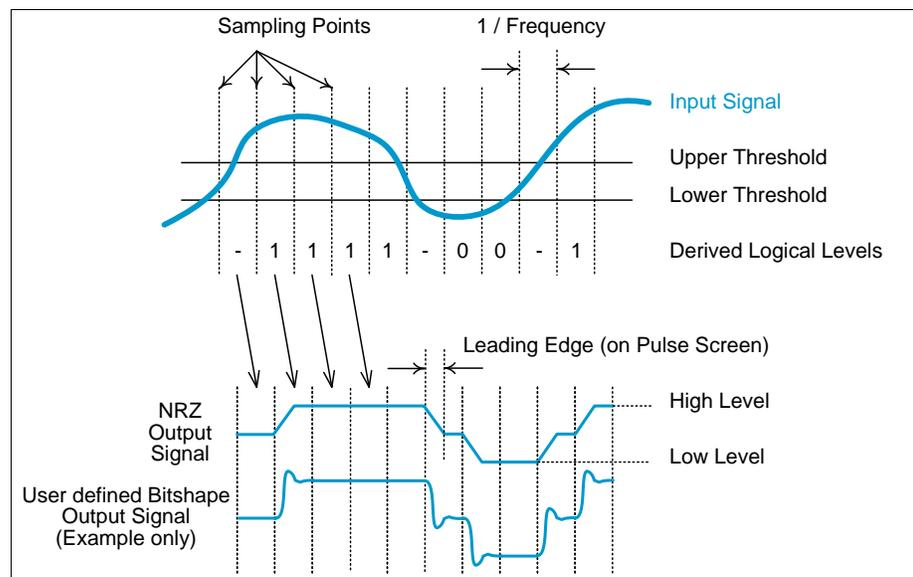

Front Panel Operation

- On the pattern mode screen press the **Ext. Input Setup** softkey.
- Press the **Upper Threshold** softkey.
- Enter the threshold voltage using the numerical keypad, or turn the rotary knob to adjust the upper threshold voltage.

Remote Interface Operation

```
:DIGital[1|2]:SOURCE:EXTERNAL:THReshold:UPPer
{<volts>|MINimum|MAXimum}
```

3.5.4 Selecting a Pattern

Introduction The Pattern Selection screen works similar to the arbitrary waveform selection screen – except that the choices are limited to user-defined patterns and PRBS sequences. The preview consists of the first bits of the data block. The preview usually doesn't show the complete pattern.

Front Panel Operation After selecting the **Pattern Setup** softkey, press the **Select Pattern** softkey. Use the Rotary Knob or Arrow Keys to select the desired Pattern.

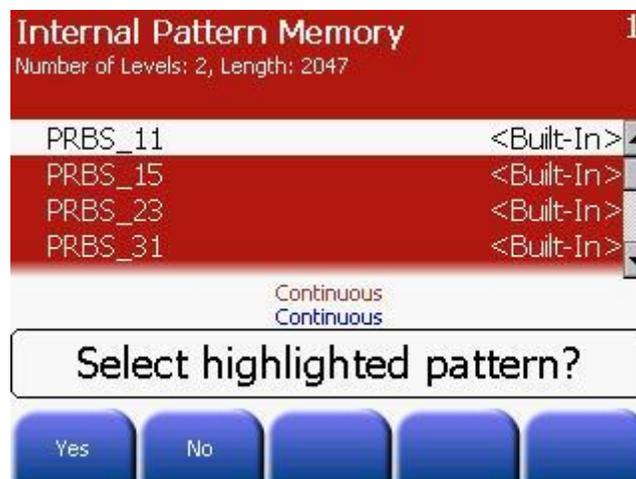
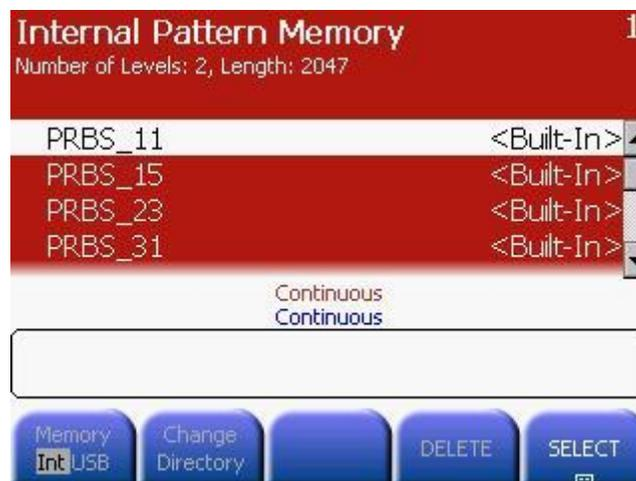

Select Highlighted Pattern Click **Yes** to confirm and **No** to reject the selected pattern.

Remote Interface Operation :DIGital[1|2]:SElect <name>
Or
:MMEMy:LOAD:PATTErn VOLATILE, "<filename>"

3.5.5 Creating, Editing and Storing a Pattern

Introduction This section gives an example which shows you how to create, edit and store a pattern from the front panel.

Create a New Pattern

Front Panel Operation After selecting the **Edit Pattern** softkey, press the **Create New** softkey. Use this screen to modify the attributes of the new pattern and finally press the **EDIT** softkey to reach the Pattern Editor screen as shown below:



Configure the new pattern Configure the new pattern by providing all the information shown in the above screen. When done press the **EDIT** softkey to open the new created pattern in the pattern editor.

Remote Interface Operation :DIG:NLEV 2
:DIG:FORM PACKED,1
:DIG:DATA #2161001101001001001

Number of Bits Defines the initial number of bits in the pattern. For most efficient and easiest editing, the desired pattern length should be chosen on this screen. In case of setting up too less or too many bits here, this can be changed by inserting or removing bits in the process of editing the pattern later on.

Number of Levels Defines the number of different levels or bit values in the pattern. This can be set to 2, 3 or 4.

Default value Defines the default bit value that is used to fill the pattern during creation. Depending on the number of levels, the possible values are 0 and 1 for 2 level patterns. 0, 1 and idle for 3-level patterns. And, 0, 1, 2, 3 for 4-level patterns.

Auto Update **On:** Changes of the pattern will be applied immediately to the output. The editor is slower.
Off: The pattern will be applied to output when editing is finished. The editor is faster due to missing hardware update.

Edit a Stored Pattern

Front Panel Operation After selecting the **Edit Pattern** softkey, press the **Edit Stored** softkey to Edit or Delete a stored pattern. This is shown in the following image.
Press the **EDIT** softkey to edit the selected pattern in the Pattern Editor, which is described below.

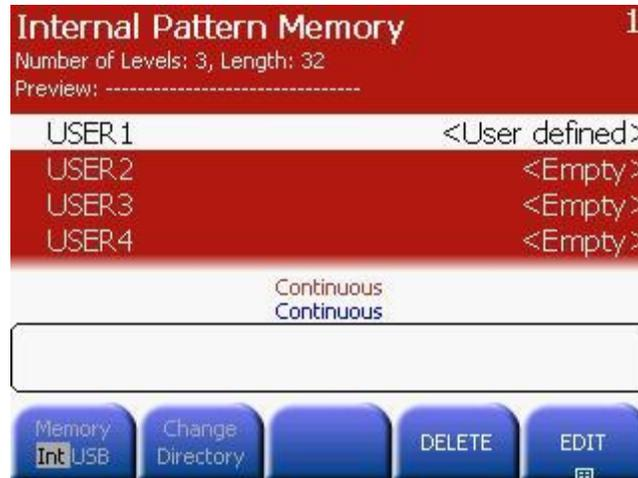

Edit VOLATILE

Front Panel Operation

After selecting the **Edit Pattern** softkey, press the **Edit VOLATILE** softkey to edit a pattern from the VOLATILE memory of the instrument. See the description of the pattern editor below.

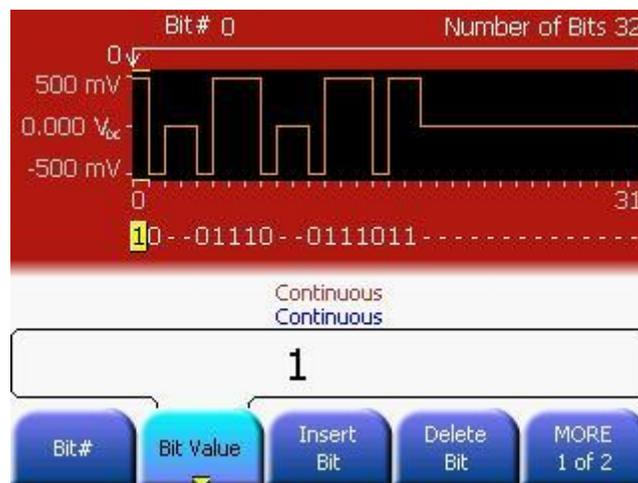

Pattern Edit

On the Pattern Edit screen, Bits can be inserted and deleted, the pattern can be edited, the loop offset can be modified and the pattern can be stored to the non-volatile memory.

Bit#	Selects a bit by its position in the pattern. The Bit# is automatically incrementing when changing the value of a bit.
Bit Value	Press the Bit Value softkey to select the value of the selected bit. Depending on the number of levels in the pattern, the Bit Value can either be set to 0/1, 0/1/idle, or 0/1/2/3. For easy editing, the different bit values can be entered using the numerical keypad. Press 0, 1, 2, 3 for the corresponding bit value. Press the decimal point key to enter a idle or '-' bit.
Loop Offset	The Loop Offset defines the bit position at which the pattern will be continued when the end of the pattern has been reached. The Loop Offset is set to 0 by default, Setting the Loop Offset to values greater than 0, allows the definition of an initialization or preamble pattern in front of the test pattern that will be looped during the pattern generation.
Hw Upd On/Off	Press the Hw Update On/Off softkey to select whether changes in the pattern shall be immediately programmed into the hardware, or if the hardware update shall be suppressed until editing of the pattern is finished. Especially when editing longer patterns, the process of editing will be faster when the pattern download is being suppressed.
STORE in NON-VOL	Press the STORE in NON-VOL softkey to leave the editor, apply the edited pattern to the hardware and store the pattern in non-volatile memory. The 81150A / 81160A provides 4 non-volatile memory locations for patterns. Additionally it is possible to store the pattern to a external USB memory device. See the description of the pattern browser below.
End Edit	Press the END Edit softkey to leave the editor and apply the edited pattern to the hardware. The pattern will be kept in VOLATILE memory when leaving the editor.

Store a Pattern to Non-Volatile Memory

**Front Panel
Operation**

After pressing the **STORE in NON-VOL** softkey in the pattern editor, the pattern browser opens. This allows storing the pattern to one of the 4 built-in memory locations for patterns, or to an external USB memory device.

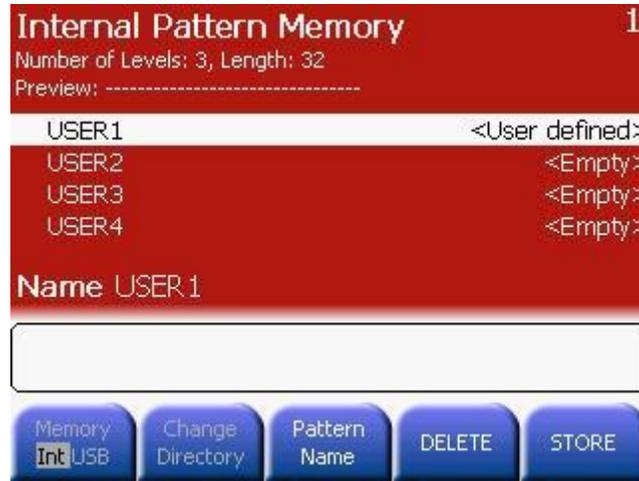

Assigning a Name

- You can assign a custom name to the non-volatile memory locations. The custom name can contain up to 12 characters. The first character must be a letter but the remaining characters can be letters, numbers, or the underscore character (" _ ").
- To add additional characters, press the right-cursor key until the cursor is to the right of the existing name and then turn the knob.
- To delete all characters to the right of the cursor, press the  key.

For this example, assign the name "RAMP_AGT" to memory location 1 and then press the **STORE** softkey to store the waveform. This will bring the following screen.

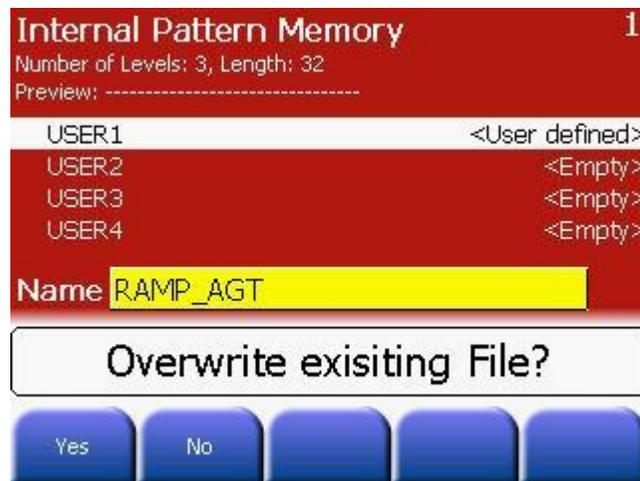

- Press **Yes** to overwrite the new Pattern Name on the existing old name.
- The pattern is now stored in non-volatile memory and is currently being output from the 81150A / 81160A. You can select the storage location by scrolling up and down in the list using the up/down arrow keys or the knob.
- The name that you used to store the pattern will now appear in the list of stored patterns (under the **Pattern Name** softkey).
- If you just change the name, you will effectively overwrite whatever has been stored in this location before.

Remote Interface Operation

Store the pattern in VOLATILE memory in one of the internal, non-volatile storage locations using the given name for the pattern.

```
:DIGital[1|2]:COPY <name>[,VOLATILE]
```

Delete a Stored Pattern**Front Panel
Operation**

After selecting the **Edit Pattern** softkey, press the **Delete Stored** softkey to delete a pattern. Press **DELETE** to delete a stored user defined pattern as shown in the following image.

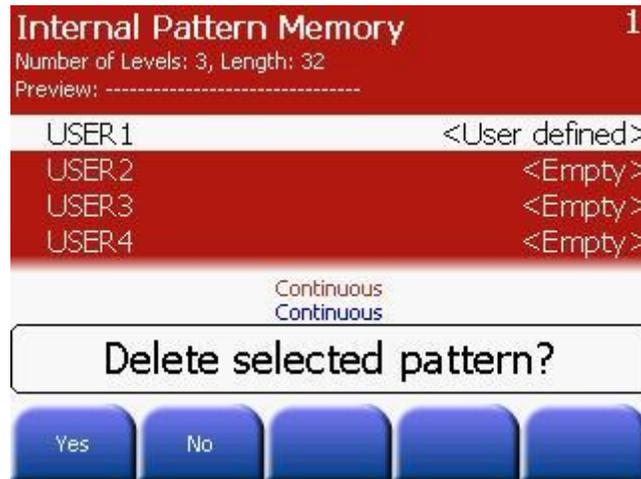
**Remote Interface
Operation**

Delete a pattern from the internal non-volatile storage locations
:DIGital[1|2]:DElete <name>

3.5.6 Bitshape Selection

Introduction If the bit shape parameter on the pattern setup screen is set to Arbitrary, it is possible to select a predefined or use a userdefined waveform that defines the shape of a bit. The screens operate similar to the standard Arb mode.

For details on arbitrary bit shapes, refer to section Defining the Shape of a Bit.

Front Panel Operation After selecting the **Pattern Setup** softkey on the Pulse screen, press MORE 1 of 2 and then press the **Bit Shape** softkey to choose from Arbitrary or NRZ.

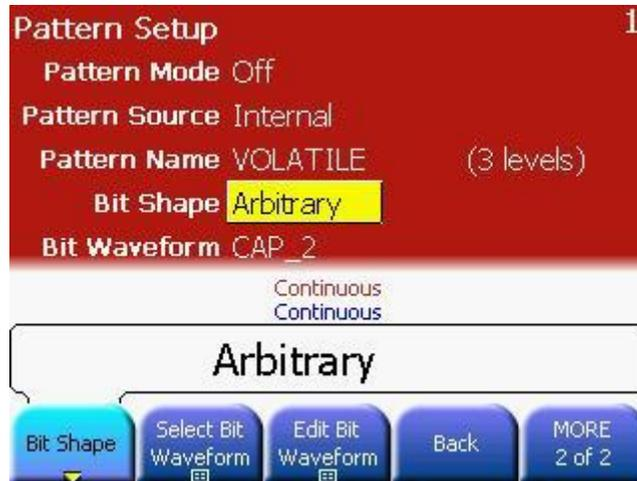

Remote Interface Operation :DIGital[1|2]:SIGNal:FORMat {NRZ|USER}

Select Bit Waveform After selecting the **Bit Shape** softkey, press the **Select Bit Waveform** softkey. This brings you to the following screen.

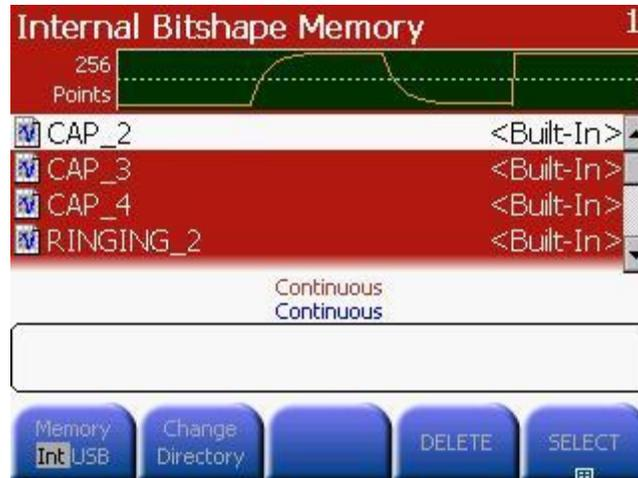

Edit Bit Waveform Press the **Edit Bit Waveform** softkey to go back to the **Creating, Editing and Storing a Bitshape** screen as explained in section 3.5.7.

```
:DIGital[1|2]:SIGNal:FORMat {NRZ|USER}
```

Remote Interface Operation Select a bit shape that is stored in internal non-volatile memory

```
:DIGital[1|2]:TRANSition:SElect <name>
```

Load a bit shape from external USB memory to VOLATILE memory

```
:MMEMory:LOAD:TRANSition VOLATILE, "<filename>"
```

Define the bit shape programmatically

```
:DIGital[1|2]:TRANSition <value>,<value>,...
:DIGital[1|2]:TRANSition:DAC <blockdata>
```

3.5.7 Creating, Editing and Storing a Bitshape

Introduction This section gives an example which shows you how to create, edit and store an arbitrary bit waveform from the front panel.

Front Panel Operation After selecting the **Pattern Setup** softkey, press **MORE**, and then press the **Edit Bit Waveform** softkey.

Create New Bitshape

Front Panel Operation After selecting **Edit Bit Waveform** softkey, press the **Create New** softkey. This screen is shown in the following image.
To Edit Stored, Edit VOLATILE and Delete Stored bit waveforms, refer to section **Creating, Editing and Storing a Pattern**.

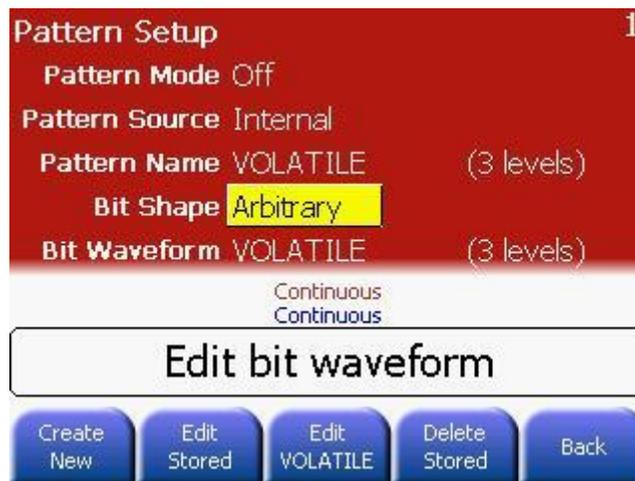

Configure the new waveform Configure the new waveform by providing all the information shown in the following screen.



Set the initial number of waveform points

You can create an arbitrary bit waveform with up to 64 points per bit. Depending on the number of levels of the pattern being used, there are 4, 9 or 16 different bit shapes to be defined in one bit shape waveform. Keep in mind that the waveform is not being played back in sequential order, but instead the samples of one bit are in sequence while the bit definition being used depends on the current and previous bit value in the pattern.

The waveform editor initially builds a waveform with two points. For ease of editing this value should be set to the desired number of points per bit when creating the bit shape waveform. Press the **Initial #Points** softkey to specify the initial number of waveform points (you can add or remove points later if necessary).

For this example, set the initial number of points to “2”.

Select the interpolation method

Press the **Interpolation** softkey to enable or disable linear interpolation between waveform points. With interpolation enabled (default), the waveform editor makes a straight-line connection between points. With interpolation disabled, the waveform editor maintains a constant voltage level between points and creates a “step-like” waveform.

For this example, turn on linear interpolation.

Remote Interface Operation : DIG:TRAN:INT {ON|OFF|0|1}

✎ For bitshapes, interpolation can be enabled from front panel as well as through SCPI.

Auto Update

On: Changes of the waveform will be applied immediately to the output. The editor is slower.

Off: The waveform will be applied to output when editing is finished. The editor is faster due to missing hardware update.

EDIT

Start the point-by-point editing process

Press the **EDIT** softkey to accept the initial waveform settings and begin point-by-point editing.

The editor is separating the waveform into sections. Each of the sections is separated by a vertical dashed line and corresponds to one of the bit shapes that have to be defined. In the upper left corner, the editor is displaying which bit value transition in the pattern will result in the sub waveform currently being edited.

Depending on the number of levels, the maximum number of samples in the waveform varies. With a maximum of 64 samples being used for one bit.

Define the first waveform point

Press **Y** softkey to set the voltage level for Point #1 (this point is fixed at address 0). By default, all points are set to 0.

For this example, set the value of Point # 1 to -8191.

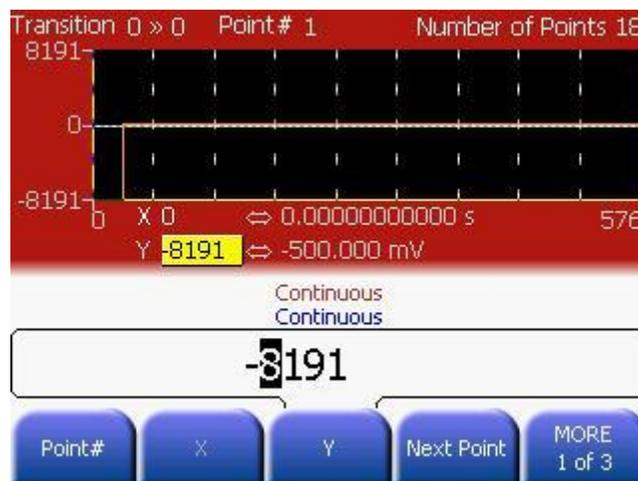

Define the next waveform point

Press the **Point #** softkey and then turn the knob to move to Point #2, or press the **Next Point** softkey.

Press the **X** softkey to set the address for the current point (this softkey is not available for Point #1). Press the **Y** softkey to set the DAC value for the current point.

For this example, Y to -8191. Then press the **Next Point** softkey to proceed to the next point in the waveform.

Define the remaining waveform points

Using the **X** and **Y** softkeys, define the remaining waveform points using the values shown in the table below.

- The X value of the last point that can be defined in each bit transition must be less than $(64 \times \text{bit\#} - 1)$. With bit# being the zero based index of the transition that contains the current point.
- The X value cannot be changed for the first point of each transition definition. These points are marked by the vertical dashed white lines.
- To insert additional points after the current waveform point, press the **Insert Point** softkey. The new point is inserted with the same DAC value as the current point.
- To remove the current waveform point, press the **Remove Point** softkey. The remaining points are joined using the interpolation method currently selected.
- If Point #1 is removed, then Point #2 will be placed to address 0. Remove Point is not possible if the waveform has 2 points, since this is the minimum waveform length.

Point	X	Y	Transition
1	0†	-8191	0 » 0
2	32	-8191	
3	64†	-8191	0 » 1
4	96	+-8191	
5	128†	-8191	0» -
6	160	0	
7	192†	+8191	1 » 0
8	224	-8191	
9	256†	+8191	1 »1
10	288	+8191	
11	320†	+8191	1 »-
12	352	0	
13	384†	0	- »0
14	416	-8191	
15	448†	0	- »1
16	480	+8191	
17	512†	0	- »-
18	544	0	

† These X positions cannot be changed, since the point is the first point in the transition.

Interpol On/Off Press the **Interpolation** softkey to enable or disable linear interpolation between waveform points. With interpolation enabled (default), the waveform editor makes a straight-line connection between points. With interpolation disabled, the waveform editor maintains a constant voltage level between points and creates a “step-like” waveform.

Remote Interface Operation :DIG:TRAN:INT {ON|OFF|0|1}

Hw Upd On/Off Press the **Hw Update On/Off** softkey to select whether changes in the bit shape waveform shall be immediately programmed into the hardware, or if the hardware update shall be suppressed until editing of the waveform is finished.

End Edit

When the editing is finished, the resulting waveform will look similar to the following screenshot.

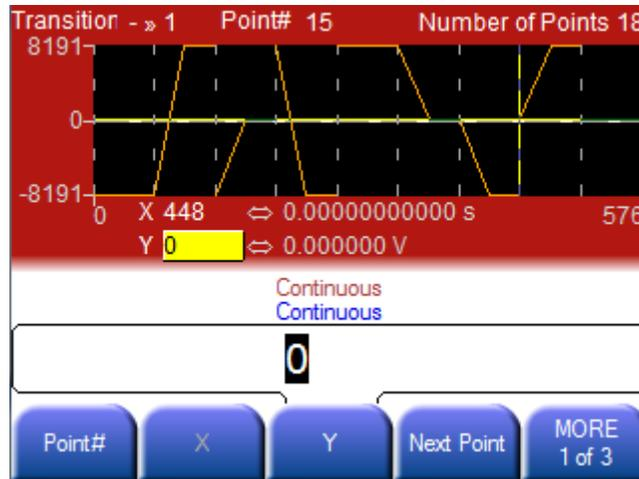

Store the arbitrary bit waveform in memory

END Edit does apply the waveform to the hardware and exits the editor. In this case, the changes are only done on the volatile memory of the waveform.

STORE in NON-VOL does open the waveform browser to store the waveform in non-volatile memory.

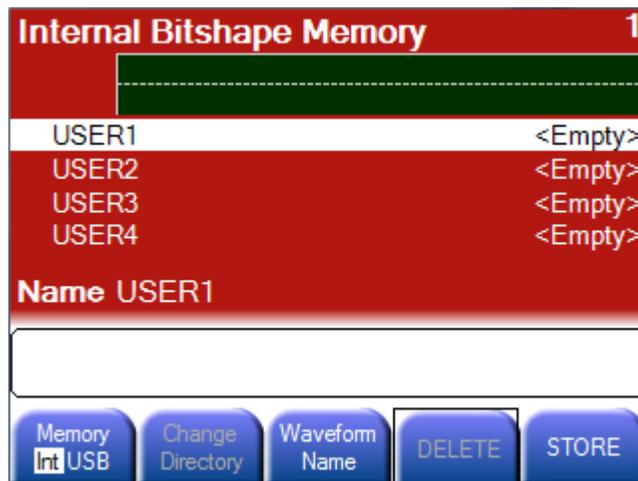

3.5.8 Triggered and Gated Patterns

Introduction

In contrast to other functions like pulse, sinewave or square, triggering or gating patterns does not always refer to exactly one unit interval, or one burst of the selected function.

In pattern mode, it is possible to select whether a trigger event will cause the generation of the complete pattern, or just a single bit.

The behavior in gated mode is similar as it allows to either generate complete pattern cycles, or 'blocks' as long as the gate signal is active, with a started block being completed. Or to gate the pattern on a per bit basis, with the bit being completed when the gate signal is getting inactive.



- The Pattern Trig. Mode is only available when pattern mode is enabled.
- The meaning of the burst length is different for Bit and Block Pattern Trigger Mode. If the Pattern Trigger Mode is set to Bit, the burst length defines the number of bits that shall be generated for the burst. In Block mode the burst length defines the number of complete pattern repetitions that build up the burst.

Front Panel Operation

- Press the **Trig** or **Gated** key on the front panel to enable triggered or gated mode and to switch to the trigger mode screen.
 - In the trigger mode screen press the **Pattern Trig.Mode** Softkey to select between Bit and Block mode.
-

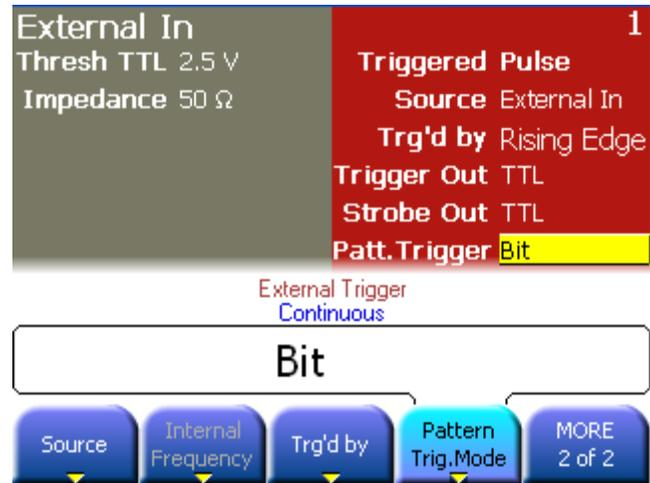

Remote Interface Operation :DIGital[1|2]:TRIGger {BIT|BLOCK}

3.6 Noise

Introduction

Noise is specified by the following parameters:

- Amplitude/Offset or High/Low Level
 - Probability Density Function (PDF)
-

Characteristics

The probability of seeing a specific output level can be defined by the PDF.

- Gaussian distribution with a crest factor of 3.1
- Gaussian distribution with a crest factor of 4.8
- Gaussian distribution with a crest factor of 6.0
- Gaussian distribution with a crest factor of 7.0

User defined distribution by the ARB waveform. In this case the waveform defines how often a level will occur relative to all the others. The more often a specific level appears in the waveform memory, the higher the probability to see it in the generated noise signal.

Restrictions

Noise does not have the following parameters

- Period
- Frequency

Therefore, it has the following restrictions:

- No modulation at all
 - No frequency sweep
 - No burst
-

**Front Panel
Operation**

Press the  key to enable Noise. This brings you to the following screen.



**Front Panel
Operation**

Press the **PDF** softkey and choose from the available noise characteristic options, as shown below.

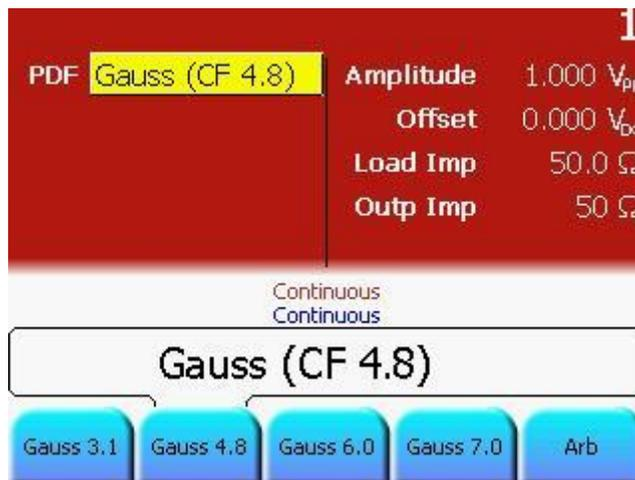

**Remote Interface
Operation**

:FUNCTION[1|2]:NOISE:PDFfunction{PDF1|PDF2|PDF3|PDF4|USER}

3.7 Amplitude Modulation (AM)

Introduction

A modulated waveform consists of:

- Carrier Waveform Shape
- Modulating Waveform Shape

In AM, the amplitude of the carrier is varied by the instantaneous voltage of the modulating waveform. The 81150A / 81160A will accept an internal or external modulation source.

For more information on the fundamentals of Amplitude Modulation, refer to the Tutorial chapter.

AM Characteristics

- The 81150A / 81160A will allow only one modulation mode to be enabled at a time. For example, you cannot enable AM and FM at the same time. When you enable AM, the previous modulation mode is turned off.
 - The 81150A / 81160A will not allow AM to be enabled at the same time that sweep or burst is enabled. When you enable AM, the sweep or burst mode is turned off.
-

Front-Panel Operation

You must enable AM before setting up any of the other modulation parameters. Press  and then select "AM" using the **Modulation Type** softkey. The AM waveform is output using the present settings for the carrier frequency, modulating frequency, output amplitude, and offset voltage.

Remote Interface Operation

To avoid multiple waveform changes, enable AM after you have set up the other modulation parameters.

```
:AM[1|2]:STATe {ON|OFF}
```

3.7.1 Selecting AM Modulation

**Front-Panel
Operation**

The 81150A / 81160A will allow only one modulation mode to be enabled at a time. For example, you cannot enable AM and FM at the same time. When you enable AM, the previous modulation mode is turned off.

AM is enabled by default.

**Remote Interface
Operation**

To avoid multiple waveform changes, enable AM after you have set up the other modulation parameters.

```
:AM[1|2]:STATE {ON|OFF}
```

3.7.2 Carrier Waveform Shape

Introduction	AM carrier shape: Sine, Square, Ramp, or Arbitrary waveform. <i>The default is Sine. You cannot use pulse, noise, or dc as the carrier waveform.</i>
Front-Panel Operation	Press any of the front-panel function keys except  or  . For arbitrary waveforms, press  and then choose the Select Waveform softkey to select the active waveform.
Remote Interface Operation	<code>:FUNCTION[1 2]{SINusoid SQUare RAMP USER}</code> You can also use the APPLy command to select the function, frequency, amplitude, and offset with a single command.

3.7.3 Carrier Frequency

Introduction The maximum carrier frequency depends on the function selected as shown below. The default is 1 MHz for all functions.

Function	Minimum Frequency	Maximum Frequency
Sine	1 μ Hz	81150A: 240 MHz 81160A: 500 MHz
Square	1 μ Hz	81150A: 120 MHz 81160A: 330 MHz
Ramp	1 μ Hz	81150A: 5 MHz 81160A: 20 MHz
Arbs	1 μ Hz	81150A: 120 MHz 81160A: 330 MHz
Pattern	1 μ Hz	81150A: 120 MHz 81160A-330: 330 MHz 81160A-660: 660 MHz 81150A and 81160A: 10 MHz for external patterns

Front-Panel Operation To set the carrier frequency, press the **Frequency** softkey for the selected function. Then use the knob or numeric keypad to enter the desired frequency.

Remote Interface Operation :FREQuency [1|2] {<frequency>|MINimum|MAXimum}
You can also use the APPLy command to select the function, frequency, amplitude, and offset with a single command.

3.7.4 Modulating Waveform Shape

Introduction The 81150A / 81160A will accept modulation from an internal or external modulation source. In case of internal modulation, the modulation signal can be the 'other channel' (2 channel instrument only) or the internal modulation source of the modulated channel.

- Characteristics**
- Modulating waveform shape (*internal source*): Sine, Square, Ramp, Negative Ramp, Triangle, Noise, or Arb waveform. *The default is Sine.*
 - Square has 50% duty cycle 
 - Ramp has 100% symmetry 
 - Triangle has 50% symmetry 
 - Negative ramp has 0% symmetry 
 - You can use noise as the modulating waveshape, but you cannot use noise, pulse, or dc as the carrier waveform.
 - If you select an arbitrary waveform as the modulating waveshape, the waveform is automatically limited to 16K points. Extra waveform points are removed using decimation.

Front-Panel Operation After enabling AM, press the **Shape** softkey.

Remote Interface Operation `:AM[1|2]:INTernal:FUNCTION{SINusoid|SQUare|RAMP|NRAMp|TRIangle|NOISe|USER}`

3.7.5 Modulating Waveform Frequency

Introduction The 81150A / 81160A will accept modulation from an internal or external modulation source. In case of internal modulation, the modulation signal can be the 'other channel' (2 channel instrument only) or the internal modulation source of the modulated channel.

Modulating frequency (internal source):

81150A: 1 mHz to 10 MHz.

81160A: 1 mHz to 50 MHz.

The default is 100 Hz.

Front-Panel Operation After enabling AM, press the **AM Frequency** softkey.

Remote Interface Operation :AM[1|2]:INTernal:FREQuency{<frequency>|MINimum|MAXimum}

3.7.6 Modulating Depth

Introduction

The *modulation depth* is expressed as a percentage and represents the extent of the amplitude variation. At 0% depth, the output amplitude is half of the selected value. At 100% depth, the output amplitude equals the selected value.

Modulation depth: 0% to 120%. *The default is 100%.*



- Even at greater than 100% depth, the 81150A / 81160A will not exceed the specified amplifier's output voltage window or specified output amplitude.
- The modulation depth setting is only used when DSSC is disabled.

Modulating Depth Characteristics

If you select the *External* modulating source, the carrier waveform is modulated with an external waveform. The modulation depth is controlled by the $\pm 2.5\text{V}/\pm 5\text{V}$ signal level present on the rear-panel *Modulation In connector*. For example, if you have set the modulation depth to 100%, then when the modulating signal is at $+2.5\text{V}/+5\text{V}$, the output will be at the maximum amplitude. When the modulating signal is at $-2.5\text{V}/-5\text{V}$, then the output will be at the *minimum* amplitude.



- The 81160A offers a fix $\pm 2.5\text{V}$ input range. The 81150A offers a selectable $\pm 2.5\text{V}$ or $\pm 5\text{V}$ input range.

Front-Panel Operation

After enabling AM, press the **AM Depth** softkey. Then use the knob or numeric keypad to enter the depth.

Remote Interface Operation

```
:AM[1|2]:DEPTh{<depth
in percent>|MINimum|MAXimum}
```

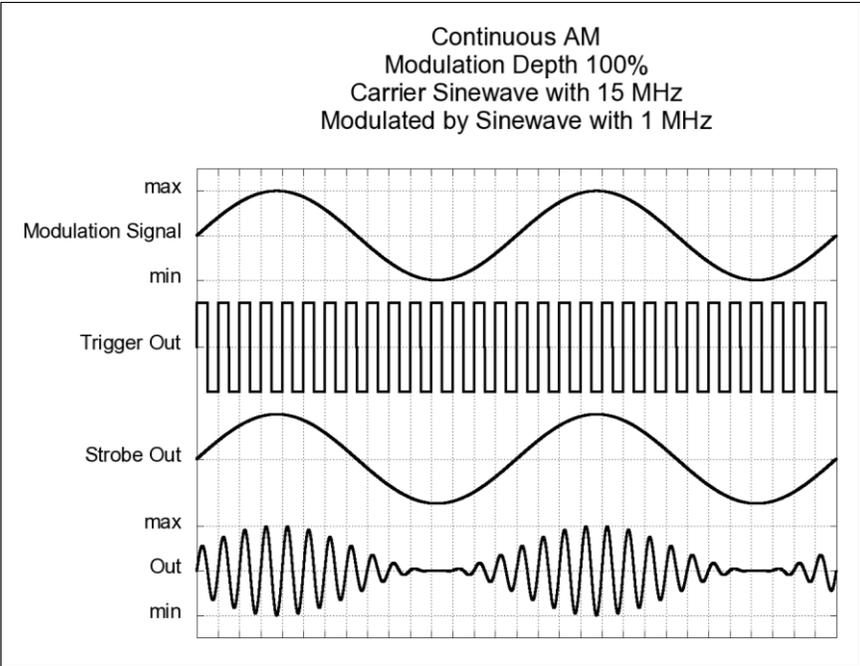
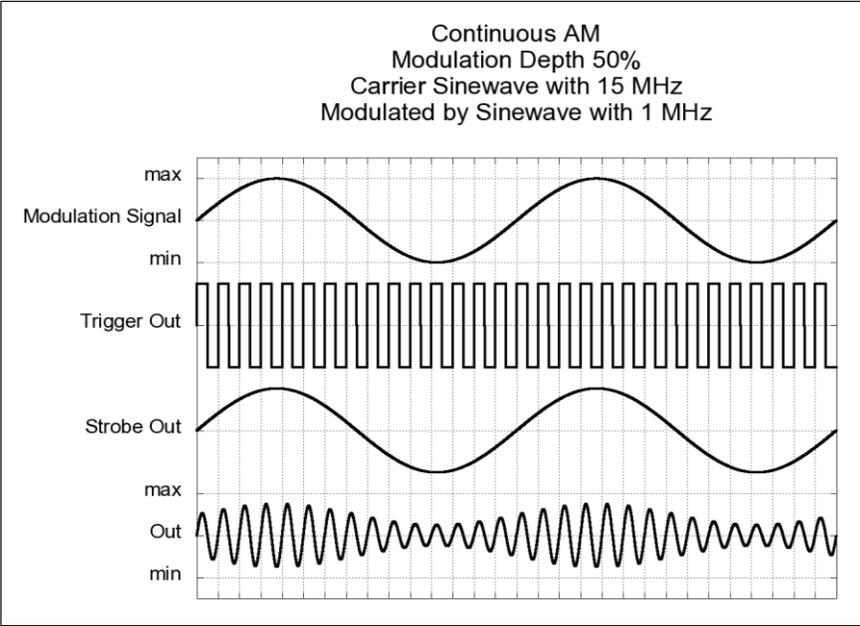

3.7.7 DSSC (Double Sideband Suppressed Carrier Mode)

Introduction If DSSC is enabled, then the carrier will no longer be present in the modulated signal.

Characteristics DSSC is only available if modulation is enabled, modulation type is AM. AM can be performed with or without carrier suppression.

DSSC = OFF

$$u(t) = \frac{1}{2} \cdot \left(1 + \frac{\text{Modulation Depth}}{100\%} \cdot u_{\text{mod}}(t) \right) \cdot u_{\text{carrier}}(t)$$

DSSC = ON

$$u(t) = u_{\text{mod}}(t) \cdot u_{\text{carrier}}(t)$$

Front Panel Operation After enabling AM, press the **DSSC** softkey to enable or disable DSSC.

Remote Interface Operation :AM[1|2]:DSSC {<Boolean>|ON|OFF}

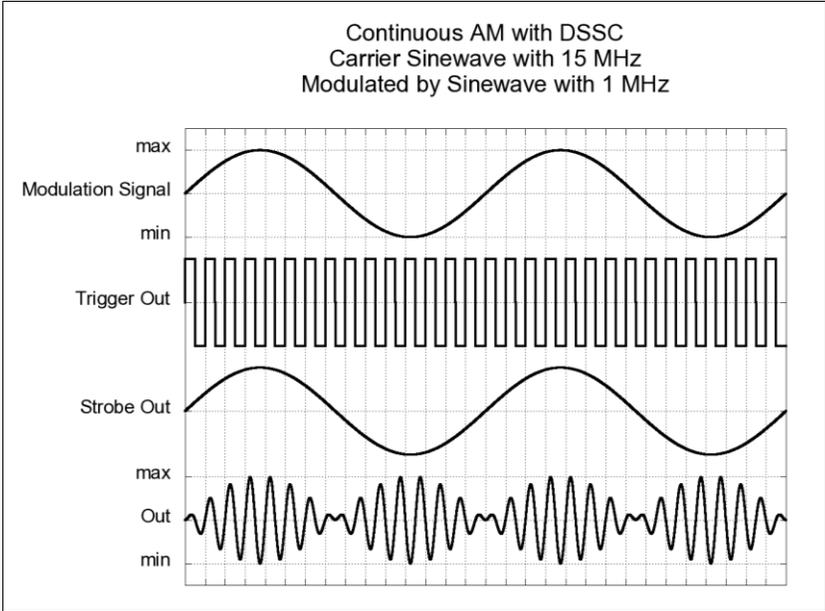

3.7.8 Modulating Source

Introduction The 81150A / 81160A will accept modulation from an internal or external modulation source. In case of internal modulation, the modulation signal can be the 'other channel' (2 channel instrument only) or the internal modulation source of the modulated channel.

Modulating Source If you select the *External* source, the carrier waveform is modulated with an external waveform. The modulation depth is controlled by the $\pm 2.5\text{V}/\pm 5\text{V}$ signal level present on the rear-panel *Modulation In* connector. For example, if you have set the modulation depth to 100%, then when the modulating signal is at $+2.5\text{V}/+5\text{V}$, the output will be at the maximum amplitude. When the modulating signal is at $-2.5\text{V}/-5\text{V}$, then the output will be at the minimum amplitude.



- The 81160A offers a fix $\pm 2.5\text{V}$ input range. The 81150A offers a selectable $\pm 2.5\text{V}$ or $\pm 5\text{V}$ input range.

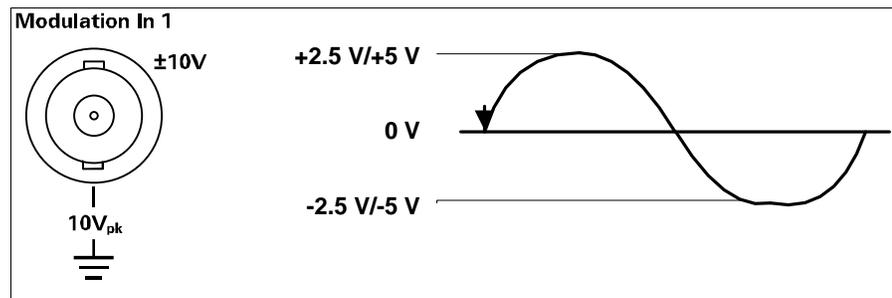

Front-Panel Operation After enabling AM, press the **Source** softkey.

Remote Interface Operation `:AM[1|2]:SOURCE {INTERNAL[1]|INTERNAL2|EXTERNAL}`

3.8 Frequency Modulation (FM)

Introduction

A modulated waveform consists of:

- A Carrier Waveform Shape
- A Modulating Waveform

In FM, the frequency of the carrier is varied by the instantaneous voltage of the modulating waveform.

For more information on the fundamentals of Frequency Modulation, refer to the Tutorial chapter.

FM Characteristics

- The 81150A / 81160A will allow only one modulation mode to be enabled at a time. For example, you cannot enable FM and AM at the same time. When you enable FM, the previous modulation mode is turned off.
 - The 81150A / 81160A will not allow FM to be enabled at the same time that sweep or burst is enabled. When you enable FM, the sweep or burst mode is turned off.
-

3.8.1 Selecting FM Modulation

Front-Panel Operation

You must enable FM before setting up any of the other modulation parameters. Press and then select "FM" using the Modulation Type softkey. The FM waveform is output using the present settings for the carrier frequency, modulating frequency, output amplitude, and offset voltage.

Remote Interface Operation

To avoid multiple waveform changes, enable FM after you have set up the other modulation parameters.

```
:FM[1|2]:STATe {ON|OFF}
```

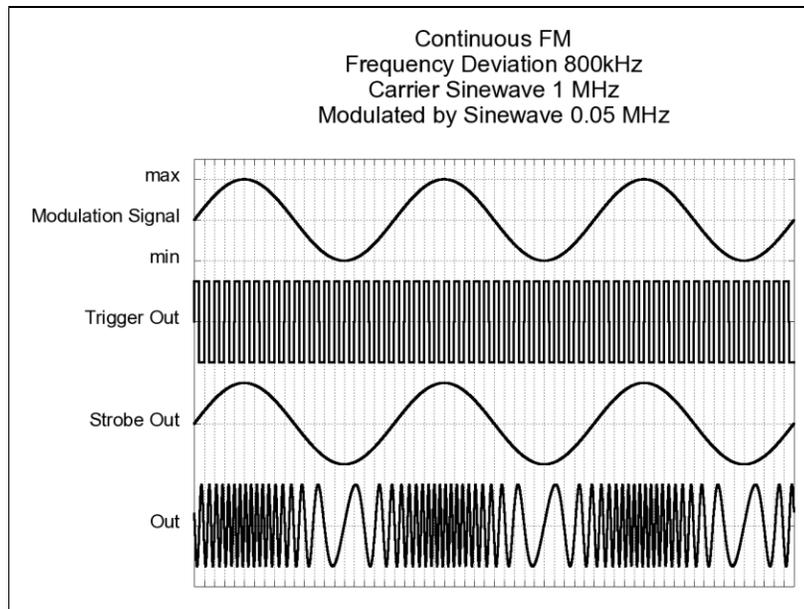

3.8.2 Carrier Waveform Shape

Introduction FM carrier shape: **Sine, Square, Ramp, or Arbitrary** waveform.
The default is Sine. You cannot use pulse, noise, or dc as the carrier waveform.

Front-Panel Operation

Steps:

- Press any of the front-panel function keys except  or .
- For arbitrary waveforms, press  and then choose the **Select Waveform** softkey to select the active waveform.
-

Remote Interface Operation

```
:FUNCTION[1|2]{SINusoid|SQUare|RAMP|USER}
```

You can also use the APPLY command to select the function, frequency, amplitude, and offset with a single command.

3.8.3 Carrier Frequency

Introduction The maximum carrier frequency depends on the function selected as shown below. The default is 1 MHz for all functions.

Function	Minimum Frequency	Maximum Frequency
Sine	1 μ Hz	81150A: 240 MHz 81160A: 500 MHz
Square	1 μ Hz	81150A: 120 MHz 81160A: 330 MHz
Ramp	1 μ Hz	81150A: 5 MHz 81160A: 20 MHz
Arbs	1 μ Hz	81150A: 120 MHz 81160A: 330 MHz
Pattern	1 μ Hz	81150A: 120 MHz 81160A-330: 330 MHz 81160A-660: 660 MHz 81150A and 81160A: 10 MHz for external patterns

Carrier Frequency Characteristics

- The *carrier frequency* must always be greater than or equal to the frequency deviation. If you attempt to set the deviation to a value greater than the carrier frequency (with FM enabled), the 81150A / 81160A will automatically adjust the deviation to the maximum value allowed with the present carrier frequency.
- The sum of the *carrier frequency* and deviation must be less than or equal to the maximum frequency for the selected function plus 100 kHz. If you attempt to set the deviation to a value that is not valid, the 81150A / 81160A will automatically adjust it to the maximum value allowed with the present carrier frequency.

Front-Panel Operation

To set the carrier frequency, press the **Frequency** softkey for the selected function. Then use the knob or numeric keypad to enter the desired frequency.

Remote Interface Operation :FREQuency[1|2] {<frequency>|MINimum|MAXimum}
 You can also use the APPLy command to select the function, frequency, amplitude, and offset with a single command.

3.8.4 Modulating Waveform Shape

Introduction The 81150A / 81160A will accept modulation from an internal or external modulation source. In case of internal modulation, the modulation signal can be the 'other channel' (2 channel instrument only) or the internal modulation source of the modulated channel.

Characteristics

- Modulating waveform shape (*internal source*): Sine, Square, Ramp, Negative Ramp, Triangle, Noise, or Arb waveform. *The default is Sine.*
- Square has 50% duty cycle 
- Ramp has 100% symmetry 
- Triangle has 50% symmetry 
- Negative ramp has 0% symmetry 
- You can use noise as the modulating waveshape, but you cannot use noise, pulse, or dc as the carrier waveform.
- If you select an arbitrary waveform as the modulating waveshape, the waveform is automatically limited to 16K points. Extra waveform points are removed using decimation.

Front-Panel Operation After enabling FM, press the **FM Shape** softkey.

Remote Interface Operation :FM[1|2]:INTernal:FUNctIon{SINusoid|SQUare|RAMP|NRAMP|TRIangle|NOISE|USER}

3.8.5 Modulating Waveform Frequency

Introduction The 81150A / 81160A will accept modulation from an internal or external modulation source. In case of internal modulation, the modulation signal can be the 'other channel' (2 channel instrument only) or the internal modulation source of the modulated channel.

Modulating frequency (internal source):

81150A: 1 mHz to 10 MHz

81160A: 1 mHz to 50 MHz

The default is 10 Hz.

Front-Panel Operation After enabling FM, press the **FM Frequency** softkey.

Remote Interface Operation :FM[1|2]:INTERNAL:FREQUENCY{<frequency>|MINimum|MAXimum}

3.8.6 Peak Frequency Deviation

Introduction The peak frequency deviation represents the variation in frequency of the modulating waveform from the carrier frequency.

Peak frequency deviation Range:

81150A: 1 μ Hz to 120 MHz

81160A: 1 μ Hz to 250 MHz

The default is 100 Hz.

- Characteristics**
- The carrier frequency must always be greater than or equal to the deviation. If you attempt to set the deviation to a value greater than the carrier frequency (with FM enabled), the 81150A / 81160A will limit the deviation to the maximum value allowed with the present carrier frequency.
 - The sum of the carrier frequency and deviation must be less than or equal to the maximum frequency for the selected function plus 100 kHz. If you attempt to set the deviation to a value that is not valid, the 81150A / 81160A will limit it to the maximum value allowed with the present carrier frequency.

Front-Panel Operation After enabling FM, press the **Frequency Deviation** softkey. Then use the knob or numeric keypad to enter the desired deviation.

Remote Interface Operation :FM[1|2]:DEVIation{<peak deviation in Hz>|MINimum|MAXimum}

3.8.7 Modulating Source

Introduction The 81150A / 81160A will accept modulation from an internal or external modulation source. In case of internal modulation, the modulation signal can be the 'other channel' (2 channel instrument only) or the internal modulation source of the modulated channel.

- Modulating Source**
- Internal, External or Channel. The default is **Internal**.
 - If you select the External source, the carrier waveform is modulated with an external waveform. The frequency deviation is controlled by the $\pm 2.5\text{V}/\pm 5\text{V}$ signal level present on the rear-panel Modulation In connector. For example, if you have set the deviation to 100 kHz, then a $+2.5\text{V}/+5\text{V}$ signal level corresponds to a 100 kHz increase in frequency. Lower external signal levels produce less deviation and negative signal levels reduce the frequency below the carrier frequency. Note: the 81160A offers a fix $\pm 2.5\text{V}$ input range. The 81150A offers a selectable $\pm 2.5\text{V}$ or $\pm 5\text{V}$ input range.

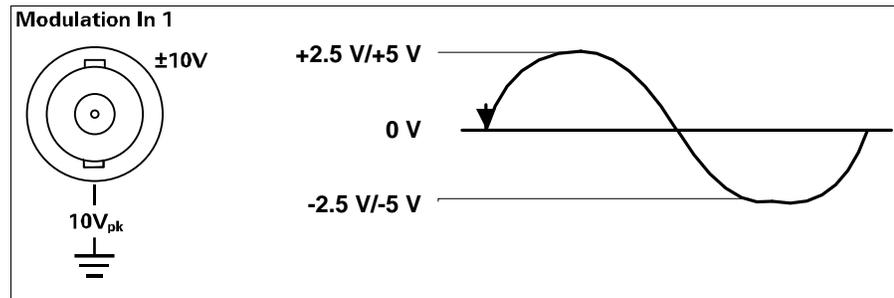

Front-Panel Operation After enabling FM, press the **FM Source** softkey.

Remote Interface Operation `:FM[1|2]:SOURce {INTernal[1]|INTernal2|EXTernal}`

3.9 Phase Modulation (PM)

Introduction

A modulated waveform consists of a *carrier waveform* and a *modulating waveform*. PM is very similar to FM, but in PM the phase of the modulated waveform is varied by the instantaneous voltage of the modulating waveform.

For more information on the fundamentals of Phase Modulation, refer to the Tutorial chapter.

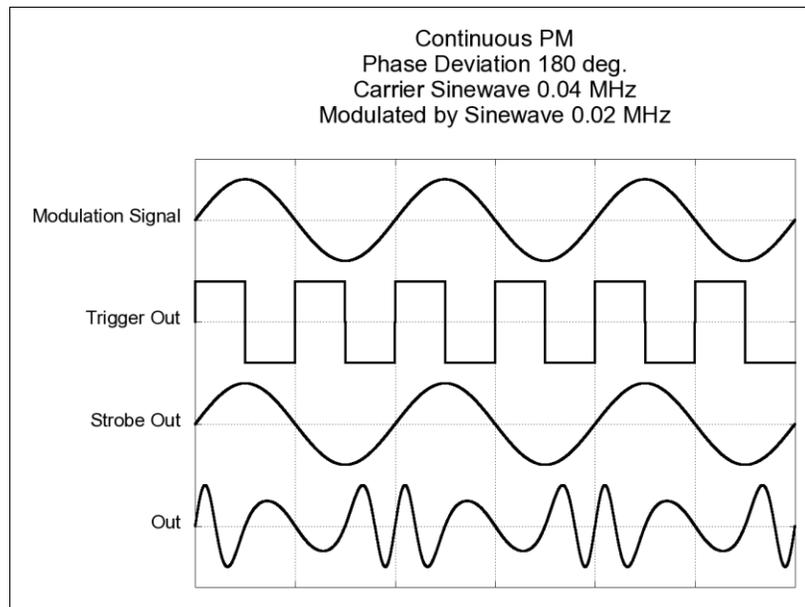

3.9.1 Selecting PM Modulation

Introduction The 81150A / 81160A will allow only one modulation mode to be enabled at a time. For example, you cannot enable PM and AM at the same time. When you enable PM, the previous modulation mode is turned off.

The 81150A / 81160A will not allow PM to be enabled at the same time that sweep or burst is enabled. When you enable PM, the sweep or burst mode is turned off.

Front-Panel Operation You must enable PM before setting up any of the other modulation parameters. Press  and then select "PM" using the **Modulation Type** softkey. The PM waveform is output using the present settings for the carrier frequency, modulating frequency, output amplitude, and offset voltage.

Remote Interface Operation To avoid multiple waveform changes, enable PM after you have set up the other modulation parameters.

```
:PM[1|2]:STATe {OFF|ON}
```

3.9.2 Carrier Waveform Shape

PM carrier shape Sine, Square, Ramp, or Arbitrary waveform.
The default is **Sine**. You cannot use pulse, noise, or dc as the carrier waveform.

Front-Panel Operation

Press any of the front-panel function keys except  or . For arbitrary waveforms, press  and then press **More** key. Press the **Select Waveform** softkey to select the active waveform.

Remote Interface Operation

`:FUNCTION[1|2]{SINusoid|SQUare|RAMP|USER}`
You can also use the **APPLY** command to select the function, frequency, amplitude, and offset with a single command.

3.9.3 Carrier Frequency

Introduction

The maximum carrier frequency depends on the function selected as shown below. *The default is 1 MHz for all functions.*

Function	Minimum Frequency	Maximum Frequency
Sine	1 μ Hz	81150A: 240 MHz 81160A: 500 MHz
Square	1 μ Hz	81150A: 120 MHz 81160A: 330 MHz
Ramp	1 μ Hz	81150A: 5 MHz 81160A: 20 MHz
Arbs	1 μ Hz	81150A: 120 MHz 81160A: 330 MHz
Pattern	1 μ Hz	81150A: 120 MHz 81160A-330: 330 MHz 81160A-660: 660 MHz 81150A and 81160A: 10 MHz for external patterns

Front-Panel Operation

To set the carrier frequency, press the **Frequency** softkey for the selected function. Then use the knob or numeric keypad to enter the desired frequency.

Remote Interface Operation

```
:FREQuency [1 | 2] {<frequency> | MINimum | MAXimum}
```

You can also use the APPLy command to select the function, frequency, amplitude, and offset with a single command.

3.9.4 Modulating Waveform Shape

Introduction The 81150A / 81160A will accept modulation from an internal or external modulation source. In case of internal modulation, the modulation signal can be the 'other channel' (2 channel instrument only) or the internal modulation source of the modulated channel.

-
- Characteristics**
- Modulating waveform shape (internal source): Sine, Square, Ramp, Negative Ramp, Triangle, Noise, or Arb waveform. The default is Sine.
 - Square has 50% duty cycle 
 - Ramp has 100% symmetry 
 - Triangle has 50% symmetry 
 - Negative ramp has 0% symmetry 
 - You can use noise as the modulating waveshape, but you cannot use noise, pulse, or dc as the carrier waveform.
 - If you select an arbitrary waveform as the modulating waveshape, the waveform is automatically limited to 16K points. Extra waveform points are removed using decimation.

Front-Panel Operation After enabling PM, press the **PM Shape** softkey and select the desired shape.

Remote Interface Operation :PM[1|2]:INTernal:FUNCTION{SINusoid|SQUare|RAMP|NRAMP|TRIangle|NOISe|USER}

3.9.5 Modulating Waveform Frequency

Introduction The 81150A / 81160A will accept modulation from an internal or external modulation source. In case of internal modulation, the modulation signal can be the 'other channel' (2 channel instrument only) or the internal modulation source of the modulated channel.

Modulating frequency (internal source):

81150A: 1 mHz to 10 MHz

81160A: 1 mHz to 50 MHz

The default is 10 Hz.

Front-Panel Operation After enabling PM, press the **PM Frequency** softkey. Then use the knob or numeric keypad to enter the desired PM Frequency.

Remote Interface Operation : PM[1 | 2] : INTernal : FREQuency { <frequency> | MINimum | MAXimum }

3.9.7 Modulating Source

Introduction The 81150A / 81160A will accept modulation from an internal or external modulation source. In case of internal modulation, the modulation signal can be the 'other channel' (2 channel instrument only) or the internal modulation source of the modulated channel.

Modulating Source Internal or External. *The default is Internal.*
If you select the *External* source, the carrier waveform is modulated with an external waveform. The phase deviation is controlled by the $\pm 2.5\text{V}/\pm 5\text{V}$ signal level present on the rear-panel *Modulation In* connector. For example, if you have set the deviation to 180 degrees, then a $+2.5\text{V}/\pm 5\text{V}$ signal level corresponds to a 180 degree phase shift. Lower external signal levels produce less deviation.



- The 81160A offers a fix $\pm 2.5\text{V}$ input range. The 81150A offers a selectable $\pm 2.5\text{V}$ or $\pm 5\text{V}$ input range.

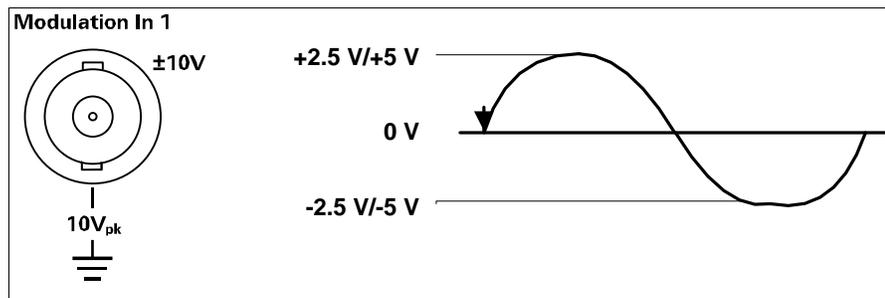

Front Panel Operation

Press  and then press **Modulation Type** softkey to enable PM. After enabling PM, press the **PM Source** softkey and select from Internal, Channel, or External.

Remote Interface Operation `:PM[1|2]:SOURCE {INTERNAL[1]|INTERNAL2|EXTERNAL}`

3.10 Frequency-Shift Keying (FSK) Modulation

Introduction

You can configure the 81150A / 81160A to “shift” its output frequency between two preset values using FSK modulation. The rate at which the output shifts between the two frequencies (called the “carrier frequency” and the “hop frequency”) is determined by the internal rate generator or the signal level on the rear panel *Modulation-In* connector, or the signal being generated on the ‘other’ channel (2 channel instrument only).

For more information on the fundamentals of FSK Modulation, refer to the Tutorial chapter.



- FSK is not available in pattern mode.

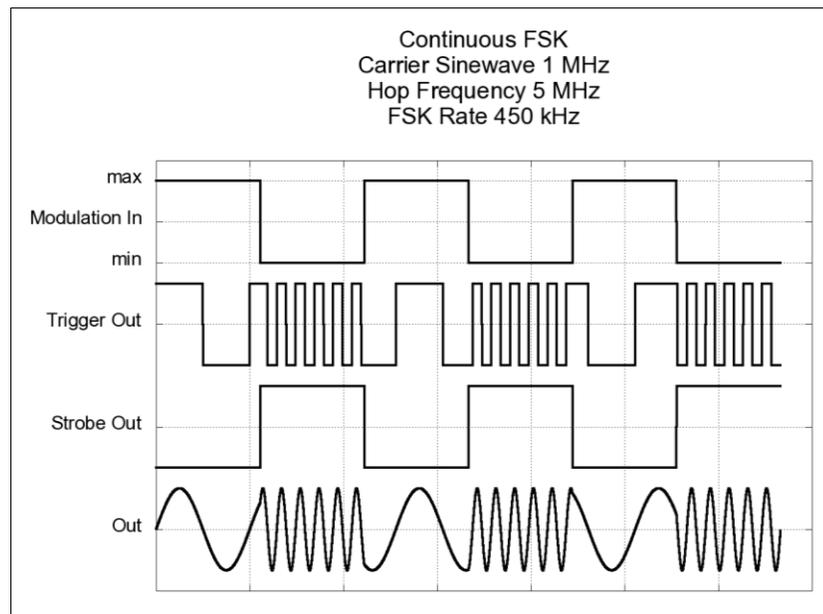

3.10.1 Selecting FSK Modulation

Introduction

The 81150A / 81160A will allow only one modulation mode to be enabled at a time. For example, you cannot enable FSK and AM at the same time. When you enable FSK, the previous modulation mode is turned off.

The 81150A / 81160A will not allow FSK to be enabled at the same time that sweep or burst is enabled. When you enable FSK, the sweep or burst mode is turned off.

Front-Panel Operation

You must enable FSK before setting up any of the other modulation parameters. Press  and then press the **Modulation Type** softkey to select FSK. The FSK waveform is output using the present settings for the carrier frequency, output amplitude, and offset voltage.

Remote Interface Operation

To avoid multiple waveform changes, enable FSK after you have set up the other modulation parameters.

```
:FSKey[1|2]:STATE {ON|OFF}
```

3.10.2 Carrier Waveform Shape

Introduction FSK carrier shape: **Sine, Square, Ramp, or Arbitrary** waveform.
The default is Sine. You cannot use pulse, noise, or dc as the carrier waveform.

Front-Panel Operation

Steps:

- Press any of the front-panel function keys except  or .

For arbitrary waveforms, press  and then press **More** key.
 Press the **Select Waveform** softkey to select the active waveform.

Remote Interface Operation

```
:FUNCTION[1|2] {SINusoid|SQUare|RAMP|USER}
```

You can also use the **APPLY** command to select the function, frequency, amplitude, and offset with a single command.

3.10.3 FSK Carrier Frequency

Introduction The maximum carrier frequency depends on the function selected as shown below. The default is 1 MHz for all functions.

Function	Minimum Frequency	Maximum Frequency
Sine	1 μ Hz	81150A: 240 MHz 81160A: 500 MHz
Square	1 μ Hz	81150A: 120 MHz 81160A: 330 MHz
Ramp	1 μ Hz	81150A: 5 MHz 81160A: 20 MHz
Arbs	1 μ Hz	81150A: 120 MHz 81160A: 330 MHz

FSK Carrier Frequency Characteristics When the **External** source is selected, the output frequency is determined by the signal level on the *Modulation In* connector. When a logic low level is present, the carrier frequency is output. When a logic high level is present, the hop frequency is output.

Front-Panel Operation To set the carrier frequency, press the **Frequency** softkey for the selected function. Then use the knob or numeric keypad to enter the desired frequency.

Remote Interface Operation :FREQuency[1|2] {<frequency>|MINimum|MAXimum}
You can also use the APPLY command to select the function, frequency, amplitude, and offset with a single command.

3.10.4 FSK “Hop” Frequency

Introduction

The maximum alternate (or “hop”) frequency depends on the function selected as shown below. The default is 100 Hz for all functions.

Function	Minimum Frequency	Maximum Frequency
Sine	1 μ Hz	81150A: 240 MHz 81160A: 500 MHz
Square	1 μ Hz	81150A: 120 MHz 81160A: 330 MHz
Ramp	1 μ Hz	81150A: 5 MHz 81160A: 20 MHz
Arbs	1 μ Hz	81150A: 120 MHz 81160A: 330 MHz

FSK “Hop” Frequency Characteristics

- The internal modulating waveform is a square wave with a 50% duty cycle.
- When the External source is selected, the output frequency is determined by the signal level on the Modulation In connector. When a logic low level is present, the carrier frequency is output. When a logic high level is present, the hop frequency is output.
- When “other” channel is selected as a modulation source, then a DAC value below 0 will output the carrier frequency, a DAC value ≥ 0 will output the hop frequency.

Front-Panel Operation

To set the “hop” frequency, do the following:

- Press  and then press the **Modulation Type** softkey to select FSK.
- Press the **Hop Frequency** softkey. Then use the knob or numeric keypad to enter the desired frequency.

Remote Interface Operation :FSKey[1|2]:FREQuency{<frequency>|MINimum|MAXimum}

You can also use the APPLY command to select the function, frequency, amplitude, and offset with a single command.

3.10.5 FSK Rate

Introduction The FSK rate is the rate at which the output frequency “shifts” between the carrier frequency and the hop frequency when you select the internal FSK source.

- FSK “Hop” Frequency Characteristics**
- FSK rate (internal source):
 - 81150A:** 1 mHz to 10 MHz.
 - 81160A:** 1 mHz to 50 MHz.
 The default is 10 Hz.
 - The FSK rate is ignored when the external FSK source or other channel source is selected.
-

- Front-Panel Operation** To set the FSK rate, do the following:
- Press  and then press the **Modulation Type** softkey to select FSK.
 - Press the **FSK Rate** softkey. Then use the knob or numeric keypad to enter the desired frequency.
-

Remote Interface Operation :FSKey[1|2]:INTernal:RATE {<rate in Hz>|MINimum|MAXimum}

3.10.6 FSK Source

- Introduction**
- FSK source can be Internal, External, or other channel. The default is **Internal**.
 - When the Internal source is selected, the rate at which the output frequency “shifts” between the carrier frequency and hop frequency is determined by the FSK rate specified.
 - When the External source is selected, the output frequency is determined by the signal level on the Modulation In connector. When a logic low level is present, the carrier frequency is output. When a logic high level is present, the hop frequency is output.
 - The maximum external FSK rate is 10 MHz.
 - When “other” channel is selected, then a DAC value below 0 will output the carrier frequency, a DAC value ≥ 0 will output the hop frequency.

Front-Panel Operation After enabling FSK, press the **FSK Source** softkey and select from Internal, Channel, or External.

Remote Interface Operation `:FSKey[1|2]:SOURCE{INTernal[1]|INTernal2|EXTernal}`

3.11 Pulse Width Modulation (PWM)

Introduction

In Pulse Width Modulation (PWM), the width of a pulse waveform is varied by the instantaneous voltage of the modulating waveform. The width of the pulse can be expressed either as a pulse width (expressed in time units, like the period) or a duty cycle (expressed as a percentage of the period).

The 81150A / 81160A will accept modulation from an internal or external modulation source. In case of internal modulation, the modulation signal can be the 'other channel' (2 channel instrument only) or the internal modulation source of the modulated channel.

For more information on the fundamentals of Pulse Width Modulation, refer the Tutorial chapter.



- PWM is not available in pattern mode.

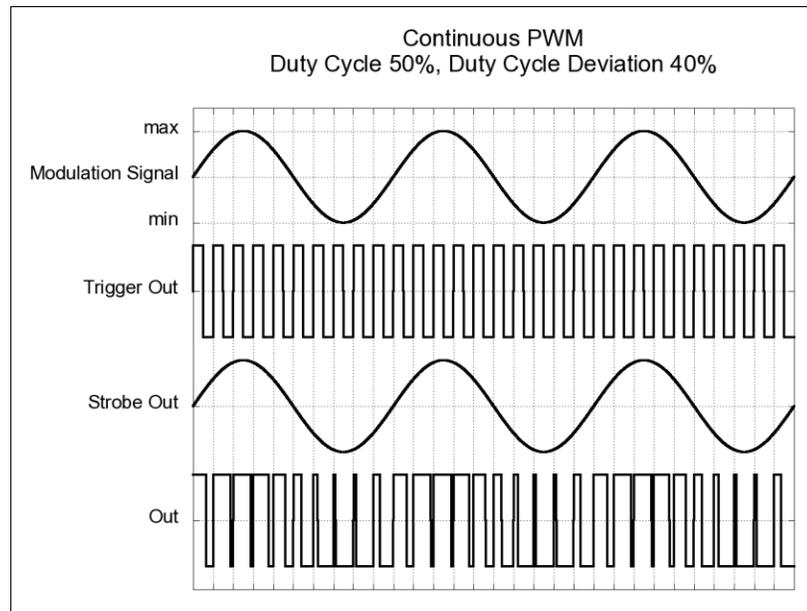

3.11.1 Selecting PWM Modulation

Introduction The 81150A / 81160A only allows PWM to be selected for a pulse waveform, and PWM is the only modulation type supported for pulse.

The 81150A / 81160A will not allow PWM to be enabled at the same time that sweep or burst is enabled.

Front-Panel Operation

You must enable PWM before setting up any of the other modulation parameters.

Press  to select pulse, and then press  to turn on modulation. PWM is selected as the only modulation type supported for pulse. The PWM waveform is output using the present settings for the pulse frequency, modulating frequency, output amplitude, offset voltage, pulse width, and edge times.

Remote Interface Operation

To avoid multiple waveform changes, enable PWM after you have set up the other modulation parameters.

```
:PWM[1|2]:STATE {ON|OFF}
```

3.11.2 Pulse Waveform

Introduction Pulse is the only waveform shape supported for PWM.

Front-Panel Operation Press  to select pulse.

Remote Interface Operation :FUNCTION {PULSe}
You can also use the APPLY command to select the function, frequency, amplitude, and offset with a single command.

3.11.3 Pulse Period

Introduction **81150A:** The range for the pulse period is 8.33 ns to 1000000s. The default is 1 μ s. Pulse frequency limits: 1 μ Hz to 120 MHz.

81160A: The range for the pulse period is 3.03 ns to 1000000s. The default is 1 μ s. Pulse frequency limits: 1 μ Hz to 330 MHz.

Front-Panel Operation After selecting the pulse function, press the **Frequency** softkey again to toggle to the **Period** softkey. Then use the knob or numeric keypad to enter the desired pulse period.

Remote Interface Operation :PULSe:PERiod {<seconds>|MINimum|MAXimum}

3.11.4 Modulating Waveform Shape

Introduction The 81150A / 81160A will accept modulation from an internal or external modulation source. In case of internal modulation, the modulation signal can be the 'other channel' (2 channel instrument only) or the internal modulation source of the modulated channel.

- Characteristics**
- Modulating waveform shape (internal source): Sine, Square, Ramp, Negative Ramp, Triangle, Noise, or Arb waveform. The default is Sine.
 - Square has 50% duty cycle 
 - Ramp has 100% symmetry 
 - Triangle has 50% symmetry 
 - Negative ramp has 0% symmetry 
 - If you select an arbitrary waveform as the modulating waveshape, the waveform is automatically limited to 16K points. Extra waveform points are removed using decimation.
-

Front-Panel Operation After enabling PWM, press the **More key**. Then, press the **PM Shape** softkey and select the desired shape.

Remote Interface Operation `:PWM[1|2]:INTernal:FUNCTION {SINusoid|SQUare|RAMP|NRAMP|TRIangle|NOISe|USER}`

3.11.5 Modulating Waveform Frequency

Introduction The 81150A / 81160A will accept modulation from an internal or external modulation source. In case of internal modulation, the modulation signal can be the 'other channel' (2 channel instrument only) or the internal modulation source of the modulated channel.

Modulating frequency (internal source):

81150A: 1mHz to 10 MHz

81160A: 1mHz to 50 MHz

The default is 10 Hz.

Front-Panel Operation After enabling PWM, press the **PWM Frequency** softkey. Then use the knob or numeric keypad to enter the desired PWM Frequency.

Remote Interface Operation : PWM[1|2]:INTernal:FREQuency {<frequency>|MINimum|MAXimum }

3.11.6 Width Deviation

Introduction The width deviation represents the variation in width (in seconds) in the modulated waveform from the width of the original pulse waveform.

- Characteristics**
- Width deviation: 0 s to 1000 s (see below). The default is 500ps.
 - The width deviation cannot exceed the current pulse width.
 - The width deviation is also limited by the minimum pulse width (Wmin):

$$\text{Width Deviation} \leq \text{Pulse Width} - W_{\text{min}}$$
 and

$$\text{Width Deviation} \leq \text{Period} - \text{Pulse Width} - W_{\text{min}}$$
81150A: Where Wmin is either 4.1 ns or 10 ns depending on the selected amplifier (See section Amplifier Type Selection).
81160A: Where Wmin is 1.5 ns.
 - The width deviation is limited by the current edge time setting.

$$\text{Width Dev} \leq \text{Pulse Width} - (0.8 \text{ Lead Edge Time} + 0.8 \text{ Trail Edge Time})$$
 and

$$\text{Width Dev} \leq \text{Period} - \text{Pulse Width} - (0.8 \text{ Lead Edge Time} + 0.8 \text{ Trail Edge Time})$$
-

Front-Panel Operation After enabling PWM, press the **Width Deviation** softkey. Then use the knob or numeric keypad to enter the desired deviation.

Remote Interface Operation :PWM[1|2]:DEVIation{<deviation in seconds>| MINimum|MAXimum}



The pulse width and width deviation, and the pulse duty cycle and duty cycle deviation are coupled in the front panel interface. If you select Width for the pulse waveform and enable PWM, the **Width Deviation** softkey is available. On the other hand, if you select Dty Cyc for the pulse waveform and enable PWM, the **Dty Cyc Deviation** softkey is available.

3.11.7 Duty Cycle Deviation

Introduction The duty cycle deviation represents the variation in duty cycle of the modulated waveform from the duty cycle of the pulse waveform. The duty cycle deviation is expressed as a percentage of the period.

-
- Characteristics**
- Duty cycle deviation: 0 to 100% (see below). The default is 50m%.
 - The duty cycle deviation cannot exceed the current pulse duty cycle.
 - The duty cycle deviation is also limited by the minimum pulse width (W_{min}):

$$\text{Duty Cycle Deviation} \leq \text{Duty Cycle} - 100 \times W_{min} \div \text{Period}$$
 and

$$\text{Duty Cycle Deviation} \leq 100 - \text{Duty Cycle} - 100 \times W_{min} \div \text{Period}$$
81150A: Where W_{min} is either 4.1 ns or 10 ns depending on the selected amplifier (See section Amplifier Type Selection).
81160A: Where W_{min} is 1.5 ns.
 - The duty cycle deviation is also limited by the current edge time setting.

$$\text{Duty Cycle Dev} \leq \text{Duty Cycle} - (80 \times (\text{Lead Edge Time} + \text{Trail Edge Time})) \div \text{Period}$$
 and

$$\text{Duty Cycle Dev} \leq 100 - \text{Duty Cycle} - (80 \times (\text{Lead Edge Time} + \text{Trail Edge Time})) \div \text{Period}$$
-

**Front-Panel
Operation**

After enabling PWM, press the **Dty Cyc Deviation** softkey. Then use the knob or numeric keypad to enter the desired deviation.

- Go to the Pulse Screen, press the **Width** softkey and switch to Duty Cycle.
- Press the **Modulation Key**. Instead of “Width Deviation” the softkey will be labeled “Dty Cyc Deviation” and the value to be entered will be in % instead of seconds.
- The width representation can be changed directly on the PWM screen by pressing the Width Deviation or Dty Cyc Deviation softkey. (shown in the figure below)

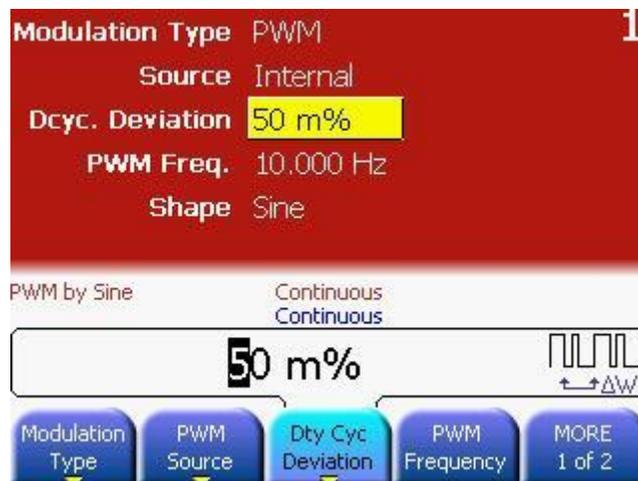

Remote Interface Operation :PWM[1|2]:DEVIation:DCYCLE{<deviation
in percent>|MINimum|MAXimum}



The pulse width and width deviation, and the pulse duty cycle and duty cycle deviation are coupled in the front panel interface. If you select **Width** for the pulse waveform and enable *PWM*, the **Width Deviation** softkey is available. On the other hand, if you select **Duty Cycle** for the pulse waveform and enable *PWM*, the **Dty Cyc Deviation** softkey is available.

3.11.8 Modulating Source

Introduction The 81150A / 81160A will accept modulation from an internal or external modulation source. In case of internal modulation, the modulation signal can be the 'other channel' (2 channel instrument only) or the internal modulation source of the modulated channel.

- Modulating Source**
- Internal, External or other channel. The default is **Internal**.
 - If you select the External source, the pulse waveform is modulated with an external waveform. The width deviation or duty cycle deviation is controlled by the $\pm 2.5\text{V}/\pm 5\text{V}$ signal level present on the rear-panel Modulation In connector. For example, if you have set the duty cycle to 10% and the duty cycle deviation to 5%, then, when the modulating signal is at $+2.5\text{V}/+5\text{V}$, the output will be at the maximum duty cycle (15%). When the modulating signal is at $-2.5\text{V}/-5\text{V}$, the output will be at the minimum duty cycle (5%).
 - The 81160A offers a fix $\pm 2.5\text{V}$ input range. The 81150A offers a selectable $\pm 2.5\text{V}$ or $\pm 5\text{V}$ input range.

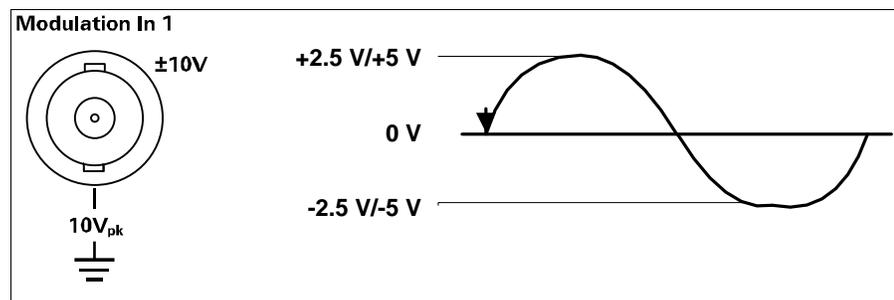

Front-Panel Operation After enabling PWM, press the **PWM source** softkey and select from Internal, Channel, or External.

Remote Interface Operation `:PWM[1|2]:SOURce {INTernal[1]|INTernal2|EXTernal}`

3.12 Frequency Sweep

Introduction

In the frequency sweep mode, the 81150A / 81160A “steps” from the *start frequency* to the *stop frequency* at a *sweep rate* which you specify. You can sweep up or down in frequency, and with either linear or logarithmic spacing. You can also configure the 81150A / 81160A to output a single sweep (one pass from start frequency to stop frequency) by applying an external or manual trigger. The 81150A / 81160A can produce a frequency sweep for sine, square, ramp, or arbitrary waveforms (pulse, noise, and dc are not allowed).

For more information on the fundamentals of a sweep, refer to the Tutorial chapter.

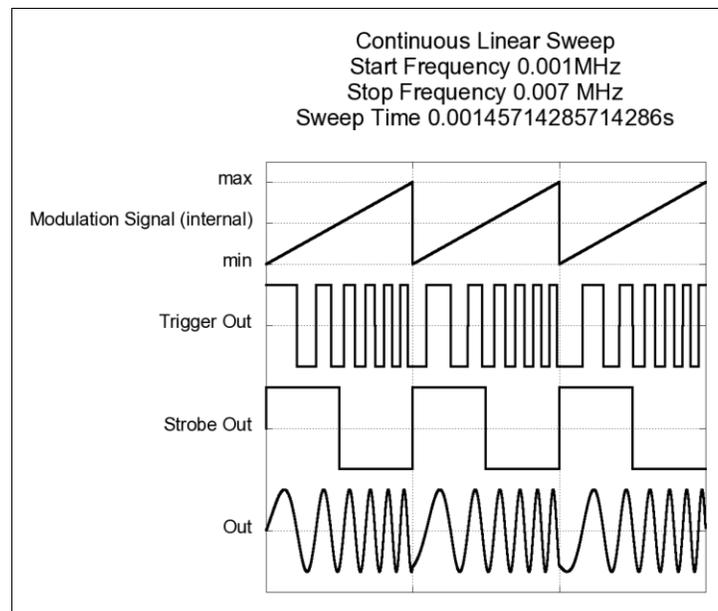

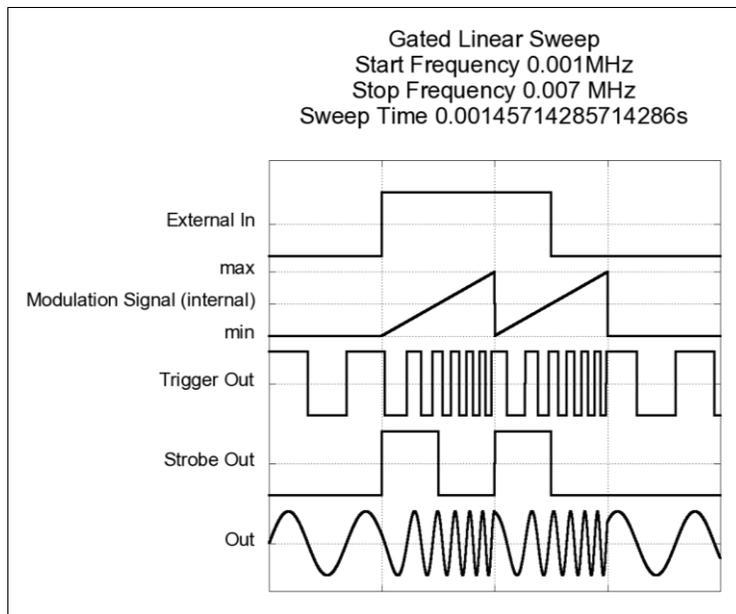
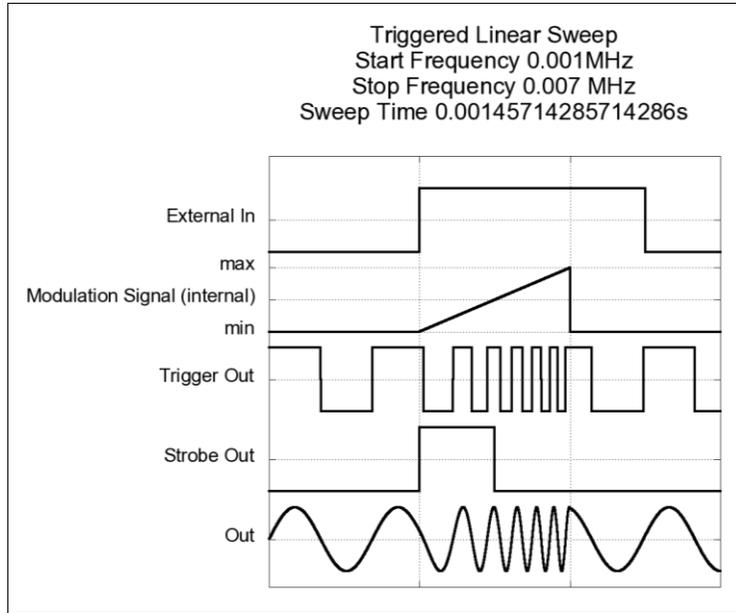

3.12.1 Selecting a Sweep

Introduction The 81150A / 81160A will not allow the sweep mode to be enabled at the same time that burst or any modulation mode is enabled. When you enable sweep, the burst or modulation mode is turned off.

Front-Panel Operation You must enable sweep before setting up any of the other sweep parameters. Press  to output a sweep using the present settings for frequency, output amplitude, and offset.

Remote Interface Operation To avoid multiple waveform changes, enable the sweep mode after you have set up the other modulation parameters.
`:SWEep[1|2]:STATE {ON|OFF}`

3.12.2 Start Frequency and Stop Frequency

Introduction	The <i>start frequency</i> and <i>stop frequency</i> set the upper and lower frequency bounds for the sweep. The 81150A / 81160A begins at the start frequency, sweeps to the stop frequency, and then resets back to the start frequency
<hr/>	
Characteristics	<ul style="list-style-type: none"> • Start and Stop frequencies: 81150A: 1 μHz to 240 MHz. 81160A: 1 μHz to 500 MHz. The sweep is phase continuous over the full frequency range. <i>The default start frequency is 100 Hz. The default stop frequency is 1 kHz.</i> • To sweep up in frequency, set the start frequency < stop frequency. • To sweep down in frequency, set the start frequency > stop frequency. • For sweeps with <i>Marker Off</i>, the Strobe Out signal is a square waveform with a 50% duty cycle. The Strobe Out signal is a “high” at the beginning of the sweep and goes “low” at the midpoint of the sweep. The frequency of the Strobe Out waveform is equal to the specified sweep time. The signal is output from the front-panel Strobe Out connector. • For sweeps with <i>Marker On</i>, the Strobe Out signal is a “high” at the beginning of the sweep and goes “low” at the marker frequency. The signal is output from the front-panel Strobe Out connector. • Voltage level at Strobe Out can be configured at TTL, ECL or $\pm 2V$ levels. • Start and Stop Frequency are limited by the output function and amplifier type.
<hr/>	
Front-Panel Operation	After enabling sweeps, press the Start Frequency or Stop Frequency softkey. Then use the knob or numeric keypad to enter the desired frequency.
<hr/>	
Remote Interface Operation	<pre>:FREQuency [1 2] : START {<frequency> MINimum MAXimum} :FREQuency [1 2] : STOP {<frequency> MINimum MAXimum}</pre>
<hr/>	

3.12.3 Center Frequency and Frequency Span

Introduction If desired, you can set the frequency boundaries of the sweep using a *center frequency* and *frequency span*. These parameters are similar to the start frequency and stop frequency (see the previous page) and are included to give you added flexibility.

- Characteristics**
- **81150A:** Center frequency: 1 μ Hz to 240 MHz. *The default is 550 Hz.*
 - **81160A:** Center frequency: 1 μ Hz to 500 MHz. *The default is 550 Hz.*
 - **81150A:** Frequency span: 0 Hz to 240 MHz. *The default is 900 Hz.*
 - **81160A:** Frequency span: 0 Hz to 500 MHz. *The default is 900 Hz.*
 - To sweep **up** in frequency, set a *positive* frequency span.
 - To sweep **down** in frequency, set a *negative* frequency span.
 - For sweeps with *Marker Off*, the Strobe Out signal is a square waveform with a 50% duty cycle. The Strobe Out signal is a TTL “high” at the beginning of the sweep and goes “low” at the midpoint of the sweep. The frequency of the Strobe Out waveform is equal to the specified sweep time. The signal is output from the front-panel Strobe Out connector.
 - For sweeps with *Marker On*, the Strobe Out signal is a TTL “high” at the beginning of the sweep and goes “low” at the marker frequency. The signal is output from the front-panel Strobe Out connector.
 - Voltage level at Strobe Out can be configured at TTL, ECL or $\pm 2V$ levels.
 - Start and Stop Frequency are limited by the output function and amplifier type.
 - Center Frequency and Frequency Span are limited by the output function and amplifier range.
-

**Front-Panel
Operation**



After enabling , press the **Start Frequency** or **Stop Frequency** softkey again to toggle to the **Center Freq** or **Freq Span** softkey. Then use the knob or numeric keypad to enter the desired values.

**Remote Interface
Operation**

```
:FREQuency[1|2]:CENTer{<frequency>|MINimum|  
MAXimum}  
:FREQuency[1|2]:SPAN {<frequency>|MINimum|MAXimum}
```

3.12.4 Idle Frequency

Introduction Whenever the instrument is waiting for an active trigger edge or an active gate signal, it outputs the idle frequency. The idle frequency can be set to Start Frequency, Stop Frequency or DC (0 Hz).

Front-Panel Operation

Press the  or  key to enable either Triggered or Gated mode.

Then press the  key to reach the sweep screen.

Press the **Idle Frequency** softkey or use the navigation keys to select Idle frequency.

Press the **Idle Frequency** softkey again or use the rotary knob to select from Start Frequency, Stop Frequency, or 0 Hz (DC).

Remote Interface Operation :SWEep[1|2]:IDLE {SFrequency|EFrequency|DC}

3.12.5 Sweep Type

Introduction

You can sweep with either linear or logarithmic spacing. *The default is Linear.*

For a *linear* sweep, the 81150A / 81160A varies the output frequency in a linear fashion during the sweep.

For a *logarithmic* sweep, the 81150A / 81160A varies the output frequency in a logarithmic fashion.

Front-Panel Operation

After enabling , press the **Sweep Type** softkey again to toggle between the Linear or Logarithmic mode.

Remote Interface Operation

:SWEep[1|2]:SPACing {LINear|LOGarithmic}

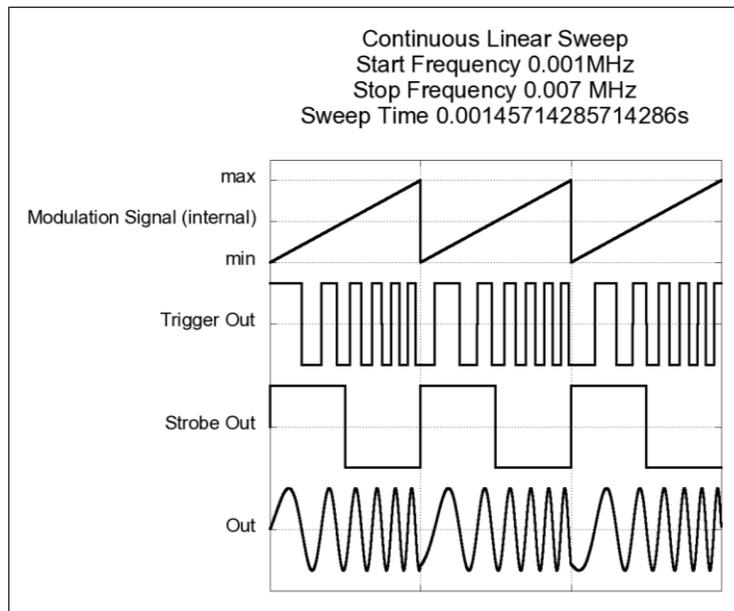

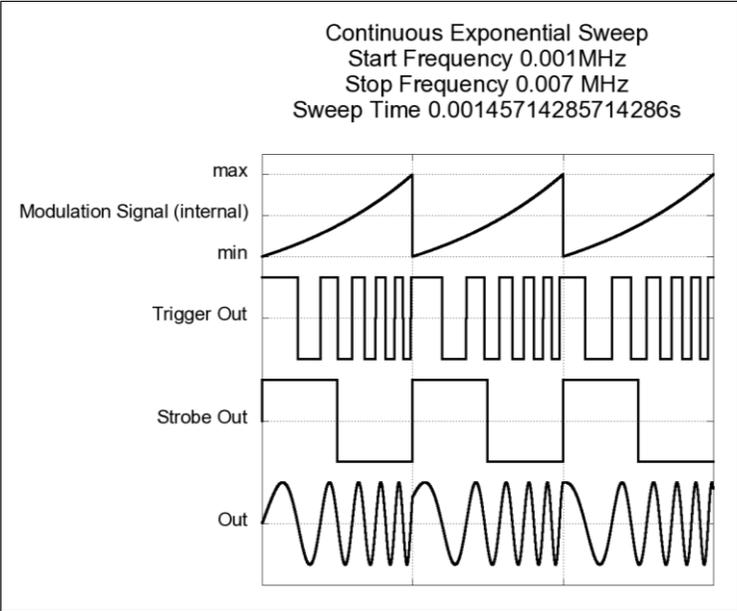

3.12.6 Sweep Time

Introduction The *sweep time* specifies the number of seconds required to sweep from the start frequency to the stop frequency. The number of discrete frequency points in the sweep is automatically calculated by the 81150A / 81160A and is based on the sweep time you select.

Sweep time:

81150A: 100 μ s to 500 seconds.

81160A: 50 μ s to 500 seconds.

The default is 1 second.

**Front-Panel
Operation**

After enabling , press the **Sweep Time** softkey. Then use the knob or numeric keypad to enter the desired sweep time.

**Remote Interface
Operation**

:SWEep[1|2]:TIME {<seconds>|MINimum|MAXimum}

3.12.7 Marker Frequency

Introduction If desired, you can set the frequency at which the signal on the front panel Strobe Out connector goes to a logic low during the sweep. The Strobe Out signal always goes from low to high at the beginning of the sweep.

- Characteristics**
- Marker frequency:
81150A: 1 μ Hz to 240 MHz.
81160A: 1 μ Hz to 500 MHz.
The default is 500 Hz.
 - When the sweep mode is enabled, the marker frequency must be between the specified start frequency and stop frequency. If you attempt to set the marker frequency to a frequency not in this range, the 81150A / 81160A will automatically set the marker frequency equal to the start frequency or stop frequency (whichever is closer).
-

Front-Panel Operation

After enabling , press the **Frequency Marker** softkey. Press the **Frequency Marker** softkey again to enable/disable the Frequency Marker. Alternatively, you can also use the rotary knob to switch it On and Off. Press the **Marker Frequency** softkey or use the navigation keys to select the Marker Frequency. Then use the knob or numeric keypad to enter the desired value.

Remote Interface Operation

Use the following command to set the Marker Frequency:
`:MARKer [1 | 2] :FREQuency {<frequency> | MINimum | MAXimum}`

Use the following command to turn the Frequency Marker on and off:
`:MARKer [1 | 2] [:STATe] { OFF | ON }`

3.12.8 Triggered/Gated Sweep

Introduction

In the triggered mode, the 81150A / 81160A outputs a single sweep when a trigger signal is received. After one sweep from the start frequency to the stop frequency, the 81150A / 81160A waits for the next trigger while outputting the idle frequency.

In gated Sweep mode, the 81150A / 81160A outputs sweep as long as the gate signal is active. If the gate signal changes to inactive, the sweep will be finished. While waiting for an active gate signal, the 81150A / 81160A will output the idle frequency.

Characteristics

- Available sources for Trigger are: **Internal**, **External**, and **Manual**.
- Available sources for Gated are: **External** and **Manual**.
- When the *Internal* (immediate or Internal 1) source is selected, the 81150A / 81160A outputs a continuous sweep at a rate determined by the *sweep time* specified.
- When the *External* source is selected, the 81150A / 81160A will accept a hardware trigger applied to the Front-panel External In connector.
- The 81150A / 81160A initiates one sweep each time *External In* receives a pulse with the specified polarity.
- The trigger period must be greater than or equal to the specified sweep time **plus 1 ms**.
- When the *Manual* source is selected, the 81150A / 81160A outputs one sweep each time the front-panel  key is pressed.

Front-Panel Operation

Press the  key to enable triggered operation, the  key for gated operation, and the  key for continuous operation. Configure Trigger Source, Frequency, and active edge/level on the Mode/Trigger Screen as required.

**Remote Interface
Operation**

Use the following command to specify whether the 81150A / 81160A triggers on the rising or falling edge of the signal on the External In connector.

```
:ARM:SOURce{IMMediate|INTernal[1]|INTernal[2]|  
  EXTernal|MANual}  
:ARM:FREQuency[1|2] {<frequency>|MAXimum|MINimum}  
:ARM:SENSe[1|2] {EDGE|LEVel}  
:ARM:PERiod[1|2] {<seconds>|MAXimum|MINimum}  
:ARM:SLOPe {POSitive|NEGative|EITHer}
```

For more information, refer to the **Triggering Commands** section.

3.13 Burst Mode

Introduction

You can configure the 81150A / 81160A to output a waveform with a specified number of cycles, called a burst. The 81150A / 81160A can produce a burst using sine, square, ramp, pulse, or arbitrary waveforms (noise and dc is not allowed).

For more information on the fundamentals of the burst mode, refer to the Tutorial chapter.

3.13.1 Selecting a Burst

Introduction The 81150A / 81160A will not allow the burst to be enabled at the same time that sweep or any modulation mode is enabled.
When you enable burst, the sweep or modulation mode is turned off.

Front-Panel Operation You must enable burst *before* setting up any of the other burst parameters.
Press  to output a burst using the present settings for frequency, output amplitude, and offset.

Remote Interface Operation To avoid multiple waveform changes, enable the burst mode after you have set up the other parameters.
:BURSt[1|2]:STATe {OFF|ON}
:TRIGger[1|2]:COUNT {<#cycles>}
Burst is enabled if the number of cycles to generate bursts is 2 or greater than 2.

3.13.2 Continuous Burst Mode

Introduction The following figure shows typical timings for trigger mode *Continuous* and *Burst* enabled.

- Characteristics**
- A burst of waveform cycles is repeated continuously.
 - You can select the number of cycles per burst in the range of 2 to 1,000,000.
 - Trigger Out marks each cycle.
 - Strobe Out rises at the start of the first cycle in a burst and falls at the start of the last cycle.

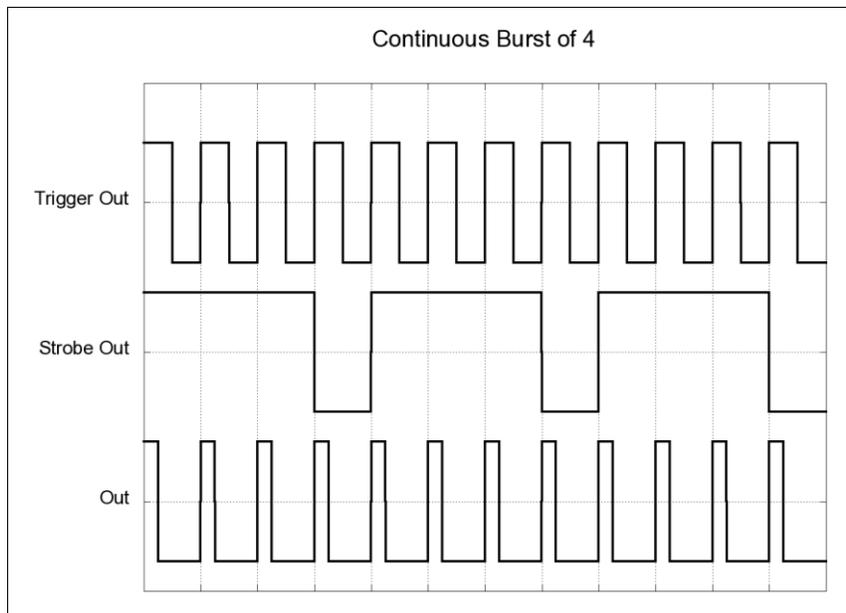

3.13.3 Triggered Burst Mode

Introduction The following figures show typical timings for trigger mode *Triggered* and *Burst* enabled.

Characteristics A burst of waveform cycles is triggered by an active edge at the selected arming source.

- Man key on front panel, triggered by press or release or both.
- External In (External signal) triggered by rising or falling or both edges.
- Internal (Internally triggered bursts), select the triggering period.

You can select the number of cycles per burst in the range of 2 to 1,000, 000. Trigger Out marks each cycle.

Strobe Out rises at the start of the first cycle in a burst and falls at the start of the last cycle.

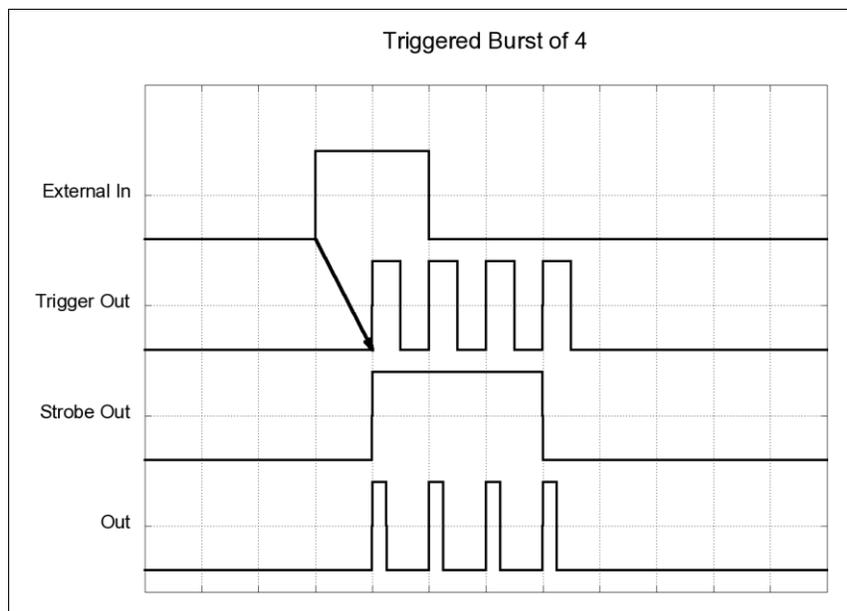

3.13.4 Gated Burst Mode

Introduction The following figures show typical timings for trigger mode *Gated* and *Burst* enabled.

Characteristics Bursts of waveform cycles are enabled by (Gated by) an active level at the selected arming source:

- Man key on front panel, gated while pressed or released or both.
- External Input (External signal) gated while high or low or both.

You can select the number of cycles per burst in the range 2 to 1,000, 000. Trigger Out marks each cycle. Strobe Out rises at the start of the first cycle in a burst and falls at the start of the last cycle.

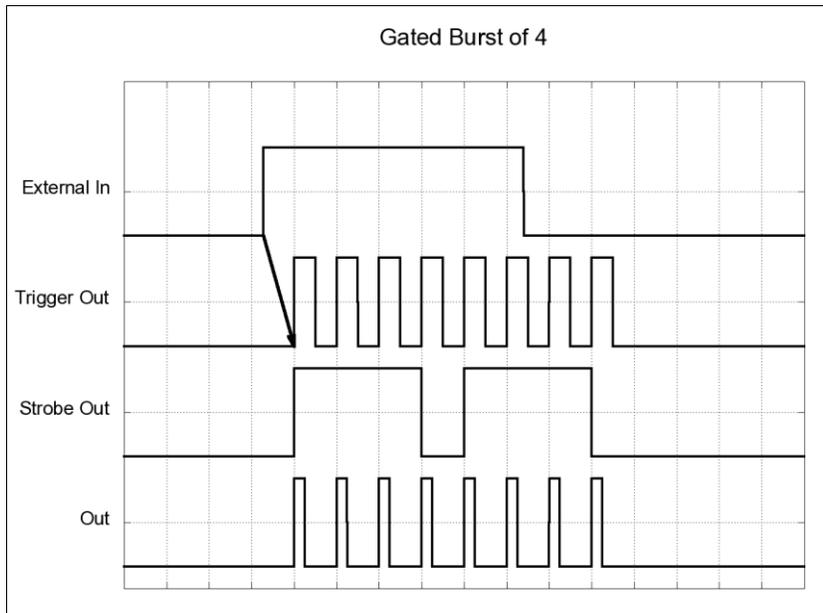

3.13.5 Burst Count

Introduction The burst count defines the number of cycles to be output per burst.

Characteristics

- Burst count: 2 to 1,000, 000 cycles, in 1 cycle increments. *The default is 2 cycles.*
- When the *Internal* trigger source is selected, the specified number of cycles is output continuously at a rate determined by the Internal trigger/frequency setting. The Internal trigger frequency defines the interval between bursts.
- When the *Internal* trigger source is selected, the burst count must be less than the product of the Internal trigger frequency and the waveform frequency as shown below.

$$\text{Burst Count} \leq \text{Internal trigger period} \times \text{Output frequency}$$

Front Panel Operation To set the burst count, press the **#Cycles** softkey and then use the knob or numeric keypad to enter the count.

Remote Interface Operation :BURSt[1|2]:NCYCles {<#cycles>|MINimum|MAXimum}
 :TRIGger[1|2]:COUNT {<#cycles>|MINimum|MAXimum}

3.13.6 Burst Phase

Introduction The *burst phase* defines the starting phase of the burst.

- Characteristics**
- Burst phase: -360 degrees to +360 degrees. *The default is 0 degrees.*
 - From the remote interface, you can set the starting phase in degrees or radians using the UNIT:ANGL command.
 - From the front panel, the starting phase is always displayed in degrees (radians are not available). If you set the starting phase in radians from the remote interface and then return to front-panel operation, you will see that the 81150A / 81160A converts the phase to degrees.
 - For sine, and arb waveforms, 0 degrees is the point at which the waveform crosses zero volts (or the dc offset value) in a positive going direction. For arbitrary waveforms, 0 degrees is the first waveform point downloaded to memory. The burst phase has no effect on pulse, ramp, square, or noise waveforms.
 - The burst phase is also used in the *gated* burst mode. When the gate signal goes *inactive*, the current waveform cycle is completed and then the 81150A / 81160A stops. The output will remain at the voltage level corresponding to the starting burst phase.
-

Front Panel Operation To set the burst phase, press the **Start Phase** softkey and then use the knob or numeric keypad to enter the desired phase in degrees.

Remote interface Operation :BURSt[1|2]:PHASe {<angle>|MINimum|MAXimum}

3.14 Arbitrary Waveforms

Introduction

There are seven built-in arbitrary waveforms stored in non-volatile memory. You can also store up to four user-defined waveforms in non-volatile memory in addition to one in volatile memory.

81150A: Each waveform can contain between 2 and 524288 data points.

81160A 1 channel: Each waveform can contain between 2 and 262144 data points.

81150A 2 channels: Each waveform can contain between 2 and 131072 data points.

You can create an arbitrary waveform from the front panel as described in the following section, or you can use the Keysight BenchLink Waveform Builder software provided on the CD-ROM included with the Keysight 81150A or 81160A. The Keysight BenchLink Waveform Builder software allows you to create arbitrary waveforms using a graphical user interface on your PC, and then download them into the Keysight 81150A / 81160A. You can also capture waveforms from your Keysight oscilloscope and import them into BenchLink.

Refer to the Tutorial chapter for more information on the internal operation of downloading and outputting an arbitrary waveform.

3.14.1 Creating and Storing an Arbitrary Waveform

Introduction

This section gives an example which shows you how to create and store an arbitrary waveform from the front panel. To download an arbitrary waveform from the remote interface, see “Arbitrary Waveform Commands”. For this example, you will create and store the ramp waveform shown below using four waveform points.

Select the arbitrary waveform function

Press  to select the arbitrary function.

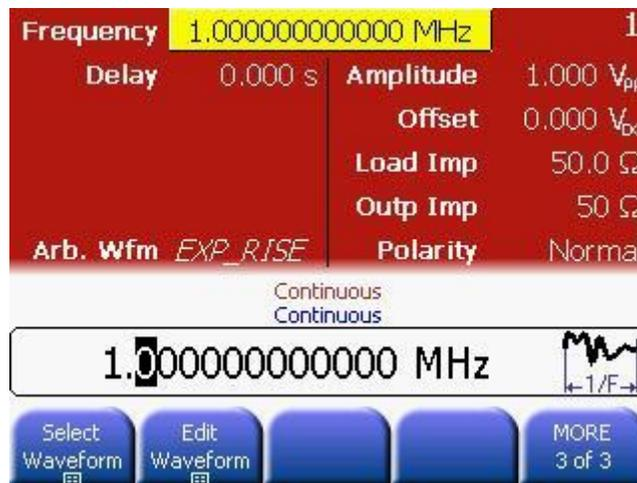

Start the arbitrary waveform editor

Press the **Edit Waveform** softkey and then the **Create New** softkey to create a new waveform (the previous waveform in volatile memory will be overwritten).

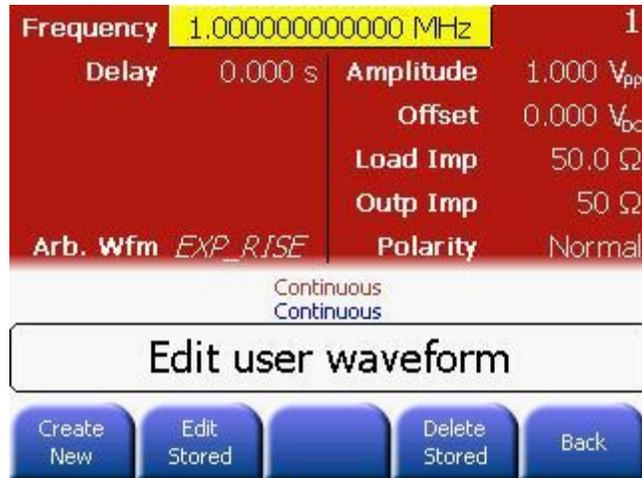

Configure the new waveform

Configure the new waveform by providing all the information shown in the following screen.



Set the initial number of waveform points

You can create an arbitrary waveform with up to 16384 (16K) points. The waveform editor initially builds a waveform with two points and automatically connects the last point of the waveform to the voltage level of the first point to create a continuous waveform. Press the **Initial #Points** softkey to specify the initial number of waveform points (you can add or remove points later if necessary).

For this example, set the initial number of points to "4".

Select the interpolation method

Press the **Interpolation** softkey to enable or disable linear interpolation between waveform points (this feature is available from the front panel only). With interpolation enabled (default), the waveform editor makes a straight-line connection between points. With interpolation disabled, the waveform editor maintains a constant voltage level between points and creates a "step-like" waveform.

For this example, turn on linear interpolation.

Auto Update

On: Changes of the waveform will be applied immediately to the output. The editor is slower.

Off: The waveform will be applied to output when editing is finished. The editor is faster due to missing hardware update.

Start the point-by-point editing process

Press the **Edit** softkey to accept the initial waveform settings and begin point-by-point editing.

Define the first waveform point

Press **Y** softkey to set the voltage level for Point #1 (this point is fixed at address 0). By default, all points are set to 0.

For this example, set the value of Point # 1 to -8191.

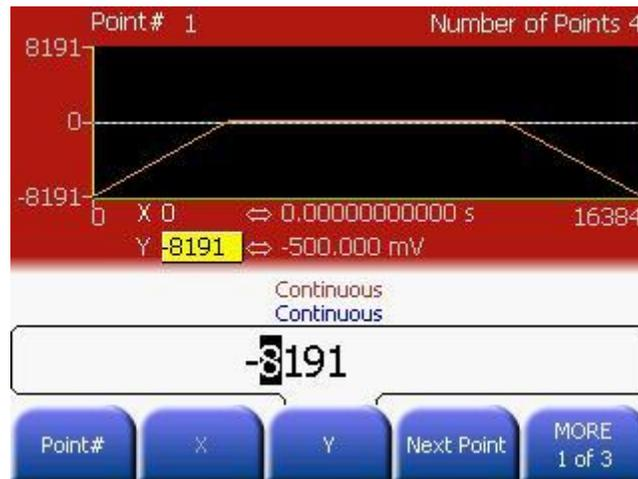
**Define the next waveform point**

Press the **Point #** softkey and then turn the knob to move to Point #2, or press the **Next Point** softkey.

Press the **X** softkey to set the address for the current point (this softkey is not available for Point #1). Press the **Y** softkey to set the DAC value for the current point.

For this example, set X to 3279 and Y to 8191.

Define the remaining waveform points

Using the **X** and **Y** softkeys, define the remaining waveform points using the values shown in the table below.

- The X value of the last point that can be defined in the waveform must be less than 16384 (16K).
- The waveform editor automatically connects the last waveform point to the voltage level of first point to create a continuous waveform.
- To insert additional points after the current waveform point, press the **Insert Point** softkey. The new point is inserted with the same DAC value as the current point.
- To remove the current waveform point, press the **Remove Point** softkey. The remaining points are joined using the interpolation method currently selected.
- If Point #1 is removed, then Point #2 will be placed to address 0. Remove Point is not possible if the waveform has 2 points, since this is the minimum waveform length.

	Point	X	Y
1	0	-8191	
2	3279	8191	
3	6554	4096	
4	11469	-8191	

Equidistant Spacing Pressing the [Equidistant Spacing] softkey adjusts all points in the waveform editor at an equal distance from one-another.

End Edit

When the editing is finished, the resulting waveform will look similar to the following screenshot.

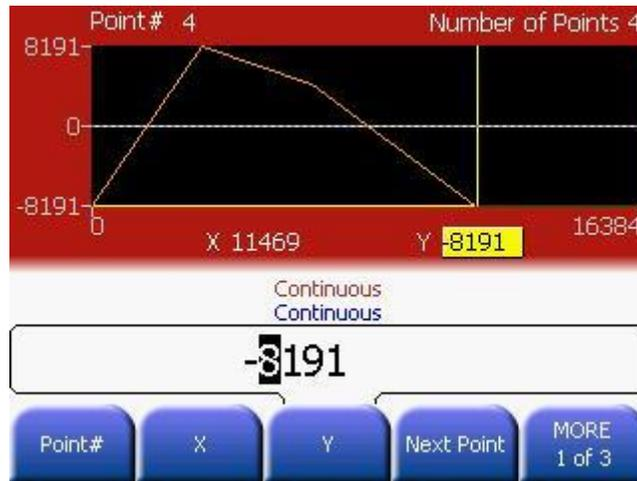

Store the arbitrary waveform in memory

END Edit does apply the waveform to the hardware and exits the editor. In this case, the changes are only done on the volatile memory of the waveform.

STORE in NON-VOL does open the waveform browser to store the waveform in non-volatile memory.

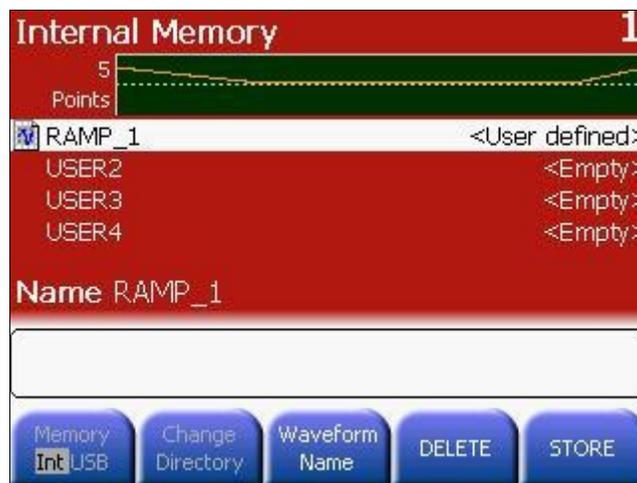

Assigning a Name

You can assign a custom name to the four non-volatile memory locations. The custom name can contain up to 12 characters. The first character must be a letter but the remaining characters can be letters, numbers, or the underscore character (“_”).

To add additional characters, press the right-cursor key until the cursor is to the right of the existing name and then turn the knob.

To delete all characters to the right of the cursor, press the  key.

For this example, assign the name “RAMP_NEW” to memory location 1 and then press the **STORE** softkey to store the waveform.

The waveform is now stored in non-volatile memory and is currently being output from the 81150A / 81160A. The name that you used to store the waveform should now appear in the list of stored waveforms (under the **Select Waveform** softkey).

3.14.2 Managing Stored Waveforms

Introduction

- There are four built-in storage locations for arbitrary waveforms.
- You can store arbitrary waveforms on a USB mass memory device.
- You can load arbitrary waveforms from the USB mass memory device into the volatile memory.

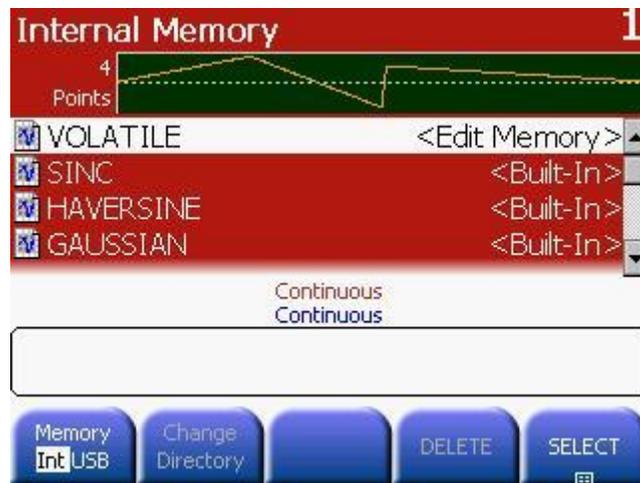
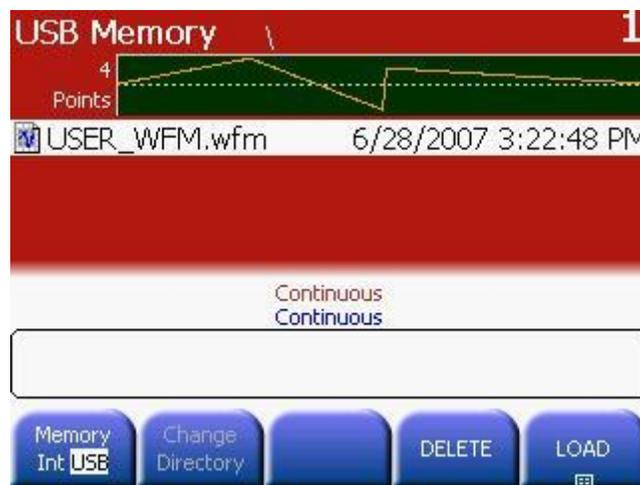

Memory Int USB This softkey toggles between the Internal storage locations and the USB mass memory.

Change Directory This softkey is only available when you are working with USB memory. Press the **Change Directory** softkey to navigate to the selected directory.

Waveform Name This softkey is only available when storing a waveform. You can assign a custom name to the four non-volatile memory locations. The custom name can contain up to 12 characters. The first character must be a letter but the remaining characters can be letters, numbers, or the underscore character (" _ "). To add additional characters, press the right-cursor key until the cursor is to the right of the existing name and then turn the knob. To delete all characters to the right of the cursor, press the  key.

DELETE This softkey deletes the currently highlighted waveform. You cannot delete the built-in waveforms and the waveform in the Volatile memory.

EDIT This softkey is only available when selecting stored waveforms for editing. Pressing this softkey loads the selected wavform into volatile memory and opens the waveform editor to edit the volatile memory. Only waveforms of upto 16K points can be created/edited using the Front Panel interface. Larger waveforms must be edited using an external application, such as Keysight BenchLink Waveform Builder, and then downloaded into the 81150A / 81160A.

LOAD This softkey is only available when selecting a waveform from USB memory. This softkey loads the currently highlighted waveform from the USB memory into the volatile memory.

If the size of this waveform is bigger than the maximum size of the destination memory, the waveform will be adjusted to fit into the destination memory.

SELECT This softkey selects the currently highlighted waveform.

STORE This softkey stores the content of the volatile memory to one of the four user-defined waveform storage locations or to the USB memory.

3.14.3 Additional Information on Arbitrary Waveforms

Introduction

The currently selected waveform is displayed on the Arb screen.

In addition to creating a new arbitrary waveform from the front panel, you can also edit any existing user-defined waveforms. You can edit waveforms that were created either from the front panel or from the remote interface. However, you cannot edit any of the seven built-in arbitrary waveforms. And only waveforms with a maximum number of 16384 points.

- Press the **Edit Waveform** softkey to edit any of the arbitrary waveforms stored in non-volatile memory or the waveform currently stored in volatile memory. While editing an existing waveform, please note the following interactions.
 - If you select an arbitrary waveform as the *modulating* waveshape for AM, FM, PM, or PWM, the waveform is automatically limited to 16K points. Extra waveform points are removed using decimation.
-

3.15 System-Related Operations

Introduction

This section gives information on topics such as instrument state storage, power-down recall, error conditions, self test, and front-panel display control. This information is not directly related to waveform generation but is an important part of operating the 81150A / 81160A.

3.15.1 Instrument State Storage

Introduction

The 81150A / 81160A has five storage locations in non-volatile memory to store instrument states. The locations are numbered 0 through 4.

Storage location "0" holds the instruments default state. It is not possible to store an instrument state to location "0".

You can also assign a user-defined name to each of the locations (1 through 4) for use from the front panel.

Characteristics

- You can store the instrument state in location "1" to "4". However, you can only recall a state from a location that contains a previously-stored state.
- From the *remote interface* only, you can recall location "0". This is equivalent to using the SCPI command *RST.
- The state storage feature "remembers" the selected function (including the name of the arbitrary waveforms), frequency, amplitude, dc offset, duty cycle, symmetry, as well as any modulation parameters in use.
- When shipped from the factory, storage locations "1" through "4" are empty (location "0" contains the default state).
- When power is turned off, the 81150A / 81160A automatically stores its state in a non-volatile memory (battery backed up). You can configure the 81150A / 81160A to automatically recall the power-down state or the default state when power is restored. When shipped from the factory, the 81150A / 81160A is configured to automatically recall the power-down state at power-on. However, when recalling the power-down state, the outputs will always be forced to the off state.
- You can assign a custom name from "1" to "4" to storage locations (however, you cannot name location "0"). You can name a location from the front panel or over the remote interface, but you can only recall a state by name from the front panel. From the remote interface, you can only recall a stored state using a number (0 through 4).

Characteristics

- The name can contain up to 12 characters. The first character must be a letter (A-Z), but the remaining characters can be letters, numbers (0-9), or the underscore character (“_”). Blank spaces are not allowed. An error will be generated if you specify a name with more than 12 characters.
- The 81150A / 81160A *will not* prevent you from assigning the *same* custom name to different storage locations. For example, you can assign the same name to locations “1” and “2”.
- If you delete an arbitrary waveform from non-volatile memory after storing the instrument state, the waveform data is lost and the 81150A / 81160A *will not* output the waveform when the state is recalled. The built-in “exponential rise” waveform is output in place of the deleted waveform.
- An instrument reset *does not affect* the configurations stored in memory. Once a state is stored, it remains until it is overwritten or specifically deleted.

Front Panel Operation

Press  and then select the **Store State** or **Recall State** softkey. To delete a stored state, select the **Delete State** softkey (also removes the custom name for this memory location).

Recall and Delete keys are both disabled if nothing is stored (and thus nothing to Recall/Delete exists).

To configure the 81150A / 81160A to recall the factory default state at power-on, press  and then select the **Power-ON State** softkey. To configure the 81150A / 81160A to recall the power-down state when power is restored, press the **Power-ON State** softkey and select Last Setting.

You can assign a custom name to each of the four storage locations.

- The custom name can contain up to 12 characters. The first character must be a letter but the remaining characters can be letters, numbers, or the underscore character (“_”).
- To add additional characters, press the right-cursor key until the cursor is to the right of the existing name and then turn the knob.
- To delete all characters to the right of the cursor, press the  key.



Remote Interface Operation

*SAV {1|2|3|4}

*RCL {0|1|2|3|4} States 1, 2, 3, and 4 are user-defined states.

To assign a custom name to a stored state to be recalled from the front panel, send the following command. From the remote interface, you can only recall a stored state using a number (0 through 4).

```
MEMory:STATe:NAME {1|2|3|4}, name
MEM:STATE:NAME 1,TEST_WFORM_1
```

To configure the 81150A / 81160A to automatically recall the power-down state when power is restored, send the following command:

```
MEMory:STATe:RECall:AUTO ON
```

3.15.2 Export/Import State

Introduction The 81150A / 81160A can store instrument states on a USB memory device, usually this is a USB stick, but could also be a hard drive.

Front Panel Operation

Press the  key and then the More softkey. You will then see two softkeys labeled **Export State** and **Import State**. This is available on the second level of the softkey menu (More 2).

These are the ones to be used when storing to/recalling from USB memory devices.



**Press
Export/Import
softkey**

- Press the **Export State/Import State** softkey to store to recall from USB memory devices.
- Choose from **DELETE/STORE/RECALL** and press the corresponding softkey.
- Press the **File Name** softkey to define/set file name. This name will be used for storing the instrument state using the **STORE** softkey.

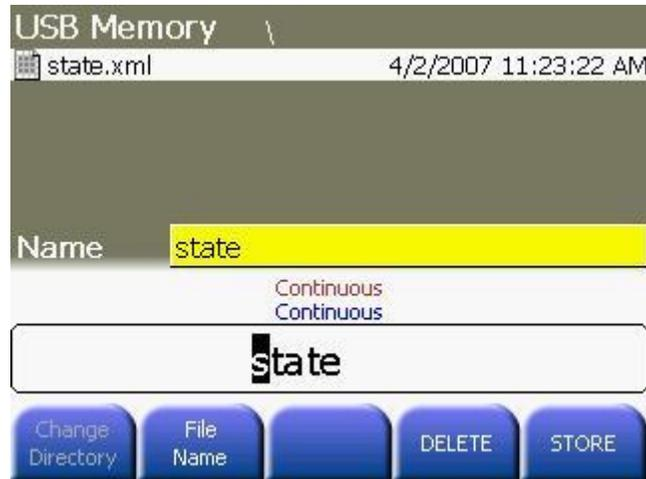

The waveform editor is also able to store to a USB memory device. In this case you need to select **Store in NON-VOL** and on the waveform browser you have to press the leftmost softkey (**Memory Int/USB**). This softkey toggles between the internal waveform storage locations and the content of the USB memory device.

The same key is to be used when selecting a waveform that is stored on an USB memory device.

3.15.3 Error Conditions

Introduction A record of up to 30 command syntax or hardware errors can be stored in the 81150A / 81160A's error queue.

- Characteristics**
- Errors are retrieved in first-in-first-out (FIFO) order. The first error returned is the first error that was stored. Errors are cleared as you read them. The 81150A / 81160A beeps once each time an error is generated (unless you have disabled the beeper).
 - If more than 30 errors have occurred, the last error stored in the queue (the most recent error) is replaced with "Queue overflow". No additional errors are stored until you remove errors from the queue. If no errors have occurred when you read the error queue, the 81150A / 81160A responds with "No error".
 - The error queue is cleared by the *CLS (clear status) command or when the power is cycled. The errors are also cleared when you read the error queue. The error queue is not cleared by an instrument reset (*RST command).
-

**Front-Panel
Operation**

Press  and then the **Error Queue** softkey to view all errors of the local interface. It is not possible to read the errors of the remote programming interfaces from the GUI.

The list of all active warnings is available with the **Warnings** softkey (same for local and remote).

Warnings are system-wide conditions that apply to the local and remote Interface at the same time.

**Remote Interface
Operation**

SYSTem:ERRor?

Reads one error from the error queue Errors have the following format (the error string may contain up to 255 characters).

-113,"Undefined header"

:SYSTem:WARNing:BUFFer?

Returns the number of active warnings.

:SYSTem:WARNing:STRing?

Returns all active warning messages.

3.15.4 Beeper Control

Introduction Normally, the 81150A / 81160A will emit a tone when an error is generated from the front-panel or over the remote interface. You may want to disable the front-panel beeper for certain applications.

- Characteristics**
- The beeper state is stored in non-volatile memory and does not change when power has been off or after a remote interface reset. When shipped from the factory, the beeper is enabled.
 - Turning off the beeper does not disable the key click generated when you press a front-panel key or turn the knob.
-

Front-Panel Operation

Press  and then press the **System** softkey. Use the knob to enable/disable the beeper.

Remote Interface Operation

SYSTem:BEEPer

Issue a single beep immediately

SYSTem:BEEPer:STATE {OFF|ON}

Disable/enable beeper.

3.15.5 Display Brightness

Introduction To optimize the readability of the front-panel display, you can adjust the brightness setting. *This feature is available from the front panel only.*

Characteristics Display brightness: 0 to 7. *The default is 0.*
The brightness setting is stored in non-volatile memory and does not change when power has been off or after a remote interface reset.

Front-Panel Operation Press  and then select the **Display Brightness** softkey from the "System" menu.

3.15.6 Display Control

Introduction For security reasons, or to speed up the rate at which the 81150A / 81160A can execute commands from the remote interface, you may want to turn off the front-panel display. From the remote interface, you can also display a 12-character message on the front panel.

Characteristics

- The display can be disabled from the front-panel. Press , then **System**, and then the **Display Off** softkey. Pressing any key or turning the Rotary Knob will turn the display on.
 - When disabled, the front-panel display is blanked.
 - Sending a message to the front-panel display from the remote interface overrides the display state. This means that you can display a message even if the display is currently disabled.
 - The display is automatically enabled when power is cycled.
 - You can display a text message on the front panel by sending a command from the remote interface. You can use upper- or lower-case letters (A-Z), numbers (0-9), and any other character on a standard computer keyboard. Depending on the number of characters that you specify, the 81150A / 81160A will choose one of two font sizes to display the message. You can display approximately 12 characters in a large font and approximately 40 characters in a small font.
 - When the display is blanked, then all the LEDs at the front-panel keys are also turned off (except the power key).
-

**Remote Interface
Operation**

The following command turns off the front-panel display:

```
DISP OFF
```

The following command displays a message on the front panel and turns on the display if currently disabled:

```
DISP:TEXT 'Test in Progress...'
```

To clear the message displayed on the front panel (without changing the display state), send the following command:

```
DISP:TEXT:CLEAR
```

3.15.7 Time

Introduction Displays the time which is set on the instrument.

Front Panel Operation

Press  and then **System** softkey. Press **MORE** and then the **Time** softkey



Remote Interface Operation :SYSTem:TIME {<hours>,<minutes>,<seconds>}
:SYSTem:TIME?



The time can be modified using the Rotary Knob.

3.15.8 Date

Introduction Displays the date which is set on the instrument.

Front Panel Operation

Press  and then **System** softkey. Press **MORE** and then the **Date** softkey



The date can be modified using the Rotary Knob.

Remote Interface Operation

:SYSTem:DATE {<years>, <month>, <day>}
:SYSTem:DATE?

3.15.9 Firmware Revision Query

Introduction You can query the 81150A / 81160A to determine which revision of firmware is currently installed.

Front-Panel Operation

Press  and then press **System**, and then press the **Configuration** softkey.



Remote Interface Operation

Use the following command to read the 81150A / 81160A's firmware revision numbers (be sure to dimension a string variable with at least 80 characters).

```
*IDN?
```

This command returns a string in the form: Keysight Technologies, 81150A / 81160A, ssssssss, x.x.x.x.-h

ssssssss – Serial Number

x.x.x.x – Software Revision

h – Hardware Revision

3.15.10 SCPI Language Version Query

Introduction The 81150A / 81160A complies with the rules and conventions of the present version of SCPI (*Standard Commands for Programmable Instruments*). You can determine the SCPI version with which the instrument is in compliance by sending a query from the remote interface. You cannot query the SCPI version from the front panel.

Remote Interface Operation SYSTem:VERSion?
Returns a string in the form "YYYY.V", where "YYYY" represents the year of the version, and "V" represents a version number for that year (e.g., 1999.0).

3.16 Remote Interface Configuration

Introduction

This section gives information on configuring the 81150A / 81160A for remote interface communication. For information on configuring the instrument from the front panel, see “Configuring the Remote Interface” section. For information on the SCPI commands available to program the 81150A / 81160A over the remote interface, see chapter 4.

The Keysight 81150A / 81160A supports remote interface communication using a choice of three interfaces: GPIB, USB, and LAN. All three interfaces are "live" at power up. This section describes some interface configuration parameters that you may need to set on your 81150A / 81160A.

 *The CD-ROM provided with your instrument contains connectivity software to enable communications over these interfaces. Refer to the instructions provided on the CD-ROM to install this software on your PC.*

- **GPIB Interface.** You need to set only the GPIB address for the 81150A / 81160A and connect it to your PC using a GPIB cable.
- **USB Interface.** There is nothing to configure on your 81150A / 81160A. Just connect the 81150A / 81160A to the PC with a USB cable.
- **LAN Interface.** By default, DHCP is On, which may enable network communication over the LAN interface. You may need to set several configuration parameters as described in the LAN configuration sections that follow.



For detailed background information, refer to the *Keysight Technologies USB/LAN/GPIB Connectivity Guide*, which you can download from the Keysight web site at the following URL:

www.keysight.com/find/connectivity

3.16.1 GPIB Address

Introduction Each device on the GPIB (IEEE-488) interface must have a unique address. You can set the 81150A / 81160A's address to any value between 0 and 30. The address is set to "10" when the 81150A / 81160A is shipped from the factory.

Characteristics The address is stored in *non-volatile* memory and *does not* change when power has been off or after a remote interface reset. Your computer's GPIB interface card has its own address. Be sure to avoid using the computer's address for any instrument on the interface bus.

Front-Panel Operation Press  and then select the **GPIB Address** softkey from the **I/O Interfaces** menu. There is no SCPI command to set the GPIB address.

3.16.2 DHCP/Auto-IP On/Off (LAN)

Introduction DHCP (Dynamic Host Configuration Protocol) is a protocol for automatically assigning a dynamic IP address to a device on a network. DHCP is typically the easiest way to configure your Keysight 81150A / 81160A for remote communication using the LAN interface. DHCP/Auto-IP is *On* by default.

Setting up DHCP/Auto-IP

- Select **DHCP/Auto-IP On** to use DHCP to automatically assign an IP address. If DHCP is not available, then Auto IP will be used to assign the IP address.
- Select **DHCP/Auto-IP Off** if you want to manually assign an IP address using the **IP Address** softkey.
- The DHCP/Auto-IP setting is stored in non-volatile memory and does not change when power has been off or after a remote interface reset.

Front Panel Operation

- Press  and then the **I/O Interfaces** softkey.
- Then select **LAN**, followed by **IP Setup**.
- By default, DHCP/Auto-IP is On. Press the **DHCP/Auto-IP** softkey to toggle its state.
- There is no SCPI command to set DHCP/Auto-IP On/Off.

3.16.3 IP Address (LAN)

Introduction An IP address is actually a four-byte integer expressed in the notation "nnn.nnn.nnn.nnn" where "nnn" in each case is a byte value from 000 to 255.

You can enter an IP address for Keysight 81150A / 81160A.

- Setting up an IP Address**
- You need not set an IP address if DHCP is in use.
 - Contact your network administrator for a valid IP address to use for your 81150A / 81160A.
 - Enter the IP address using the numeric keypad (not the knob).
 - The IP address is stored in *non-volatile* memory and does not change when power has been off or after a remote interface reset.
-

- Front Panel Operation**
- Press  and then the **I/O Interfaces** softkey.
 - Then select **LAN**, followed by **IP Setup**.
 - By default, DHCP is On. Select **DHCP Off** if necessary. The **IP Address** field appears.
 - There is no SCPI command to set an IP address.
-

3.16.4 Subnet Mask (LAN)

Introduction Subnetting allows the network administrator to divide a network into smaller networks to simplify administration and to minimize network traffic. The subnet mask indicates the portion of the host address to be used to indicate the subnet.

Setting up a Subnet Mask

- You need not set a subnet mask if DHCP is in use.
- Contact your network administrator to find out whether subnetting is being used, and for the correct subnet mask.
- Enter the subnet mask using the numeric keypad (not the knob).
- The subnet mask is stored in non-volatile memory and does not change when power has been off or after a remote interface reset.

Front Panel Operation

- Press  and then the **I/O Interfaces** softkey.
- Then select **LAN**, followed by **IP Setup**.
- By default, DHCP is On. Select **DHCP Off** if necessary. Then select **Subnet Mask**.
- There is no SCPI command to set a subnet mask.

3.16.5 Default Gateway (LAN)

Introduction A gateway is a network device that provides a connection between networks. The default gateway setting is the IP address of such a device.

- Setting up a default Gateway**
- You need not set a gateway address if DHCP is in use.
 - Contact your network administrator to find out whether a gateway is being used, and for the address.
 - Enter the gateway address using the numeric keypad (not the knob).
 - The gateway address is stored in non-volatile memory and does not change when power has been off or after a remote interface reset.
-

- Front panel operation**
- Press  and then the **I/O Interfaces** softkey.
 - Then select **LAN**, followed by **IP Setup**.
 - By default, DHCP is On. Select **DHCP Off** if necessary. Then select **Default Gateway**.
 - There is no SCPI command to set a gateway address.
-

3.16.6 Host Name

Introduction A host name is the host portion of the domain name, which is translated into an IP address.

- Setting up a Host Name**
- Contact your network administrator for the correct host name.
 - Enter the host name using the knob and cursor keys. Each character in the name can be a letter ("a" through "z"), number, or dash ("-").
 - Use the knob to select each character.
 - Use the cursor key to move to the next character.
 - You can use the keypad for numbers.
 - The host name is stored in non-volatile memory and does not change when power has been off or after a remote interface reset.
-

Front panel operation

- Press  and then the **I/O Interfaces** softkey.
 - Then select **LAN**, followed by **DNS Setup**.
 - Then select **Host Name**.
 - There is no SCPI command to set a host name.
-

3.16.7 Domain Name (LAN)

Introduction A domain name is a registered name on the Internet, which is translated into an IP address.

Front Panel Operation

- Press  and then the **I/O Interfaces** softkey.
 - Then select **LAN**, followed by **DNS Setup**.
-



The Domain name cannot be changed. The 81150A / 81160A simply displays the name of the domain that was determined when the instrument was connected to the LAN.

3.16.8 DNS Server (LAN)

Introduction DNS (Domain Name Service) is an Internet service that translates Domain names into IP addresses. The DNS server address is the IP address of a server that performs this service.

Setting up a DNS Server address

- Contact your network administrator to find out whether DNS is being used, and for the correct DNS server address.
- Enter the address using the numeric keypad (not the knob).
- The DNS server address is stored in non-volatile memory and does not change when power has been off or after a remote interface reset.

Front Panel Operation

- Press  and then the **I/O Interfaces** softkey.
- Then select **LAN**, followed by **DNS Setup**.
- Then select DNS Server 1 or DNS Server 2.
- There is no SCPI command to set a DNS server address.

3.16.9 WINS Server (LAN)

Introduction WINS (Windows Internet Naming Service) is an Internet service that translates Host names to IP addresses. The WNS server address is the IP address of a server that performs this service.

Setting up a WNS Server address

- Contact your network administrator to find out whether WINS is being used, and for the correct WINS server address.
- Enter the address using the numeric keypad (not the knob).
- The WINS server address is stored in non-volatile memory and does not change when power has been off or after a remote interface reset.

Set the “WINS Server” address Press the **WINS Server** softkey and enter the address of the WINS server (there are two DNS Server addresses) in the IP address format (using the keypad). Set the WINS Server 1 and WINS Server also.

**Front Panel
Operation**

- Press  and then the **I/O Interfaces** softkey.
- Then select **LAN**, followed by **DNS Setup**.
- Then select WINS Server 1 or WINS Server 2.
- There is no SCPI command to set a WINS server address.



3.16.10 Current Configuration (LAN)

Introduction

The current configuration is displayed on the LAN screen. Changes to the LAN settings will be applied immediately. It is not required to re-boot after changing the LAN settings.





Try the Keysight 81150A / 81160A Web Interface!

The Keysight 81150A / 81160A provides a web interface resident in the instrument.

You can use this interface over the LAN to view and modify the instrument's I/O configuration. Also, a remote front panel interface is provided, which allows you to control the instrument over the network.

To access and use the web interface:

1. Establish LAN interface connectivity from your PC to the 81150A / 81160A.
2. Open your PC's web browser.
3. To launch the web interface enter the IP address of the instrument, or its fully qualified host name, in the browser address field.
4. Follow the directions in the web interface's online help.

For further information, see the Keysight Technologies USB/LAN/GPIB Connectivity Guide, which you can download from the Keysight web site at the following URL:

www.keysight.com/find/connectivity

3.17 Software Update

Introduction

The Software Update screen gives you prompt information about the 81150A / 81160A.

The software update package contains two firmware images. Both will be extracted to the USB memory device during the update process. In case of a power-loss during the update, the instrument will load the recovery image from the USB memory device if the regular firmware image is corrupt.

This recovery image will continue the update process in case of a completely or partially erased or incomplete (not yet updated completely) firmware image.

To ensure that this recovery mechanism is working, the USB memory device may not be unplugged until the instrument has booted into the upgraded firmware.

Requirements

- USB Memory device with at least 100 MB of free space.
 - The USB memory device must be formatted as a hard-drive with a primary partition. The partition has to be formatted using the FAT or FAT32 file system.
 - Do not use USB memory devices that contain extended partition. The instrument will not be able to recover from a failed update from such memory devices.
 - USB memory devices that are formatted as a super floppy are not supported and hence will not be recognized by the instrument.
-

**Front Panel
Operation**

- Press  and then the **System** softkey. Then press the **Configuration** softkey to reach the Software Update screen.
- Press the Software Update softkey for instructions on how to update the instrument with the latest software. This is shown below in the second screen.



3.18 Installing Licenses

Introduction

Some of the features of the 81150A / 81160A are enabled by additional software licenses.

Installed licenses are being displayed on the system configuration screen.

Additional licenses can be installed by entering the license code that is provided by Keysight Technologies when ordering a specific license.

Licenses are not transferable from one instrument to another one.

For pattern Generation of 81150A / 81160A, a software license is available.

Front Panel Operation

- Press  and then the **System** softkey. Then press the **Configuration** softkey to reach the Software License screen.
- Press the **Software License** softkey for entering the license code. Enter the license code using the numerical keypad and confirm the input by pressing the **Enter** softkey.





3.19 Diagnostics/Calibration Overview

Introduction

The 81150A / 81160A provides a self-calibration functionality.

The diagnostics screen allows to review the power-on messages, to execute the instruments self-test (standard + extended) and to perform the self-calibration.

All cables need to be disconnected before executing the extended self-test or self-calibration.

Self-Calibration includes

- Levels at normal and inverted outputs
 - **81150A only:** Levels at Trigger-Out
 - **81150A only:** Levels at Strobe-Out
 - **81160A only:** Levels at Sync-Out
 - Sensitivity of External-In
 - Input voltage window and OV level at Modulation-In
-

Front Panel Operation

Press  and then the **System** softkey and then press the **Diagnostics** softkey. The Diagnostics screen contains the following:

- Power On Messages
- Selftest
- Extended Selftest
- Calibration

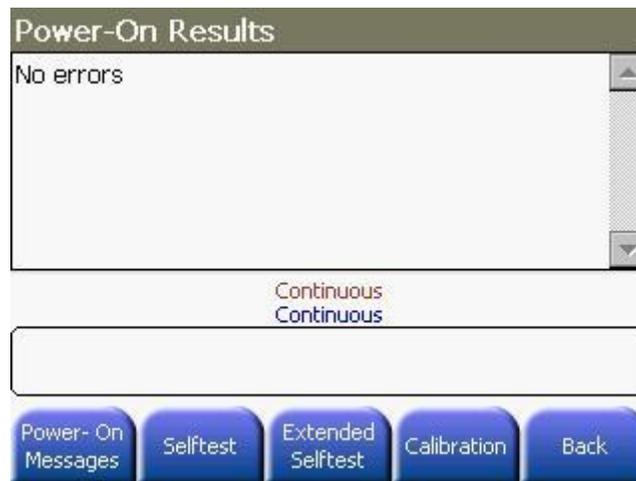

Power-On Results Press the **Power-On Messages** softkey to review the result of the power-on test.

Performing Selftest Press the **Selftest** softkey to execute the standalone selftest. Remove all cables from the instrument before starting the extended selftest.

Performing Extended Selftest Press the **Extended Selftest** softkey to reach this screen. Press **Yes** to start Extended Selftest and **No** to exit. Remove all cables from the instrument before starting the extended selftest.

**Performing
Calibration**

Press the **Calibration** softkey to reach this screen. Press **Yes** to start calibration and **No** to exit.

Remove all cables from the instrument before starting the calibration.

**Remote Interface
Operation**

The following functions are used to execute the selftests:

*TST?

:SYSTem:TEST? {PON|NORM|ALL}

To execute self-calibration, use:

*CAL?

3.20 Security

Introduction The 81150A / 81160A provides security functionality.

Front Panel Operation

- Press  and then press the **System** softkey.
- Press the **Security** softkey.



Secure All Pressing this key deletes all user data and shuts down the machine.

Web Server This key helps you to enable/disable the embedded web-server.

Web Password Defines the password that is required to modify the instrument settings from within the web Interface.

81150A: The default password is: AGT81150

81160A: The default password is: Keysight

3.21 Factory Default Settings

Introduction

The table on the following page summarizes the factory default settings for the Keysight 81150A / 81160A.



- The power-on state will be different than that in the table if you have enabled the power-down recall mode. See “Instrument State Storage”.

Keysight 81150A / 81160A Factory Default Settings

 Output Configuration	Factory Setting
Function	Sine wave
Frequency	1 MHz
Amplitude/Offset	1 Vpp/0.000 Vdc
Output Units	Vpp
Output Impedance	50Ω
Output Termination	50Ω (81150A only)
Polarity	Normal
Autorange	On
Amplifier Type	Max. Bandwidth (81150A only)
Trigger-Out	TTL (81150A only)
Strobe-Out	TTL (81150A only)
Sync-Out A	TTL (81160A only), Logical Trigger Signal 1
Sync-Out B	TTL (81160A only), Logical Strobe Signal 1
Output State	Off
 Timing Configuration	Factory Setting
Delay	0s (Pulse, Sine, Square, Ramp, Arb)
Width (Pulse)	50 ns
Lead Edge (Pulse)	81150A: 2.5 ns 81160A: 1.2 ns
Duty Cycle (Square)	50%

Trail Edge (Pulse)	81150A: 2.5 ns 81160A: 1.2 ns
Symmetry (Ramp)	100%

 Noise Configuration	Factory Setting
PDF	Gaussian with Crest Factor 3.1
 Arb Configuration	Factory Setting
Waveform	Exponential Rise
 Pattern Configuration	Factory Setting
Pattern Mode	Off
Pattern Source	Internal
Pattern	PRBS 2 ⁷ -1
Bit Shape	NRZ
Bit Waveform	CAP_2
External Patterns	
Number of Levels	2
Sample Mode	Fixed
Lower Threshold Voltage	1.0 V
Upper Threshold Voltage	1.6 V
Pattern Trigger Mode	Block
 Input Configuration	Factory Setting
External-In	
Threshold Voltage	2.5 V
Input Impedance	50Ω
Hysteresis	High (81160A only)
Modulation-In	
Input Range	±5 V
Input Impedance	10 kΩ
Threshold Voltage	2.5 V (external modulated FSK only)
 Modulation	Factory Setting
Carrier (AM, FM, PM, FSK)	1 MHz Sine wave
Carrier(PWM)	1 MHz Pulse
Mod. Waveform (AM)	100 Hz Sine wave
Mod. Waveform (FM, PM, PWM)	10 Hz Sine wave
AM Depth	100%

AM DSSC	Off
FM Deviation	100 Hz
PM Deviation	180 degrees
FSK Hop Frequency	100 Hz
FSK Rate	10 Hz
PWM Width Deviation	500 ps
Modulation State	Off
 Sweep	Factory Setting
Start/Stop Frequency	100 Hz/1 kHz
Sweep Time	1 Second
Sweep Mode/Type	Linear
Sweep State/Frequency Marker	Off

 Burst	Factory Setting
Burst Count	2 Cycle
Burst Start Phase	0 degrees
Burst State	Off
 Triggering Operations	Factory Setting
Trigger Mode	Continuous
Trigger Source	External-In
Internal Trigger Frequency	100 KHz
Triggered/Gated by	Rising Edge/High Level
System-Related Operations	Factory Setting
*Power-Down Recall	Enabled
Display Mode	On
Error Queue	Errors are cleared
Stored States, Stored Arbs	No Change
Remote Interface Configuration	Factory Setting
*GPIB Address	*10
*DHCP	*On
*IP Address	*0.0.0.0.
*Subnet Mask	*0.0.0.0.
*Default Gateway	*000.000.000.000
*DNS Server	*000.000.000.000
*Host Name	*agtXXXXXX (where XXXXX stands for the instrument's serial number)
*Web Server	*Enabled
*Web Server Password	*AGT81150 (81150A only) *Keysight (81160A only)

Parameters marked with an asterisk are stored in non-volatile memory.

Parameter groups marked with a  will be part of the stored instrument state. The content of the volatile arb memories is not part of a stored instrument state.

4 Remote Programming Reference

Introduction This chapter provides general information on writing SCPI programs for the 81150A / 81160A.

4.1 Keysight 81150A / 81160A Remote Control

Introduction The Keysight 81150A / 81160A has two modes of operation:

- Local – The Instrument can be operated using the front panel keys.
- Remote – After receiving the first command or query via the GPIB, USB or LAN, the instrument is put into the remote state and the front panel is locked. To return to the local operating mode, press the Local key on the Front Panel.

USB The USB interface requires no front panel configuration parameters. Just connect your Keysight 81150A / 81160A to your PC using a standard USB cable and the interface will self configure.

LAN There are several parameters that you may need to set to establish network communication using the LAN interface. Primarily, you will need to establish an IP address. You may need to contact your network administrator for help in establishing communication with the LAN interface.

4.1.1 Programming Recommendations

Recommendations for programming the 81150A / 81160A

This section lists some recommendations for programming the instrument.

- Start programming from the default setting. The common command for setting the default setting is:

```
*RST
```

- Switch off the automatic update of the display to increase the programming speed. The device command for switching off the display is:

```
:DISPlay OFF
```

- The SCPI standard defines a long and a short form of the commands. For fast programming speed it is recommended to use the short forms. The short forms of the commands are represented by upper case letters. For example the short form of the command to set 100 ns pulse delay is:

```
:PULS:DEL 100NS
```

- To improve programming speed it is also allowed to skip optional subsystem command parts. Optional subsystem command parts are depicted in square brackets, e.g.: Set edge time in seconds by 4 ns
[:SOURce]:PULSe:TRANSition[1|2][:LEADING]
Sufficient to use:

```
:PULS:TRAN          sets the leading edge in seconds output 1
```

- The commands to set the timing and level parameters, 81150A / 81160A is a real 2 channel instrument have to be specified for output 1 and output 2. If there is no output specified the command will set the default output 1. So, for setting a high level of 3 Volts for output 1 and output 2 the commands are:

```
:VOLT:HIGH 3V      # sets high level of 3 V at out 1
```

```
:VOLT1:HIGH 3V     # sets high level of 3 V at out 1
```

```
:VOLT2:HIGH 3V     # sets high level of 3 V at out 2
```

**Recommendations
for programming
the 81150A /
81160A**

- It is recommended to test the new setting which will be programmed on the instrument by setting it up manually. Enable the outputs so that the instruments error check system is on and possible parameter conflicts are immediately displayed. When you have found the correct setting, then use this to create the program. In the program it is recommended to send the command for enabling outputs (for example, `:OUTPut1 ON`) as the last command. With this procedure it is possible to increase programming speed.

```
*RST           # set default settings
:DISP OFF     # switch off display update
...           # other commands to set modes
...           # and parameters
:OUTP1 ON     # enable the output 1
```

- Selftest of the instrument can be invoked by the common command.

```
*TST?
```

- If it is important to know whether the last command is completed then send the common command.

```
*OPC?
```

4.2 81150A / 81160A SCPI Command Summary

Apply Commands

Command	Parameter	See Page
:APPLy[1 2]?		321
:DC	[<frequency DEFault>[,<amplitude> DEFault>[,<offset>]]]	322
:NOISe	[<frequency DEFault>[,<amplitude>[,<offset>]]]	323
:PULSe	[<frequency>[,<amplitude>[,<offset>]]]	324
:RAMP	[<frequency>[,<amplitude>[,<offset>]]]	325
:SINusoid	[<frequency>[,<amplitude>[,<offset>]]]	326
:SQUare	[<frequency>[,<amplitude>[,<offset>]]]	327
:USER	[<frequency>[,<amplitude>[,<offset>]]]	328

Arbitrary Commands

Command	Parameter	See Page
:DATA[1 2]	VOLATILE, <value>, <value>, ...	330
:ATTRibute		
:AVERAge?	[<arb name>]	332
:CFACTOR?	[<arb name>]	333
:POINTs?	[<arb name>]	334
:PTPeak?	[<arb name>]	335
:CATalog?		336
:COPY	<destination arb name> [,VOLATILE]	337
:DAC	VOLATILE, <binary block> <value>, <value>, ...	339
:DElete	[<arb name>]	341
:ALL		342
:MODulation	VOLATILE <value>, <value>, ...	343
:DAC	VOLATILE,<binary block> <value>, <value>, ...	344
:COPY	<destination arb name> [,VOLATILE]	345
:NVOlatile		
:CATalog?		346
:FREE?		347
:QUANTity?		348
:FORMAT		
:BORder[?]	NORMAl SWAPped	349
:FUNction[1 2]		
:MODulation		
:USER[?]	<arb name> VOLATILE	350
:USER[?]	<arb name> VOLATILE	351

Burst Commands

Command	Parameter	See Page
:BURSt		
:GATE		
:POLarity[?]	NORMal INVerted	353
:BURSt[1 2]		
:INTernal		
:PERiod[?]	<NR3> MINimum MAXimum	354
:MODE[?]	TRIGered GATed	355
:NCYCles[?]	<#cycles> MINimum MAXimum	356
:PHASE[?]	<angle>,MINimum MAXimum	357
:STATE[?]	ON OFF	358
:TRIGer[1 2]		
:COUNT[?]	<NR3> MINimum MAXimum	359
:UNIT		
:ANGLE[?]	DEGree RADian	360

Level Commands

Command	Parameter	See Page
:VOLTage[1 2]		
:AMPLitude[?]	<NR3> MINimum MAXimum	362
:HIGH[?]	<NR3> MINimum MAXimum	363
:LOW[?]	<NR3> MINimum MAXimum	364
:UNIT[?]	VPP VRMS DBM	365
:LIMit		
:HIGH[?]	<NR3> MINimum MAXimum	366
:LOW[?]	<NR3> MINimum MAXimum	367
:STATE[?]	ON OFF	368
:OFFSet[?]	<NR3> MINimum MAXimum	369
:RANGe		
:AUTO[?]	ON OFF ONCE	370

Amplitude Modulation Commands

Command	Parameter	See Page
:AM[1 2]		
:DEPT _H [?]	<NR3> MINimum MAXimum	372
:DSSCarrier[?]	ON OFF	373
:EXTernal		
:IMPedance[?]	<NR3> MINimum MAXimum	374
:RANGe[?]	<NR3> MINimum MAXimum	375
:INTernal		
:FREQuency[?]	<NR3> MINimum MAXimum	376
:FUNCTion[?]	SINusoid SQUare RAMP NRAMp TRlangle NOISe USER	377
:SOURce[?]	INTernal[1] INTernal2 EXTernal	378
:STATe[?]	ON OFF	379

Frequency Modulation Commands

Command	Parameter	See Page
:FM[1 2]		
:DEViation[?]	<NR3> MINimum MAXimum	381
:EXTernal		
:IMPedance[?]	<NR3> MINimum MAXimum	382
:RANGe[?]	<NR3> MINimum MAXimum	383
:INTernal		
:FREQuency[?]	<NR3> MINimum MAXimum	384
:FUNCTion[?]	SINusoid SQUare RAMP NRAMp TRlangle NOISe USER	385
:SOURce[?]	INTernal[1] INTernal2 EXTernal	386
:STATe[?]	ON OFF	387

Frequency Shift-Keying Modulation Commands

Command	Parameter	See Page
:FSKey[1 2]		
:EXternal		
:IMPedance[?]	<NR3> MINimum MAXimum	389
:LEVel[?]	<NR3> MINimum MAXimum	390
:RANGe[?]	<NR3> MINimum MAXimum	391
:FREQuency[?]	<NR3> MINimum MAXimum	392
:INTernal		
:RATE[?]	<NR3> MINimum MAXimum	393
:SOURce[?]	INTernal[1] INTernal2 EXTernal	394
:STATe[?]	ON OFF	395

Phase Modulation Commands

Command	Parameter	See Page
:PM[1 2]		
:DEVIation[?]	<NR3> MINimum MAXimum	397
:EXternal		
:IMPedance[?]	<NR3> MINimum MAXimum	398
:RANGe[?]	<NR3> MINimum MAXimum	399
:INTernal		
:FREQuency[?]	<NR3> MINimum MAXimum	400
:FUNCTion[?]	SINusoid SQUare RAMP NRAMp TRlangle NOISe USER	401
:SOURce[?]	INTernal[1] INTernal2 EXTernal	402
:STATe[?]	ON OFF	403

Pulse Width Modulation Commands

Command	Parameter	See Page
:PWM[1 2]		
:DEVIation[?]	<NR3> MINimum MAXimum	405
:DCYCLE[?]	<NR3> MINimum MAXimum	406
:EXTernal		
:IMPedance[?]	<NR3> MINimum MAXimum	408
:RANGe[?]	<NR3> MINimum MAXimum	409
:INTernal		
:FREQuency[?]	<NR3> MINimum MAXimum	410
:FUNCTion[?]	SINusoid SQUare RAMP NRAMp TRlangle NOISe USER	411
:SOURce[?]	INTernal[1] INTernal2 EXTernal	412
:STATe[?]	ON OFF	413

Output Commands

Command	Parameter	See Page
:CHANnel		
:MATH[?]	OFF PLUS	415
:OUTPut[1 2]	0 1 OFF ON	417
:COMPLement[?]	0 1 OFF ON	418
:IMPedance[?]	<NR3> MINimum MAXimum	419
:EXTernal[?]	<NR3> MINimum MAXimum	420
:LOAD[?]	<NR3> MINimum MAXimum	420
:POLarity[?]	NORMAL INVERTed	421
:ROUte[?]	HIVoltage HIBandwidth	422
:STRobe		
:VOLTagE[?]	TTL ECL SYM4vpp	423
:TRIGger		
:VOLTagE[?]	TTL ECL	424
:TRACk		
:CHANnel[1 2][?]	ON OFF	427
:FREQuency[?]	ON OFF	428
:DIVider[?]	<NR3> MINimum MAXimum	429
:MULTIplier[?]	<NR3> MINimum MAXimum	430

Output Function Commands

Command	Parameter	See Page
:FREQuency[1 2][?]	<NR3> MINimum MAXimum	432
:FUNction[1 2][?]	SINusoid SQUare RAMP PULSe NOISe DC USER	433
:NOISe		
:PDFunction[?]	USER PDF1 PDF2 PDF3 PDF4	434
:PULSe		
:DCYCLe[?]	<NR3> MINimum MAXimum	435
:DELay[?]	<NR3> MINimum MAXimum	
:HOLD[?]	TIME PRATio	436
:UNIT[?]	S SEC PCT DEG RAD	437

Command	Parameter	See Page
:HOLD[?]	WIDTH DCYCLE TDELAY	438
:TDELAY[?]	<NR3> MINIMUM MAXIMUM	440
:TRANSITION[?]	<NR3> MINIMUM MAXIMUM	441
:HOLD[?]	TIME WRATIO	442
:TRAILING[?]	<NR3> MINIMUM MAXIMUM	443
:AUTO[?]	OFF ON ONCE	444
:UNIT[?]	S SEC PCT	445
:WIDTH[?]	<NR3> MINIMUM MAXIMUM	446
:RAMP		
:SYMMETRY[?]	<NR3> MINIMUM MAXIMUM	447
:SQUARE		
:DCYCLE[?]	<NR3> MINIMUM MAXIMUM	448
:PERIOD[1 2][?]	<NR3> MINIMUM MAXIMUM	449
:PULSE		
:DCYCLE[1 2][?]	<NR3> MINIMUM MAXIMUM	450
:DELAY[1 2][?]	<NR3> MINIMUM MAXIMUM	451
:HOLD[?]	TIME PRATIO DEGREE	452
:UNIT[?]	S SEC PCT DEG RAD	453
:FREQUENCY[1 2][?]	<NR3> MINIMUM MAXIMUM	454
:HOLD[1 2][?]	WIDTH DCYCLE TDELAY	455
:PERIOD[1 2][?]	<NR3> MINIMUM MAXIMUM	457
:TDELAY[1 2][?]	<NR3> MINIMUM MAXIMUM	458
:TRANSITION[1 2][?]	<NR3> MINIMUM MAXIMUM	459
:HOLD[?]	TIME WRATIO	460
:TRAILING[?]	<NR3> MINIMUM MAXIMUM	461
:AUTO[?]	OFF ON ONCE	462
:UNIT[?]	S SEC PCT	463
:WIDTH[?]	<NR3> MINIMUM MAXIMUM	464

Reference Clock Commands

Command	Parameter	See Page
:ROSCillator		
:SOURce[?]	INTernal EXTernal	466
:AUTO[?]	ON OFF 0 1	467

Non Volatile Storage Commands

Command	Parameter	See Page
:MEMory		
:NSTates?		469
:STATE		
:DELeTe	1 2 3 4	470
:NAME[?]	1 2 3 4 [<name>]	471
:RECall		
:AUTO[?]	OFF ON	472
:VALid?	1 2 3 4	473
:MMEMemory		
:COpy	"<file name>"["?:"], "<copy name>"["?:"]	474
:DELeTe	"<file name>"	475
:LOAD		
:STATE	{1 2 3 4}, "<file name>"["?:"]	476
:DATA[1 2]	VOLATILE, "<file name>"["?:"]	477
:MODulation	VOLATILE, "<file name>"["?:"]	478
:STORe		
:STATE	{1 2 3 4}, "<file name>"["?:"]	479
:DATA[1 2]	VOLATILE, "<file name>"["?:"]	480
:MODulation	VOLATILE, "<file name>"["?:"]	481

Status Reporting Commands

Command	Parameter	See Page
:STATus		
:PRESet		
:QUEStionable		483
:CONDition?		484
:ENABle[?]	<NR1>	485
:EVENT?		
:NTRansition[?]	<NR1>	486
:PTRansition[?]	<NR1>	487

Sweep Commands

Command	Parameter	See Page
:FREQuency[1 2]		
:CENTer[?]	<NR3> MINimum MAXimum	489
:SPAN[?]	<NR3> MINimum MAXimum	490
:START[?]	<NR3> MINimum MAXimum	491
:STOP[?]	<NR3> MINimum MAXimum	492
:MARKer[1 2][?]	OFF ON	493
:FREQuency[?]	<frequency> MINimum MAXimum	494
:SWEep[1 2]		
:IDLE[?]	SFREquency EFRequency DC	495
:SPACing[?]	LINear LOGarithmic	496
:STATe[?]	ON OFF	497
:TIME[?]	<NR3> MINimum MAXimum	498

System Related Commands

Command	Parameter	See Page
:SYSTem		
:BEEPer		500
:STATe[?]	ON OFF	501
:DATE[?]	<years>,<month>,<day>	502
:COMMUnicate		
:RLSTate	LOCAl REMote RWLock	503
:ERRor?		504
:HELP		
:HEADer?		505
:KLOCK[?]	ON OFF	507
EXCLude[?]	NONE LOCAL	508
:PRESet		509
:SECurity[?]	ON OFF	510
:IMMediate		511
:SET[?]	<block data>	512
:TEST?	PON NORMAl ALL	513
:TIME[?]	<hours>,<minutes>,<seconds>	514
:VERSion?		515
:WARning?		516
:BUFFer?		517
:STRing?		518
:CALibration		
:ALL?		519

Display Commands

Command	Parameter	See Page
:DISPlay[?]	ON OFF	521
:TEXT[?]	<quoted string>	522
:CLEar		523

Triggering Commands

Command	Parameter	See Page
:ARM		
:FREQuency[1 2][?]	<NR3> MINimum MAXimum	525
:IMPedance[?]	<NR3> MINimum MAXimum	528
:LEVel[?]	<NR3> MINimum MAXimum	529
:PERiod[1 2][?]	<NR3> MINimum MAXimum	530
:SENSe[1 2][?]	EDGE LEVel	531
:SLOPe[?]	POSitive NEGative EITHER	532
:SOURce[1 2][?]	IMMediate INTernal[1] INTernal[2] EXTernal MANual	533
:TRIGger		534
:TRIGger[1 2]		
:SOURce[?]	IMMediate INTernal[1]	535

Pattern Related Commands

Command	Parameter	See page
:DIGital[1 2]		
[:STIMulus]		
:SIGNal:FORMat[?]	{NRZ USER}	536
[:PATTern]		
[:STATe][?]	{ON OFF}	537
:PRBS	<n>	538
:PRESet	<n>,<m>	539
:DATA	<block data>	540
:FORMat	PACKed,<nr1>	541
:SElect[?]	<name>	543
:COPY	<name> [,VOLATILE]	544
:DElete	<name>	545
:DElete:ALL	-	546
:CATalog?	-	547
:NVOlatile	-	
:CATalog?	-	548
:FREE?	-	549
:QUANtity?	-	550
:LENGth?	[<name>]	551
:NLEVels[?]	<n>	552
:LOFFset[?]	<n>	553
:TRANsition	<value>...	554
:DAC	<block data>	556
:INTerpolate	ON OFF	557
:SElect	<name>	558
:COPY	<name> [,VOLATILE]	559
:DElete	<name>	560
:DElete:ALL	<name>	561
:CATalog?		562
:TRIGger		
:MODE	BIT BLOCK	563
:SOURce	INT EXT	564

:EXTErnal	-	
:RANGe	<nr3>	565
:IMPedance	<nr3>	566
:THREshold	-	
[:LOWer][?]	<nr3>	567
:UPPer[?]	<nr3>	567
:SAMPling	AUTO FIXEd	568
:MMEMory		
:LOAD		
:PATTern	Filename	569
:TRANsition	Filename	570
:STORE	-	
:PATTern	Filename	571
:TRANsition	Filename	572

4.3 Common Command Summary

Command	Parameter	Description
*CAL?		Internal self-calibration
*CLS		Clear the Status Structure
*ESE[?]	<NR1>	Standard Event Status Register
*ESR?		Standard Event Status Event Register
*IDN?		Instrument's Identification
*LRN?		Complete Instrument Setting
*OPC		Operation Complete
*OPC[?]		Return 1
*OPT?		Installed Options

Appendix

Command	Parameter	Description
*PSC [?]		Power On Status
*RCL	0 1 2 3 4	Recall Instrument Setting
*RST		Reset
*SAV	1 2 3 4	Save Instrument Setting
*SRE [?]		Service Request Enable Mask
*STB?		Status Byte
*TRG		Software Trigger
*TST?		Start Instrument's Selftests
*WAI		Wait until all pending actions are complete

4.4 81150A / 81160A SCPI Instrument Command List Format

Introduction

The following reference sections list the instrument commands in alphabetical order. In addition to a command description, the attributes of each command are described under the following headings. Not all of these attributes are applicable to all commands. The commands conform to the IEEE 488.2 SCPI standard.

The following table presents some of the most common <suffix names> elements used while referring to some units in the instrument.

Command	Shows the short form of the command
Long	Shows the long form of the command
Parameter	The type of parameter, if any, accepted by the command. The minimum and maximum value of numeric parameters can be accessed by the option MINimum or MAXimum.
Parameter Suffix	The suffixes that may follow the parameter.
Description	A detailed description of what the command does.
Example	Example programming statements

4.5 81150A / 81160A SCPI Instrument Elements Name

Introduction

The following table presents some of the most common <suffix names> elements used while referring to some units in the instrument. The following table gives both, the short name and its expanded name for the most commonly used units.

Element	Expanded Name
DEG	Degree
HZ	Hertz
OHM	Ohm
PCT	Percent
RAD	Radian
S	Seconds
V	Volt

4.5.1 APPLy Commands

Introduction The APPLy command provides the most straightforward method to program the instrument over the remote interface. You can select the function, frequency, amplitude, and offset all in one command as shown in the syntax statement below.

```
APPLy:<function> [<frequency> [, <amplitude>
[, <offset>]]]
```

For example, the following command string sent from your computer will output a 3 V sine wave at 5 kHz with a -2.5 volt offset. APPL:SIN 5 KHZ, 3.0 V, -2.5 V.

Output Frequency For the frequency parameter of the APPLy command, the output frequency range depends on the function specified. You can substitute "MINimum", "MAXimum" or "DEFault" in place of a specific value for the frequency parameter. The "DEFault" frequency is 1kHz.

Output Amplitude For the amplitude parameter of the APPLy command, the output amplitude range depends on the function specified, the output termination and the selected amplifier type. "MINimum", "MAXimum" or "DEFault" can also be used. The "DEFault" amplitude is 1.0 Vpp (into 50Ohms) for all functions. The amplitude value will be interpreted as defined by the SCPI command: VOLT:UNIT VPP|VRMS|DBM.

DC Offset Voltage "MINimum", "MAXimum" or "DEFault" can also be used here. The default offset is 0.0 V for all functions.

APPLy Command Syntax (examples)

```
APPL:SIN 5.0e3, 3.0 ,0.0
```

```
APPL:NOIS def, 5.0, 2.0
```

```
APPL:PULS def, def, def is the same as APPL:PULS
```

```
APPL:DC def, def, -2.5
```

**APPLY command
Operations**

The APPLY command performs the following operations:

Sets the trigger source to Immediate (equivalent to sending the `ARM:SOUR IMM` command).

- Turns off any modulation, sweep, or burst mode currently enabled and places the instrument in the continuous waveform mode.
 - Turns on the Output connector (`OUTP ON` command) but does not change the output termination setting (`OUTP:LOAD` command).
 - Overrides the voltage autorange setting and automatically enables autoranging (`VOLT:RANG:AUTO` command).
 - For square waveforms, overrides the current duty cycle setting and automatically selects 50% (`FUNC:SQU:DCYC` command).
 - For ramp waveforms, overrides the current symmetry setting and automatically selects 100% (`FUNC:RAMP:SYMM` command).
-

APPLY Commands

Command :APPL[1|2]?

Long :APPLy[1|2]?

Parameters —

Parameter Suffix —

Description Query the instrument's current configuration and return a quoted string. The purpose of this command is to allow you to append this query response to an `APPL:` command in your programming application and use the result to place the instrument in the specified state. The function, frequency, amplitude, and offset are returned as shown in the sample string below (the quotation marks are returned as part of the string).

Example :APPL1?
Response:
 "SIN+5.0000000000000E+03,+3.0000000000000E+00,-
 2.5000000000000E+00"

Command	:APPL[1 2]:DC
Long	:APPLy[1 2]:DC
Parameters	[<frequency DEFault>,<amplitude> DEFault> [,<offset>]]
Parameter Suffix	–
Description	<p>Output a dc voltage with the level specified by the <i>offset</i> parameter. You can set the dc voltage to any value between ± 5 Vdc into 50 ohms or ± 10 Vdc into an open circuit or depending on the selected amplifier type. The dc voltage is output as soon as the command is executed.</p> <p>The <i>frequency</i> and <i>amplitude</i> parameters have no effect for this command but you must specify a value or “DEFault”.</p> <p>If you specify a frequency and amplitude, they have no effect on the dc output, but the values are remembered when you change to a different function.</p>
Example	:APPL:DC DEF, DEF, -2.5

Command	<code>:APPL[1 2]:NOIS</code>
Long	<code>:APPLy[1 2]:NOISe</code>
Parameters	<code>[<frequency DEFault>[,<amplitude>[,<offset>]]]</code>
Parameter Suffix	–
Description	Output Gaussian noise with the specified amplitude and dc offset. The waveform is output as soon as the command is executed. The frequency parameter has no effect for this command but you must specify a value or “DEFault”. If you specify a frequency, it has no effect on the noise output, but the value is remembered when you change to a different function.
Example	<code>:APPL:NOIS DEF, 5.0, 2.0</code>

Command	:APPL[1 2]:PULS
Long	:APPLy[1 2]:PULSe
Parameters	[<frequency>[,<amplitude>[,<offset>]]]
Parameter Suffix	–
Description	Output a pulse wave with the specified frequency, amplitude, and dc offset. The waveform is output as soon as the command is executed. This command preserves the current pulse width setting (FUNC:PULS:WIDT command) or pulse duty cycle setting (FUNC:PULS:DCYC command), depending on which has been selected to “hold” (FUNC:PULS:HOLD command). The edge time setting (FUNC:PULS:TRAN:LEAD; FUNC:PULS:TRAN:TRA command) is also preserved.
Example	:APPL:PULS 1MHz, 1.0, 0.1

Command	:APPL [1 2] :RAMP
Long	:APPLy [1 2] :RAMP
Parameters	[<frequency>[,<amplitude>[,<offset>]]]
Parameter Suffix	–
Description	Output a ramp wave with the specified frequency, amplitude, and dc offset. This command overrides the current symmetry setting and automatically selects 100%. The waveform is output as soon as the command is executed.
Example	:APPL:RAMP 4MHz, 3.42, 0.1

Appendix

Command	:APPL[1 2]:SIN
Long	:APPLy[1 2]:SINusoid
Parameters	[<frequency>[,<amplitude>[,<offset>]]]
Parameter Suffix	–
Description	Output a sine wave with the specified frequency, amplitude, and dc offset. The waveform is output as soon as the command is executed.
Example	:APPL1:SIN 120MHz, 4.2, 1.7

Command	:APPL[1 2]:SQU
Long	:APPLy[1 2]:SQUare
Parameters	[<frequency>[,<amplitude>[,<offset>]]]
Parameter Suffix	–
Description	Output a square wave with the specified frequency, amplitude, and dc offset. This command overrides the current duty cycle setting and automatically selects 50%. The waveform is output as soon as the command is executed.
Example	:APPL1:SQU 110e6, 2.4, -1.25

Appendix

Command	:APPL[1 2]:USER
Long	:APPLy[1 2]:USER
Parameters	[<frequency>[,<amplitude>[,<offset>]]]
Parameter Suffix	–
Description	Output the arbitrary waveform currently selected by the FUNC:USER command. The waveform is output using the specified frequency, amplitude, and dc offset. The waveform is output as soon as the command is executed.
Example	:APPL1:USER 3MHz, 1.2, -0.1

4.5.2 Arbitrary Waveform Commands

Introduction

Download the waveform points into volatile memory. You can download from 1 point (a dc signal) to $\text{Sample}_{\text{max}}$ points per waveform.

81150A: $\text{Sample}_{\text{max}} = 524288$ (512 k)

81160A 1 channel: $\text{Sample}_{\text{max}} = 262144$ (256 k)

81160A 2 channels: $\text{Sample}_{\text{max}} = 131072$ (128 k)

You can download the points as floating-point values, binary integer values, or decimal integer values. Use the `DATA` command to download floating-point values from -1.0 to +1.0. Use the `DATA:DAC` command to download binary integer or decimal integer values from -8191 to +8191. To ensure that binary data is downloaded properly, you must select the order in which the bytes are downloaded using the `FORM:BORD` command.

The names of the built-in arb waveforms are: `EXP_RISE`, `EXP_FALL`, `HAVERSINE`, `SINC`, `GAUSSIAN`, `CARDIAC`, and `NEG_RAMP`.

The <arb name> may contain up to 12 characters. The first character must be a letter (A-Z), but the remaining characters can be numbers (0-9) or the underscore character (" _ "). Blank spaces are not allowed. If you specify a name with more than 12 characters, a "Program mnemonic too long" error is generated.

Arbitrary Waveform Commands

Command	:DATA [1 2]
Long	:DATA [1 2]
Parameters	{VOLATILE, <value>, <value>, <value>, ...}
Parameter Suffix	—
Description	<p>Download floating-point values from -1.0 to +1.0 into volatile memory. You can download from 1 to Sample_{max} points per waveform.</p> <p>81150A: Sample_{max} = 524288 (512 k)</p> <p>81160A 1 channel: Sample_{max} = 262144 (256 k)</p> <p>81160A 2 channels: Sample_{max} = 131072 (128 k)</p> <p>The instrument takes the specified number of points and expands them to fill waveform memory. If you download less than 16 k points, a waveform with 16 k points is automatically generated. If you download more than 16 k points, a Sample_{max} points waveform is generated.</p> <p>The values -1.0 and +1.0 correspond to the peak values of the waveform (if the offset is 0.0 volts). For example, if you set the amplitude to 10.0 Vpp (0.0 V offset), “+1.0” corresponds to +5.0 V and “-1.0” corresponds to -5.0 V. The maximum amplitude will be limited if the data points do not span the full range of the output DAC (Digital-to-Analog Converter).</p> <p>Downloading floating-point values (using DATA VOLATILE) is slower than downloading binary values (using DATA:DAC VOLATILE) but is more convenient when using trigonometric functions which return values from -1.0 to +1.0.</p>

Description

The DATA command overwrites the previous waveform in volatile memory (and no error will be generated). Use the DATA:COPY command to copy the waveform to non-volatile memory.

Up to 4 user-defined waveforms can be stored in non-volatile memory. Use the DATA:DEL command to delete the waveform in volatile memory or any of the 4 user-defined waveforms in nonvolatile memory.

Use the DATA:CAT? command to list all waveforms currently stored in volatile and non-volatile memory (as well as the seven built-in waveforms).

After downloading the waveform data to memory, use the FUNC:USER command to choose the active waveform and the FUNC USER command to output it.

The Example below shows how to use the DATA command to download seven points to volatile memory.

 Whenever possible, use the binary waveform data download (refer to :DATA[1|2]:DAC on page 339) instead of a comma separated specification of the waveform as the binary download is faster than the comma separated one.

Example

```
:DATA VOLATILE, 1, .67, .33, 0, -.33, -.67, -1.
```

Command	:DATA[1 2]:ATTR:AVER?
Long	:DATA[1 2]:ATTRibute:AVERage?
Parameters	[<arb name>]
Parameter Suffix	–
Description	<p>Query the <i>arithmetic average</i> of all data points for the specified arbitrary waveform ($-1 \leq \text{average} \leq +1$). The default <i>arb-name</i> is the arbitrary waveform currently active (selected with FUNC:USER command).</p> <p>If you query a waveform that is not currently stored in memory, a “Specified arb waveform does not exist” error is generated.</p>
Example	<pre>:DATA[1:ATTR:AVER? EXP_RISE</pre> <p>Response</p> <pre>0.833275</pre>

Command	:DATA[1 2]:ATTR:CFAC?
Long	:DATA[1 2]:ATTRibute:CFACTOR?
Parameters	[<arb name>]
Parameter Suffix	–
Description	<p>Query the crest factor of all data points for the specified arbitrary waveform. Crest factor is the ratio of the peak value to the RMS value of the waveform. The default arb- name is the arbitrary waveform currently active (selected with FUNC:USER command).</p> <p>If you query a waveform that is not currently stored in memory, a “Specified arb waveform does not exist” error is generated.</p>
Example	<pre>:DATA1:ATTR:CFAC? EXP_RISE</pre> <p>Response</p> <pre>1.239349433E+01</pre>

Command	:DATA[1 2]:ATTR:POIN?
Long	:DATA[1 2]:ATTRibute:POINTs?
Parameters	[<arb name>]
Parameter Suffix	–
Description	<p>Query the number of points in the specified arbitrary waveform. Returns a value from 1 to Sample_{max} points.</p> <p>81150A: Sample_{max} = 524288 (512 k)</p> <p>81160A 1 channel: Sample_{max} = 262144 (256 k)</p> <p>81160A 2 channels: Sample_{max} = 131072 (128 k)</p> <p>The default arb-name is the arbitrary waveform currently active (selected with FUNC:USER command).</p> <p>If you query a waveform that is not currently stored in memory, a “Specified arb waveform does not exist” error is generated.</p>
Example	<pre>:DATA:ATTR:POIN? EXP_RISE Response 1.63840E+04</pre>

Command	:DATA[1 2]:ATTR:PTP?
Long	:DATA[1 2]:ATTRibute:PTPeak?
Parameters	[<arb name>]
Parameter Suffix	–
Description	<p>Query the peak-to-peak value of all data points for the specified arbitrary waveform. The default arb- name is the arbitrary waveform currently active (selected with <code>FUNC:USER</code> command). This command returns a value from “0” to “+1.0”, with “+1.0” indicating full amplitude available.</p> <p>The maximum amplitude will be limited if the data points do not span the full range of the output DAC (Digital-to-Analog Converter). For example, the built-in “Sinc” waveform does not use the full range of binary values between ± 1 and therefore its maximum amplitude is lower (into 50 ohms).</p> <p>If you query a waveform that is not currently stored in memory, a “Specified arb waveform does not exist” error is generated.</p>
Example	<pre>:DATA:ATTR:PTP? EXP_RISE</pre> <p>Response</p> <pre>1.0000E+00</pre>

Command	:DATA[1 2]:CAT?
Long	:DATA[1 2]:CATalog?
Parameters	-
Parameter Suffix	-
Description	<p>List the names of all waveforms currently available for selection. Returns the names of the seven built-in waveforms (non-volatile memory), "VOLATILE" if a waveform is currently downloaded to volatile memory, and all user-defined waveforms downloaded to non-volatile memory.</p> <p>Use the DATA:DEL command to delete the waveform in volatile memory or any of the user-defined waveforms in non-volatile memory.</p>
Example	<p>:DATA:CAT?</p> <p>Response:</p> <p>"CARDIAC", "EXP_FALL", "EXP_RISE", "GAUSSIAN", "HAVERSINE", "SINC", "VOLATILE", "TEST1"</p>

Command	:DATA[1 2]:COPY
Long	:DATA[1 2]:COPY
Parameters	{<destination arb name> [,VOLATILE]}
Parameter Suffix	–
Description	<p>Copy the waveform from volatile memory to the specified name in non-volatile memory. The source for the copy is always VOLATILE. You cannot copy from any other source and you cannot copy to VOLATILE. The arb name may contain up to 12 characters. The first character must be a letter (A-Z), but the remaining characters can be numbers (0-9) or the underscore character (“_”). Blank spaces are not allowed. If you specify a name with more than 12 characters, a “Program mnemonic too long” error is generated.</p> <p>The VOLATILE parameter is optional and can be omitted.</p> <p>✎ The keyword VOLATILE does not have a short form. The following built-in waveform names are reserved and cannot be used with the DATA: COPY command: EXP_RISE, EXP_FALL, HAVERSINE, SINC, GAUSSIAN, CARDIAC and NEG_RAMP. If you specify one of the built-in waveforms, a “Cannot overwrite a built-in waveform” error is generated.</p> <p>The instrument does not distinguish between upper- and lower-case letters. Therefore, ARB_1 and arb_1 are the same name. All characters are converted to upper case.</p>

Description

If you copy to a waveform name that already exists, the previous waveform is overwritten (and no error will be generated). However, you cannot overwrite any of the seven built-in waveforms. Up to four user-defined waveforms can be stored in non-volatile memory. If memory is full and you try to copy a new waveform to nonvolatile memory, a “Not enough memory” error is generated. Use the `DATA:DEL` command to delete the waveform in volatile memory or any of the four user-defined waveforms in non-volatile memory.

Use the `DATA:CAT?` command to list all waveforms currently stored in volatile and non-volatile memory. The default selection is `EXP_RISE`.

The Example below shows how to use the `DATA:COPY` command to copy the `VOLATILE` waveform into named storage “`ARB_1`”.

Example

```
:DATA:COPY ARB_1, VOLATILE
```

Command	:DATA [1 2] :DAC
Long	:DATA [1 2] :DAC
Parameters	{VOLATILE, <binary block> <value>, <value>, <value>, ...}
Parameter Suffix	–
Description	<p>Download binary or decimal integer values from -8191 to +8191 into volatile memory. You can download from 1 to Sample_{max} points per waveform in IEEE-488.2 binary block format or as a list of values.</p> <p>81150A: Sample_{max} = 524288 (512 k) 81160A 1 channel: Sample_{max} = 262144 (256 k) 81160A 2 channels: Sample_{max} = 131072 (128 k)</p> <p>The range of values corresponds to the values available using internal 14-bit DAC (Digital-to-Analog Converter) codes. The instrument takes the specified number of points and expands them to fill waveform memory. If you download less than 16,384 (16K) points, a waveform with 16,384 points is automatically generated. If you download more than 16,384 [16,384] points, a Sample_{max} point waveform is generated. The values -8191 and +8191 correspond to the peak values of the waveform (if the offset is 0 volts). For example, if you set the output amplitude to 10 V_{pp}, "+8191" corresponds to +5 V and "-8191" corresponds to -5 V.</p> <p>The maximum amplitude will be limited if the data points do not span the full range of the output DAC.</p> <p>The DATA : DAC command overwrites the previous waveform in volatile memory (and no error will be generated). Use the DATA : COPY command to copy the waveform to non-volatile memory.</p>

Description

Up to 4 user-defined waveforms can be stored in non-volatile memory. Use the `DATA:DEL` command to delete the waveform in volatile memory or any of the four user-defined waveforms in nonvolatile memory. Use the `DATA:CAT?` command to list all waveforms currently stored in volatile and non-volatile memory (as well as the seven built-in waveforms).

After downloading the waveform data to memory, use the `FUNC:USER` command to choose the active waveform and the `FUNC USER` command to output it.

Whenever possible, use the binary waveform data download instead of a comma separated specification of the waveform as the binary download is faster than the comma separated one.

The Example below shows how to use the `DATA:DAC` command to download integer points using the binary block format (see also appendix "Using the IEEE-488.2 Binary Block Format") and a second example shows how to use the `DATA:DAC` command to download integer points in decimal format.

Example

```
:DATA:DAC VOLATILE, #1801020304  
:DATA:DAC VOLATILE, 8187, 4098, 0, -4096, -8187
```

Command	:DATA[1 2]:DEL
Long	:DATA[1 2]:DELeTe
Parameters	{ <arb name> }
Parameter Suffix	–
Description	<p>Delete the specified arbitrary waveform from memory. You can delete the waveform in volatile memory or any of the four user-defined waveforms in non-volatile memory.</p> <p>You cannot delete the arbitrary waveform that is currently being output. If you attempt to delete this waveform, a “Not able to delete the currently selected active arb waveform” error is generated.</p> <p>You cannot delete any of the seven built-in arbitrary waveforms. If you attempt to delete one of these waveforms, a “Not able to delete a built-in arb waveform” error is generated.</p> <p>Use the DATA:DEL:ALL command to delete the waveform in volatile memory and all user-defined non-volatile waveforms all at once.</p> <p>If one of the waveforms is currently being output, a “Not able to delete the currently selected active arb waveform” error is generated.</p>
Example	:DATA:DEL ARB_1

Command	:DATA[1 2]:DEL:ALL
Long	:DATA[1 2]:DELeTe:ALL,
Parameters	-
Parameter Suffix	-
Description	<p>Delete all user-defined arbitrary waveforms from memory. This command deletes the waveform in volatile memory and all user-defined waveforms in non-volatile memory. The seven built-in waveforms in non-volatile memory are not deleted.</p> <p>The colon before the ALL parameter is required (DATA:DELeTe:ALL). If you insert a space instead of a colon, the instrument will attempt to delete an arbitrary waveform with the name "ALL". If no such waveform is stored in memory, a "Specified arb waveform does not exist" error is generated.</p> <p>Use the DATA:DEL <arb name> command to delete stored waveforms one at a time.</p> <p>You cannot delete the arbitrary waveform that is currently being output. If you attempt to delete this waveform, a "Not able to delete the currently selected active arb waveform" error is generated.</p> <p>You cannot delete any of the seven built-in arbitrary waveforms. If you attempt to delete one of these waveforms, a "Not able to delete a built-in arb waveform" error is generated.</p>
Example	:DATA2:DEL:ALL

Command	<code>:DATA[1 2]:MOD</code>
Long	<code>:DATA[1 2]:MODulation</code>
Parameters	<code>VOLATILE <value>, <value>, <value>, ...}</code>
Parameter Suffix	–
Description	Addresses the internal 16K (16384) modulation memory. It can be used to download an arbitrary waveform into the modulation memory which can be used as modulating waveform for a signal generated by the instrument. It corresponds to the <code>DATA[1 2]</code> commands which loads the <code>VOLATILE</code> memory of the instrument. For a more detailed description of the data format, refer to <code>:DATA VOLATILE</code> SCPI command or Appendix of this document.
Example	<code>:DATA:MOD VOLATILE, 0.2, 1.0, -1.0, 0.5, -0.75</code>

Command	<code>:DATA[1 2]:MOD:DAC</code>
Long	<code>:DATA[1 2]:MODulation:DAC</code>
Parameters	<code>{VOLATILE,<binary block> <value>, <value>, <value>, ...}</code>
Parameter Suffix	–
Description	Addresses the internal 16K (16384) modulation memory. It can be used to download an arbitrary waveform into the modulation memory which can be used as modulating waveform for a signal generated by the instrument. It corresponds to the <code>DATA[1 2] ...</code> and <code>DATA[1 2]:DAC ...</code> commands which loads the VOLATILE memory of the instrument. For a more detailed description of the data format, refer to <code>:DATA:DAC VOLATILE</code> SCPI command or Appendix of this document.
Example	<code>:DATA:MOD:DAC VOLATILE,#1801020304</code> <code>:DATA:MOD:DAC VOLATILE,8187, 4098, 0, -4096, -8187</code>

Command :DATA[1|2]:MOD:COPY

Long :DATA[1|2]:MODulation:COPY

Parameters <destination arb name> [,VOLATILE]

Parameter Suffix —

Description Copies the waveform from VOLATILE memory to the specified name in non-volatile memory. The source for the copy is always VOLATILE. You cannot copy from any other source and you cannot copy to VOLATILE. The arb name may contain up to 12 characters. The first character must be a letter (A-Z), but the remaining characters can be numbers (0-9) or the underscore character (" _ "). Blank spaces are not allowed. If you specify a name with more than 12 characters, a "Program mnemonic too long" error is generated.

Example :DATA:MOD:COPY ARB_1,VOLATILE

Command	:DATA[1 2]:NVOL:CAT?
Long	:DATA[1 2]:NVOLatile:CATalog?
Parameters	-
Parameter Suffix	-
Description	<p>Lists the names of all user-defined arbitrary waveforms downloaded to non-volatile memory. Returns the names of up to four waveforms. A series of quoted strings separated with commas is returned as shown in the example below. If no user-defined waveforms are currently downloaded, the command returns a null string (" ").</p> <p>Use the DATA:DEL command to delete any of the user-defined waveforms in non-volatile memory.</p>
Example	<pre>:DATA2:NVOL:CAT? Response "TEST1_ARB","TEST2_ARB","TEST3_ARB","TEST4_ARB"</pre>

Command	:DATA[1 2]:NVOL:FREE?
Long	:DATA[1 2]:NVOLatile:FREE?
Parameters	-
Parameter Suffix	-
Description	Query the number of free non-volatile memory slots available to store user-defined waveforms. Returns the number of memory slots available to store user-defined waveforms. Returns "0" (memory is full), "1", "2", "3", or "4"
Example	:DATA2:NVOL:FREE? Response 2

Command	:DATA[1 2]:NVOL:QUAN?
Long	:DATA[1 2]:NVOLatile:QUANtity?
Parameters	-
Parameter Suffix	-
Description	Query the number of total non-volatile memory slots available to store user-defined waveforms. Returns "4".
Example	:DATA2:NVOL:QUAN? Response 4

Command	:FORM:BORD [?]
Long	:FORMat :BORDER [?]
Parameters	{NORMal SWAPped}
Parameter Suffix	–
Description	<p><i>Used for binary block transfers only.</i> Select the byte order for binary transfers in the block mode using the <code>DATA : DAC</code> command. The default is <code>NORM</code>. The <code>:FORM:BORD?</code> query returns “<code>NORM</code>” or “<code>SWAP</code>”. In <code>NORM</code> byte order (default), the most-significant byte (MSB) of each data point is assumed first. In <code>SWAP</code> byte order, the least-significant byte (LSB) of each data point is assumed first. Most computers use the “swapped” byte order. The instrument represents binary data as signed 16-bit integers, which are sent as two bytes. Therefore, each waveform data point requires 16 bits, which must be transferred as two bytes on the instrument’s interfaces.</p>
Example	:FORM:BOARD NORM

Command	<code>:FUNC [1 2] :MOD:USER [?]</code>
Long	<code>:FUNction [1 2] :MODulation:USER [?]</code>
Parameters	<code>{<arb name> VOLATILE}</code>
Parameter Suffix	–
Description	<p>Select one of the seven built-in arbitrary waveforms, one of four user-defined waveforms, or the waveform currently downloaded to volatile memory. The <code>:FUNC:USER?</code> query returns either <code>EXP_RISE</code>, <code>EXP_FALL</code>, <code>HAVERSINE</code>, <code>SINC</code>, <code>CARDIAC</code>, <code>VOLATILE</code>, <code>GAUSSIAN</code>, <code>NEG_RAMP</code> or the name of any user-defined waveforms in non-volatile memory.</p> <p>✎ This command does not activate the selected arbitrary waveform. Use the e.g. <code>FM:INT:FUNC USER</code> command to activate the usage of the modulation memory (16k).</p> <p>The names of the seven built-in arbitrary waveforms are: <code>EXP_RISE</code>, <code>EXP_FALL</code>, <code>HAVERSINE</code>, <code>SINC</code>, <code>GAUSSIAN</code>, <code>CARDIAC</code> and <code>NEG_RAMP</code>.</p> <p>To select the waveform currently stored in volatile modulation memory, specify the <code>VOLATILE</code> parameter. The keyword <code>VOLATILE</code> does not have a short form.</p> <p>If you select a waveform name that is not currently downloaded, a “Specified arb waveform does not exist” error is generated.</p> <p>The instrument does not distinguish between upper- and lower-case letters. Therefore, <code>ARB_1</code> and <code>arb_1</code> are the same name. All characters are converted to upper case.</p>
Example	<code>:FUNC2:MOD:USER exp_rise</code>

Command	<code>:FUNC [1 2] :USER [?]</code>
Long	<code>:FUNction[1 2]:USER[?]</code>
Parameters	{<arb name> VOLATILE}
Parameter Suffix	–
Description	<p>Select one of the seven built-in arbitrary waveforms, one of the four user-defined waveforms, or the waveform currently downloaded to volatile memory. The <code>:USER?</code> query returns <code>EXP_RISE</code>, <code>EXP_FALL</code>, <code>HAVERSINE</code>, <code>SINC</code>, <code>CARDIAC</code>, <code>VOLATILE</code>, <code>GAUSSIAN</code>, <code>NEG_RAMP</code> or the name of any user-defined waveforms in non-volatile memory.</p> <p>✎ This command does not output the selected arbitrary waveform. Use the <code>FUNC USER</code> command to output the selected waveform.</p> <p>The names of the seven built-in arbitrary waveforms are: <code>EXP_RISE</code>, <code>EXP_FALL</code>, <code>HAVERSINE</code>, <code>SINC</code>, <code>CARDIAC</code>, <code>VOLATILE</code>, <code>GAUSSIAN</code>, <code>NEG_RAMP</code>.</p> <p>To select the waveform currently stored in volatile memory, specify the <code>VOLATILE</code> parameter. The keyword <code>VOLATILE</code> does not have a short form.</p> <p>If you select a waveform name that is not currently downloaded, a “Specified arb waveform does not exist” error is generated.</p> <p>The instrument does not distinguish between upper- and lower-case letters. Therefore, <code>ARB_1</code> and <code>arb_1</code> are the same name. All characters are converted to upper case.</p> <p>Use the <code>DATA:CAT?</code> command to list the names of the seven built-in waveforms (non-volatile).</p> <p><code>VOLATILE</code> if a waveform is currently downloaded to volatile memory, and the names of any user-defined waveforms (non-volatile).</p>
Example	<code>:FUNC1:USER VOLATILE</code>

4.5.3 Burst Commands

Introduction

A burst is a certain number of cycles generated by the instrument on a single event. The burst of a cycle can be triggered by an internal or external trigger signal. When the gated burst mode is selected, the last 'Burst' of cycles will always be completed.

Burst Commands

Command	:BURS:GATE:POL[?]
Long	:BURSt:GATE:POLarity[?]
Parameters	{NORMal INVerted}
Parameter Suffix	—
Description	Selects whether the instrument uses true-high or true-low logic levels on the externally-gated burst. It corresponds with :ARM:SLOP POS NEG command. Application recommendation: Use :ARM:SLOP
Example	:BURS:GATE:POL NEG

Appendix

Command	:BURS [1 2] :INT:PER[?]
Long	:BURSt [1 2] :INTernal:PERiod[?]
Parameters	{<NR3> MINimum MAXimum}
Parameter Suffix	HZ
Description	Set the burst period for internally-triggered bursts. The burst period defines the time from the start on one burst to the start of the next burst. It corresponds with the :ARM:PERiod or :ARM:FREQ command.
Example	:BURS:INT:PER 10MHZ

Command	:BURS [1 2] :MODE [?]
Long	:BURSt [1 2] :MODE [?]
Parameters	{TRIGgered GATed}
Parameter Suffix	—
Description	Sets trigger on the edge or gate level at the external input. It corresponds with the :ARM:SENS EDGE LEV command. . Application recommendation: Use :ARM:SENS
Example	:BURS1:MODE TRIG

Appendix

Command	<code>:BURS[1 2]:NCYC[?]</code>
Long	<code>:BURSt[1 2]:NCYCles[?]</code>
Parameters	<code>{<#cycles> MINimum MAXimum}</code>
Parameter Suffix	–
Description	<code>:TRIGger[1 2]:COUNT</code> and <code>:BURSt:NCYCles</code> set the number of triggered periods to be generated per arm event. <code>:TRIGger:COUNT > 1</code> is the short form of <code>:BURSt:NCYCles</code> and <code>:BURSt:STATe</code> . In other words for example <code>:TRIGger:COUNT 3</code> set the <code>BURSt:STATe</code> to <code>ON</code> and <code>:BURSt:NCYCles</code> to <code>3</code> .
Example	<code>:BURS2:NCYC 200</code>

Command	<code>:BURS [1 2] :PHAS [?]</code>
Long	<code>:BURSt [1 2] :PHASe [?]</code>
Parameters	{<angle>, MINimum MAXimum}
Parameter Suffix	–
Description	<p>The burst phase defines the starting phase of the burst.</p> <p>Burst phase: -360.0 degrees to +360.0 degrees. The default is 0 degree.</p> <p>From the remote interface, you can set the starting phase in degrees or radians using the <code>UNIT:ANGL</code> command.</p> <p>From the front panel, the starting phase is always displayed in degrees (radians are not available). If you set the starting phase in radians from the remote interface and then return to front-panel operation, you will see that the instrument converts the phase to degrees.</p> <p>For sine waveform, 0 degrees is the point at which the waveform crosses zero volts (or the dc offset value) in a positive going direction. For arbitrary waveforms, 0 degrees is the first waveform point downloaded to memory.</p> <p>The burst phase has no effect on pulse, noise, square and ramp waveforms.</p> <p>The burst phase is also used in the gated burst mode. When the gate signal goes false, the current waveform cycle is completed and then the instrument stops. The output will remain at the voltage level corresponding to the starting burst phase.</p>
Example	<code>:BURS:PHAS 211.2</code>

Command	:BURS[1 2]:STAT[?]
Long	:BURSt[1 2]:STATe[?]
Parameters	{ON OFF}
Parameter Suffix	–
Description	<p>:TRIGger[1 2]:COUNT and :BURSt[1 2]:NCYCles set the number of triggered periods to be generated per arm event. :TRIGger:COUNT > 1 is the short form of :BURSt:NCYCles and :BURST:STATe. In other words for example :TRIGger:COUNT 3 set the BURSt:STATe to ON and :BURTs:NCYCles to 3.</p>
Example	:BURS2:STAT ON

Command	:TRIG[1 2]:COUN[?]
Long	:TRIGger[1 2]:COUNT[?]
Parameters	{<NR3> MINimum MAXimum}
Parameter Suffix	–
Description	<p>:TRIGger[1 2]:COUNT and :BURSt[1 2]:NCYCles set the number of triggered periods to be generated per arm event. :TRIGger:COUNT > 1 is the short form of :BURSt:NCYCles and :BURST:STATe. In other words for example :TRIGger:COUNT 3 set the BURSt:STATe to ON and :BURTs:NCYCles to 3.</p>
Example	:TRIG:COUN 17

Appendix

Command	:UNIT[1 2]:ANGL[?]
Long	:UNIT[1 2]:ANGLe[?]
Parameters	{DEGree RADian}
Parameter Suffix	–
Description	<p>Select degrees or radians to set the phase offset value (remote interface only). The default is DEG. The :ANGL? query returns “DEG” or “RAD”.</p> <p>From the front panel, the phase offset is always displayed in degrees (radians are not available). If you set the phase offset in radians from the remote interface and then return to front-panel operation, you will see that the instrument converts the phase offset to degrees.</p>
Example	:UNIT:ANGL RAD

4.5.4 Level Commands

Introduction

The following SCPI command subsystem specifies all the commands to change amplitude, offset, high-level and low-level of a signal to be output. The Amplitude can be specified as VPP, VRMS, dBm.

Level Commands

Command	<code>:VOLTage[1 2]</code>
Long	<code>[:SOURCE] :VOLTage[1 2]</code> <code>[:LEVel] [:IMMediate] [:AMPLitude]</code>
Parameters	<code>{<NR3> MINimum MAXimum}</code>
Parameter Suffix	VPP, VRMS, DBM, V
Description	Set the output amplitude. MIN selects the smallest amplitude MAX selects the largest amplitude for the selected function. The <code>:VOLT[1 2]:UNIT</code> command specifies the unit the amplitude will be interpreted (VPP, VRMS or DBM).
Example	<code>:VOLT2 4.12</code>

Command	<code>:VOLT[1 2]:HIGH[?]</code>
Long	<code>[:SOURCE] :VOLTage[1 2] [:LEVel] [:IMMediate] :HIGH[?]</code>
Parameters	<code>{<NR3> MINimum MAXimum}</code>
Parameter Suffix	V
Description	Set the high voltage level. MIN selects the most negative voltage level for the selected function and MAX selects the largest voltage level.
Example	<code>:VOLT2:HIGH 1.33</code>

Appendix

Command	<code>:VOLT[1 2]:LOW[?]</code>
Long	<code>[:SOURCE] :VOLTage[1 2] [:LEVel] [:IMMediate] :LOW[?]</code>
Parameters	<code>{<NR3> MINimum MAXimum}</code>
Parameter Suffix	V
Description	Set the low voltage level. MIN selects the most negative voltage level for the selected function and MAX selects the largest voltage level.
Example	<code>:VOLT1:LOW -1.2</code>

Command	<code>:VOLT[1 2]:UNIT[?]</code>
Long	<code>[:SOURCE] :VOLTagE[1 2] [:LEVel] [:IMMediate] :UNIT[?]</code>
Parameters	{VPP VRMS DBM}
Parameter Suffix	–
Description	Selects the unit for output amplitude (does not affect offset voltage or high/low levels. The default is Vpp. The <code>:VOLT:UNIT?</code> Query returns “VPP”, “VRMS” or “DBM”.
Example	<code>:VOLT2:UNIT VPP</code>

Command	<code>:VOLT[1 2]:LIM[?]</code>
Long	<code>[:SOURCE] :VOLTage[1 2] :LIMit [:HIGH] [?]</code>
Parameters	<code>{ <NR3> MINimum MAXimum }</code>
Parameter Suffix	V
Description	<p>It's used to set/read the high-level voltage limit. If you switch on voltage limiting, the high-level voltage cannot be set above the programmed limits.</p> <p></p> <ul style="list-style-type: none"> • The voltage is not limited by the output hardware, it's a software limit. • The limits relate to the HIGH and LOW parameters of the instrument.
Example	<code>:VOLT:LIM 2.00</code>

Command	<code>:VOLTage[1 2]:LIM:LOW[?]</code>
Long	<code>[:SOURCE] :VOLTage[1 2] :LIMit:LOW[?]</code>
Parameters	{<NR3> MINimum MAXimum}
Parameter Suffix	V
Description	<p>It's used to set/read the low-level voltage limit. If you switch on voltage limiting, the low-level voltage cannot be set below the programmed limit.</p> <p></p> <ul style="list-style-type: none">• The voltage is not limited by the output hardware, it's a software limit.• The limits relate to the HIGH and LOW parameters of the instrument.
Example	<code>:VOLT2:LIM:LOW -2.4</code>

Appendix

Command	<code>:VOLT[1 2]:LIM:STAT[?]</code>
Long	<code>[:SOURCE] :VOLTage[1 2]:LIMit:STATe[?]</code>
Parameters	{OFF ON}
Parameter Suffix	–
Description	This command switches the output limits on or off. When you switch on the output levels cannot be programmed beyond the programmed limits, until you switch off the voltage limits. The limits apply whether you program high/low levels or amplitude/offset levels.
Example	<code>:VOLT2:LIMit:STAT ON</code>

Command	<code>:VOLT[1 2]:OFFS[?]</code>
Long	<code>[:SOURce] :VOLTage[1 2] [:LEVEl] [:IMMediate] :OFFSet[?]</code>
Parameters	<code>{<NR3> MINimum MAXimum}</code>
Parameter Suffix	V
Description	Set the output offset. MIN selects the smallest offset MAX selects the largest possible offset
Example	<code>:VOLT2:OFFS 0.0</code>

Command	<code>:VOLT[1 2]:RANG:AUTO[?]</code>
Long	<code>[:SOURCE] :VOLTagE[1 2] [:LEVel] [:IMMediate] :RANGe:AUTO</code>
Parameters	<code>{ON OFF ONCE}</code>
Parameter Suffix	—
Description	<p>Disable or enable voltage autoranging for all functions. In the default mode, autoranging is enabled (“ON”) and the instrument automatically selects the optimal settings for the output amplifier and attenuators. With autoranging disabled (“OFF”), the instrument uses the current amplifier and attenuator settings. The <code>:AUTO?</code> Query returns “0” (OFF) or “1” (ON).</p> <p>The <code>APPLY</code> command overrides the voltage autorange setting and automatically enables autoranging (“ON”).</p> <p>The advantage of disabling autoranging is to eliminate momentary disruptions caused by switching of the attenuators while changing amplitude. However, the amplitude and offset accuracy and resolution (as well as waveform fidelity) may be adversely affected when reducing the amplitude below the expected range change.</p> <p>The “ONCE” parameter has the same effect as turning autoranging “ON”, and then “OFF”. This parameter allows you to make a one-time change to the amplifier/attenuator setting before returning to the OFF setting.</p>
Example	<code>:VOLT:RANG:AUTO ONCE</code>

4.5.5 Modulation Commands

Amplitude Modulation (AM) Commands

Introduction

A modulated waveform consists of a carrier waveform and a modulating waveform. In AM, the amplitude of the carrier is varied by the instantaneous voltage of the modulating waveform. The instrument will accept an internal or external modulation source.

Command	:AM[1 2]:DEPT[?]
Long	[:SOURCE] :AM[1 2] :DEPT h [?]
Parameters	{<NR3> MINimum MAXimum}
Parameter Suffix	PCT
Description	<p>Set the internal modulation depth (or “percent modulation”) in percent. Select from 0% to 120%. The default is 100%. MIN = 0%. MAX = 120%. The :AM[1 2]:DEPT? query returns the modulation depth in percent. Note that even at greater than 100% depth, the instrument will not exceed hardware limits on the output (into a 50Ω load). If you select the External modulating source (AM:SOUR EXT command), the carrier waveform is modulated with an external waveform. The modulation depth is controlled by the ±5V signal level present on the rear-panel Modulation In connector. For example, if you have set the modulation depth to 100% using the AM:DEPT command, then when the modulating signal is at +5 volts, the output will be at the maximum amplitude. When the modulating signal is at -5 volts, then the output will be at the minimum amplitude.</p>
Example	:AM1:DEPT 10PCT

Command	:AM[1 2]:DSSC[?]
Long	[:SOURCE] :AM[1 2] :DSSCarrier[?]
Parameters	{ON OFF}
Parameter Suffix	–
Description	<p>Double-sideband suppressed carrier (DSSC) AM can be performed with or without carrier suppression.</p> <p>DSSC = OFF</p> $u(t) = \frac{1}{2} \cdot \left(1 + \frac{\text{ModulationDepth}}{100\%} \cdot u_{\text{mod}}(t) \right) \cdot u_{\text{carrier}}(t)$ <p>DSSC = ON</p> $u(t) = u_{\text{mod}}(t) \cdot u_{\text{carrier}}(t)$
Example	:AM1:DSSC OFF

Command	<code>:AM[1 2]:EXT:IMP[?]</code>
Long	<code>[:SOURCE] :AM[1 2] :EXTeRnal :IMPedance [?]</code>
Parameters	<code>{ <NR3> MINimum MAXimum }</code>
Parameter Suffix	OHM
Description	Specifies the impedance of the modulation input. If you try to program any other value, it will be rounded to one of the specified values, 50Ω or 10kΩ.
Example	<code>:AM1:EXT:IMP 50</code>

Command	<code>:AM[1 2]:EXT:RANG[?]</code>
Long	<code>[:SOURCE] :AM[1 2] :EXTernal:RANGe[?]</code>
Parameters	{<NR3> MINimum MAXimum}
Parameter Suffix	V
Description	<p>Specifies the voltage range of the modulation input. If you try to program any other value, it will be rounded to one of the specified values, either 2.5V or 5V.</p> <p>Setting the input voltage range to 2.5/5 selects $\pm 2.5V/\pm 5V$ as full range input voltage range.</p>
Example	<code>:AM1:EXT:RANG 5</code>

Command	:AM[1 2]:INT:FREQ[?]
Long	[:SOURCE] :AM[1 2] :INTernal:FREQuency[:CW :FIXed] [?]
Parameters	{<NR3> MINimum MAXimum}
Parameter Suffix	HZ
Description	Set the frequency of the modulating waveform. Used only when the Internal modulation source is selected (AM[1 2]:SOUR INT command). The AM[1 2]:FREQ? query returns the internal modulating frequency in Hertz. It doesn't apply if "INT2" is selected.
Example	:AM1:INT:FREQ 8MHZ

Command	<code>:AM[1 2]:INT:FUNC[?]</code>
Long	<code>[:SOURCE] :AM[1 2] :INTernal :FUNction[:SHAPE] [?]</code>
Parameters	{SINusoid SQUare RAMP NRAMp TRIangle NOISe USER}
Parameter Suffix	–
Description	<p>Select the shape of the modulating waveform. Used only when the Internal modulation source is selected (<code>AM[1 2]:SOUR INT</code> command). You can use noise as the modulating waveshape, but you cannot use noise, pulse, or dc as the carrier waveform. The default is SIN. The <code>:AM[1 2]:FUNC?</code> Query returns "SIN", "SQU", "RAMP", "NRAM", "TRI", "NOIS", "USER".</p> <ul style="list-style-type: none"> • Select "SQU" for a square waveform with a 50% duty cycle. • Select "RAMP" for a ramp waveform with 100% symmetry. • Select "TRI" for a ramp waveform with 50% symmetry. • Select "NRAM" (negative ramp) for a ramp waveform with 0% symmetry. <p>If you select an arbitrary waveform as the modulating waveshape ("USER"), the waveform is automatically limited to 16K (16384) points. Extra waveform points are removed using decimation.</p>
Example	<code>:AM1:INT:FUNC USER</code>

Command	<code>:AM[1 2]:SOUR[?]</code>
Long	<code>[:SOURCE] :AM[1 2] :SOURce [?]</code>
Parameters	{INTernal[1] INTernal2 EXTernal}
Parameter Suffix	–
Description	<p>Select the source of the modulating signal. The instrument will accept an internal or external modulation source. The default is <code>INT[1]</code>. The <code>:AM[1 2]:SOUR?</code> query returns “INT” or “INT2” or “EXT”. <code>INT</code> selects an internal modulation signal and <code>INT2</code> selects the other channel of the instrument (if available) If you select the <code>EXTernal</code> source, the carrier waveform is modulated with an external waveform. The modulation depth is controlled by the $\pm 2.5V/\pm 5V$ signal level present on the rear-panel Modulation In connector. For example, if you have set the modulation depth to 100% using the <code>:AM[1 2]:DEPT</code> command, then when the modulating signal is at +2.5/+5 Volts, the output will be at the maximum amplitude. When the modulating signal is at -2.5/-5 Volts, then the output will be at the minimum amplitude.</p> <p>If you select the other channel as the modulation waveshape (“INT2”) the SCPI command <code>:AM[1 2]:INT:FREQ</code> doesn’t apply.</p>
Example	<code>:AM1:SOUR EXT</code>

Command	<code>:AM[1 2]:STAT[?]</code>
Long	<code>[:SOURCE] :AM[1 2] :STATe[?]</code>
Parameters	{ON OFF}
Parameter Suffix	–
Description	<p>Disable or enable AM. To avoid multiple waveform changes, you can enable AM after you have set up the other modulation parameters. The default is OFF. The <code>AM[1 2]:STAT?</code> query returns “0” (OFF) or “1” (ON). The instrument will allow only one modulation mode to be enabled at a time. For example, you cannot enable AM and FM at the same time. When you enable AM, the previous modulation mode is turned off. The instrument will not allow AM to be enabled at the same time that sweep or burst is enabled. When you enable AM, the sweep or burst mode is turned off.</p>
Example	<code>:AM1:STAT ON</code>

Frequency Modulation (FM) Commands

Introduction

A modulated waveform consists of a carrier waveform and a modulating waveform. In FM, the frequency of the carrier is varied by the instantaneous voltage of the modulating waveform.

Command	<code>:FM[1 2]:DEV[?]</code>
Long	<code>[:SOURCE] :FM[1 2] :DEViation[?]</code>
Parameters	{<NR3> MINimum MAXimum}
Parameter Suffix	HZ
Description	<p>Set the peak frequency deviation in Hertz. This value represents the peak variation in frequency of the modulated waveform from the carrier frequency. The <code>:PM[1 2]:DEV?</code> query returns the deviation in Hertz. The carrier frequency must always be greater than or equal to the deviation.</p> <p>If you attempt to set the deviation to a value greater than the carrier frequency (with FM enabled), the instrument will automatically adjust the deviation to the maximum value allowed with the present carrier frequency. From the remote interface, a "Data out of range" error will be generated and the deviation will be adjusted as described.</p> <p>If you select the External modulating source (<code>FM[1 2]:SOUR EXT</code> command), the deviation is controlled by the $\pm 2.5V/\pm 5V$ signal level present on the rear panel Modulation In connector.</p> <p>For example, if you have set the frequency deviation to 100 kHz, then a $+2.5V/+5V$ signal level corresponds to a 100 kHz increase in frequency. Lower external signal levels produce less deviation and negative signal levels reduce the frequency below the carrier frequency.</p>
Example	<code>:FM2:DEV 1111HZ</code>

Appendix

Command	<code>:FM[1 2]:EXT:IMP[?]</code>
Long	<code>[:SOURCE] :FM[1 2] :EXTernal :IMPedance [?]</code>
Parameters	<code>{<NR3> MINimum MAXimum}</code>
Parameter Suffix	<code>OHM</code>
Description	Specifies the impedance of the modulation input. If you try to program any other value, it will be rounded to one of the specified values, either 50Ω or 10kΩ.
Example	<code>:FM2:EXT:IMP 50OHM</code>

Command	<code>:FM[1 2]:EXT:RANG[?]</code>
Long	<code>[:SOURCE] :FM[1 2] :EXTernal:RANGe[?]</code>
Parameters	<code>{<NR3> MINimum MAXimum}</code>
Parameter Suffix	–
Description	<p>Specifies the voltage range of the modulation input. If you try to program any other value, it will be rounded to one of the specified values, either 2.5V or 5V.</p> <p>Setting the input voltage range to 2.5/5 selects $\pm 2.5V/\pm 5V$ as full range input voltage range.</p>
Example	<code>:FM2:EXT:RANG 5.0</code>

Command	<code>:FM[1 2]:INT:FREQ[?]</code>
Long	<code>[:SOURCE] :FM[1 2] :INTernal:FREQuency[:CW :FIXed] [?]</code>
Parameters	<code>{<NR3> MINimum MAXimum}</code>
Parameter Suffix	HZ
Description	Set the frequency of the modulating waveform. Used only when the Internal modulation source is selected (FM[1 2]:SOUR INT command). The :FM[1 2]:INT:FREQ? query returns the internal modulating frequency in Hertz. It doesn't apply if "INT2" is selected.
Example	<code>:FM2:INT:FREQ 20KHZ</code>

Command	<code>:FM[1 2]:INT:FUNC[?]</code>
Long	<code>[:SOURCE] :FM[1 2] :INTernal :FUNction[?]</code>
Parameters	{SINusoid SQUare RAMP NRAMp TRIangle NOISe USER}
Parameter Suffix	–
Description	<p>Select the shape of the modulating waveform. Used only when the Internal modulation source is selected (<code>FM[1 2]:SOUR INT</code> command). You can use noise as the modulating waveshape, but you cannot use noise, pulse, or dc as the carrier waveform. The default is SIN. The <code>:FM[1 2]:INT:FUNC?</code> Query returns "SIN", "SQU", "RAMP", "NRAM", "TRI", "NOIS" or "USER".</p> <ul style="list-style-type: none"> • Select "SQU" for a square waveform with a 50% duty cycle. • Select "RAMP" for a ramp waveform with 100% symmetry. • Select "TRI" for a ramp waveform with 50% symmetry. • Select "NRAM" (negative ramp) for a ramp waveform with 0% symmetry. <p>If you select an arbitrary waveform as the modulating waveshape ("USER"), the waveform is automatically limited to 16K (16384) points. Extra waveform points are removed using decimation.</p>
Example	<code>:FM2:INT:FUNC TRI</code>

Command	<code>:FM[1 2]:SOUR[?]</code>
Long	<code>[:SOURCE] :FM[1 2] :SOURce [?]</code>
Parameters	{INTernal[1] INTernal2 EXTernal}
Parameter Suffix	–
Description	<p>Select the source of the modulating signal. The instrument will accept an INTernal or EXTernal modulation source. The default is INT[1]. The <code>:FM[1 2]:SOUR?</code> query returns "INT" or "INT2" or "EXT".</p> <p>INT[1] selects an internal modulation signal and INT2 selects the other channel of the instrument (if available). If you select the External source, the carrier waveform is modulated with an external waveform. The frequency deviation is controlled by the $\pm 2.5/\pm 5V$ signal level present on the rear-panel Modulation In connector. For example, if you have set the deviation to 100 kHz using the <code>FM[1 2]:DEV</code> command, then a +2.5/+5V signal level corresponds to a 100 kHz increase in frequency. Lower external signal levels produce less deviation and negative signal levels reduce the frequency below the carrier frequency.</p> <p>If you select the other channel as the modulation waveshape ("INT2") the SCPI command <code>:FM[1 2]:INT:FREQ</code> doesn't apply.</p>
Example	<code>:FM2:SOUR EXT</code>

Command	<code>:FM[1 2]:STAT[?]</code>
Long	<code>[:SOURCE] :FM[1 2] :STATe[?]</code>
Parameters	{ON OFF}
Parameter Suffix	—
Description	<p>Disable or enable FM. To avoid multiple waveform changes, you can enable FM after you have set up the other modulation parameters. The default is OFF. The <code>:FM[1 2]:STAT?</code> query returns “0” (OFF) or “1” (ON). The instrument will allow only one modulation mode to be enabled at a time. For example, you cannot enable FM and AM at the same time. When you enable FM, the previous modulation mode is turned off. The instrument will not allow FM to be enabled at the same time that sweep or burst is enabled. When you enable FM, the sweep or burst mode is turned off.</p>
Example	<code>:FM2:STAT ON</code>

Frequency-Shift Keying Modulation (FSK) Commands

Introduction

You can configure the instrument to “shift” its output frequency between two preset values using FSK modulation. The rate at which the output shifts between the two frequencies (called the “carrier frequency” and the “hop frequency”) is determined by the internal rate generator or the signal level on the rear-panel Modulation - In connector.

Command	:FSKey[1 2]:EXT:IMP[?]
Long	[:SOURCE] :FSKey[1 2] :EXTernal :IMPedance[?]
Parameters	{<NR3> MINimum MAXimum}
Parameter Suffix	OHM
Description	Specifies the impedance of the modulation input. If you try to program any other value, it will be rounded to one of the specified values, either 50Ω or 10kΩ.
Example	:FSK1:EXT:IMP 50

Appendix

Command	<code>:FSKey[1 2]:EXT:LEV[?]</code>
Long	<code>[:SOURCE] :FSKey[1 2] :EXTernal :LEVel[?]</code>
Parameters	<code>{<NR3> MINimum MAXimum}</code>
Parameter Suffix	V
Description	Defines the 'decision' threshold used to select the 'carrier' frequency or the 'hop' frequency.
Example	<code>:FSK1:EXT:LEV 1.0</code>

Command	<code>:FSKey[1 2]:EXT:RANG[?]</code>
Long	<code>[:SOURCE] :FSKey[1 2] :EXTernal :RANGe [?]</code>
Parameters	{<NR3> MINimum MAXimum}
Parameter Suffix	V
Description	<p>Specifies the voltage range of the modulation input. If you try to program any other value, it will be rounded to one of the specified values, either 2.5V or 5V.</p> <p>Setting the input voltage range to 2.5/5 selects $\pm 2.5V/\pm 5V$ as full range input voltage range.</p>
Example	<code>:FSK1:EXT:RANG 5.0</code>

Appendix

Command	:FSKey[1 2]:FREQ[?]
Long	[:SOURCE] :FSKey[1 2] :FREQuency[:CW :FIXed] [?]
Parameters	{ <NR3> MINimum MAXimum }
Parameter Suffix	HZ
Description	Set the FSK alternate (or “hop”) frequency. The :FSK[1 2]:FREQ? Query returns the “hop” frequency in Hertz.
Example	:FSK1:FREQ 5MHZ

Command	<code>:FSKey[1 2]:INT:RATE[?]</code>
Long	<code>[:SOURCE] :FSKey[1 2] :INTernal:RATE [?]</code>
Parameters	{<NR3> MINimum MAXimum}
Parameter Suffix	HZ
Description	Set the rate at which the output frequency “shifts” between the carrier and hop frequency. The <code>:FSK[1 2]:RATE?</code> query returns the FSK rate in Hertz. The FSK rate is only used when the Internal source is selected (<code>FSK[1 2]:SOUR INT</code> command) and is ignored when the external source is selected (<code>FSK:SOUR[1 2] EXT</code> command)
Example	<code>:FSK1:INT:RATE 10HZ</code>

Command	<code>:FSKey[1 2]:SOURCE[?]</code>
Long	<code>[:SOURCE] :FSKey[1 2] :SOURCE[?]</code>
Parameters	{INTernal[1] INTernal2 EXTernal}
Parameter Suffix	–
Description	<p>Select an INTernal or EXTernal FSK source. The default is INT[1]. The <code>:FSK[1 2]:SOUR?</code> query returns "INT", "INT2" or "EXT". When the INTernal1 source is selected, the rate at which the output frequency "shifts" between the carrier frequency and hop frequency is determined by the FSK rate specified (<code>FSK:INT:RATE</code> command). INT2 selects the other channel of the instrument (if available). When the External source is selected, the output frequency is determined by the signal level on the rear-panel Modulation-In connector. When a logic low level is present, the carrier frequency is output. When a logic high level is present, the hop frequency is output.</p> <p>If you select the other channel as the modulation waveshape ("INT2") the SCPI command <code>FSK[1 2]:INT:RATE</code> doesn't apply.</p>
Example	<code>:FSK1:SOUR EXT</code>

Command	<code>:FSK[1 2]:STAT[?]</code>
Long	<code>[:SOURCE] :FSKey[1 2] :STATe[?]</code>
Parameters	{ON OFF}
Parameter Suffix	–
Description	<p>Disable or enable FSK modulation. To avoid multiple waveform changes, you can enable FSK after you have set up the other modulation parameters. The default is OFF. The <code>:FSK1:STAT?</code> query returns “0” (OFF) or “1” (ON). The instrument will allow only one modulation mode to be enabled at a time. For example, you cannot enable FSK and AM at the same time. When you enable FSK, the previous modulation mode is turned off. The instrument will not allow FSK to be enabled at the same time that sweep or burst is enabled. When you enable FSK, the sweep or burst mode is turned off.</p>
Example	<code>:FSK1:STAT ON</code>

Phase Modulation (PM) Commands

Introduction

A modulated waveform consists of a carrier waveform and a modulating waveform. PM is very similar to FM, but in PM the phase of the modulated waveform is varied by the instantaneous voltage of the modulating waveform.

Command	<code>:PM[1 2]:DEV[?]</code>
Long	<code>[:SOURCE] :PM[1 2] :DEViation[?]</code>
Parameters	{<NR3> MINimum MAXimum}
Parameter Suffix	DEG
Description	<p>Set the phase deviation in degrees. This value represents the peak variation in phase of the modulated waveform from the carrier waveform. Select any value from 0 to 360 degrees. The default is 180 degrees. MIN = 0 degrees. MAX = 360 degrees. The <code>:PM[1 2]:DEV?</code> query returns the phase deviation in degrees. If you select the External modulating source (<code>PM[1 2]:SOUR EXT</code> command), the deviation is controlled by the $\pm 2.5V/\pm 5V$ signal level present on the rear panel Modulation In connector. For example, if you have set the frequency deviation to 180 degrees, then a $+2.5V/+5V$ signal level corresponds to a 180 degree phase deviation. Lower external signal levels produce less deviation, and negative signal levels produce a negative phase shift.</p>
Example	<code>:PM:DEV 110</code>

Command	:PM[1 2]:EXT:IMP[?]
Long	[:SOURCE] :PM[1 2] :EXTernal :IMPedance [?]
Parameters	{<NR3> MINimum MAXimum}
Parameter Suffix	OHM
Description	Specifies the impedance of the modulation input. If you try to program any other value, it will be rounded to one of the specified values, either 50Ω or 10kΩ.
Example	:PM:EXT:IMP 50

Command	<code>:PM[1 2]:EXT:RANG[?]</code>
Long	<code>[:SOURCE] :PM[1 2] :EXTernal:RANGe[?]</code>
Parameters	{<NR3> MINimum MAXimum}
Parameter Suffix	–
Description	<p>Specifies the voltage range of the modulation input. If you try to program any other value, it will be rounded to one of the specified values, either 2.5V or 5V.</p> <p>Setting the input voltage range to 2.5/5 selects $\pm 2.5\text{V}/\pm 5\text{V}$ as full range input voltage range.</p>
Example	<code>:PM:EXT:RANG 5.0</code>

Command	<code>:PM[1 2]:INT:FREQ[?]</code>
Long	<code>[:SOURCE] :PM[1 2] :INTernal:FREQuency[:CW :FIXed] [?]</code>
Parameters	{<NR3> MINimum MAXimum}
Parameter Suffix	HZ
Description	Set the frequency of the modulating waveform. Used only when the Internal modulation source is selected (PM[1 2]:SOUR INT command). The <code>:PM[1 2]:INT:FREQ?</code> query returns the internal modulating frequency in Hertz. It doesn't apply if "INT2" is selected.
Example	<code>:PM:INT:FREQ 1.2 MHZ</code>

Command	<code>:PM[1 2]:INT:FUNC[?]</code>
Long	<code>[:SOURCE]:PM[1 2]:INTernal:FUNction[:SHApe][?]</code>
Parameters	{SINusoid SQUare RAMP NRAMp TRIangle NOISe USER}
Parameter Suffix	–
Description	<p>Select the shape of the modulating waveform. Used only when the Internal modulation source is selected (<code>PM[1 2]:SOUR INT</code> command). You can use noise as the modulating waveshape, but you cannot use noise, pulse, or dc as the carrier waveform. The default is <code>SIN</code>. The <code>:PM[1 2]:INT:FUNC?</code> Query returns “SIN”, “SQU”, “RAMP”, “NRAM”, “TRI”, “NOIS” or “USER”.</p> <ul style="list-style-type: none"> • Select “SQU” for a square waveform with a 50% duty cycle. • Select “RAMP” for a ramp waveform with 100% symmetry • Select “TRI” for a ramp waveform with 50% symmetry. • Select “NRAM” (negative ramp) for a ramp waveform with 0% symmetry. <p>If you select an arbitrary waveform as the modulating waveshape (“USER”), the waveform is automatically limited to 16K (16384) points. Extra waveform points are removed using decimation.</p>
Example	<code>:PM:INT:FUNC RAMP</code>

Command	:PM[1 2]:SOUR[?]
Long	[:SOURCE] :PM[1 2] :SOURce [?]
Parameters	{INTernal[1] INTernal2 EXTernal}
Parameter Suffix	–
Description	<p>Select the source of the modulating signal. The instrument will accept an INTernal or EXTernal modulation source. The default is INT[1]. The :PM[1 2]:SOUR? query returns "INT" or "INT2" or "EXT".</p> <p>INT[1] selects an internal modulation signal and INT2 selects the other channel of the instrument (if available). If you select the External source, the carrier waveform is modulated with an external waveform. The phase deviation is controlled by the $\pm 2.5V/\pm 5V$ signal level present on the rear-panel Modulation In connector. For example, if you have set the phase deviation to 180 degrees using the PM:DEV command, then a +2.5V/+5V signal level corresponds to a 180 degree phase deviation. Lower external signal levels produce less deviation, and negative signal levels produce a negative phase shift.</p> <p>If you select the other channel as the modulation waveshape ("INT2") the SCPI command :PM[1 2]:INT:FREQ doesn't apply.</p>
Example	:PM:SOUR:EXT

Command	<code>:PM[1 2]:STAT[?]</code>
Long	<code>[:SOURCE] :PM[1 2] :STATe[?]</code>
Parameters	{ON OFF}
Parameter Suffix	–
Description	<p>Disable or enable PM. To avoid multiple waveform changes, you can enable PM after you have set up the other modulation parameters. The default is OFF. The <code>:PM[1 2]:STAT?</code> query returns “0” (OFF) or “1” (ON). The instrument will allow only one modulation mode to be enabled at a time. For example, you cannot enable PM and AM at the same time. When you enable PM, the previous modulation mode is turned off. The instrument will not allow PM to be enabled at the same time that sweep or burst is enabled. When you enable PM, the sweep or burst mode is turned off.</p>
Example	<code>:PM:STAT ON</code>

Pulse Width Modulation (PWM) Commands

Introduction

In Pulse Width Modulation (PWM), the width of a pulse waveform is varied by the instantaneous voltage of the modulating waveform. The width of the pulse can be expressed either as a pulse width (expressed in time units, like the period) or a duty cycle (expressed as a percentage of the period). The instrument will accept an internal or external modulation source.

Command	<code>:PWM[1 2]:DEV[?]</code>
Long	<code>[:SOURCE] :PWM[1 2] :DEViation[?]</code>
Parameters	{<NR3> MINimum MAXimum}
Parameter Suffix	S
Description	<p>Set the pulse width deviation in seconds. This value represents the variation in width (in seconds) from the pulse width of the carrier pulse waveform. The <code>:PWM[1 2]:DEV?</code> query returns the pulse width deviation in seconds.</p> <ul style="list-style-type: none"> • The pulse width deviation cannot exceed the current pulse width. • The pulse width deviation is also limited by the minimum pulse width. <p>If you select the External modulating source (<code>PWM[1 2]:SOUR EXT</code> command), the deviation is controlled by the $\pm 2.5V/\pm 5V$ signal level present on the rear-panel <i>Modulation In</i> connector. For example, if you have set the width deviation to 10 μs, then a +2.5V/+5V signal level corresponds to a 10 μs deviation. Lower external signal levels produce less deviation, and negative signal levels produce negative deviation.</p> <p> The operation of the <code>PWM[1 2]:DEV</code> command is affected by the <code>FUNC[1 2]:PULS:HOLD</code> command. The <code>FUNC:PULS:HOLD</code> command determines whether pulse width (the default) or pulse duty cycle values are to be held constant as the period is varied. If the width is held, so is the width deviation. If the duty cycle is held, so is the duty cycle deviation. If duty cycle and duty cycle deviation are being held, width deviation values specified with the <code>PWM[1 2]:DEV</code> command are automatically converted to the equivalent duty cycle deviation in percent.</p>
Example	<code>:PWM:DEV 100ns</code>

Command	:PWM[1 2]:DEV:DCYC[?]
Long	[:SOURCE] :PWM[1 2] :DEViation :DCYCLE[?]
Parameters	{<NR3> MINimum MAXimum}
Parameter Suffix	PCT
Description	<p>Set the duty cycle deviation in percent (percent of period). This value represents the peak variation in duty cycle from the duty cycle of the underlying pulse waveform. For example, if duty cycle is 10% and duty cycle deviation is 5%, the duty cycle of the modulated waveform will vary from 5% to 15%. The default is 1 percent. MIN is approximately 0%. MAX is approximately 100% (limited by the period, minimum pulse width, and edge time). The :PWM[1 2]:DEV:DCYC? query returns the duty cycle deviation in percent.</p> <ul style="list-style-type: none"> • The duty cycle deviation cannot exceed the current pulse duty cycle. • The duty cycle deviation is also limited by the minimum pulse width. <p>If you select the External modulating source (PWM[1 2]:SOUR EXT command), the deviation is controlled by the $\pm 2.5V/\pm 5V$ signal level present on the rear-panel <i>Modulation In</i> connector. For example, if you have set the duty cycle deviation to 5 percent, a +2.5V/+5V signal level corresponds to a 5 percent deviation, that is an additional 5% of period added to the pulse duty cycle. Lower external signal levels produce less deviation, and negative signal levels reduce the duty cycle.</p>

Description

The operation of the `PWM[1|2]:DEV:DCYC` command is affected by the `FUNC[1|2]:PULS:HOLD` command. The `FUNC:PULS:HOLD` command determines whether pulse width (the default) or pulse duty cycle values are to be held constant as the period is varied. If the width is held, so is the width deviation. If the duty cycle is held, so is the duty cycle deviation. If pulse width and width deviation are being held, duty cycle deviation values specified with the `PWM[1|2]:DEV:DCYC` command are automatically converted to the equivalent width deviation in seconds.

Example

```
:PWM:DEV:DCYC 10.1 PCT
```

Appendix

Command	<code>:PWM[1 2]:EXT:IMP[?]</code>
Long	<code>[:SOURCE] :PWM[1 2] :EXTernal :IMPedance [?]</code>
Parameters	<code>{<NR3> MINimum MAXimum}</code>
Parameter Suffix	<code>OHM</code>
Description	Specifies the impedance of the modulation input. If you try to program any other value, it will be rounded to one of the specified values, either 50Ω or 10kΩ.
Example	<code>:PWM:EXT:IMP 50 OHM</code>

Command	<code>:PWM[1 2]:EXT:RANG[?]</code>
Long	<code>[:SOURCE] :PWM[1 2] :EXTernal :RANGe [?]</code>
Parameters	{<NR3> MINimum MAXimum}
Parameter Suffix	V
Description	<p>Specifies the input voltage range of the modulation input. If you try to program any other value, it will be rounded to one of the specified values, either 2.5V or 5V.</p> <p>Setting the input voltage range to 2.5/5 selects $\pm 2.5V/\pm 5V$ as full range input voltage range.</p>
Example	<code>:PWM:EXT:RANG 10.0V</code>

Command	:PWM[1 2]:INT:FREQ[?]
Long	[:SOURCE] :PWM[1 2] :INTernal :FREQuency [:CW :FIXed] [?]
Parameters	{<NR3> MINimum MAXimum}
Parameter Suffix	HZ
Description	Set the frequency of the modulating waveform. Used only when the Internal modulation source is selected (PWM[1 2]:SOUR INT command). The :PWM[1 2]:INT:FREQ? query returns the internal modulating frequency in Hertz. It does not apply if "INT2" is selected.
Example	:PWM:INT:FREQ 5.5 MHZ

Command	<code>:PWM[1 2]:INT:FUNC[?]</code>
Long	<code>[:SOURCE] :PWM[1 2] :INTernal :FUNction[:SHAPE] [?]</code>
Parameters	{SINusoid SQUare RAMP NRAMp TRIangle NOISe USER}
Parameter Suffix	–
Description	<p>Select the shape of the modulating waveform. Used only when the Internal modulation source is selected (<code>PWM[1 2]:SOUR INT</code> command). (The carrier must be a pulse waveform for PWM.) The default is SIN. The <code>:PWM[1 2]:INT:FUNC?</code> query returns "SIN", "SQU", "RAMP", "NRAM", "TRI", "NOIS" or "USER".</p> <ul style="list-style-type: none"> • Select "SQU" for a square waveform with a 50% duty cycle. • Select "RAMP" for a ramp waveform with 100% symmetry. • Select "TRI" for a ramp waveform with 50% symmetry. • Select "NRAM" (negative ramp) for a ramp waveform with 0% symmetry. <p>If you select an arbitrary waveform as the modulating waveshape ("USER"), the waveform is automatically limited to 16K (16384) points. Extra waveform points are removed using decimation.</p>
Example	<code>:PWM:INT:FUNC NOIS</code>

Command	:PWM[1 2]:SOUR[?]
Long	[:SOURCE] :PWM[1 2] :SOURce [?]
Parameters	{INTernal[1] INTernal2 EXTernal}
Parameter Suffix	–
Description	<p>Select the source of the modulating signal. The instrument will accept an INTernal or EXTernal modulation source. The default is INT[1]. The :PWM[1 2]:SOUR? query returns "INT" or "INT2" or "EXT".</p> <p>INT[1] selects an internal modulation signal and INT2 selects the other channel of the instrument (if available). If you select the External source, the carrier waveform is modulated with an external waveform. The pulse width or pulse duty cycle deviation is controlled by the $\pm 2.5V/\pm 5V$ signal level present on the rear panel <i>Modulation In</i> connector. For example, if you have set the pulse width deviation to 50 μs using the PWM:DEV command, then a +2.5V/+5V signal level corresponds to a 50 μs width increase. Lower external signal levels produce less deviation.</p> <p>If you select the other channel as the modulation waveshape ("INT2") the SCPI command :PWM[1 2]:INT:FREQ doesn't apply.</p>
Example	:PWM:SOUR EXT

Command	<code>:PWM[1 2]:STAT[?]</code>
Long	<code>[:SOURCE] :PWM[1 2] :STATe[?]</code>
Parameters	{ON OFF}
Parameter Suffix	–
Description	<p>Disable or enable PWM. To avoid multiple waveform changes, you can enable PWM after you have set up the other modulation parameters. The default is OFF. The <code>:PWM[1 2]:STAT?</code> query returns “0” (OFF) or “1” (ON). The instrument will allow only one modulation mode to be enabled at a time. For example, you cannot enable PWM and AM at the same time. When you enable PWM, the previous modulation mode is turned off. The instrument will not allow PWM to be enabled at the same time that sweep or burst is enabled. When you enable PWM, the sweep or burst mode is turned off. PWM is allowed only when pulse is the selected function.</p>
Example	<code>:PWM:STAT OFF</code>

4.5.6 Channel Command

Introduction

The channel command is used to enable or disable channel addition in an instrument with two channel installed. With the `:CHAN:MATH PLUS` command, the signals from both channels are added at Output 1. Output 2 provides its signal further on. This allows you to, for example, generate 3 or 4 level signals, simulate single and repeated glitches, simulate overshoot and undershoot.

Channel Commands

Command	:CHAN:MATH [?]
Long	:CHANnel:MATH [?]
Parameters	{OFF PLUS}
Parameter Suffix	—
Description	It is used to enable or disable channel addition in an instrument with two channel installed. The output signal generated by channel 2 will be added to the signal of channel 1. The corresponding signal will be provided by channel 1.
Example	:CHAN:MATH PLUS

4.5.7 Output Commands

Introduction

The SCPI OUTPut subsystem controls the characteristics of the source's outputs.

Output Commands

Command	:OUT [1 2] [?]
Long	:OUTput [1 2] [:NORMal] [:STATe] [?]
Parameters	{0 1 OFF ON}
Parameter Suffix	—
Description	<p>Disable or enable the corresponding front-panel Output connector. The default is "OFF". When the output is enabled, the corresponding key is illuminated on the instrument's front panel. The <code>OUTP[1 2]?</code> query returns "0" (OFF) or "1" (ON).</p> <p>The <code>APPLY</code> command overrides the current <code>OUTP</code> command setting and automatically enables the Output connector ("ON").</p> <p>If an excessive external voltage is applied to the front-panel Output connector, an error message will be displayed and the output will be disabled. To re-enable the output, remove the overload from the Output connector and send the <code>OUTP[1 2] ON</code> command.</p>
Example	OUTP2 ON

Appendix

Command	:OUTP[1 2]:COMP[?]
Long	:OUTPut[1 2]:COMPLement[:STATe][?]
Parameters	{0 1 OFF ON}
Parameter Suffix	–
Description	Disable or enable the corresponding front-panel Output (complement) connector. The default is OFF. See <code>OUTPut[1 2]:STATe</code> for more information.
Example	:OUTP2:COMP ON

Command	<code>:OUTP[1 2]:IMP[?]</code>
Long	<code>:OUTPut[1 2]:IMPedance[:INTernal][?]</code>
Parameters	{<NR3> MAXimum MINimum}
Parameter Suffix	OHM
Description	<p>It's used to program the source impedance of the output connector.</p> <ul style="list-style-type: none">• There are only two settings available. If you try to program any other value, it will be rounded to one of the specified values, either 50Ω or 5Ω.
Example	<code>:OUTP2:IMP MAX</code>

Command	<code>:OUTP[1 2]:IMP:EXT[?]</code> <code>:OUTP[1 2]:LOAD[?]</code>
Long	<code>:OUTPut[1 2]:IMPedance:EXTernal[?]</code> <code>:OUTPut[1 2]:LOAD[?]</code>
Parameters	{<NR3> MAXimum MINimum}
Parameter Suffix	OHM
Description	These two SCPI commands address the same instrument parameter. To be compatible with other instrument from Keysight, both commands were implemented. Select the desired output termination (i.e., the impedance of the load attached to the output of the instrument). The specified value is used for amplitude, offset, and high/low level settings. You can set the load to any value from 0.3Ω to 1MΩ. MIN selects from 0.3Ω MAX selects 1MΩ. The default is 50Ω.
Example	<code>:OUTP1:LOAD 50</code>

Command	<code>:OUTP[1 2]:POL[?]</code>
Long	<code>:OUTPut[1 2][:NORMal]:POLarity[?]</code>
Parameters	{NORMal INVerted}
Parameter Suffix	–
Description	Invert the waveform relative to the offset voltage. In the normal mode (default), the waveform goes positive during the first part of the cycle. In the inverted mode, the waveform goes negative during the first part of the cycle. The <code>:OUP[1 2]:POL?</code> query returns “NORM” or “INV”. The waveform is inverted relative to the offset voltage. Any offset voltage present will remain unchanged when the waveform is inverted.
Example	<code>:OUTP2:POL?</code> Response: INV

Appendix

Command	:OUTP[1 2]:ROUT[?]
Long	:OUTPut[1 2]:ROUte[:SElect][?]
Parameters	{HIVoltage HIBandwith}
Parameter Suffix	–
Description	Choose from the two available amplifier types: <ul style="list-style-type: none">• First type (HIVoltage) runs 0 MHz – 50 MHz / $\pm 10V$• The second type (HIBandwidth) runs 0 MHz– 240 MHz / $\pm 5V$.
Example	:OUP2:ROUT HIB

Command	:OUTP[1 2]:STR:VOLT[?]
Long	:OUTPut[1 2]:STRobe:VOLTag[?]
Parameters	{TTL ECL SYM4vpp}
Parameter Suffix	–
Description	Specifies the output voltage of the strobe output of the selected channel.
Example	:OUP2:STR:VOLT TTL

Command	:OUTP[1 2]:TRIG:VOLT[?]
Long	:OUTPut[1 2]:TRIGger:VOLTage[?]
Parameters	{TTL ECL}
Parameter Suffix	–
Description	Specifies the output voltage of the trigger output of the selected channel.
Example	:OUTP2:TRIG:VOLT ECL

Command	<code>:OUTPut [1:2]:STRobe:ROUte [?]</code>
Long	<code>:OUTPut [1:2]:STRobe:ROUte</code>
Parameters	<code>{ NONE SYNA SYNB SYNAB }</code>
Parameter Suffix	–
Description	This command is routing the strobe functionality from output N to the given sync connector.
Example	<code>:OUTPUT1:STROBE:ROUTE SYNB</code>

Appendix

Command	<code>:OUTPut [1:2]:TRIGger:ROUte [?]</code>
Long	<code>:OUTPut [1:2]:TRIGger:ROUte</code>
Parameters	<code>{ NONE SYNA SYNb SYNAB }</code>
Parameter Suffix	–
Description	This command is routing the trigger functionality from output N to the given sync connector.
Example	<code>:OUTPUT1:TRIGGER:ROUTE SYNA</code>

Command	:TRAC:CHAN[1 2][?]
Long	[:SOURce] :TRACk:CHANnel [1 2][?]
Parameters	{ON OFF}
Parameter Suffix	–
Description	<p>:TRAC:CHAN1 ON couples both channels; copies all values from channel 1 to channel 2; switches tracking state ON.</p> <p>:TRAC:CHAN2 ON couples both channels; copies all values from channel 2 to channel 1; switches tracking state ON.</p> <p>:TRAC:CHAN[1 2] OFF decouples both channel.</p>
Example	:TRAC:CHAN1 ON

Appendix

Command	:TRAC:FREQ[?]
Long	[:SOURce] :TRACk:FREQuency [:STATe] [?]
Parameters	{ON OFF}
Parameter Suffix	–
Description	Switches frequency coupling on to generate sub-rates of channel one's frequency at the output connector of channel two.
Example	:TRAC:FREQ ON

Command	:TRAC:FREQ:DIV[?]
Long	[:SOURce] :TRACk:FREQuency:DIVider[?]
Parameters	{<NR3> MINimum MAXimum}
Parameter Suffix	–
Description	Specifies the divider of the 'frequency quotient' of channel two's frequency. Range 1 – 255
Example	:TRAC:FREQ:DIV 4

Appendix

Command	:TRAC:FREQ:MULT [?]
Long	[:SOURce] :TRACk:FREQuency:MULTiplier [?]
Parameters	{ <NR3> MINimum MAXimum }
Parameter Suffix	–
Description	Specifies the multiplier of the ‘frequency quotient’ of channel two’s frequency. Range 1 – 255
Example	:TRAC:FREQ:MULT 8

4.5.8 Output Function Commands

Introduction

This section describes the low-level commands used to program the instrument. Although the APPLy commands provide the most straightforward method to program the instrument, the 'low-level' commands give you more flexibility to change individual parameters. Based on the characteristics of the instrument, i.e. combining the two instruments (pulse generator and function generator) into one, some parameters can be changed in two different ways. One command set based on the function generator concept, and the other command set based on the pulse generator concept to change electrical parameters of signals. To minimize the effort for test program designer, the instrument accepts both command types for the same parameters wherever applicable.

Output Function Commands

Command	<code>:FREQ[1 2][?]</code>
Long	<code>[:SOURce] :FREQuency [1 2] [:CW :FIXed] [?]</code>
Parameters	{<NR3> MINimum MAXimum}
Parameter Suffix	HZ
Description	Set the output frequency. The <code>:FREQ[1 2]?</code> query returns the frequency setting in Hertz for the function currently selected. MIN selects the lowest actual possible frequency allowed for the selected function. MAX selects the highest actual possible frequency allowed.
Example	<code>:FREQ 1.234MHZ</code>

Command	:FUNC [1 2] [?]														
Long	[:SOURce] :FUNction [1 2] [:SHAPe] [?]														
Parameters	{SINusoid SQUare RAMP PULSe NOISe DC USER}														
Parameter Suffix	–														
Description	<p>Select the output function. The selected waveform is output using the previously selected frequency, amplitude, and offset voltage settings. The FUNC [1 2] ? query returns "SIN", "SQU", "RAMP", "PULS", "NOIS", "DC", or "USER" (without "'")</p> <p>If you select "USER", the instrument outputs the arbitrary waveform currently selected by the FUNC [1 2] :USER command.</p> <table border="0"> <tr> <td>SINusoid</td> <td>Output a sine wave</td> </tr> <tr> <td>SQUare</td> <td>Output a square wave</td> </tr> <tr> <td>RAMP</td> <td>Output a ramp wave</td> </tr> <tr> <td>PULSe</td> <td>Output a pulse wave</td> </tr> <tr> <td>NOISe</td> <td>Output Gaussian noise</td> </tr> <tr> <td>DC</td> <td>Output a dc voltage</td> </tr> <tr> <td>USER</td> <td>Output the arbitrary waveform</td> </tr> </table>	SINusoid	Output a sine wave	SQUare	Output a square wave	RAMP	Output a ramp wave	PULSe	Output a pulse wave	NOISe	Output Gaussian noise	DC	Output a dc voltage	USER	Output the arbitrary waveform
SINusoid	Output a sine wave														
SQUare	Output a square wave														
RAMP	Output a ramp wave														
PULSe	Output a pulse wave														
NOISe	Output Gaussian noise														
DC	Output a dc voltage														
USER	Output the arbitrary waveform														
Example	:FUNC1 SIN														

Command	:FUNC [1 2] :NOIS:PDF [?]										
Long	[:SOURce] :FUNction [1 2] :NOISe:PDFunction [?]										
Parameters	{USER PDF1 PDF2 PDF3 PDF4}										
Parameter Suffix	–										
Description	<p>Selects a Probability Density Function (PDF) that specifies a Gaussian distribution of amplitude values in the memory.</p> <p>The following table shows how the above-mentioned parameters match to the pre-defined crest factors of noise.</p> <table border="1"> <thead> <tr> <th>Parameter</th> <th>Indicates a crest factor of...</th> </tr> </thead> <tbody> <tr> <td>PDF1</td> <td>3.1</td> </tr> <tr> <td>PDF2</td> <td>4.8</td> </tr> <tr> <td>PDF3</td> <td>6.0</td> </tr> <tr> <td>PDF4</td> <td>7.0</td> </tr> </tbody> </table>	Parameter	Indicates a crest factor of...	PDF1	3.1	PDF2	4.8	PDF3	6.0	PDF4	7.0
Parameter	Indicates a crest factor of...										
PDF1	3.1										
PDF2	4.8										
PDF3	6.0										
PDF4	7.0										
Example	:FUNC2:NOIS PDF4										

Command	<code>:FUNC [1 2] :PULS:DCYC [?]</code>
Long	<code>[:SOURce] :FUNction [1 2] :PULSe:DCYClE [?]</code>
Parameters	{<NR3> MINimum MAXimum}
Parameter Suffix	PCT
Description	<p>Set the pulse duty cycle in percent. The pulse duty cycle is defined as: Duty Cycle = 100 X Pulse Width ÷ Period where the pulse width represents the time from the start of the rising edge of the pulse to the start of the next falling edge. The pulse duty cycle range is 0 percent to 100 percent. However, the pulse duty cycle is limited by the minimum pulse width and edge time restrictions, which prevent you from setting exactly 0 percent or 100 percent.</p> <p>✎ This command is affected by the <code>:PULS:HOLD [1 2]</code> command, which determines the value to be held constant as the period is adjusted: the specified pulse width value, or the specified pulse duty cycle value, or the specified trailing delay. See the <code>:PULS:HOLD [1 2]</code> command for further information.</p>
Example	<code>:FUNC2:PULS:DCYC 10PCT</code>

Command	:FUNC [1 2] :PULS:DEL:HOLD [?]	
Long	[:SOURce] :FUNction [1 2] :PULSe:DElAy:HOLD [?]	
Parameters	{TIME PRATio DEGREE}	
Parameter Suffix	-	
Description	Set the coupling between the pulse period and the pulse delay.	
	TIME	The absolute pulse delay is held fixed when the pulse period is varied.
	PRATio	The pulse delay (delay as ratio of period) is held fixed when the pulse period is varied.
	DEGREE	Holds the delay in degrees fixed.
Example	:FUNC1:PULS:DEL:HOLD TIME	

Command	<code>:FUNC [1 2] :PULS:DEL:UNIT [?]</code>
Long	<code>[:SOURce] :FUNction [1 2] :PULSe:DELay:UNIT [?]</code>
Parameters	<code>{S SEC PCT DEG RAD}</code>
Parameter Suffix	–
Description	It is used to set the default unit for the pulse-delay parameter. The default unit of a parameter is the unit used when the parameter is programmed to a value without a unit suffix.
Example	<code>:FUNC2 :PULS:DEL:UNIT PCT</code>

Command	:FUNC [1 2] :PULS:HOLD [?]	
Long	[:SOURce] :FUNction[1 2] :PULSe:HOLD [?]	
Parameters	{WIDTh DCYClE TDELay}	
Parameter Suffix	–	
Description	Set instrument to hold either pulse width or pulse duty cycle or trailing delay:	
	WIDTh	<p>The instrument holds the pulse width setting (in seconds) constant as the period is varied. (Minimum width and edge time restrictions apply.)</p> <p>If a command to set a duty cycle value is received, the duty cycle is converted to the equivalent pulse width in seconds. If Pulse Width Modulation (PWM) is turned on, the pulse width is held, and the width deviation also is held, as the period is varied. Duty cycle deviation commands are converted to width deviation values.</p>
	DCYClE	<p>The instrument holds the pulse duty cycle setting (in percent) constant as the period is varied. (Minimum width and edge time restrictions apply.)</p> <p>If a command to set a pulse width value is received, the width is converted to the equivalent duty cycle in percent. If Pulse Width Modulation (PWM) is turned on, the pulse duty cycle is held, and the duty cycle deviation also is held, as the period is varied. Width deviation commands are converted to duty cycle deviation values.</p>
	TDEL	<p>The instrument holds the trailing delay setting (in seconds) constant as the period is varied. (Minimum width and edge time restrictions apply.)</p>

The `:PULS:HOLD[1|2]` command does not limit period settings. The physical limits of the width are not exceeded.

Example

```
:FUNC2:PULS:HOLD DCYC
```

Command	<code>:FUNC [1 2] :PULS:TDEL [?]</code>
Long	<code>[:SOURce] :FUNction [1 2] :PULSe:TDELay [?]</code>
Parameters	<code>{<NR3> MINimum MAXimum}</code>
Parameter Suffix	S
Description	<p>Set the delay of the trailing edge of the pulse relative to start of pulse period. This is an alternative method of programming pulse width.</p> <p>✎ This command is affected by the <code>:PULS:HOLD [1 2]</code> command, which determines the value to be held constant as the period is adjusted: the specified pulse width value, or the specified pulse duty cycle value, or specifies the trailing delay. See the <code>:PULS:HOLD [1 2]</code> command for further information.</p>
Example	<code>:FUNC2:PULS:TDEL 50.8NS</code>

Command	<code>:FUNC [1 2] :PULS:TRAN[?]</code>
Long	<code>[:SOURCE] :FUNction [1 2] :PULSe:TRANsition [:Leading] [?]</code>
Parameters	{<NR3> MINimum MAXimum}
Parameter Suffix	S
Description	<p>Set the edge time in seconds for the leading edges. The edge time represents the time from the 10% threshold to the 90% threshold of each edge. The <code>:FUNC [1 2] :PULS:TRAN?</code> query returns the edge time in seconds.</p> <p>The specified edge time must fit within the specified pulse width.</p>
Example	<code>:FUNC2:PULS:TRAN 6.7NS</code>

Appendix

Command	<code>:FUNC [1 2] :PULS:TRAN:HOLD [?]</code>				
Long	<code>[:SOURce] :FUNction [1 2] :PULSe:TRANsition:HOLD [?]</code>				
Parameters	<code>{TIME WRATio}</code>				
Parameter Suffix	—				
Description	<p>It's used to set the coupling between transition times and the pulse width.</p> <table><tr><td><code>TIME</code></td><td>The absolute transition times are held when the pulse width is varied.</td></tr><tr><td><code>WRATio</code></td><td>The ratio of transition time to pulse width is held when the pulse width is varied.</td></tr></table>	<code>TIME</code>	The absolute transition times are held when the pulse width is varied.	<code>WRATio</code>	The ratio of transition time to pulse width is held when the pulse width is varied.
<code>TIME</code>	The absolute transition times are held when the pulse width is varied.				
<code>WRATio</code>	The ratio of transition time to pulse width is held when the pulse width is varied.				
Example	<code>:FUNC2:PULS:TRAN:HOLD TIME</code>				

Command	<code>:FUNC [1 2] :PULS :TRAN :TRA [?]</code>
Long	<code>[:SOURce] :FUNction [1 2] :PULSe :TRANsition : TRAIling [?]</code>
Parameters	<code>{ <NR3 > MINimum MAXimum }</code>
Parameter Suffix	<code>S</code>
Description	Set the edge time in seconds for the trailing edges. The edge time represents the time from the 90% threshold to the 10% threshold of each edge. The <code>:FUNC [1 2] PULS :TRAN :TRA ?</code> query returns the edge time in seconds.
Example	<code>:FUNC2 :PULS :TRAN :TRA 12.4NS</code>

Command	:FUNC [1 2] :PULS :TRAN :TRA :AUTO [?]
Long	[:SOURCE] :FUNction [1 2] :PULSe :TRANsition :TRAIling : AUTO [?]
Parameters	{OFF ON ONCE}
Parameter Suffix	–
Description	<p>It's used to set the automatic coupling of the pulse-trailing-edge transition time to the leading-edge transition time.</p> <p>ON The trailing-edge transition time is automatically set to the same value as the leading edge and is updated automatically each time the leading-edge transition time changes.</p> <p>OFF The trailing-edge/leading-edge transition time is independently programmable.</p> <p>ONCE The trailing-edge transition time is set ONCE to the same value as the leading edge.</p>
Example	:FUNC2 :PULS :TRAN :TRA :AUTO ON

Command	<code>:FUNC [1 2] :PULS:TRAN:UNIT [?]</code>
Long	<code>[:SOURce] :FUNction [1 2] :PULSe:TRANsition:UNIT [?]</code>
Parameters	<code>{S SEC PCT}</code>
Parameter Suffix	–
Description	Use this command to set the default units for the pulse transition-times. The default unit is used when the parameter is programmed to a value without a unit suffix.
Example	<code>:FUNC2 :PULS:TRAN:UNIT PCT</code>

Command	<code>:FUNC [1 2] :PULS:WIDT [?]</code>
Long	<code>[:SOURce] :FUNction [1 2] :PULSe:WIDTh [?]</code>
Parameters	<code>{ <NR3> MINimum MAXimum }</code>
Parameter Suffix	S
Description	<p>✎ Set the pulse width in seconds. The pulse width represents the time from the start of rising edge of the pulse to the start of the next falling edge. The <code>:FUNC [1 2] :PULS:WIDT?</code> query returns the pulse width in seconds.</p> <p>✎ This command is affected by the <code>:FUNC [1 2] :PULS:HOLD</code> command, which determines the value to be held constant as the period is adjusted: the specified pulse width value, or the specified pulse duty cycle value, or the specifies trailing delay. See the <code>:FUNC [1 2] :PULS:HOLD</code> command for further information.</p>
Example	<code>:FUNC2:PULS:WIDT 21.5NS</code>

Command	<code>:FUNC [1 2] :RAMP:SYMM[?]</code>
Long	<code>[:SOURce] :FUNction [1 2] :RAMP:SYMMetry [?]</code>
Parameters	<code>{<NR3> MINimum MAXimum}</code>
Parameter Suffix	PCT
Description	<p>Set the symmetry percentage for ramp waves. Symmetry represents the amount of time per cycle that the ramp wave is rising (assuming that the waveform polarity is not inverted). You can set the symmetry to any value from 0% to 100%. The default is 100%. MIN = 0%. MAX = 100%. The <code>:SYMM?</code> query returns the current symmetry setting in percent.</p> <p>For ramp waveforms, the <code>APPLY</code> command overrides the current symmetry setting and automatically selects 100%.</p> <p>The symmetry setting is remembered when you change from ramp wave to another function. When you return to the ramp wave function, the previous symmetry is used. If you select a ramp waveform as the modulating waveform for AM or FM, the symmetry setting does not apply.</p>
Example	<code>:FUNC2:RAMP:SYMM 23.8PCT</code>

Command	<code>:FUNC [1 2] :SQU:DCYC [?]</code>
Long	<code>[:SOURce] :FUNction [1 2] :SQUare :DCYCl e [?]</code>
Parameters	{<NR3> MINimum MAXimum}
Parameter Suffix	PCT
Description	<p>Set the duty cycle percentage for square waves. Duty cycle represents the amount of time per cycle that the square wave is at a high level (assuming that the waveform polarity is not inverted). The default is 50%. MIN selects the minimum duty cycle for the selected frequency and MAX selects the maximum duty cycle. The <code>:FUNC [1 2] :SQU:DCYC?</code> query returns the current duty cycle setting in percent.</p> <p>For square waveforms, the APPLy command overrides the current duty cycle setting and automatically selects 50%. The duty cycle setting is remembered when you change from square wave to another function. When you return to the square wave function, the previous duty cycle is used.</p> <p>If you select a square waveform as the modulating waveform for AM or FM, the duty cycle setting does not apply. The instrument always uses a square waveform with a 50% duty cycle.</p>
Example	<code>:FUN2 :SQU:DCYC 23.3PCT</code>

Command	<code>:PER[1 2][?]</code>
Long	<code>[:SOURce] :PERiod[1 2][?]</code>
Parameters	{<NR3> MINimum MAXimum}
Parameter Suffix	S
Description	<p>Set the period for pulses. The <code>PER[1 2]?</code> query returns the period of the pulse waveform in seconds. The specified period must be greater than the sum of the pulse width and the edge time.</p> <p>This command affects the period (and frequency) for all waveform functions (not just pulse). For example, if you select a period using the <code>PER[1 2]</code> command and then change the function to sine wave, the specified period will be used for the new function. MIN selects the lowest actual possible period allowed for the selected function. MAX selects the highest actual possible period allowed.</p>
Example	<code>PER2 555.5NS</code>

Command	<code>:PULS:DCYC[1 2][?]</code>
Long	<code>[:SOURce] :PULSe:DCYCl e [1 2][?]</code>
Parameters	{<NR3> MINimum MAXimum}
Parameter Suffix	PCT
Description	<p>Set the pulse duty cycle in percent. The pulse duty cycle is defined as: $\text{Duty Cycle} = 100 \times \text{Pulse Width} \div \text{Period}$ where the pulse width represents the time from the start of the rising edge of the pulse to the start of the next falling edge. The pulse duty cycle range is 0 percent to 100 percent. However, the pulse duty cycle is limited by minimum pulse width and edge time restrictions, which prevent you from setting exactly 0 percent or 100 percent.</p> <p> This command is affected by the <code>:PULS:HOLD[1 2]</code> command, which determines the value to be held constant as the period is adjusted: the specified pulse width value, or the specified pulse duty cycle value, or the specified trailing delay. See the <code>:PULS:HOLD[1 2]</code> command for further information.</p>
Example	<code>:PULS:DCYC2 12.25</code>

Command	<code>:PULS:DEL[1 2][?]</code>
Long	<code>[:SOURce] :PULSe:DELaY[1 2][?]</code>
Parameters	{<NR3> MINimum MAXimum}
Parameter Suffix	S
Description	Set the pulse delay in second. Delay is the time between the start of the pulse period and the start of the leading edge of the pulse. If you want the pulse delay to remain constant when the pulse period is varied (see <code>:PULS:DEL:HOLD[1 2]</code>).
Example	<code>:PULS:DEL2 4.2NS</code>

Appendix

Command	<code>:PULS:DEL[1 2]:HOLD[?]</code>						
Long	<code>[:SOURce] :PULSe:DELaY[1 2]:HOLD[?]</code>						
Parameters	{TIME PRATio DEGree}						
Parameter Suffix	–						
Description	<p>Set the coupling between the pulse period and the pulse delay.</p> <table><tr><td>TIME</td><td>The absolute pulse delay is held fixed when the pulse period is varied.</td></tr><tr><td>PRATio</td><td>The pulse delay (delay as ratio of period) is held fixed when the pulse period is varied.</td></tr><tr><td>DEGree</td><td>Holds the delay in degrees fixed.</td></tr></table>	TIME	The absolute pulse delay is held fixed when the pulse period is varied.	PRATio	The pulse delay (delay as ratio of period) is held fixed when the pulse period is varied.	DEGree	Holds the delay in degrees fixed.
TIME	The absolute pulse delay is held fixed when the pulse period is varied.						
PRATio	The pulse delay (delay as ratio of period) is held fixed when the pulse period is varied.						
DEGree	Holds the delay in degrees fixed.						
Example	<code>:PULS:DEL2:HOLD PRAT</code>						

Command	<code>:PULS:DEL[1 2]:UNIT[?]</code>
Long	<code>[:SOURce] :PULSe:DELay[1 2]:UNIT[?]</code>
Parameters	<code>{S SEC PCT DEG RAD}</code>
Parameter Suffix	–
Description	It's used to set the default unit for the pulse-delay parameter. The default unit of a parameter is the unit used when the parameter is programmed to a value without a unit suffix.
Example	<code>:PULS:DEL2:WIDT PCT</code>

Command	<code>:PULS:FREQ[1 2][?]</code>
Long	<code>[:SOURce] :PULSe :FREQuency [1 2] [:CW :FIXed] [?]</code>
Parameters	{<NR3> MINimum MAXimum}
Parameter Suffix	HZ
Description	Set the output frequency. The <code>:PULS:FREQ[1 2]?</code> query returns the frequency setting in hertz for the function currently selected. MIN selects the lowest actual possible frequency allowed for the selected function. MAX selects the highest actual possible frequency allowed.
Example	<code>:PULS:FREQ2 222.22KHZ</code>

Command	:PULSe:HOLD[1 2][?]	
Long	[:SOURce]:PULSe:HOLD[1 2][?]	
Parameters	{WIDTh DCYClE TDELay}	
Parameter Suffix	–	
Description	Set instrument to hold either pulse width or pulse duty cycle or trailing delay:	
	WIDTh	<p>The instrument holds the pulse width setting (in seconds) constant as the period is varied. (Minimum width and edge time restrictions apply.)</p> <p>If a command to set a duty cycle value is received, the duty cycle is converted to the equivalent pulse width in seconds. If Pulse Width Modulation (PWM) is turned on, the pulse width is held, and the width deviation also is held, as the period is varied. Duty cycle deviation commands are converted to width deviation values.</p>
	DCYClE	<p>The instrument holds the pulse duty cycle setting (in percent) constant as the period is varied. (Minimum width and edge time restrictions apply.)</p> <p>If a command to set a pulse width value is received, the width is converted to the equivalent duty cycle in percent. If Pulse Width Modulation (PWM) is turned on, the pulse duty cycle is held, and the duty cycle deviation also is held, as the period is varied. Width deviation commands are converted to duty cycle deviation values.</p>
	TDEL	<p>The instrument holds the trailing delay setting (in seconds) constant as the period is varied. (Minimum width and edge time restrictions apply.)</p>

Appendix

✎ The `:PULS:HOLD[1|2]` command does not limit period settings. The physical limits of the width are not exceeded.

Example

```
:PULS:HOLD2 TDEL
```

Command	<code>:PULS:PER[1 2][?]</code>
Long	<code>[:SOURce] :PULSe:PERiod[1 2][?]</code>
Parameters	{<NR3> MINimum MAXimum}
Parameter Suffix	S
Description	<p>Set the period for pulses. The <code>PULS:PER[1 2]?</code> query returns the period of the pulse waveform in seconds. The specified period must be greater than the sum of the pulse width and the edge time.</p> <p>This command affects the period (and frequency) for all waveform functions (not just pulse). For example, if you select a period using the <code>PULS:PER[1 2]</code> command and then change the function to sine wave, the specified period will be used for the new function. MIN selects the lowest actual possible period allowed for the selected function. MAX selects the highest actual possible period allowed.</p>
Example	<code>:PULS:PER2 89NS</code>

Command	<code>:PULS:TDEL [1 2] [?]</code>
Long	<code>[:SOURce] :PULSe:TDELay [1 2] [?]</code>
Parameters	{<NR3> MINimum MAXimum}
Parameter Suffix	S
Description	<p>Set the delay of the trailing edge of the pulse relative to start of pulse period. This is an alternative method of programming pulse width.</p> <p>✎ This command is affected by the <code>:PULS:HOLD [1 2]</code> command, which determines the value to be held constant as the period is adjusted: the specified pulse width value, or the specified pulse duty cycle value, or the specifies trailing delay. See the <code>:PULS:HOLD [1 2]</code> command for further information.</p>
Example	<code>:PULS:TDEL1 6.77NS</code>

Command	<code>:PULS:TRAN[1 2][?]</code>
Long	<code>[:SOURce]:PULSe:TRANsition[1 2][:Leading][?]</code>
Parameters	{<NR3> MINimum MAXimum}
Parameter Suffix	S
Description	Set the edge time in seconds for the leading edges. The edge time represents the time from the 10% threshold to the 90% threshold of each edge. The <code>:PULS:TRAN[1 2]?</code> query returns the edge time in seconds. The specified edge time must fit within the specified pulse width.
Example	<code>:PULS:TRAN2 34.5NS</code>

Appendix

Command	<code>:PULS:TRAN[1 2]:HOLD[?]</code>
Long	<code>[:SOURce]:PULSe:TRANsition[1 2]:HOLD[?]</code>
Parameters	{TIME WRATio}
Parameter Suffix	–
Description	<p>It's used to set the coupling between transition times and the pulse width.</p> <p>TIME The absolute transition times are held when the pulse width is varied.</p> <p>WRATio The ratio of transition time to pulse width is held when the pulse width is varied.</p>
Example	<code>:PULS:TRAN2:HOLD TIME</code>

Command	<code>:PULS:TRAN[1 2]:TRA[?]</code>
Long	<code>[:SOURce] :PULSe:TRANsition[1 2]:TRAIling[?]</code>
Parameters	<code>{<NR3> MINimum MAXimum}</code>
Parameter Suffix	S
Description	Set the edge time in seconds for the trailing edges. The edge time represents the time from the 90% threshold to the 10% threshold of each edge. The <code>:PULS:TRAN[1 2]:TRA?</code> query returns the edge time in seconds.
Example	<code>:PULS:TRAN1:TRA 89.9NS</code>

Command	<code>:PULS:TRAN[1 2]:TRA:AUTO[?]</code>
Long	<code>[:SOURce] :PULSe:TRANsition[1 2]:TRAIling:AUTO[?]</code>
Parameters	{OFF ON ONCE}
Parameter Suffix	–
Description	<p>It's used to set the automatic coupling of the pulse-trailing-edge transition time to the leading-edge transition time.</p> <p>ON The trailing-edge transition time is automatically set to the same value as the leading edge and is updated automatically each time the leading-edge transition time changes.</p> <p>OFF The trailing-edge/leading-edge transition time is independently programmable.</p> <p>ONCE The trailing-edge transition time is set ONCE to the same value as the leading edge.</p>
Example	<code>:PULS:TRAN1:TRA:AUTO OFF</code>

Command	<code>:PULS:TRAN[1 2]:UNIT[?]</code>
Long	<code>[:SOURce]:PULSe:TRANsition[1 2]:UNIT[?]</code>
Parameters	<code>{S SEC PCT}</code>
Parameter Suffix	–
Description	Use this command to set the default units for the pulse transition-times. The default unit is used when the parameter is programmed to a value without a unit suffix.
Example	<code>:PULS:TRAN2:UNIT PCT</code>

Command	<code>:PULS:WIDT[1 2][?]</code>
Long	<code>[:SOURce] :PULSe:WIDTh[1 2][?]</code>
Parameters	{<NR3> MINimum MAXimum}
Parameter Suffix	S
Description	<p>Set the pulse width in seconds. The pulse width represents the time from the start of rising edge of the pulse to the start of the next falling edge. The <code>:PULS:WIDT[1 2]?</code> query returns the pulse width in seconds.</p> <p>✎ This command is affected by the <code>:PULS:HOLD[1 2]</code> command, which determines the value to be held constant as the period is adjusted: the specified pulse width value, or the specified pulse duty cycle value, or the specifies trailing delay. See the <code>:PULS:HOLD[1 2]</code> command for further information.</p>
Example	<code>:PULS:WIDT2 98.7NS</code>

4.5.9 Reference Clock Commands

Introduction This section describes the Reference clock related commands.

Reference Clock Commands

Command	:ROSC:SOUR[?]
Long	[:SOURce]:ROSCillator:SOURce[?]
Parameters	{INTernal EXTernal}
Parameter Suffix	–
Description	Select internal or external reference clock. When set to INTernal, the instrument will use it's built-in 10MHz reference. When set to EXTernal, it will use the signal provided at the 10MHz Ref-In connector. The selection will be overridden by the automatic reference clock detection if this is enabled. When :ROSC:SOUR:AUTO is set to ON, then the query will report the currently used reference clock source.
Example	:ROSC:SOUR EXT

Command	<code>:ROSC:SOUR:AUTO[?]</code>
Long	<code>[:SOURce] :ROSCillator :SOURce :AUTO[?]</code>
Parameters	<code>{ON OFF 0 1}</code>
Parameter Suffix	–
Description	Enable/disable the automatic reference clock selection. When set to ON, the instrument will switch to external clock reference as soon as it detects a signal at the 10MHz Ref-In connector. There is no check for validity of the signal at Ref-In. As a result of this, the instruments PLL may loose lock state if an invalid reference clock signal is applied to Ref-In.
Example	<code>:ROSC:SOUR:AUTO ON</code>

4.5.10 Non-Volatile Storage Commands

Introduction

The instrument has five storage locations in non-volatile memory to store instrument states. The locations are numbered 1 through 4. The instrument automatically uses location "0" to hold the state of the instrument at power down. You can also assign a user-defined name to each of the locations (1 through 4) for use from the front panel. Additionally it is possible to store an instrument state and arbitrary waveform to an USB mass memory connected with the instrument. The USB connector is located at the front-panel. To address the USB mass memory, the Mass MEMORY command subsystem can be used.

Command	:MEM:NST?
Long	:MEMory:NStates?
Parameters	—
Parameter Suffix	—
Description	Query the total number of memory locations available for state storage. Always returns "4".
Example	:MEM:NST? Response: 4

Command	:MEM:STAT:DEL
Long	:MEMory:STATe:DElete
Parameters	{1 2 3 4}
Parameter Suffix	–
Description	<p>Delete the contents of the specified storage location. If you have assigned a user-defined name to a location (MEM:STAT:NAME command), this command also removes the name that you assigned and restores the default name ("STATE_1", "STATE_2", etc.).</p> <p>🔑 You cannot recall the instrument state from a storage location that is empty. An error is generated if you attempt to recall a deleted state.</p>
Example	:MEM:STAT:DEL 3

Command	<code>:MEM:STAT:NAME[?]</code>
Long	<code>:MEMoRY:STATe:NAME[?]</code>
Parameters	<code>{1 2 3 4}[,<name>]</code>
Parameter Suffix	–
Description	<p>Assign a custom name to the specified storage location. You can name a location from the front panel or over the remote interface, but you can only recall a state by name from the front panel (the *RCL command requires a numeric parameter).</p> <p>The <code>:MEM:STAT:NAME? 1</code> query returns a quoted string containing the name currently assigned to the specified storage location. If you have not assigned a user-defined name to the specified location, the default name is returned ("<code>STATE_1</code>" or "<code>STATE_2</code>" or "<code>STATE_3</code>", or "<code>STATE_4</code>"). The name can contain up to 12 characters. The first character must be a letter (A-Z), but the remaining characters can be letters, numbers (0-9), or the underscore character ("<code>_</code>"). Blank spaces are not allowed. An error is generated if you specify a name with more than 12 characters. An example is shown below. <code>MEM:STATE:NAME 1,TEST_WFORM_1</code></p> <p>If you do not specify a name (note that the name parameter is optional), the default name is assigned to that state. This provides a way to clear a name (however, the stored state is not deleted).</p> <p>The instrument will not prevent you from assigning the same name to different storage locations. For example, you can assign the same name to locations "1" and "2".</p>
Example	<pre> Renames state 1 to TEST_WFORM1 : :MEM:STAT:NAME 1,TEST_WFORM1 Assigns the default name to state 1 :STATE_1 :MEM:STAT:NAME 1 Returns the name of state 0, here: "STATE_1" :MEM:STAT:NAME? 1 </pre>

Appendix

Command	:MEM:STAT:REC:AUTO[?]
Long	:MEMory:STATe:RECall:AUTO[?]
Parameters	{OFF ON}
Parameter Suffix	–
Description	<p>Disable or enable the automatic recall of the power-down state, when power is turned on. Select “ON” (default) to automatically recall the power-down state when power is turned on. Select “OFF” to issue a reset (*RST command) when power is turned on.</p> <p>The :MEM:STAT:REC:AUTO? Query returns “0” (OFF) or “1” (ON).</p>
Example	:MEM:STAT:REC:AUTO ON

Command	:MEM:STAT:VAL?
Long	:MEMory:STATe:VALid?
Parameters	{1 2 3 4}
Parameter Suffix	–
Description	Query the specified storage location to determine if a valid state is currently stored in that location. You can use this command before sending the *RCL command to determine if a state has been previously stored in this location. Returns “0” if no state has been stored or if it has been deleted. Returns “1” if a valid state is stored in the specified location.
Example	:MEM:STAT:VAL? 2 Response: 0

Appendix

Command	:MMEM:COPY
Long	:MMEMoRY:COPY
Parameters	"<file name>"["?:"], "<copy name>"["?:"]
Parameter Suffix	—
Description	<p>A command to copy an existing file <file name> in the current directory to a new file <copy name>. If <copy name> is the name of a subdirectory in the current directory, a copy is made in the subdirectory.</p> <p>Use ".." as <copy name> to copy a file into the parent directory.</p> <pre>:MMEM:COPY "ISTATE1", "ISTATE2" :MMEM:COPY "ISTATE1", ".."</pre>
Example	:MMEM:COPY "STATE_1", "STATE2"

Command	:MMEM:DEL
Long	:MMEM:DELeTe "<file name>"
Parameters	"<file name>"
Parameter Suffix	–
Description	It's used to delete file "<file name>" from the currently selected directory.
Example	:MMEM:DEL "STATE_1"

Appendix

Command	:MMEM:LOAD:STAT
Long	:MMEM:LOAD:STATe
Parameters	{1 2 3 4}, "<file name>"[, "?"]
Parameter Suffix	–
Description	<p>To load a complete instrument setting (state) from a file "<file name>" located in the current selected directory on the USB memory stick into non-volatile memory in the instrument.</p> <p>Load "FREQ_SWEEP" into storage location 2 :MMEM:LOAD:STAT 2, "FREQ_SWEEP" Recall storage location <2> as current setting: *RCL 2</p>
Example	:MMEM:LOAD:STAT 1, "TEST_0012"

Command :MMEM:LOAD:DATA [1 | 2]

Long :MMEM:LOAD:DATA [1 | 2]

Parameters VOLATILE,"<file name>"["?:"]

Parameter Suffix –

Description It is used to load a waveform from a file into VOLATILE memory.

Example :MMEM:LOAD:DATA VOLATILE,"SIGNAL.WFM"

Appendix

Command	:MMEM:LOAD:DATA[1 2]:MOD
Long	:MMEM:LOAD:DATA[1 2]:MODulation
Parameters	VOLATILE,"<file name>":["?:"]
Parameter Suffix	-
Description	It is used to load a waveform from a file into VOLATILE memory.
Example	:MMEM:LOAD:DATA:MOD VOLATILE,"ENVELOPE.WFM"

Command	<code>:MMEM:STOR:STAT</code>
Long	<code>:MMEM:STORe:STATe</code>
Parameters	<code>{1 2 3 4},"<file name>"["?:""]</code>
Parameter Suffix	–
Description	<p>Use this command to store a complete instrument setting (state) from non-volatile memory { 1 2 3 4 } location to file "<file name>" in the current selected directory on the USB memory stick.</p> <p>Store storage location <1> to file "FREQ_SWEEP" <code>:MMEM:STOR:STAT 1,"FREQ_SWEEP"</code></p> <p>Save current state to storage location 1 <code>*SAV 1</code></p>
Example	<code>:MMEM:STOR:STAT 4,"TEST_0012"</code>

Appendix

Command	:MMEM:STOR:DATA [1 2]
Long	:MMEM:STORe:DATA [1 2]
Parameters	VOLATILE,"<file name>"["?:""]
Parameter Suffix	–
Description	It is used to store a waveform to a file from VOLATILE memory.
Example	:MMEM:STOR:DATA VOLATILE,"SIGNAL.WFM"

Command	<code>:MMEM:STOR:DATA[1 2]:MOD</code>
Long	<code>:MMEM:STORe:DATA[1 2]:MODulation</code>
Parameters	<code>VOLATILE,"<file name>"["?:"]</code>
Parameter Suffix	–
Description	It is used to store a waveform to a file from VOLATILE memory.
Example	<code>:MMEM:STOR:DATA:MOD VOLATILE,"ENVELOPE.WFM"</code>

4.5.11 Status Reporting Commands

Introduction

The Questionable Data register group provides information about the quality or integrity of the instrument. Any or all of these conditions can be reported to the Questionable Data summary bit through the enable register.

Status Reporting Commands

Command	:STAT:QUES [?]
Long	:STATus:QUESTionable[:EVENT] [?]
Parameters	—
Parameter Suffix	—
Description	Reads the event register in the questionable status group. It's a read-only register. Once a bit is set, it remains set until cleared by this command or *CLS command. A query of the register returns a decimal value which corresponds to the binary-weighted sum of all bits set in the register.
Example	:STAT:QUES? Response: 4

Command	:STAT:QUES:COND?
Long	:STATus:QUESTionable:CONDition?
Parameters	–
Parameter Suffix	–
Description	Reads the condition register in the questionable status group. It's a read-only register and bits are not cleared when you read the register. A query of the register returns a decimal value which corresponds to the binary-weighted sum of all bits set in the register.
Example	:STAT:QUES:COND? Response: 4

Command	:STAT:QUES:ENAB[?]
Long	:STATus:QUESTionable:ENABle[?]
Parameters	–
Parameter Suffix	–
Description	Sets or queries the enable register in the questionable status group. The selected bits are then reported to the Status Byte. A *CLS will not clear the enable register but it does clear all bits in the event register. To enable bits in the enable register, you must write a decimal value which corresponds to the binary-weighted sum of the bits you wish to enable in the register.
Example	<pre> :STAT:QUES:ENAB 32 :STAT:QUES:ENAB #H20 :STAT:QUES:ENAB #B100000 :STAT:QUES:ENAB? Response: 32 </pre>

Command	:STAT:QUES:NTR[?]
Long	:STATus:QUEStionable:NTRansition[?]
Parameters	–
Parameter Suffix	–
Description	Sets or queries the negative-transition register in the questionable status group. A negative transition filter allows an event to be reported when a condition changes from true to false. Setting both positive/negative filters true allows an event to be reported anytime the condition changes. Clearing both filters disables event reporting. The contents of transition filters are unchanged by *CLS and *RST.
Example	:STAT:QUES:NTR 4 :STAT:QUES::NTR #H4 :STAT:QUES:NTR #B100 :STAT:QUES:NTR? Response: 4

Command	:STAT:QUES:PTR[?]
Long	:STATus:QUEStionable:PTRansition[?]
Parameters	
Parameter Suffix	–
Description	Set or queries the positive-transition register in the questionable status group. A positive transition filter allows an event to be reported when a condition changes from false to true. Setting both positive/negative filters true allows an event to be reported anytime the condition changes. Clearing both filters disables event reporting. The contents of transition filters are unchanged by *CLS and *RST.
Example	<pre> :STAT:QUES:PTR 15 :STAT:QUES::PTR #HF :STAT:QUES:PTR #Q17 :STAT:QUES:PTR #B1111 :STAT:QUES:PTR? Response: 15 </pre>

4.5.12 Sweep Commands

Introduction

In the frequency sweep mode, the instrument “steps” from the start frequency to the stop frequency at a sweep rate which you specify. You can sweep up or down in frequency, and with either linear or logarithmic spacing. You can also configure the instrument to output a single sweep (one pass from start frequency to stop frequency) by applying an external or manual trigger. The instrument can produce a frequency sweep for sine, square, ramp, or arbitrary waveforms (pulse, noise, and dc are not allowed).

Sweep Commands

Command	:FREQ[1 2]:CENT[?]
Long	[:SOURce] :FREQuency [1 2] [:CW :FIXed] :CENTer [?]
Parameters	{<NR3> MINimum MAXimum}
Parameter Suffix	HZ
Description	Set the center frequency (used in conjunction with the frequency span). MIN = 1 μ Hz, MAX = based on the frequency span and maximum frequency for the selected function. The :FREQ[1 2]:CENT? query returns the center frequency in Hertz.
Example	:FREQ2:CENT 5MHZ

Command	<code>:FREQ[1 2]:SPAN[?]</code>
Long	<code>[:SOURCE] :FREQuency [1 2] [:CW :FIXed] :SPAN [?]</code>
Parameters	<code>{ <NR3 > MINimum MAXimum }</code>
Parameter Suffix	HZ
Description	<p>Set the frequency span (used in conjunction with the center frequency) MIN = 0Hz, MAX = based on the center frequency and maximum frequency for the selected function. The <code>:FREQ[1 2]:SPAN?</code> query returns the span in Hertz (can be a positive or negative value). Frequency Span (max) = $2 \times (\text{Max. Frequency} - \text{Center Frequency})$</p> <ul style="list-style-type: none">• To sweep up in frequency, set a positive frequency span.• To sweep down in frequency, set a negative frequency span.
Example	<code>:FREQ1:SPAN 2.5MHZ</code>

Command	<code>:FREQ[1 2]:STAR[?]</code>
Long	<code>[:SOURce] :FREQuency [1 2] [:CW :FIXed] :STARt [?]</code>
Parameters	<code>{<NR3> MINimum MAXimum}</code>
Parameter Suffix	HZ
Description	Set the start frequency (used in conjunction with the stop frequency. The <code>:FREQ[1 2]:STAR?</code> query returns the start frequency in Hertz. To sweep up in frequency, set the start frequency < stop frequency. To sweep down in frequency, set the start frequency > stop frequency.
Example	<code>:FREQ2:STAR 10.1MHZ</code>

Appendix

Command	:FREQ[1 2]:STOP[?]
Long	[:SOURce] :FREQuency [1 2] [:CW :FIXed] :STOP [?]
Parameters	{ <NR3> MINimum MAXimum }
Parameter Suffix	HZ
Description	Set the stop frequency (used in conjunction with the start frequency). The :FREQ[1 2]:STOP? query returns the stop frequency in Hertz.
Example	:FREQ2:STOP 15.1MHZ

Command	:MARK [1 2] [?]
Long	:MARKer [1 2] [:STATe] [?]
Parameters	{OFF ON}
Parameter Suffix	–
Description	Disable or enable the frequency marker. The default is OFF. The MARK? Query returns “0” (OFF) or “1” (ON).
Example	:MARK ON

Command	:MARK [1 2] :FREQ [?]
Long	:MARKer [1 2] :FREQuency [?]
Parameters	{<frequency> MINimum MAXimum}
Parameter Suffix	HZ
Description	<p>Set the marker frequency. This is the frequency at which the signal on the front-panel Strobe Out connector goes to a logic low during the sweep. The Strobe signal always goes from low to high at the beginning of the sweep. Select from 1 μHz to 240 MHz (limited to 5 MHz for ramps and 80 MHz for arbitrary and square waveforms). The default is 500 Hz. MIN = the start or stop frequency (whichever is lower). MAX = the start frequency or stop frequency (whichever is higher). The :MARKer [1 2] :FREQ? query returns the marker frequency in Hertz.</p> <p>When sweep is enabled, the marker frequency must be between the specified start frequency and stop frequency. If you attempt to set the marker frequency to a frequency not in this range, the instrument will automatically set the marker frequency equal to the start frequency or stop frequency (whichever is closer).</p>
Example	:MARK2 :FREQ 12.4MHZ

Command	<code>:SWE [1 2] :IDLE [?]</code>						
Long	<code>[:SOURce] :SWEep [1 2] :IDLE [?]</code>						
Parameters	{SFRrequency EFRrequency DC}						
Parameter Suffix	–						
Description	<p>Specifies the so called sweep ‘idle’ frequency while waiting for a new trigger event to start a new sweep cycle. If the <code>:swe:idle efr</code> is sent to the instrument the frequency of the output signal will stay on the stop (end) frequency of the sweep until a new trigger event occurs.</p> <table> <tr> <td>SFRrequency</td> <td>The idle frequency is the Start FRequency</td> </tr> <tr> <td>EFRrequency</td> <td>The idle frequency is the End FRequency (stop frequency)</td> </tr> <tr> <td>DC</td> <td>The ‘idle frequency’ is a DC level</td> </tr> </table>	SFRrequency	The idle frequency is the Start FRequency	EFRrequency	The idle frequency is the End FRequency (stop frequency)	DC	The ‘idle frequency’ is a DC level
SFRrequency	The idle frequency is the Start FRequency						
EFRrequency	The idle frequency is the End FRequency (stop frequency)						
DC	The ‘idle frequency’ is a DC level						
Example	<code>:SWE2:IDLE EFR</code>						

Command	:SWE [1 2] :SPAC [?]
Long	[:SOURce] :SWEep [1 2] :SPACing [?]
Parameters	{LINear LOGarithmic}
Parameter Suffix	–
Description	<p>Select linear or logarithmic spacing for the sweep. The default is LINear. The :SWE [1 2] :SPAC? query returns “LIN” or “LOG”.</p> <ul style="list-style-type: none"> • For a linear sweep, the instrument varies the output frequency in a linear fashion during the sweep. • For a logarithmic sweep, instrument varies the output frequency in a logarithmic fashion during the sweep.
Example	:SWE2:SPAC LOG

Command	<code>:SWE [1 2] :STAT [?]</code>
Long	<code>[:SOURce] :SWEep [1 2] :STATe [?]</code>
Parameters	{ON OFF}
Parameter Suffix	–
Description	<p>Disable or enable the sweep mode. To avoid multiple waveform changes, you can enable the sweep mode after you have set up the other sweep parameters. The default is OFF. The <code>:SWE [1 2] :STAT?</code> query returns "0" (OFF) or "1" (ON).</p> <p>The instrument will not allow the sweep mode to be enabled at the same time that burst or any modulation mode is enabled. When you enable sweep, the burst or modulation mode is turned off.</p>
Example	<code>:SWE2:STAT OFF</code>

Appendix

Command	<code>:SWE [1 2] :TIME [?]</code>
Long	<code>[:SOURce] :SWEep [1 2] :TIME [?]</code>
Parameters	<code>{<NR3> MINimum MAXimum}</code>
Parameter Suffix	S
Description	Set the number of seconds required to sweep from the start frequency to the stop frequency. The default is 1 second. The <code>:SWE [1 2] :TIME?</code> query returns the sweep time in seconds.
Example	<code>:SWE2:TIME 3</code>

4.5.13 System-Related Commands

Introduction System (Instrument) related commands.

System-Related Commands

Command :SYST:BEEP

Long :SYSTem:BEEPer

Parameters –

Parameter Suffix –

Description Issue a single beep immediately.

Example :SYST:BEEP

Command	<code>:SYST:BEEP:STAT[?]</code>
Long	<code>:SYSTem:BEEPer:STATe</code>
Parameters	{ON OFF}
Parameter Suffix	–
Description	Disable or enable the tone heard when an error is generated from the front-panel or over the remote interface. The current selection is stored in non-volatile memory. The <code>:STAT?</code> query returns “0” (OFF) or “1” (ON).
Example	<code>:SYST:BEEP:STAT ON</code>

Appendix

Command	:SYST:DATE [?]
Long	:SYSTem:DATE [?]
Parameters	<years>,<month>,<day>
Parameter Suffix	–
Description	Queries or sets the date of the internal clock of the instrument.
Example	:SYST:DATE? Response: 2007, 5, 14

Command	<code>:SYST:COMM:RLST</code>
Long	<code>:SYSTem:COMMunicate:RLState</code>
Parameters	{LOCal REMote RWLock}
Parameter Suffix	–
Description	<p>Set the remote/local state of the instrument over the LAN interface from a Telnet or socket session. Provides control analogous to the IEEE-488.2 commands such as GTL (Go To Local) over the GPIB and USB interfaces.</p> <ul style="list-style-type: none">• LOCal - (The default). Sets the instrument state to local. Removes any annunciator and unlocks the front panel keyboard.• REMote - Sets the instrument state to remote. Displays the remote annunciator and locks the keyboard (except the <LOCAL> key).• RWLock - Sets the instrument state to remote with lock. Displays the rwl annunciator and locks the keyboard (including the <LOCAL> key).
Example	<code>:SYST:COMM:RLST LOC</code>

Command	:SYST:ERR?
Long	:SYSTem:ERRor[:NEXT]?
Parameters	–
Parameter Suffix	–
Description	<p>Read and clear one error from the instrument's error queue.</p> <p>A record of up to 30 command syntax or hardware errors can be stored in the error queue. Errors are retrieved in first-in-first-out (FIFO) order. The first error returned is the first error that was stored. Errors are cleared as you read them.</p> <p>If more than 30 errors have occurred, the last error stored in the queue (the most recent error) is replaced with "Queue overflow". No additional errors are stored until you remove errors from the queue.</p> <p>If no errors have occurred when you read the error queue, the instrument responds with 0, "No error".</p> <p>The error queue is cleared by the *CLS command or when the power is cycled.</p> <p>The error queue is not cleared by a reset (*RST) command.</p> <p>The error messages have the following format (the error string may contain up to 255 characters).</p> <p>-113, "Undefined header"</p>
Example	<pre>:SYST:ERR? Response:0,"No error"</pre>

Command	:SYST:HELP:HEAD?
Long	:SYSTem:HELP:HEADers?
Parameters	–
Parameter Suffix	–
Description	<p>The HEADers? query shall return all SCPI commands and queries and IEEE 488.2 common commands and common queries implemented by the instrument. The response shall be a <DEFINITE LENGTH ARBITRARY BLOCK RESPONSE DATA> element. The full path for every command and query shall be returned separated by linefeeds. The syntax of the response is defined as: The <nonzero digit> and sequence of <digit> follow the rules in IEEE 488.2, Section 8.7.9. An <SCPI header> is defined as: It shall contain all the nodes from the root. The <SCPI program mnemonic> contains the node in standard SCPI format. The short form shall use uppercase characters while the additional characters for the long form shall be in lowercase characters. Default nodes shall be surrounded by square brackets ([]).</p>

Description

For example, an instrument which implemented the required commands listed in Syntax & Style, Volume 1 section 4.2.1, this query, and the required IEEE 488.2 common commands and queries might return:

```
#3425
:SYSTem:ERRor?/qonly/
:SYSTem:HELP:HEADers?/qonly/
:SYSTem:VERSion?/qonly/
:STATus:OPERation[:EVENT]?/qonly/
:STATus:OPERation:CONDition?/qonly/
:STATus:OPERation:ENABLE
:STATus:QUEStionable[:EVENT]?/qonly/
:STATus:QUEStionable:CONDition?/qonly/
:STATus:QUEStionable:ENABLE
:STATus:PRESet/nquery/
*IDN?/qonly/
*RST/nquery/
*TST?/qonly/
```

*RST shall have no direct effect on the response to this query.

Example

:SYST:HELP:HEAD?

Response: See Description above.

Command	:SYST:KLOC [?]
Long	:SYSTem:KLOCK [:STATe] [?]
Parameters	{ON OFF}
Parameter Suffix	–
Description	Set front panel keyboard lock OFF (the default) or ON. With :SYST:KLOC ON, the front panel keyboard is locked, including the <LOCAL> key unless it has been excluded. To lock the keyboard without locking the <LOCAL> key, send SYST:KLOC:EXCL LOC first, before SYST:KLOC ON.
Example	:SYST:KLOC ON

Appendix

Command	:SYST:KLOC:EXCL[?]
Long	:SYSTem:KLOCk:EXCLude[?]
Parameters	{NONE LOCAL}
Parameter Suffix	–
Description	<p>Setting :SYST:KLOC:EXCL NONE (the default) sets no exclusion, and SYST:KLOC ON locks the entire keyboard including the <LOCAL> key.</p> <p>Setting :SYST:KLOC:EXCL excludes the <LOCAL> key, and SYST:KLOC ON locks the keyboard, except the <LOCAL> key.</p>
Example	:SYST:KLOC:EXCL NONE

Command	:SYST:PRES
Long	:SYSTem:PRESet
Parameters	–
Parameter Suffix	–
Description	The PRESet command is an event that configures the SCPI device-dependant status data structure to its preset value, e.g. NTR to 0x00, PTR to 0xFF.
Example	:SYST:PRES

Command	:SYST:SEC[?]
Long	:SYSTem:SECurity[:STATe][?]
Parameters	{ON OFF}
Parameter Suffix	–
Description	<p>Use this command to switch on system security mode. Switch on system security if you need to make sure that all instrument settings stored in the instrument are erased automatically when the instrument is switched off or when the security mode is switched off.</p> <p>The instrument's settings are erased by overwriting them with the default setting.</p> <p>System security mode is not available via the front-panel.</p>
Example	:SYST:SEC ON

Command	:SYST:SEC:IMM
Long	:SYSTem:SECurity:IMMediate
Parameters	–
Parameter Suffix	–
Description	<p>Clears all instrument memory except for the boot parameters and calibration constants. Initializes all instrument settings to their *RST values. Destroys all user-defined state information, user-defined arbitrary waveforms, and user-defined I/O settings such as the IP address. The built-in arbitrary waveforms are not affected and the VOLATILE waveform persists until the power is turned off. This command is typically used to clear all memory before removing the instrument from a secure area. This command is not recommended for use in routine applications because of the possibility of unintended loss of data.</p>
Example	:SYST:SEC:IMM

Command	:SYST:SET[?]
Long	:SYSTem:SET[?]
Parameters	<block data>
Parameter Suffix	–
Description	<p>In query form, the command reads a block of data containing the instrument's complete set-up. The set-up information includes all parameter and mode settings, but does not include the contents of the instrument setting memories, the status group registers or the :DISPlay[:WINDow][:STATe]. The data is in a binary format, not ASCII, and cannot be edited.</p> <p>In set form, the block data must be a complete instrument set-up read using the query form of the command.</p> <p>This command has the same functionality as the *LRN command.</p>
Example	<pre>:SYST:SET? Response #527576...</pre>

Command	:SYST:TEST?
Long	:SYSTem:TEST?
Parameters	{PON NORMal ALL}
Parameter Suffix	–
Description	<p>Execute the selftest and report the result.</p> <ul style="list-style-type: none">• PON: This does not execute any test, but simply evaluate the result of the power on selftest,• NORMal: Execute the normal selftest (no need to disconnect DUT) and report the result.• ALL: Execute the extended selftest and report the result. The instrument must be completely disconnected from any external setup before the extended selftest may be started. <p>The result is 0 if no errors are found and 1 if at least one test failed. The error queue will contain the corresponding error messages.</p>
Example	<pre>:SYST:TEST? PON Response: 0</pre>

Appendix

Command	:SYST:TIME [?]
Long	:SYSTem:TIME [?]
Parameters	<hours>,<minutes>,<seconds>
Parameter Suffix	–
Description	Queries or sets the time of the internal clock of the instrument.
Example	:SYST:TIME 10, 0, 30

Command	:SYST:VERS?
Long	:SYSTem:VERSion
Parameters	–
Parameter Suffix	–
Description	Returns a string in the form “YYYY.V”, where “YYYY” represents the year of the version, and “V” represents a version number for that year (e.g., 1999.0).
Example	:SYST:VERS? Response: 1999.0

Appendix

Command	:SYST:WARN?
Long	:SYSTem:WARNing[:COUNT]?
Parameters	–
Parameter Suffix	–
Description	<p>Use this command to read the number of warnings, which are currently active.</p> <p> The warning status of voltage, time and frequency are also summarized by bits in the questionable status register.</p>
Example	:SYST:WARN? Response: 0

Command	:SYST:WARN:BUFF?
Long	:SYSTem:WARNing:BUFFer?
Parameters	—
Parameter Suffix	—
Description	Use this command to read the maximum possible number of characters which could be returned by :SYST:WARN:STR? If all warnings were active.
Example	:SYST:WARN:BUFF? Response: 8627

Command	:SYST:WARN:STR?
Long	:SYSTem:WARNing:STRing?
Parameters	–
Parameter Suffix	–
Description	It is used to read all the currently active warning messages. The warning messages are concatenated to form a single string with a “;” as separator between the messages.
Example	:SYST:WARN:STR? Response: “ ”

Command	:CAL?
Long	:CALibration[:ALL]?
Parameters	–
Parameter Suffix	–
Description	<p>Disconnect all cables before executing calibration. Self-calibration includes the following:</p> <ul style="list-style-type: none">• Levels at normal and inverted outputs• Levels at Trigger-Out• Levels at Strobe-Out• Sensitivity of External-In• Input voltage window and OV level at Modulation-In
Example	:CAL? Response: 1

4.5.14 Display Commands

Introduction Display related commands.

Display Commands

Command	:DISP[?]
Long	:DISPlay[:WINDow] [:STATe] [?]
Parameters	{ON OFF}
Parameter Suffix	—
Description	<p>Disable or enable the instrument's front-panel display. When it is disabled, the front-panel display is blanked and the bulb used to backlight the display is also switched off. The <code>DISP?</code> query returns "0" (OFF) or "1" (ON).</p> <p>Sending a message to the front-panel display from the remote interface (<code>DISP:TEXT</code> command) overrides the display state. This means that you can display a message even if the display is disabled.</p> <p>The display is automatically enabled when power is cycled, after an instrument reset (<code>*RST</code> command), or when you return to local (front panel) operation. Press the key or execute the IEEE-488 GTL (Go To Local) command from the remote interface to return to the local state.</p>
Example	:DISP ON

Command	<code>:DISP:TEXT[?]</code>
Long	<code>:DISPlay[:WINDow]:TEXT[?]</code>
Parameters	{<quoted string>}
Parameter Suffix	–
Description	<p>Display a text message on the instrument's front-panel display. Sending a text message to the display overrides the display state as set by the DISP command. The <code>:TEXT?</code> query reads the message sent to the front-panel display and returns a quoted string.</p> <p>You can use upper- or lower-case letters (A-Z), numbers (0-9), and any other character on a standard computer keyboard. Depending on the number of characters you specify in the string, the instrument will choose one of two font sizes to display the message. An example is shown below.</p> <pre>DISP:TEXT 'Test in Progress...'</pre> <p>While a message is displayed, information relating to the output waveform, such as frequency and amplitude, is not sent to the front panel display</p>
Example	<code>:DISP:TEXT "TEST 1 is running."</code>

Command	<code>:DISP:TEXT:CLE[?]</code>
Long	<code>:DISPlay[:WINDow]:TEXT:CLEar[?]</code>
Parameters	–
Parameter Suffix	–
Description	<p>Clear the text message currently shown on the instrument's front-panel display.</p> <p>If the display is currently enabled (DISP ON command), the <code>DISP:TEXT:CLEAR</code> command will return the normal front-panel display mode.</p> <p>If the display is currently disabled (DISP OFF command), the <code>DISP:TEXT:CLEAR</code> command will clear the message but the display will remain disabled. To enable the display, send the DISP ON command, press the key, or send the GTL (Go To Local) command for GPIB or USB. (For LAN you can send the <code>SYST:COMM:RLST LOC</code> command.)</p>
Example	<code>:DISP:TEXT:CLE</code>

4.5.15 Triggering Commands

Introduction

The trigger subsystem is used to synchronize device action(s) with events or in other words you program the comprehensive triggering capabilities of the instrument using the `SCPI:ARM` and `:TRIGger` subsystem. Using these two command subsystems you can program the operating modes of the instrument. More precise use the `:ARM` subsystem to select the overall triggering mode of the instrument e.g. Continuous, External triggered, Gated, etc. and the trigger subsystem to select for example the number of pulse period. The following diagram illustrates the trigger model of 81150A / 81160A.

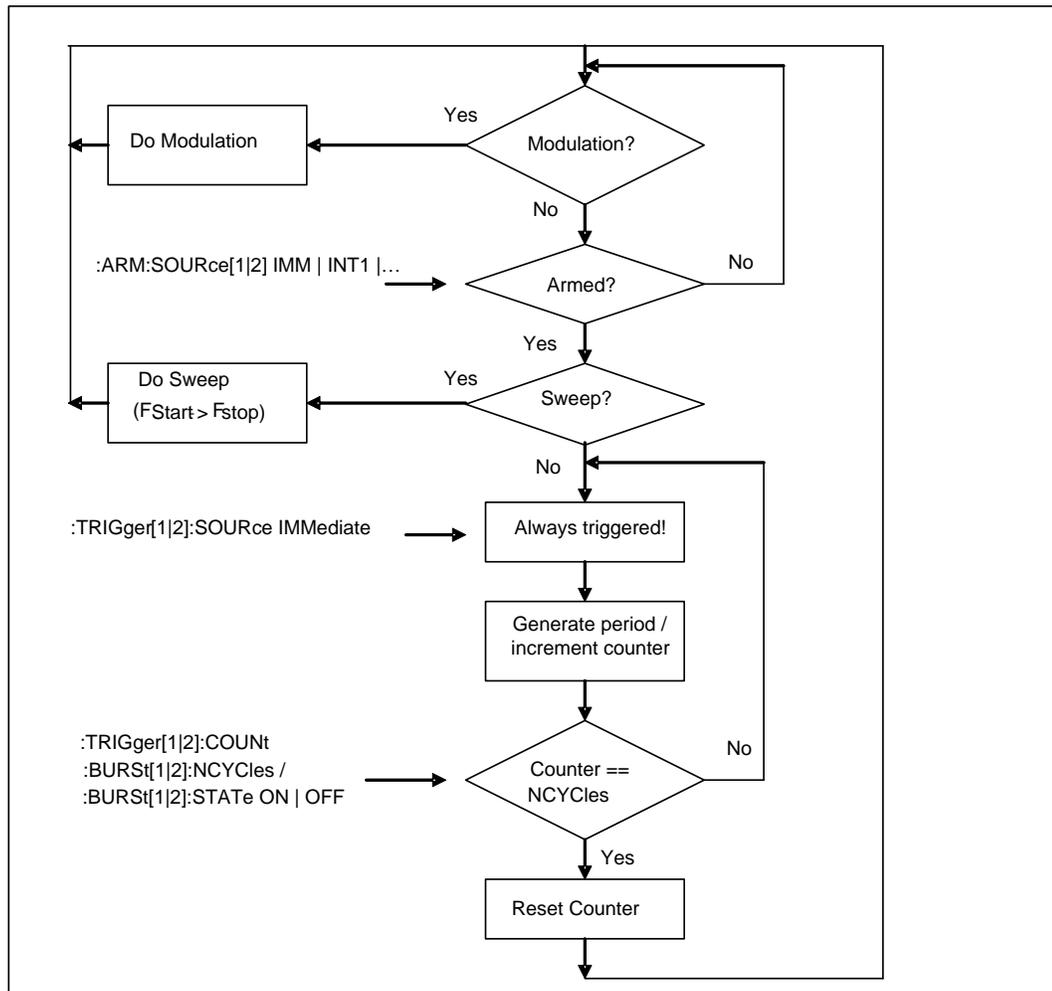

Triggering Commands

Command	:ARM:FREQ[1 2][?]
Long	:ARM[:SEquence[1] [START][:LAYer[1]]:FREQuency[1 2] [:CW :FIXed][?]
Parameters	{<NR3> MINimum MAXimum}
Parameter Suffix	HZ
Description	Specifies the frequency of the internal trigger period generator of the selected channel. To select the internal trigger generator use :ARM:SOUR[1 2] INT2
Example	:ARM:FREQ2 10MHz

Appendix

Command	:ARM:EFREquency? [?]
Long	:ARM[:SEQuence] [:STARt] [:LAYer] :EFREquency? [?]
Parameters	{<NR3>}
Parameter Suffix	Hz
Description	Read the detected trigger input frequency at the "External In" connector.
Example	:ARM:EFREquency?

Command	:ARM:HYSTerisis [?]
Long	:ARM[:SEQuence] [:STARt] [:LAYer]:HYSTerisis [?]
Parameters	{LOW HIGH}
Parameter Suffix	–
Description	Set the hysteresis input range for the “External In” connector.
Example	:ARM:HYST LOW

Command	:ARM:IMP[?]
Long	:ARM[:SEQuence[1] STARt][:LAYer[1]]:IMPedance[?]
Parameters	{<NR3> MINimum MAXimum}
Parameter Suffix	OHM
Description	<p>Use this command to program the input impedance of the external input (EXT-IN) connector. Two separate values are available:</p> <p>81150A: 50 Ω or 10 kΩ</p> <p>81160A: 50 Ω or 1 kΩ</p> <p>The command accepts numerical values; the sent value will be clipped to the corresponding value 50 Ω or 10 kΩ for the 81150A (50 Ω or 1 kΩ for the 81160A). To select the external input as trigger source use</p> <p>:ARM:SOUR[1 2] EXT.</p>
Example	:ARM:IMP 50OHM

Command	:ARM:LEV[?]
Long	:ARM[:SEQuence[1] STARt][:LAYer[1]]:LEVel[?]
Parameters	{<NR3> MINimum MAXimum}
Parameter Suffix	V
Description	It is used to program the triggering threshold of the external input (EXT-IN) connector. To select the external input as trigger source use :ARM:SOUR[1 2] EXT
Example	:ARM:LEV 1V

Command	:ARM:PER[1 2][?]
Long	:ARM[:SEQuence[1] STARt][:LAYer[1]]:PERiod[1 2][?]
Parameters	{<NR3> MINimum MAXimum}
Parameter Suffix	{S SEC}
Description	Specifies the period of the internal trigger period generator of the selected channel. To select the internal trigger generator use: :ARM:SOUR[1 2] INT2.
Example	:ARM:PER2 10uS

Command	<code>:ARM:SENS[1 2][?]</code>
Long	<code>:ARM[:SEQuence[1] START][:LAYer[1]]:SENSe[1 2][?]</code>
Parameters	{EDGE LEVe}
Parameter Suffix	–
Description	Use this command to select triggered or gated mode by choosing whether the instrument arms on the edge(s) or level of the trigger signal. To select the external input as trigger source use <code>:ARM:SOUR[1 2] EXT</code>
Example	<code>:ARM:SENS2 LEV</code>

Appendix

Command	<code>:ARM:SLOP[1 2][?]</code>
Long	<code>:ARM[:SEQuence[1] STARt][:LAYer[1]]:SLOPe[1 2][?]</code>
Parameters	{POSitive NEGative EITHer}
Parameter Suffix	–
Description	Use this command to select the trigger slope for the triggering signal when triggering on edges. Select EITHer to trigger on both the positive and negative edge of the triggering signal. To select the external input as trigger source use <code>:ARM:SOUR[1 2] EXT</code> or gating level.
Example	<code>:ARM:SLOP1 POS</code>

Command	:ARM:SOUR[1 2][?]								
Long	:ARM[:SEQuence[1] [START][:LAYer[1]]:SOURce[1 2][?]								
Parameters	{IMMediate INTernal[1] INTernal[2] EXTernal BUS MANual}								
Parameter Suffix	–								
Description	<p>Use this command to select the triggering mode of the instrument by selecting the source of the arming signal for the specified channel of the instrument.</p> <table border="0"> <tr> <td>IMMediate INTernal1</td> <td>Continuous mode</td> </tr> <tr> <td>INTernal2</td> <td>Triggered by the internal trigger period generator</td> </tr> <tr> <td>EXTernal</td> <td>Triggered or Gated by External Input (EXT-IN)</td> </tr> <tr> <td>MANual</td> <td>Triggered or Gated by the manual key or by *TRG :TRIGger</td> </tr> </table> <p> If the mode IMM of INT1 was sent, the query form returns always IMM.</p>	IMMediate INTernal1	Continuous mode	INTernal2	Triggered by the internal trigger period generator	EXTernal	Triggered or Gated by External Input (EXT-IN)	MANual	Triggered or Gated by the manual key or by *TRG :TRIGger
IMMediate INTernal1	Continuous mode								
INTernal2	Triggered by the internal trigger period generator								
EXTernal	Triggered or Gated by External Input (EXT-IN)								
MANual	Triggered or Gated by the manual key or by *TRG :TRIGger								
Example	:ARM:SOUR2 IMM								

Appendix

Command	:TRIG
Long	:TRIGger
Parameters	–
Parameter Suffix	–
Description	Initiates a software trigger. Corresponds to the *TRG, *TRG and :TRIG are both channel independent or in other words it generates a software trigger on both channels if both channels are waiting for a trigger event.
Example	:TRIG

Command	:TRIG[1 2]:SOUR[?]
Long	:TRIGger[1 2] [:SEQuence[1] [STARt]:SOURce[?]
Parameters	{IMMediate INTernal[1]}
Parameter Suffix	–
Description	This command was implemented to be compatible with the Keysight Pulse generator Family trigger model.
Example	:TRIG:SOUR IMM

4.5.16 Pattern Related Commands

Command	:DIG:SIGN:FORM
Long	:DIGital[1 2][:STIMulus]:SIGNal:FORMat[?]
Parameters	NRZ USER
Parameter Suffix	–
Description	<p>This command is used to set the bit shape in pattern mode. Setting the bitshape to NRZ causes the output signal to be equal to high level for a '1' bit and equal to low level for a '0' bit and equal to offset for a '-' bit. In NRZ mode, the transition times can be adjusted using the leading edge parameter (:PULS:TRAN).</p> <p>If bitshape is set to USER, the bit transitions can be defined using the :DIG:TRAN command.</p>
Example	:DIG:SIGN:FORM NRZ

Command	:DIG
Long	:DIGital[1 2] [:STIMulus] [:PATtern] [:STATe] [?]
Parameters	ON OFF 0 1
Parameter Suffix	–
Description	Use this command to enable/disable pattern mode. When pattern mode is enabled, the function switches to “Pulse”.
Example	:DIG ON

Appendix

Command	:DIG:PRBS
Long	:DIGital[1 2][:STIMulus][:PATtern]:PRBS
Parameters	<n>
Parameter Suffix	–
Description	Use this command to generate a PRBS (pseudo random bit sequence). The parameter <n> defines the polynomial length of the PRBS, i.e. :DIG:PRBS 7 generates a PRBS 2 ⁷ -1. Valid values for <n> are 7, 9, 11, 15, 23 and 31. The standard polynomial coefficients are used.
Example	:DIG:PRBS 7

Command	:DIG:PRES
Long	:DIGital[1 2][:STIMulus][:PATTern]:PRESet
Parameters	<n> [, <length>]
Parameter Suffix	–
Description	<p>Use this command to generate a clock pattern with a rate of <instrument frequency> / <n>. The parameter <length> determines the length of the sequence.</p> <p><n> = 2 generates 0101010101010101010...</p> <p><n> = 3 generates 001001001001001000100...</p> <p>and so on.</p> <p>Special case: With <n> = 0, the sequence defined by <length> is filled with zeroes. If <n> = 1, the sequence is filled with ones.</p>
Example	:DIG:PRES 4

Command	:DIG:DATA
Long	:DIGital[1 2][:STIMulus][:PATTern]:DATA
Parameters	<block data>
Parameter Suffix	–
Description	<p>Use this command to define the contents of the VOLATILE pattern. Depending on the data format (see :DIG:FORM), each byte contains one, four or eight bits.</p> <p>81150A: 2-level patterns can be 2 to 16 Mbit long, 3- and 4-level patterns can be up to 8 Mbit long.</p> <p>81160A 1-channel: 2-level patterns can be 2 to 4 Mbit long, 3- and 4-level patterns can be up to 2 Mbit long.</p> <p>81160A 2-channels: 2-level patterns can be 2 to 2 Mbit long, 3- and 4-level patterns can be up to 1 Mbit long.</p>
Example	<pre>:DIG:NLEV 2 :DIG:FORM PACKED,1 :DIG:DATA #2161001101001001001</pre>

Command	:DIG:FORM
Long	:DIGital[1 2] [:STIMulus] [:PATTern] :FORMat[:DATA]
Parameters	PACKed, 1 4 8
Parameter Suffix	–
Description	<p>This command controls the format of data transfer for the :DIG:DATA command. . In the following description, MLbit stands for a multi-level bit (a bit value that has either 2, 3 or 4 levels).</p> <p>The following values are possible:</p> <ul style="list-style-type: none"> 1 – This is the default format and should be used in most cases. Data is sent as a string of ASCII 1's and 0's (or ASCII '0', '1' and '2' for 3-level patterns, or ASCII '0','1','2' and '3' for 4-level patterns). Only the least significant bit (2-level patterns) or two bits (3- and 4-level patterns) are used to define a single MLbit. 4 – The data is sent as a string HEX characters. With this format, the amount of data to be transmitted is reduced amount, but the binary block data still contains printable characters (which is needed for some programming environments). For 2-level patterns, bits 3 through 0 of each symbol are used to define 4 MLbits. For 3- and 4-level patterns, bits 3&2 and 1&0 are used to define 2 MLbits. 8 – The data is sent as a string of 8-bit ASCII characters. All 8 bits are used. This format provides maximum packing density, but the binary data block might contain non-printable characters. For 2-level patterns, bits 7 through 0 define one MLbit each; For 3- and 4-level patterns, bits 7&6, 5&4, 3&2 and 1&0 define one MLbit each. <p>Data is used from left to right and within one byte from MSB to LSB.</p>

Appendix

Example

```
:DIG:NLEV 2  
:DIG:FORM PACKED,1  
:DIG:DATA #2161001101001001001
```

Command	<code>:DIG:SEL</code>
Long	<code>:DIGital[1 2] [:STIMulus] [:PATtern] :SElect</code>
Parameters	<name>
Parameter Suffix	–
Description	Use this command to select a named data block. The name can be one of the built-in pattern names (PRBS_7, PRBS_15, etc.), a user-defined pattern name that has been stored with <code>:DIG:COPY</code> before or the name <code>VOLATILE</code> to select the pattern that is currently in volatile memory.
Example	<code>:DIG:SEL MY_PATTERN</code>

Appendix

Command	:DIG:COPY
Long	:DIGital[1 2] [:STIMulus] [:PATTern]:COPY
Parameters	<name> [,VOLATILE]
Parameter Suffix	–
Description	Use this command to store the volatile pattern into non-volatile storage under a certain name.
Example	:DIG:COPY MY_PATTERN

Command	:DIG:DEL
Long	:DIGital[1 2] [:STIMulus] [:PATtern]:DElete
Parameters	<name>
Parameter Suffix	–
Description	Use this command to delete the named pattern from non-volatile storage. ✎ If a pattern is currently in use, it can not be deleted.
Example	:DIG:DEL MY_PATTERN

Command	:DIG:DEL:ALL
Long	:DIGital[1 2] [:STIMulus] [:PATTern] :DElete:ALL
Parameters	–
Parameter Suffix	–
Description	Use this command to delete all user-defined patterns from non-volatile storage. ✎ If a pattern is currently in use, it can not be deleted.
Example	:DIG:DEL:ALL

Command	:DIG:CAT?
Long	:DIGital[1 2] [:STIMulus] [:PATtern] :CATalog?
Parameters	–
Parameter Suffix	–
Description	Use this query to get a list of all user defined patterns.
Example	:DIG:CAT?

Appendix

Command	:DIG:NVOL:CAT?
Long	:DIGital[1 2] [:STIMulus] [:PATtern]:NVOLatile :CATalog?
Parameters	–
Parameter Suffix	–
Description	Use this query to get a list of all non-volatile patterns.
Example	:DIG:NVOL:CAT?

Command	:DIG:NVOL:FREE?
Long	:DIGital[1 2] [:STIMulus] [:PATtern]:NVOLatile:FREE?
Parameters	–
Parameter Suffix	–
Description	Use this command to get the number of unused pattern slots that are available for storing patterns. The return value will be in the range of 0 to 4.
Example	:DIG:NVOL:FREE?

Appendix

Command	:DIG:NVOL:QUAN?
Long	:DIGital[1 2] [:STIMulus] [:PATtern]:NVOLatile :QUANtity?
Parameters	–
Parameter Suffix	--
Description	Use this command to get the total number of pattern slots that are available for storing patterns.
Example	:DIG:NVOL:QUAN?

Command	:DIG:LENG?
Long	:DIGital[1 2] [:STIMulus] [:PATtern] :LENGth?
Parameters	[<name>]
Parameter Suffix	–
Description	Use this command to query the length of the currently selected pattern. If <name> is specified, then the length of the named pattern is returned.
Example	:DIG:LENG?

Command	<code>:DIG:NLEV</code>
Long	<code>:DIGital[1 2] [:STIMulus] [:PATTern] :NLEVels</code>
Parameters	<code><n></code>
Parameter Suffix	–
Description	<p>Use this parameter to define the number of levels in a data pattern. For binary patterns use 2, for three-level data (binary + electrical idle) use 3.</p> <p>The behavior of this command/query is slightly different in internal and external pattern mode.</p> <p>In internal pattern mode (<code>:DIG:SOUR INT</code>), the command form of this parameter is used to set the number of levels for a pattern or a bitshape that will be programmed subsequently (using <code>:DIG:DATA</code> or <code>:DIG:TRAN resp.</code>).</p> <p>The query form always returns the number of levels of the currently selected pattern – which is not necessarily identical with the number of levels that was previously set using the <code>:DIG:NLEV</code> command. (E.g. If this parameter is set to 3, then a pattern with 2 levels is selected, the query will return 2).</p> <p>In external pattern mode (<code>:DIG:SOUR EXT</code>), the value of this parameter is used to distinguish between a binary level or 3 levels of external input signal. The query returns the previously programmed value. Depending on the value of this parameter, the external thresholds have to be programmed accordingly (see <code>:DIG:EXT:THRE</code>)</p>
Example	<pre>:DIG:NLEV 3 :DIG:DATA #2162222201010102222</pre>

Command	:DIG:LOFF
Long	:DIGital[1 2][:STIMulus][:PATTern]:LOFFset
Parameters	<n>
Parameter Suffix	–
Description	<p>Use this command to define the offset within the data block where the loop occurs. E.g. If the data pattern is defined as 11101010 and loop offset is defined as 5 then the following output will be generated: 11101010010010010010010...</p> <p> The query form always returns the loop offset of the <i>currently selected</i> pattern – which is not necessarily identical with the loop offset previously set with the :DIG:LOFF command. This parameter will automatically be updated when loading a data pattern from non-volatile storage or when defining a new pattern using the local user interface.</p>
Example	:DIG:LOFF 5

Command	:DIG:TRAN
Long	:DIGital[1 2][:STIMulus][:PATTern]:TRANSition
Parameters	<list of values>
Parameter Suffix	

Description Use this command to download user-defined “bitshape waveforms”. Bitshape waveforms describe the transition between MLbit levels. Each transition is defined with up to 64 waveform points. Depending on the current number of levels, a certain minimum and maximum number of waveform points is required to describe all transitions:

# of levels	# of transitions	minimum # of waveform points	maximum # of waveform points
2	4 (= 2 * 2)	4	256 (= 4 * 64)
3	9 (= 3 * 3)	9	576 (= 9 * 64)
4	16 (= 4 * 4)	16	1024 (= 16 * 64)

All 4, 9 or 16 transitions are downloaded as a single waveform. The order of transitions is as follows:

For 2 levels: 0→0, 0→1, 1→0, 1→1

For 3 levels: 0→0, 0→1, 0→2, 1→0, 1→1, 1→2, 2→0, 2→1, 2→2

For 4 levels: 0→0, 0→1, 0→2, 0→3, 1→0, ..., ..., 3→3

Each waveform point is specified as a floating point value between -1 (minimum DAC value) to +1 (maximum DAC value). The number of downloaded values must be between the minimum and maximum number of waveform points and it must be a multiple of the number of transitions. The downloaded points are evenly distributed across the transitions and DAC values will be linearly interpolated. E.g. if you download 8 points for a 2-level bitshape, each transition will be defined by 2 points with linear interpolation in between.

 The number of levels (:DIG:NLEV) must be set before using this command, because the number of waveform points depends on the number of levels.

Example

```
:DIG:NLEV 3  
:DIG:TRAN -1,-1,-1,1,-1,0.5,1,-1,1,-1,1,0.5,0.5,  
          -1,0.5,1,0.5,0.5
```

Appendix

Command	:DIG:TRAN:DAC
Long	:DIGital[1 2][:STIMulus][:PATtern]:TRANsition:DAC
Parameters	<block data>
Parameter Suffix	-
Description	This command is similar to :DIG:TRAN (see previous section), except that the values are sent as a binary block and consist of 16-bit integer values between -8191 (minimum DAC value) and 8191 (maximum DAC value). Refer to :DIG:TRAN for a detailed explanation.
Example	:DIG:NLEV 2 :DIG:TRAN:DAC#3512<...512 bytes of binary data...>

Command : DIG:TRAN:INT

Long : DIGital[1|2] [:STIMulus] [:PATTern]:TRANSition
 : INTERpolate

Parameters ON|OFF|0|1

Parameter Suffix -

Description Use this command to turn interpolation of the bitshape waveform on or off. When turned off, the output is series of steps from DAC value to DAC value. When turned on, the output signal is interpolated linearly between adjacent DAC values.

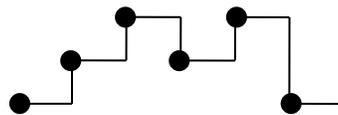

Interpolation OFF

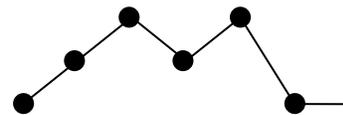

Interpolation ON

Example : DIG:TRAN:INT ON

Command	<code>:DIG:TRAN:SEL</code>
Long	<code>:DIGital[1 2][:STIMulus][:PATTern]:TRANSition :SElect</code>
Parameters	<code><name></code>
Parameter Suffix	-
Description	Use this command to select a named bit transition waveform. The name can be a user-defined pattern name that has been stored with <code>:DIG:TRAN:COPY</code> before or the name <code>VOLATILE</code> to select the bit transition waveform that is currently in volatile memory.
Example	<code>:DIG:TRAN:SEL MY_WAVEFORM</code>

Command	:DIG:TRAN:COPY
Long	:DIGital[1 2][:STIMulus][:PATTern]:TRANsition:COPY
Parameters	<name> [,.VOLATILE]
Parameter Suffix	-
Description	<p>Use this command to store the volatile bit transition waveform into non-volatile storage under a certain name.</p> <p> The storage space for bit transition waveforms is shared with waveforms used for arbitrary waveform mode.</p>
Example	:DIG:TRAN:COPY MY_WAVEFORM

Appendix

Command	:DIG:TRAN:DEL
Long	:DIGital[1 2] [:STIMulus] [:PATtern]:TRANSition :DElete
Parameters	<name>
Parameter Suffix	-
Description	Use this command to delete a particular bit transition waveform. Built-in waveforms can not be deleted.
Example	:DIG:TRAN:DEL MY_WAVEFORM

Command	:DIG:TRAN:DEL:ALL
Long	:DIGital[1 2] [:STIMulus] [:PATTern]:TRANSition :DElete:ALL
Parameters	None
Parameter Suffix	
Description	Use this command to delete all user-defined bit transition waveforms. Built-in waveforms will not be deleted by this command.
Example	:DIG:TRAN:DEL:ALL

Appendix

Command	:DIG:TRAN:CAT?
Long	:DIGital[1 2] [:STIMulus] [:PATtern]:TRANSition :CATalog?
Parameters	None
Parameter Suffix	-
Description	Use this query to get a list of all user-defined bit transition waveforms.
Example	:DIG:TRAN:CAT?

Command	:DIG:TRIG
Long	:DIGital[1 2] [:STIMulus] [:PATtern] :TRIGger [:MODE]
Parameters	BIT BLOCK
Parameter Suffix	-
Description	Use this command to select the trigger mode for pattern. If it is set to BIT, each trigger event causes a single bit to be output. If set to BLOCK, each trigger event will cause a complete data block to be output.
Example	:DIG:TRIG BLOCK

Command	:DIG:SOUR
Long	:DIGital[1 2] [:STIMulus] [:PATtern] :SOURce
Parameters	INTernal EXTernal
Parameter Suffix	-
Description	<p>Use this command to select the pattern source. In INTernal mode, one of the built-in or user-defined patterns or a PRBS can be selected. In EXTernal mode, pattern data is supplied on the MOD-IN connector on the rear-panel of the 81150A / 81160A.</p> <p>See also :DIG:EXT:IMP, :DIG:EXT:RANG, :DIG:EXT:THR, :DIG:EXT:SAMP.</p>
Example	:DIG:SOUR EXT

Command	<code>:DIG:EXT:RANG</code>
Long	<code>:DIGital[1 2][:STIMulus][:PATTern]:EXTernal:RANGe</code>
Parameters	2.5 or 5
Parameter Suffix	-
Description	Specifies the input voltage range of the external pattern input (i.e. the modulation input on the rear panel). Setting the input voltage range to 2.5/5 selects $\pm 2.5\text{V}/\pm 5\text{V}$ as full range input voltage. Any other value will be rounded to one of the possible values, either 2.5V or 5V.
Example	<code>:DIG:EXT:RANG 2.5</code>

Command	:DIG:EXT:IMP
Long	:DIGital[1 2][:STIMulus][:PATTern]:EXTernal :IMPedance
Parameters	<nr3>
Parameter Suffix	-
Description	Specifies the input impedance for the external pattern input (i.e. the modulation input on the rear panel). Valid values are 50 Ohm and 10 kOhm. Any other value will be rounded to one of the two possible values.
Example	:DIG:EXT:IMP 50

Command	<code>:DIG:EXT:THR:LOW</code> <code>:DIG:EXT:THR:UPP</code>
Long	<code>:DIGital[1 2][:STIMulus][:PATtern]:EXTernal</code> <code>:THReshold[:LOWer]</code> <code>:DIGital[1 2][:STIMulus][:PATtern]:EXTernal</code> <code>:THReshold:UPPer</code>
Parameters	<code><nr3></code>
Parameter Suffix	-
Description	<p>Defines the threshold to distinguish between logical levels on the external input. Depending on the number of levels (see <code>:DIG:NLEV</code>), a subset of the thresholds are actually used.</p> <p>If <code>NLEV == 2</code>, the <code>LOWer</code> threshold is used to distinguish between '0' and '1'.</p> <p>If <code>NLEV == 3</code>, the <code>LOWer</code> threshold is used to distinguish between '0' and '-', while the <code>UPPer</code> threshold is used to distinguish between '-' and '1'.</p>
Example	<code>:DIG:NLEV 3</code> <code>:DIG:EXT:THR:LOW -0.5</code> <code>:DIG:EXT:THR:UPP 0.5</code>

Command	<code>:DIG:EXT:SAMP</code>
Long	<code>:DIGital[1 2][:STIMulus][:PATTern]:EXTernal :SAMPling</code>
Parameters	AUTomatic FIXed
Parameter Suffix	-
Description	<p>Selects whether the sampling of the external pattern data that is provided at MOD-IN, is done in fixed or automatic mode.</p> <p>Use fixed mode for test setups that allow operation of the external pattern source by a clock signal that is generated by the 81150A / 81160A, or if the external pattern source provides a clock signal that can be used to trigger the 81150A / 81160A via the External-In connector.</p> <p>Use automatic mode for external pattern sources that do not allow to tightly couple the timing systems of pattern source and 81150A / 81160A, or that send patterns in packets with inactivity between the data packets. See External Patterns for more details on externally provided patterns.</p>
Example	<code>:DIG:EXT:SAMP FIX</code>

Command	<code>:MMEM:LOAD:PATT</code>
Long	<code>:MMEMory:LOAD:PATtern</code>
Parameters	<code>VOLATILE, "<filename>"</code>
Parameter Suffix	-
Description	Loads a data pattern from external storage.
Example	<code>:MMEM:LOAD:PATT VOLATILE, "mypattern.pat"</code>

Appendix

Command	:MMEM:LOAD:TRAN
Long	:MMEMory:LOAD:TRANSition
Parameters	VOLATILE, "<filename>"
Parameter Suffix	-
Description	Loads a bit shape transition waveform from external storage.
Example	:MMEM:LOAD:TRAN VOLATILE, "mybitshape.wfm"

Command	<code>:MMEM:STOR:PATT</code>
Long	<code>:MMEMory:STORe:PATtern</code>
Parameters	<code>VOLATILE, "<filename>"</code>
Parameter Suffix	-
Description	Stores a data pattern to external storage.
Example	<code>:MMEM:STOR:PATT VOLATILE, "mypattern.pat"</code>

Appendix

Command	:MMEM:STOR:TRAN
Long	:MMEMory:STORe:TRANsition
Parameters	VOLATILE, "<filename>"
Parameter Suffix	-
Description	Stores a bit shape transition waveform to external storage.
Example	:MMEM:STOR:TRAN VOLATILE, "mybitshape.wfm"

4.6 Common Command List

Command	Description
*CAL?	<p>The Calibration query causes the instrument to perform an internal self-calibration and generates a response that indicates whether or not the device completed the self-calibration without error. Additional information about any calibration errors may be contained in the error queue.</p> <p>The instrument must be completely disconnected from all external equipment before executing *CAL?</p>
*CLS	<p>Clear the event register in all register groups. This command also clears the error queue and cancels a *OPC operation.</p> <p>☞ It doesn't clear the enable register.</p>
*ESE[?]	<p>Enable bits in the Standard Event Status Register to be reported in the Status Byte. The selected bits are summarized in the "Standard Event" bit (bit 5) of the Status Byte Register. The *ESE? query returns a value which corresponds to the binary-weighted sum of all bits enabled decimal by the *ESE command. These bits are not cleared by a *CLS command. Value Range: 0–255.</p>
*ESR?	<p>Query the Standard Event Status Register. Once a bit is set, it remains set until cleared by a *CLS (clear status) command or queried by this command. A query of this register returns a decimal value which corresponds to the binary-weighted sum of all bits set in the register.</p>
*IDN?	<p>Read the instrument's identification string which contains four fields separated by commas. The first field is the manufacturer's name, the second field is the model number, the third field is the serial number, and the fourth field is a revision code which contains four numbers separated by dashes</p> <p>Keysight Technologies, NxxxxA,<serial number>, x.x.x.x-h</p> <p>x.x.x.x= Firmware revision number</p> <p>h = Hardware revision number</p>

Command	Description
*LRN?	Query the instrument and return a binary block of data containing the current settings (learn string). You can then send the string back to the instrument to restore this state at a later time. For proper operation, do not modify the returned string before sending it to the instrument. The returned string will contain about 32K characters. Use <code>:SYST:SET</code> to send down the learn string. See <code>:SYST:SET[?]</code>
*OPC	Set the "Operation Complete" bit (bit 0) in the Standard Event register after the previous commands have been completed.
*OPC?	Return "1" to the output buffer after the previous commands have been completed. Other commands cannot be executed until this command completes.
*OPT?	Read the installed options. The response consists of any number of fields separated by commas.
*PSC {0 1} *PSC?	Clear the Standard Event enable register and Status Byte condition register at power on (*PSC 1). When *PSC 0 is in effect, these two registers <i>are not</i> cleared at power on. The default is *PSC 1. The *PSC? query returns the power-on status clear setting. Returns "0" (do not clear at power on) or "1" (clear at power on).
*RCL	Recall the instrument state stored in the specified non-volatile storage location. You cannot recall an instrument state from a storage location that is empty. *RCL 1 to 4 recalls a stored instrument setting. *RCL 0 recalls the default setting.
*RST	Reset instrument to its factory default state (<i>refer to "Keysight 81150A / 81160A Factory Default Settings" in section 3.21</i>). This command will abort a sweep or burst in progress and will re-enable the front-panel display if it was previously disabled (DISP OFF command).
*SAV	Store (save) the current instrument state in the specified non-volatile storage location. Any state previously stored in the same location will be overwritten (and no error will be generated). There are four locations 1, 2, 3, 4) available.

Command	Description
*SRE [?]	Enable bits in the Status Byte to generate a Service Request. To enable specific bits, you must write a decimal value which corresponds to the binary-weighted sum of the bits in the register. The selected bits are summarized in the "Master Summary" bit (bit 6) of the Status Byte Register. If any of the selected bits change from "0" to "1", a Service Request signal is generated. The *SRE? query returns a decimal value which corresponds to the binary-weighted sum of all bits enabled by the *SRE command.
*STB?	Query the summary (status byte condition) register in this register group. This command is similar to a Serial Poll but it is processed like any other instrument command. This command returns the same result as a Serial Poll but the "Master Summary" bit (bit 6) <i>is not</i> cleared by the *STB? command.
*TRG	Trigger e.g. a sweep, a burst, or a simple pulse from the remote interface depending on the selected instrument function. It is similar to the :TRIG command.
*TST?	Performs a complete self-test of the instrument. Returns "+0" (PASS) or "+1" (FAIL). If the test fails, one or more error messages will be generated to provide additional information on the failure. Use the SYST:ERR? command to read the error queue.
*WAI	Wait for all pending operations to complete before executing any additional commands over the interface.

4.7 Status Model

Introduction

This section describes the structure of the SCPI status system used by the 81150A / 81160A. The status system records various conditions and states of the instrument in several register groups as shown on the following pages. Each of the register groups is made up of several *low level* registers called Condition registers, Event registers, and Enable registers which control the action of specific bits within the register group.

These groups are explained below:

What is a Condition Register?

A condition register continuously monitors the state of the instrument. The bits in the condition register are updated in real time and the bits are not latched or buffered. This is a read-only register and bits are not cleared when you read the register. A query of a condition register returns a decimal value which corresponds to the binary-weighted sum of all bits set in that register.

What is an Event Register?

An event register latches the various events from changes in the condition register. There is no buffering in this register; while an event bit is set, subsequent events corresponding to that bit are ignored. This is a read only register. Once a bit is set, it remains set until cleared by query command (such as `STAT:QUES:EVEN?`) or a `*CLS` (clear status) command. A query of this register returns a decimal value which corresponds to the binary-weighted sum of all bits set in that register.

What is an Enable Register?

An enable register defines which bits in the event register will be reported to the Status Byte register group. You can write to or read from an enable register. A `*CLS` (clear status) command will not clear the enable register but it does clear all bits in the event register. A `STAT:PRES` command clears all bits in the enable register. To enable bits in the enable register to be reported to the Status Byte register, you must write a decimal value which corresponds to the binary weighted sum of the corresponding bits.

What are Transition Filters?

Transition Filters are used to detect changes of the state in the condition register and set the corresponding bit in the event register. You can set transition filter bits to detect positive transitions (PTR), negative transitions (NTR) or both. Transition filters are read/write registers. They are not affected by `*CLS`.

4.7.1 Status register structure

Introduction

The 81150A / 81160A has a status reporting system conforming to IEEE 488.2 and SCPI. The figure below shows the status group available in the instrument.

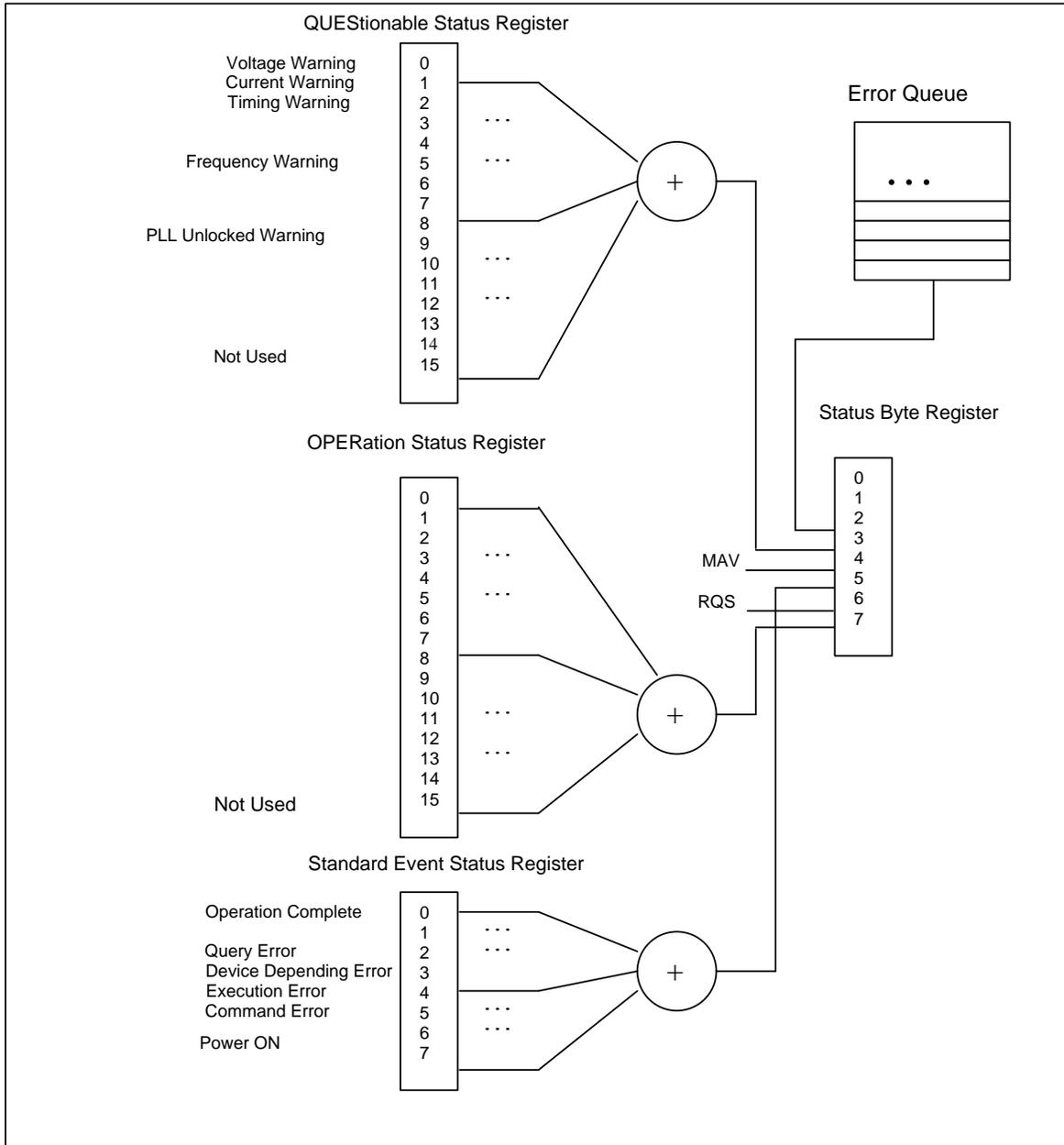

4.7.2 Status Byte Register

Introduction

The Status Byte summary register reports conditions from the other status registers. Data that is waiting in the instrument's output buffer is immediately reported on the "Message Available" bit (bit 4) for example. Clearing an event register from one of the other register groups will clear the corresponding bits in the Status Byte condition register. Reading all messages from the output buffer, including any pending queries, will clear the "Message Available" bit. To set the enable register mask and generate an SRQ (service request), you must write a decimal value to the register using the *SRE command.

Bit Definitions – Status Byte Register

Bit Number	Decimal Value	Definition
0 Not used	1	Not Used. Returns "0"
1 Not used	2	Not Used. Returns "0"
2 Error Queue	4	One or more error are stored in the Error Queue
3 Questionable Data	8	One or more bits are set in the Questionable Data Register (bits must be enabled)
4 Message Available	16	Data is available in the instrument's output buffer
5 Standard Event	32	One or more bits are set in the Standard Event Register
6 Master Summary	64	One or more bits are set in the Status Byte Register
7 Not Used	128	One or more bits set in the Operation Data Register

4.7.3 STATus Commands

Command The PRESet command is an event that configures the SCPI and device-dependant status data structures. The mandatory mechanism is defined in part by the IEEE 488.2.

:STATus:PRESet

It clears all status group event registers. Presets the status group, enables PTR and NTR registers as follows:

ENABLE = 0x0000, PTR = 0xffff, NTR = 0x0000.

4.7.4 STATus Questionable Data Register command subsystem

Introduction The Questionable Data register group provides information about the quality or integrity of the instrument. Any or all of these conditions can be reported to the Questionable Data summary bit through the enable register.

The 81150A / 81160A has two levels of error reporting mechanism called "warnings" and "errors". Checking for warnings and errors is always enabled by switching on the output(s). A warning is generated when due to a combination of worst case uncertainties at the current settings of all relevant parameters, an invalid signal is output. A warning will be reflected in the QUEStionable data register structure. See the following table for definitions.

Bit Definitions – Questionable Data Register

Bit Number		Decimal Value	Definition
0	Voltage warning	1	Output signal could be invalid
1	Current warning	2	Output signal could be invalid
2	Time warning	4	Output signal could be invalid
3	Not used	8	Returns "0"
4	Not used	16	Returns "0"
5	Frequency warning	32	Output signal could be invalid
6	Not used	64	Returns "0"
7	Not used	128	Returns "0"
8	Not used	256	Returns "0"
9	PLL unlocked warning	512	PLL is currently unlocked, the output signal is invalid
10	Not used	1024	Returns "0"
11	Not used	2048	Returns "0"
12	Not used	4096	Returns "0"
13	Not used	8192	Returns "0"
14	Not used	16384	Returns "0"
15	Not used	32768	Returns "0"

**Commands
accessing the
questionable status
group**

The following commands access the questionable status group.

`:STATus:QUEStionable[:EVENT]?`

Reads the event register in the questionable status group. It's a read-only register. Once a bit is set, it remains set until cleared by this command or *CLS command. A query of the register returns a decimal value which corresponds to the binary-weighted sum of all bits set in the register.

`:STATus:QUEStionable:CONDition?`

Reads the condition register in the questionable status group. It's a read-only register and bits are not cleared when you read the register. A query of the register returns a decimal value which corresponds to the binary-weighted sum of all bits set in the register.

`:STATus:QUEStionable:ENABle[?]`

Sets or queries the enable register in the questionable status group. The selected bits are then reported to the Status Byte. A *CLS will not clear the enable register but it does clear all bits in the event register. To enable bits in the enable register, you must write a decimal value which corresponds to the binary-weighted sum of the bits you wish to enable in the register.

`:STATus:QUEStionable:NTRansition[?]`

Sets or queries the negative-transition register in the questionable status group. A negative transition filter allows an event to be reported when a condition changes from true to false. Setting both positive/negative filters true allows an event to be reported anytime the condition changes. Clearing both filters disable event reporting. The contents of transition filters are unchanged by *CLS and *RST.

`:STATus:QUEStionable:PTRansition[?]`

Set or queries the positive-transition register in the questionable status group. A positive transition filter allows an event to be reported when a condition changes from false to true. Setting both positive/negative filters true allows an event to be reported anytime the condition changes. Clearing both filters disable event reporting. The contents of transition filters are unchanged by *CLS and *RST.

4.8 Programming Basics

Introduction This chapter provides the information you need for programming the 81150A / 81160A using the Keysight IO Libraries Suite. Familiarity with the Keysight IO Libraries Suite is instrumental in understanding the remote programming of the 81150A / 81160A.

See the user documentation delivered with the Keysight IO Libraries Suite for information on how to use them.

Depending on the options of your 81150A / 81160A, (e.g. one channel or two channel instrument) some of the following functions may not be valid. See the integrated Help or the User's Guide for a more detailed description of available options.

4.8.1 Before you begin

Introduction This section provides background information that you need before you start with remote programming.

Connecting to the instrument

Introduction

To communicate with the generator from a remote computer, the Keysight IO Libraries Suite must be installed on this computer.

The following description only provides you with the information you need for the instrument. For complete instructions on how to establish connections to the instrument, refer to the user documentation delivered with the Keysight IO Libraries Suite.

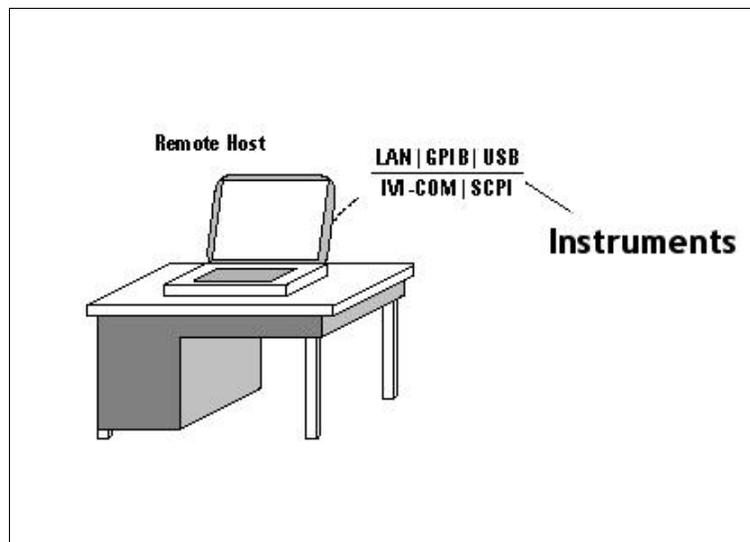

The instrument supports the following possibilities for remotely connecting:

LAN

The instrument's network settings are managed by the internal instrument software and the connected network environment. You can press the Utility key at the front panel, select I/O interface -> LAN using the instrument's softkeys to get the network setting. The default setting for DHCP (Dynamic Host Configuration Protocol) is ON. Contact your network administrator if you need help in defining your own instrument's IP address.

GPIB

To connect to the generator via GPIB you have to have the instrument's GPIB address. To see the address on the display press the Utility key at the front panel, select I/O Interface using the instrument's softkeys. The default address is 10. When setting the GPIB address, it is recommended that you do not use the GPIB address 21. This address is reserved for a GPIB controller.

USB

The generator has a device type USB port on the rear panel for remote programming. This is the non-flat USB port close to the LAN connector. To connect to the instrument via USB, you need the instrument's USB ID. If the instrument's USB port is connected to a computer via an adequate USB cable a dialog will pop up automatically. This dialog generated by the Keysight IO Library Suite shows the USB ID. You can either use the full VISA resource string or assign an alias. See the Keysight IO Libraries Suite documentation for details.

Instrument Behavior

Introduction

The generator behaves as follows when it is turned on:

Instrument Mode

At power on, the generator will return to the same mode as it was powered down. Normally, once it has booted, the instrument is ready for either front panel operation or remote operation.

Registers and Filters

At power on, the state of the registers and filters is:

All registers and filters are set to its initial state except the PON bit of the Standard Event Status Register. The PON (Power ON) event bit indicates that an off-to-on transition has occurred in the device's power supply.

All bits of Positive Transition Filter will be set and all bits of the Negative Transition Filter will be cleared.

Local Mode

In Local Mode, all the front panel controls are responsive and control the instrument.

Remote Mode

In Remote Mode, the front panel controls are inoperative and the instrument is controlled by a remote client. The front panel display reflects the remote programming commands received.

The instrument automatically enters remote mode when a command has been received from the remote client. This is indicated by a small icon on right hand side of the display.

Returning to Local Mode

To return to local mode, press the front panel Graph (Local) key. When you power-cycle the instrument, it will also start in local mode.

Overheat Protection

The generator protects itself from damage by overheating by shutting down itself in such cases. If the temperature exceeds a certain threshold the instrument will immediately shut down itself as mentioned and a self-test error will be stored in the instrument's error queue when the instrument is switched on again.

4.8.2 Application Programs

Introduction

This chapter contains several remote interface example programs to help you develop programs for your own application. Chapter 4 Remote Programming Reference lists the syntax for the SCPI (Standard Commands for Programmable Instruments) commands available to program the generator.

These example programs are included in this chapter to demonstrate controlling the instrument using SCPI commands. All of these programs are created by means of Microsoft Visual Studio 2005 and use the Keysight IO Library Suite features.

*Visual Studio 2005 C++/Unmanaged - *IDN*

Introduction

This example program queries via the GPIB interface the instrument for an identification string and prints the result.



- You must change the address accordingly. Here 10 is used as the default address of the instrument.
- Your application must link to VISA import libraries. To keep this example simple, configuring the Visual Studio 2005 is not described.

Appendix

```
#include <visa.h>
#include "stdafx.h"

int _tmain(int argc, _TCHAR* argv[])
{
    ViStatus errorStatus = 0;
    ViSession viRm = 0, vi = 0;

    char buf [0xffff] = {0};

    /* Open session to GPIB device at address 10 */
    errorStatus = viOpenDefaultRM(&viRm);
    errorStatus = viOpen(viRm, "GPIB0::10::INSTR",
                        VI_NULL, VI_NULL, &vi);

    /* Send an *IDN? string to the device */
    viPrintf (vi, "*IDN?\n");

    /* Read results */
    viScanf (vi, "%t", &buf);
    printf ("IDN? response: %s\n", buf);

    /* Close session */
    viClose (vi);
    viClose (viRm);

    return 0;
}
```

Example output of the short C++ / Unmanaged program above:

```
IDN? response: Keysight Technologies, 81150A /
81160A, DE1234567, 0.22.104.12-0
```

Visual Studio 2005 C++/Unmanaged – Block Transfer

Introduction

Download binary or decimal integer values from 8191 to -8191 into volatile memory of the instrument. You can download from 1 to $\text{Sample}_{\text{max}}$ points per waveform in IEEE 488.2 binary block format or as a list of values.

81150A: $\text{Sample}_{\text{max}} = 524288$ (512 k)

81160A 1 channel: $\text{Sample}_{\text{max}} = 262144$ (256 k)

81160A 2 channels: $\text{Sample}_{\text{max}} = 131072$ (128 k)

The following small example downloads a created waveform in binary format and shows the formatting string for the alternative format 'list of values' (it is just a comma separated list of integer values).

You have to specify a timeout value using the `viSetAttribute` function if a large block of data has to be transferred to the instrument. The transfer of a data block as a comma separated value list is also time-consuming. E.g. `viSetAttribute (vi, VI_ATTR_TMO_VALUE, VI_TMO_INFINITE);`

Do not forget to reset the timeout to the previous setting after the waveform data transfer has finished.

Appendix

```
#include <visa.h>
#include "stdafx.h"

int _tmain(int argc, _TCHAR* argv[])
{
    ViStatus errorStatus = 0;
    ViSession viRm = 0, vi = 0;

    /* Open session to GPIB device at address 10 */
    errorStatus = viOpenDefaultRM(&viRm);
    errorStatus = viOpen(viRm, "GPIB0::10::INSTR",
                        VI_NULL, 10000, &vi);

    double pi, temp_waveform, n_cycles, damp_factor, data_size;
    short waveform[16000];
    long i;
    char cmd_str[50];

    // Setup the waveform
    pi = 3.14159; // The approximate value of PI
    n_cycles = 16; // Total number of cycles
    damp_factor = -5; // Damping factor
    data_size = 16000;

    // Generate the waveform
    for (i=1; i <= ((long)data_size); i++)
    {
        temp_waveform = sin(2*pi*n_cycles*(i)/data_size)*8191;
        waveform[i-1] = (short)(temp_waveform *
                                exp(damp_factor*i/data_size));
    }

    // Set byte order for binary block data transfer;
    // order depends on computer and GPIB card used;
    // NORMAl = most significant bit (MSB) sent first,
    // SWAPped = least significant bit (LSB) sent first
    viPrintf(vi, "FORMat:BOReDer NORMAl\n");

    // Setup cmd_str for the viPrintf function to send block data
    // cmd_str should look like this:
    // "DATA:DAC VOLATILE,%16000hb\n"
```

```
sprintf(cmd_str, "%s %%dhb\n",
        "DATA:DAC VOLATILE,", (long)(data_size));

// A comma separated list of values use this format
// Setup cmd_str for the viPrintf function to send integer
// list data
// sprintf(cmd_str, "%s %, %dh\n",
//         "DATA:DAC VOLATILE,", (long)(data_size));

//Set timeout to infinite
errorStatus = viSetAttribute(vi, VI_ATTR_TMO_VALUE,
                             VI_TMO_INFINITE);

// Write the data to the instrument
errorStatus = viPrintf(vi, cmd_str, waveform);

//restore standard timeout
errorStatus = viSetAttribute(vi, VI_ATTR_TMO_VALUE, 2000);

/* Close session */
viClose (vi);
viClose (viRm);

return 0;
}
```

Visual Studio 2005 C++/Unmanaged – Linear Sweep

Introduction This program creates a linear sweep for a sine wave. It sets the start and stop frequency, and the sweep time. Here the instrument's second channel parameters are changed and additionally the error queue is read out.

```
#include <visa.h>
#include "stdafx.h"

int _tmain(int argc, _TCHAR* argv[])
{
    ViStatus errorStatus = 0;
    ViSession viRm = 0, vi = 0;

    /* Open session to GPIB device at address 10 */
    errorStatus = viOpenDefaultRM(&viRm);
    errorStatus = viOpen(viRm, "GPIB0::10::INSTR",
                        VI_NULL, 10000, &vi);

    // Reset the function generator
    viPrintf(vi, "*RST?\n");
    // Clear error and status register
    viPrintf(vi, "*CLS\n");

    // Select waveshape
    viPrintf(vi, ":FUNCTION2 SINusoid\n");
    // Load impedance to 50Ohm
    viPrintf(vi, ":OUTput2:LOAD 50\n");
    // Amplitude to 1.0 Vpp
    viPrintf(vi, ":VOLTage2 1.00\n");
    // Set LINEar/LOG spacing
    viPrintf(vi, "SWEep2:SPACing LINear\n");
    // Sweep time is 1 second
    viPrintf(vi, "SWEep2:TIME 1\n");
    // Sweep start freq is 123Hz
    viPrintf(vi, "FREQuency2:STARt 123\n");
    // Sweep stop freq is 20kHz
    viPrintf(vi, "FREQuency2:STOP 20e3\n");
}
```

```
// Turn on output (channel 2)
viPrintf(vi, "OUTPut2 on\n");
// Turn sweep on
viPrintf(vi, "SWEep2:STATe ON\n");

ViChar    err_msg[256];
ViInt32   err_num;

// Check for first error
viQueryf(vi, "SYSTem:ERRor?\n", "%d,%t", &err_num, err_msg);
printf("Error Number: %d; Error Message: %s\n", err_num,
       err_msg);
/* Close session */
viClose (vi);
viClose (viRm);

return 0;
}
```

The following is a summary of the VISA function calls used in the previous example programs. For more detailed explanation of VISA functionality, see Keysight IO Libraries Suite “Programming with VISA”.

<code>visa.h</code>	This file is included at the beginning of the file to provide the function prototypes and constants defined by VISA.
<code>ViSession</code>	The <code>ViSession</code> is a VISA type data type. Each program that will establish a communication channel must be defined as <code>ViSession</code> .
<code>viOpenDefaultRM</code>	You must first open a session with the default resource manager.
<code>viOpen</code>	This function establishes a communication channel with the device specified. This call must be made for each device you will be using.
<code>viPrintf, viScanf</code>	These are the VISA formatted “C like” I/O functions.
<code>viClose</code>	This function must be used to close each session. All allocated data structures that had been allocated for the session, will be deallocated.
<code>viSerAttribute</code>	This function is used to change attributes of an active <code>ViSession</code> .

5 Error Messages

Introduction

The 81150A / 81160A has two levels of error reporting called “*warnings*” and “*errors*”. Checking for errors and warnings is always enabled, unless you switch off the output(s).

Warning

A **warning** is generated when the output signal could be invalid due to a combination of worst case uncertainties at the current settings of all relevant parameters.

For example, when adjusting the pulse width, all other timing parameters and their uncertainties have to be considered in order to check if the width setting will fit within the pulse period.

✎ The warning limits are therefore not fixed for a particular parameter, but vary with the settings of the related parameters. It is also possible that the error and warning limits are the same, that is, a warning does not occur before the error limit is reached.

If a warning occurs, the settings are still implemented in the hardware because the worst-case conditions used to evaluate the warning limits are very unlikely to occur in practice.

A blinking **W** indicates that one or more warnings have occurred. The first 5 warning messages will be displayed on the screen. These messages will stay active until the warning condition is changed by changing the settings

of the respective parameter. Press  to view the warning list.

Error

An **error** is generated when an invalid mode is chosen, or the required parameter settings cannot be implemented in the output hardware. Multiple errors can occur, but only the first 5 errors detected are displayed.

An error is indicated by a blinking **E**. These messages will stay active until the error condition is changed by changing the settings of the respective parameter.

If the instrument has both, an error and a warning condition together, then the text indicating the error condition will be shown on the display. If you

press the  key, the description for the errors will be shown first. However, you can see the description of warnings by pressing the **Warning** softkey.



If the output(s) are switched off and you are using the knob to adjust parameters, it is usually not possible to generate warnings or errors. All parameters are automatically limited to settings that guarantee specified operation.

6 Application Programs

Introduction

The enclosed CD contains several remote interface example programs to help you develop programs for your own application. Chapter 4, “Remote Interface Reference”, lists the syntax for the SCPI (Standard Commands for Programmable Instruments) commands available to program the function generator.

Several example programs are given in the CD to demonstrate controlling the Keysight 81150A / 81160A using SCPI commands. These example programs are written in Microsoft® Visual BASIC® 6.0 and use the Keysight VISA-COM objects for example, C sharp or VC++, examples are also available.

The example programs given in the CD illustrate the use of several drivers and environments. Also included is the “Keysight BenchLink Waveform Builder for the 81150A / 81160A Waveform Generator”. For a detailed description of these programs, refer to the “readme” file in the “Examples” directory.

If you want to modify the example programs, or write your own programs and compile them, you will need to install the Keysight E2094 I/O Libraries software:

- **If you are using GPIB.** The Keysight E2094 I/O Libraries software is provided with Keysight GPIB I/O products. The software should have been loaded when you installed your GPIB interface card in your PC.
- **If you are using USB or LAN.** If you don't have a copy, you can order the Keysight E2094 I/O Libraries software on CD-ROM. You must have version M (order Keysight product number E2094M) or a later version to support USB and LAN.

You can obtain the Keysight I/O Libraries through the Keysight Developer Network. Go to www.keysight.com/find/adn and purchase an ADN Professional Membership. This gives you the right to download the latest version of the Keysight I/O Libraries. Look for the Keysight I/O Libraries link under "Downloads" on the ADN web site.

The programs given in the CD are protected by copyright.

Copyright © 2007 Keysight Technologies

You have a royalty-free right to use, modify, reproduce and distribute the Sample Application Files (and/or any modified version) in any way you find useful, provided that you agree that Keysight has no warranty, obligations, or liability for any Sample Application Files.

Keysight Technologies provides programming examples for illustration only. All sample programs assume that you are familiar with the programming language being demonstrated and the tools used to create and debug procedures. Keysight support engineers can help explain the functionality of Keysight software components and associated commands, but they will not modify these samples to provide added functionality or construct procedures to meet your specific needs.

7 Tutorial

Introduction

In order to achieve the best performance from the Keysight 81150A / 81160A, it may be helpful for you to gain a better understanding of the internal operations of the instrument. This chapter describes basic signal-generation concepts and gives specific details on the internal operations of the 81150A / 81160A. This chapter explains the following:

- Direct Digital Synthesis
- Creating Arbitrary Waveforms
- Pulse Waveform Generation
- Pattern Generation
- Trigger Modes
- External In to Trigger Out Timing
- Signal Imperfections
- Output Amplitude Control
- Attributes of AC Signals
- Modulation
- Frequency Sweep
- Burst
- Channel Addition
- Coupling between Channels

You can use an arbitrary waveform generator in a variety of applications where it might be otherwise difficult or impossible to generate complex output waveforms. With an arbitrary waveform generator, signal imperfections such as rise time, ringing, glitches, noise, and random timing variations can be easily simulated in a controlled manner.

Physics, chemistry, biomedicine, electronics, mechanics, and other fields can benefit from the versatility of an arbitrary waveform generator. Wherever things vibrate, pump, pulse, bubble, burst, or change with time in any way, there are possible applications – limited only by your ability to specify the waveform data.

7.1 Direct Digital Synthesis

Introduction

The Keysight 81150A / 81160A uses a signal-generation technique called Direct Digital Synthesis (DDS) for all waveform functions except noise. As shown below, a stream of digital data representing the desired waveform is sequentially read from waveform memory and is applied to the input of a digital-to-analog converter (DAC). The DAC is clocked at the 81150A / 81160A's sampling frequency of 2 GHz for the 81150A (2.5 GHz for the 81160A) and outputs a series of voltage steps approximating the desired waveform. A low-pass "anti-aliasing" filter then smoothes the voltage steps to create the final waveform.

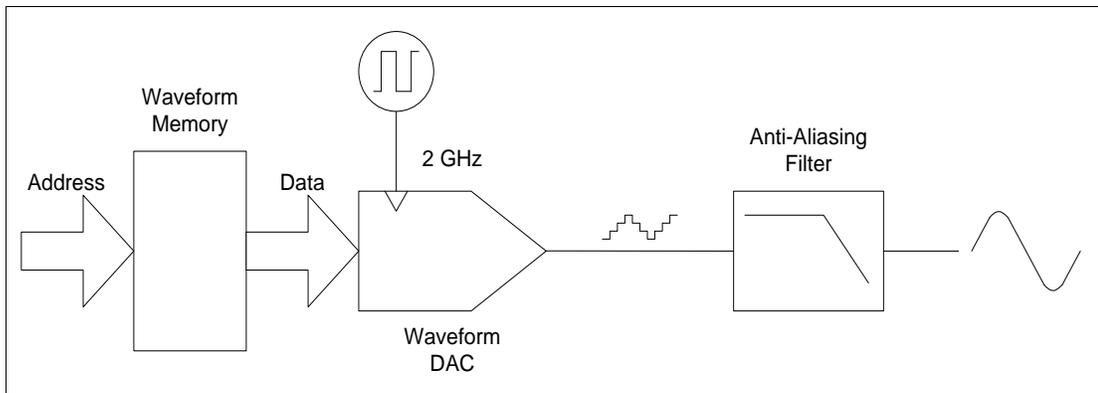

Direct Digital Synthesis Circuitry

Direct Digital Synthesis Circuitry

The 81150A / 81160A uses two anti-aliasing filters. A linear-phase filter is used for all waveform functions.

For standard waveforms, and arbitrary waveforms that are defined with fewer than 16,384 (16K) points, the 81150A / 81160A uses waveform memory that is 16K words deep. For arbitrary waveforms that are defined with more than 16K points, the 81150A uses waveform memory that is 524288 (512K) words (81160A uses 32k/64k/128k(2ch) or 64k/128k/256k(2ch)) deep.

Waveform Memory The 81150A / 81160A represents amplitude values by 16,384 discrete voltage levels (or 14-bit vertical resolution). The specified waveform data is divided into samples such that one waveform cycle exactly fills waveform memory (see the illustration below for a sine wave). If you create an arbitrary waveform that does not contain exactly 16K or $\text{Sample}_{\text{max}}$ points, the waveform is automatically “stretched” by repeating points or by interpolating between existing points as needed to fill waveform memory.

81150A: $\text{Sample}_{\text{max}} = 524288$ (512 k)

81160A 1 channel: $\text{Sample}_{\text{max}} = 262144$ (256 k)

81160A 2 channels: $\text{Sample}_{\text{max}} = 131072$ (128 k)

Since all of waveform memory is filled with one waveform cycle, each memory location corresponds to a phase angle of $2\pi/16,384$ radians or $2\pi/\text{Sample}_{\text{max}}$ radians.

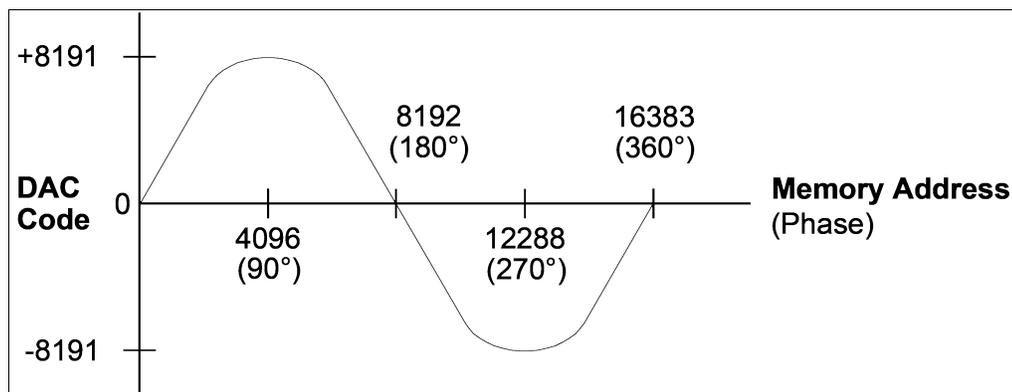

Sine Wave Representation in Waveform Memory

Phase Increment Register (PIR)

Direct digital synthesis (DDS) generators use a phase accumulation technique to control waveform memory addressing. Instead of using a counter to generate sequential memory addresses, an “adder” is used (see the following page). On each clock cycle, the constant loaded into the phase increment register (PIR) is added to the present result in the phase accumulator. The most-significant bits of the phase accumulator output are used to address waveform memory. By changing the PIR constant, the number of clock cycles required to step through the entire waveform memory changes, thus changing the output frequency.

The PIR determines how fast the phase value changes with time and thereby controls the frequency being synthesized. More bits in the phase accumulator result in finer frequency resolution. Since the PIR affects only the rate of change of the phase value (and not the phase itself), changes in waveform frequency are phase-continuous.

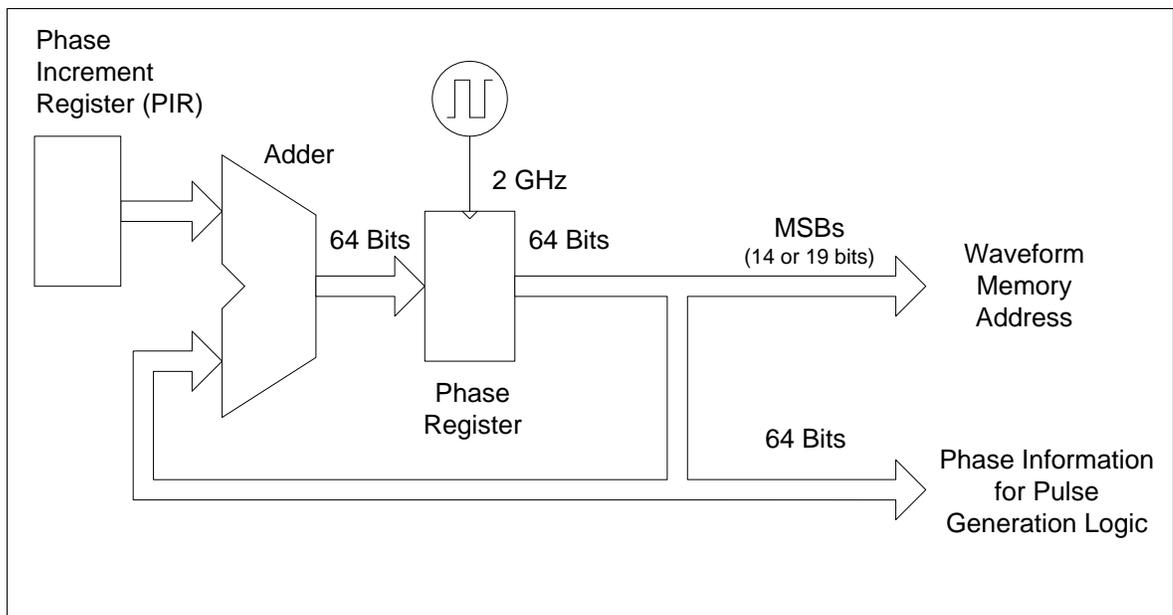

Phase Accumulator Circuitry of 81150A



81160A is clocked with 2.5GHz.

Phase Accumulator The 81150A and 81160A use a 64-bit phase accumulator which yields $2^{-64} \times 2$ GHz or 2.7 picohertz for 81150A ($2^{-64} \times 2.5$ GHz or 3.4 picohertz for 81160A) frequency resolution internally.

Only the 14 or 19 (values of the 81150A) most-significant bits of the Phase Register are used to address waveform memory. Therefore, when synthesizing low frequencies (less than 122,07 kHz for a typical, 16K point waveform), the address will not change in every clock cycle. However, at higher frequencies (greater than 122,07 kHz), the address will change by more than one location during each clock cycle and some points will be skipped. If too many points are skipped, a phenomenon known as “aliasing” will occur and the waveform output will become somewhat distorted.



The Nyquist Sampling Theorem states that in order to prevent aliasing, the highest frequency component of the desired output waveform must be less than half of the sampling frequency (2 GHz for the 81150A / 2.5 GHz for the 81160A).

7.2 Creating Arbitrary Waveforms

Introduction

The Keysight 81150A allows you to create arbitrary waveforms of up to 512K points (524288 points) (81160A 1ch: 262144 points; 81160A 2ch: 131072 points), and provides seven built-in examples of arbitrary waveforms. You can create an arbitrary waveform from the front panel, or you can use the Keysight BenchLink Waveform Builder software provided on the CD-ROM included with the Keysight 81150A / 81160A. The Keysight BenchLink Waveform Builder software allows you to create arbitrary waveforms using a graphical user interface on your PC, and then download them into the Keysight 81150A / 81160A. You can also capture waveforms from your Keysight oscilloscope and import them into BenchLink.

Creating a waveform

For most applications, it is not necessary to create an arbitrary waveform with a specific number of points since the function generator will repeat points (or interpolate) as necessary to fill waveform memory. For example, if you specify 100 points, each waveform point will be repeated an average of 16,384 / 100 or 163.84 times. For the 81150A / 81160A, you do not have to change the length of the waveform to change its output frequency. All you have to do is create a waveform of any length and then adjust the function generator's output frequency. However, in order to get the best results (and minimize voltage quantization errors), it is recommended that you use the full range of the waveform DAC.

When entering waveform points from the function generator's front panel, you are not required to enter the points at evenly-spaced intervals in time. You can always add additional points as needed where the waveform is more complex. From the front panel only, you can also use linear interpolation to smooth the transition between waveform points. These features make it possible to create useful arbitrary waveforms using a relatively small number of points.

With the 81150A, you can output an arbitrary waveform to an upper frequency limit of 120 MHz (81160A: 330 MHz). However, note that the useful upper limit is usually less due to the function generator's bandwidth limitation and aliasing. Waveform components above the function generator's -3 dB bandwidth will be attenuated.

Creating a waveform

An example of the 81150A: Consider an arbitrary waveform consisting of 10 cycles of a sine waveform. When you set the function generator's frequency to 24 MHz, the actual output frequency will be 240 MHz and the amplitude will be attenuated by approximately 11 dB. As you increase the frequency above

24 MHz, more attenuation will occur. At approximately 60 MHz, waveform distortion due to aliasing will become evident. Some aliasing will be present in most arbitrary waveforms, but whether or not it will be troublesome depends on your specific application.

When creating arbitrary waveforms, the function generator will always attempt to replicate the finite-length time record to produce a periodic version of the data in waveform memory. However, as shown below, it is possible that the shape and phase of a signal may be such that a discontinuity is introduced at the end point. When the wave shape is repeated for all time, this end-point discontinuity will introduce leakage errors in the frequency domain because many spectral terms are required to describe the discontinuity.

Leakage Error

Leakage error is caused when the waveform record does not include an integral number of cycles of the fundamental frequency. Power from the fundamental frequency, and its harmonics, is transferred to the spectral components of the rectangular sampling function. You can reduce leakage errors by adjusting the window length to include an integer number of cycles or by including more cycles within the window to reduce the residual end-point discontinuity size. Some signals are composed of discrete, non-harmonically related frequencies. Since these signals are non-repetitive, all frequency components cannot be harmonically related to the window length. You should be careful in these situations to minimize end-point discontinuities and spectral leakage.

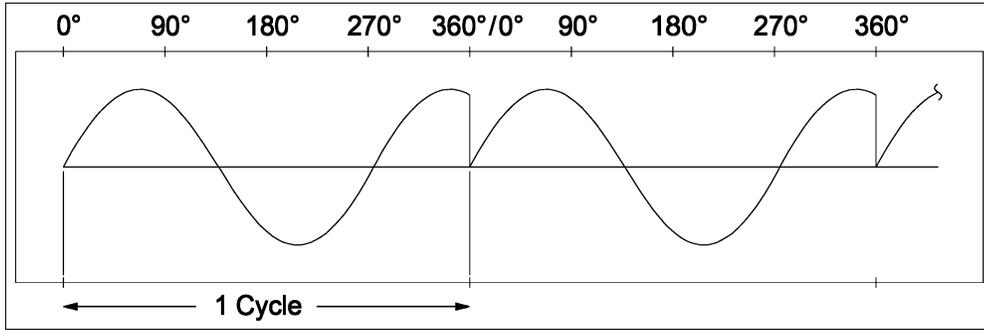

Arbitrary Waveform with Discontinuity

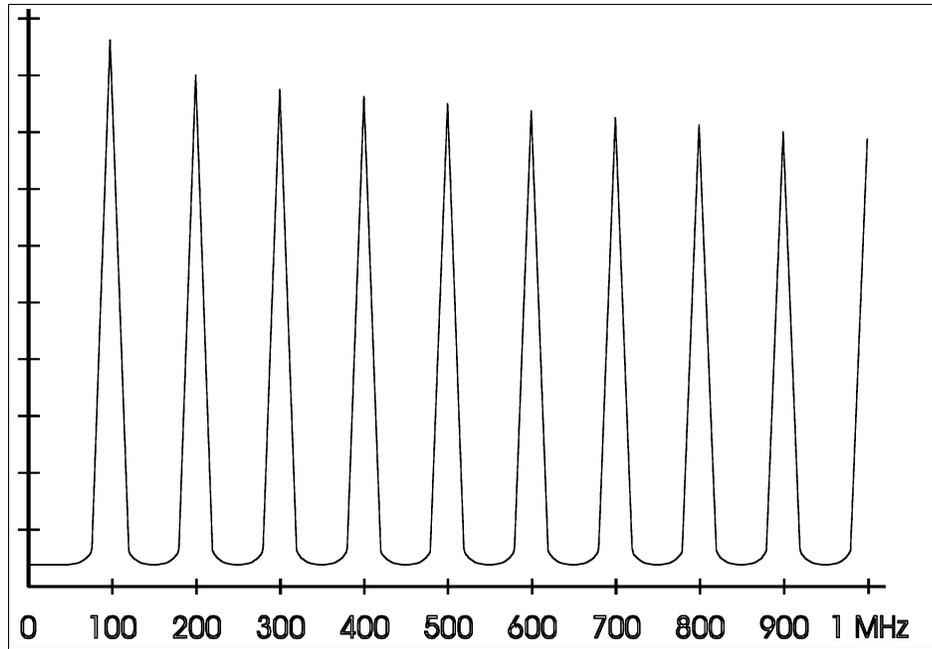

Spectrum of Above Waveform at 100 kHz

7.3 Pulse Waveform Generation

Introduction

The Keysight 81150A / 81160A uses a modified DDS scheme for pulse, square and ramp waveform generation.

The full 64 bit phase information is used for the timing calculations. Every sample for the waveform DAC is computed by arithmetic-logic units. This prevents the need to reprogram a waveform memory if one of the pulse parameter changes.

All timing changes are synchronized with the pulse period so that there are no glitches in the output signal as long as the period is small. Signal generation will be reset if the period is greater than 100 ms to guarantee reasonable response times when changing the timing parameters.

The pulse waveform generation logic is represented in the diagram shown below for the 81150A.



The 81160A uses a 2.5 GHz clock.

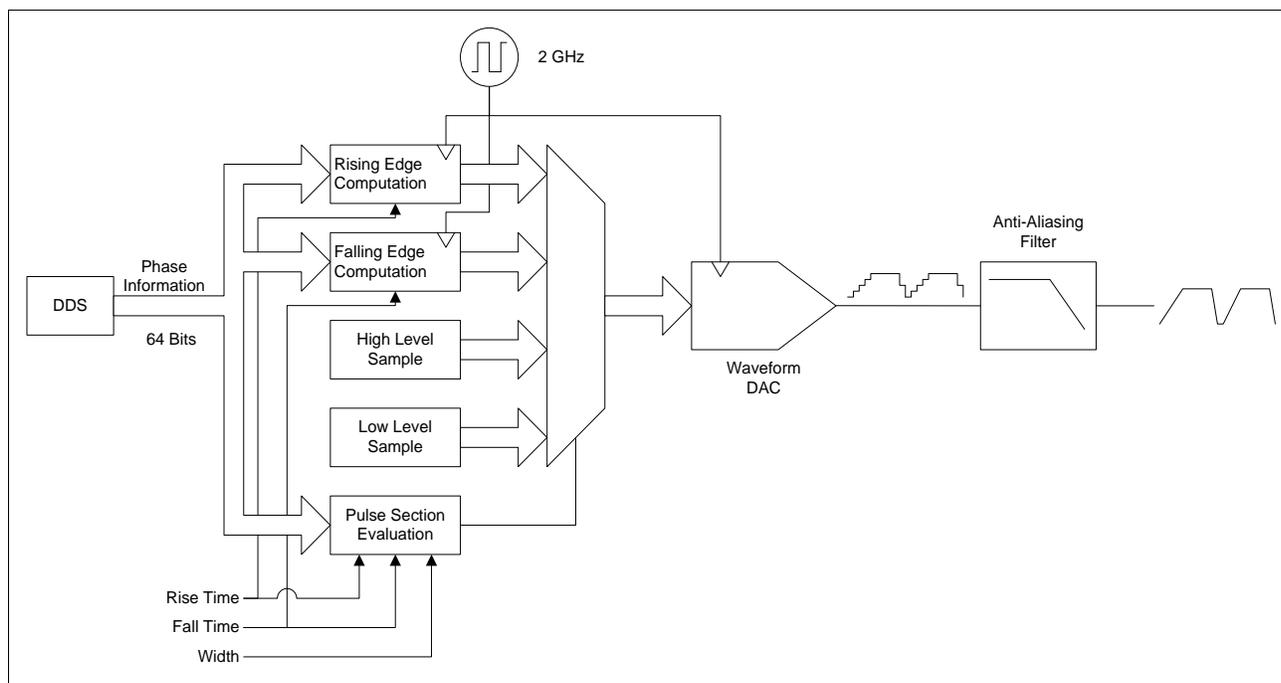

Pulse Generation Block Diagram

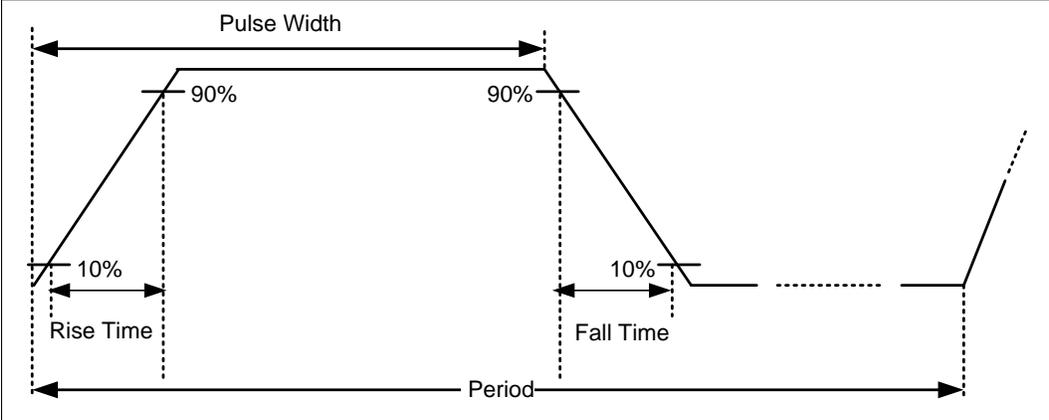

Pulse Waveform Parameters

7.4 Pattern Generation

Introduction

The 81150A / 81160A's pattern functionality is implemented as an extension of the Pulse Mode. In addition to RZ pulses, it allows the generation of pattern sequences that are using either NRZ formatting with adjustable transition times as well as arbitrary transition definitions which are being referred as bit shapes. The pattern generation itself allows the definition of pattern sequences with 2, 3 or 4 different level settings, which allows the emulation of electrical idle sequences as being required in several serial data protocols like USB 1.1, Flexray or CAN.

7.4.1 Multi-Level Pattern Definitions

Introduction

Unlike most other pattern generators in the market, the 81150A / 81160A allows the generation of digital data streams with 2, 3 or 4 different output levels.

The number of levels that are used during the pattern generation is being defined when creating a new pattern and cannot be changed afterwards.

The definition of the output level that is being used by one bit is as follows:

2 Level Patterns	Logical Bit Value/Symbol	Output Level
	0	Low Level
	1	High Level
3 Level Patterns	Logical Bit Value/Symbol	Output Level
	0	Low Level
	- (electrical idle bit)	Offset Level
	1	High Level
4 Level Pattern	Logical Bit Value/Symbol	Output Level
	0	Low Level
	1	Low Level + $\frac{1}{3}$ * Amplitude Voltage
	2	Low Level + $\frac{2}{3}$ * Amplitude Voltage
	3	High Level



- The definition of the output levels above is only valid for NRZ formatted patterns.
- When using arbitrary bitshapes, the number of levels basically only defines how many different level transitions can be defined. It is up to the user how the output level is being defined for the arbitrary bitshapes. The High and Low Level that is configured on the outputs will only define the levels that will be achieved for minimum and maximum DAC settings (+/-8191). The particular output level is defined by the used DAC value(s) in the arb bitshape and can be distributed between High and Low Level as required by the application.

7.4.2 Pattern Types and Sequencing Capabilities

Introduction

Internally 2 types of patterns can be generated:

- **81150A:** Memory based patterns with a length of up to 16 Mbit for 2-level patterns and up to 8 MSymbols for 3- and 4-level patterns.
- **81160A 1 channel:** Memory based patterns with a length of up to 4 Mbit for 2-level patterns and up to 2 MSymbols for 3- and 4-level patterns.
- **81160A 2 channels:** Memory based patterns with a length of up to 2 Mbit for 2-level patterns and up to 8 MSymbols for 3- and 4-level patterns.
- Algorithmically generated PRBS patterns with a polynomial of 7, 9, 11, 15, 23 and 31.

The 81150A / 81160A allows 2 different modes of pattern playback. First there is the sequential playback of all bits in the pattern being used. In case of continuous trigger mode, this will continuously output the pattern at the output. In addition to this, it is possible to split the pattern into 2 parts, with the repetition being only executed on the second part of the pattern. This allows to setup preamble and payload definitions, where the preamble is initializing the device under test, while the test itself is being done with the looped payload part of the pattern.

✎ The preamble/payload model is not available when using the predefined PRBS patterns.

The pattern definition contains the definition of a loop offset. This loop offset is controlling at which bit inside the data pattern the pattern generation will continue when the end of the pattern has been reached. By setting this value to 0, all bits of the pattern will be looped, while for non-zero loop offsets, only the bits beginning at the loop offset will be generated at the second and all following repetitions.



Once the sequencing is started, there is no way to stop or restart the sequence since the looped part of the pattern will simply be repeated continuously. If there is the need to have a restartable pattern with preamble and looped payload, then set the Pattern Trigger Mode to BLOCK and enable Burst Mode. In this case the preamble part of the pattern will be generated once, while the payload part of the pattern will be repeated N time. With N being the configured burst length. The sequence will stop after the burst has reached the number of block repetitions and the 81150A / 81160A is awaiting the next trigger event, which in turn will reset the sequence to the start of the preamble and initiate another playback of the preamble and N repetitions of the payload.

7.4.3 Trigger Modes

Introduction

In continuous trigger mode, the pattern is continuously generated at the output. If the loop offset is set to a non-zero value, the preamble part of the pattern is generated only once.

The 81150A / 81160A is using the concept of 'last cycle completed' when using triggered or gated modes, which means that a pulse, burst or arbitrary waveform is always completed before the next trigger event or active gate state will be processed.

When using pattern generation, the definition of a 'cycle' is selectable between the entire pattern (a block) and a single bit. This allows to either trigger one complete run of the pattern sequence being used, or to trigger/gate each bit in the pattern sequence individually.

Note that in burst mode, a triggered/gated burst of bits does generate as many bits as defined by the burst length, while a burst of 'blocks' does generate as many repetitions of the pattern as the burst length defines.

In gated mode, the bit or block is always completed when the gate signal is getting deasserted. After stopping, the output level will be held constant at the last bits value.

The selection whether the pattern is being bit or block triggered is done on the trigger mode screen.

7.4.4 Defining the Shape of a Bit

Introduction The NRZ signals and the Arbitrary Bit Shapes are explained in this section.

NRZ Signals

Introduction In NRZ mode, the transition times can be adjusted using the leading edge parameter. The transition time defines the time it takes to move from one signal level to the next one.

Transition times in NRZ mode are configured on the Pulse Screen using the Leading Edge Parameter. The transition time is specified from 10% to 90% of Amplitude. Refer to the Pulse Parameter Definitions for more details.

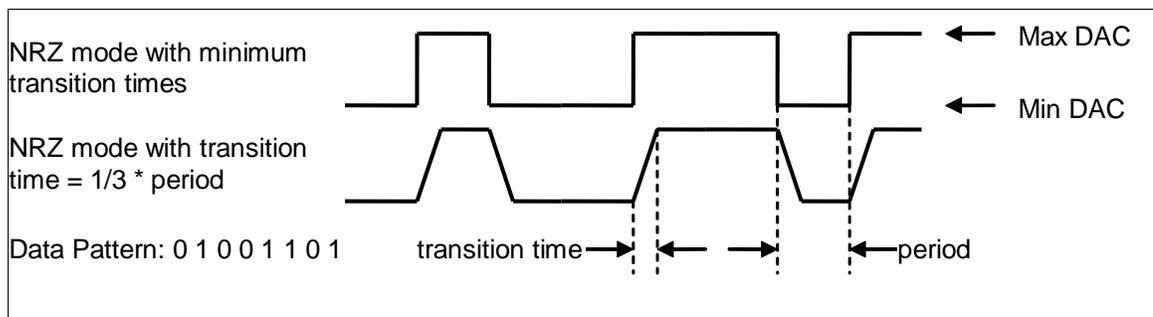

Arbitrary Bit Shapes

Introduction

In contrast to NRZ mode, there is no fix association between the logical bit value (e.g. 0 and 1 for 2-level patterns) and the voltage level at the output in arbitrary bit shape mode. Instead of the simple logical bit value to output voltage mapping, an arbitrary waveform is being used to define the transition from one voltage level to the next one.

For a 2-level pattern, there are 4 different transitions (0 → 0, 0 → 1, 1 → 0, and 1 → 1), for 3-level patterns there are 9 possible transitions and for 4-level patterns there are 16 transitions that need to be defined.

Each type of transition is selecting the shape of the following bit. The bit shape is defined as an arbitrary waveform with up to 64 points. The bit shape editor is separating the several bit shapes by vertical lines. The possible bit shapes are ordered in a way that all bits that are coming from the same logical bit value (e.g. 1) are kept together and inside that group, the logical bit value (or level index) of the target bit is increasing (e.g. 0, 1, ' for 3-level patterns).

Appendix

Number of Levels	Level Index	Current Symbol	Next Symbol
2	0	'0'	'0'
	1	'0'	'1'
	2	'1'	'0'
	3	'1'	'1'
3	0	'0'	'0'
	1	'0'	'1'
	2	'0'	'-'
	3	'1'	'0'
	4	'1'	'1'
	5	'1'	'-'
	6	'-'	'0'
	7	'-'	'1'
	8	'-'	'-'
4	0	'0'	'0'
	1	'0'	'1'
	2	'0'	'2'
	3	'0'	'3'
	...		
	13	'3'	'1'
	14	'3'	'2'
	15	'3'	'3'

Transition Time

In arbitrary bit shape mode, leading and trailing edge are not available as adjustable parameters since they are a part of the transition definition. But the transition time does vary with changing frequency in this case.

The benefit of describing the transition from one bit value to the following one is that the value of the previous bit does have influence the current bit. This allows the emulation of various real world effects and distortions like capacitive loads, asymmetric delay or crossing point deviations, as well as duty-cycle distortions or arbitrary transition times. The use cases are almost unlimited, as long as the required signal transitions can be expressed by an arbitrary waveform and do not depend on anything else than the value of the previous and current bit.

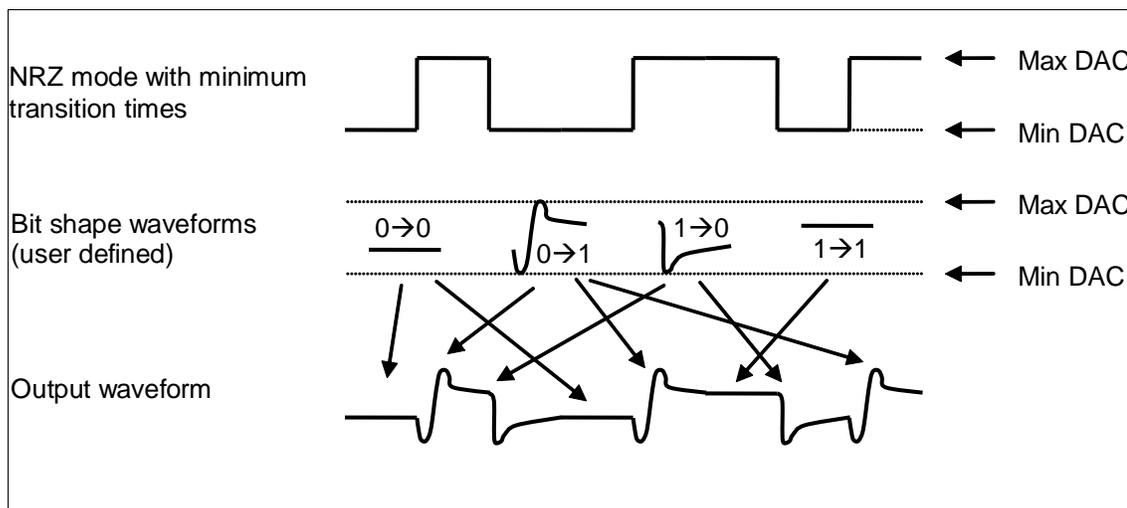

7.4.5 External Patterns

Introduction

In some applications a memory or algorithm (PRBS) based pattern generation cannot cover all the required test patterns. For such applications (i.e. a protocol exerciser), the 81150A / 81160A can be used to re-time and re-shape an externally provided data-stream.

Externally provided patterns are being input at the MOD-IN input on the rear panel of the instrument. The available data rate is limited to 10Mbit/s in this case.

The externally provided signal is being evaluated against either 1 or 2 adjustable threshold voltages.

Number of Levels	Threshold comparison	Symbol	Level Index
2	Input <= Lower Threshold	0	0
	Input > Lower threshold	1	1
3	Input <= Lower Threshold	0	0
	Lower Threshold < Input <= Upper Thres	-	2
	Input > Upper threshold	1	1

When using external pattern mode, the incoming pattern must be sampled by the 81150A / 81160A before it can be processed by the pattern generation logic. There are two different sampling modes that differ in the way the 81150A / 81160A chooses the point in time when the value of the sample is being determined.

Fixed Sampling

Introduction

With fixed sampling, there is a deterministic relation between the sampling time at MOD-IN and the edge at the TRIGGER-OUT connector. The external data is sampled at fixed intervals. The latency of the external pattern through the 81150A / 81160A is deterministic. This mode shall be used whenever the device that provides the external data pattern can either be driven with an external clock that is provided by the 81150A / 81160A (via TRIGGER-OUT) or it provides a clock signal together with the data, which can be used to trigger the 81150A / 81160A via the External-In connector. Or in other words, when the timing of pattern source can be tightly coupled with the 81150A / 81160A, then fixed sampling is possible.

Automatic Sampling

Introduction

With automatic sampling, the 81150A / 81160A is monitoring the signal at MOD-IN to detect an initial transition. After this transition occurred, the incoming data is sampled at the data rate that is set as frequency value in the instrument. If there are no level changes for more than 8 unit intervals, the initial transition search is re-started. This sampling method shall be used for pattern sources that cannot be coupled with the 81150A / 81160A based on a clock signal, or that send the data in 'packets' separated by a period of inactivity between the data packets.

7.5 Noise Generation

Introduction

The Keysight 81150A / 81160A generates noise waveforms using a digital noise source.

This digital noise source consists of the following four major blocks:

- Address Generation
- Sample Memory
- Digital Filter
- Digital Analog Converter

The block diagram is very similar to a traditional memory based noise generation, but there is one crucial difference: the sample memory holds a sample distribution, rather than pre-calculated samples. The sample memory is read using a random address generator.

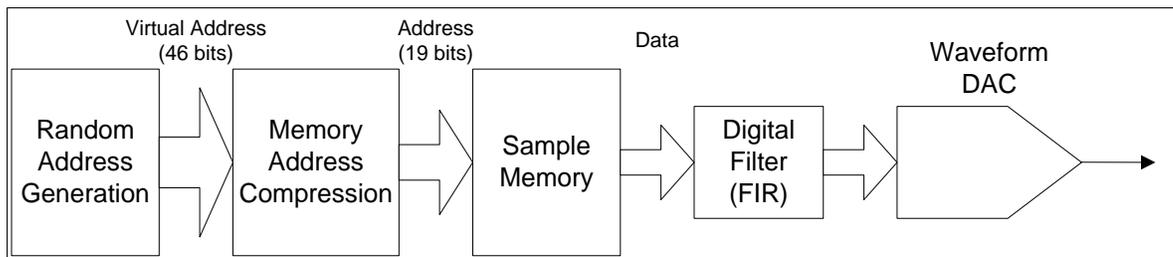

Noise with Memory Address Compression

The advantage of this approach is that the voltage domain is separated from the time domain. The memory content determines the distribution of the output signal, while the address generation determines the repetition rate and randomness of the output signal.

Due to the huge virtual address range, the generated noise signal repeats after approximately 26 days.

Triggered Noise In triggered mode, the random address generation will be reset to its start condition whenever the trigger event occurs. This allows to generate the same random noise sequence again without the need to wait for the repetition time to elapse.

Gated Noise Mode In gated mode, the output signal will be blanked when the gate signal is inactive. The noise source will continue generating random addresses while the output signal is blanked. Address generation will not be reset on the inactive to active transition of the gate signal.

PDF The Keysight 81150A / 81160A has four built-in probability density functions (PDF) to generate noise signals with a crest factor of 3.1, 4.8, 6.0 and 7.0. When generating one of the built-in distributions, the noise generation uses a virtual address that is 46 bit wide and that is mapped to the 19 bit (values of the 81150A) address bus of the sample memory.

User-defined Noise distribution When generating noise with a user-defined distribution, the random address generation is connected directly to the sample memory as shown below.

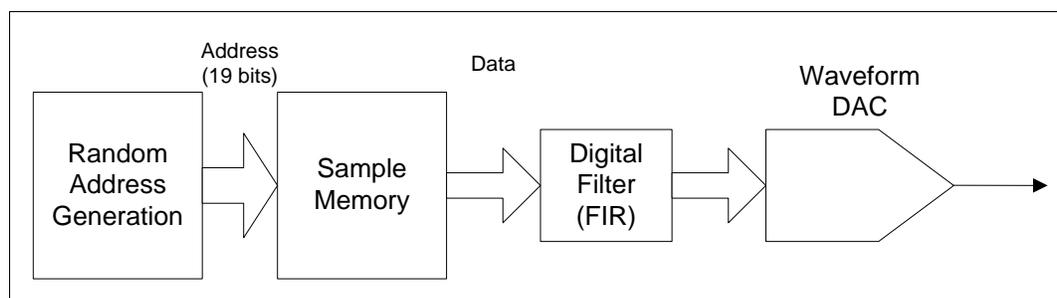

Noise without Memory Address Compression

The crest factor of the user-defined distribution is:

$$cf = \frac{Sample_{max} - Sample_{min}}{2 \times \sqrt{\frac{1}{N} \sum_{i=0}^{N-1} Sample_i^2}}$$

Where N is either 16384 or 524288 (for 81150A).

7.5.1 Limitations of User-defined Noise Distributions

Introduction

Due to bandwidth limitations of the output amplifier, the measured histogram does not perfectly match the defined distribution.

The difference between the calculated crest factor of the user defined distribution and the measured histogram depends on the amplifier path being used and on the distribution itself.

Example of user defined distribution defined by Ramp waveform

The following example shows a user defined distribution that is defined by a ramp waveform. This should lead to an equal distribution of all voltage levels in the output signal. Due to the bandwidth limitations and asynchronous sampling of the oscilloscope, the measured histogram is not rectangular as expected.

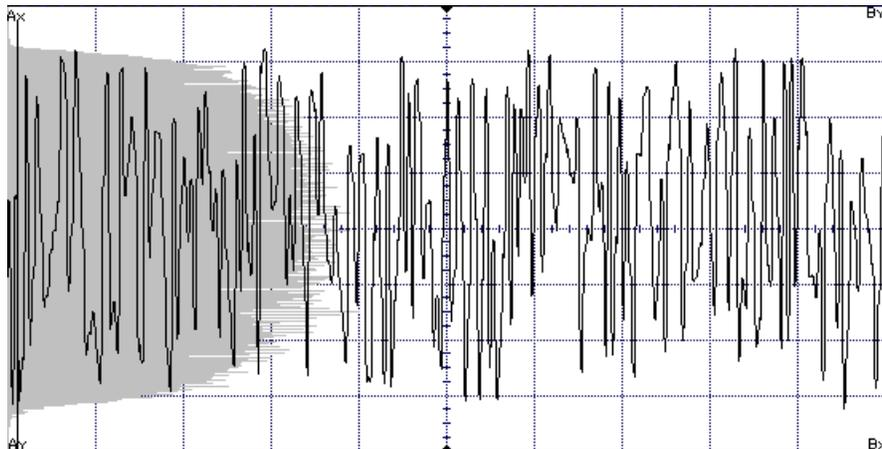

Example of user defined noise distribution

The example below shows the measured histogram of a user defined noise distribution containing only 2 different values (square wave with 50% duty cycle). Since the output signal cannot jump between the programmed high and low level, it is sampled on voltage levels in between, while it is on the transition between the high and low level. This leads to a measured histogram that does not only contain readings at the high and low level, but also during the transitions of the output signal.

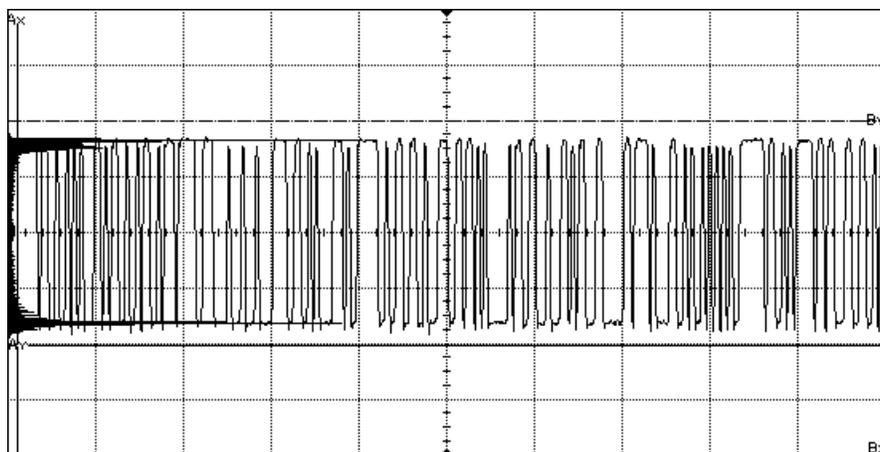

Example of user defined distribution defined by Square waveform

The following example shows a user defined distribution that is a square wave with 25% duty cycle. Due to the bandwidth limitations, the ratio between the high and low level peaks in the histogram is not 1/3 but 1/4. And thus the probability to see the programmed high level at the output is less than expected.

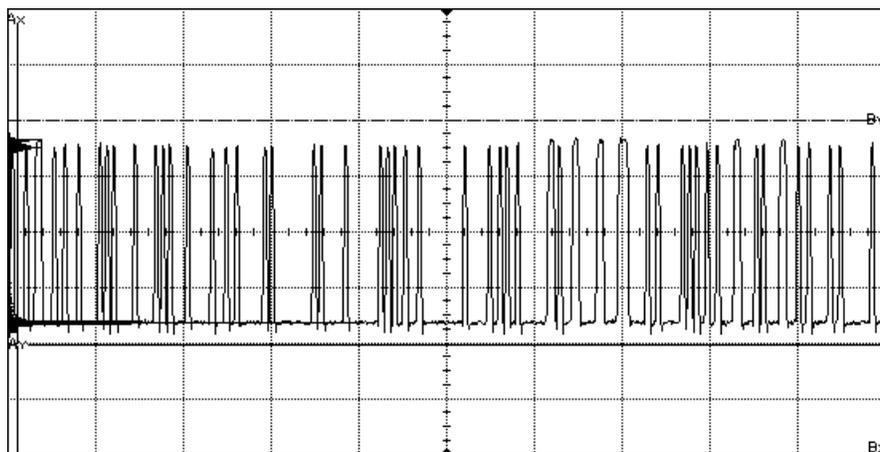

7.6 Trigger Modes

Introduction The Keysight 81150A / 81160A allows you to control the signal generation in several ways. One of the most important selection is the trigger mode being used. Basically, there are three different trigger modes, namely, continuous, triggered, and gated. These are explained below.

Continuous The instrument continuously generates the selected waveform, sweep, or burst. The next cycle is started immediately automatically. This is the only trigger mode that can be used when modulation is enabled.

Triggered The instrument generates exactly one waveform cycle, sweep, or burst. If a trigger event occurs while a signal is being generated, then this trigger event is ignored.

Gated The instrument is continuously generating the selected waveform, sweep, or burst while the selected gate signal is active. If the gate is getting inactive, the current cycle will be finished. If the gate is getting active again while the previous cycle is being finished, then there will be no discontinuity at the output.

In triggered and gated mode, the triggering event or gate signal may be generated by the following:

- External-In
 - Man key or SCPI command
 - Internal Trigger Generator
-

External-In This input allows to define the decision threshold in a $\pm 10V$ voltage window. The input signal is referenced to chassis ground.

81150A: The input impedance may be set to either 50Ω or $10 \text{ k}\Omega$.

81160A: The input impedance may be set to either 50Ω or $1 \text{ k}\Omega$.

Man key or SCPI command The Man key on the front panel may be used to generate the trigger event or gate signal manually. When receiving the *TRG command, the instrument will emulate a press and release event of the Man key.

Internal Trigger Generator Each channel of the Keysight 81150A / 81160A contains its own internal trigger event generator. The frequency of the trigger event may be adjusted as required for the specific application. The internal trigger generator cannot be used to generate the gate signal.

While each of the two channels has its own internal trigger generator, the External-In and Man key are a shared resource for both channels. But both channels can use the available arming sources independently (only if channel coupling is disabled).

The block diagram below reflects the trigger mode related functional blocks for one channel:

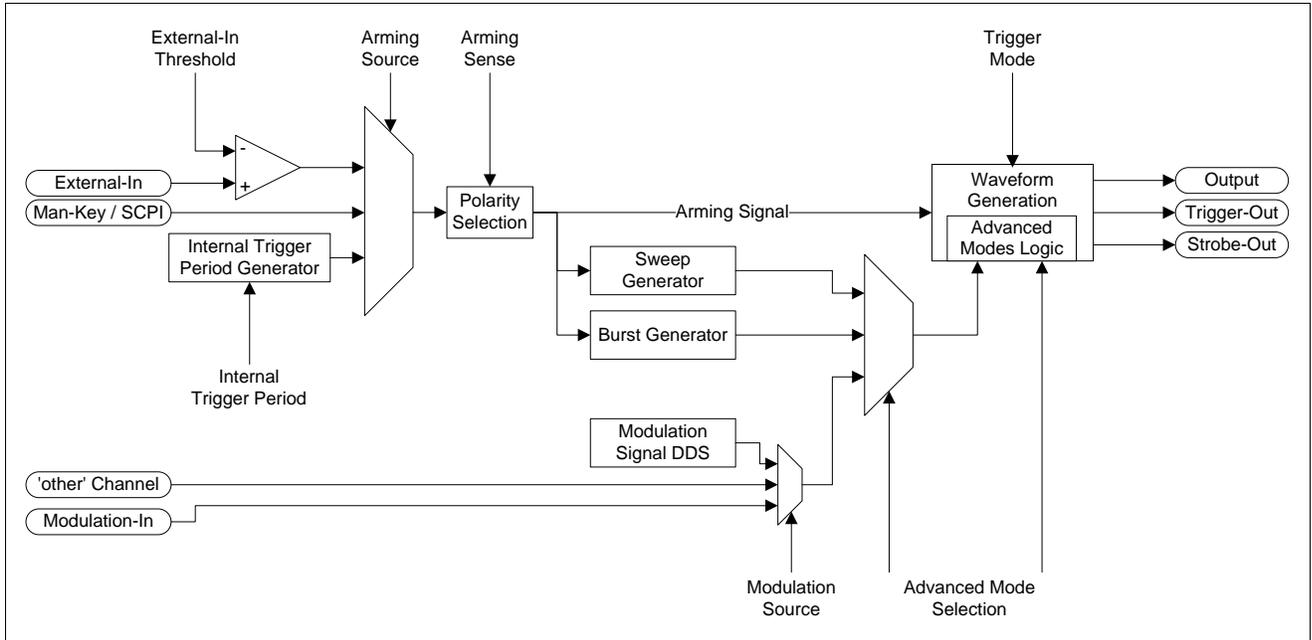

Trigger Modes

Trigger events can be generated on the rising or falling edge of the selected arming signal. The active state of the gating signal can be set to high or low level.

✎ The selection of the trigger edge and gate level is done using the arming sense (`:ARM[1|2]:SENS`), so that changing this setting in triggered mode also changes the selection in burst mode.

7.7 External In to Trigger Out Timing

Introduction

The Keysight 81150A / 81160A has a constant timing between the signal provided at the External-In connector and the response at the Trigger Out connector. This latency is independent to the output frequency being generated, but depends on the overall mode of operation (the latency is bigger for triggered or gated frequency sweeps). To achieve this constant latency, the logic depicted in the following block diagram is used.



The 81160A uses a 2.5 GHz ADC.

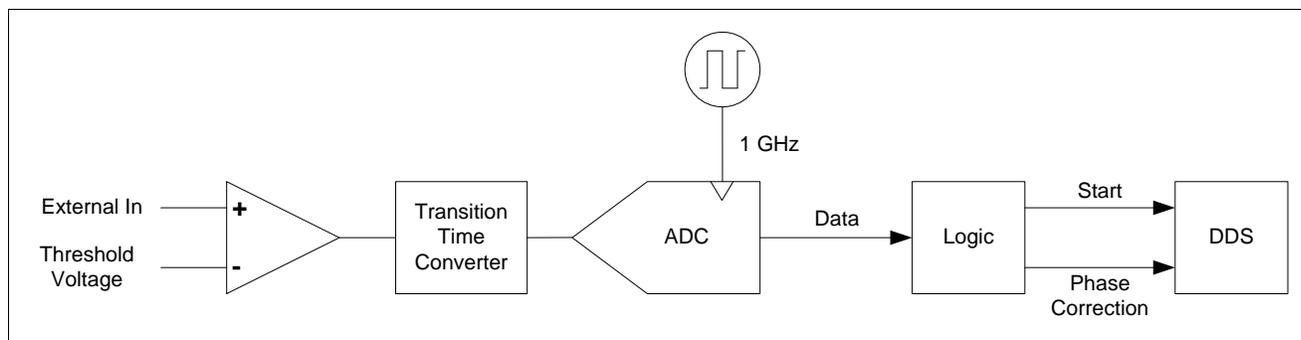

External-In Block Diagram of 81150A

The signal applied to External-In is first compared against the threshold voltage. The digitized External-In signal is then fed through a transition time converter. This guarantees that the signal that is sampled by the ADC has a well known transition time, which is greater than the sampling interval. The required phase offset for the DDS is calculated from the first 2 ADC readings that are not clipped to the ADC's minimum reading as shown below.

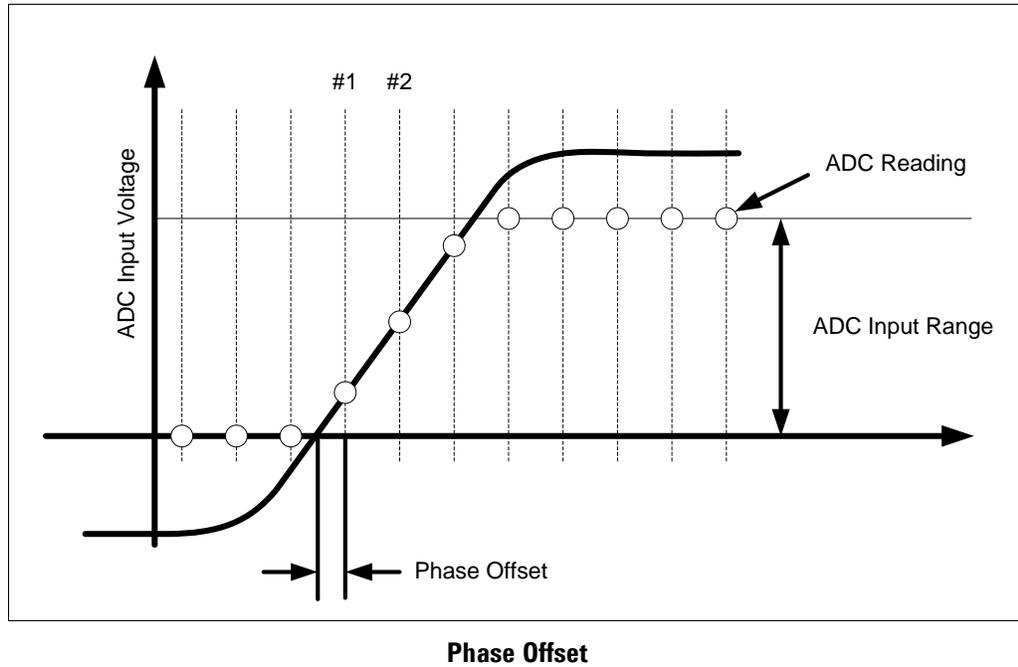

Phase Offset

$$PhaseOffset = \frac{Sample\#1}{Sample\#2 - Sample\#1}$$

The calculated phase offset will then be applied to the DDS when processing the Start signal.

While waiting for the start signal, the DDS sends the waveform data that corresponds to the start phase (usually 0°) to the waveform DAC. The first waveform data that is sent after receiving the start signal uses the phase that corresponds to Phase Increment – Phase Offset.

7.8 Signal Imperfections

Introduction

For sine waveforms, signal imperfections are easiest to describe and observe in the frequency domain using a spectrum analyzer. Any component of the output signal which has a different frequency than the fundamental (or “carrier”) is considered to be spurious. The signal imperfections can be categorized as harmonic, non-harmonic, or phase noise and are specified in “decibels relative to the carrier level” or “dBc”.

Harmonic Imperfections

Harmonic components always appear at multiples of the fundamental frequency and are created by non-linearities in the waveform DAC and other elements of the signal path. At low amplitudes, another possible source of harmonic distortion is due to the current flowing through the cable connected to the function generator’s Strobe output connector. This current can cause a small square-wave voltage drop across the resistance of the cable’s shield and some of this voltage can be imposed on the main signal. If this is a concern for your application, you should remove the cable. If your application requires that you use the Strobe output connector, you can minimize the effect by terminating the cable in a high impedance load (rather than into a 50Ω load).

Non-Harmonic Imperfections

The biggest source of non-harmonic spurious components (called “spurs”) is the waveform DAC. Nonlinearity in the DAC leads to harmonics that are aliased, or “folded back”, into the passband of the function generator. These spurs are most significant when there is a simple fractional relationship between the signal frequency and the function generator’s sampling frequency (81150A: 2 GHz; 81160A: 2.5 GHz).

For example, at 225 MHz, the DAC produces harmonics at 450 MHz, 675 MHz, ..., 1800 MHz, 2025 MHz. These harmonics, which are 200 MHz and 25 MHz from the function generator’s 2 GHz sampling frequency, will appear as spurs at 200 MHz and 25 MHz.

Another source of non-harmonic spurs is the coupling of unrelated signal sources (such as the microprocessor clock) into the output signal. These spurs usually have a constant amplitude (≤ -75 dBm or 112 μ Vpp) regardless of the signal’s amplitude and are most troublesome at signal amplitudes below 100 mVpp. To obtain low amplitudes with minimum spurious content, keep the function generator’s output level relatively high and use an external attenuator if possible.

Phase Noise

Phase noise results from small, instantaneous changes in the output frequency (“jitter”). It is seen as an elevation of the apparent noise floor near the fundamental frequency and increases at 6 dBc / octave with the carrier frequency. The 81150A / 81160A’s phase noise specification represents the amplitude of the noise in a 1 Hz bandwidth, 10 kHz away from the carrier.

Quantization Errors

Finite DAC resolution (14 bits) leads to voltage quantization errors. Assuming the errors are uniformly distributed over a range of ± 0.5 least-significant bit (LSB), the equivalent noise level is -86 dBc for a sine wave that uses the full DAC range (16,384 levels).

Similarly, finite-length waveform memory leads to phase quantization errors. Treating these errors as low-level phase modulation and assuming a uniform distribution over a range of ± 0.5 LSB, the equivalent noise level is -76 dBc for a sine wave that is 16K samples long. All of the 81150A / 81160A’s standard waveforms use the entire DAC range and are 16K samples in length. Any arbitrary waveforms that use less than the entire DAC range, or that are specified with fewer than 16,384 points, will exhibit proportionally higher relative quantization errors.

7.9 Output Amplitude Control

Introduction

The Keysight 81150A and 81160A uses a variable reference voltage to control the signal amplitude over a 1dB range. As shown in the simplified block diagram below, the output of the waveform DAC goes through an anti-aliasing filter. An adjustable attenuator (0dB to 62dB) is used to control the output amplitude in 1dB steps over a wide range of amplitude values (10 mV_{pp} to 10 V_{pp}).

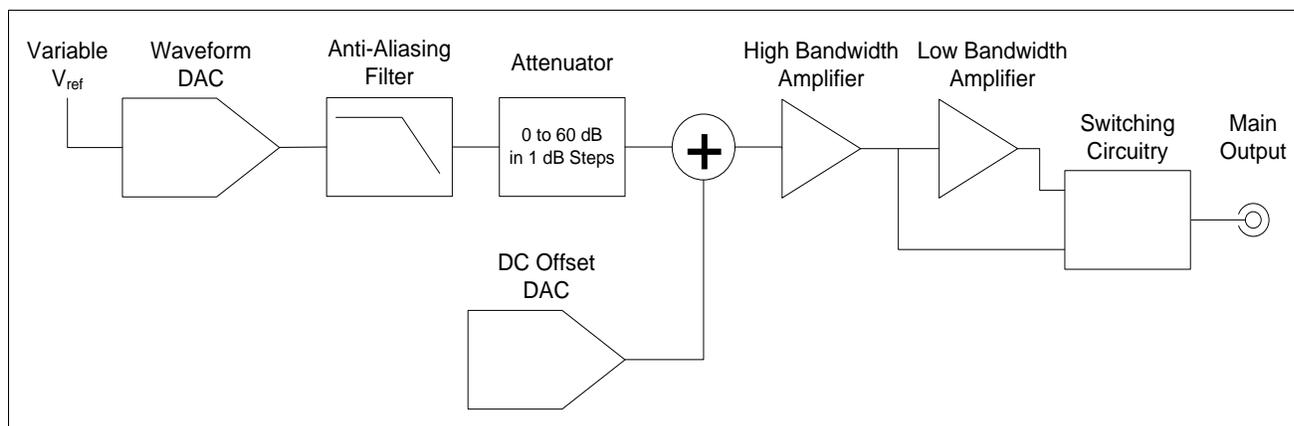

Output Amplitude Control of 81150A



The 81160A has one amplifier.

DC Offset

The dc offset is summed with the ac signal in the output amplifier. This allows relatively small ac signals to be offset by relatively large dc voltages. For example, you can offset a 100 mV_{pp} signal by almost 5 V_{dc} (into a 50Ω load).

81150A, only: The output of the high bandwidth amplifier may optionally be amplified by the low bandwidth amplifier to achieve higher output voltages (amplifier gain of 2). 81150A, only: When enabling the low bandwidth path, the available output voltage range doubles. But, the maximum output frequency, as well as the other pulse parameters (like transition times and width) are limited to 50 MHz.

When changing ranges, the 81150A and the 81160A switches attenuators such that the output voltage never exceeds the current amplitude setting. However, momentary disruptions or "glitches" caused by switching can cause problems in some applications. For this reason, the 81150A and the 81160A incorporates a range hold feature to "freeze" the attenuator and amplifier switches in their current states. However, the amplitude and offset accuracy and resolution (as well as waveform fidelity) may be adversely affected when reducing the amplitude below the expected range change.

81150A: As shown below, the 81150A has a selectable series output impedance of $5\ \Omega$ or $50\ \Omega$, forming a voltage divider with the load resistance.

81160A: The 81160A has a series output impedance of $50\ \Omega$ fix, forming a voltage divider with the load resistance.

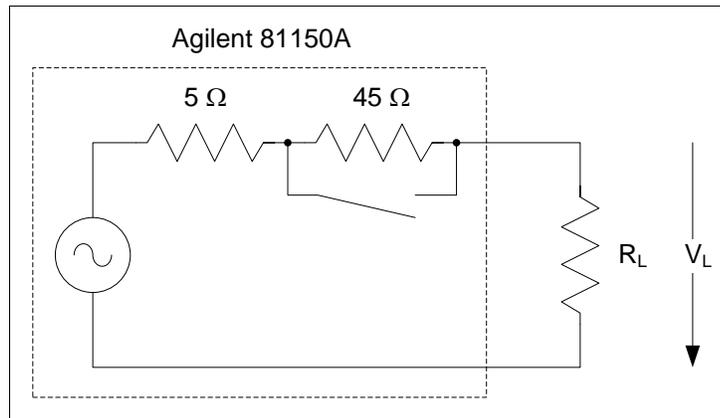

81150A Output Amplitude Control - Impedance

Load Impedance

As a convenience, you can specify the load impedance as seen by the function generator and thereby display the correct load voltage. If the actual load impedance is different than the value specified, the displayed amplitude, offset, and high/low levels will be incorrect. Variations in source resistance are measured and taken into account during an instrument calibration. Therefore, the accuracy of the load voltage depends primarily on the accuracy of the load resistance as shown below.

$$\Delta V_L(\%) \cong \frac{R_S}{R_L + R_S} \times R_L(\%)$$

where R_S is either 50Ω or 5Ω for the 81150A (R_S is 50Ω for the 81160A).

7.10 Attributes of AC Signals

Introduction

The most common ac signal is a sine wave. In fact, any periodic signal can be represented as the sum of different sine waves. The magnitude of a sine wave is usually specified by its peak, peak-to-peak, or root-mean square (RMS) value. All of these measures assume that the waveform has zero offset voltage.

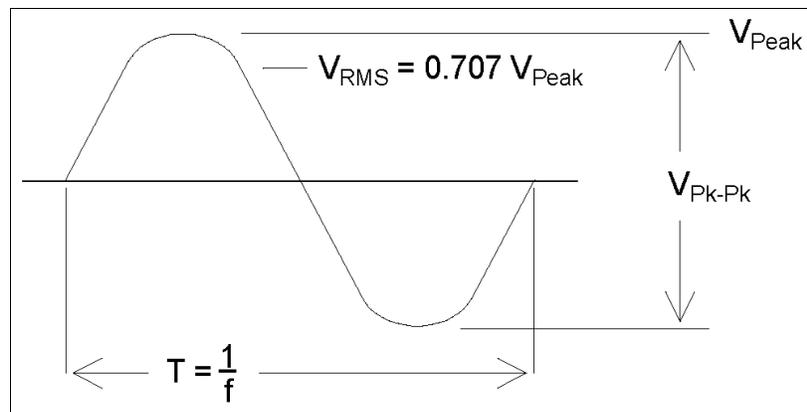

Attributes of AC Signals

Peak Voltage

The *peak voltage* of a waveform is the maximum absolute value of all points in the waveform. The *peak-to-peak* voltage is the difference between the maximum and minimum. The RMS voltage is found by summing the squares of the voltages of every point in the waveform, dividing the sum by the number of points, and then taking the square root of that quotient. The RMS value of a waveform also represents the one-cycle average power in the signal:

$$Power = V_{RMS}^2 / R_L$$

Crest factor is the ratio of a signal's peak value to its RMS value and will differ according to waveshape. The table below shows several common waveforms with their respective crest factors and RMS values.

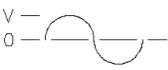
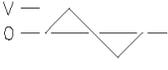
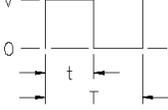
Waveform Shape	Crest Factor (C.F.)	AC RMS	AC+DC RMS
	1.414	$\frac{V}{1.414}$	$\frac{V}{1.414}$
	1.732	$\frac{V}{1.732}$	$\frac{V}{1.732}$
	$\sqrt{\frac{T}{t}}$	$\frac{V}{C.F.} \times \sqrt{1 - \left(\frac{1}{C.F.}\right)^2}$	$\frac{V}{C.F.}$

Attributes of AC Signals Crest Factor



If an average-reading voltmeter is used to measure the “DC voltage” of a waveform, the reading may not agree with the DC Offset setting of the function generator. This is because the waveform may have a non-zero average value that would be added to the DC Offset.

You may occasionally see ac levels specified in “decibels relative to 1 milliwatt” (dBm). Since dBm represents a power level, you will need to know the signal’s RMS voltage and the load resistance in order to make the calculation.

$$dBm = 10 \times \log_{10}(P / 0.001)$$

where $P = V_{RMS}^2 / R_L$

For a sine wave into a 50Ω load, the following table relates dBm to voltage.

Appendix

For a sine wave into a 50Ω load, the following table relates dBm to voltage.

dBm	RMS Voltage	Peak-to-Peak Voltage
+23.98 dBm	3.54 Vrms	10.00 Vpp
+13.01 dBm	1.00 Vrms	2.828 Vpp
+10.00 dBm	707 mVrms	2.000 Vpp
+6.99 dBm	500 mVrms	1.414 Vpp
0.00 dBm	224 mVrms	632 mVpp
-6.99 dBm	100 mVrms	283 mVpp
-10.00 dBm	70.7 mVrms	200 mVpp
-36.02 dBm	3.54 mVrms	10.0 mVpp

Conversions

For 75Ω or 600Ω loads, use the following conversions:

$$\text{dBm (75}\Omega) = \text{dBm (50}\Omega) - 1.76$$

$$\text{dBm (600}\Omega) = \text{dBm (50}\Omega) - 10.79$$

7.11 Modulation

Introduction Modulation is the process of modifying a high-frequency signal (called the *carrier signal*) with low-frequency information (called the *modulating signal*). The carrier and modulating signals can have any waveshape, but the carrier is usually a sine waveform.

Common Types of Modulation The two most common types of modulation are *amplitude modulation* (AM) and *frequency modulation* (FM). These two forms of modulation modify the carrier's amplitude or frequency, respectively, according to the instantaneous value of the modulating signal. A third type of modulation is phase modulation (PM), which is similar to FM except that the phase of the carrier waveform is varied, rather than its frequency. Another type of modulation is *frequency-shift keying* (FSK), where the output frequency "shifts" between two frequencies depending on the state of a digital modulating signal. Finally, pulse width modulation (PWM), is provided for pulse waveforms only. In PWM, the pulse width or duty cycle of the pulse waveform is varied according to the modulating signal.

The function generator will accept an *internal* or *external* modulation source. If you select the internal source, the modulated waveform is generated by a secondary DDS synthesizer. Alternatively, the samples that are generated on the other channel can be selected as the modulating signal (2 channel version only). This allows even more detailed control over the modulation signal as provided by the secondary DDS synthesizer. If you select the external source, the modulated waveform is controlled by the signal level present on the function generator's rear-panel *Modulation In* connector. The external signal is sampled and digitized by an analog-to-digital converter (ADC). With either modulation source, the result is a stream of digital samples representing the modulating waveform.

Amplitude Modulation (AM)

Introduction

The function generator implements two forms of AM called “double-sideband transmitted carrier” and “double-sideband suppressed carrier.” The “double-sideband transmitted carrier” is the type of modulation used by most AM radio stations.

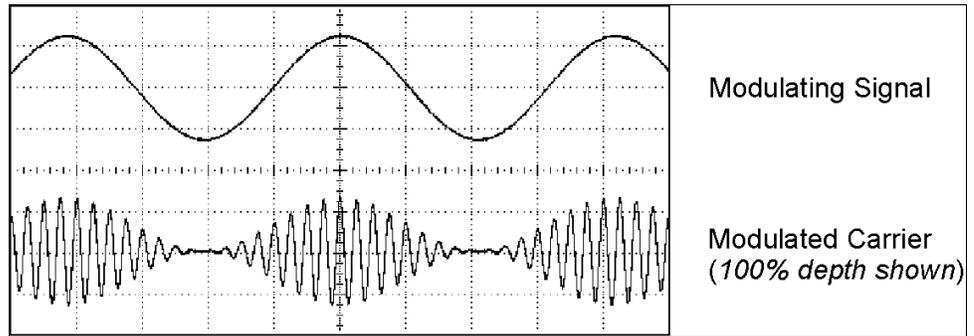

Amplitude Modulation double-sideband transmitted carrier

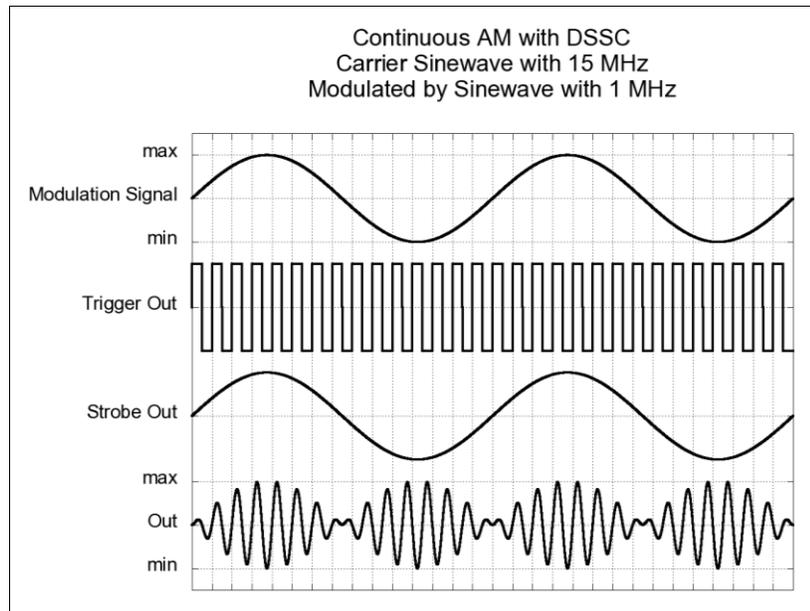

Amplitude Modulation DSSC

Modulation Depth The amount of amplitude modulation is called the *modulation depth* which refers to the portion of the amplitude range that will be used by the modulation. For example, a depth setting of 80% causes the amplitude to vary from 10% to 90% of the amplitude setting ($90\% - 10\% = 80\%$) with either an internal or a full-scale ($\pm 5V$) external modulating signal.

Frequency Modulation (FM)

Introduction

For FM, the function generator uses modulation samples to modify the output frequency of the instrument by changing the content of the PIR (see “Direct Digital Synthesis”).

✎ Since the rear-panel Modulation In connector is decoupled, you can use the 81150A / 81160A to emulate a voltage-controlled oscillator (VCO).

The variation in frequency of the modulated waveform from the carrier frequency is called the *frequency deviation*. Waveforms with frequency deviations less than 1% of the modulating signal’s bandwidth are referred to as *narrowband FM*. Waveforms with larger deviations are referred to as *wideband FM*. The bandwidth of the modulated signal can be approximated by the following equations.

$BW \cong 2 \times (\text{Modulating Signal Bandwidth})$ For narrowband FM

$BW \cong 2 \times (\text{Deviation} + \text{Modulating Signal Bandwidth})$ For wideband FM

In the United States, commercial FM stations usually have a modulation bandwidth of 15 kHz and deviation of 75 kHz, making them “wideband”. Therefore, the modulated bandwidth is: $2 \times (75 \text{ kHz} + 15 \text{ kHz}) = 180 \text{ kHz}$. Channel spacing is 200 kHz.

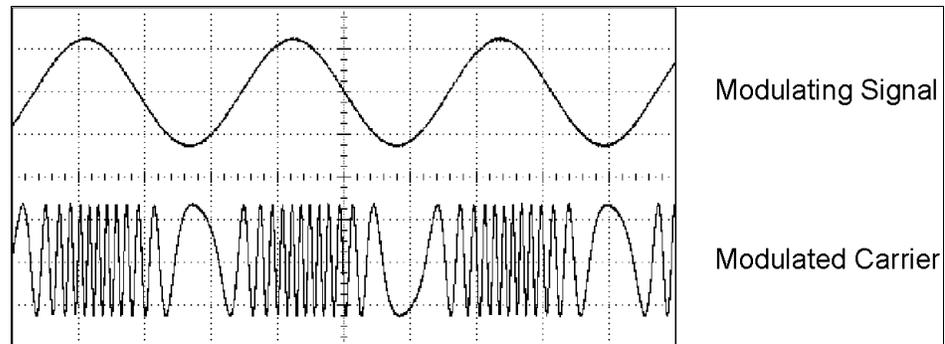

Frequency Modulation

Phase Modulation (PM)

Introduction

PM is very similar to FM, but for PM, the phase of the carrier waveform is varied, rather than the frequency. The variation in phase of the modulated waveform from the carrier waveform is called the phase deviation, which can vary from 0 to 360 degrees.

✎ Since 360 degrees of deviation is equivalent to 0 degrees, the maximum effective deviation is at 180 degrees (the default).

Frequency-Shift Keying Modulation (FSK)

Introduction

FSK is similar to FM except the frequency alternates between two preset values. The rate at which the output shifts between the two frequencies (called the "carrier frequency" and the "hop frequency") is determined by the internal rate generator or the signal level on the rear-panel Modulation In connector. Frequency changes are instantaneous and phase-continuous.

Internal Modulating Signal

The internal modulating signal is a square waveform with 50% duty cycle. You can set the internal FSK rate from 1 mHz to 10 MHz. When using the samples of the other channel as modulating signal, samples with a value below 0 will select the carrier frequency, while samples greater than or equal to 0 will select the hop frequency.

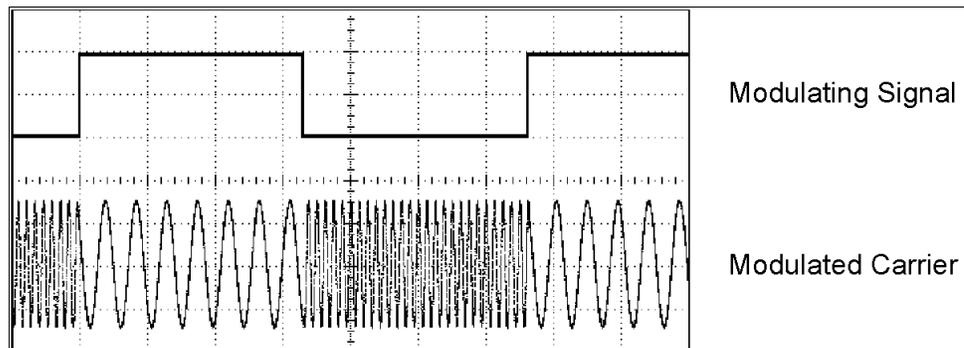

Frequency-Shift Keying Modulation

Pulse Width Modulation (PWM)

Introduction

PWM is used in digital audio applications, motor control circuitry, switching power supplies, and other control applications. The Keysight 81150A / 81160A provides PWM for pulse waveforms, and PWM is the only type of modulation supported for pulse waveforms. For PWM, the amplitude of the modulating waveform is sampled digitally and used to control the pulse width or duty cycle of the pulse waveform.

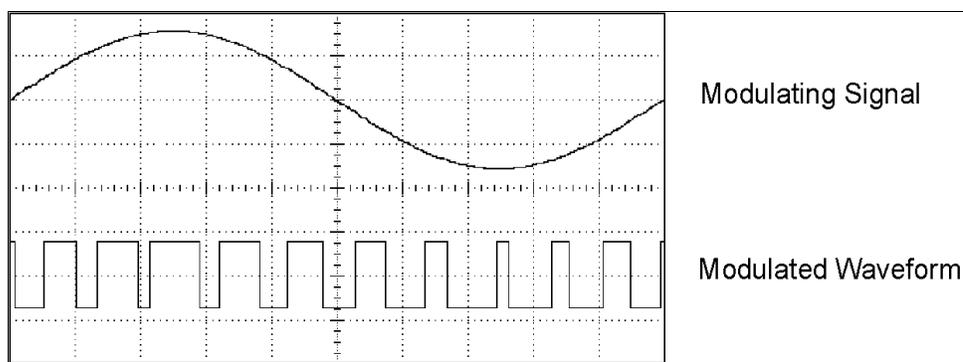

Pulse Width Modulation

Width Deviation

The variation of pulse width in the modulated waveform from the pulse width of the pulse waveform is called the *width deviation*. The deviation can also be expressed in terms of duty cycle (as a percentage referenced to the period of the pulse waveform), which is called the *duty cycle deviation*. In PWM the deviation of width or duty cycle is symmetrical around the pulse width or duty cycle of the original pulse waveform. For example, if you specify a pulse waveform with a 10% duty cycle, and then specify PWM with a duty cycle deviation of 5%, the modulated waveform will have a pulse that varies in duty cycle from 5% to 15% under control of the modulating waveform.

7.12 Frequency Sweep

Introduction

Frequency sweeping is similar to FM but no modulating waveform is used. Instead, the function generator sets the output frequency based on either a linear or logarithmic function. In a *linear* sweep, the output frequency changes in a constant “hertz per second” manner. In a *logarithmic* sweep, the output frequency changes in a constant “octaves per second” or “decades per second” manner. Logarithmic sweeps are useful for covering wide frequency ranges where resolution at low frequencies could be lost with a linear sweep.

You can generate a sweep using an *internal* trigger source or an *external* hardware trigger source. When the *internal* source is selected, the function generator outputs a continuous sweep at a rate determined by the *sweep time* specified. When the *external* source is selected, the function generator will accept a hardware trigger applied to the front panel External-In connector. The function generator initiates one sweep each time External-In receives an active edge.

You can generate a sweep in combination with all trigger modes. Therefore, it is possible to generate a continuous sweep as well as triggering or gating a sweep. In triggered mode, one sweep will be generated for each trigger event. In Gated mode, continuous sweeps will be generated while the gate signal is active. A sweep will always be finished before starting a new one. This does limit the maximum trigger rate or the gate timing to the sweep time (or multiple in case of a gated sweep).

A sweep consists of a finite number of small frequency steps. Since each step takes the same amount of time, longer sweep times result in smaller steps and therefore better resolution. The number of discrete frequency points in the sweep is automatically calculated by the function generator and is based on the *sweep time* you select.

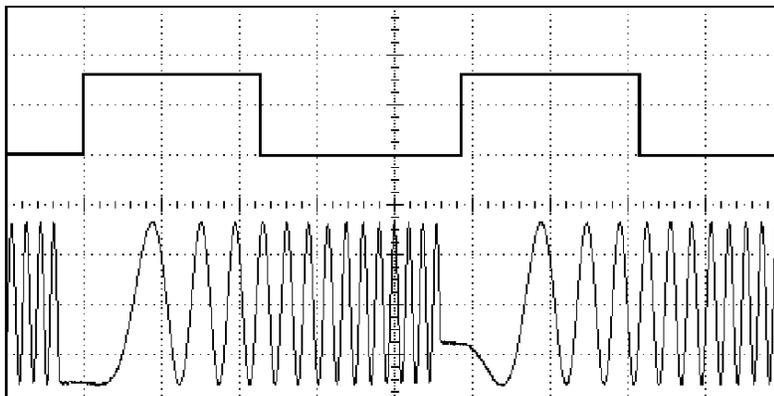

Frequency Sweep

For triggered sweeps, the trigger source can be an external signal, an internal timer, the Man key, or a command received from the remote interface.

The input for external trigger signals is the front-panel External-In connector. This connector accepts levels in the range of ± 10 V for the 81150A (± 5 V for the 81160A) and is referenced to chassis ground.

Strobe Out and Marker Signals

The output from the front-panel *Strobe* connector goes “high” at the beginning of each sweep. If you have *disabled* the Marker function, the Strobe signal goes “low” at the midpoint of the sweep. However, if you have *enabled* the Marker function, the Strobe Out signal goes “low” when the output frequency reaches the specified marker frequency. The marker frequency must be between the specified start frequency and stop frequency.

You can use the Marker function to identify a notable frequency in the response of a device under test (DUT) – for example, you may want to identify a resonance. To do this, connect the *Strobe* output to one channel of your oscilloscope and connect the DUT output to another channel. Then, trigger the oscilloscope with the rising edge of the Strobe signal to position the start frequency on the left side of the screen. Adjust the marker frequency until the falling edge of the Strobe Out signal lines up with the interesting feature in the device’s response. You can then read the frequency from the front-panel display of the 81150A / 81160A.

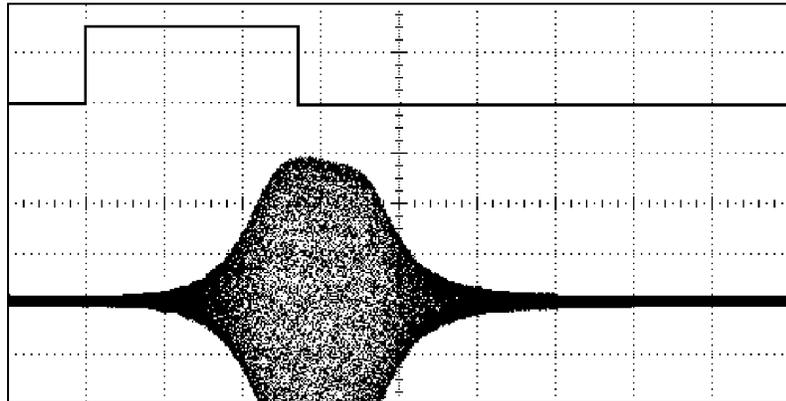

Sweep with Marker at DUT Resonance

7.13 Burst

Introduction

You can configure the function generator to output a waveform with a specified number of cycles (2 to 1,000,000), called a burst.

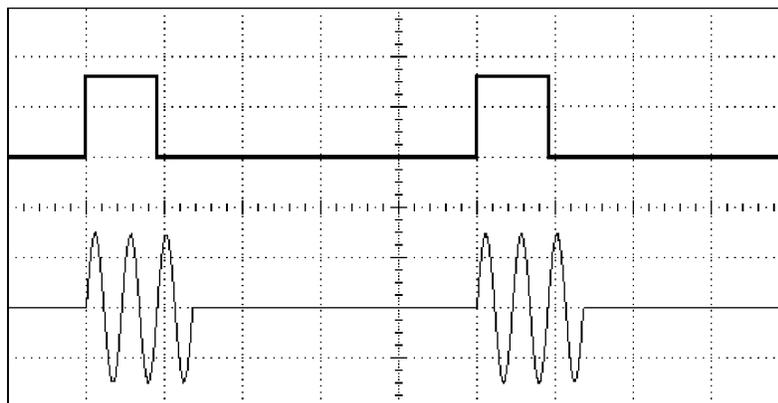

Three-Cycle Burst Waveform

The Strobe Out connector generates a rising edge at the first cycle of the burst and a falling edge on the last cycle.

Bursts can be combined with all trigger modes. In continuous mode, the difference between having a burst mode enabled or disabled is in the presence or absence of the burst framing signal provided at Strobe Out. The main and trigger output generate the same signals in both cases.

In triggered burst mode, the function generator initiates one burst per trigger event. In gated burst mode, bursts will be generated as long as the gate signal is active. A burst will always be finished before another one can be started. So, the trigger rate and gate timing is limited by the product of the number of cycles and the cycle period.

For bursts, the trigger source can be an external signal, an internal timer, the Man key, or a command received from the remote interface.

The input for external trigger signals is the front-panel External In connector. This connector accepts levels in the range of ± 10 V for the 81150A (± 5 V for the 81160A) and is referenced to chassis ground.

A burst always begins and ends at the same point in the waveform. This is called the start phase. A starting phase of 0° corresponds to the beginning of the waveform record and 360° corresponds to the end of the waveform record. The starting phase can be adjusted in the range from 0° to 360° for sine and arb waveforms and will be 0° for pulse, square and ramp waveforms.

The Noise waveform cannot be bursted.

7.14 Channel Addition

Introduction

The Keysight 81150A / 81160A allows you to add the output signal of both channels internally.

The added signal will always be routed to the output connectors of channel 1. The addition of the two signals is done before the waveform DAC, while still working with digital data.

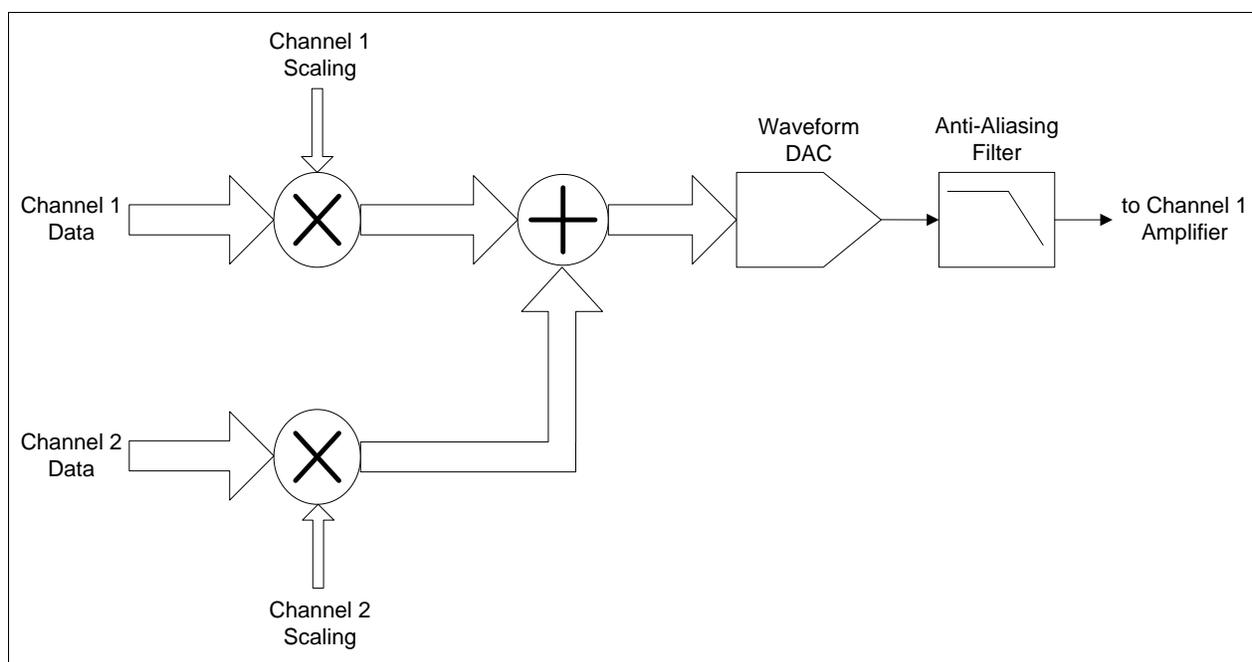

Channel Addition

The sample data of both channels is being scaled according to the contribution to the added signal, so that the added signal is using the full scale of the waveform DAC. The amplifier of channel 1 is set to the sum of the specified voltages for channel 1 and channel 2.

$$\text{High Level} = \text{High Level}_1 + \text{High Level}_2$$

$$\text{Low Level} = \text{Low Level}_1 + \text{Low Level}_2$$

Appendix

The resulting added voltages must be in the allowed voltage range of the amplifier being used on channel 1.

Due to the scaling of the digital samples before the addition, there might be a loss of resolution if the specified amplitudes of channel 1 and channel 2 are different.

The scaling factors are defined as follows:

$$Scaling_{ch} = \frac{Amplitude_{ch}}{Amplitude_1 + Amplitude_2}$$

7.15 Coupling between Channels

Introduction

Each of the two channels of the Keysight 81150A / 81160A uses its own DDS as time base for the signal being generated. This allows using the two channels completely independently, just as if they are two independent 1 channel instruments that use the same reference clock.

In some applications, the 2 channels are not used completely independently, but rather require some synchronization between the two channels.

Frequency Coupling

When enabling frequency coupling, the output frequency of channel 2 is derived from the output frequency of channel 1 (except for frequency sweeps).

The frequency of channel 2 is defined as follows:

$$\text{Frequency}_2 = \frac{\text{Multiplier}}{\text{Divider}} \cdot \text{Frequency}_1$$

Whenever the frequency of channel 1 is changed, the frequency of channel 2 is adjusted automatically according to the above formula. All other settings of channel 2 are still independent of the settings on channel 1.

Channel Coupling

The channel coupling implements a much tighter coupling of channel 1 and channel 2.

When channel coupling is enabled, the two channels are not only locked in frequency, but also in phase. Additionally, all timing relevant parameters will be updated between the channels automatically (refer to the Appendix for the complete list of coupled parameters) to ensure that the frequency and phase remain locked when changing the instrument's state.

The initial update when enabling channel coupling can be done from channel 1 to channel 2 or from channel 2 to channel 1, depending on which channel is being used to enable the channel coupling. All following updates are done from channel 1 to channel 2 or from channel 2 to channel 1, depending on where the change was done.

A Appendix

Introduction

This section covers the following:

- Coupled Parameters when channel coupling is on
- Pulse Parameter Definitions
- Keysight 81150A / 81160A in comparison with other Keysight instruments

Channel 1 to channel 2 or from channel 2 to channel 1, depending on where the change was done.

A.1 Coupled Parameters when channel coupling is on

Introduction

The following parameters will be updated from Channel 1 to Channel 2 and vice versa, if Channel Coupling is enabled.

**Coupled
Parameters when
channel coupling is
on**

Trigger Mode
Trigger Source
Internal Trigger Period/Frequency
Triggered/Gated by
Period
Frequency
Frequency Period Mode
Function
DC State
Noise Type
Modulation State
Modulation Type
Modulation AM Depth
Modulation AM Frequency
Modulation AM Shape
Modulation AM Source
Modulation AM DSSC
Modulation FM Source
Modulation FM Frequency Deviation
Modulation FM Frequency
Modulation FM Shape
Modulation PM Source
Modulation PM Phase Deviation
Modulation PM Frequency
Modulation PM Shape
Modulation FSK Source
Modulation FSK Rate
Modulation FSK Hop Frequency
Modulation PWM Source
Modulation PWM Duty Cycle Deviation
Modulation PWM Width Deviation
Modulation PWM Frequency
Modulation PWM Shape
Burst State
Burst Length (#Cycles)
Burst Start Phase
Sweep State
Sweep Time

Coupled Parameters when channel coupling is on	Sweep Mode
	Sweep Hold Mode
	Sweep Center Frequency
	Sweep Frequency Span
	Sweep Start Frequency
	Sweep Stop Frequency
	Sweep Idle Frequency
	Sweep Marker State
	Sweep Marker Frequency

A.2 Pulse Parameter Definitions

Introduction

Here you find the pulse parameter definitions of terms used in the instrument specifications. In the following figure, a graphical overview of the pulse parameters is provided.

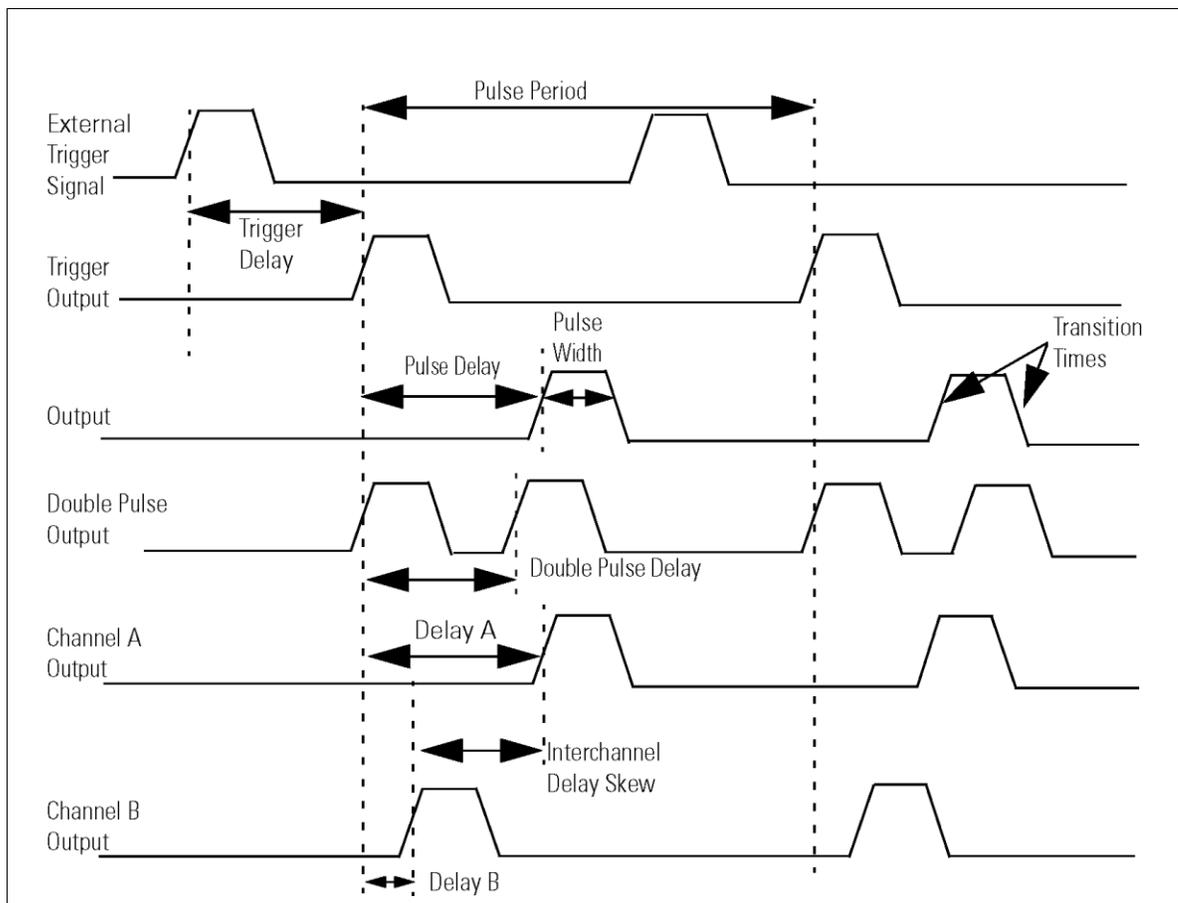

Time Reference Point

The time reference point is at the median of the amplitude (50% amplitude point on pulse edge):

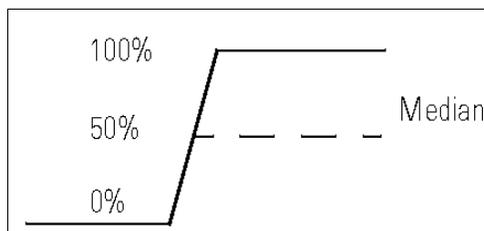
**Pulse Period**

The time interval between the leading edge medians of consecutive output pulses:

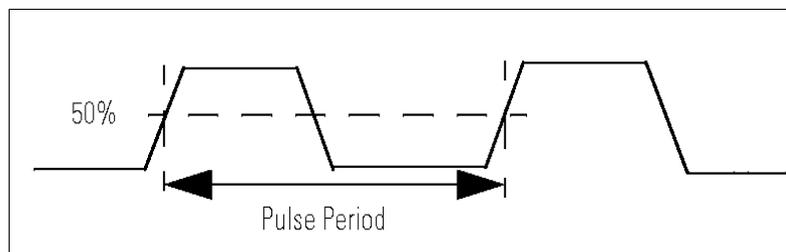
**Trigger Delay**

Interval between trigger point of the external trigger input signal and the trigger output pulse's leading edge median.

Pulse Width

Interval between leading and trailing edge medians:

The specified and displayed value is that obtained with fastest edges, essentially equal to the interval from the start of the leading edge to the start of the trailing edge. By designing so that the pulse edges turn about their start points, the interval from leading edge start stays unchanged (in practice, start points may shift with changes in transition time) when transition times are varied. This is more convenient for programming and the width display is easy to interpret.

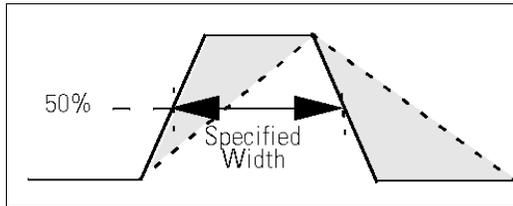

Pulse Delay

Interval between leading edge medians of trigger output pulse and output pulse:

The specified and displayed value is that obtained with the fastest leading edge. Pulse delay has two components, a fixed delay from trigger output to output signal and a variable delay with respect to the trigger output.

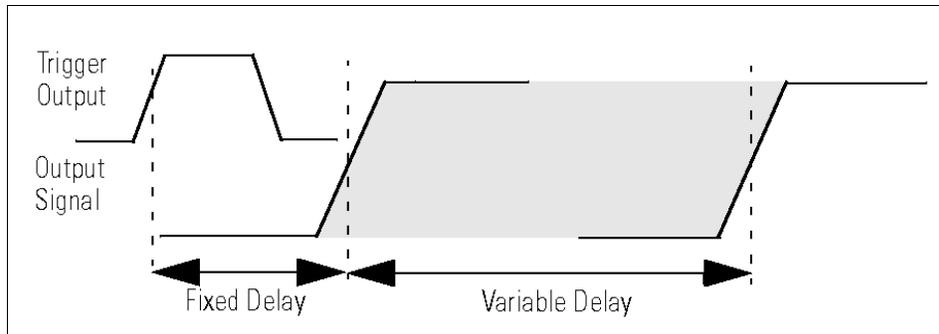

Inter channel Delay (Skew) Interval between corresponding leading edge medians of the output signals.

Transition Time Interval between the 10% and 90% amplitude points on the leading/trailing edge:

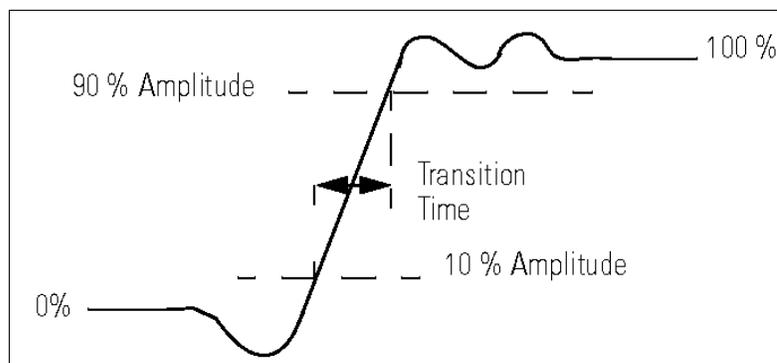

Linearity Peak deviation of an edge from a straight line through the 10% and 90% amplitude points, expressed as percentage of pulse amplitude:

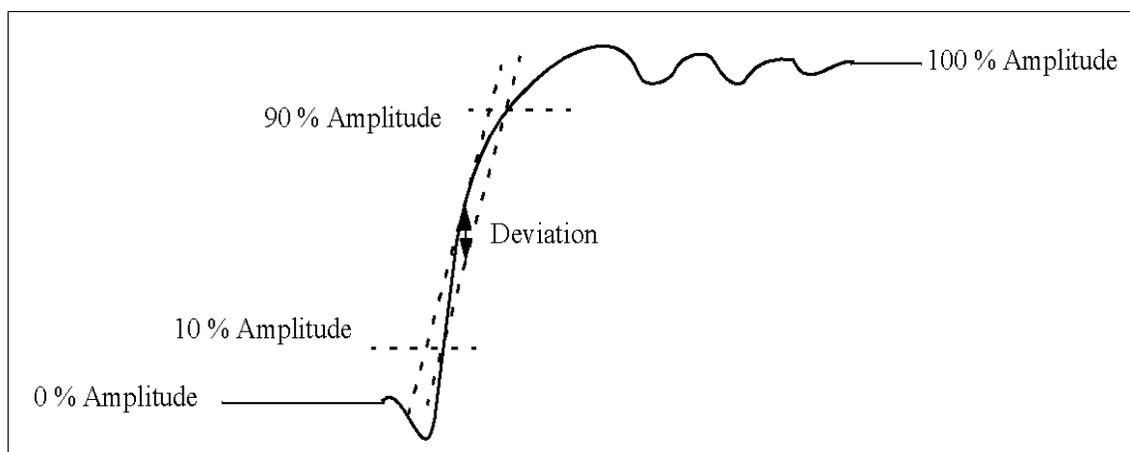

Jitter

Short-term instability of one edge relative to a reference edge. Usually specified as rms value, which is one standard deviation or "sigma". If distribution is assumed Gaussian, six sigma represents 99.74% of the peak-peak jitter.

The reference edge for period jitter is the previous leading edge. That for delay jitter is the leading edge of the trigger output. Width jitter is the stability of the trailing edge with regard to the leading edge.

Stability

Long-term average instability over a specific time, for example, hour, year. Jitter is excluded.

Pulse Levels

Pulse output is specified as pulse top and pulse base (usually referred to as high level and low level), or as peak to peak amplitude and median offset. A "window" specification shows the limits within which the pulse can be positioned.

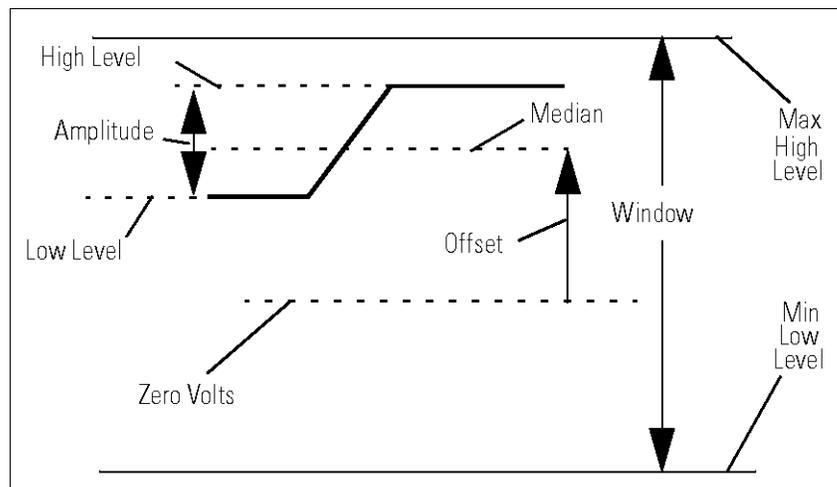

**Preshoot,
Overshoot, Ringing**

Preshoot and overshoot are peak distortions preceding/following an edge. Ringing is the positive-peak and negative-peak distortion, excluding overshoot, on pulse top or base. For example, a combined preshoot, overshoot, and ringing specification of 5% implies:

- Overshoot/undershoot < 5%
- Largest pulse-top oscillation <+ 5%, of pulse amplitude.

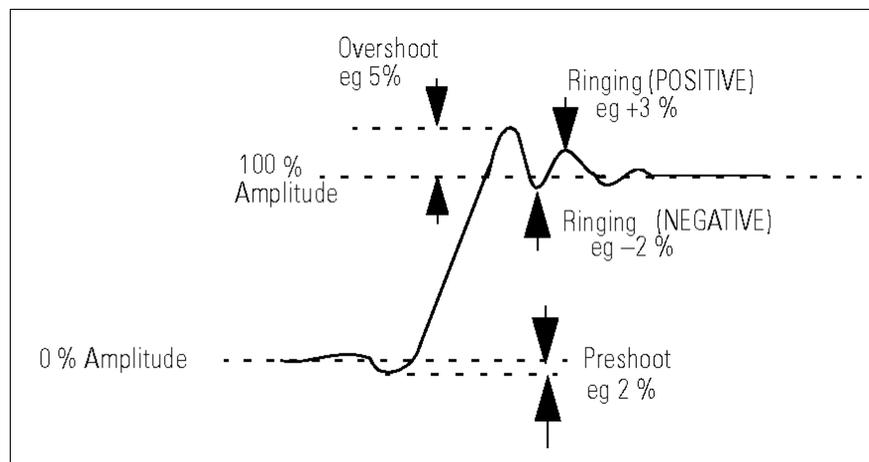

Settling Time

Time taken for pulse levels to settle within level specifications, measured from 90% point on leading edge.

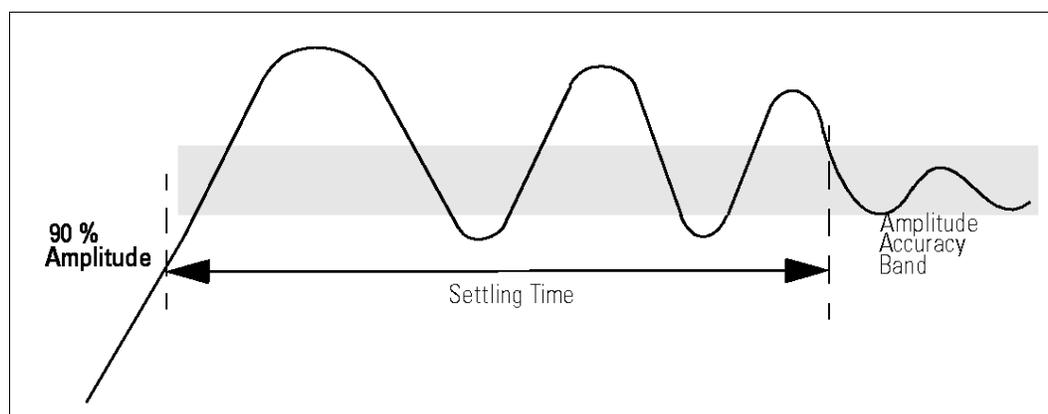

Repeatability

When an instrument operates under the same environmental conditions and with the same settings, the value of a parameter will lie within a band inside the accuracy window. Repeatability defines the width of this band.

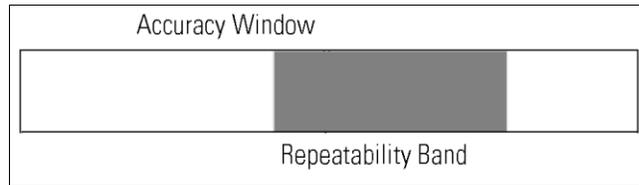

A.3 Keysight 81150A / 81160A in comparison with other Keysight instruments

A.3.1 Keysight 81110A/81104A/81101A instrument family

Introduction The implemented SCPI command set is based on Keysight's 81110A/81104A/81101A Pulse/Data Generator product family. Most of the SCPI commands available for that instrument family are also available in the Keysight 81150A / 81160A instrument. The following table lists the SCPI commands which are not available in 81150A / 81160A as compared to the above-mentioned instruments.

Pattern Data SCPI subsystem	
Set/read pattern data	:DIGital[:STIMulus]:PATtern:DATA[1 2 3] [<start>,] <data>
Set PRBS 2n-1 data	:DIGital[:STIMulus]:PATtern:PRBS[1 2 3] [<n>,] <length>
Set present pattern with clock divided by n	:DIGital[:STIMulus]:PATtern:PRESet[1 2 3] [<n.>,] <length>
Switch pattern mode on off	:DIGital[:STIMulus]:PATtern[:STATE] {ON OFF}
Update the hardware with pattern	:DIGital[:STIMulus]:PATtern:UPDate {ON OFF ONCE}
Set/read the format of output channel	:DIGital[:STIMulus]:SIGNal[1 2]:FORMat {RZ NRZ}
Current SCPI subsystem	
Switches between Voltage/Current	[:SOURce]:HOLD[1 2] VOLT CURR

Set/read channel amplitude current [:SOURce]:CURRent[1 2][:LEVel][:IMMediate][:AMPLitude]<value>
Set/read channel offset current [:SOURce]:CURRent[1 2][:LEVel][:IMMediate]:OFFSet <value>
Set/read channel high-level current [:SOURce]:CURRent[1 2][:LEVel][:IMMediate]:HIGH <value>
Set/read channel low-level current [:SOURce]:CURRent[1 2][:LEVel][:IMMediate]:LOW <value>
Set/read maximum current limit [:SOURce]:CURRent[1 2]:LIMit[:HIGH] <value>
Set/read minimum current limit [:SOURce]:CURRent[1 2]:LIMit:LOW <value>
Enable/disable the current limits [:SOURce]:CURRent[1 2]:LIMit:STATe {ON OFF}
CLK-IN Input SCPI subsystem
Measure frequency at CLK-IN [:SOURce]:FREQuency[:CW FIXed]:AUTO {ONCE}
Measure period at CLK-IN [:SOURce]:PERiod:AUTO {ONCE}
Set/read impedance of CLK-IN :TRIGger:IMPedance <value>
Set/read threshold of CLK-IN :TRIGger:LEVel <value>
Set/read trigger slope CLK-IN :TRIGger:SLOPe POS NEG
Reference Clock SCPI subsystem
Set/read frequency of external PLL reference [:SOURce]:ROSCillator:EXTernal:FREQuency <value>
Mass Memory SCPI subsystem

<p>Read directory of memory card :MMEMory:CATalog? [“?:”]</p>
<p>Change directory of memory card :MMEMory:CDIRectory [“directory name”]</p>
<p>Initialize memory card to DOS format :MMEM:INITialize [“?:” [“DOS”]]</p>
<p>Pulse Configuration SCPI subsystem</p>
<p>Trigger Out/Strobe Out output level [:SOURce]:PULse:TRIGger[1 2] {TTL ECL}</p> <p> The Trigger Out/Strobe Out levels can be set on the 81150A / 81160A via: :OUTP[1 2]:TRIG:VOLT TTL ECL :OUTP[1 2]:STR:VOLT TTL ECL SYM4</p>
<p>Trigger Mode SCPI subsystem</p>
<p>This command is implemented but only with the following arguments: IMMEDIATE and INTERNAL. The 81150A / 81160A does not have different pulse-period trigger sources that can be used as a pulse-period.</p> <p>Set/read pulse-period trigger source :TRIGger[1 2] [:SEQuence[1] START:SOURce[?]] { IMMEDIATE INTERNAL[1] }</p>

A.3.2 Keysight 33220A

Introduction The following commands of the 33220A instrument are not available on the 81150A / 81160A.

<p>Output SCPI subsystem</p>
<p>Front-panel Sync connector on/off :OUTPut:SYNC {OFF ON}</p>
<p>Calibration SCPI subsystem</p>

<p>Unsecure/Secure the instrument for calibration :CALibration:SECure:STATE {ON OFF}</p>
<p>Enter a new security code :CALibration:CODE</p>
<p>Configure the FunGen’s internal state for each of the calibration steps to be performed :CALibration:SETup[?]</p>
<p>Specify the value of the known calibration signal :CALibration:VALue[?]</p>
<p>Query the instrument to determine the number of times it has been calibrated :CALibration:COUNt?</p>
<p>Store a message in non-volatile calibration memory :CALibration:STRing[?]</p>
<p>Trigger Model SCPI Commands</p>
<p>Falling/Raising edge of a trigger signal at the rear panel :TRIGgger:SLOPe {POSitive NEGative}</p>
<p>“Trig-Out” Connector :OUTPut:TRIGger:SLOPe {POSitive NEGative}</p>
<p>“Trig-Out” Connector :OUTPut:TRIGger {ON OFF}</p>
<p>Phase-Lock Commands</p>
<p>Adjust the Phase Offset :PHASe[?] {angle}</p>
<p>Set the Zero Phase Reference :PHASe:REFerence</p>
<p>On Off of error reporting if phase-lock is lost :PHASe:UNLock:ERRor:STATE {ON OFF}</p>

Introduction

The following commands of the 81150A / 81160A instrument are not available on the 33220A.

Arbitrary Command SCPI subsystem**Download an arbitrary modulation waveform**

```
:DATA[1|2]:MOD VOLATILE <value>, <value>, ...
```

```
:DATA[1|2]:MOD:DAC VOLATILE,<binary block>|<value>, <value>, ...
```

Select an arbitrary waveform for modulation

```
:FUNction[1|2]:MODulation:USER[?] <arb name>|VOLATILE
```

A.4 Preparing a USB Flash Drive using Windows Vista®

Introduction

The following description is intended to help you prepare an USB flash drive if it is not being detected by the 81150A / 81160A, or if the recovery mechanism of the software update was not able to bring up the instrument after an interrupted software update.



- You need to have administrative rights on your computer to execute the steps mentioned below.
 - The steps mentioned below will erase all data from the USB flash drive.
 - The procedure does not work on computers that have Windows XP installed on them, since the required partition tool does not support USB flash drives on Windows XP.
-

Steps

1. Click on the Windows logo and type "**cmd**".
 2. At the command prompt type "**diskpart**" and press enter (allow permissions and continue).
 3. When you are at the **diskpart>** prompt type "**list disk**" and press enter.
 4. Insert the USB flash drive into a Windows Vista PC.
 5. Wait until Windows Vista has recognized the USB flash drive.
 6. At the **diskpart>** prompt type "**list disk**" and press enter. Check which drive has been added to the list, usually disk 1 depending on how many disk drives are installed.
 7. Type "**select disk #**" where # is the disk number of the USB flash drive.
Continue only if you are sure that the selected drive is the USB flash key that you want to prepare. The following steps will erase all data from the selected drive!
 8. Type "**clean**" and press enter.
 9. Type "**create partition primary**" and press enter. This creates the partition on the flash drive.
 10. Type "**active**" and press enter.
 11. Type "**exit**" and press enter. This exits the disk partition utility.
 12. Now the flash drive needs to be formatted. Click on the Windows logo and then click on Computer.
 13. Find the drive letter of the removable disk drive that needs to be formatted.
 14. In the command prompt window type "**format ? : /fs:fat32 /q**" where ? is the removable drive letter that needs to be formatted. Press enter.
 15. Enter a volume label of your choice and press enter.
-

For recovering the 81150A / 81160A....

If you need to recover the 81150A / 81160A from an interrupted software update, you need to do the following in addition:

1. Copy the software update zip file on the USB flash drive's root directory.
2. Extract the content of the software update zip file to the root directory of the USB flash drive. Remember to maintain the folder structure in the zip file when doing this.
3. Connect the USB flash drive to the 81150A / 81160A and switch the instrument on.
4. The 81150A / 81160A will now boot the recovery image from the USB flash drive and continue to update the instrument firmware.

Windows® and Windows Vista® are trademarks of Microsoft Corporation.



This information is subject to change without notice.
© Keysight Technologies 2011, 2014
Edition 2.0, August 2014



81160-91020

www.keysight.com