User's Guide

Publication Number 01169-97003
September 2005

For Safety and Regulatory information, see the pages at the back of this book.

© Copyright Agilent Technologies 2004-2005
All Rights Reserved.

1169A 12 GHz InfiniiMax Differential and Single-ended Probe

In This Book

This book provides user and service documentation for the Agilent Technologies 1169A differential and single-ended probe. It is divided into two chapters.

Chapter 1 provides an overview of the recommended configurations and capacitance values of the probe; shows you how to use the convenience accessories with the probe; and provides the frequency, impedance, and time response for the recommended configurations of the probe.

Chapter 2 provides service and performance verification information for the probe.

At the back of the book you will find Safety information and Regulatory information.

Contents

1 Differential and Single-ended Probe Configurations

Introduction 1-2

Convenience Accessories 1-3

Using the Velcro strips and dots 1-3

Using the ergonomic handle 1-3

Slew Rate Requirements for Different Technologies 1-6

Recommended Configurations Overview 1-9

1 Solder-in Differential Probe Head (full bandwidth) 1-9

2 Differential Browser Probe Head (full bandwidth) 1-10

3 SMA Probe Head (full bandwidth) 1-11

Other Configurations Overview 1-12

4 Solder-in Differential Probe Head (high bandwidth resistors) 1-12

5 Socketed Differential Probe Head (high bandwidth resistors) 1-13

6 Differential Browser Probe Head 1-14

7 Solder-in Single-ended Probe Head (high bandwidth resistors) 1-15

8 Single-ended Browser Probe Head 1-16

9 Socketed Differential Probe Head with damped wire accessory 1-17

Recommended configurations at a glance 1-18

Other configurations at a glance 1-19

Detailed Information for Recommended Configurations 1-20

1 N5381A Solder-in Differential Probe Head (Full Bandwidth)

and 2 N5382A Differential Browser Probe Head (Full Bandwidth) 1-21

3 N5380A SMA Probe Head (Full Bandwidth) 1-24

Detailed Information for Other Configurations 1-27

4 E2677A Solder-in Differential Probe Head (High Bandwidth) 1-28

5 E2678A Socketed Differential Probe Head (High Bandwidth) 1-30

6 E2675A Differential Browser 1-32

7 E2679A Solder-in Single-ended Probe Head (High Bandwidth) 1-34

8 E2676A Single-ended Browser 1-36

9 E2678A Socketed Differential Probe Head with Damped Wire Accessory 1-38

10 E2695A SMA Probe Head 1-40

N5380A SMA Probe Head with the 1134A InfiniiMax Probe 1-41

N5381A Solder-in Differential Probe Head with 2 x Longer Wires 1-42

2 Service

Service Strategy for the 1169A Probe 2-3

To return the probe to Agilent Technologies for service 2-4

Troubleshooting 2-5

Failure Symptoms 2-6

Probe Calibration Fails 2-6

Incorrect Pulse Response (flatness) 2-6

Incorrect Input Resistance 2-6

Incorrect Offset 2-6

Calibration Testing Procedures 2-7

To Test Bandwidth 2-8

Using the 8720ES VNA successfully 2-8

Contents

Initial Setup	2-8
Calibrating a Reference Plane	2-9
Measuring Vin Response	2-14
Measuring Vout Response	2-16
Displaying Vin/Vout Response on 8720ES VNA Screen	2-17
To Test Input Resistance	2-19
Initial Setup	2-19
Differential Test	2-20
Single-ended Test	2-21
Performance Test Record	2-23
Replaceable Parts and Accessories	2-24

Differential and Single-ended Probe Configurations

Introduction

The 1169A InfiniiMax II Active Probing system allows probing of differential and single-ended signals to a bandwidth of over 12 GHz. The unique architecture of the InfiniiMax probe system provides a large common mode range for measuring differential signals and a large offset range for measuring single-ended signals. Additionally, the lower attenuation and noise greatly enhance the measurement of low-level signals that are so prevalent today, without overly sacrificing the input dynamic range. This family of probes continues the resistor-at-the-tip technology that Agilent pioneered in the 115x and 113x probe families. In this new probe family, the resistors have been moved onto the very edge of the probe tip board because at these extreme frequencies the off-board mini-axial lead resistors cause more response variation than is desirable. The wires or probe tips in front of the resistors are long enough to allow easy connection but are short enough that any resonances caused by them are out of band and don't impact the input impedance. This system uses interchangeable probe heads to optimize the performance and usability of hand (or probe holder) browsing, solder-in, and SMA connections. The new probe heads available for this system are:

- Differential Solder-in Probe Head — allows a soldered connection into a system for a reliable hands-free connection. This probe head provides full bandwidth performance for measuring differential and single-ended signals and utilizes strong 7 mil (or optional 5 mil) diameter nickel wires, which allow connection to very small, fine pitch targets.
- Differential Hand-held Browser — (or for probe holders) allows temporary connection to points in a system. This probe head has the same tip pc board and the same length tip wires so it provides the same full bandwidth performance and fidelity as the solder-in probe head for measuring differential and single-ended signals. The tip wires for this probe head are tin plated spring steel that can be formed to different spacing and provide compliance for a reliable connection.
- Differential Socket-tip Probe Head — provides sockets that accept 20 mil diameter pins with 100 mil spacing. The intended application for this probe head is to insert two of the supplied 20 mil diameter lead resistors into the sockets and then solder the resistors into the target system. This allows a removable, hands-free connection that provides full bandwidth, but with an increase in capacitive loading over the solder-in and browser probe heads. Additionally, 3.6 cm resistor tip wire accessories are provided for high fidelity lower bandwidth probing of signals with very wide spacing. It is recommended that a 25 mil diameter plated through hole be placed on a board for mounting the 20 mil diameter lead of the resistors.
- SMA Probe Head — allows connection to differential and single-ended signals that have 50 Ω connectors. This probe head provides full bandwidth performance with high quality 50 Ω terminations and an external port for driving the common mode termination voltage. This is a relatively inexpensive probe head for the 1169A probe amp, which allows the probe amp to be used in multiple applications.

Also, probe heads from the 113x probe family are supported within the limitations which are noted. Please refer to the 1134A User's Guide for information on these probe heads. Performance graphs and data are provided for all probe heads.

Convenience Accessories

Using the Velcro strips and dots

The Velcro strips and dots can be used to secure the probe amp to a circuit board removing the weight of the probe from the circuit connection. This is done by using the following steps.

- 1 Wrap the Velcro strip around the probe amp body.
- 2 Attach a Velcro dot to the circuit board.
- 3 Attach the Velcro strip to the Velcro dot.

Figure 1-1

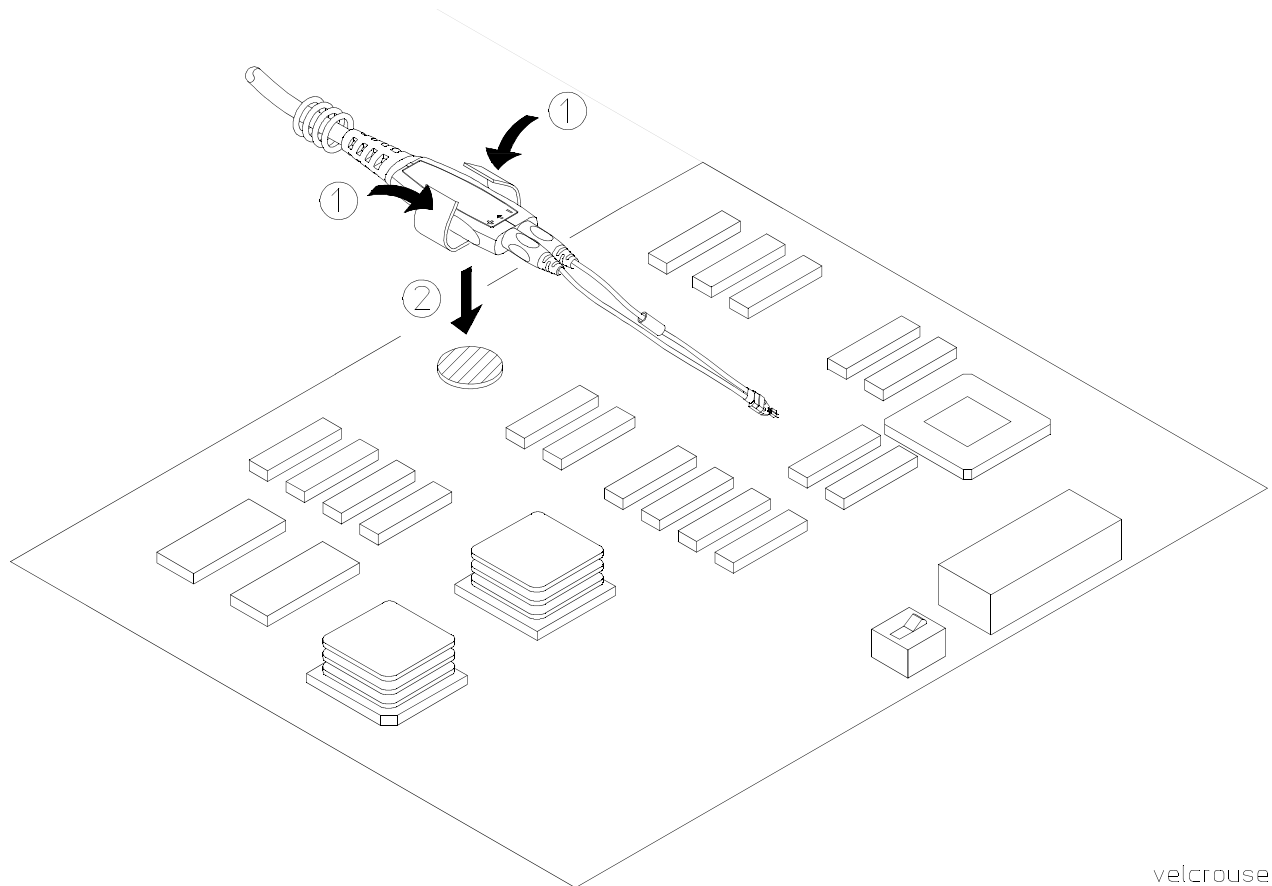

Using the Velcro dots and strips.

Using the ergonomic handle

Because of their small size, it can be difficult to hold the single-ended or the differential browsers for extended periods of time. The ergonomic handle can be used to more comfortably hold the browser. The following pictures show how to mount the browser in the ergonomic handle.

Differential and Single-ended Probe Configurations Convenience Accessories

Figure 1-2

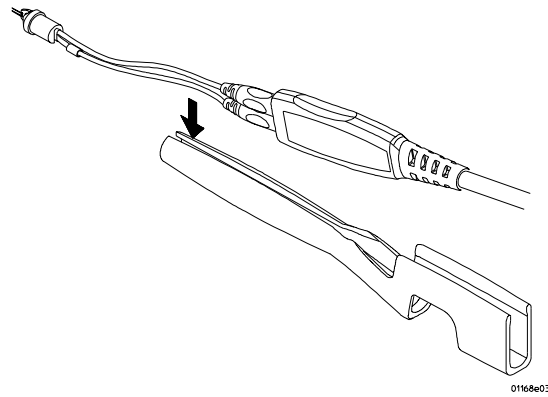

Put part number label here

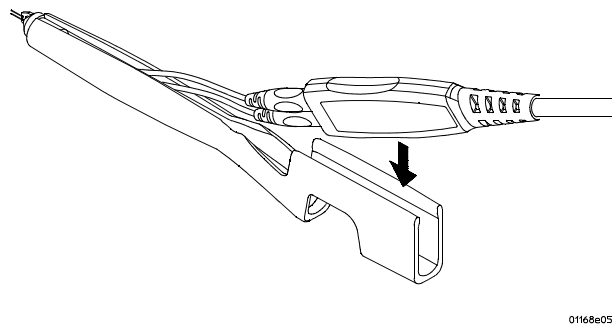
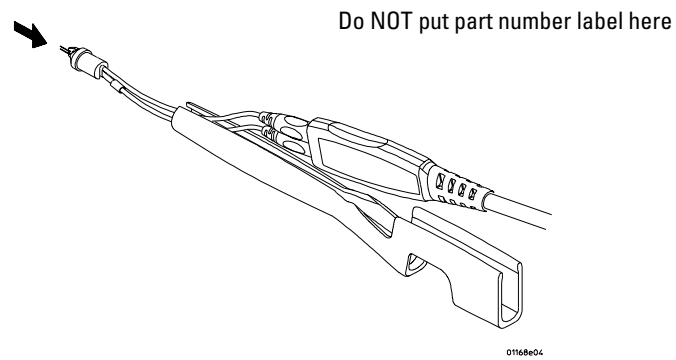

The following pictures show how to remove the browser from the ergonomic handle.

Figure 1-3

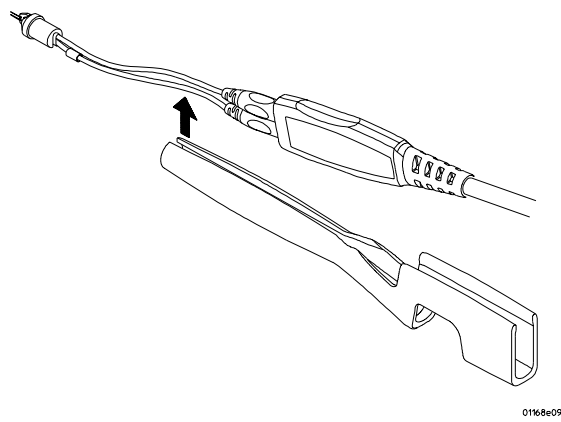
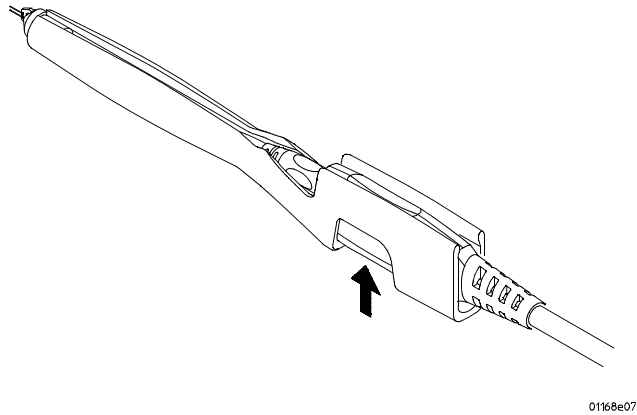

Differential and Single-ended Probe Configurations
Slew Rate Requirements for Different Technologies

Slew Rate Requirements for Different Technologies

The following table shows the slew rates for several different technologies. The maximum allowed input slew rate is 18 V/ns for single-ended signals and 30 V/ns for differential signals. Table 1-1 shows that the maximum required slew rate for the different technologies is much less than that of the probe.

Table 1-1

Slew Rate Requirements

Name of Technology	Differential Signal	Max Single-Ended Slew Rate ¹ (V/ns)	Max Differential Slew Rate ² (V/ns)	Driver Min Edge Rate (20%-80% ps)	Max Transmitter Level (Diff V)
PCI Express (3GIO)	YES	9.6	19.2	50	1.6
RapidIO Serial 3.125Gb	YES	8.0	16.0	60	1.6
10GbE XAUI (4x3.125Gb)	YES	8.0	16.0	60	1.6
1394b	YES	8.0	16.0	60	1.6
Fibre Channel 2125	YES	8.0	16.0	75	1
Gigabit Ethernet 1000Base-CX	YES	7.8	15.5	85	2.2
RapidIO 8/16 2Gb	YES	7.2	14.4	50	1.2
Infiniband 2.5Gb	YES	4.8	9.6	100	1.6
HyperTransport 1.6Gb	YES	4.0	8.0	113	1.5
SATA (1.5Gb)	YES	1.3	2.7	134	0.6
USB 2.0	YES	0.9	1.8	375	1.1
DDR 200/266/333	NO	7.2	n/a	300	3.6
PCI	NO	4.3	n/a	500	3.6
AGP-8X	NO	3.1	n/a	137	0.7

¹ The probe specification is 18 V/ns

² The probe specification is 30 V/ns

Figure 1-4

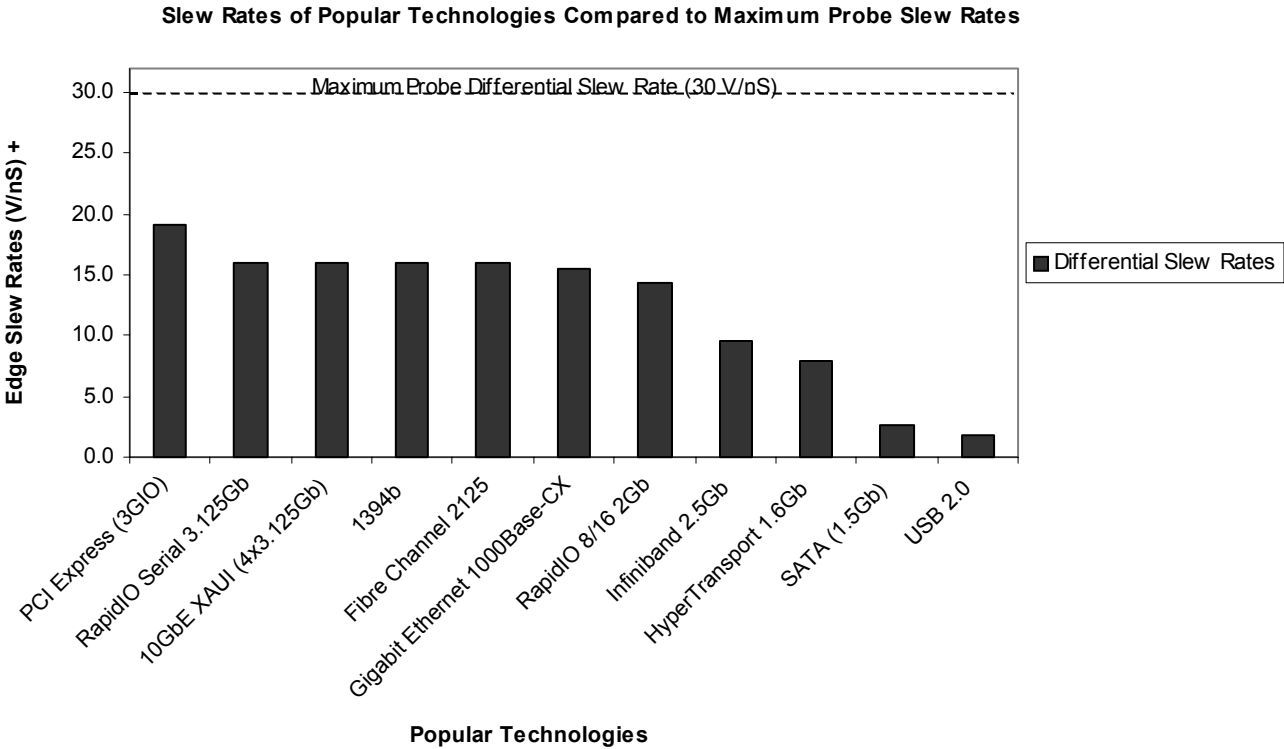

+ $\frac{\text{Maximum Edge Amplitude} \times 0.6}{\text{Minimum 20\% to 80\% Rise Time}}$

Differential and Single-ended Probe Configurations Slew Rate Requirements for Different Technologies

Figure 1-5

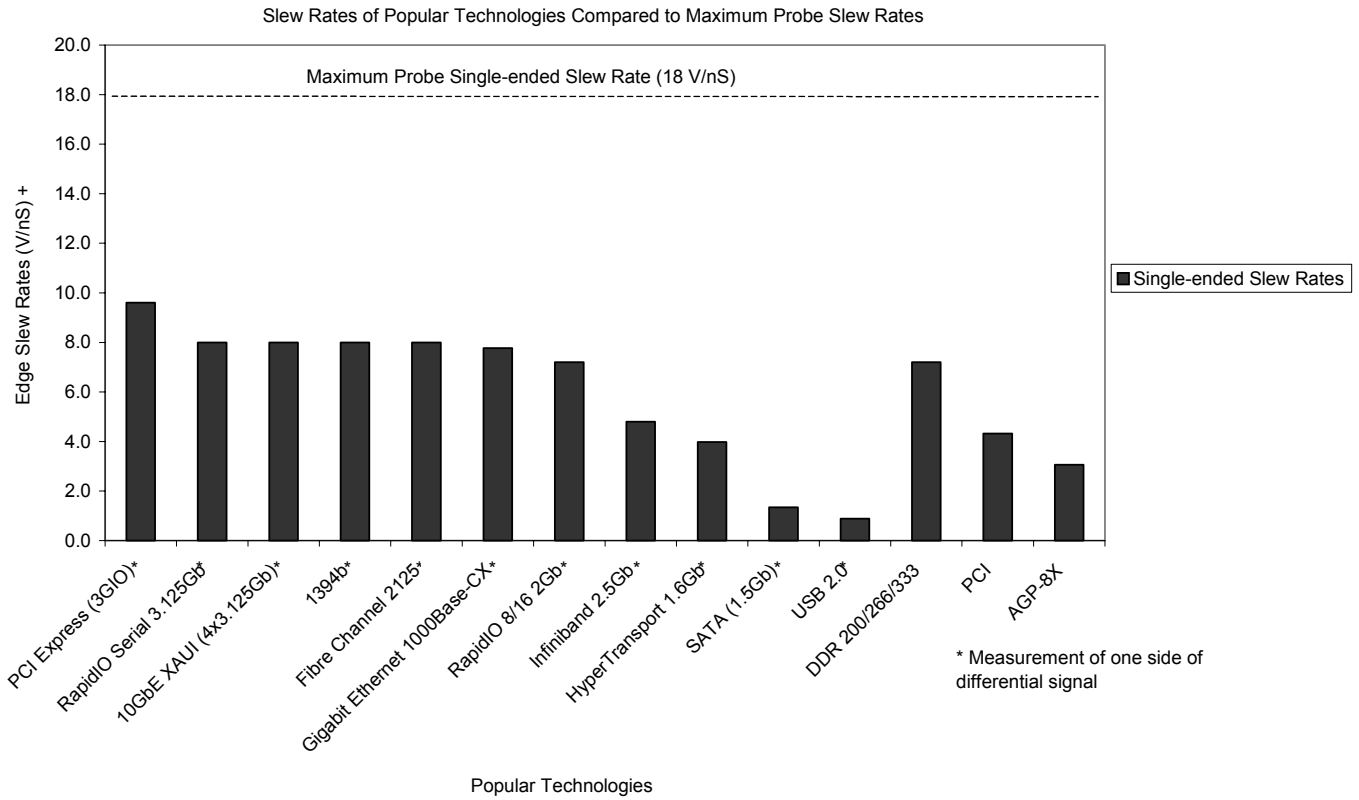

+
$$\frac{\text{Maximum Edge Amplitude} \times 0.6}{\text{Minimum 20\% to 80\% Rise Time}}$$

Recommended Configurations Overview

The recommended configurations are designed to give the best probe performance for different probing situations. The probe configurations are shown in the order of the best performance to the least performance.

1 Solder-in Differential Probe Head (full bandwidth)

This configuration has a bandwidth of greater than 12 GHz (see the graphs starting on page 1-28). The configuration consists of the following parts:

- N5381A — Solder-in Differential Probe Head
- 01169-81301 — tin-plated nickel wires (2 each)

The 01169-81301 wire has been trimmed and formed as per trim gauge 01169-23801.

Figure 1-6

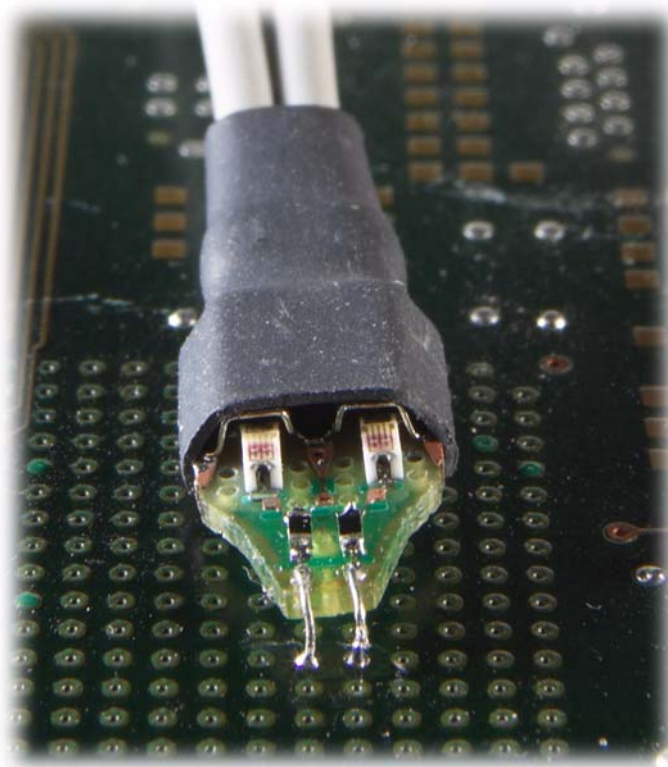

2 Differential Browser Probe Head (full bandwidth)

This configuration has a bandwidth of greater than 12 GHz (see the graphs starting on page 1-28). The configuration consists of the following parts:

- N5382A — Differential Browser Probe Head
- 01130-43202 — Ergonomic handle
- 01169-21304 — tin-plated steel wires (2 each)

The 01169-21304 wire has been trimmed and formed as per trim gauge 01169-23801.

Figure 1-7

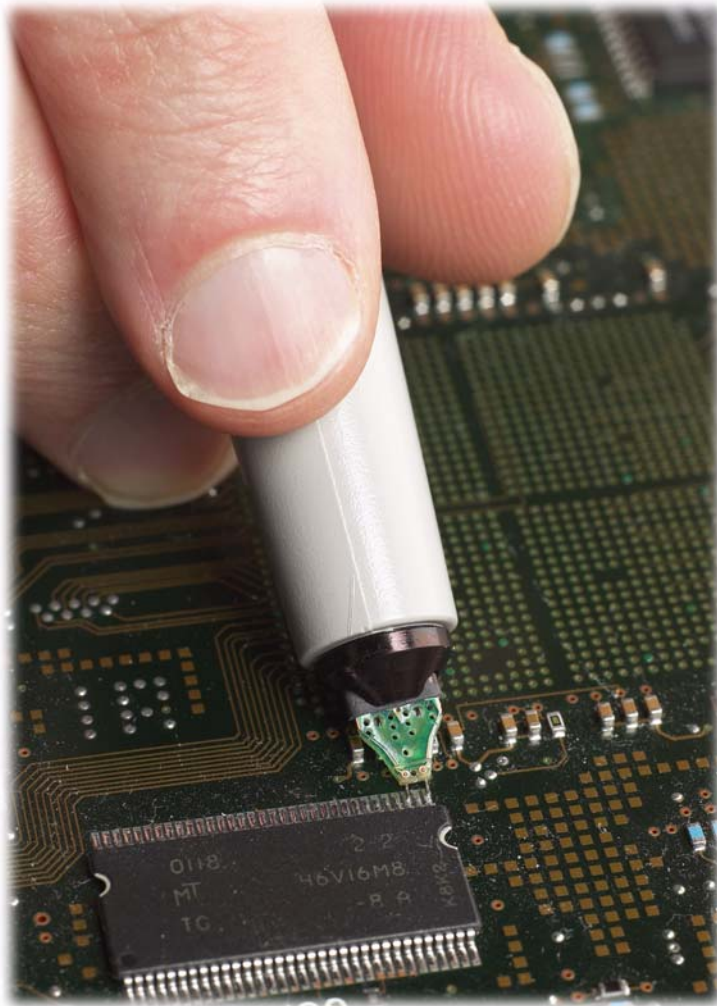

3 SMA Probe Head (full bandwidth)

This configuration has a bandwidth of greater than 12 GHz (see the graphs starting on page 1-28). The two outside SMA connectors are for input signal connection and the center SMA connector can be used to provide a dc bias for the termination. The configuration consists of the following parts:

- N5380A — SMA Probe Head

Figure 1-8

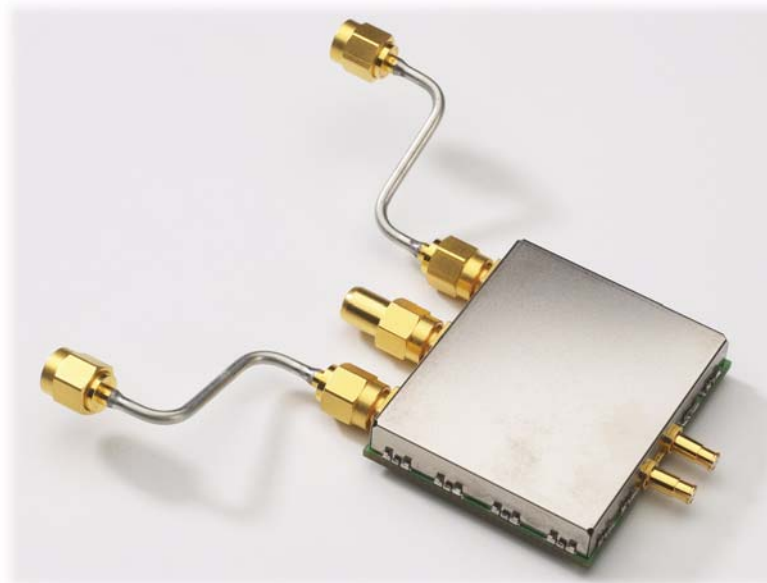

SMA Probe Head Schematic

N5380A SMA Probe Head

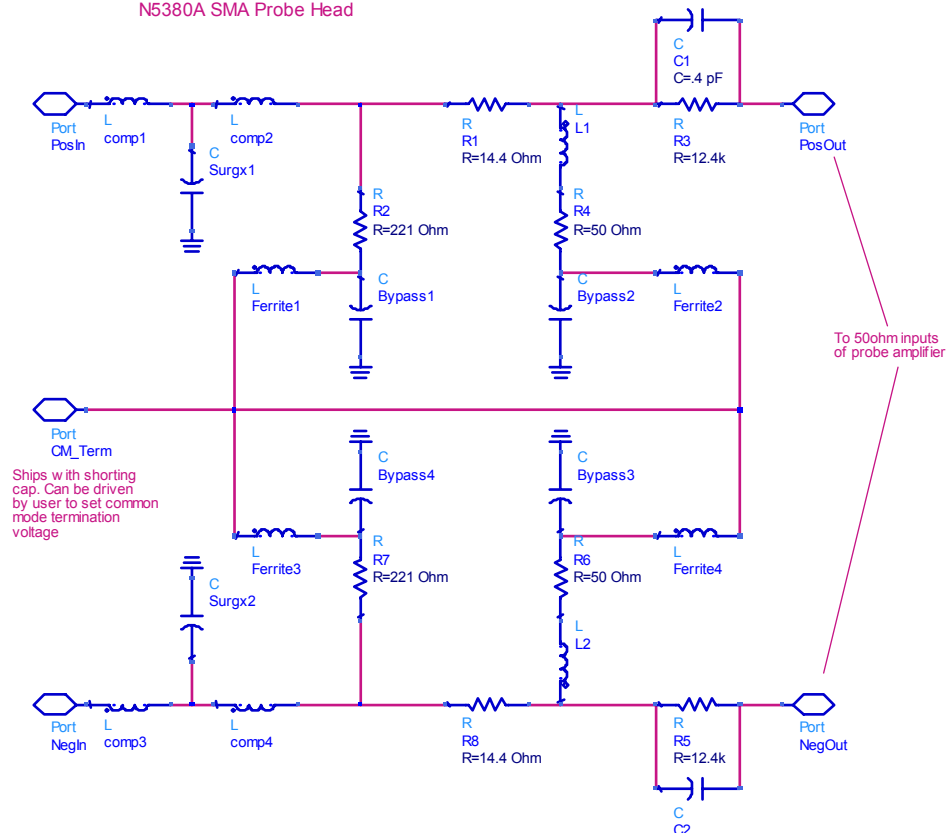

Other Configurations Overview

Other configurations of probe heads are available in the E2669A connectivity kit. Not all of these configurations will give the best probe performance of the 1169A. The probe configurations are shown in the order of the best performance to the least performance.

4 Solder-in Differential Probe Head (high bandwidth resistors)

This configuration has a bandwidth of greater than 12 GHz (see the graphs starting on page 1-28). The configuration consists of the following parts:

- E2677A — Solder-in Differential Probe Head
- 01131-81510 — 91 Ω mini-axial lead resistors (2 each)

The 01131-81510 resistor has been trimmed and formed as per template 01131-94311.

Figure 1-9

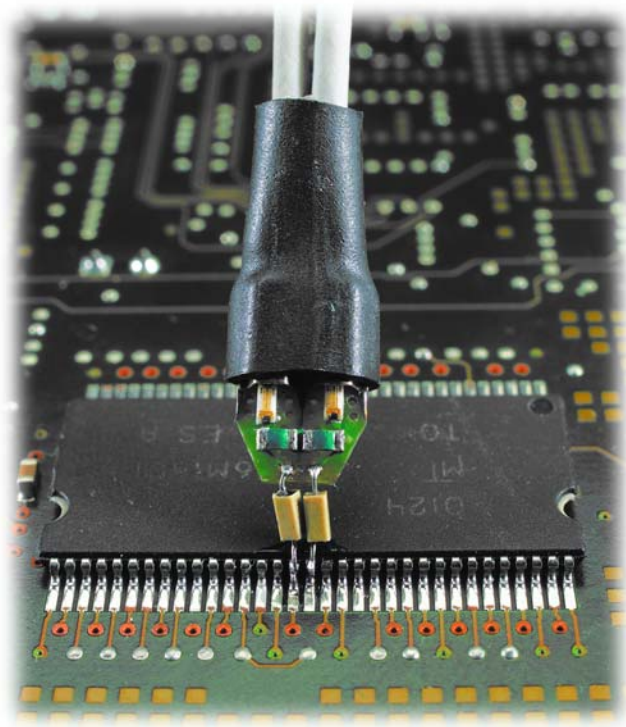

5 Socketed Differential Probe Head (high bandwidth resistors)

This configuration has a bandwidth of greater than 12 GHz (see the graphs starting on page 1-30). This configuration consists of the following parts:

- E2678A — Socketed Differential Probe Head
- 01130-81506 — 82 Ω axial lead resistors (2 each)

The 01130-81506 resistor has been trimmed and formed as per template 01131-94308.

Figure 1-10

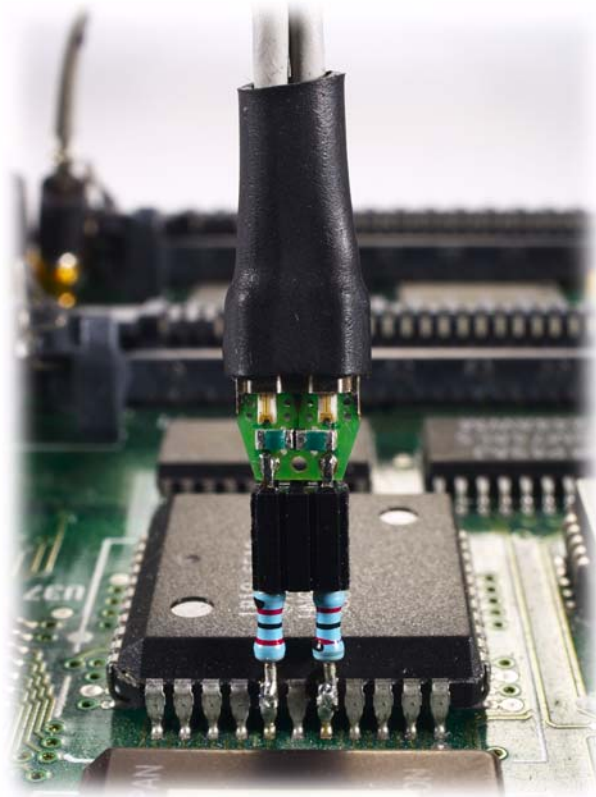

6 Differential Browser Probe Head

This configuration has a bandwidth approximately equal to 6 GHz (see the graphs starting on page 1-32). This configuration consists of the following parts:

- E2675A — Differential Browser Probe Head
- 01131-62102 — 91 Ω resistor probe tips (2 each)
- 01131-43201 — Ergonomic handle (optional)

Figure 1-11

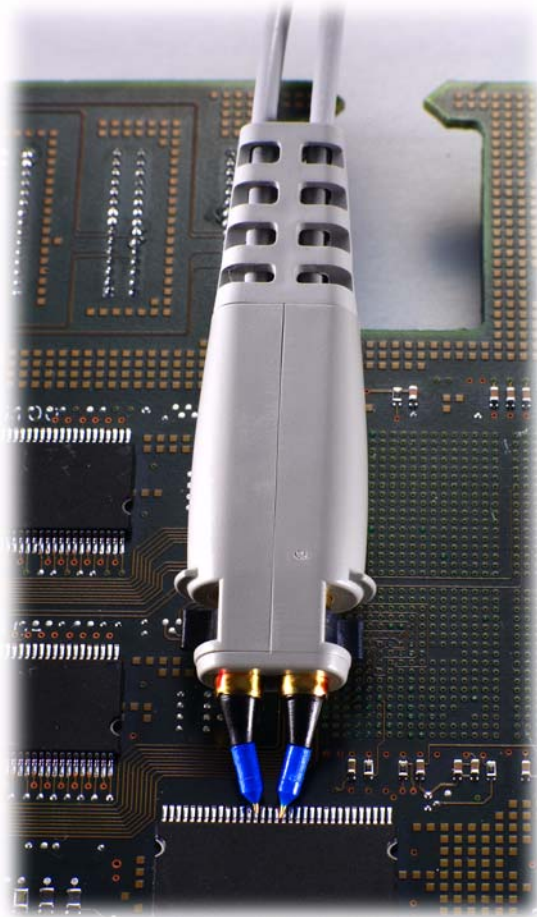

7 Solder-in Single-ended Probe Head (high bandwidth resistors)

This configuration has a bandwidth approximately equal to 6 GHz (see the graphs starting on page 1-34). This configuration consists of the following parts:

- E2679A — Solder-in Single-ended Probe Head
- 01131-81510 — 91 Ω mini-axial lead resistor
- 01131-81504 — 0 Ω mini-axial lead resistor

The 01131-81510 and 01131-81504 resistors have been trimmed and formed as per template 01131-94311.

Figure 1-12

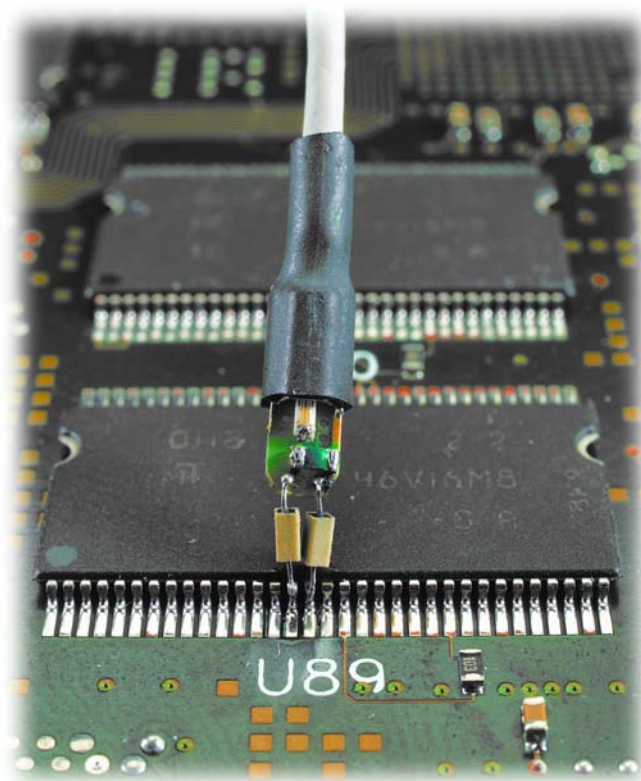

8 Single-ended Browser Probe Head

This configuration has a bandwidth approximately equal to 6 GHz (see the graphs starting on page 1-36). This configuration consists of the following parts:

- E2676A — Single-ended Browser Probe Head
- 01131-43202 — Ergonomic handle (optional)
- 01131-62102 — 91 Ω resistor probe tip
- 01130-60005 — Ground collar assembly

Figure 1-13

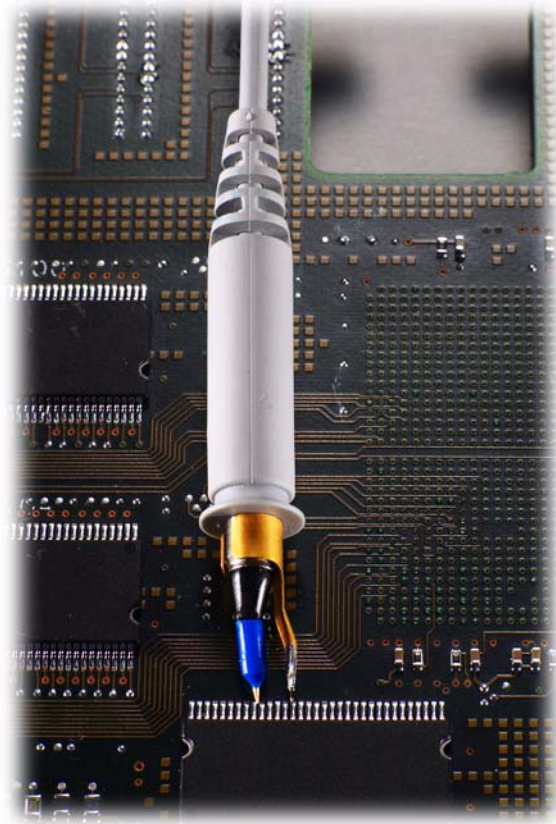

9 Socketed Differential Probe Head with damped wire accessory

This configuration has a bandwidth approximately equal to 1.2 GHz (see the graphs starting on page 1-38). This configuration consists of the following parts:

- E2678A — Socketed Differential Probe Head
- 01130-21302 — 160 Ω damped wire accessory (2 each)

Figure 1-14

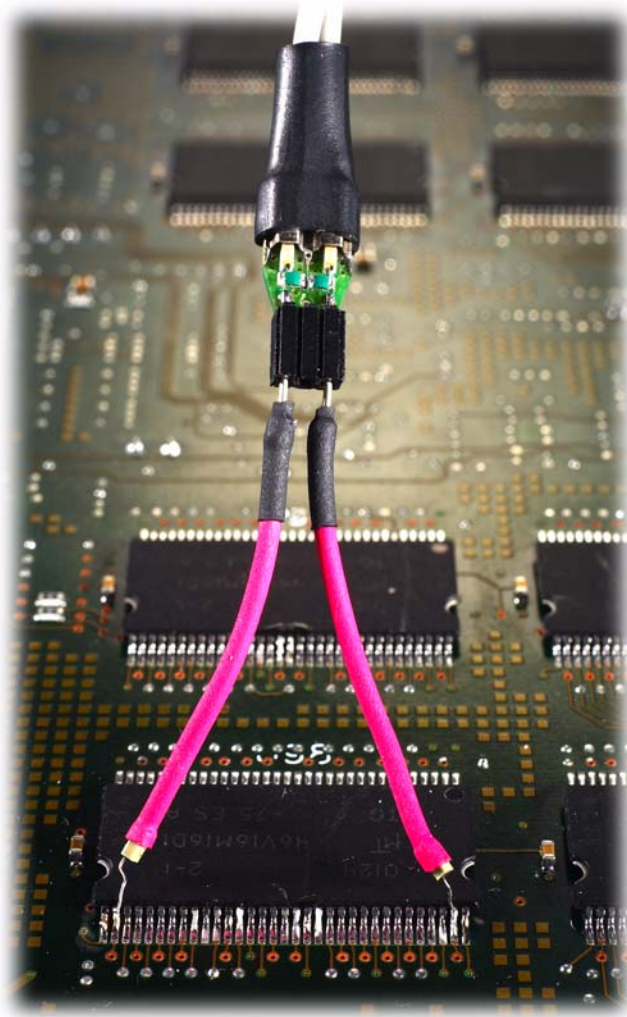

Recommended configurations at a glance

Table 1-2

Probe Head Configurations	Band width (GHz)	Cdiff ¹ (pF)	Cse ² (pF)	Starting Page of Performance Graphs	Usage
1 N5381A Soldier-in differential (full bandwidth)	> 12	0.21	0.35	1-21	<ul style="list-style-type: none"> • Differential and Single-ended signals • Solder-in hands free connection • Hard to reach targets • Very small fine pitch targets • Characterization
2 N5382A Differential browser (full bandwidth)	> 12	0.21	0.35	1-21	<ul style="list-style-type: none"> • Differential and Single-ended signals • Hand-held browsing • Probe holders • General purpose troubleshooting • Ergonomic handle available
3 N5380A SMA (full bandwidth)	> 12	N/A	N/A	1-24	<ul style="list-style-type: none"> • Full bandwidth • Preserve oscilloscope channels as opposed to using the A minus B mode. • Removes inherent cable loss through compensation. • Common mode termination voltage can be applied • Offset matched sma cables adapt to variable spacing

¹ Capacitance seen by differential signals

² Capacitance seen by single-ended signals

Other configurations at a glance

Table 1-3

Probe Head Configurations	Band width (GHz)	Cdiff ¹ (pF)	Cse ² (pF)	Starting Page of Performance Graphs	Usage
4 E2677A Solder-in differential (high bandwidth resistors)	> 12	0.27	0.44	1-28	<ul style="list-style-type: none"> Differential and Single-ended signals Solder-in hands free connection Hard to reach targets Very small fine pitch targets Characterization
5 E2678A Socketed differential (high bandwidth resistors)	> 12	0.34	0.56	1-30	<ul style="list-style-type: none"> Differential and Single-ended signals Removable connection using solder-in resistor pins Hard to reach targets
6 E2675A Differential browser	~ 5.2	0.32	0.57	1-32	<ul style="list-style-type: none"> Differential and Single-ended signals Hand-held browsing Probe holders General purpose troubleshooting Ergonomic handle available
7 E2679A Solder-in single-ended (high bandwidth resistors)	~ 5.2	N/A	0.50	1-34	<ul style="list-style-type: none"> Single-ended signals only Solder-in hands free connection when physical size is critical Hard to reach targets Very small fine pitch targets
8 E2676A Single-ended browser	~ 6	N/A	0.65	1-36	<ul style="list-style-type: none"> Single-ended signals only Hand or probe holder where physical size is critical General purpose troubleshooting Ergonomic handle available
9 E2678A Socketed differential with damped wire accessories	~ 1.2	0.63	0.95	1-38	<ul style="list-style-type: none"> Differential and Single-ended signals For very wide spaced targets Connection to 25 mil square pins when used with supplied sockets
10 E2695A SMA	~ 8	N/A	N/A	1-40	<ul style="list-style-type: none"> Not full bandwidth but good signal fidelity Preserve oscilloscope channels as opposed to using the A minus B mode. Removes inherent cable loss through compensation. Common mode termination voltage can be applied Offset sma cables adapt to variable spacing

¹ Capacitance seen by differential signals

² Capacitance seen by single-ended signals

Detailed Information for Recommended Configurations

This section contains graphs of the performance characteristics of the 1169A active probe using the different probe heads that come with the N5381A, N5382A, and N5380A kits.

1 N5381A Solder-in Differential Probe Head (Full Bandwidth)
and 2 N5382A Differential Browser Probe Head (Full Bandwidth)

Unless otherwise noted, time and frequency responses shown here are for the probe only. When the probe is used with the 80000 series oscilloscope, magnitude and phase correction can be applied to further optimize the overall response.

Figure 1-15

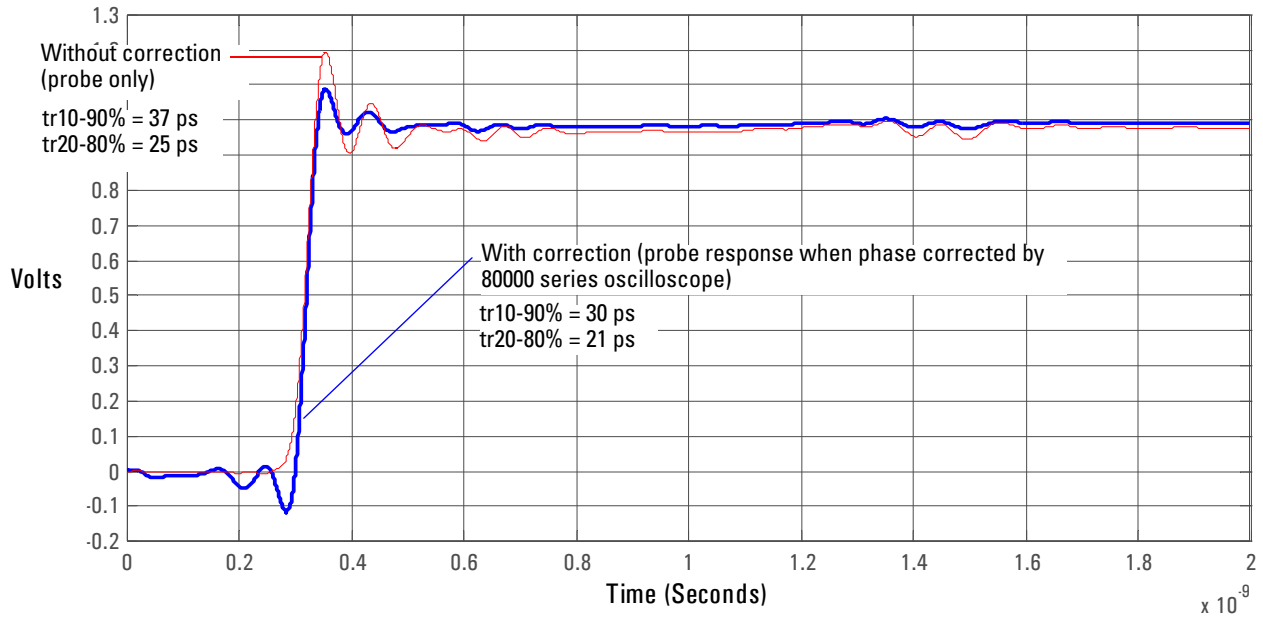

Graph of step response with and without phase correction. Normalized to an ideal input step.

Figure 1-16

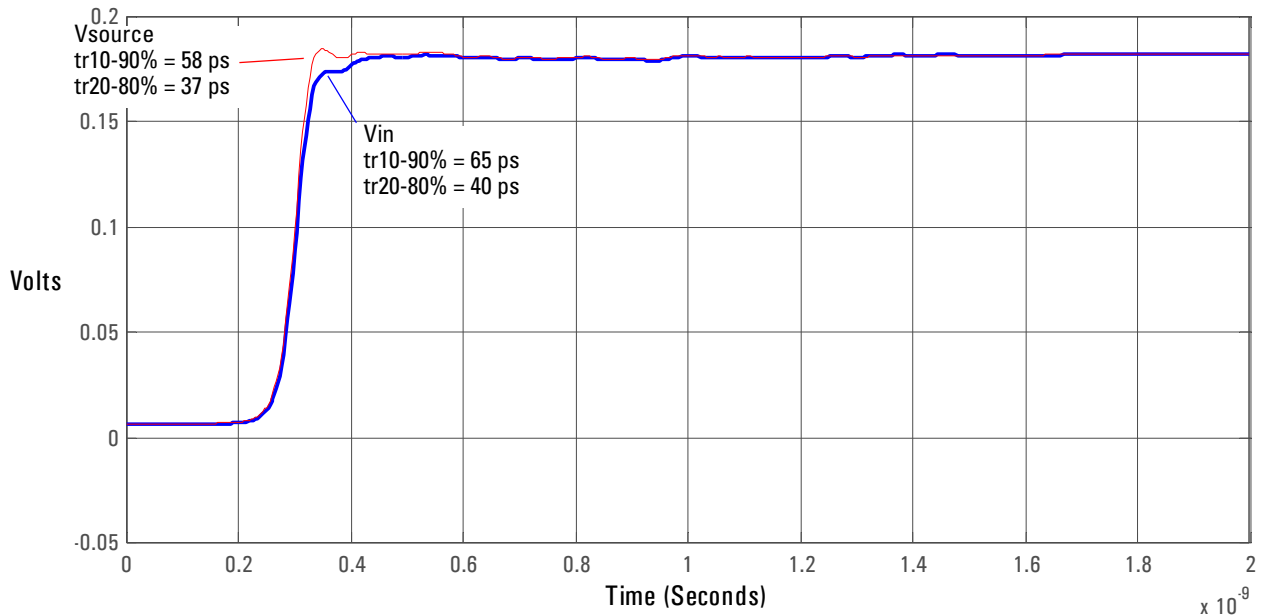

Graph of 25 Ω 58 ps step generator with and without probe connected.

Differential and Single-ended Probe Configurations
1 N5381A Solder-in Differential Probe Head (Full Bandwidth) and 2 N5382A Differential Browser Probe Head (Full Bandwidth)

Figure 1-17

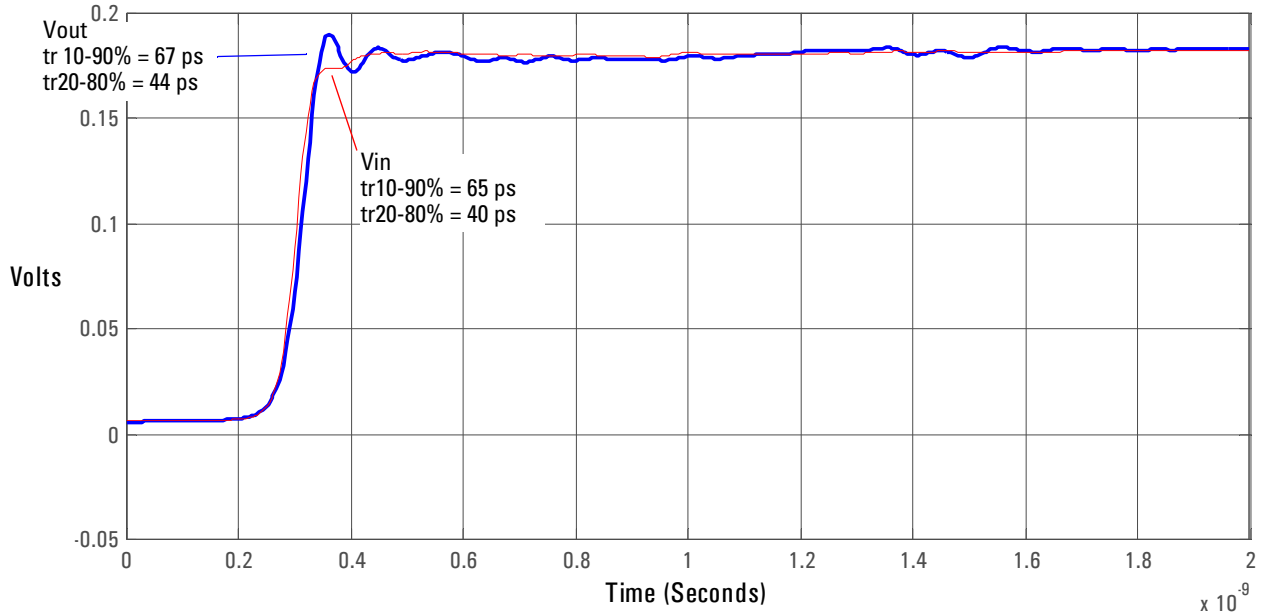

Graph of V_{in} and V_{out} of probe with a 25Ω 58 ps step generator.

Figure 1-18

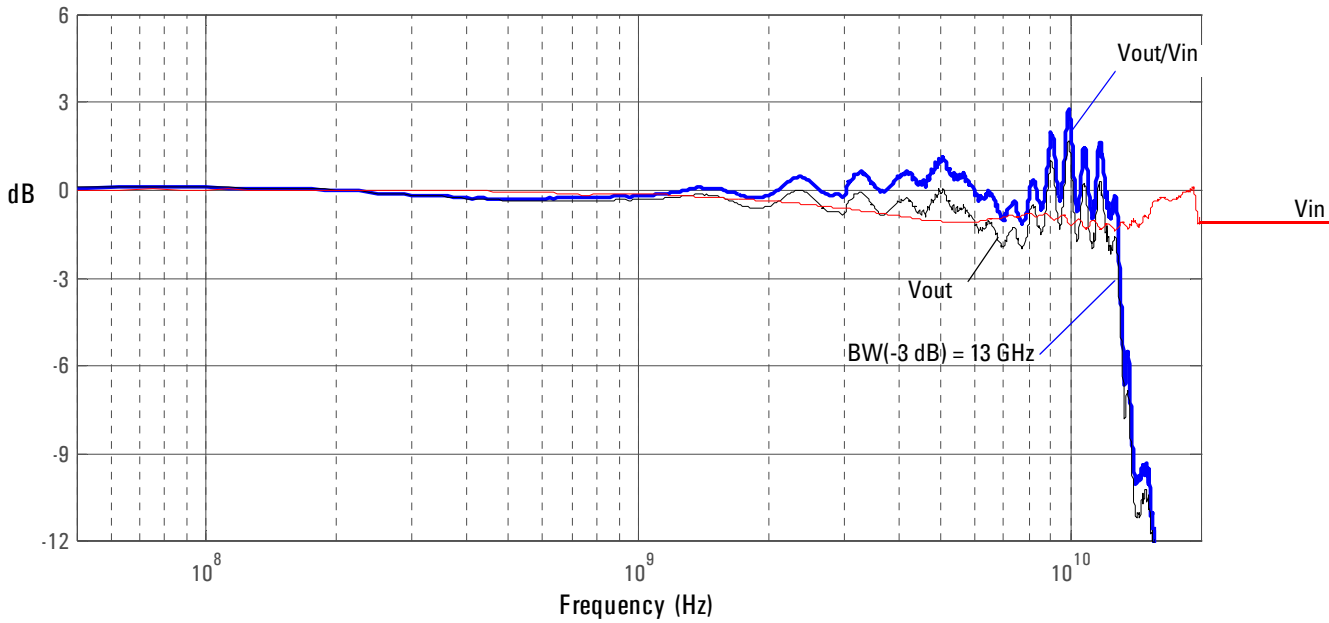

Graph of $\text{dB}(V_{in})$ and $\text{dB}(V_{out}) + 10.8 \text{ dB}$ of probe with a 25Ω source and $\text{dB}(V_{out}/V_{in}) + 10.8 \text{ dB}$ frequency response.

Figure 1-19

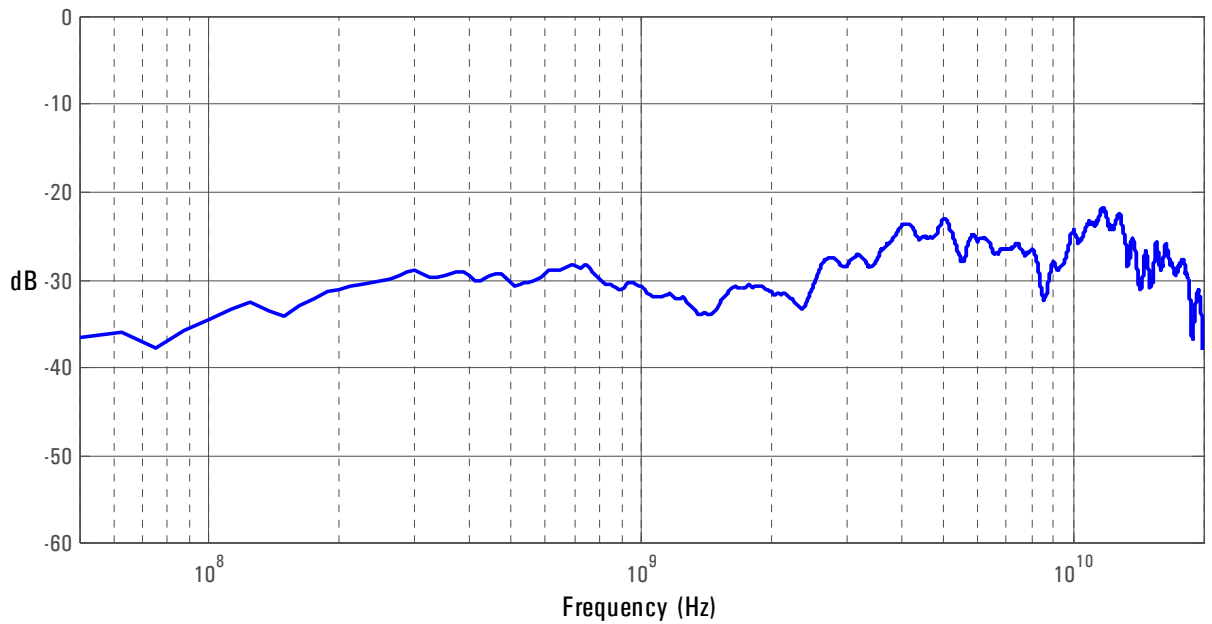

Graph of $\text{dB}(V_{\text{out}}/V_{\text{in}}) + 10.8 \text{ dB}$ frequency response when inputs driven in common (common mode rejection).

Figure 1-20

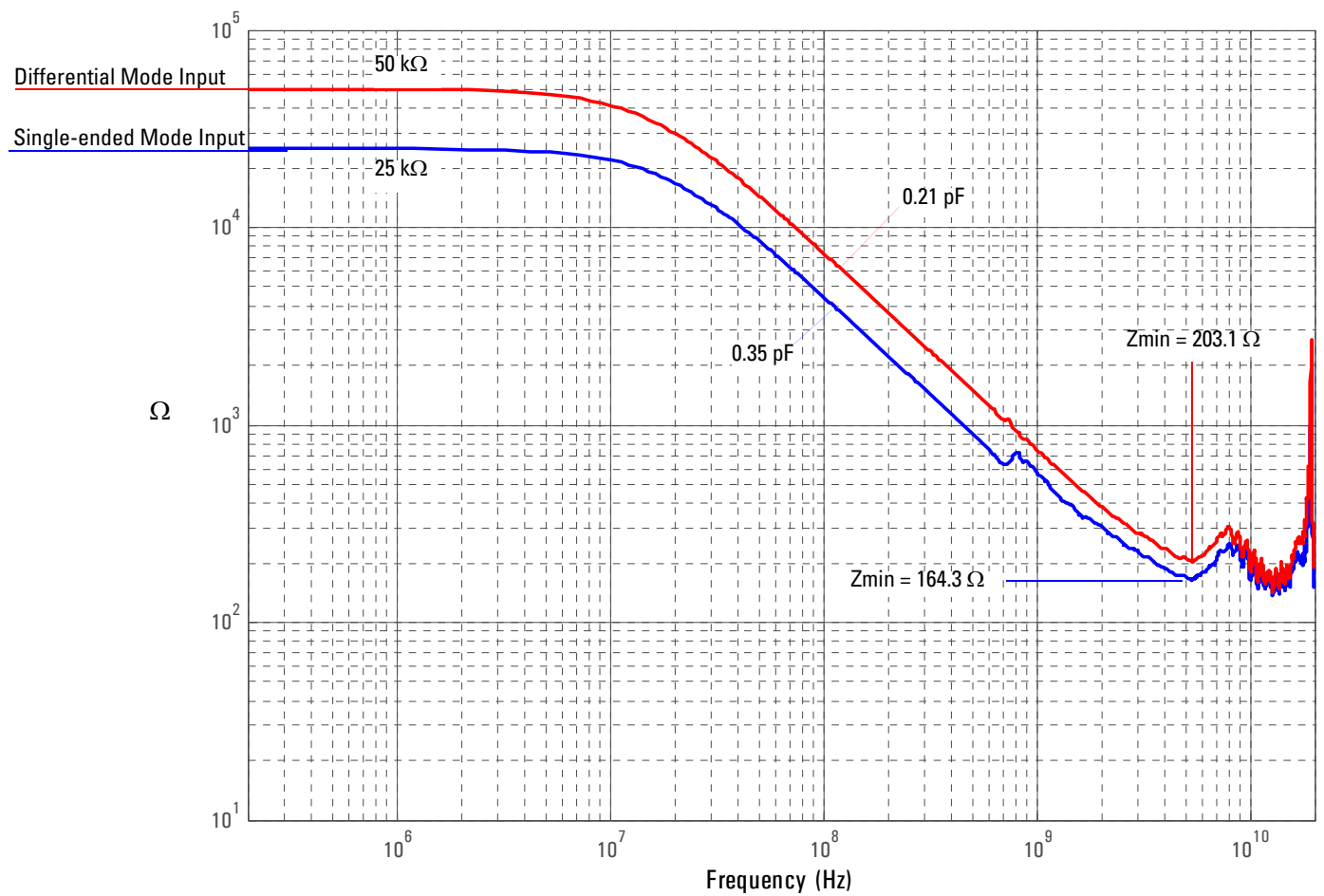

Magnitude plot of probe input impedance versus frequency.

3 N5380A SMA Probe Head (Full Bandwidth)

Unless otherwise noted, time and frequency responses shown here are for the probe only. When the probe is used with the 80000 series oscilloscope, magnitude and phase correction is applied to further optimize the overall response.

Figure 1-21

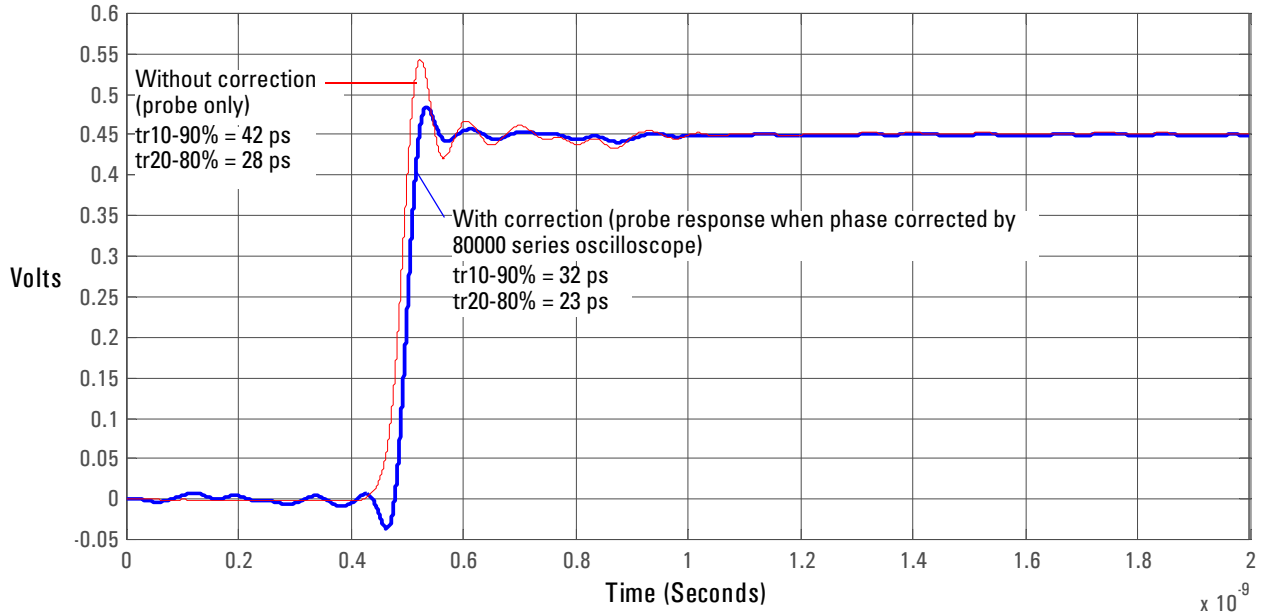

Graph of step response with and without phase correction. Normalized to an ideal input step.

Figure 1-22

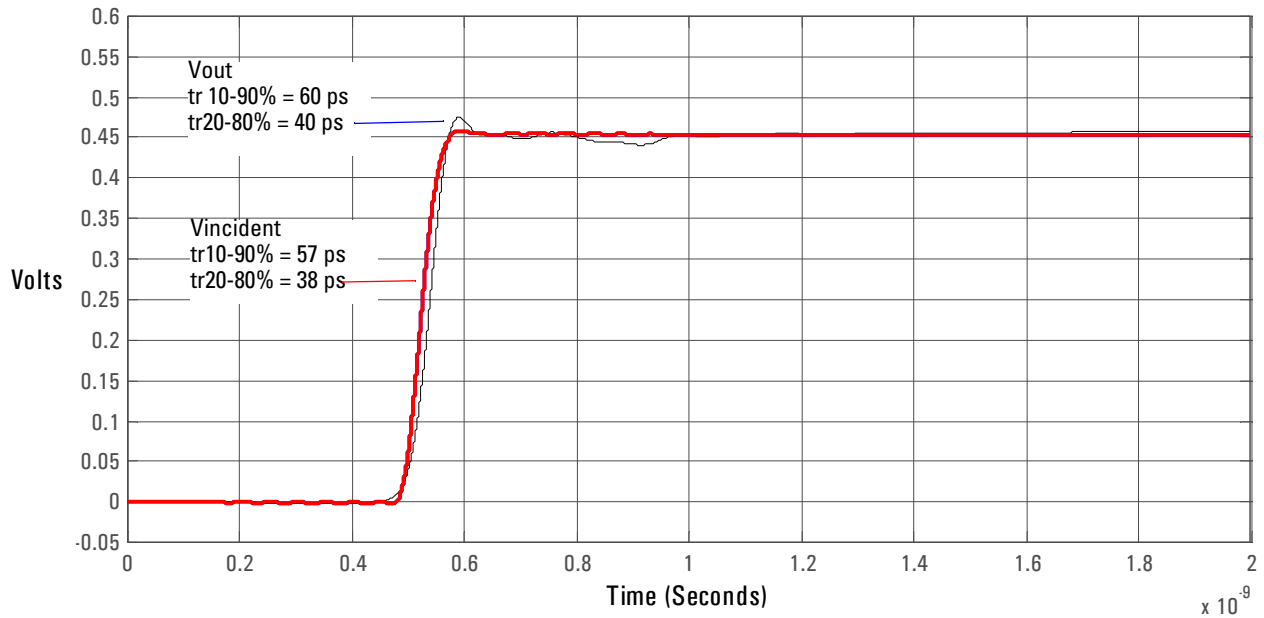

Graph of Vincident and Vout of probe with a 57 ps step.

Figure 1-23

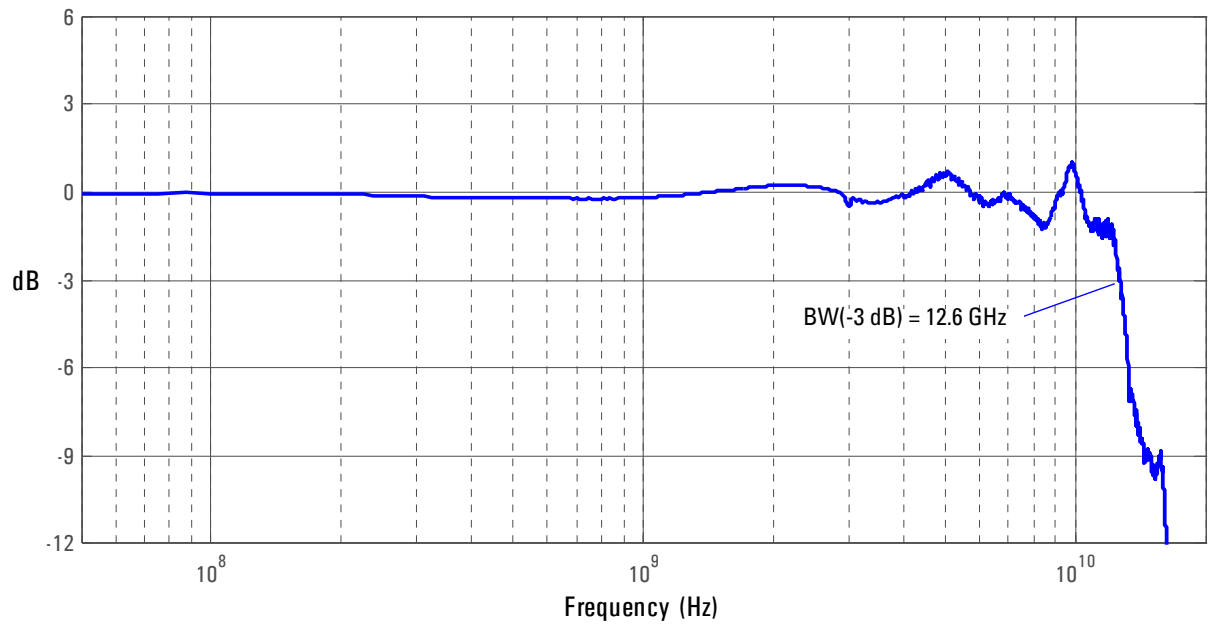

Magnitude plot of differential insertion loss +6.8 dB.

Figure 1-24

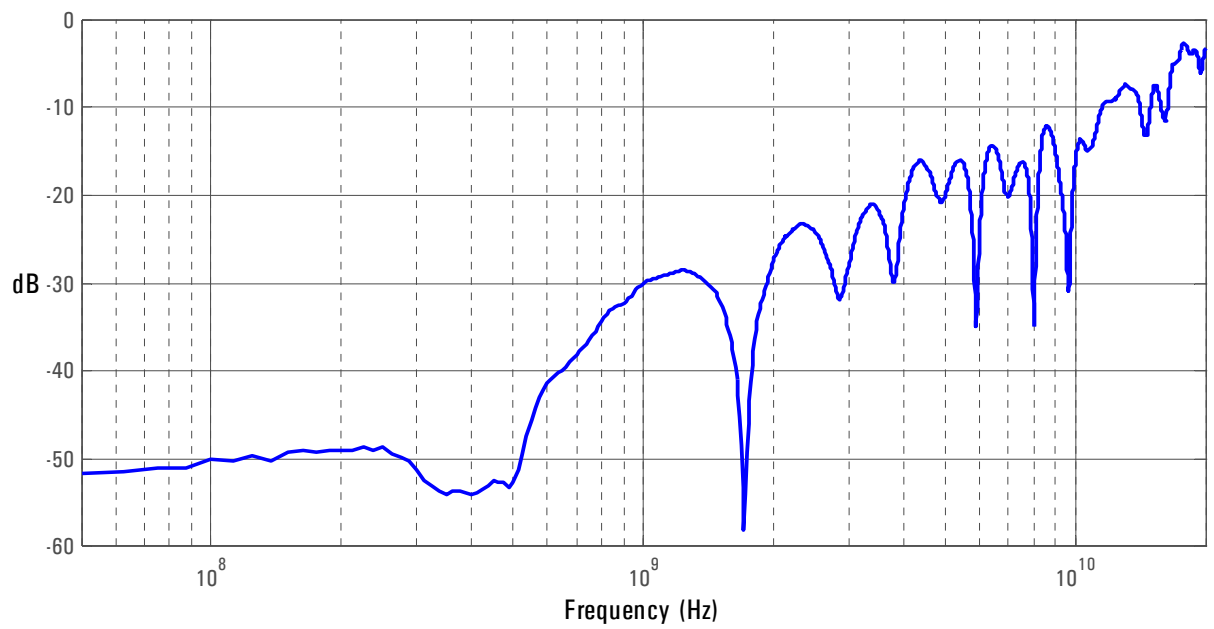

Magnitude plot of differential return loss.

Differential and Single-ended Probe Configurations
3 N5380A SMA Probe Head (Full Bandwidth)

Figure 1-25

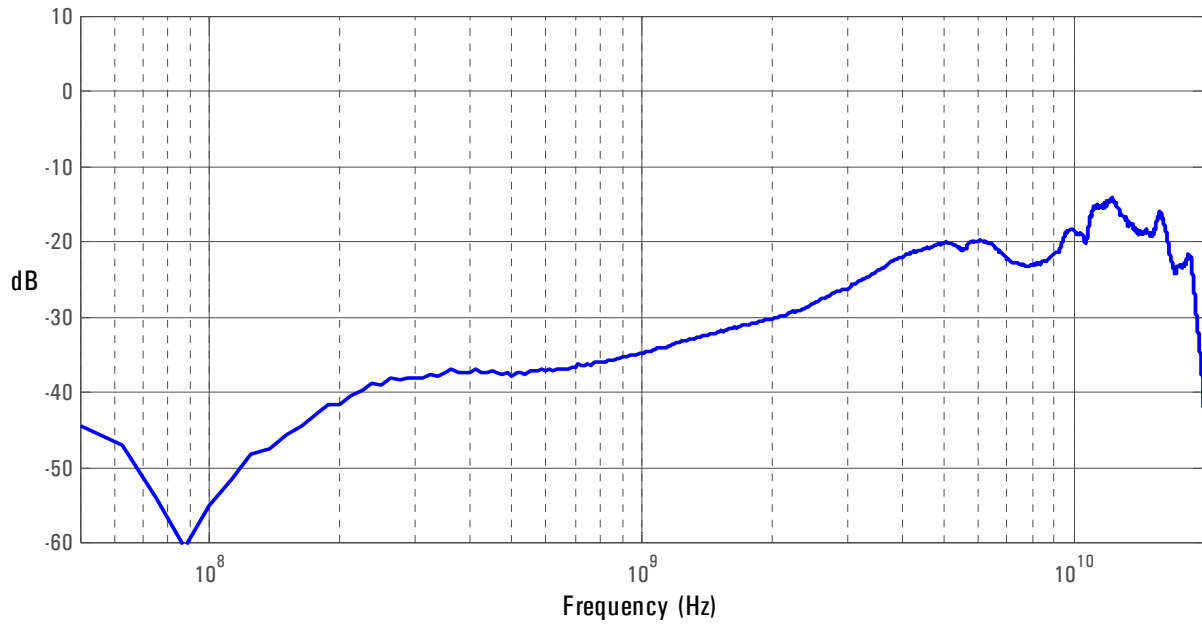

Magnitude plot of common mode response +6.8dB (common mode rejection).

Detailed Information for Other Configurations

This section contains graphs of the performance characteristics of the 1169A active probe using the different probe heads that come with the E2669A differential connectivity kit and the E2695A SMA probe head.

4 E2677A Solder-in Differential Probe Head (High Bandwidth)

For solder-in applications, the N5381A probe head is preferred. Variations in the manufacture and positioning of the mini-axial lead resistors used with the E2677A cause variations in the response. If you must use the E2677A, insure that the mini-axial lead resistors are positioned directly adjacent to each other and touching.

Figure 1-1

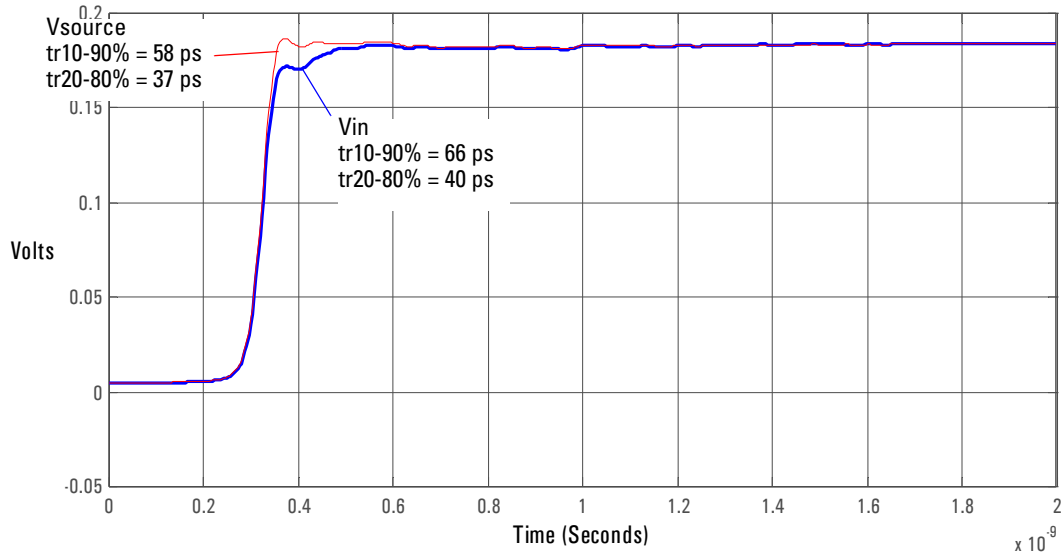

Graph of 25 Ω 58 ps step generator with and without probe connected.

Figure 1-2

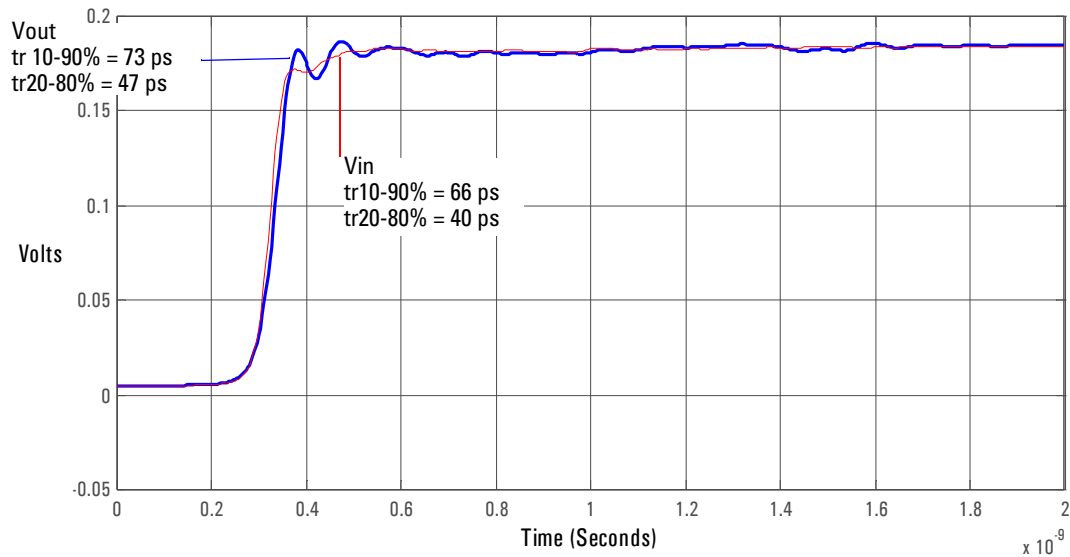

Graph of Vin and Vout of probe with a 25 Ω 58 ps step generator.

Figure 1-3

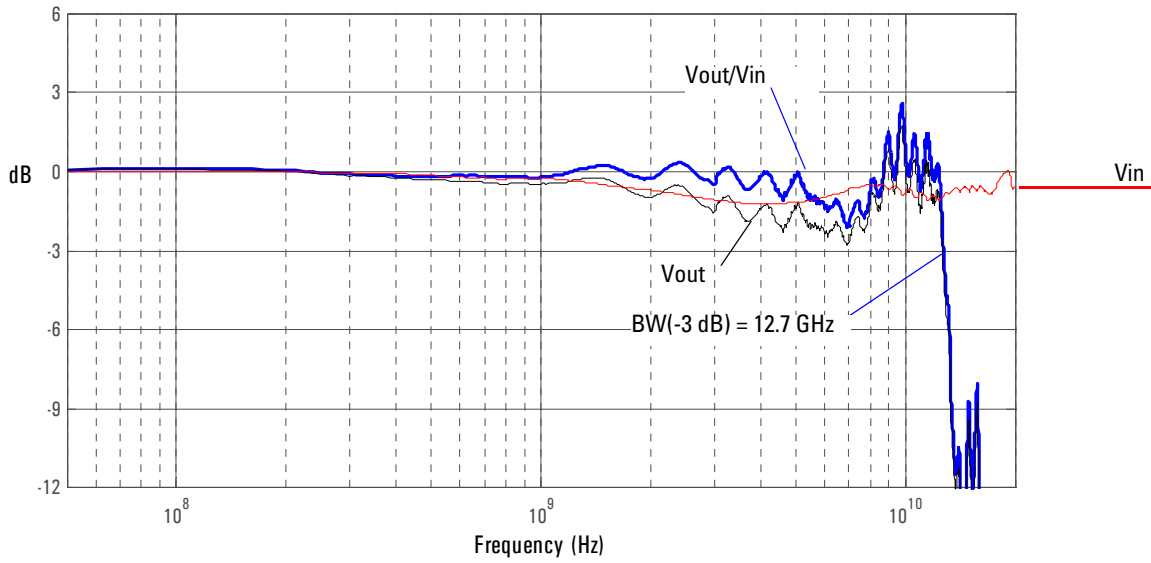

Graph of $\text{dB}(\text{Vin})$ and $\text{dB}(\text{Vout}) + 10.8 \text{ dB}$ of probe with a 25Ω source and $\text{dB}(\text{Vout}/\text{Vin}) + 10.8 \text{ dB}$ frequency response.

5 E2678A Socketed Differential Probe Head (High Bandwidth)

Figure 1-4

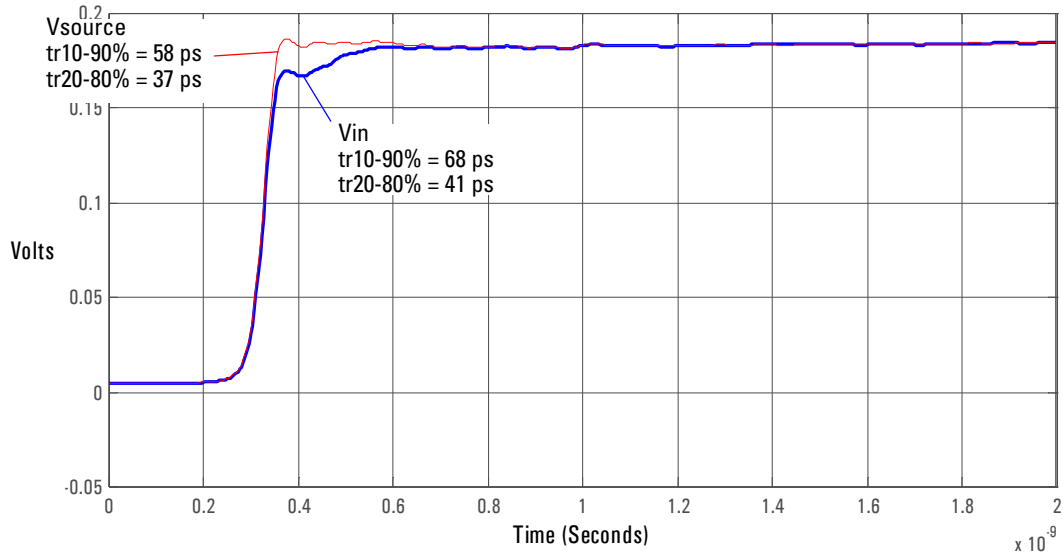

Graph of 25 Ω 58 ps step generator with and without probe connected.

Figure 1-5

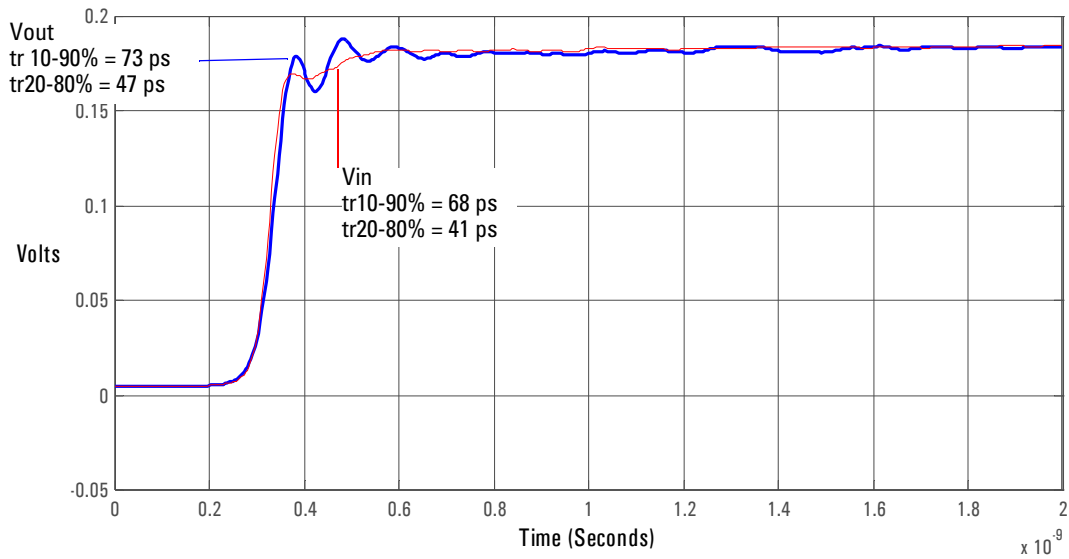

Graph of Vin and Vout of probe with a 25 Ω 58 ps step generator.

Figure 1-6

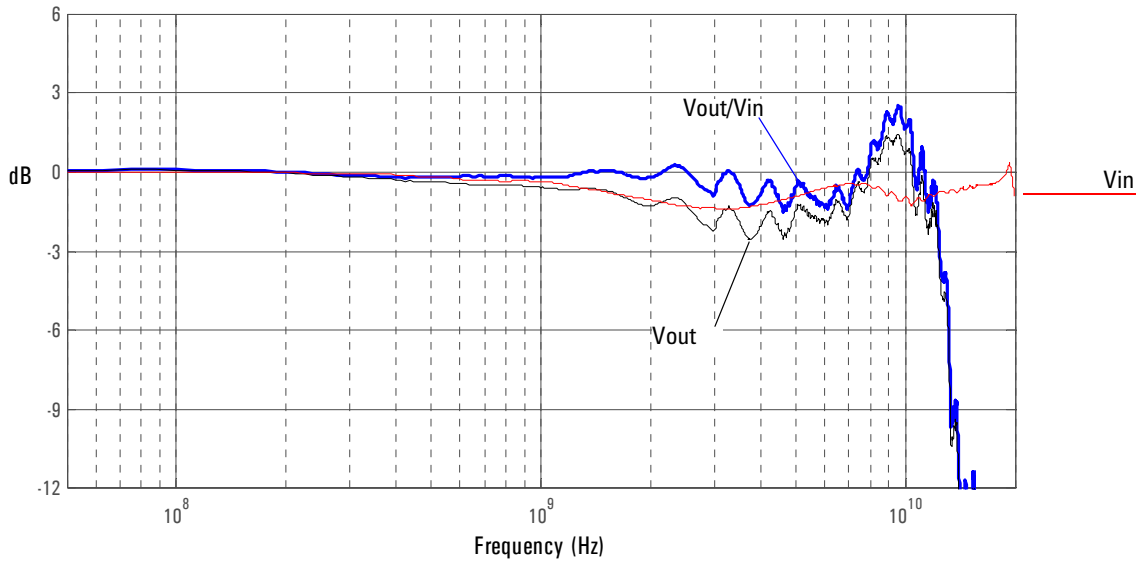

Graph of $\text{dB}(V_{in})$ and $\text{dB}(V_{out}) + 10.8 \text{ dB}$ of probe with a 25Ω source and $\text{dB}(V_{out}/V_{in}) + 10.8 \text{ dB}$ frequency response.

6 E2675A Differential Browser

Figure 1-7

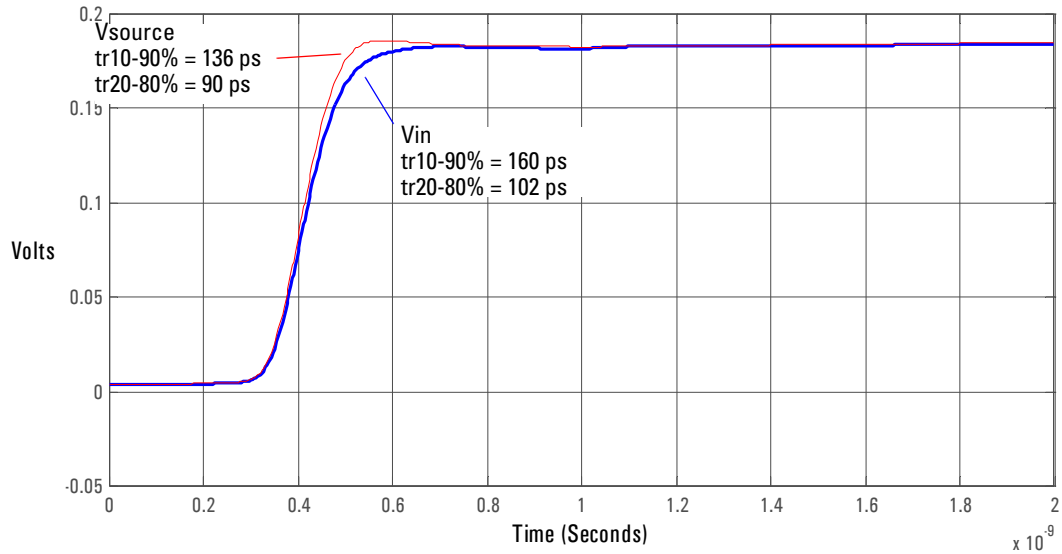

Graph of 25 Ω 136 ps step generator with and without probe connected.

Figure 1-8

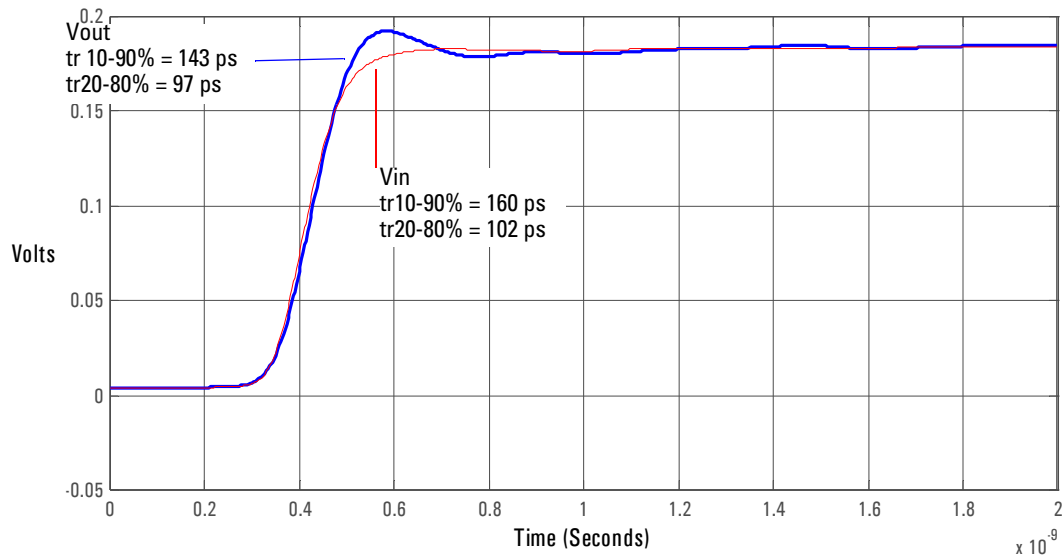

Graph of V_{in} and V_{out} of probe with a 25 Ω 136 ps step generator.

Figure 1-9

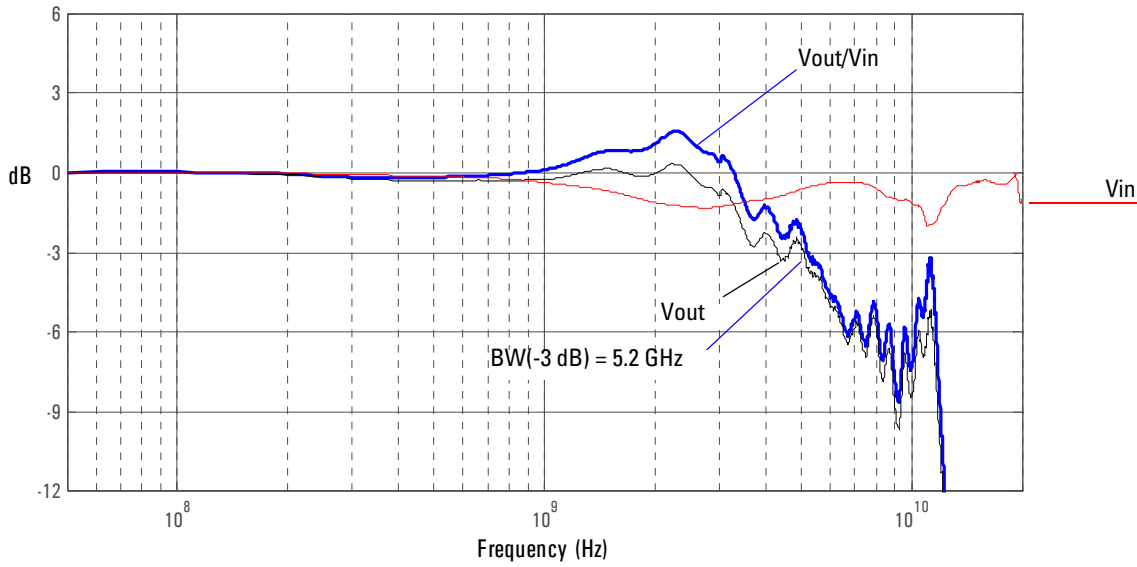

Graph of dB(Vin) and dB(Vout) + 10.8 dB of probe with a 25 Ω source and dB(Vout/Vin) + 10.8 dB frequency response.

7 E2679A Solder-in Single-ended Probe Head (High Bandwidth)

Figure 1-10

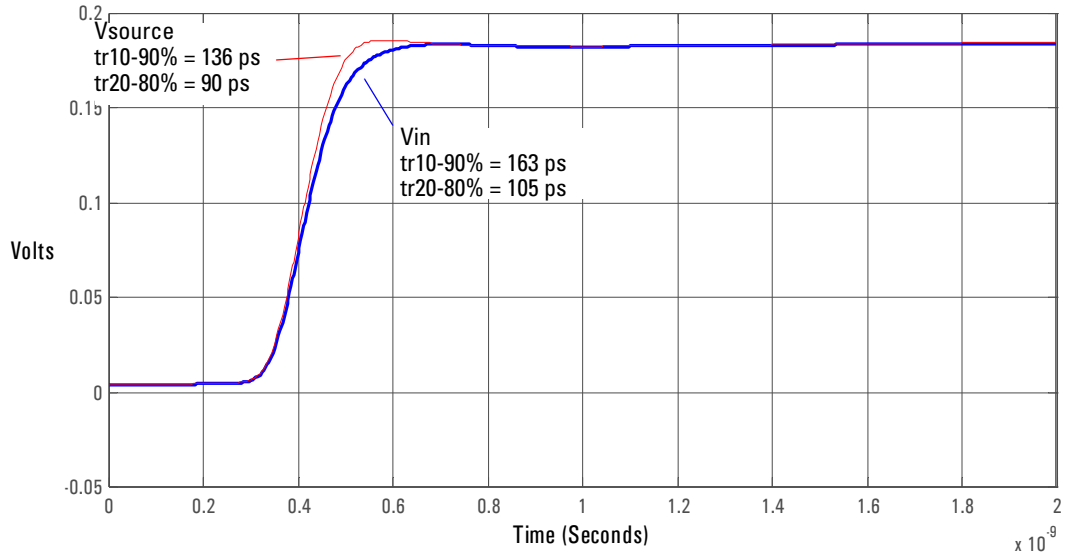

Graph of 25 Ω 136 ps step generator with and without probe connected.

Figure 1-11

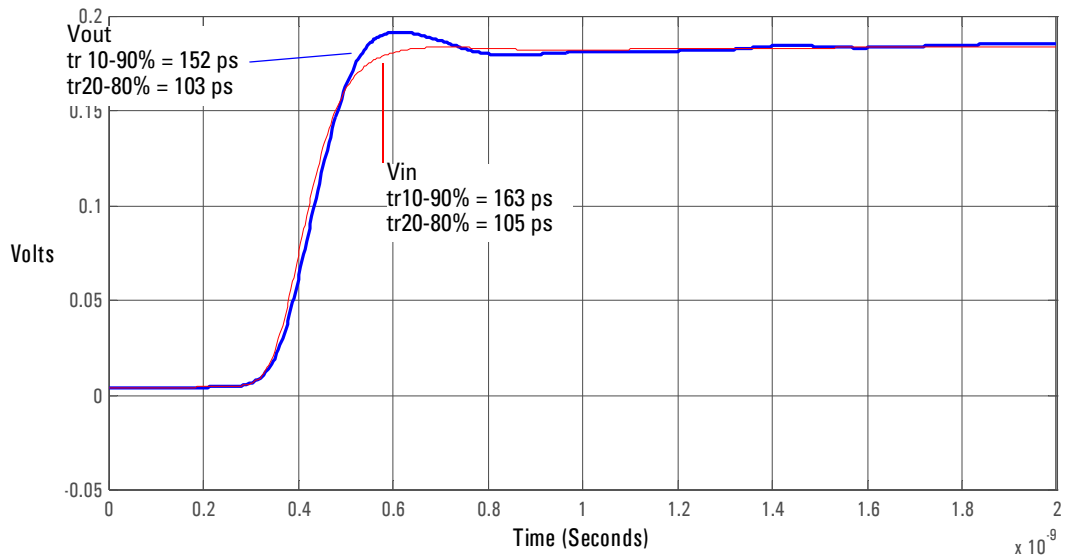

Graph of V_{in} and V_{out} of probe with a 25 Ω 136 ps step generator.

Figure 1-12

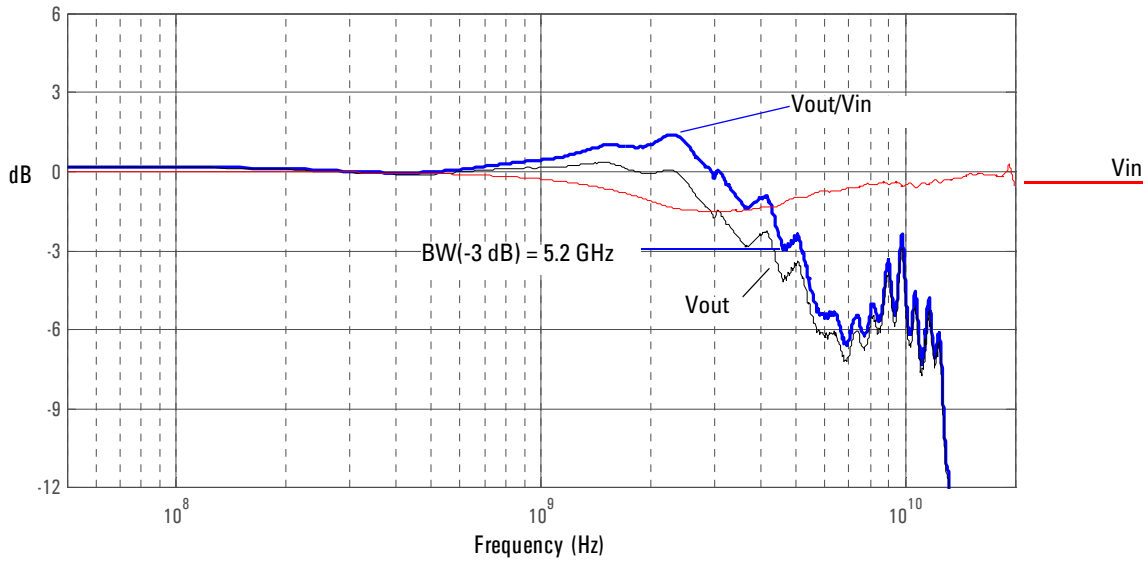

Graph of $\text{dB}(V_{in})$ and $\text{dB}(V_{out}) + 10.8 \text{ dB}$ of probe with a 25Ω source and $\text{dB}(V_{out}/V_{in}) + 10.8 \text{ dB}$ frequency response.

8 E2676A Single-ended Browser

Figure 1-13

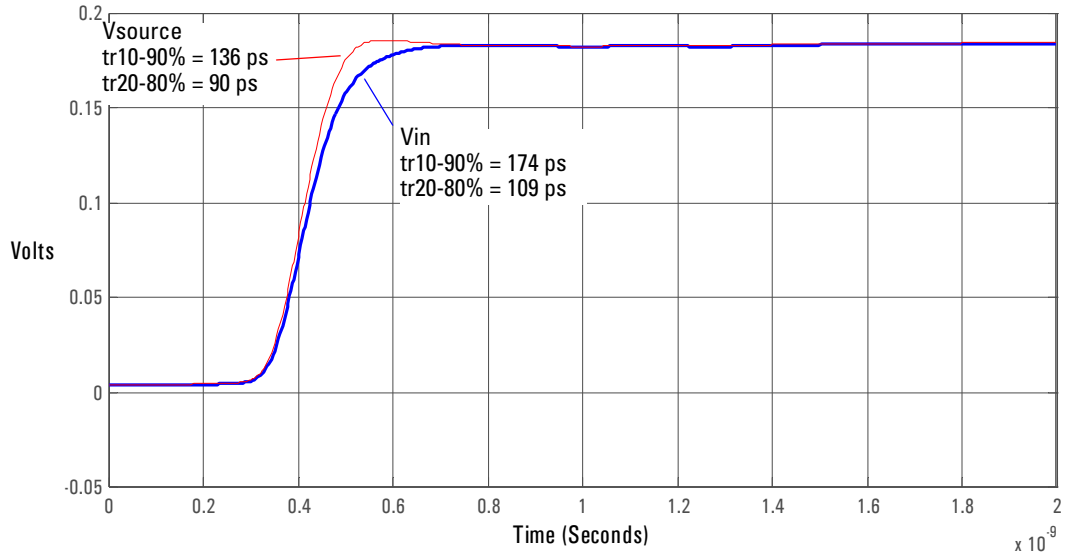

Graph of 25 Ω 100 ps step generator with and without probe connected.

Figure 1-14

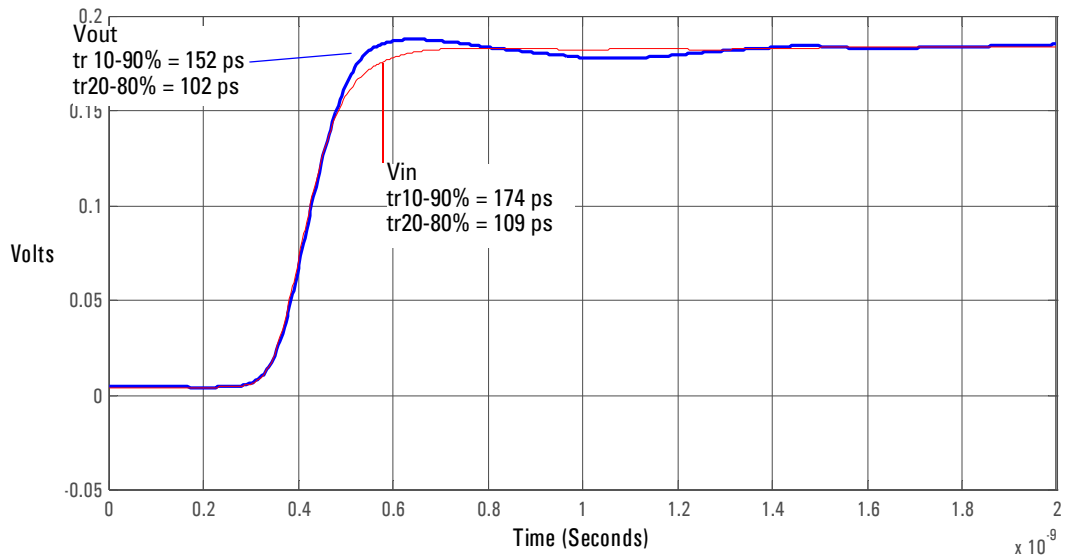

Graph of V_{in} and V_{out} of probe with a 25 Ω 100 ps step generator.

Figure 1-15

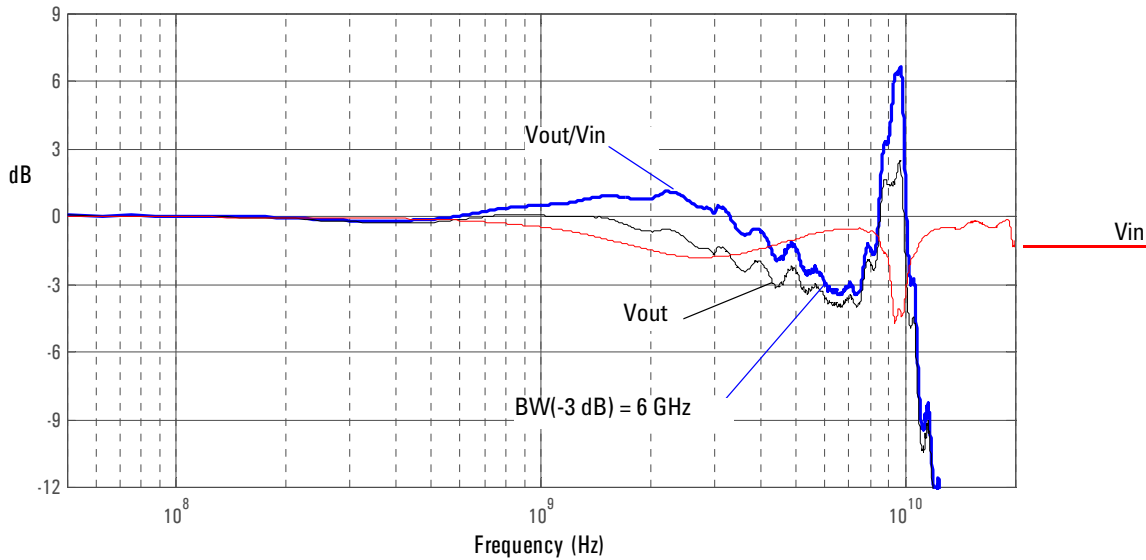

Graph of $\text{dB}(V_{in})$ and $\text{dB}(V_{out}) + 10.8 \text{ dB}$ of probe with a 25Ω source and $\text{dB}(V_{out}/V_{in}) + 10.8 \text{ dB}$ frequency response.

The ground inductance and structure of the E2676A Single-ended Browser causes a resonant peak at $\sim 10 \text{ GHz}$. This probe head was designed for the 1134A 7 GHz probe system. The input signal should be limited to an equivalent bandwidth of about 4.2 GHz (110 ps, 10-90%) to prevent ringing at 10 GHz

9 E2678A Socketed Differential Probe Head with Damped Wire Accessory

Due to reflections on the long wire accessories, signals being probed should be limited to $\sim \geq 240$ ps rise time measured at the 10% and 90% amplitude levels. This is equivalent to $\sim \leq 1.5$ GHz bandwidth.

Figure 1-16

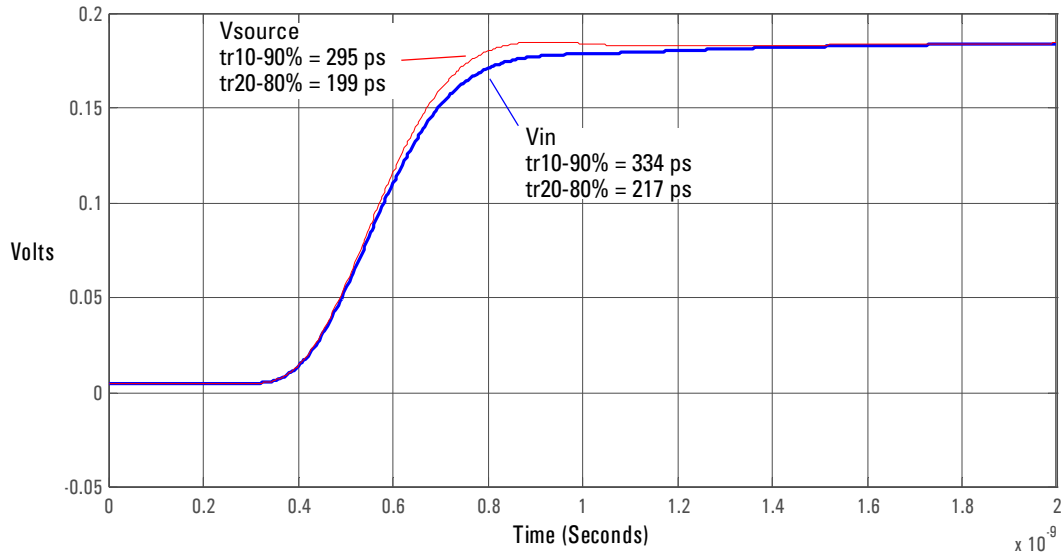

Graph of 25 Ω 295 ps step generator with and without probe connected.

Figure 1-17

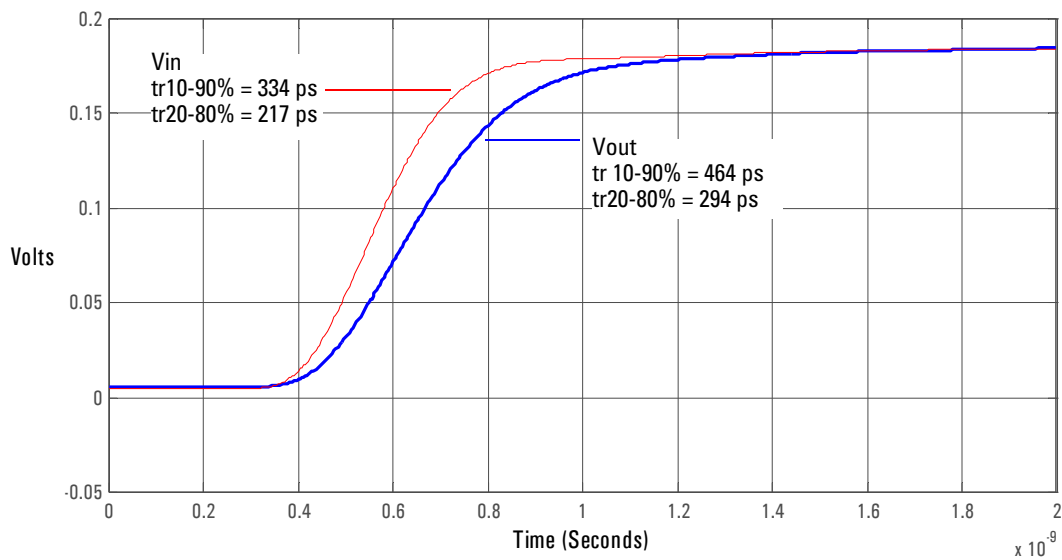

Graph of V_{in} and V_{out} of probe with a 25 Ω 295 ps step generator.

Figure 1-18

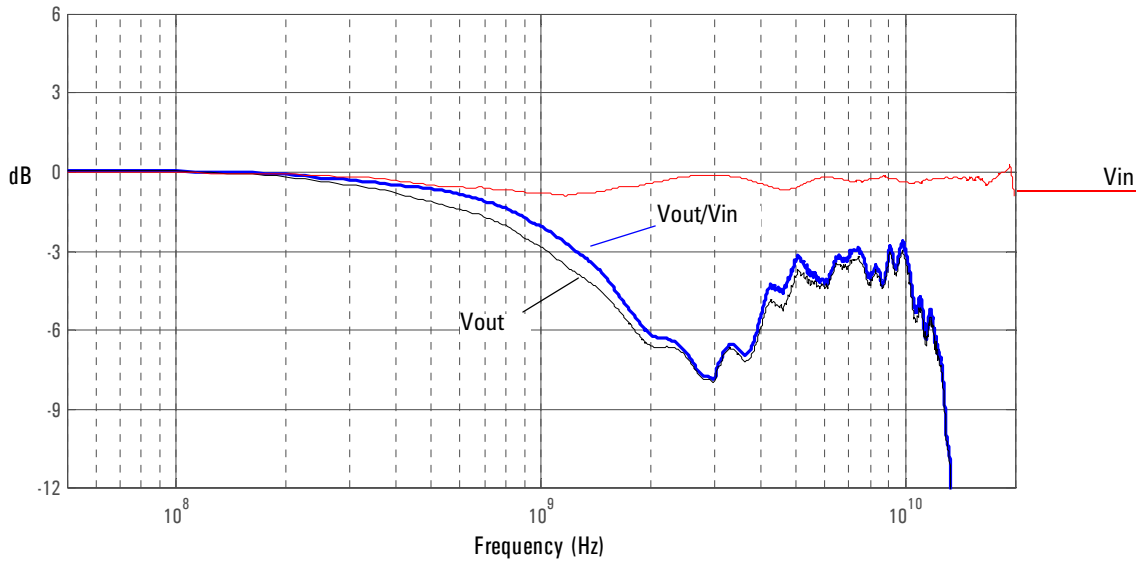

Graph of $\text{dB}(V_{in})$ and $\text{dB}(V_{out}) + 10.8 \text{ dB}$ of probe with a 25Ω source and $\text{dB}(V_{out}/V_{in}) + 10.8 \text{ dB}$ frequency response.

10 E2695A SMA Probe Head

Figure 1-19

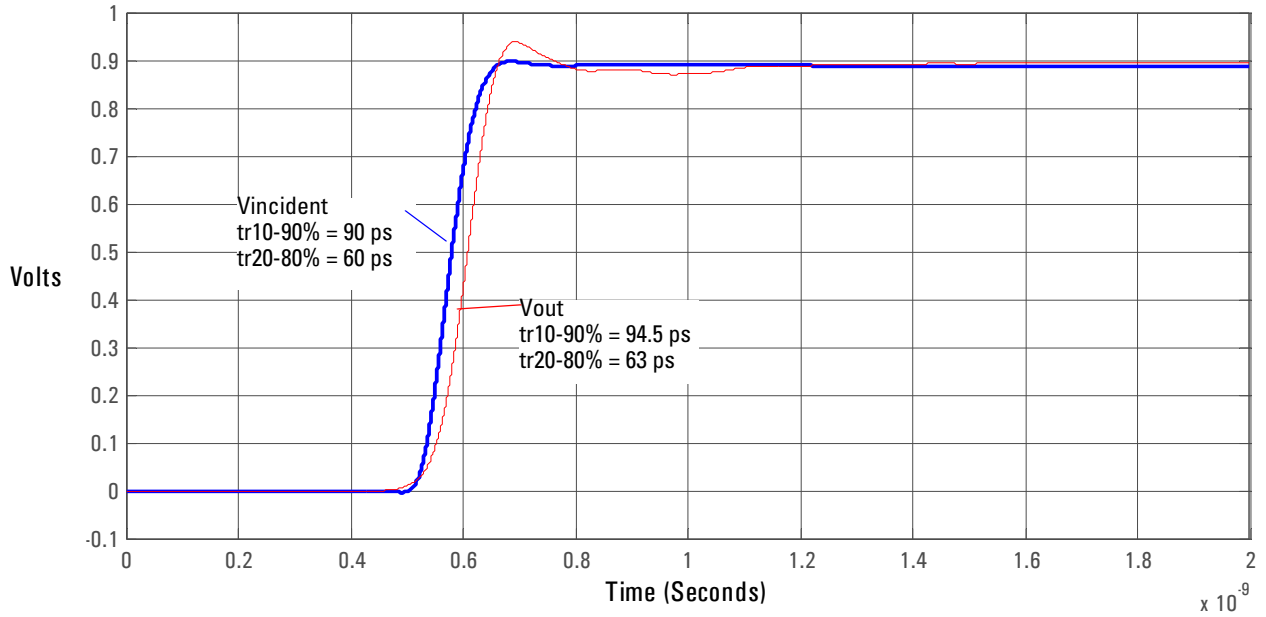

Graph of Vincident and Vout of probe with a 90 ps step.

Figure 1-20

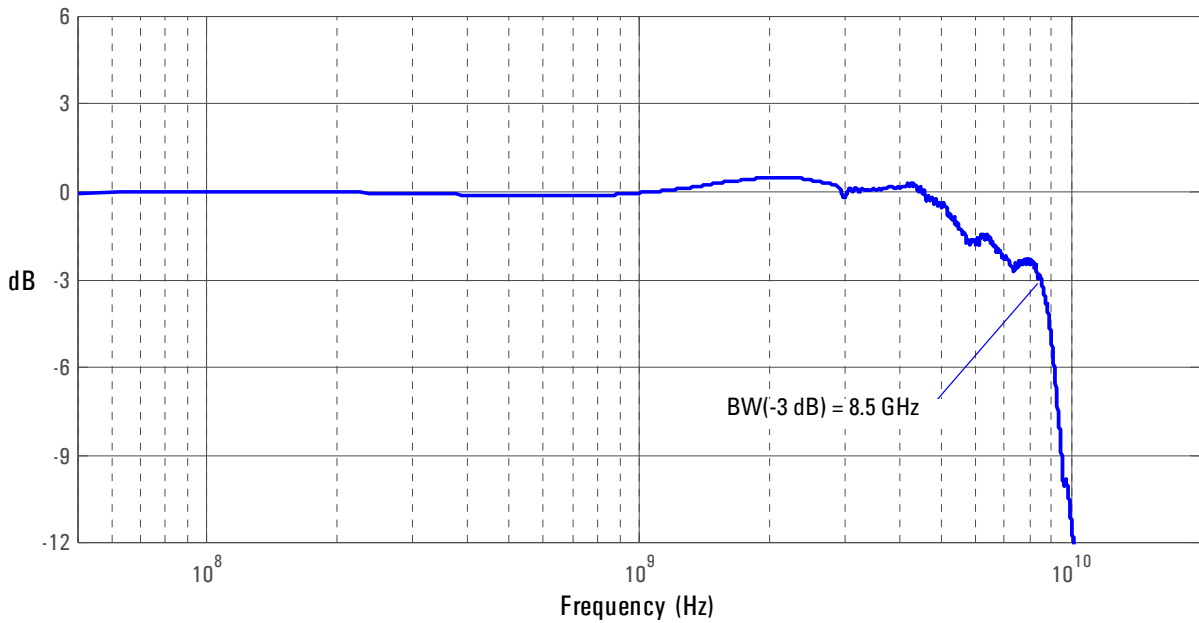

Magnitude response of differential insertion loss +1.03 dB.

N5380A SMA Probe Head with the 1134A InfiniiMax Probe

Figure 1-21

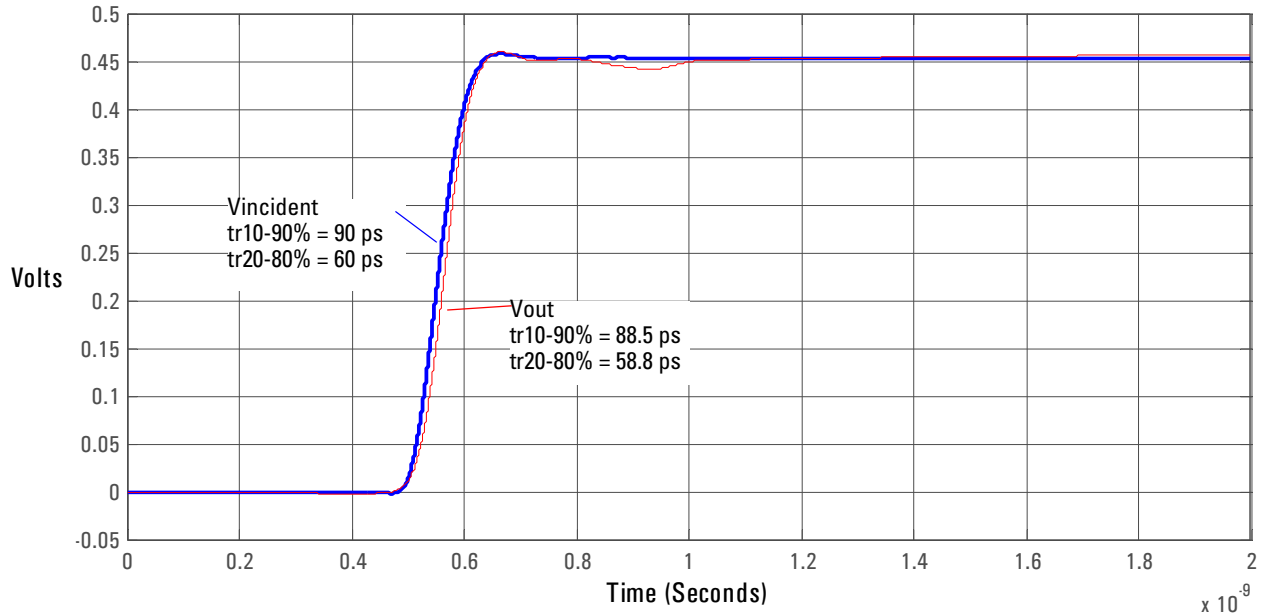

Graph of Vincident and Vout of probe with a 90 ps step.

Figure 1-22

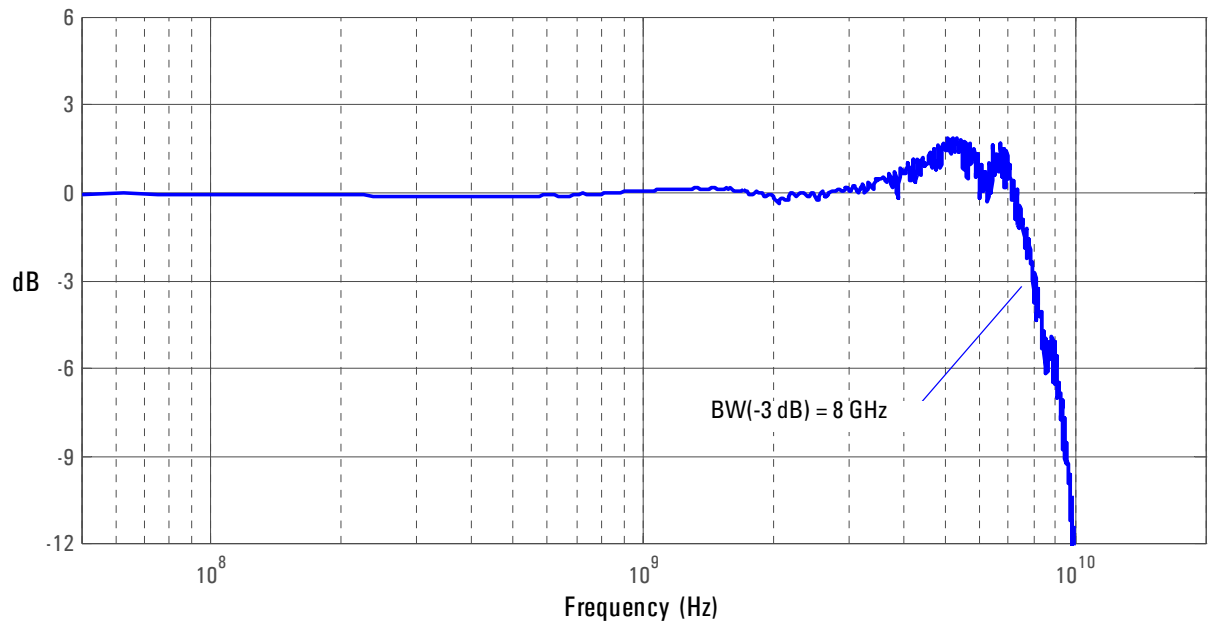

Magnitude response of differential insertion loss +16.03 dB.

N5381A Solder-in Differential Probe Head with 2 x Longer Wires

The following graph shows the probe response to a 25 Ω , 58 ps step generator with the recommended wire length, twice the recommended wire length with wires parallel to each other, and twice the recommended wire length with wires spread 90 degrees.

Figure 1-23

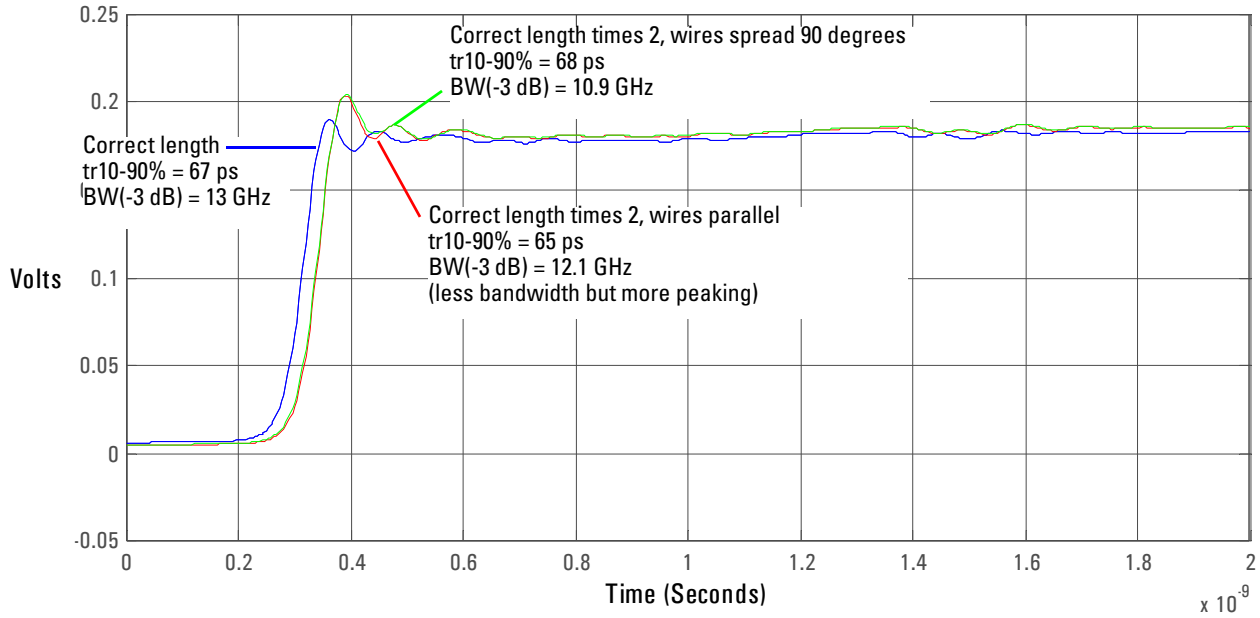

Service

Service

The service section of this manual contains the following information:

- Service Strategy for the 1169A probe
- Cleaning the 1169A probe
- Returning the 1169A probe to Agilent Technologies for service
- Recommended tools and test equipment
- Calibration Testing Procedures
 - To Test Bandwidth
 - To Test Input Resistance
- Performance test record
- Replaceable parts and accessories

Service Strategy for the 1169A Probe

This chapter provides service information for the 1169A Active Probe. The following sections are included in this chapter.

- Service strategy
- Returning to Agilent Technologies for service
- Troubleshooting
- Failure symptoms

The 1169A Active Probe is a high frequency device with many critical relationships between parts. For example, the frequency response of the amplifier on the hybrid is trimmed to match the output coaxial cable. As a result, to return the probe to optimum performance requires factory repair. If the probe is under warranty, normal warranty services apply.

Warranted specification are listed below.

Table 2-1

Description	Specification	Further Information
Bandwidth	12 GHz	
Input Resistance	50 k Ω \pm 2% 25 k Ω \pm 2%	Differential mode resistance Single-ended mode resistance each side to ground

You may perform the tests in the "Calibration and Operational Verification Tests" later in this chapter to ensure these specifications are met.

If the probe is found to be defective we recommend sending it to an authorized service center for all repair and calibration needs. Please see the "To return the probe to Agilent Technologies for service" on page 2-4.

To return the probe to Agilent Technologies for service

Follow the following steps before shipping the 1169A back to Agilent Technologies for service.

- 1 Contact your nearest Agilent sales office for information on obtaining an RMA number and return address.**
- 2 Write the following information on a tag and attach it to the malfunctioning equipment.**
 - Name and address of owner
 - Product model number Example 1169A
 - Product Serial Number Example MYXXXXXXXX
 - Description of failure or service required

Include probing and browsing tips if you feel the probe is not meeting performance specifications or a yearly calibration is requested.

- 3 Protect the 1169A Probe by wrapping in plastic or heavy paper.**
- 4 Pack the 1169A Probe in the original carrying case or if not available use bubble wrap or packing peanuts.**
- 5 Place securely in sealed shipping container and mark container as "FRAGILE".**

If any correspondence is required, refer to the product by serial number and model number.
--

Troubleshooting

- If your probe is under warranty and requires repair, return it to Agilent Technologies. Contact your nearest Agilent Technologies Service Center.
- If the failed probe is not under warranty, you may exchange it for a reconditioned probe. See "To Prepare the Probe for Exchange" in this chapter.

Failure Symptoms

The following symptoms may indicate a problem with the probe or the way it is used. Possible remedies and repair strategies are included.

The most important troubleshooting technique is to try different combinations of equipment so you can isolate the problem to a specific probe.

Probe Calibration Fails

Probe calibration failure with an oscilloscope is usually caused by improper setup. If the calibration will not pass, check the following:

- Check that the probe passes a waveform with the correct amplitude.
- If the probe is powered by the oscilloscope, check that the offset is approximately correct. The probe calibration cannot correct major failures.
- Be sure the oscilloscope passes calibration without the probe.
- Be sure that the probe head that you are using has been in the oscilloscope's Probe Setup dialog box.

Incorrect Pulse Response (flatness)

If the probe's pulse response shows a top that is not flat, check for the following:

- Output of probe must be terminated into a proper $50\ \Omega$ termination. If you are using the probe with an Infiniium oscilloscope, this should not be a problem. If you are using the probe with other test gear, insure the probe is terminated into a low reflectivity $50\ \Omega$ load ($\sim \pm 2\%$).
- If the coax or coaxes of the probe head in use has excessive damage, then reflections may be seen within $\sim 1\ \text{ns}$ of the input edge. If you suspect a probe head, swap it with another probe head and see if the non-flatness problem is fixed.
- If one of the components in the tip has been damaged, there may be a frequency gain non-flatness at around 40 MHz. If you suspect a probe head, swap it with another probe head and see if the non-flatness problem is fixed.

Incorrect Input Resistance

The input resistance is determined by the probe head in use. If the probe head is defective, damaged, or has been exposed to excessive voltage, the input resistor may be damaged. If this is the case, the probe head is no longer useful. A new probe head will need to be obtained either through purchase or warranty return.

Incorrect Offset

Assuming the probe head in use is properly functioning, incorrect offset may be caused by defect or damage to the probe amplifier or by lack of probe calibration with the oscilloscope.

Calibration Testing Procedures

These tests can be performed to ensure the 1169A Probe meets specifications.

To Test Bandwidth

This test ensures that the 1169A Probe meets its specified bandwidth.

1169A >12 GHz

Table 2-2

Equipment/Tool	Critical Specification	Model Number
Vector Network Analyzer (VNA)	13 GHz sweep range full 2 port cal Option 1D5	Agilent 8720ES
Calibration Standards	No Substitute	Agilent 85052D
External Power Supply	No Substitute	Agilent 1143A
AutoProbe Interface Adapter	No Substitute	Agilent N1022A
Outside thread 3.5 mm (male) to 3.5 mm (female) adapter	No Substitute	Agilent 5062-1247
Cable (2)	3.5 mil; SMA; High Quality	Agilent 8120-4948
Cable	1.5 mil Probe Power Extension No Substitute	Agilent 01143-61602
PV/DS Test Board	No Substitute (In E2655B Kit)	Agilent E2655-66503

Using the 8720ES VNA successfully

Remember these simple guidelines when working with the 8720ES VAN to get accurate stable measurements.

1 Sometimes it may take a few seconds for the waveforms to settle completely. Please allow time for waveforms to settle before continuing.

2 Make sure all connections are tight and secure. If needed, use a vice to hold the cables and test board stable while making measurements.

3 Be careful not to cross thread or force any connectors. This could be a very costly error to correct.

Initial Setup

- 1 Turn on the 8720ES VNA and let warm up for 20 minutes.
- 2 Press the green "Preset" key on the 8720ES VNA.
- 3 Use the 8720ES VNA's default power setting of 0 dBm. You can locate this feature by pressing the "Power" key on the front panel.
- 4 Set the 8720ES VNA's averaging to 4. You can find this selection menu by pressing the "AVG" key. Then select the "Averaging Factor" screen key to adjust the averaging.
- 5 Press the "Sweep Setup" key on the 8720ES VNA. Then press the "sweep type menu" screen key. Select the "log freq" screen key.
- 6 Connect the 1169A probe under test to the Auto Probe Adapter and power the probe using the 1143A power supply. Install the outside thread adapter to the Auto Probe Adapter.

Figure 2-1

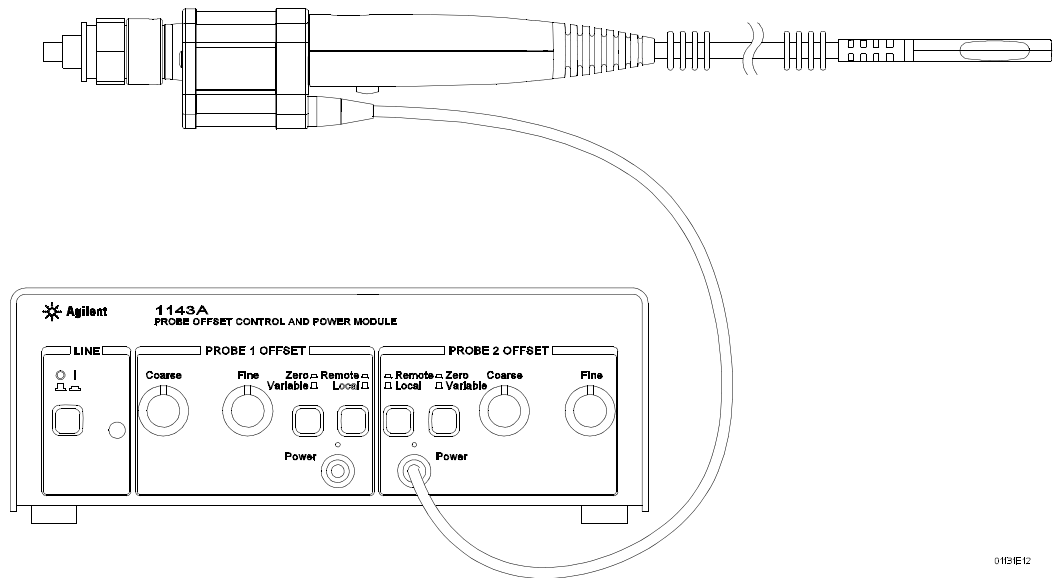

01B/E12

Calibrating a Reference Plane

To get a reliable measurement from the 8720ES VNA we must calibrate a reference plane so that the 8720ES VNA knows where the probe under test is located along the transmission line.

Service
To Test Bandwidth

- 1 Press the "Cal" key on the 8720ES VNA.

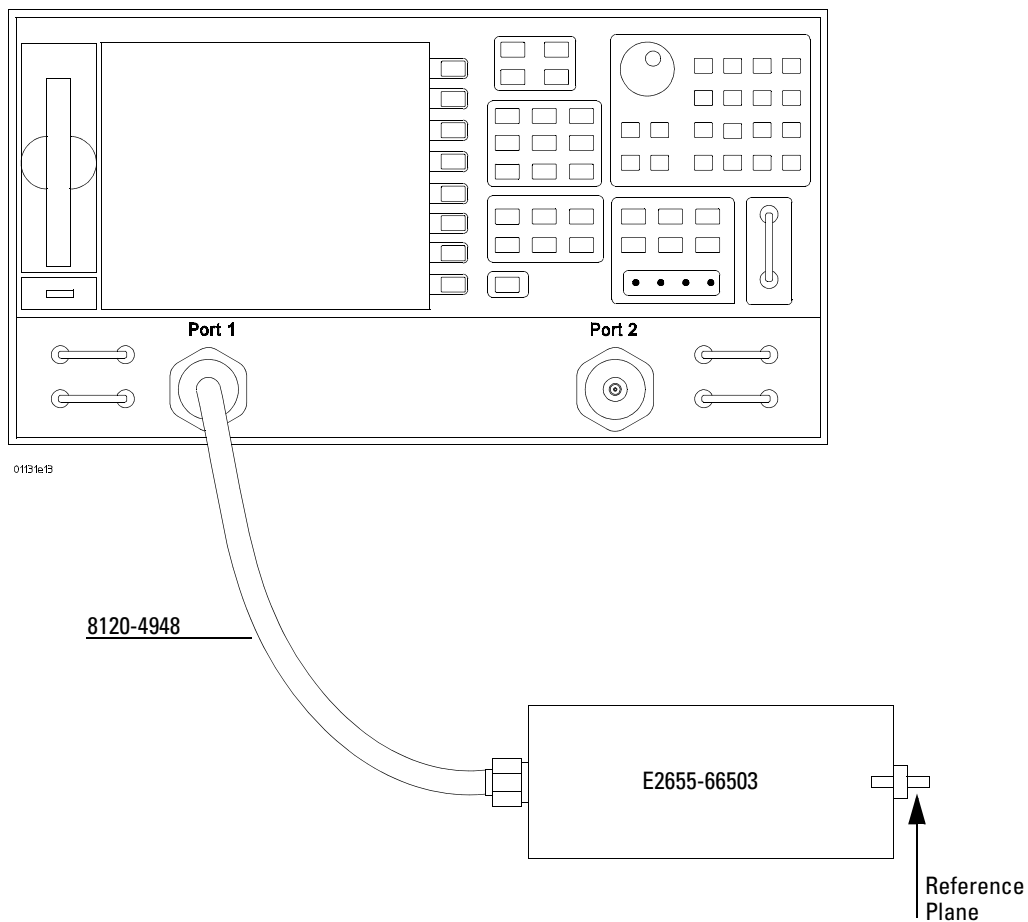

- 2 Then Press the "cal menu" screen key.
- 3 Finally, press the "full 2 port" screen key.
- 4 Connect one of the high quality SMA cables to port one and to the pincher side of PV/DS test board.
- 5 The calibration reference plane is at the other end of PV/DS test board.

Figure 2-2

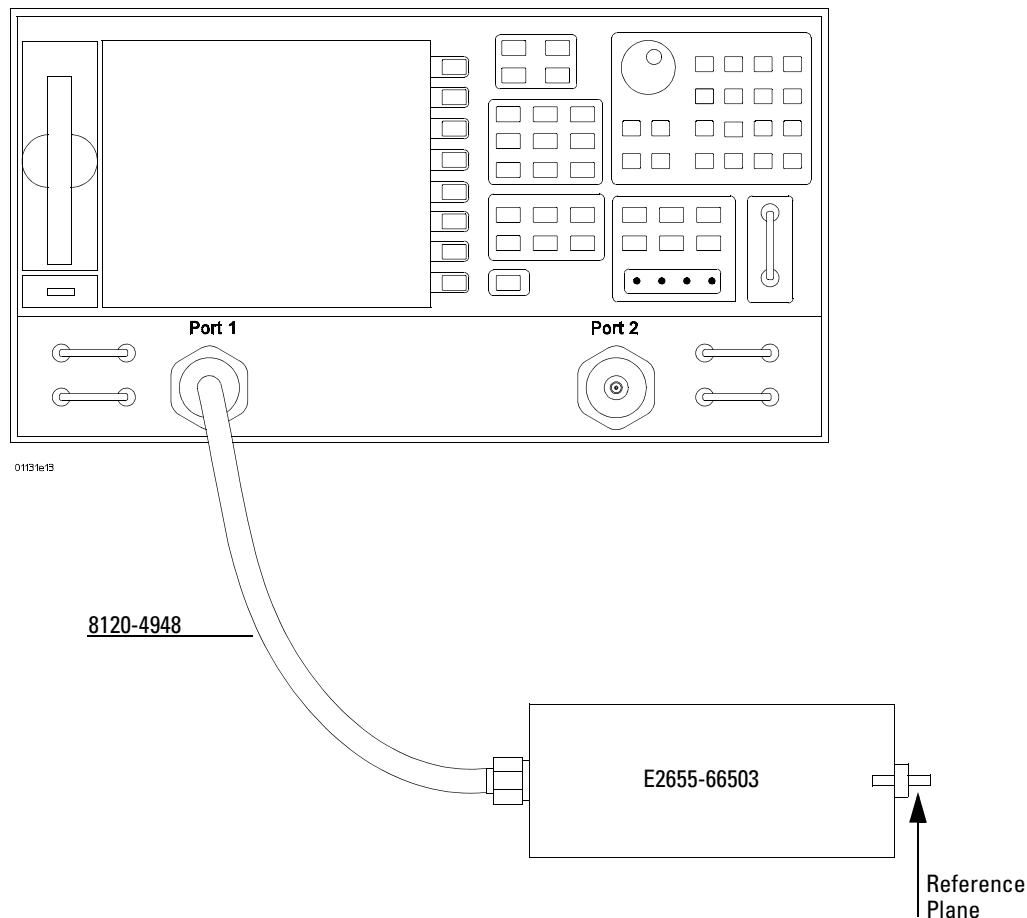

6 Perform Calibration for the port one side of the Reference plane.

- Press the "reflection" screen key
- Connect open end of 85052D to the non-pincher side of the PV/DS test board.
- Select the "open" screen key under the "Forward" group.
- The 8720ES VAN will beep when done.
- Connect short end of 85052D to the non-pincher side of the PV/DS test board.
- Select "short" screen key under the "Forward" group.
- The 8720ES VAN will beep when done.
- Connect load end of 85052D to the non-pincher side of the PV/DS test board.
- Select the "loads" screen key under the "Forward" group.
- Press "broadband" screen key selection.
- The 8720ES VAN will beep when done.
- Press the "done loads" screen key.
- You have just calibrated one side of the reference plane.

7 Connect the other high quality SMA cable to port two of the 8720ES VNA.

Figure 2-3

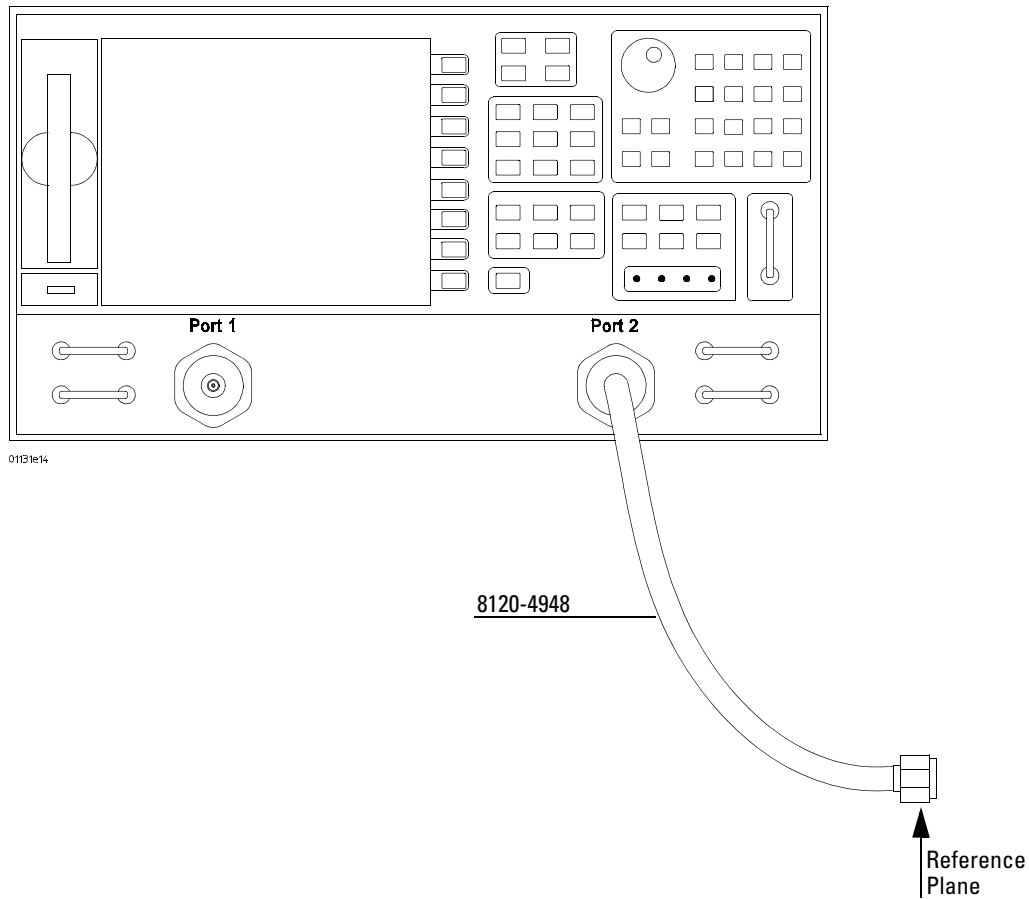

- 8 Get the opposite sex of the 85052D calibration standards for the next step.
- 9 Perform Calibration for the port two side of the Reference plane.
 - Press the "reflection" screen key.
 - Connect open end of 85052D to the available end of the port two SMA cable.
 - Select the "open" screen key under the "Reverse" group.
 - The 8720ES VNA will beep when done.
 - Connect short end of 85052D to the available end of the port two SMA cable.
 - Select "short" screen key the "Reverse" group.
 - The 8720ES VNA will beep when done.
 - Connect load end of 85052D to the available end of the port two SMA cable.
 - Select the "loads" screen key the "Reverse" group.
 - Press "broadband" screen key selection.
 - The 8720ES VNA will beep when done.
 - Press the "done loads" screen key.
 - You have just calibrated the other side of the reference plane.
- 10 Press "standards done" key.
- 11 Connect port two SMA cable to the non-pincher side of PV/DS test board.

Figure 2-4

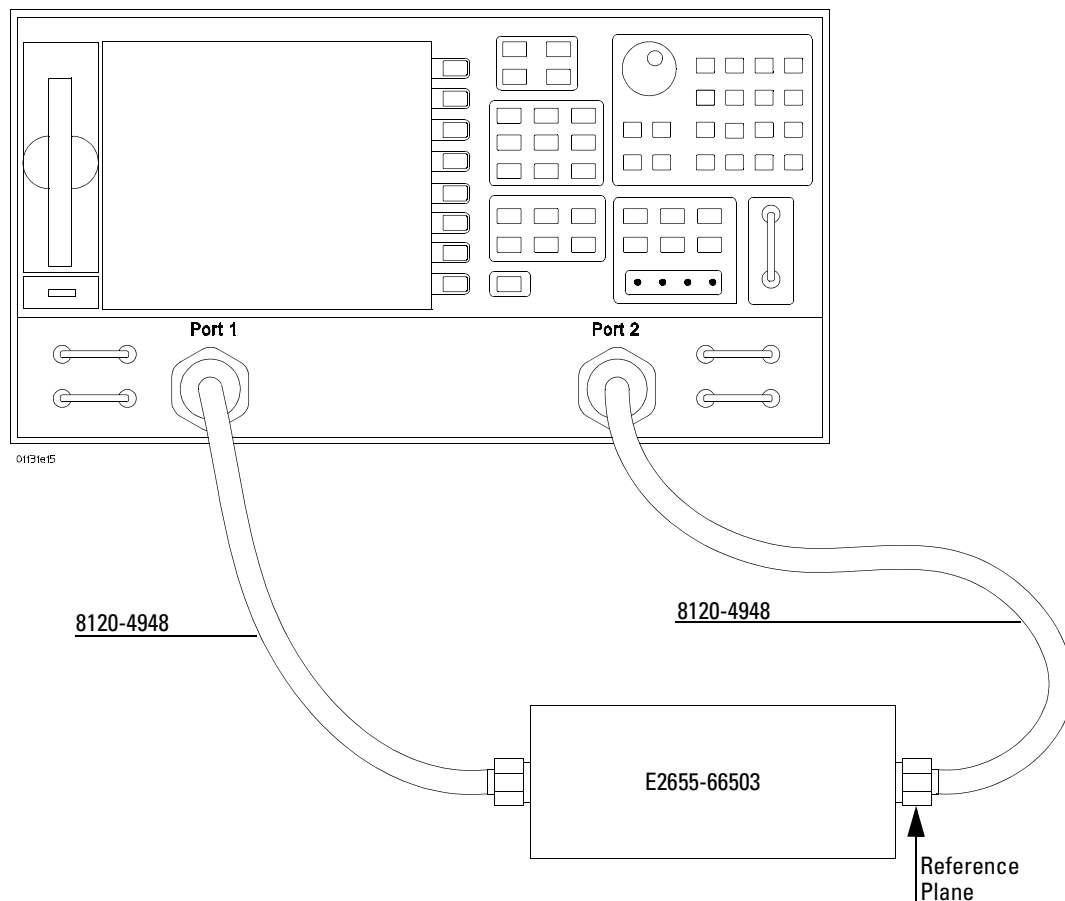

- 12 Press the "transmission" screen key.
- 13 Press the "do both fwd and reverse" screen key.
- 14 The 8720ES VNA will beep **four** times when done.
- 15 Press the "isolation" screen key.
- 16 Press the "omit isolation" screen key.
- 17 Press "done 2 port cal" screen key.
- 18 Set the 8720ES VNA's averaging to off.
- 19 Save the reference plane cal by pressing the "save recall" key then the "save state" key.
- 20 You may change name if you wish.
- 21 Press the "scale reference" key. Then
 - Set for 1 dB per division.
 - Set reference position for 7 divisions.
 - Set reference value for 0 dB
- 22 Press the "measure" key.
- 23 Press the "s21" screen key.
- 24 Ensure s21 response on screen is flat (about ± 0.1 dB) out to 13 GHz.

Measuring Vin Response

- 1 Position 1169A probe conveniently to allow the probe tip to be normal to the PV/DS board. See Figure 2-5.
- 2 Spread the probe tip wires slightly so that the tips are a little bit wider than the gap between the signal trace and the ground on PV/DS board
- 3 To best simulate the conditions that are present when the probe is in actual use, inset only the tips of the wires under the pincher. Do not inset the wires completely under the pincher such that the contact points are right next to the tip of the PC board. The best way to accomplish this is to insert the wires under the pincher with the probe head at a 45 degree angle with respect to the PV/DS board, then apply upward pressure to the clip to hold the tip wires firmly. Gently pull the probe head up to the 90 degree position. This will actually form the wires into an "L" shape.

Place the "+" side on center conductor and "-" side to ground.

Press the "Sweep Setup" key on the 8720ES VNA. Then press the "trigger menu" screen key. Select the "continuous" screen key.

Figure 2-5

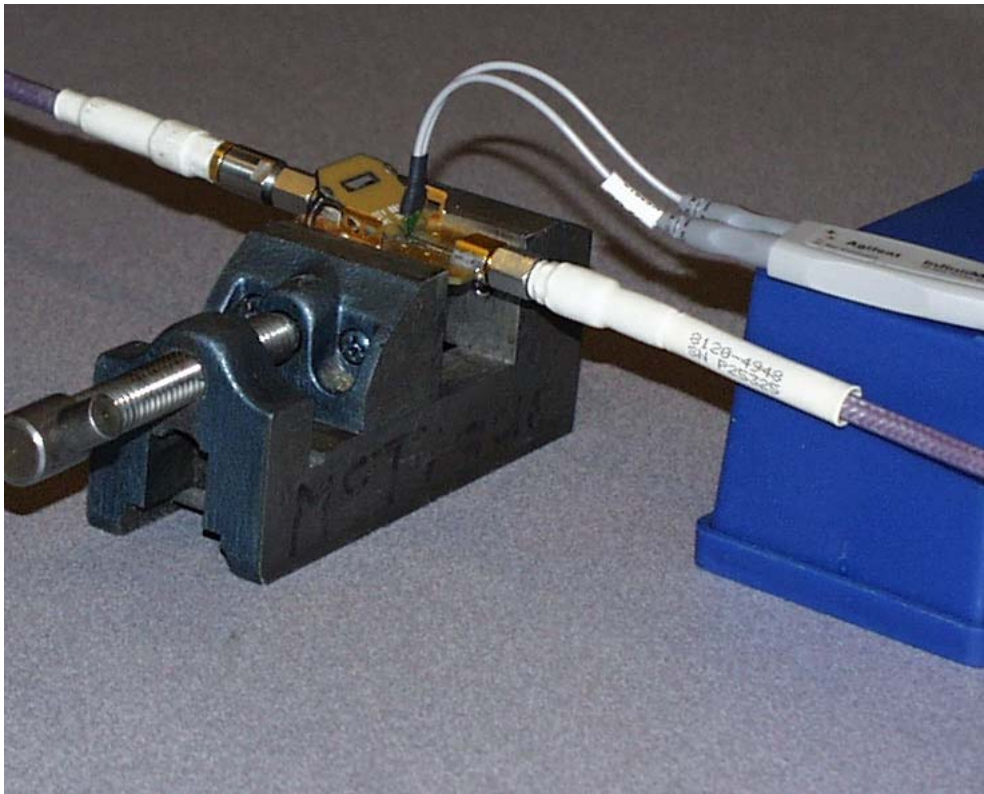

- 4 You should now have the Vin waveform on screen. It should look similar to Figure 2-6.

Figure 2-6

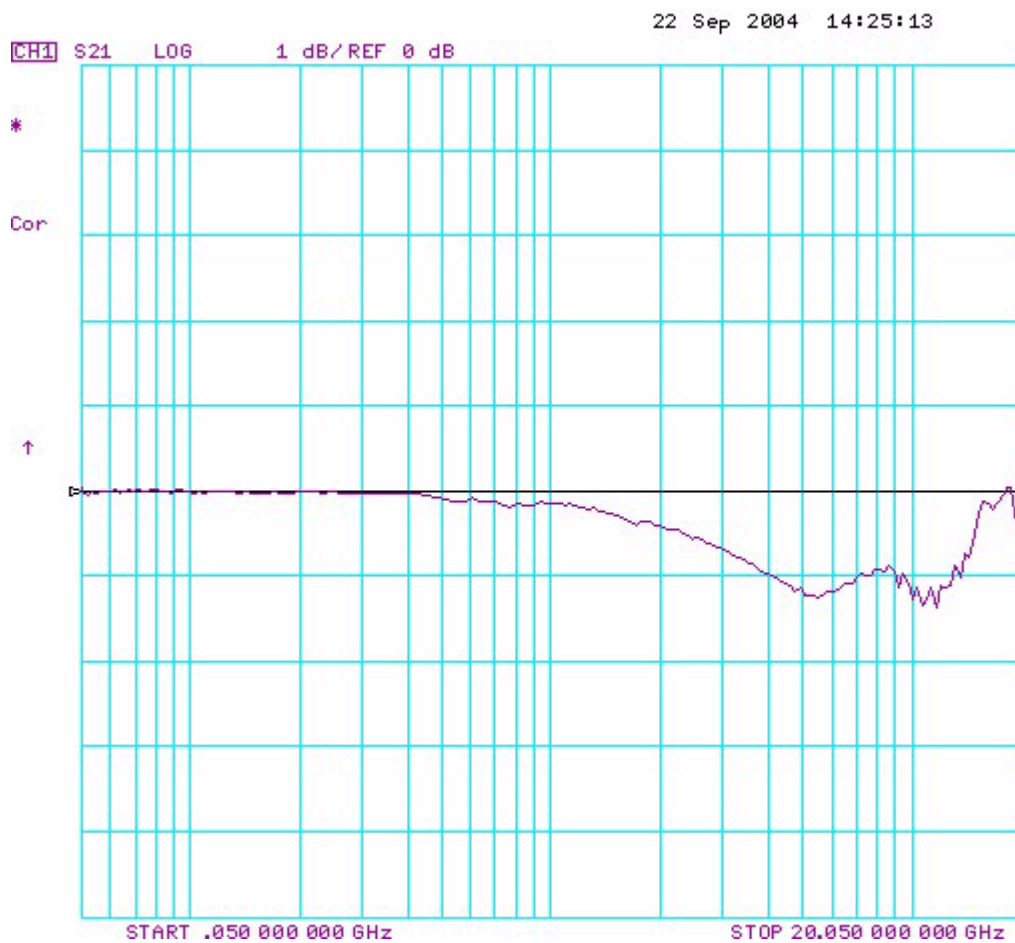

- 5 Select "display key" then "data->memory" screen key.
- 6 You have now saved Vin waveform into the 8720ES VNA's memory for future use.

Service
To Test Bandwidth

Measuring Vout Response

- 1 Disconnect the port 2 cable from PV/DS test board and attach to probe output on the AutoProbe Adapter.
- 2 Connect the 85052D cal standard load to PV/DS test board (non-pincher side). See Figure 2-7.
- 3 Check that the tip connection is still proper. See "Measuring Vin Response" on page 2-14

Figure 2-7



- 4 Press "scale reference" key on the 8720ES VNA.
- 5 Set reference value to -10.8 dB.
- 6 The display on screen is Vout. It should look similar to Figure 2-8.

Figure 2-8

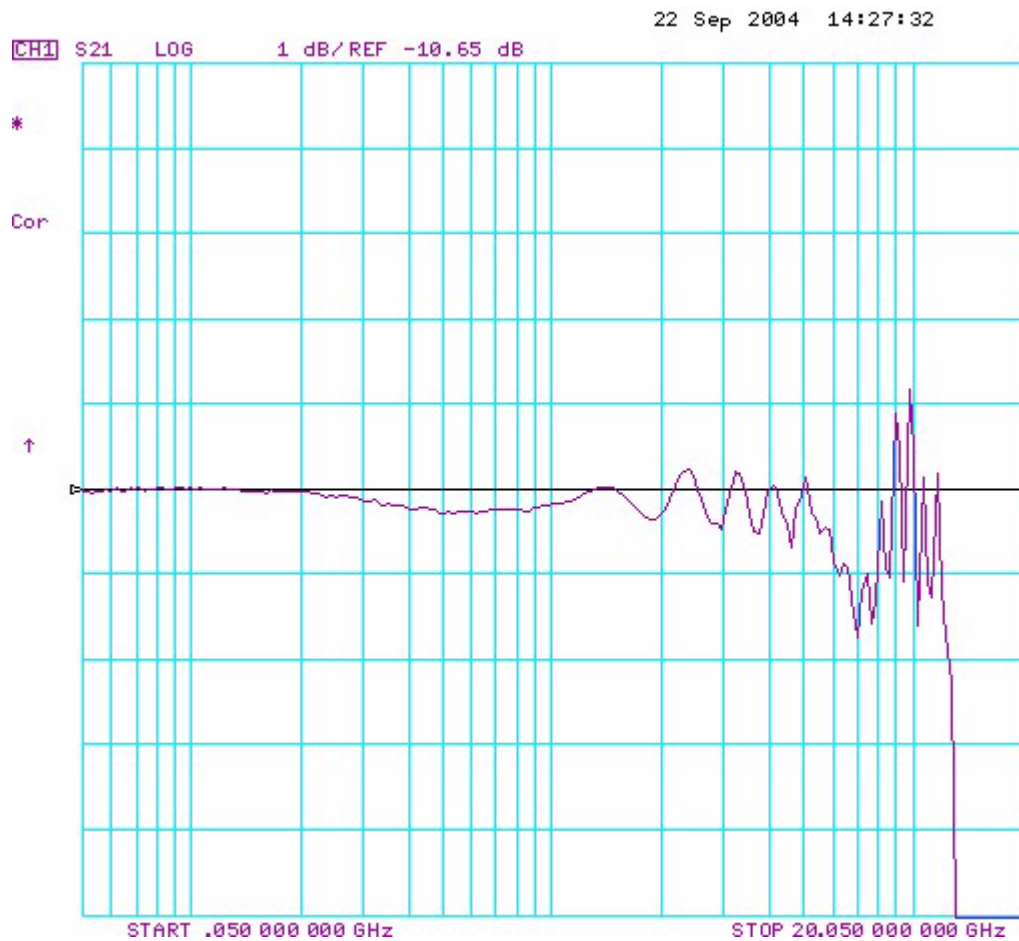

Displaying Vin/Vout Response on 8720ES VNA Screen

- 1 Press the "Display" Key.
- 2 Then select the "Data/Memory" Screen Key. The display should look similar to Figure 2-9. You may need to adjust the "Reference Value", located under the "Scale Ref" key, slightly to position the waveform at center screen at 100 MHz.
- 3 Press marker key and position the marker to the first point that the signal is -2.6 dB below center screen. Minus 2.6 dB is used rather than -3 dB because the loss caused by the PV/DS board makes a slightly optimistic measurement.
- 4 Read marker frequency measurement and record it in the test record located later in this chapter.
- 5 The bandwidth test passes if the frequency measurement is greater than the probe's bandwidth limit. Example: > 12 GHz.

Service
To Test Bandwidth

Figure 2-9

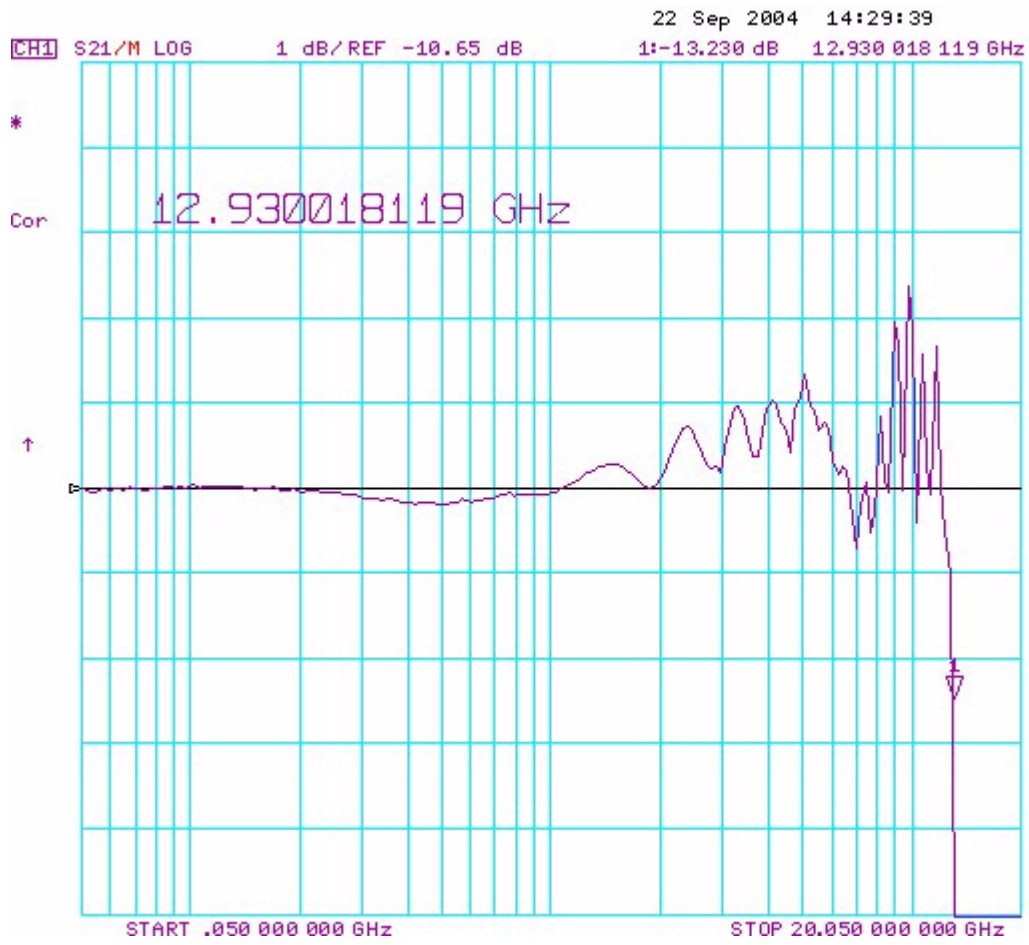

To Test Input Resistance

This test ensures that the 1169A Probe meets its specified input resistance.

Differential Mode	50 k Ω \pm 2%
Single-ended Mode	25 k Ω \pm 2%

Table 2-10

Equipment/Tool	Critical Specification	Model Number
Oscilloscope	No substitute. Requires precision BNC connectors	DSO80000 Series Infiniium Oscilloscope
Digital Multimeter	2 wire resistance accuracy better than \pm 0.01%	34401A
Adapter	BNC (f) to SMA(m) (In E2655B Kit)	E2655-83201
PV/DS Test Board	No Substitute (In E2655B Kit)	E2655-66503

Initial Setup

- 1 Power on the Infiniium oscilloscope and 34401A DMM.
- 2 Connect the 1169A probe under test to Channel 1 of the Infiniium oscilloscope.
- 3 Select the 2-wire Ohm display on the 34401A DMM.

Service
To Test Input Resistance

Differential Test

- 1 Using the PV/DS test board, connect the 1169A "+" and "-" probe tips to the 34401A DMM.

Apply upward pressure to the clip to insure proper electrical connection.

Figure 2-11

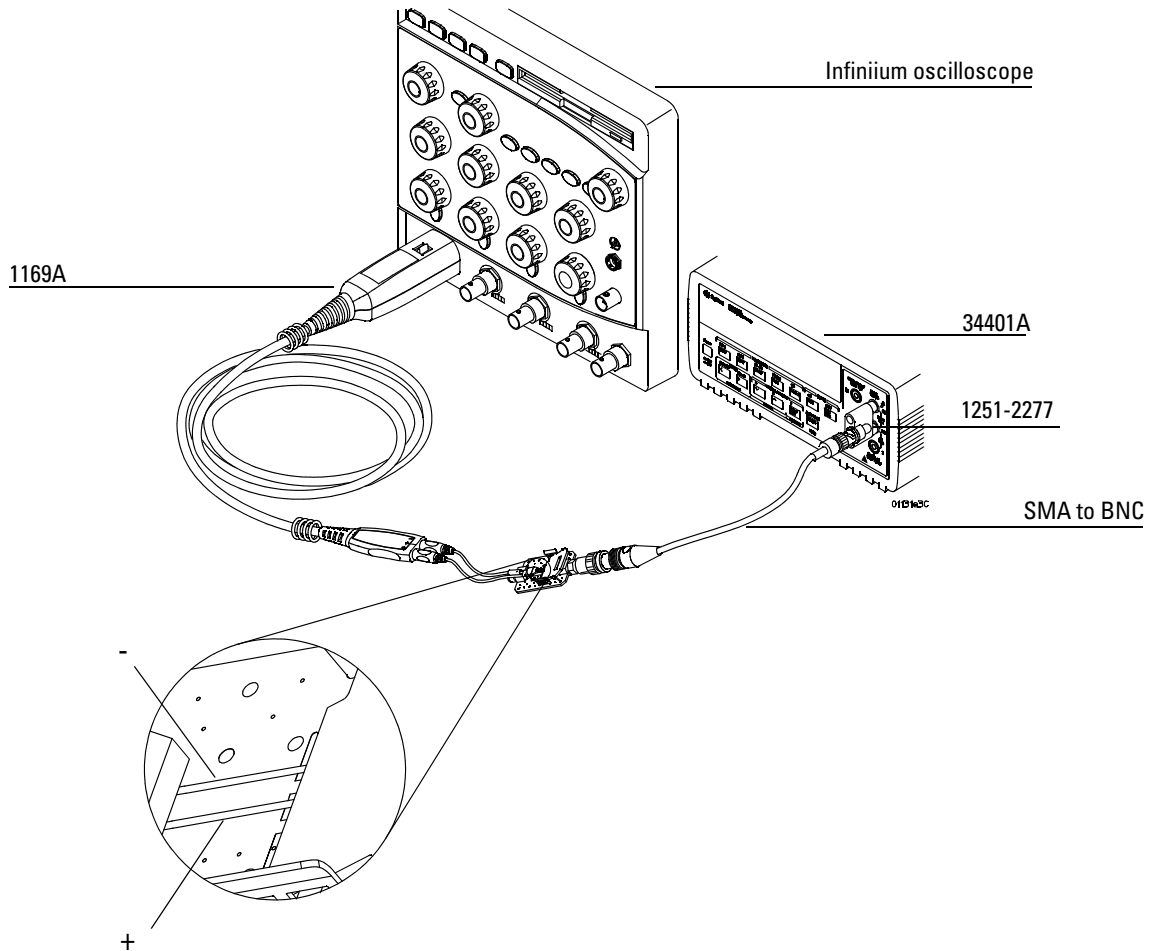

- 2 Read the 34401A display for the Input Resistance.
- 3 Record the result in the performance test record later in this chapter. To pass this test the result should be between 49,000 Ω and 51,000 Ω .

Single-ended Test

- 1 Using the PV/DS test board, connect the "+" probe trip to the 34401A DMM.

Apply upward pressure to the clip to insure proper electrical connection.

- 2 Connect the amp body ground to the PV/DS test board ground.

Figure 2-12

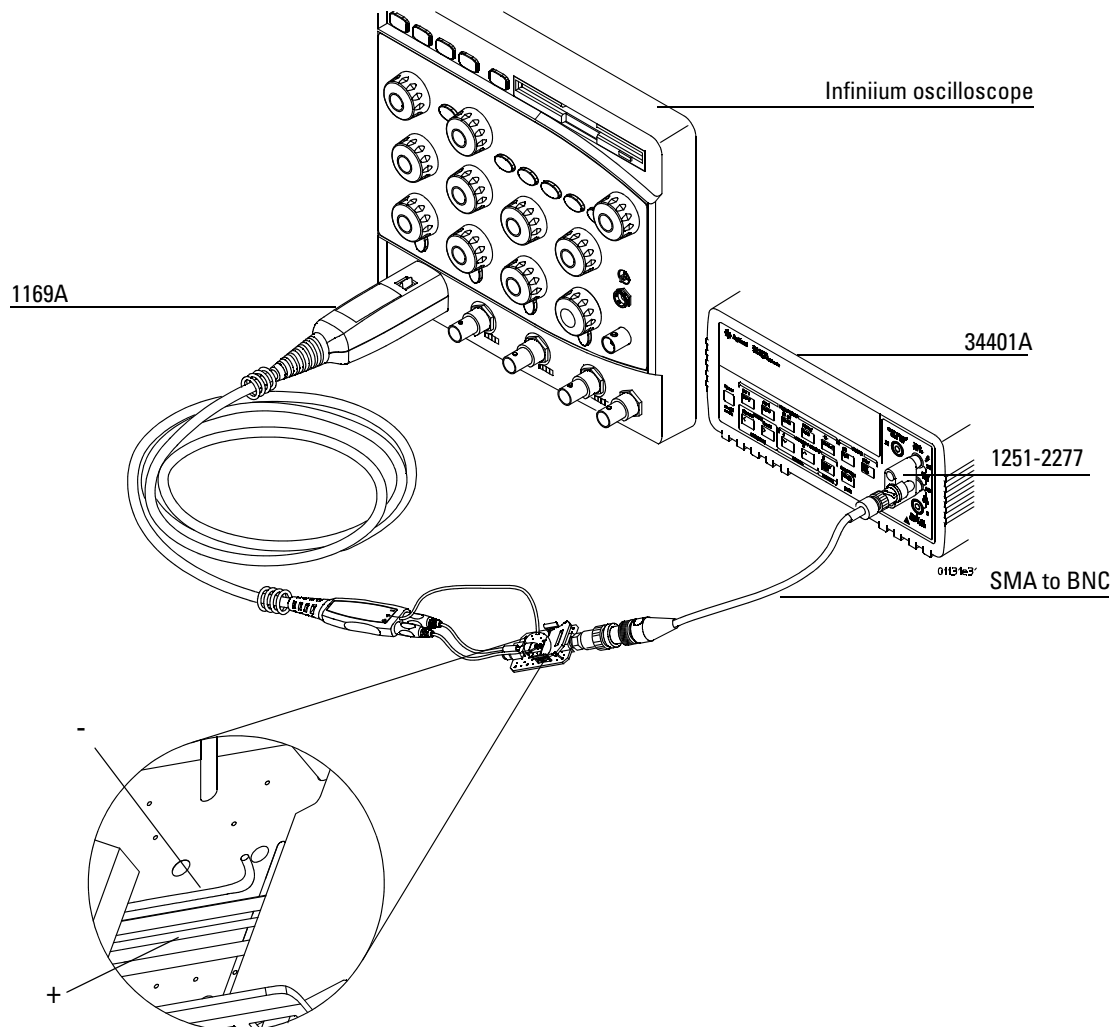

- 3 Read the 34401A display for the Input Resistance.
- 4 Record the result in the performance test record later in this chapter. To pass this test the result should be between 24,500 Ω and 25,500 Ω .

Service
To Test Input Resistance

- Using the PV/DS test board, connect the "-" probe tip to the 34401A DMM.

Apply upward pressure to the clip to insure proper electrical connection.

- Connect the amp body to ground on the PV/DS test board.

Figure 2-13

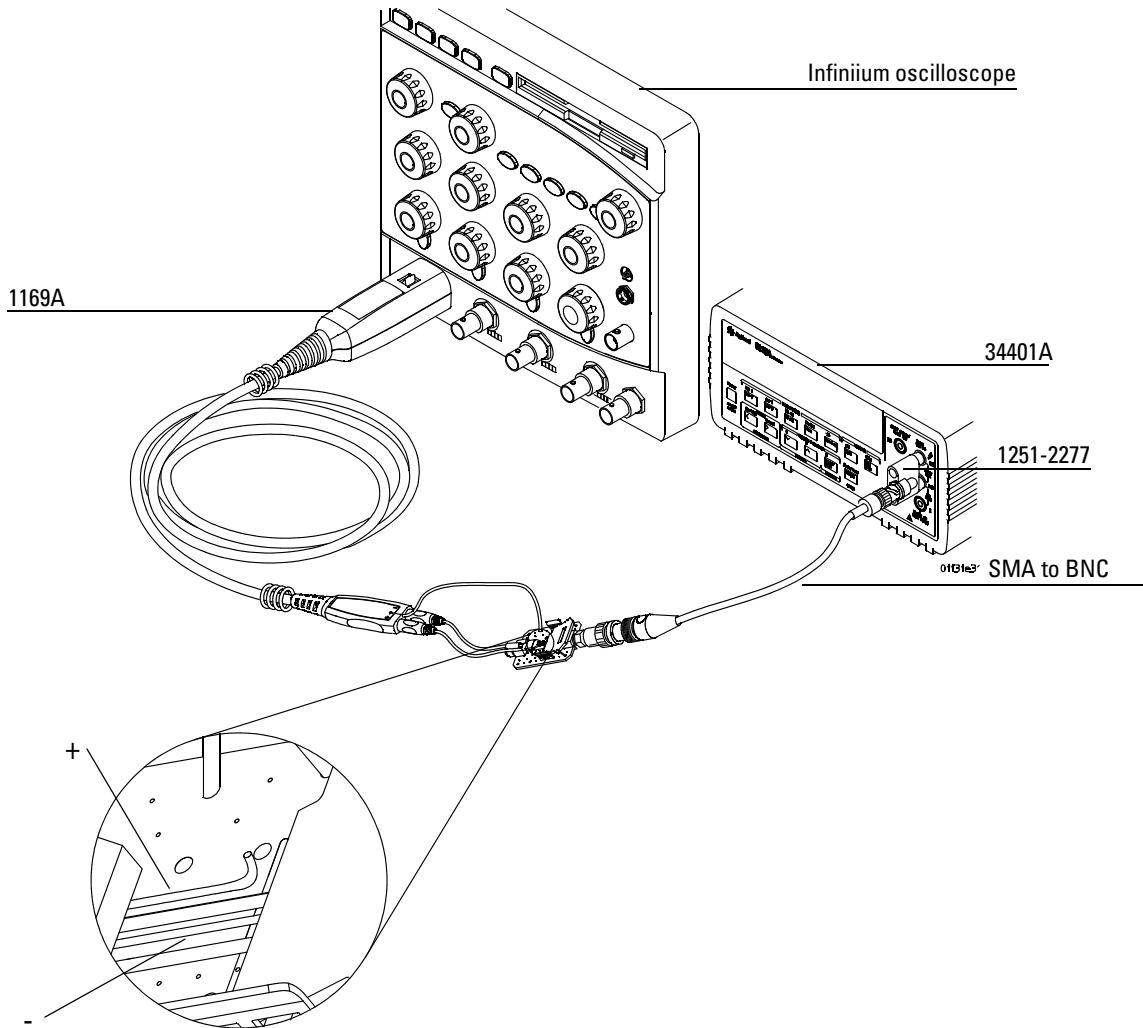

- Read the 34401A display for the Input Resistance.
- Record the result in the performance test record later in this chapter. To pass this test the result should be between $24,500 \Omega$ and $25,500 \Omega$.

A recommended grounding solution is to use the probe body ground.

Performance Test Record

Test Name	Results	
Bandwidth	>12 GHz Result _____ GHz	Pass/Fail
Input Resistance	Differential Mode Limits: 49,000 Ω to 51,000 Ω \pm _____ k Ω	Pass/Fail
	Single-ended Mode Limits: 24,500 Ω to 25,500 Ω + _____ k Ω - _____ k Ω	Pass/Fail

Replaceable Parts and Accessories

See the "User's Quick Start Guide" for a list of replaceable parts and accessories.

Index

B

bandwidth test 2-8

C

calibration

failure 2-6

calibration procedure 2-7

cleaning the instrument 1-3

F

failure symptoms 2-6

I

instrument, cleaning the 1-3

P

packing for return 2-4

parts

replaceable 2-24

R

repair 2-4

replacement parts 2-24

resistance testing 2-19

returning probe to Agilent Technologies 2-4

S

service

strategy 2-3

specifications

warrantied 2-3

T

test

bandwidth 2-8

testing

input resistance 2-19

troubleshooting 2-5

Safety Notices

This apparatus has been designed and tested in accordance with IEC Publication 1010, Safety Requirements for Measuring Apparatus, and has been supplied in a safe condition. This is a Safety Class I instrument (provided with terminal for protective earthing). Before applying power, verify that the correct safety precautions are taken (see the following warnings). In addition, note the external markings on the instrument that are described under "Safety Symbols."

Warnings

- Before turning on the instrument, you must connect the protective earth terminal of the instrument to the protective conductor of the (mains) power cord. The mains plug shall only be inserted in a socket outlet provided with a protective earth contact. You must not negate the protective action by using an extension cord (power cable) without a protective conductor (grounding). Grounding one conductor of a two-conductor outlet is not sufficient protection.
- Only fuses with the required rated current, voltage, and specified type (normal blow, time delay, etc.) should be used. Do not use repaired fuses or short-circuited fuseholders. To do so could cause a shock or fire hazard.
- If you energize this instrument by an auto transformer (for voltage reduction or mains isolation), the common terminal must be connected to the earth terminal of the power source.
- Whenever it is likely that the

ground protection is impaired, you must make the instrument inoperative and secure it against any unintended operation.

- Service instructions are for trained service personnel. To avoid dangerous electric shock, do not perform any service unless qualified to do so. Do not attempt internal service or adjustment unless another person, capable of rendering first aid and resuscitation, is present.

- Do not install substitute parts or perform any unauthorized modification to the instrument.

- Capacitors inside the instrument may retain a charge even if the instrument is disconnected from its source of supply.

- Do not operate the instrument in the presence of flammable gasses or fumes. Operation of any electrical instrument in such an environment constitutes a definite safety hazard.

- Do not use the instrument in a manner not specified by the manufacturer.

To clean the instrument

If the instrument requires cleaning: (1) Remove power from the instrument. (2) Clean the external surfaces of the instrument with a soft cloth dampened with a mixture of mild detergent and water. (3) Make sure that the instrument is completely dry before reconnecting it to a power source.

Safety Symbols



Instruction manual symbol: the product is marked with this symbol when it is necessary for you to refer to the instruction manual in order to protect against damage to the product..



Hazardous voltage symbol.



Earth terminal symbol: Used to indicate a circuit common connected to grounded chassis.

Notices

© Agilent Technologies, Inc. 2004-2005

No part of this manual may be reproduced in any form or by any means (including electronic storage and retrieval or translation into a foreign language) without prior agreement and written consent from Agilent Technologies, Inc. as governed by United States and international copyright laws.

Manual Part Number

01169-97003, September 2005

Print History

01169-97000, October 2004
01169-97003, September 2005

Agilent Technologies, Inc.
1900 Garden of the Gods Road
Colorado Springs, CO 80907 USA

Restricted Rights Legend

If software is for use in the performance of a U.S. Government prime contract or subcontract, Software is delivered and licensed as "Commercial computer software" as defined in DFAR 252.227-7014 (June 1995), or as a "commercial item" as defined in FAR 2.101(a) or as "Restricted computer software" as defined in FAR 52.227-19 (June 1987) or any equivalent agency regulation or contract clause. Use, duplication or disclosure of Software is subject to Agilent Technologies' standard commercial license terms, and non-DOD Departments and Agencies of the U.S. Government will receive no greater than Restricted Rights as defined in FAR 52.227-19(c)(1-2) (June 1987). U.S. Government users will receive no greater than Limited Rights as defined in FAR 52.227-14 (June 1987) or DFAR 252.227-7015 (b)(2)

(November 1995), as applicable in any technical data.

Document Warranty

The material contained in this document is provided "as is," and is subject to being changed, without notice, in future editions. Further, to the maximum extent permitted by applicable law, Agilent disclaims all warranties, either express or implied, with regard to this manual and any information contained herein, including but not limited to the implied warranties of merchantability and fitness for a particular purpose. Agilent shall not be liable for errors or for incidental or consequential damages in connection with the furnishing, use, or performance of this document or of any information contained herein. Should Agilent and the user have a separate written agreement with warranty terms covering the material in this document that conflict with these terms, the warranty terms in the separate agreement shall control.

Technology Licenses

The hardware and/or software described in this document are furnished under a license and may be used or copied only in accordance with the terms of such license.

WARNING

A WARNING notice denotes a hazard. It calls attention to an operating procedure, practice, or the like that, if not correctly performed or adhered to, could result in personal injury or death. Do not proceed beyond a WARNING notice until the indicated conditions are fully understood and met.

CAUTION

A CAUTION notice denotes a hazard. It calls attention to an operating procedure, practice, or the like that, if not correctly performed or adhered to, could result in damage to the product or loss of important data. Do not proceed beyond a CAUTION notice until the indicated conditions are fully understood and met.