

# **USER'S GUIDE**

**Model: 100HVT-A**

**Part Number: CS14-1486**



**HIPOTRONICS**<sup>®</sup>  
THE MEASURE OF A LEADER



**ROBINSON  
INSTRUMENTS**



**WARNING!** This publication describes a product engineered and designed to measure or operate with **HIGH VOLTAGES**. Accordingly, maximum safeguards have been built into the equipment and the best safety techniques possible are described in the unit's operating instructions. These instructions caution the user to exercise great care when using certain controls at appropriate points in the operating procedures. In addition to following these written warnings, the operator of this equipment is strongly advised to maintain safety consciousness. The following rules are particularly relevant and must be followed at all times.

- ◇ GROUND THE SYSTEM BEFORE CONNECTING INPUT POWER
- ◇ DISCONNECT POWER BEFORE UN-GROUNDING THE SYSTEM
- ◇ NEVER APPROACH OR TOUCH A POTENTIALLY LIVE HIGH VOLTAGE CIRCUIT WITHOUT SOLIDLY CONNECTING AN APPROPRIATE GROUND CONDUCTOR FIRST.

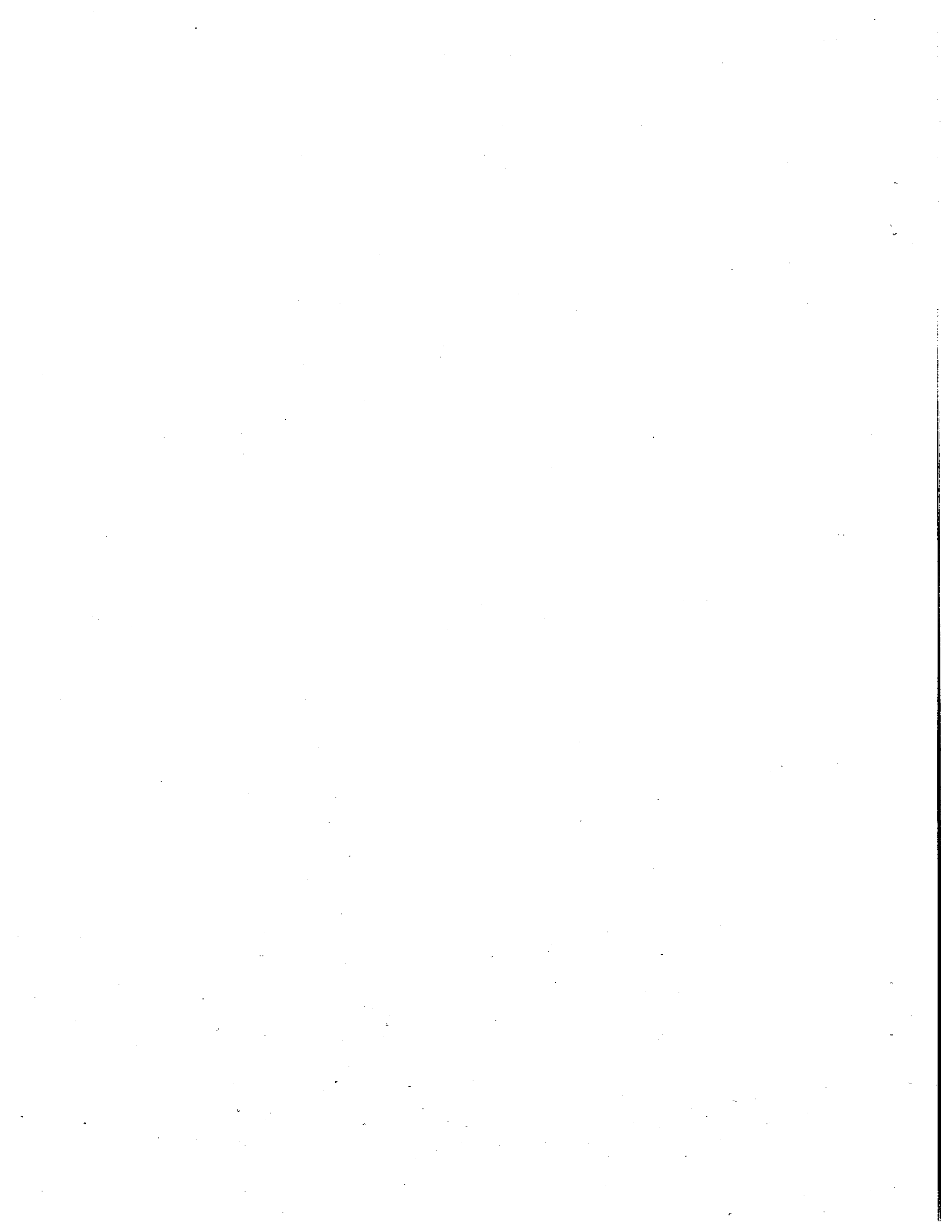

## Table of Contents

---

About the User's Guide .....	1
General Information.....	2
Features and Specifications.....	2
Controls and Indicators .....	3
Main Power Circuit Breaker .....	3
Overload Circuit Breaker .....	3
External Interlock Provision .....	4
Output Selector .....	4
High Voltage ON and OFF .....	4
Raise Voltage Control.....	4
Output Voltmeter and Controls.....	4
Output Current Meter and Controls .....	4
Guard Circuit .....	5
Setting Up the Equipment.....	7
Operating the Equipment .....	8
Performing Special Operations .....	12
Meter Recalibration .....	12
Recalibrating the Current Meter .....	12
Recalibrating the Voltmeter .....	13
Performing Maintenance.....	13
Cleaning the Equipment Surfaces .....	13
Maintaining the Transformer Oil .....	14
Cleaning the Meter Faces.....	14

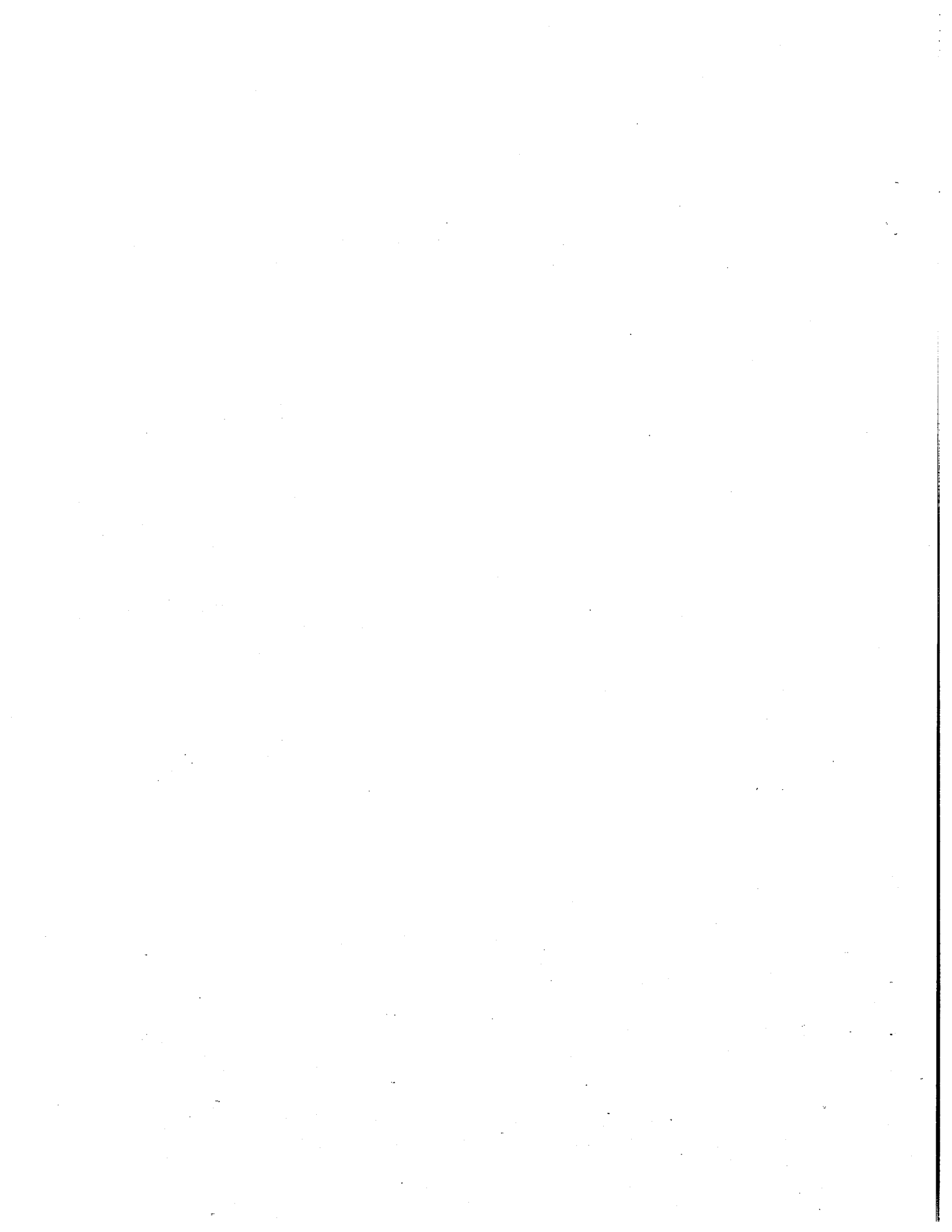

## About the User's Guide

---

This user's guide describes functions and features of the HIPOTRONICS Model 100 HVT (High Voltage Insulation Test Set). It is intended to provide a simplified reference for users of this equipment, allowing the quick, safe, and efficient use of the unit's features.

Specific information for the model purchased includes a diagram of the front panel, a parts list, and a schematic diagram.

### Before You Begin

It is assumed that the user has a basic understanding of electrical equipment and the functions to be performed by this unit. *Only trained, qualified personnel should operate this equipment.*

### Organization of this User's Guide

This user's guide is divided into four major sections, including:

- **General Information**, which discusses the features and specifications of the HIPOTRONICS High Voltage Insulation Test Set, and provides a description of the functions performed by each of the controls and indicators on the front panel.
- **Setting Up the Equipment**, which provides instructions for preparing the unit for test operations.
- **Operating the Equipment**, which provides instructions for performing test operations.
- **Performing Special Operations**, which provides procedures for recalibrating the unit and performing maintenance.

### Related Publications

The functions, features, and specifications of HIPOTRONICS' High Voltage Insulation Test Sets are discussed in the HIPOTRONICS Product Catalog.

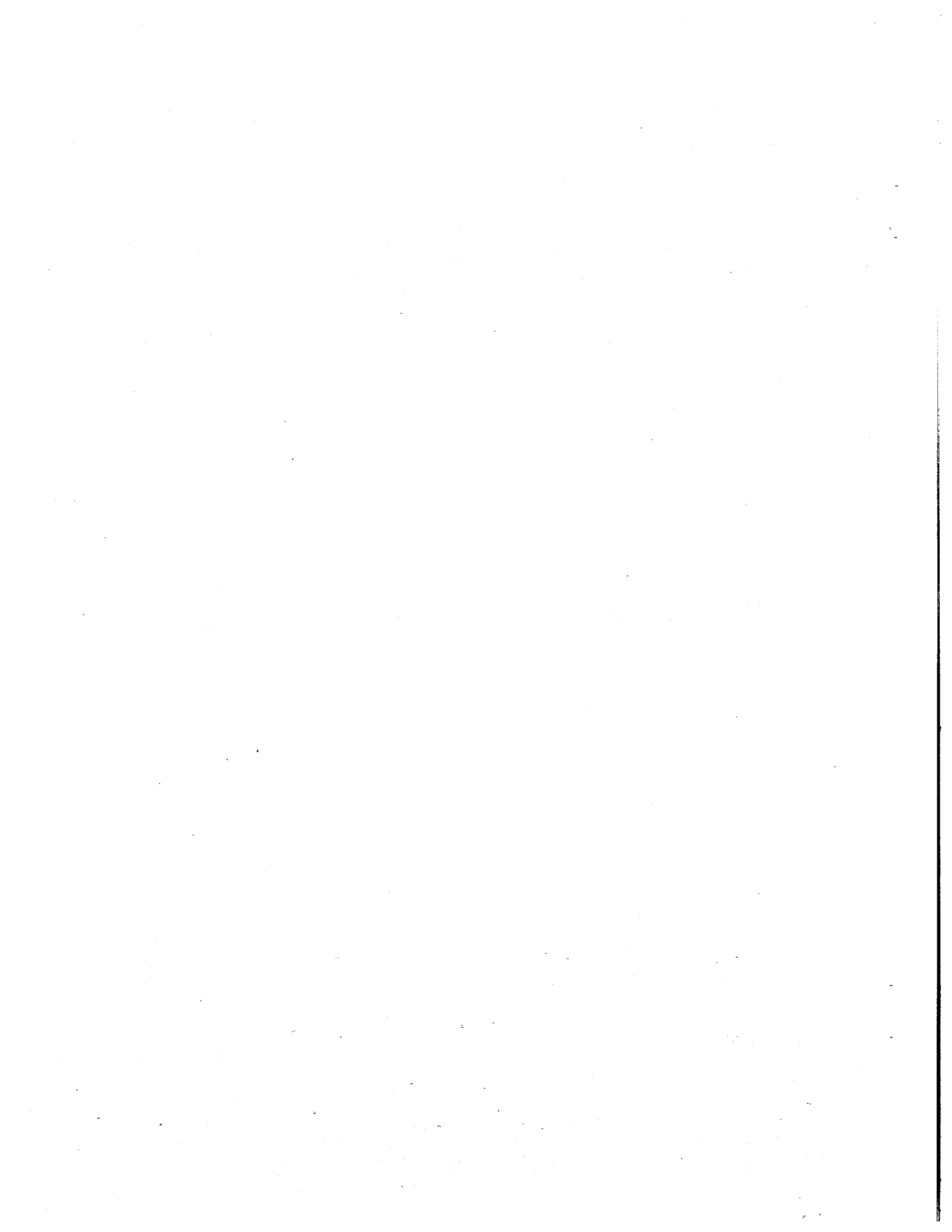

## General Information

---

This section acquaints the user with the major features and specifications of the HIPOTRONICS High Voltage Insulation Test Set, Model 100HVT, and the functions performed by each of the controls and indicators on the front panel.

### Features and Specifications

The HIPOTRONICS High Voltage Insulation Test Set is a portable unit with low input power requirements. It is designed specifically to meet ANSI specification A92.2 in the testing of new bucket trucks that use insulated booms. Both 220 and 115 volt input systems are available.

Standard features of the High Voltage Insulation Test Sets include:

- Portable construction
- Triple-range current meter to enable low leakage current measurements
- Continuously adjustable output from zero to full voltage
- Triple-range voltmeter
- "Zero start" and external interlock provisions
- Backup overload circuit
- Secondary overload relay protection
- High Voltage ON and OFF pushbuttons.

Figure 1 lists the specifications for the model purchased.

**Model:** 100 HVT

**Part No.:** CS14-1486

<b>Input</b>	115 V ac, 25 A, 60 Hz, 1 $\phi$ (220 V input also available)
<b>Output</b>	100 kV, 50 mA = 5 kVA/50 kV @ 100 mA = 5 kVA
<b>Duty Cycle</b>	5 min. ON/5 min. OFF, maximum. Repeated 6 times, then OFF for 2 hours.
<b>Current Meter</b>	Triple range, 0-1/10/100 mA ac
<b>Voltmeter</b>	Triple range, 0-25/50/100 kV ac
<b>Dimensions</b>	17 $\frac{1}{8}$ " Wide x 14 $\frac{1}{2}$ " Deep x 31 $\frac{1}{8}$ " High (441 mm Wide x 368 mm Deep x 810 mm High) HV Module 135 lb. (61 kg) Controls 62 lb. (28 kg) Complete Unit 197 lb. (89 kg)

Figure 1 HIPOTRONICS High Voltage Insulation Test Set Specifications

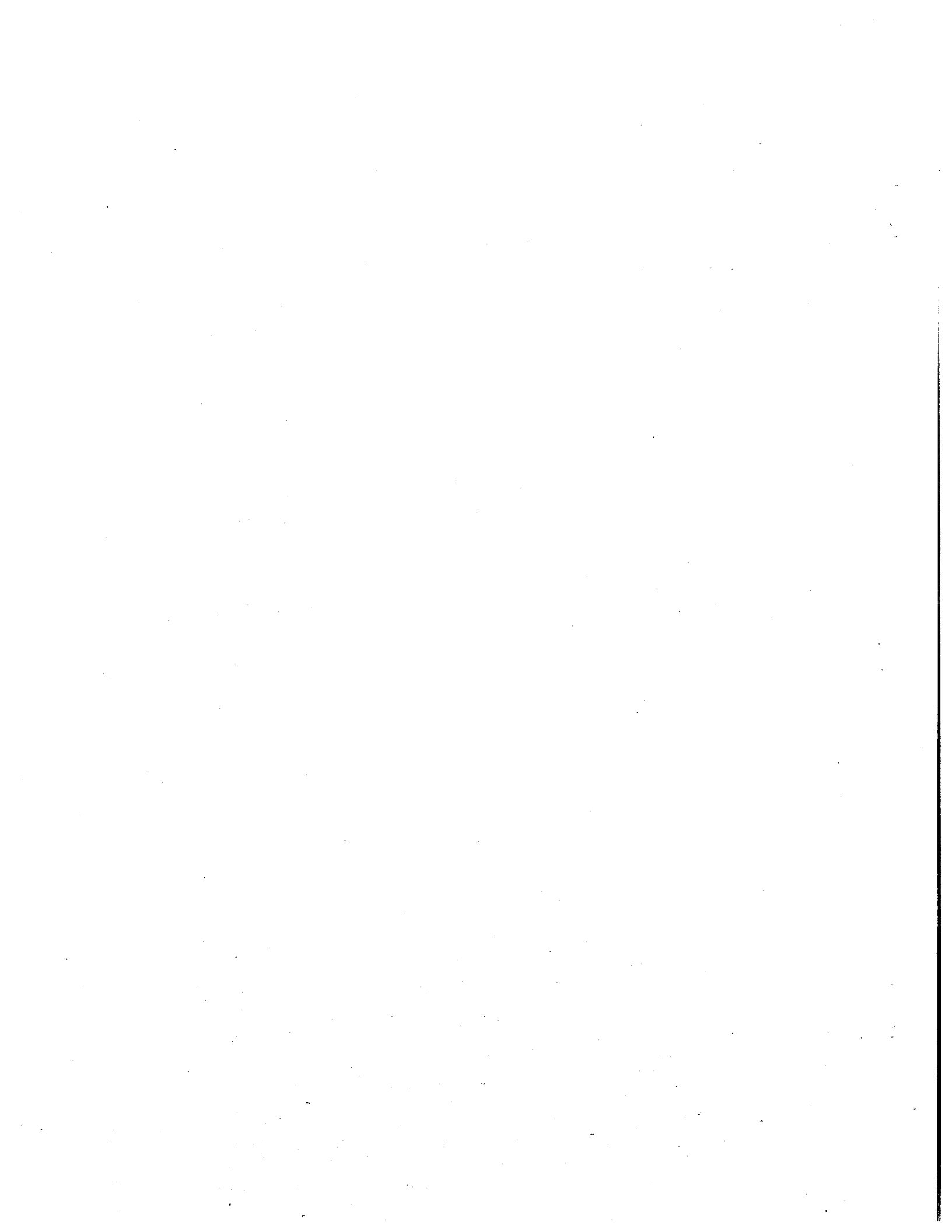



## Controls and Indicators

A diagram of the front panel for the High Voltage Insulation Test Set is displayed in Figure 2. Refer to this diagram, as well as to the front panel itself, when reading the description of the controls and indicators. *Note that the front panel displayed in Figure 2 may differ slightly from that of the model purchased.*

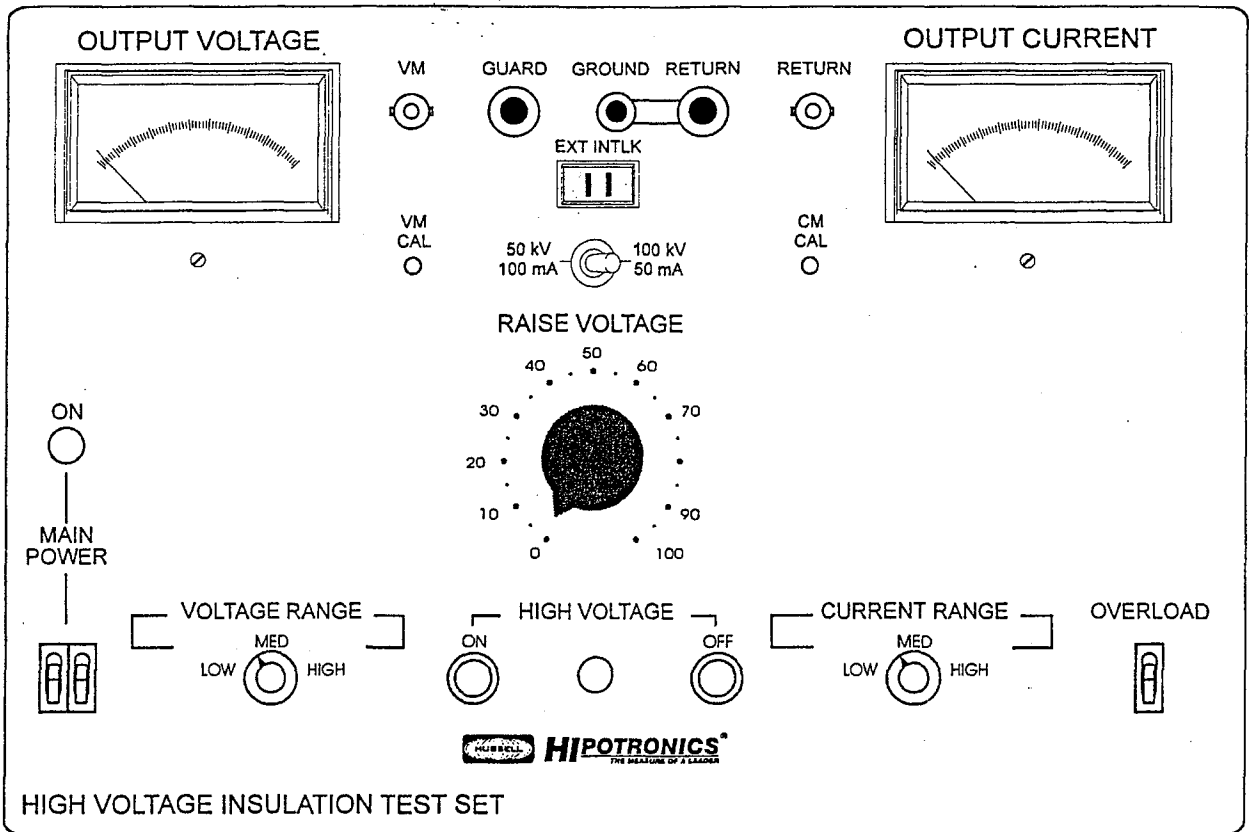

Figure 2 High Voltage Insulation Test Set Front Panel

### Main Power Circuit Breaker

The **MAIN POWER** circuit breakers provide the input power connection to the system. The breakers serve as the primary overload protection device for the system. Each circuit breaker is rated for the input voltage and maximum current under normal operating conditions. Under fault conditions, the current input of the system must be coordinated with a source power protection device to reduce the fault current. Failure to do so may cause the circuit breaker to fail, resulting in serious damage to the system.

### Overload Circuit Breaker

This circuit breaker trips and shuts down the test set when the power range is exceeded.

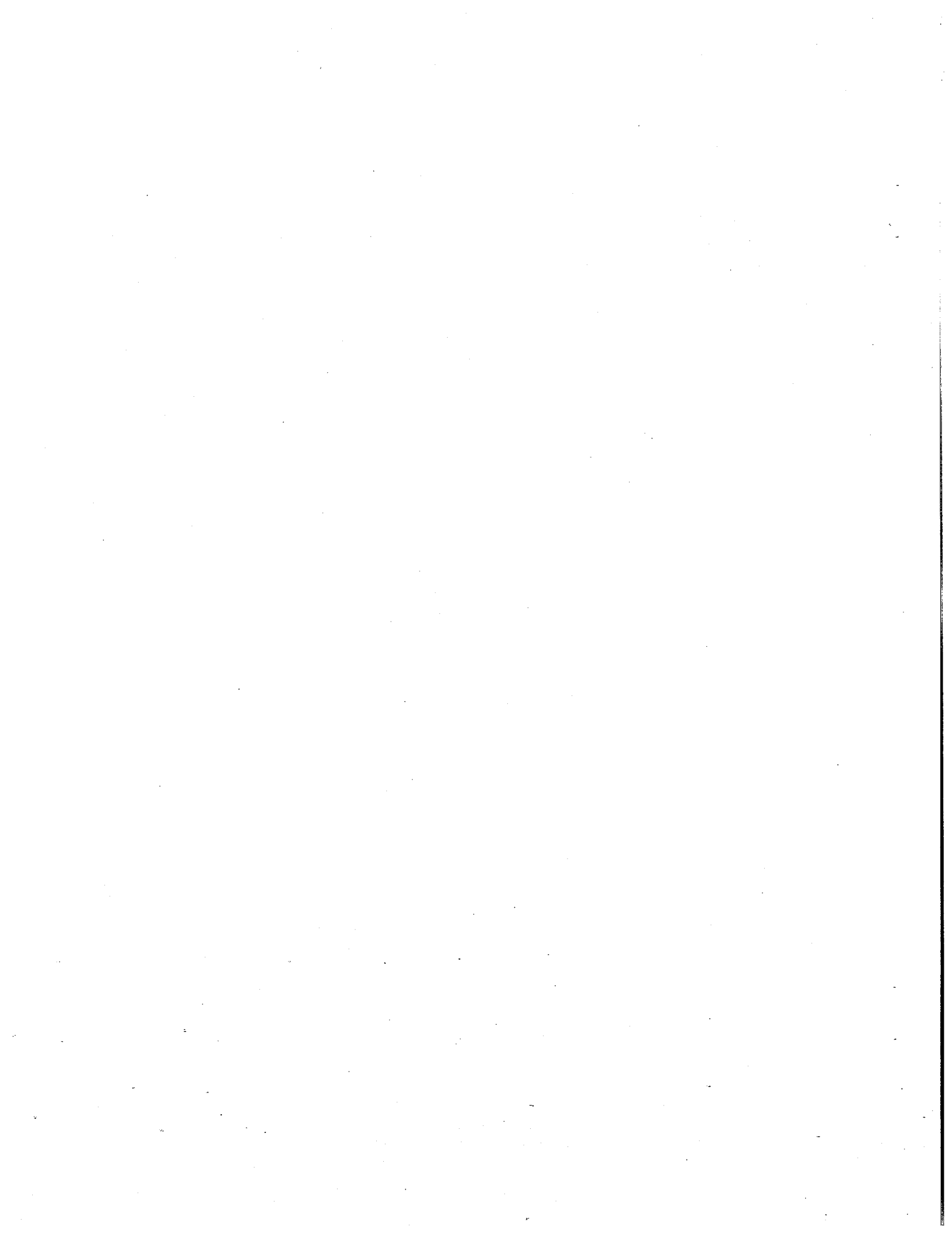

## External Interlock Provision

Use the **EXT INTLK** terminal to hook the test system to safety gates in the high voltage test area. The plug must be in the receptacle in order for the high voltage to be activated.

## Output Selector

Set the **OUTPUT SELECTOR** toggle switch to correspond to the connection of the high voltage voltmeter probe to the high voltage module. The output is 50 kV, 100 mA if the probe is connected to the 50 kV tap located on the side of the high voltage module. If the probe is connected to the brushed aluminum toroid on top of the high voltage module, the output will be 100 kV, 50 mA.

## High Voltage ON and OFF

The **HIGH VOLTAGE ON** pushbutton, when pressed, activates the high voltage transformer. This unit is supplied with a zero start feature that prohibits the user from activating the high voltage transformer unless the voltage regulator is set to zero. The red indicator lights when the high voltage transformer is activated. The **HIGH VOLTAGE OFF** pushbutton, when pressed, de-energizes the high voltage transformer.

## Raise Voltage Control

The **RAISE VOLTAGE** control knob is located in the center of the front panel. The markings **0-100** indicate to what percentage the voltage transformer is excited. The knob must always be returned to zero at the end of each test, before de-energizing the high voltage transformer.

## Output Voltmeter and Controls

The **OUTPUT VOLTMETER** is located on the left side of the front panel and displays the output voltage in kilovolts. The **VOLTAGE RANGE** selector allows for output voltage readings in three ranges, (0-25 kV, 0-50 kV, 0-100 kV) depending on the position of the selector.

## Output Current Meter and Controls

The **OUTPUT CURRENT METER** is located on the right side of the front panel and displays the magnitude of current circulating in the test loop. The **CURRENT RANGE** selector allows for output current readings in three ranges, (0-1/10/100 mA) depending on the position of the selector.

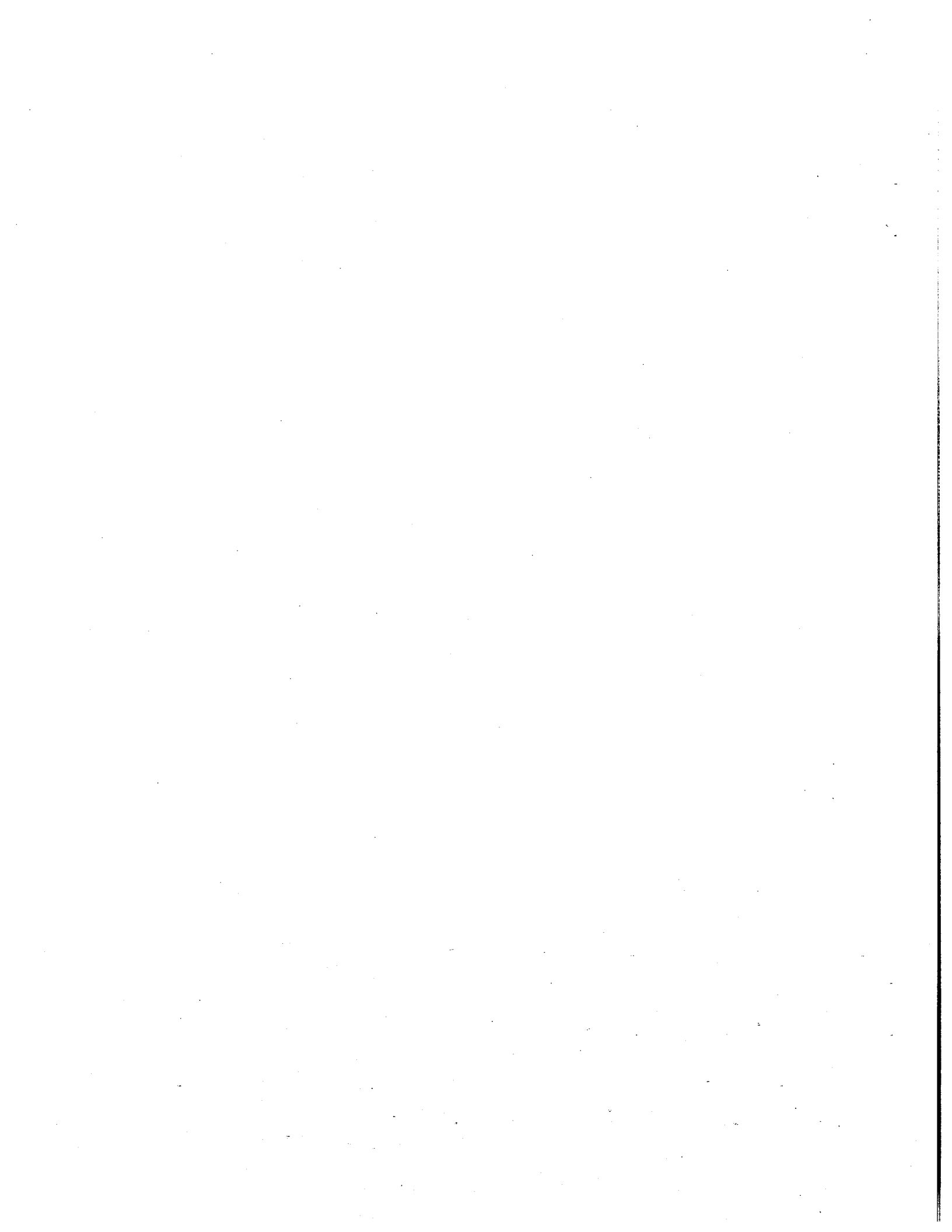

## Guard Circuit

On the panel are three 5-way binding posts labeled **GUARD**, **GROUND**, and **RETURN**. These binding posts are spaced so that a shorting link can connect either the **GUARD** or the **RETURN** posts to ground. *The shorting link must always be in place between the **GROUND** and the **GUARD** or **RETURN** posts.*

### Grounded Guard

In this mode, the shorting link is placed between the **GUARD** and **GROUND** terminals. The **RETURN** terminal is connected to the "low side" of the test specimen. This mode permits direct measurement of leakage current on or within the actual test object while bypassing any extraneous leakage current to ground (see Figure 3).

*Note: This mode can be used only when the test specimen is isolated from ground.*

**Caution!**  
*Ensure that the high voltage output is turned off before changing the position of the shorting link.*

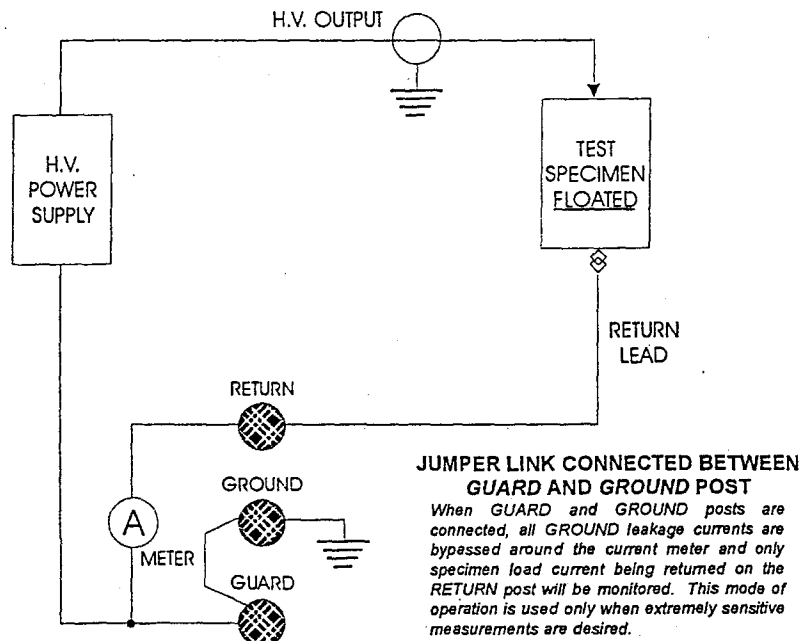
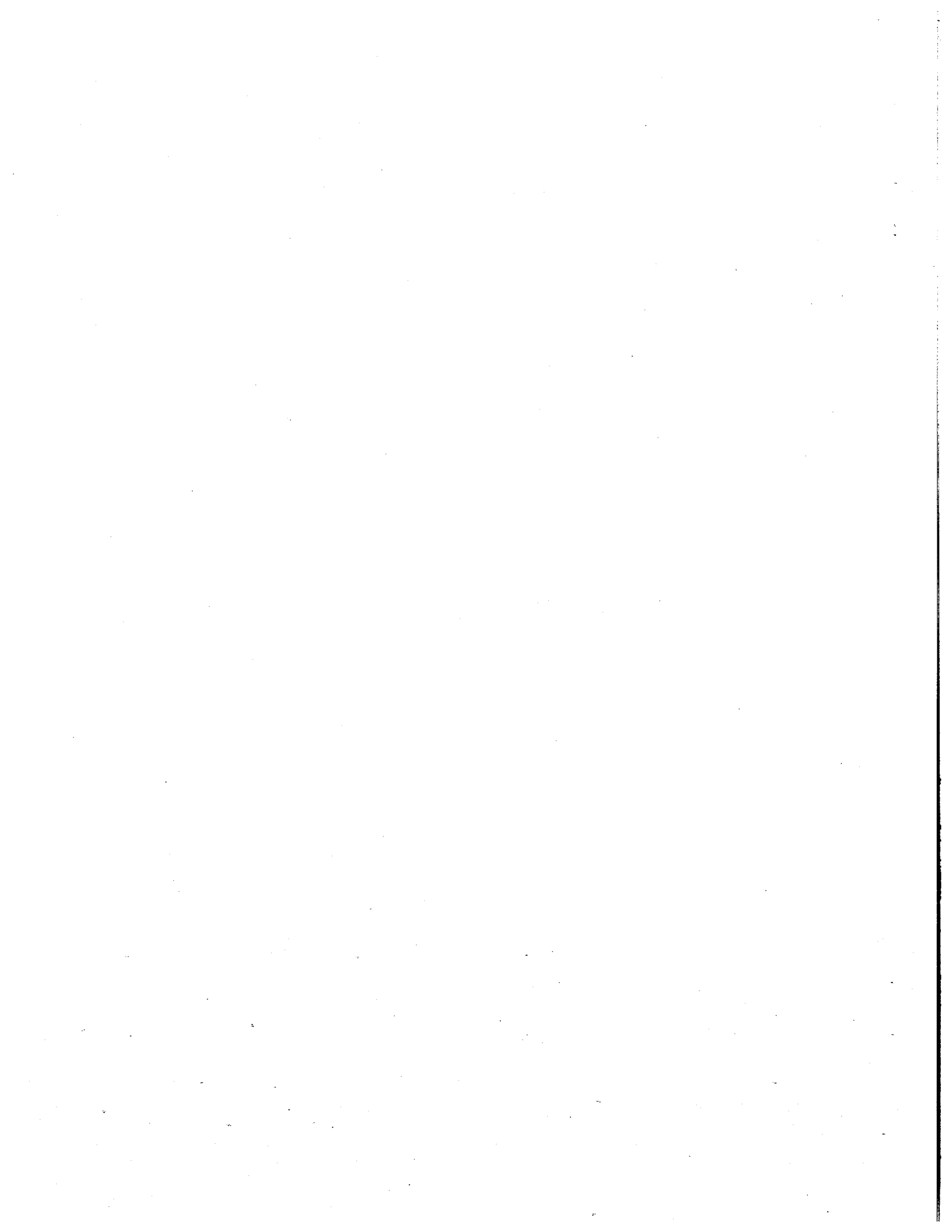

Figure 3 Jumper Link Connected Between Ground and Guard Post



## Grounded Return

In this mode, the shorting link is placed between the **GROUND** and **RETURN** terminals. The **RETURN** terminal is connected to the "low side" of the test specimen. This mode permits all leakage current to be measured by the current meter, including any extraneous leakage current that may be flowing to ground. This mode is less sensitive than the guarded return since extraneous leakage current is measured with the leakage current flowing through the test specimen (see Figure 4).

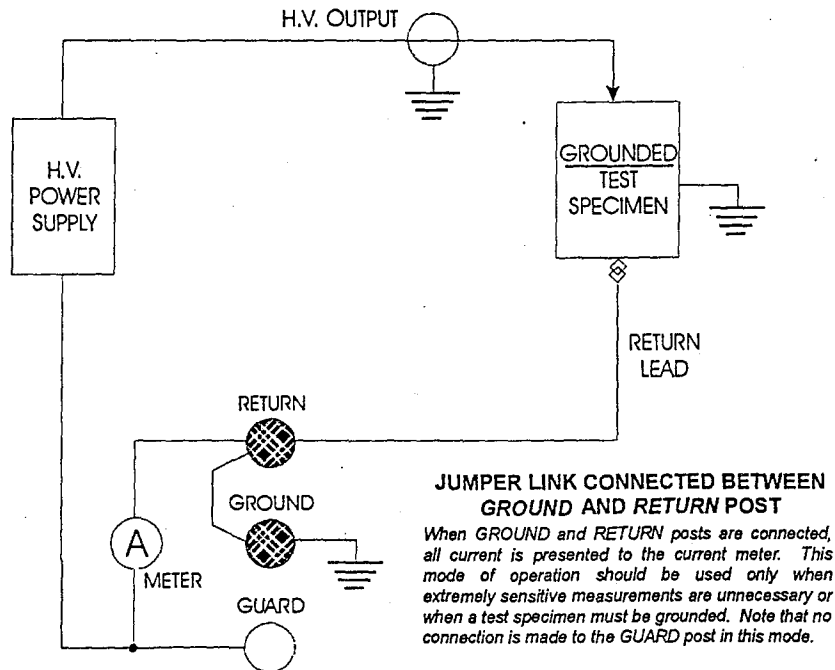
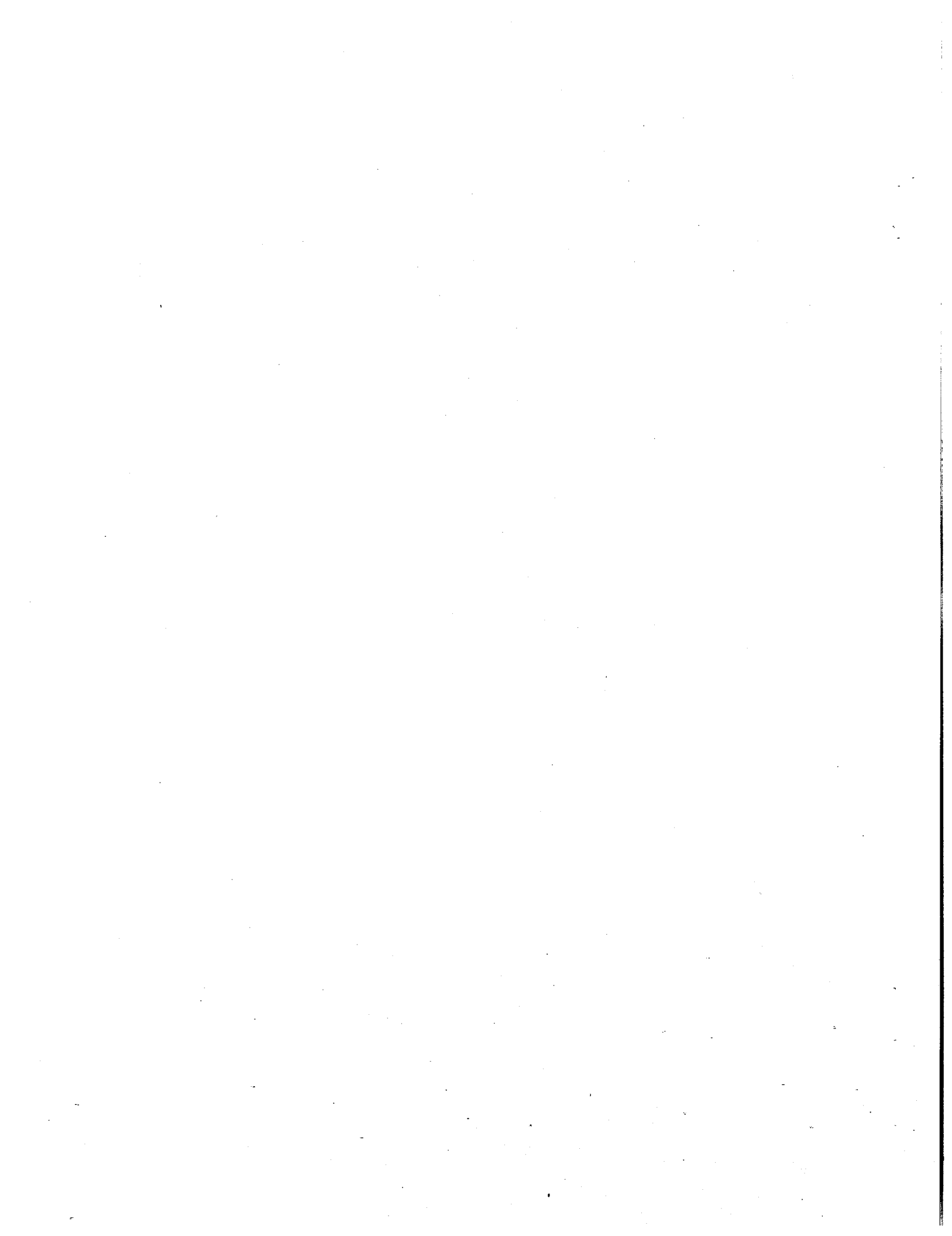

Figure 4 Jumper Link Connected Between Ground and Return Post





## Setting Up the Equipment

1. Position the test unit in the area where the high voltage module will be used and remove the high voltage module from the cart. The control cabinet should remain on the cart and should be positioned approximately 20 feet to one side of the high voltage module.
2. Remove the top cover of the control cabinet. Plug the 3-conductor power cable from the high voltage module into the socket on the control cabinet.
3. Remove the high voltage voltmeter probe from its vertical rack. Hook the probe over the brushed aluminum toroid on top of the high voltage module (for 100 kV output) or over the 50 kV tap on the side of the module (for 50 kV output) and allow it to hang to the ground (see Figure 5). *Note: The 50 kV tap is used only when performing bucket liner tests in water.*
4. Plug one end of the RG58/U coaxial cable into the base of the high voltage voltmeter probe. Plug the other end into the socket marked **HV PROBE** on the base of the high voltage module.
5. Locate the connector marked **VM** on the base of the high voltage module and connect it with coaxial cable to the BNC-type connector on the front panel labeled **VM**.
6. Locate the connector marked **RETURN** on the base of the high voltage module and connect it with coaxial cable to the BNC-type connector on the front panel labeled **RETURN**.
7. Connect a ground lead to the **GROUND** post on the front panel.
8. Position an aerial lift truck so that the boom extends outward and the bucket is directly above the high voltage module. Using an insulated or bare wire conductor, interconnect the high voltage module to the metal area where the boom and the bucket connect. Use 1-inch diameter conductor to minimize air corona and make leakage measurements easier.
9. Connect one end of each of the two remaining 20-foot insulated leads (black and red) to the front panel 5-way binding posts labeled **RETURN** and either **GROUND** or **GUARD** (see the section of this user's guide titled *Guard Circuit* on Page 4).

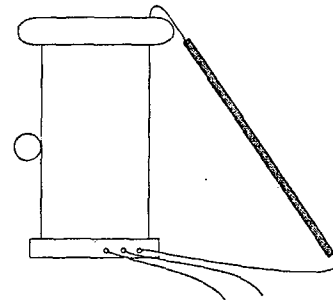
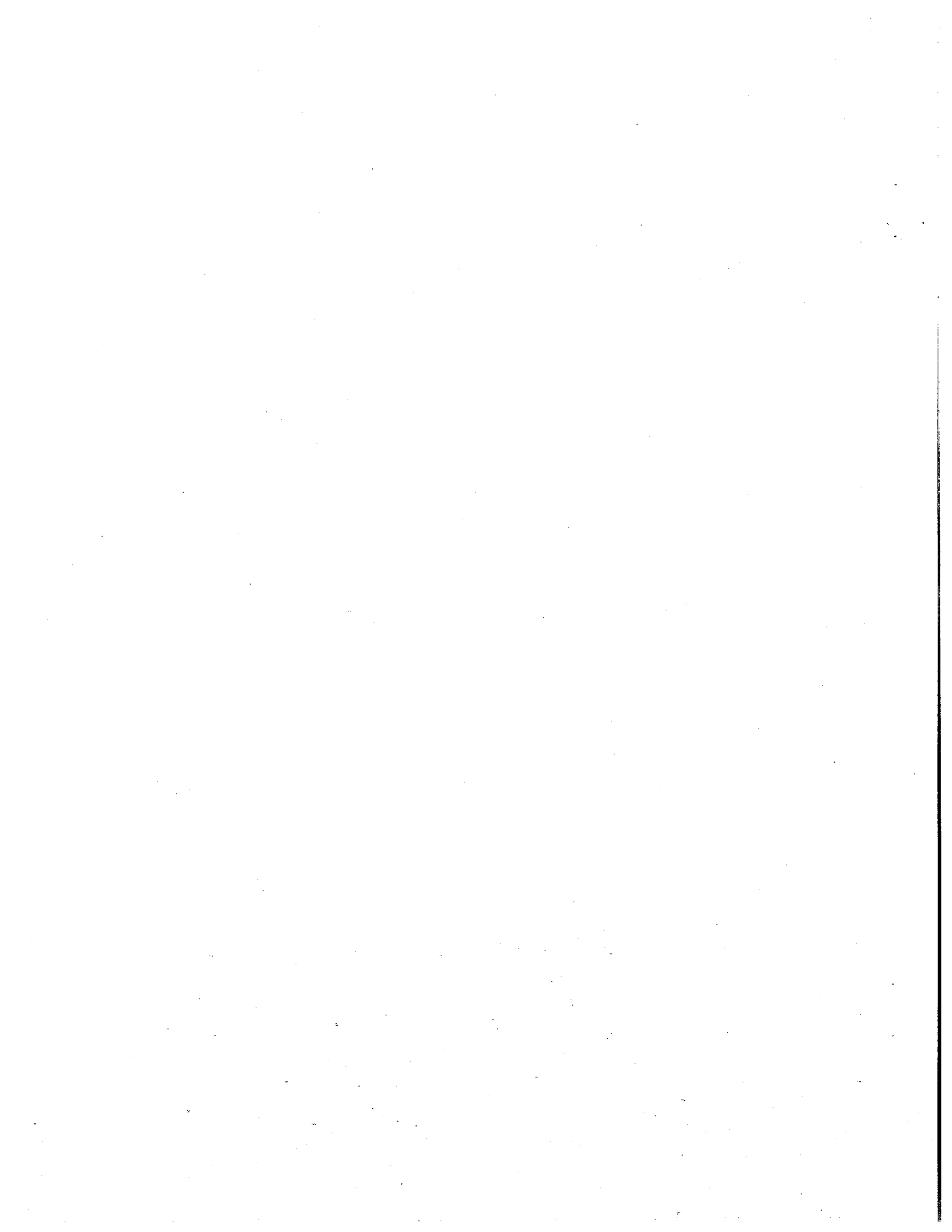

Figure 5 High Voltage Voltmeter Probe Hookup

**Warning!!**  
*The high voltage voltmeter probe must be hooked over the toroid on top of the high voltage module or over the 50 kV tap on the side of the high voltage module (depending on the type of test) before operating the unit.*



## Operating the Equipment

---

This section provides step-by-step instructions for operating the equipment. Prior to performing these tests, the procedures described in the section of this user's guide titled *Setting Up the Equipment* must be performed. Ensure that the main power circuit breaker is **OFF**.

1. Connect the low end of the test sample to ground with a conductor large enough to carry the rated output current of the system. Connect the high end of the test sample to the output bushing of the transformer. In general, aluminum or copper pipe is the most suitable material to use for this purpose. Use a minimum size of 1 inch OD per 100 kV. Keep all surfaces smooth and free of any sharp edges. Figures 6, 7, 8, 9, and 10 detail the connections to boom trucks. Figure 11 depicts a flashover test on a bucket liner in water.
2. Connect the input power cord to a power source. On 220 V units, a 220 V, 15 amp service is required. On 115 V units, a 115 V, 25 amp service is required.

*Note:* Depending on the capacitance of the test load, it may be possible to operate the system with less than rated input current. Since the system is power factor compensated for approximately 2.5 kVA, a 2.5 kVA capacitive load (660 pF @ 100 kV, 60 Hz, or 2.6 nF @ 50 kV, 60 Hz) will draw negligible input current. To operate at full capacitive load, for example, 1.3 nF @ 100 kV, 60 Hz; 1.6 nF @ 100 kV, 50 Hz; 5.3 nF @ 50 kV, 60 Hz; 6.4 nF @ 50 kV, 50 Hz; full 2.5 kVA input service is required.

3. Set the **VOLTAGE RANGE** and **CURRENT RANGE** selectors so the meters read to levels in the upper third of scale.
4. Set the **OUTPUT SELECTOR** toggle switch to the appropriate setting. Select the 50 kV/100 mA position only when the the high voltage voltmeter probe is hooked over the 50 kV tap on the side of the high voltage module and tests are being performed on bucket liners in water.
5. Turn the **MAIN POWER** and the **OVERLOAD** circuit breakers ON.
6. Turn the **RAISE VOLTAGE** selector to zero to engage the zero start interlock.
7. Press the **HIGH VOLTAGE ON** pushbutton. The associated indicator lights.
8. Turn the **RAISE VOLTAGE** selector to the desired voltage level. Depending on the test setup, the leakage current along the insulated boom section of the truck may now be recorded from the reading on the front panel current meter.
9. When the test is complete, return the **RAISE VOLTAGE** selector to zero and press the **HIGH VOLTAGE OFF** pushbutton to de-energize the high voltage transformer.

*Note:* If a fault occurs while testing, the secondary connected overload circuitry will activate, causing the high voltage circuitry to be de-energized. Return the **RAISE VOLTAGE** selector to zero.

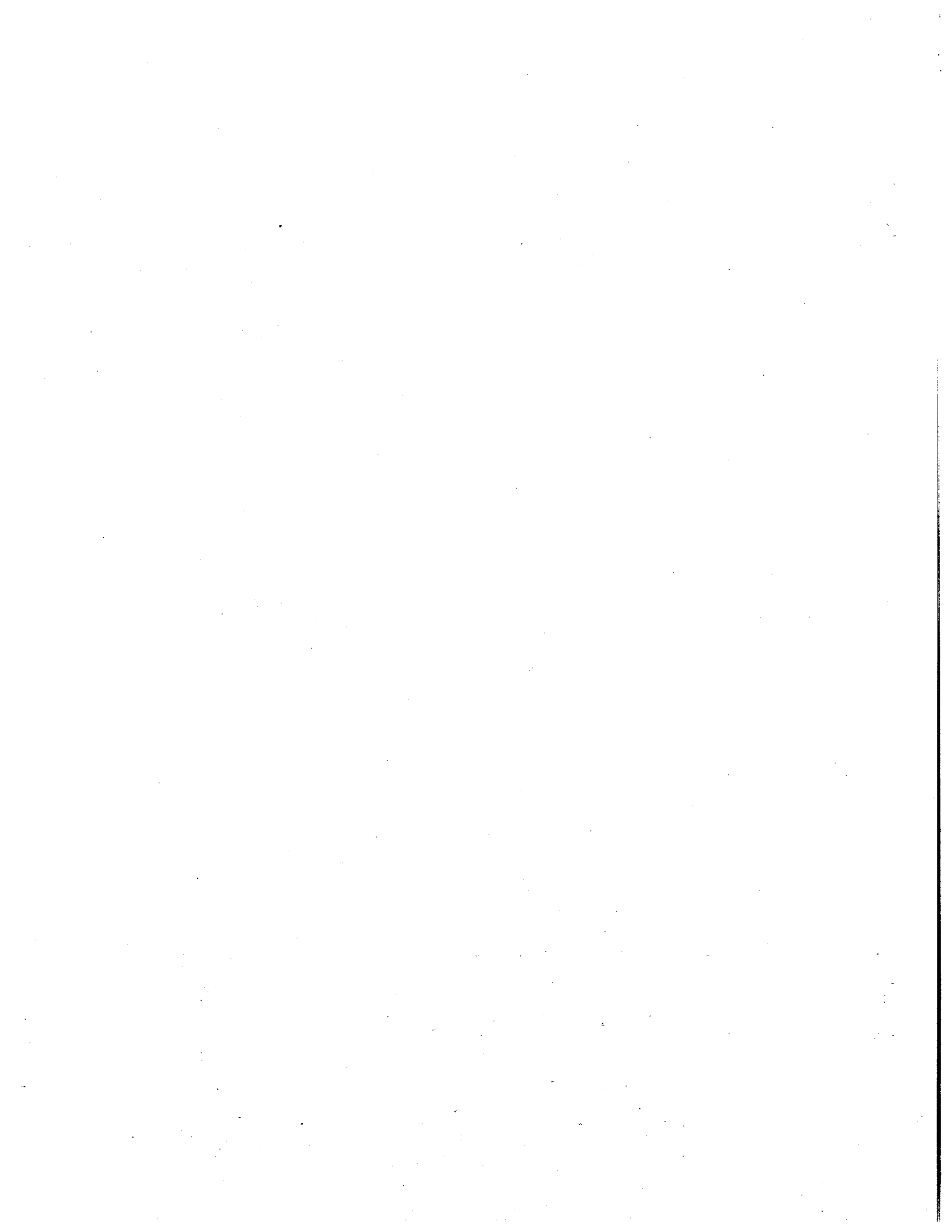

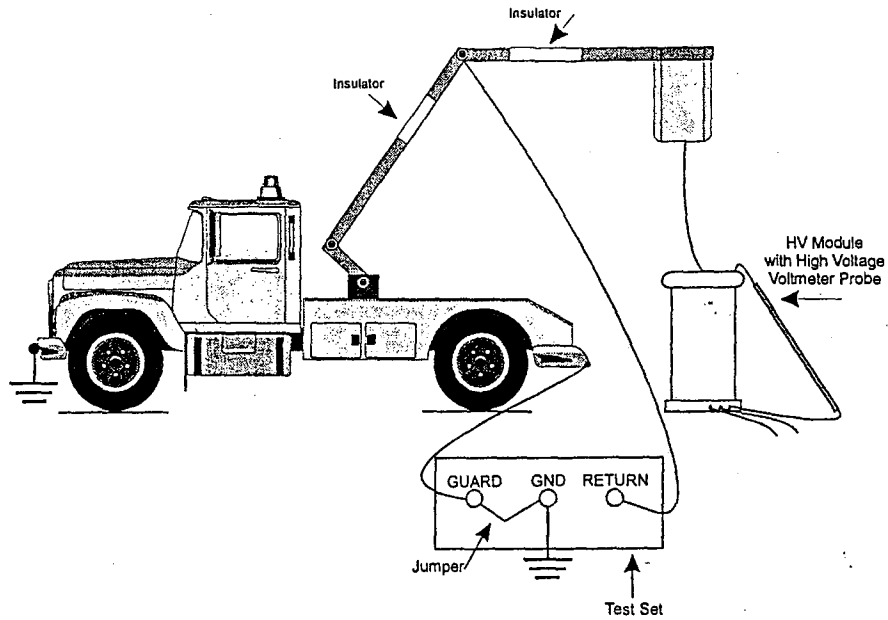

Figure 6 ANSI Test on the Upper Insulated Arm of a Double Insulated Boom Truck

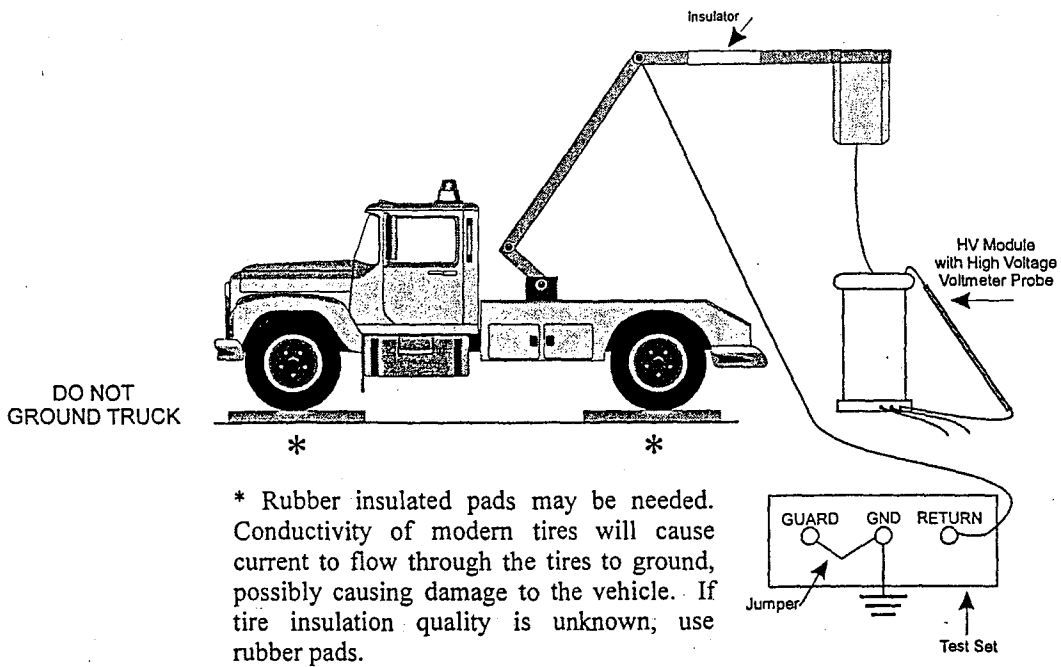
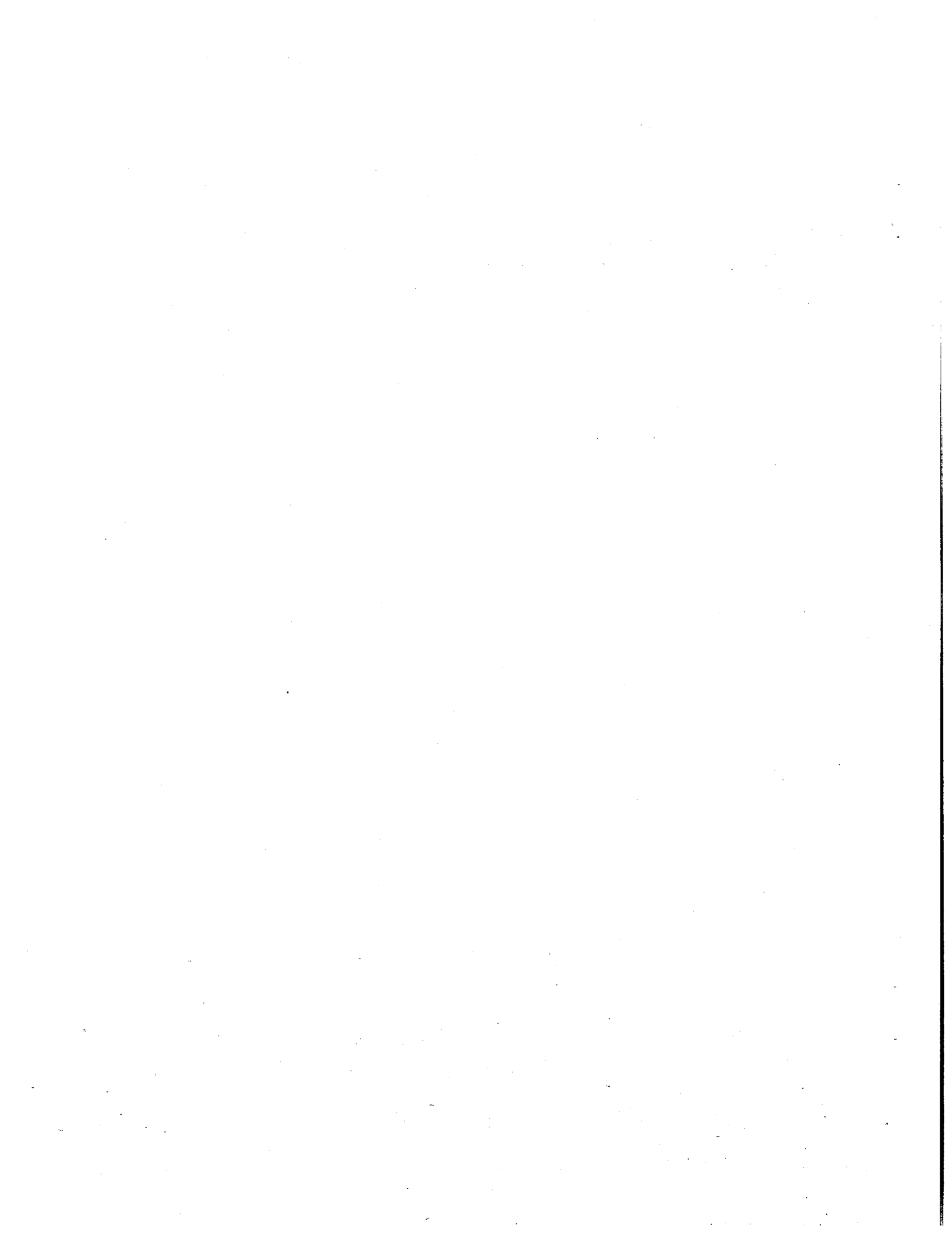

Figure 7 ANSI Test on the Upper Arm of a Single Insulated Boom Truck



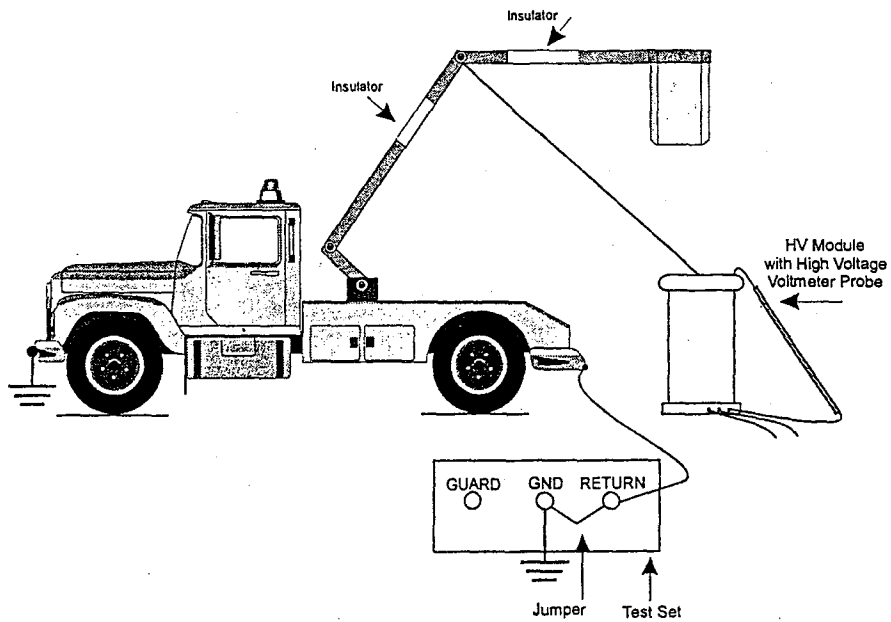

Figure 8 Flashover Test on Lower Insulated Arm of Double Insulated Boom Truck

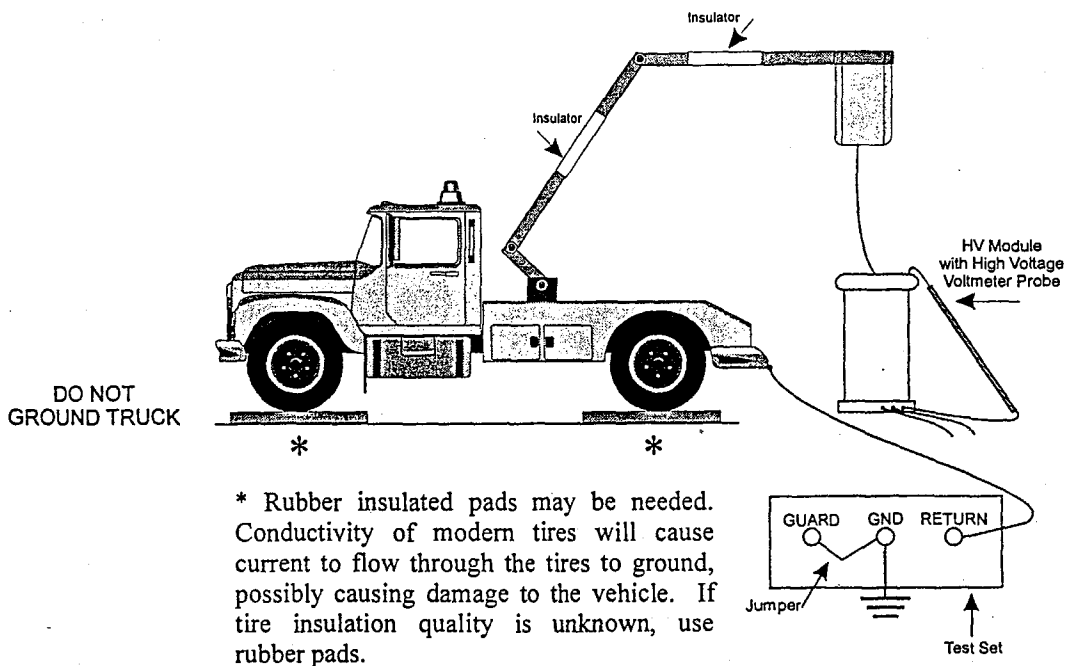
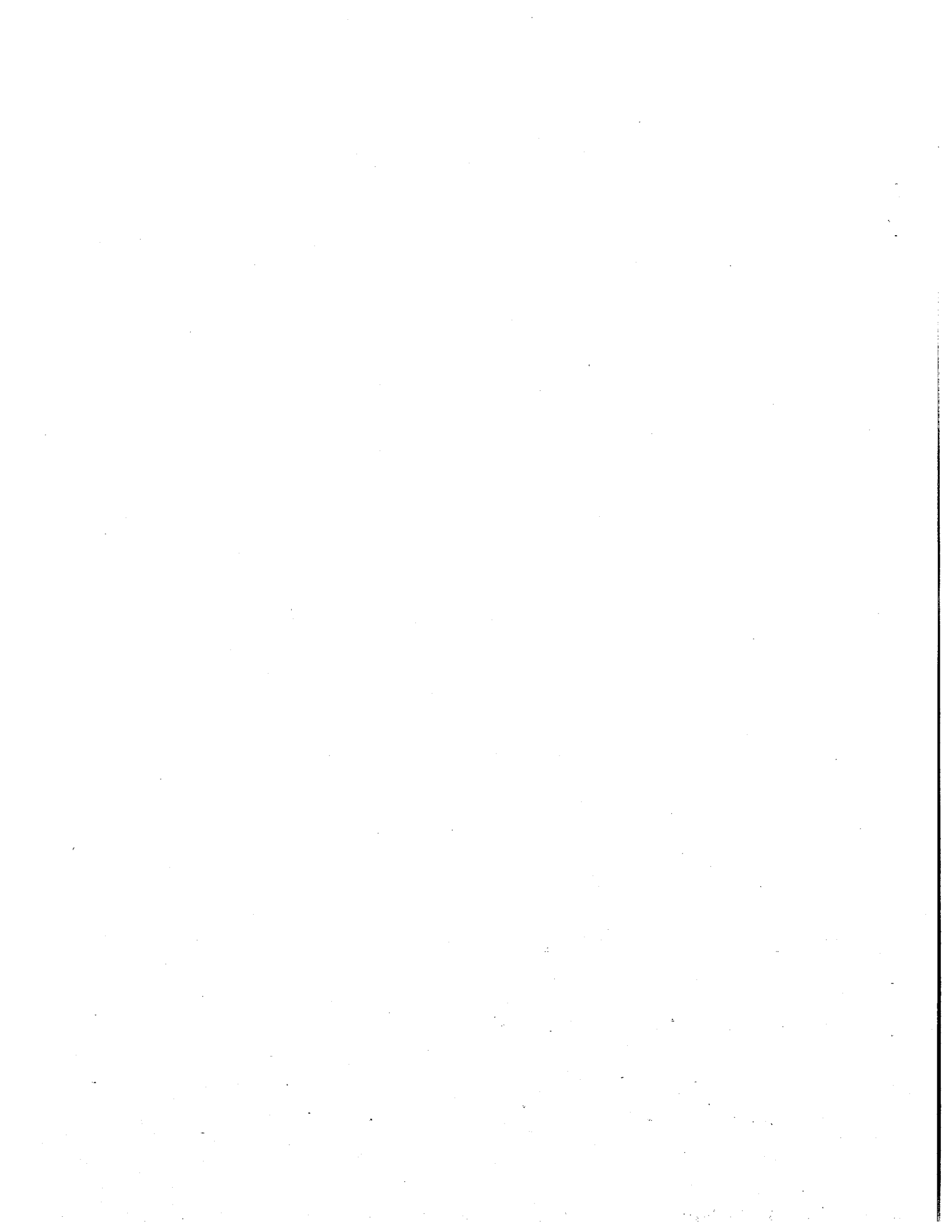

Figure 9 Overall Test on Double Insulated Boom Truck





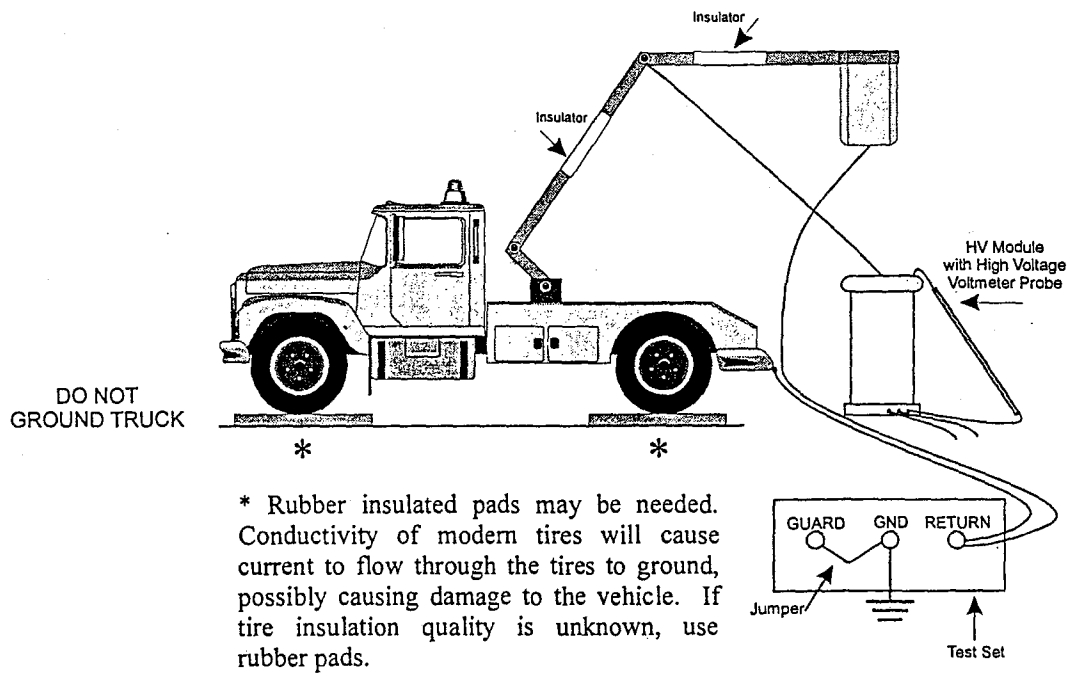

Figure 10 Phase-to-Phase Test on Double Insulated Boom Truck

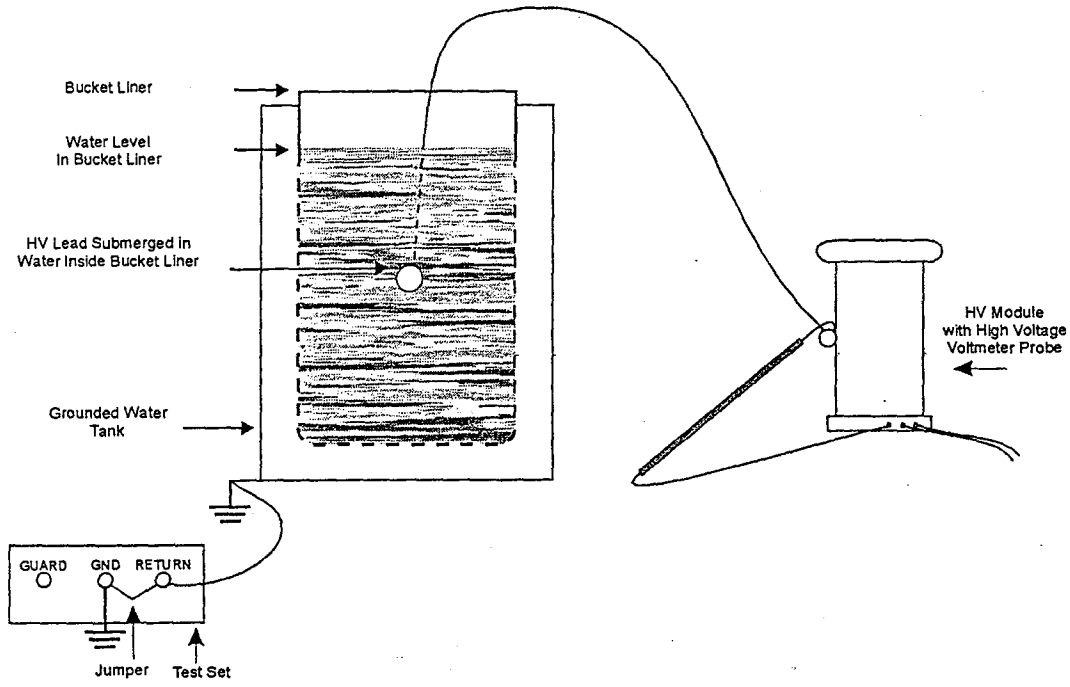
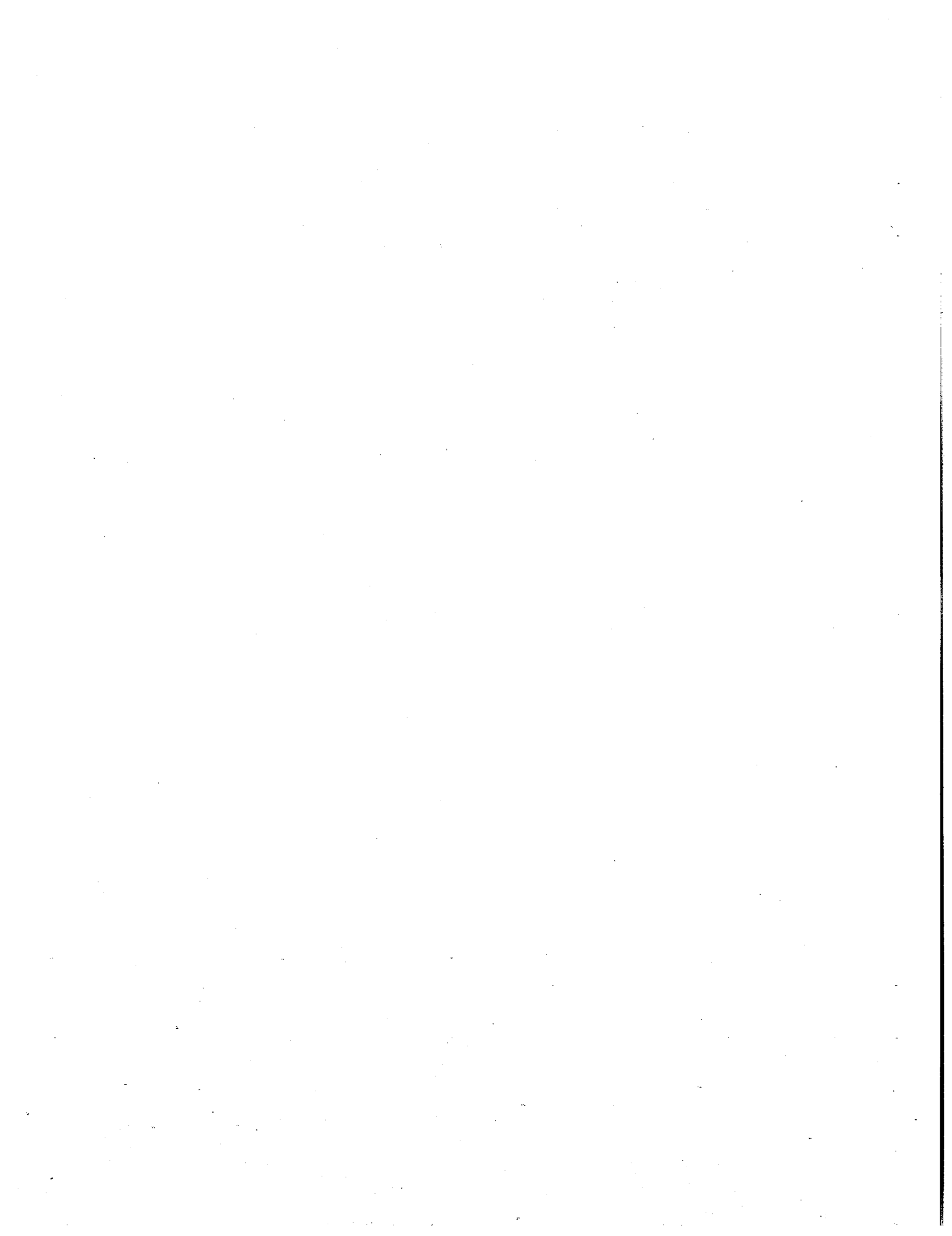

Figure 11 Flashover Test on Bucket Liner in Water



## Performing Special Operations

---

This section describes the step-by-step procedures required to perform meter recalibration and to maintain the equipment.

### Meter Recalibration

HIPOTRONICS meters have been calibrated with standards traceable to national standards maintained by the National Institute of Standards and Technology (NIST) in Washington, DC and are certified accurate to within 2 percent when shipped. Perform meter recalibration as often as necessary to meet the requirements of each particular installation, as dictated by usage and standards for accuracy. Three factors influence the frequency of meter calibration: the amount of physical handling, time lapse, and extent of usage. Intervals between meter recalibration can vary from one month to one year.

### Recalibrating the Current Meter

1. *Ensure the unit is properly grounded.*
2. Connect a suitable 1 mA standard current meter between the high voltage output toroid and ground potential.
3. Connect the unit to a suitable input power source.
4. Turn the **MAIN POWER** circuit breaker ON.
5. Press the **HIGH VOLTAGE ON** pushbutton.
6. Set the **CURRENT RANGE** selector to **LOW**. Increase the output current until the external current meter reading is equivalent to two-thirds of the unit's maximum rated output.
7. Press the **HIGH VOLTAGE OFF** pushbutton and remove the external meter.

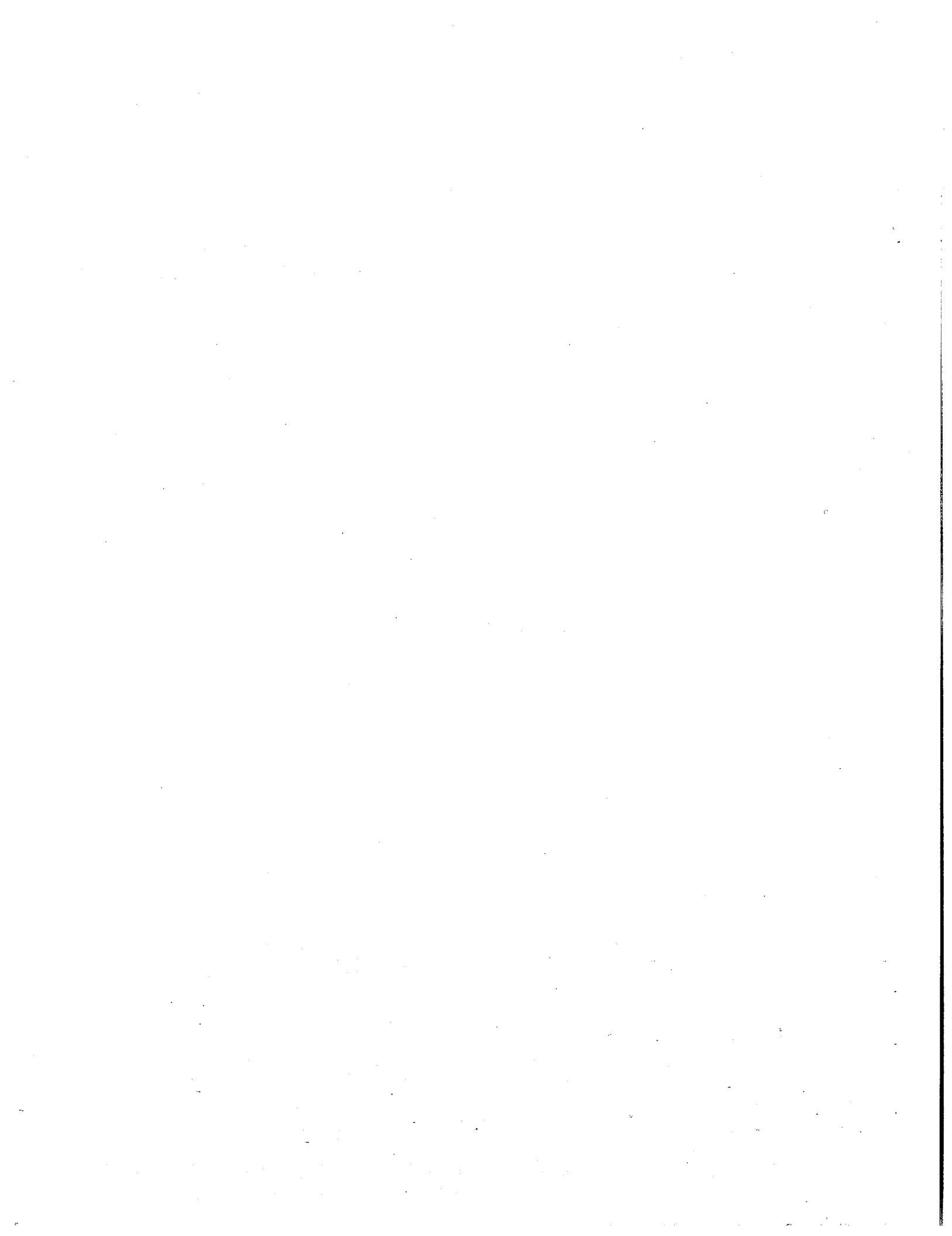

## Recalibrating the Voltmeter

1. *Ensure the unit is properly grounded.*
2. Connect a HIPOTRONICS standard kilovoltmeter between the high voltage output toroid and ground potential.
3. Connect the unit to a suitable input power source.
4. Turn the **MAIN POWER** circuit breaker ON.
5. Press the **HIGH VOLTAGE ON** pushbutton.
6. Set the **VOLTAGE RANGE** selector to LOW. For units with *analog* meters, increase the output voltage until the external voltmeter reading is equivalent to two-thirds of the high scale on the unit's meter.
7. Adjust the voltmeter calibration potentiometer until the unit's meter reading equals the reading on the external meter.
8. Press the **HIGH VOLTAGE OFF** pushbutton and remove the external meter. Ensure that all ranges are calibrated.

## Performing Maintenance

***Warning!!***

***To ensure operator safety, interconnecting ground and output cables must be inspected regularly for degraded insulation and frayed conductors.***

## Cleaning the Equipment Surfaces

Clean the painted surfaces and front panel with a damp cloth and a mild detergent, ensuring that the solution does not come in contact with the electrical circuitry. Clean meter faces and acrylic parts with a residue-free, commercial grade glass cleaner. Periodically, the interior of the unit should be blown out with water-free, filtered compressed air. This prevents dust build-up and extends the operating life of the equipment.

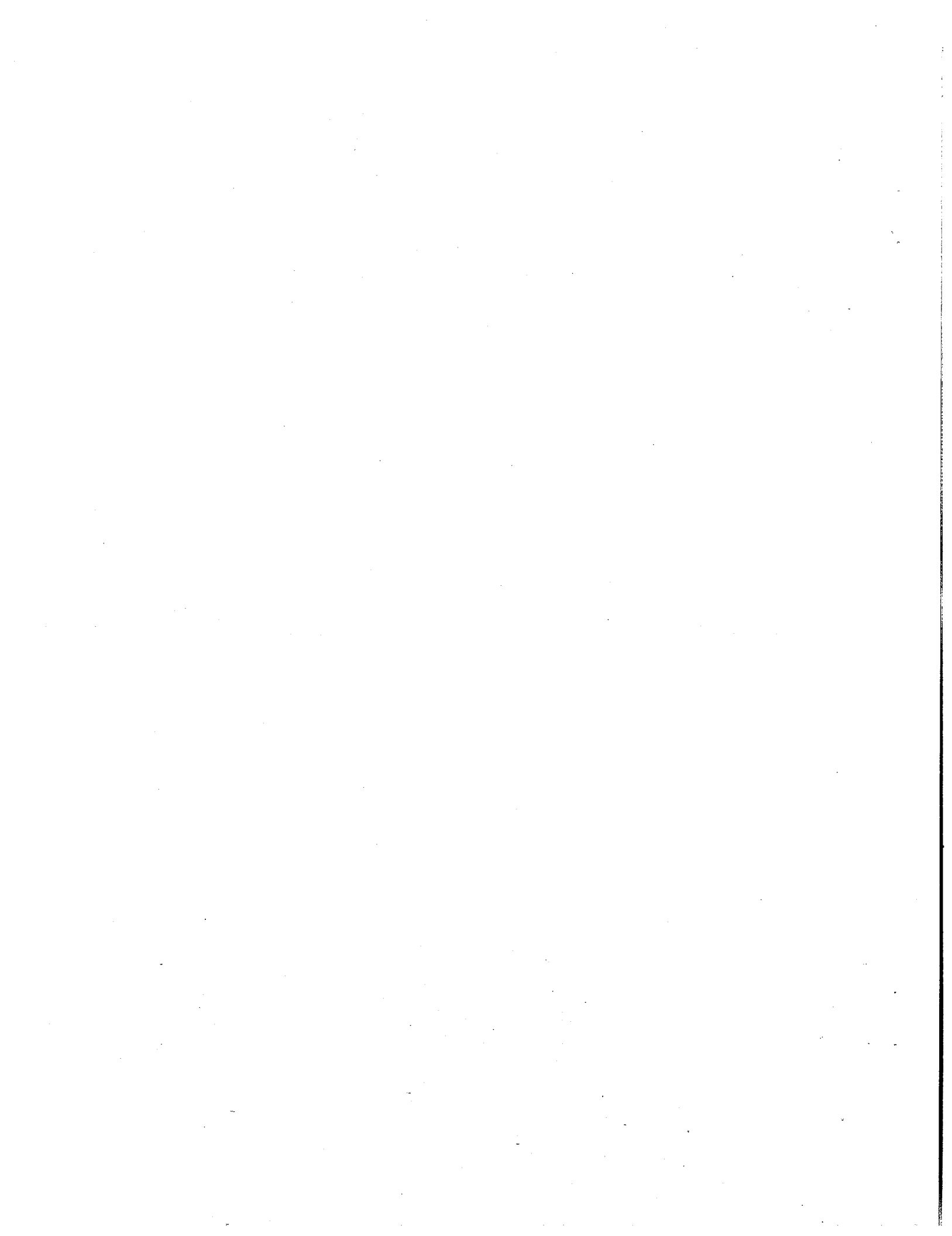

## Maintaining the Transformer Oil

The HV tank oil level should be maintained so that there is a minimum of 1 inch of space from the oil level to the header for every 30 inches of height at 25 degrees Centigrade. In the event oil must be added, use EXXON Univolt 60 uninhibited transformer oil or an equivalent. Observe ASTM Standards concerning oil dielectric breakdown limits. Perform tests at least annually using a HIPOTRONICS Liquid Dielectric Tester Model OC60 or the equivalent. *These tests should be performed by qualified personnel only, as serious damage may result from contamination.* Oil dielectric strength should be at least 22 kV with standard 0.1 inch disk electrodes.

## Cleaning the Meter Faces

When a meter acts erratically, clean the face with an anti-static solution such as Crown™ or Statnul™.

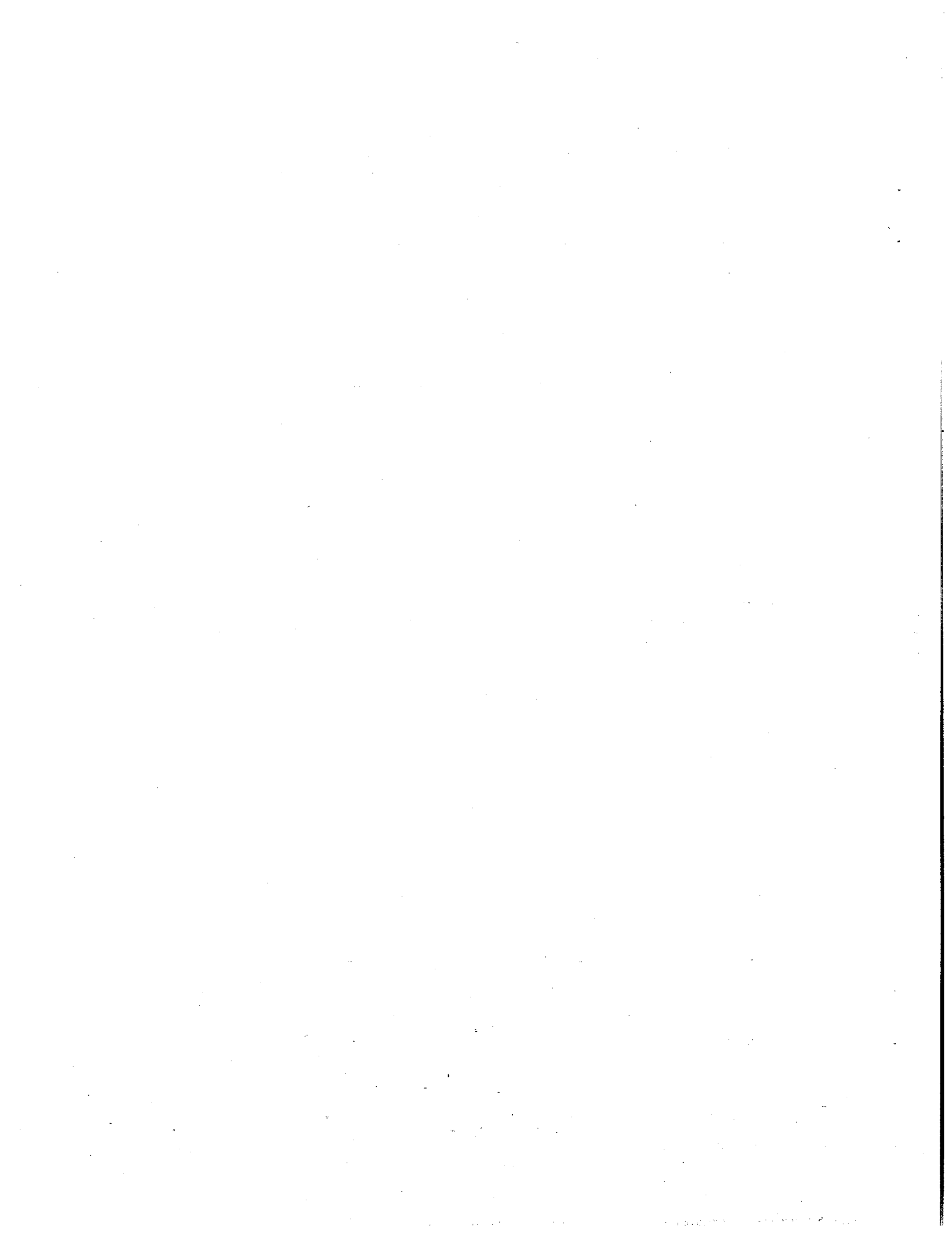



# Warranty



**HIPOTRONICS**<sup>®</sup>  
THE MEASURE OF A LEADER

HIPOTRONICS, INC. warrants to the original purchaser of any new merchandise that the merchandise is free from defects in materials and workmanship under normal use and service for a period of one (1) year from the date of shipment. The obligation of Hipotronics, Inc. under this warranty is limited, in its exclusive option, to repair, replace or issue credit for parts or materials which prove to be defective, and is subject to Purchaser's compliance with the Hipotronics, Inc. Warranty Claim Procedure as set forth below. The happening of any one or more of the following events will serve to void this warranty and any defect or damage resulting therefrom is specifically excluded from Warranty coverage:

- (a) defects due to accident, negligence, alteration, modification, faulty installation, abuse or misuse by Purchaser or Purchaser's agents or employees.
- (b) attempted or actual dismantling, disassembling, service or repair by any person, firm or corporation not specifically authorized in writing by Hipotronics, Inc.
- (c) defects caused by or due to handling by carrier or incurred during shipment, transshipment or other move.

This Warranty covers only those parts and/or materials deemed by Hipotronics, Inc. to be defective within the meaning of this Warranty. The liability of Hipotronics, Inc. shall be limited to the repair, replacement or issuance of credit for parts deemed defective within the meaning of this Warranty. Costs incurred by purchaser for labor or other expenses incidental to the inspection, repair, replacement or issuance of credit for such parts and/or materials shall be the sole responsibility of purchaser. This Warranty shall not apply to any accessories, parts or materials not manufactured or supplied by Hipotronics, Inc. and if, in the sole discretion of Hipotronics, Inc., Purchaser's claim relates to any materials of a component part, or of the manufacturer of a device of which the defective part is a component, Hipotronics, Inc. reserves the right to disclaim liability under this Warranty and to direct that the Purchaser deal directly with such supplier or manufacturer. Hipotronics, Inc. agrees to assist the

purchaser in processing or settling any such claim without prejudicing its position as to liability.

## Warranty Claim Procedure

Compliance with the following Warranty Claim Procedure is a condition precedent to the obligation of Hipotronics, Inc. under this Warranty.

- (a) Purchaser must notify Hipotronics, Inc. in writing by certified or registered mail, of the defect claimed within twelve (12) months after the date of original shipment. Said notice shall describe in detail the defect, the defective part and the alleged cause of the defect.
- (b) At the exclusive option of Hipotronics, Inc., Purchaser shall dismantle or disassemble at Purchaser's cost and expense and shall ship the defective part or material, prepaid, to Hipotronics, Inc., Brewster, New York 10509, for inspection, or permit an authorized service representative of Hipotronics, Inc. to inspect the defective part or material at the Purchaser's premises. Purchaser shall provide facilities for, and at Purchaser's cost and expense, dismantle, disassemble, or otherwise make accessible the subject part or material whether or not same is a component of, or installed in, a device other than that manufactured or supplied by Hipotronics, Inc. If disclosure shows that the defect is not one for which Hipotronics, Inc. is liable, the Purchaser agrees to reimburse Hipotronics, Inc. for all expense incurred.
- (c) Upon receipt of the defective part or material, or after access to same, Hipotronics, Inc. shall inspect the part or material to determine the validity of Purchaser's claim.

The validity of any Warranty Claim, Purchaser's compliance with Hipotronics, Inc. Warranty Claim Procedure, the obligation to either repair, replace or issue credit, or direct the purchaser to deal directly with a manufacturer or supplier are to be determined solely and exclusively by Hipotronics, Inc. any determination so made shall be final and binding.

**THIS WARRANTY IS EXPRESSLY IN LIEU OF ALL OTHER WARRANTIES EXPRESSED OR IMPLIED ON THE PART OF HIPOTRONICS, INC., INCLUDING THE WARRANTIES OF MERCHANTABILITY AND FITNESS FOR USE AND CONSEQUENTIAL DAMAGES ARISING FROM ANY BREACH THEREOF AND HIPOTRONICS, INC. NEITHER ASSUMES NOR AUTHORIZES ANY OTHER PERSON, FIRM OR CORPORATION TO ASSUME ANY LIABILITY OR OBLIGATION IN CONNECTION WITH THIS SALE ON ITS BEHALF AND PURCHASER ACKNOWLEDGES THAT NO REPRESENTATIONS EXCEPT THOSE MADE HEREIN HAVE BEEN MADE TO PURCHASER.**

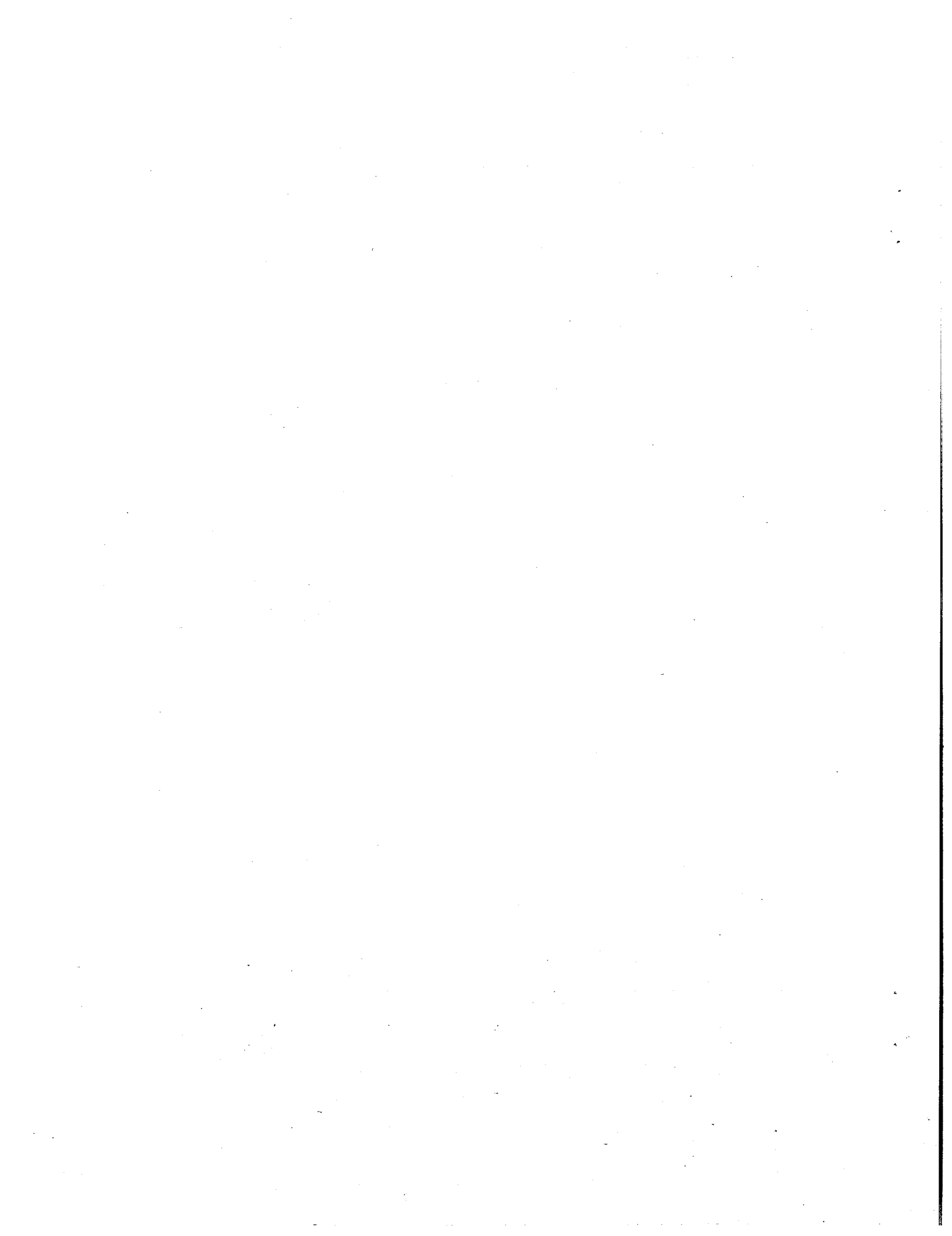

# Warranty



## Returned Material

If it should become necessary to return the equipment described in this publication to the factory, the Service Department of HIPOTRONICS, INC. must be contacted at (914) 279-8091. If the return of the unit is appropriate, a Return Authorization Number will be issued and you will be instructed as to the method of return. If return of the unit is *not* advisable, other inspection arrangements will be made.

Please have the following information available to help our service personnel identify the unit and determine the necessity for return.

**Note: Material received at this plant without the proper authorization shall be held as "customer's property" and no service will be performed until the proper steps have been taken. Your cooperation is requested in order to ensure prompt service.**

MODEL: \_\_\_\_\_

SERIAL NUMBER: \_\_\_\_\_

TYPE (Part Number): \_\_\_\_\_

*(The MODEL, SERIAL NUMBER and TYPE are indicated on the black and silver tag affixed to the unit.)*

REASON FOR RETURN: \_\_\_\_\_

\_\_\_\_\_

\_\_\_\_\_

DEFECT: \_\_\_\_\_

\_\_\_\_\_

\_\_\_\_\_

## Replacement Parts

To order replacement parts for this unit, please refer to the Parts List provided with this publication. Provide the number of the specific component along with the *type* (Part Number) of the unit, which is indicated on the Parts List and on the black and silver tag affixed to the unit.

