

HIOKI

FT4310

Instruction Manual

BYPASS DIODE TESTER



EN

May 2017 Revised edition 1
FT4310A961-01 17-05H



Contents

Introduction.....	1
Verifying Package Contents	1
Safety Information	3
Operating Precautions	8

1 Overview 13

1.1 Product Overview.....	13
1.2 Names and Functions of Parts	14

2 Preparing for Measurement 21

2.1 Battery Replacement	22
2.2 Using Model L9788-10 Test Lead with Remote Switch (Red)	24
2.3 How to Use the Carrying Case (Model C0206).....	26

3 Measurement 27

3.1 Pre-measurement Inspection	27
3.2 Auto Power Save (Power-Saving Function) 29	
3.3 Auto Backlight-off (Automatic Light-off Function).....	30
3.4 Pass/Fail Judgment (Comparator) Function	31
Setting the Comparator Function	32
Canceling the Comparator Function	32
3.5 Measurement Preparation	33
3.6 Making Measurements in Voc Mode.....	34
Comparison Display Function.....	35
Auto-hold	36

	Negative Voltage Notification Function	37
	Ground Fault Detection	37
3.7	Making Measurements in BPD TEST Mode 38	
	Lock Function	39
	Measuring Bypass Diode	40
3.8	Bluetooth® Communication Function..... 43	
	Installing the Smartphone Application Software	
	GENNECT Cross	44
	Pairing the Application Software	45
	Making Measurements with the Bluetooth® Function	46
4	Specifications	47
4.1	General Specifications	47
4.2	Input/Output/Measurement Specifications .	49
4.3	Function Specifications.....	54
4.4	Interface Specifications	57
4.5	Factory Settings	57
5	Maintenance and Service	59
5.1	Troubleshooting	60
	Error Displays and Remedies	61
Appx.	Appx.1	
	Appx. 1 Measurement Principles	Appx.1
	Measurement Principles for Bypass Diodes with an Open Fault.....	Appx.1
	Measurement Principles for Bypass Diodes with a Short-circuit Fault	Appx.2

Introduction

Thank you for purchasing the Hioki FT4310 Bypass Diode Tester. To obtain maximum performance from the instrument, please read this Instruction Manual first, and keep it handy for future reference.

Verifying Package Contents

When you receive the instrument, inspect it carefully to ensure that no damage occurred during shipping. In particular, check the accessories, panel switches, and connectors. If damage is evident, or if it fails to operate according to the specifications, contact your authorized Hioki distributor or reseller.

Confirm that these contents are provided.

- Model FT4310
Bypass Diode Tester



- Instruction Manual



- LR6 Alkaline battery × 6



- Model C0206 Carrying Case
- Model L9788-11
Test Lead Set with Remote Switch

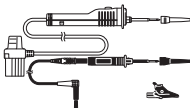

Model L9788-11 is a set of model L9788-10 Test Lead with Remote Switch (Red) and EARTH side lead.

Options

The following options are available for the instrument. Contact your authorized Hioki distributor or reseller when ordering.

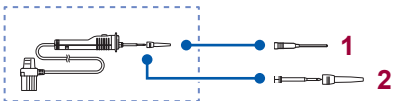

	Product name	Maximum rated voltage and maximum rated current
1	Model L9788-92 Breaker Pin	CAT III 600 V, 2 A
2	Model L9788-90 Tip Pin	CAT III 600 V/CAT II 600 V, 2 A

Safety Information

This instrument is designed to conform to IEC 61010 Safety Standards, and has been thoroughly tested for safety prior to shipment. However, using the instrument in a way not described in this manual may negate the provided safety features.

Before using the instrument, be certain to carefully read the following safety notes.

DANGER



Mishandling during use could result in injury or death, as well as damage to the instrument. Be certain that you understand the instructions and precautions in the manual before use.

WARNING



Protective gear

This instrument is measured on a live line. To prevent an electric shock, use appropriate protective insulation and adhere to applicable laws and regulations.

Notation

In this manual, the risk seriousness and the hazard levels are classified as follows.





DANGER

Indicates an imminently hazardous situation that will result in death or serious injury to the operator.









WARNING

Indicates a potentially hazardous situation that may result in death or serious injury to the operator.

 CAUTION	Indicates a potentially hazardous situation that may result in minor or moderate injury to the operator or damage to the instrument or malfunction.
	Indicates prohibited actions.
	Indicates the action which must be performed.
*	Additional information is presented below.
(p.)	Indicates the page of reference information.
[]	Screen displays are enclosed in square brackets.
MEASURE (Bold)	Indicates the names of keys and other controls on the instrument.

Symbols on the instrument

	Indicates cautions and hazards. When the symbol is printed on the instrument, refer to a corresponding topic in the Instruction Manual.
	Indicates that dangerous voltage may be present at this terminal.
	Indicates a instrument that has been protected throughout by double insulation or reinforced insulation.
	Indicates a grounding terminal.
	Indicates DC (Direct Current).
	Indicates AC (Alternating Current).

Symbols for various standards



Indicates the Waste Electrical and Electronic Equipment Directive (WEEE Directive) in EU member states.



Indicates that the product conforms to regulations set out by the EU Directive.



Indicates that the product incorporates Bluetooth® wireless technology.

Screen Display

The instrument screen displays the alphanumeric characters as follows.

A	B	C	D	E	F	G	H	I	J	K	L	M	N	O	P	Q	R	S	T	U	V	W	X	Y	Z
A	b	c	d	E	F	G	H	.	u	l	ñ	n	o	P	q	r	S	t	U	u	y	1	4	3	

1	2	3	4	5	6	7	8	9	0
1	2	3	4	5	6	7	8	9	0

Accuracy

We define measurement tolerances in terms of rdg. (reading) and dgt. (digit) values, with the following meanings:

	(reading or displayed value)
rdg.	The value currently being measured and indicated on the measuring instrument.
	(resolution)
dgt.	The smallest displayable unit on a digital measuring instrument, i.e., the input value that causes the digital display to show a “1” as the least-significant digit.

Trademarks

- Bluetooth® is a registered trademark of Bluetooth SIG, Inc. (USA). The trademark is used by HIOKI E.E.CORPORATION under license.
- Android, Google Play are registered trademarks of Google, Inc.
- IOS is a registered trademark of Cisco in the U.S. and other countries.
- iPhone, iPad, iPad mini, and iPod Touch are trademarks of Apple Inc.
- The App Store is a service mark of Apple Inc.

Measurement Categories

To ensure safe operation of measuring instruments, IEC 61010 establishes safety standards for various electrical environments, categorized as CAT II to CAT IV, and called measurement categories.

DANGER



- **Using a measuring instrument in an environment designated with a higher-numbered category than that for which the instrument is rated could result in a severe accident, and must be carefully avoided.**
- **Never use a measuring instrument that lacks category labeling in a CAT II to CAT IV measurement environment. Doing so could result in a serious accident.**

CAT II: When directly measuring the electrical outlet receptacles of the primary electrical circuits in equipment connected to an AC electrical outlet by a power cord (portable tools, household appliances, etc.)

CAT III: When measuring the primary electrical circuits of heavy equipment (fixed installations) connected directly to the distribution panel, and feeders from the distribution panel to outlets.

CAT IV: When measuring the circuit from the service drop to the service entrance, and to the power meter and primary overcurrent protection device (distribution panel).

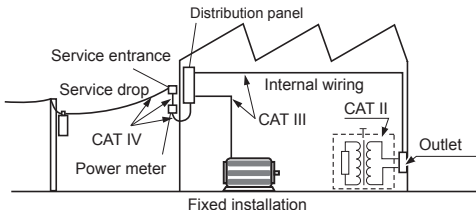

Operating Precautions

Follow these precautions to ensure safe operation and to obtain the full benefits of the various functions.

DANGER



- For your safe operation, do not connect any test lead to the primary of the distribution panel.
- Do not short-circuit two wires to be measured by bringing the test leads into contact with them. Arcs or such grave accidents are likely to occur.
- To prevent a short-circuit or an electric shock, do not touch the metal part of the connecting test lead tip.
- To prevent an electric shock, be careful to avoid shorting live lines with the test leads tip.

If the test lead or the instrument is damaged, there is a risk of an electric shock. Perform the following inspection before using them:



- Before using the instrument, check that the coating of the test leads are neither ripped nor torn and that no metal parts are exposed. Using the instrument under such conditions could result in an electric shock. Replace the test leads with those specified by our company.
 - Verify that it operates normally to ensure that no damage occurred during storage or shipping. If you find any damage, contact your authorized Hioki distributor or reseller.
-

 **WARNING**

- To prevent an electric shock, a short-circuit and damage to the instrument, observe the following precautions: Check the position of the rotary switch before taking measurements. Disconnect the test leads from the measurement object before switching the rotary switch.



- Do not use the instrument with circuits that exceed its ratings or specifications. Doing so may damage the instrument, resulting in an electric shock.



- Use only the specified test leads. Use of any test lead not specified by our company does not allow safe measurements.
- To prevent electrical accidents, remove power from the circuit before connecting the test leads.
- To prevent an electric shock, do not exceed the lower of the ratings shown on the instrument and test leads.

CAUTION

Observe the following to prevent an electric shock, a short-circuit, or damage to the instrument.

- Turn off any disconnecter devices and separate from the power conditioner before starting the measurements for the solar battery panel.
- Solar batteries always generate high voltages especially in day time. Pay attention to prevent an electric shock for measurements.
- Do not touch any metal parts such as connection box and disconnecter devices directly with bare hands. Doing so may cause an electric shock due to the voltage of the generator.
- Maximum rated voltage to terminal of the instrument is 1000 V DC. Do not use the instrument for equipment with rated voltage over 1000 V DC. Doing so may cause an electric shock or damage to the instrument.
- The cable is hardened in freezing temperatures. Do not bend or pull it to avoid tearing its shield or cutting cable.
- The protection rating for the enclosure of this instrument (based on EN60529) is IP40*.



* IP40:

This indicates the degree of protection provided by the enclosure of the instrument for use in hazardous locations, entry of solid foreign objects, and the ingress of water.

- 4: Protected against access to hazardous parts with wire measuring 1.0mm in diameter.
- 0: The equipment inside the enclosure is not protected against the harmful effects of water.

Installing the instrument

WARNING

Installing the instrument in inappropriate locations may cause a malfunction of instrument or may give rise to an accident. Avoid the following locations.



- Exposed to direct sunlight or high temperature
- Exposed to corrosive or combustible gases
- Exposed to a strong electromagnetic field or electrostatic charge
- Near induction heating systems (such as high-frequency induction heating systems and IH cooking equipment)
- Susceptible to vibration
- Exposed to water, oil, chemicals, or solvents
- Exposed to high humidity or condensation
- Exposed to high quantities of dust particles

Precautions when transporting the instrument

During shipment of the instrument, handle it carefully so that it is not damaged due to a vibration or shock.

Handling the Instrument

CAUTION



To avoid damage to the instrument, protect it from physical shock when transporting and handling it. Be especially careful to avoid physical shock from due to dropping it.

Test leads

CAUTION



- Removable sleeves are attached to the metal pins at the end of the test leads. To prevent a short-circuit accident, be sure to use the test leads with the sleeves attached when performing measurements in the CAT III measurement category. Remove the sleeves before starting CAT II circuit measurements. You can use the test leads with the sleeve removed for secondary side of the circuit breakers turned off. (Refer to “Measurement Categories” (p.7))
- If the sleeves are inadvertently removed during measurement, stop the measurement.(p.26)

1.1 Product Overview

This is a measuring instrument to test faults of bypass diodes (BPD) incorporated in solar power generation systems*.

Can be measured even in day time

- Bypass diode condition can be measured without covering the solar panels.

Easy measurements

- Bypass diode condition can be measured with a connection box.
- Measurement results can be sent to a tablet or other mobile device by Bluetooth®.

Detecting bypass diode deterioration

- The resistance of the bypass route can be measured and deterioration of the bypass diode or increase of connector contact resistance between modules can be detected.

*: Strings in parallel configuration or special complex configuration cannot be measured.

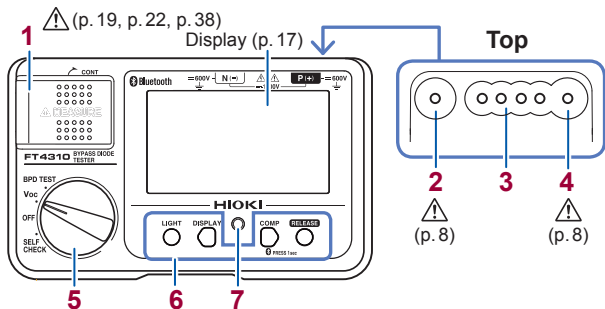

1.2 Names and Functions of Parts

Front



1 MEASURE key (p. 15)	Measurement switch
2 N(-) terminal	Connect the black test lead.
3 Control terminal	Connect Model L9788-10 Test Lead with Remote Switch (Red).
4 P(+) terminal	Connect Model L9788-10 Test Lead with Remote Switch (Red).
5 Rotary switch (p. 15)	Selects the measurement functions (the measurement modes) and turns off the power. (p. 15)
6 Operation keys (p. 16)	
7 Live circuit indicator	Flashes when voltage remains between measuring terminals.



MEASURE key

MEASURE key states			
	Raise the key	Press the right of the key	Retract the key
Description in this manual	Turn on comparison display or enable continuous measurement.	Press the MEASURE key.	Release the MEASURE key.

1

Changing measurement mode (turning on the power)

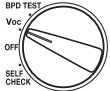
Setting the rotary switch in a position other than OFF turns on the power.

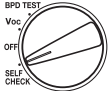
Rotary switch state	Voc mode	BPD TEST mode	Self-check mode
			
Description in this manual	Set the rotary switch in Voc.	Set the rotary switch in BPD TEST.	Set the rotary switch in SELF CHECK.

Voc mode: Measures open-circuit voltages. (p. 34)

BPD TEST mode: Measures bypass diodes and bypass diode resistors.
(p. 38)

Turning off the power

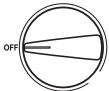
Rotary switch state	
Description in this manual	Set off the rotary switch in OFF.

Operation keys

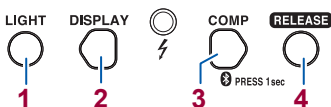

Key name	Press	Press and hold (1 second or more)	Turn on the instrument while holding down
1 LIGHT		Turns off the auto-backlight function	Cancel the auto power save function
2 DISPLAY	<ul style="list-style-type: none"> In BPD TEST mode: Switches between the measurement screen and the COUNT mode screen When comparator is set: Decrease of judgment reference value (p. 32) 	<ul style="list-style-type: none"> When comparison display is set: Reference value reset (p. 35) COUNT mode screen: Count reset (p. 51) 	-
3 COMP Bluetooth	<ul style="list-style-type: none"> In Voc or BPD TEST mode: Moves to comparator setting screen. (p. 32) When comparator is set: Increase of judgment reference value (p. 32) 	Bluetooth® communication On/Off (p. 43)	-
4 RELEASE	<ul style="list-style-type: none"> In BPD TEST mode/ self-check mode: Unlock In locked state, RELEASE key flashes. (p. 39) 	-	Turns on the power in self-check mode. Indicates the number of capacitor discharges.

Display

Open-circuit voltage value (Voc mode, (p. 34)) or bypass route resistance (R_{BPR})

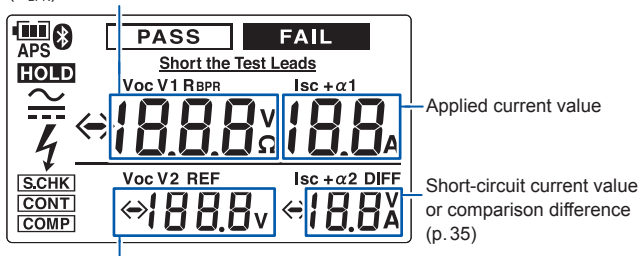

Open-circuit voltage value (BPD TEST mode) or reference value (REF, (p. 35))

	Battery indicator (four levels) (p.28)
	Appears when measured voltage is DC.
	Flashes when measured voltage is AC.
	Flashes when the measured value is less than the minimum display value.
	Flashes when the measured value is greater than the maximum display value.
HOLD	Appears when the measured value is retained. (p. 36)
PASS	Appears when BPD TEST is PASS (good). (p. 40) Appears when the judgment is PASS (good) with comparator function. (p.31)
FAIL	Appears when BPD TEST is FAIL (defective). (p.40) Appears when the judgment is FAIL (defective) with comparator function. (p. 31)
	Flashes during measurement in BPD TEST mode.
APS	The auto power save function will activate 30 seconds after this mark starts flashing. (p. 29)



Displays Bluetooth® function state. (p. 43)

- On: Bluetooth® function On
- Off: Bluetooth® function Off
- Flashes: Bluetooth® communication active

S.CHK

Appears while in self-check mode.

CONT

Appears while in continuous measurement. (p. 15) (p. 35)

COMP

Appears when the comparator function is enabled. (p. 31)

REF

Reference value for comparison display measurement in Voc mode. (p. 35)

DIFF

Difference between reference value and measured value for comparison display measurement in Voc mode. (p. 35)

R_{BPR}

Bypass route resistance

Voc

Open-circuit voltage value (p. 34)

I_{sc}

Short-circuit current value

I_{sc} + α1 Applied current value

Short the Test Leads

Short the test lead when this mark appears during the self-check.

Model L9788-10 Test Lead with Remote Switch (Red)

CAUTION



The **MEASURE** key of the instrument is enabled even when the L9788-10 is connected to the instrument. Note that the testing voltage is output when the **MEASURE** key of the instrument is pressed while the L9788-10 is connected.

Refer to the L9788-92 Breaker Pin Connection (p. 25)

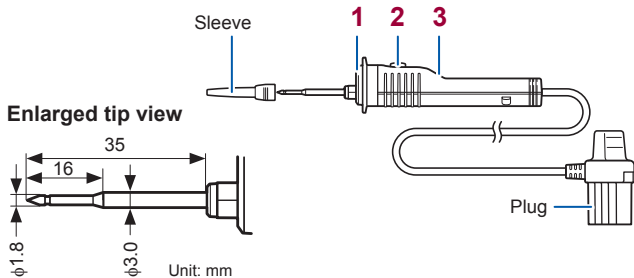

1 Light

Lights up interlocked with the backlight of the instrument.

2 **MEASURE** key

Measurement switch

- Press: Press the **MEASURE** key.
- Press and hold: Turns on the comparison display or enables continuous measurement.
(This operation cannot be performed if the instrument's **MEASURE** key is in the raised position.)
- Lights up in red interlocked with the live wire warning indicator of the instrument.

3 Judgment display LED

Lights up in accordance with the BPD TEST or comparator judgment result.

- PASS: Green
- FAIL: Red

2

Preparing for Measurement

1 Insert the batteries. (p.22)

2 Connect the test leads to the terminals.

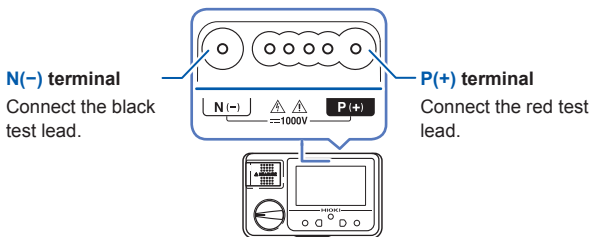

2

2.1 Battery Replacement

WARNING



Do not short-circuit, recharge, disassemble or dispose of in fire. Battery may explode if mistreated.



- To prevent an electric shock, release the **MEASURE** key, disconnect the test leads from the measurement object and replace the batteries.
- After replacing the batteries, reattach the cover and secure the screw before using the instrument.
- To prevent instrument damage or an electric shock, use only the screw for securing the battery cover in place that are originally installed. If you have lost a screw or find that a screw is damaged, please contact your authorized Hioki distributor for a replacement.

CAUTION

Poor performance or damage from battery leakage could result. Observe the cautions listed below.



- Do not mix new and old batteries, or different types of batteries.
- Be careful to observe the battery polarity during installation.
- Do not use batteries after their recommended expiry date.
- Do not leave depleted batteries inside the instrument.
- Replace batteries only with the specified type.

- The battery indicator flashes when the remaining battery capacity is low. In this case, measurement is not possible. Replace the batteries. (p.28)
- Handle and dispose of batteries in accordance with local regulations.

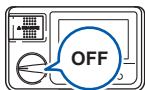

1 Set the rotary switch in OFF. Disconnect the test leads from the instrument.

2

Battery (LR6 × 6)
Check the polarity.

2 Loosen the fastening screw at the rear of the instrument and remove the battery cover.

3 Replace all six batteries.

4 Slide the battery cover back into place and tighten the screw.

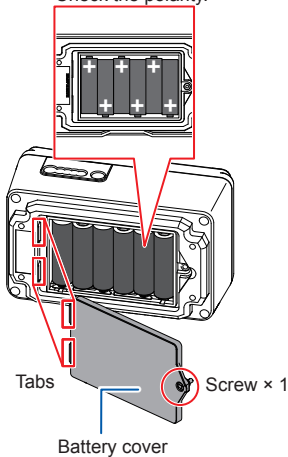

2.2 Using Model L9788-10 Test Lead with Remote Switch (Red)

Pre-measurement Inspection

- 1 Set the rotary switch in OFF.
- 2 Fully insert the plug of L9788-10 into terminal P(+) of the instrument.



- 3 Set the rotary switch in SELF CHECK.
- 4 Press the **RELEASE** key to cancel the lock function.
- 5 After [**Short the Test Leads**] is shown on the display, short the test lead tips with each other.
- 6 Press the **MEASURE** key of the L9788-10. Verify that the display indicates [**PASS**].



- 7 Press **LIGHT**.

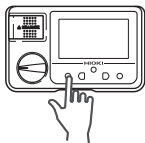

Check that the L9788-10 tip lamp lights up.



Replacing the Tip Pin (optional) for Model L9788-10

When the tip pin (L9788-90) of model L9788-10 Test Lead with Remote Switch (Red) is worn out or broken, it can be replaced. The tip pin can be purchased via authorized Hioki distributor or reseller.

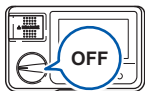

- 1 Set the rotary switch in OFF and disconnect the L9788-10.**

2

- 2 Remove the tip pin by rotating with a wrench.**

- 3 Attach the new tip pin to the L9788-10 by rotating with a wrench.**

(Tightening torque: 0.3N·m)

- 4 Check the operation.**

Measure a measurement object of known values and use after checking that the resistance is correct.

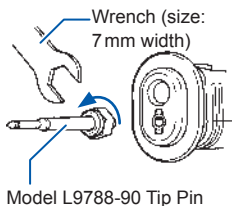

Attaching the L9788-92 Breaker Pin

Remove the sleeve of the L9788-10 (p.26) and attach the breaker pin.

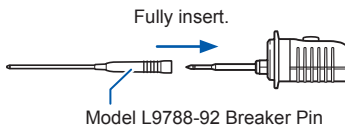

Removing and attaching the test lead sleeves

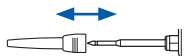

Safely store the removed sleeves so as not to lose them. (p. 12)

Removing the sleeves	Attaching the sleeves
Gently hold the bottom of the sleeves and pull the sleeves off.	Insert the metal pins of the test leads into the holes of the sleeves, and firmly push them all the way in.

2.3 How to Use the Carrying Case (Model C0206)

CAUTION



Attach the strap securely to the four fittings on the carrying case. If insecurely attached, the instrument may fall and be damaged when carrying.

Housing

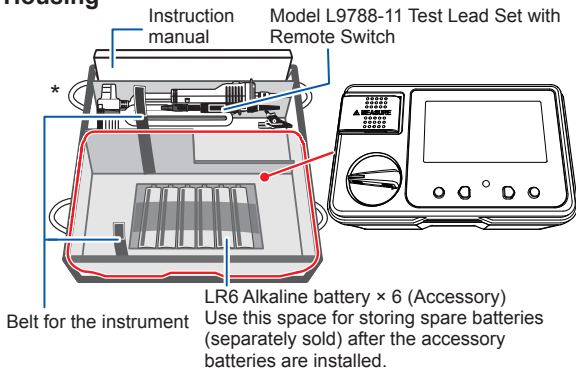

* Secure the strap at 4 positions.

3

Measurement

WARNING



Be sure to perform the self-check before using the instrument. If the instrument is damaged, electric shock could result.

3.1 Pre-measurement Inspection

Before using the instrument, verify that it operates normally to ensure that no damage occurred during storage or shipping. If you find any damage, contact your authorized Hioki distributor or reseller.

Checking the test lead

Is the white portion (insulation layer) inside the cable exposed?



Not Exposed

Exposed



Do not use any damaged cables and replace them with those specified by our company. This may cause an electric shock.

Checking the instrument

1. Set the rotary switch in SELF CHECK.
2. Press the **RELEASE** key to release the lock function.
3. Short the test lead tips.
4. Is **[PASS]** displayed when the **MEASURE** key is pressed?



Displayed
(Go on to the following page)

Not displayed



The following issues may be occurring:

- The test lead has not been inserted all the way.
→Insert the test lead all the way in.
- There is a broken connection in the test lead.
→Replace them with those specified by our company.
- Error is displayed.
→The instrument may have failed. (p.61)



From the previous page

Checking the remaining battery charge

Is the battery level adequate?

Set the rotary switch in SELF CHECK and confirm the battery indicator.

Flashes



Replace the batteries. (p. 22)



 appears

Inspection complete

Please read “Operating Precautions” (p. 8) before use.

3.2 Auto Power Save (Power-Saving Function)

When the rotary switch is not set in the OFF position, the instrument changes to the auto power save state 15 minutes after the last operation or live wire warning indication.

After use, set the rotary switch in OFF. The auto power save feature consumes a small amount of current.

Disabling the function

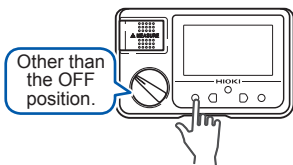

Turn on the instrument while holding down .

Recovering from auto power save state

Set the rotary switch in OFF and then put it back into place.

3.3 Auto Backlight-off (Automatic Light-off Function)

The backlight of the instrument will automatically turn off after approx. 3 minutes has passed since the last operation.

The automatic light-off function can be canceled when working continuously in a dark location.

Disabling the function

Backlight: Off

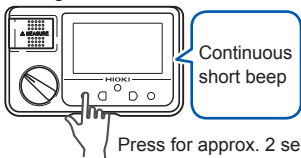

Press for approx. 2 seconds.

With the backlight off, press
LIGHT
○ for approx. 2 seconds
until the instrument beeps
continuously.

Setting the rotary switch in OFF cancels the disabled state.

3.4 Pass/Fail Judgment (Comparator) Function

This function compares the measured value with the preset value (= judgment reference value) and judges whether the result is PASS (good) or FAIL (defective).

Comparator settings for each mode pass/fail judgment (comparator) will be saved, even if the rotary switch is set in OFF.

The range that can be set for the reference value is as follows:





DIFF

0 V to ± 20 V. The setting allows 1 V increments.

R_{BPR}

0 Ω to 15 Ω . The setting allows 0.5 Ω increments.

Indication lights up

	PASS (good) judgment		FAIL (defective) judgment	
Indication				
	Backlight: No change	Lights up in green	Backlight: Lights up in red	Lights up in red

Type of measurements that can be judged

Mode	PASS judgment		FAIL judgment	
	State of measured value	Buzzer	Backlight	Buzzer
Voc	Reference value or lower	Short beep	Lights up in red	Long beep
BPD TEST	Lower than reference value and bypass diode is working correctly			

Setting the Comparator Function

- 1 Set the rotary switch in the mode for which you wish to set the comparator function.

In BPD TEST mode, press  to cancel the lock function. (p. 39)

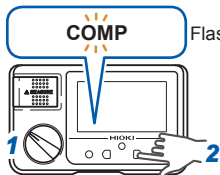

- 2 Press .

[COMP] flashes and a value set as judgment reference value at that moment is displayed.

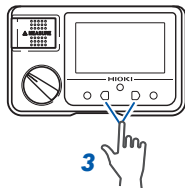

- 3 Press  or  to set the reference value.

If you do nothing about 2 seconds after you set the reference value, the comparator function will be set, and [COMP] will appear.

Canceling the Comparator Function

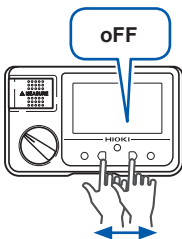

- Press  or  several times to select [oFF].

If you do nothing for about 2 seconds after you select, [COMP] will go out, and the comparator function will be canceled.

3.5 Measurement Preparation

- 1** Turn off the main switch of the connection box to be disconnected from the power conditioner.
- 2** Turn off all the disconnecter devices of the strings.
- 3** Disconnect lightning arresters from the measuring circuit.
Disconnection is not required for the figure (solar generator facility) shown below because a lightning arrester is not present at the string side of the disconnecter device.

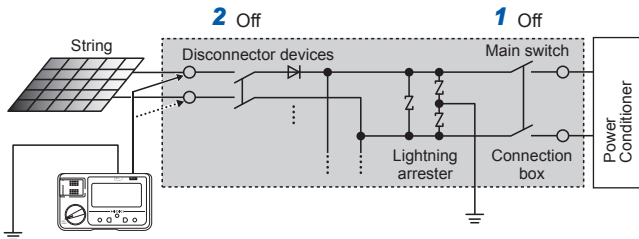

(Example: Solar generator facility)

3.6 Making Measurements in Voc Mode

Open-circuit voltage of a string can be measured. Checking the difference between strings allows determining short-circuit fault.

WARNING



During measurement, do not switch over to other measurement modes.

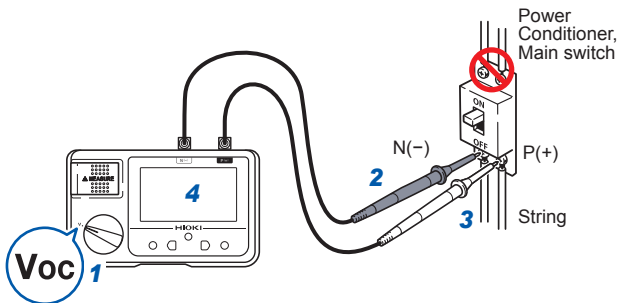

- 1** Set the rotary switch in Voc.
- 2** Connect the black test lead to N(-) of the measurement object.
- 3** Connect the red test lead to P(+) of the measurement object.
- 4** Check the displayed value.
[Voc] shows the measured value (open-circuit voltage value).

Comparison Display Function

You can check the difference between the reference value and the measured value while measuring the open-circuit voltage of solar battery string.

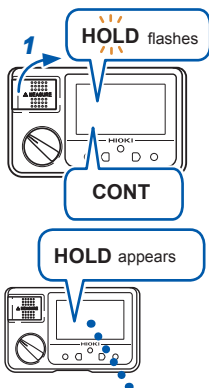

- 1 Raise the **MEASURE** key of the instrument or press and hold the **MEASURE** key of the L9788-10. **[HOLD]** flashes and **[CONT]** appears.

- 2 Connect the test lead to the measurement object. **[HOLD]** appears and **[Voc]** and **[REF]** show their measured values.



Example measurement results display

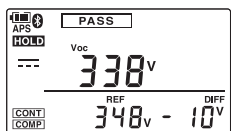

Example measurement results display

Voc=338 V, REF=348 V,
DIFF= -10 V

- 3 Connect the test lead to the next measurement object. **[Voc]** shows the measured value and **[DIFF]** shows the difference with the **[REF]** (the reference value). When the comparator function is enabled, **[PASS]** or **[FAIL]** is displayed.

To reset the reference value, press and hold the **DISPLAY** key.

Auto-hold

With the comparison display function, when the measured value stabilizes, a short beep is emitted and the measured value is automatically retained.

When the measured value is 20 V or higher and stabilizes for approx. 1 second (fluctuation range is within 20 V), the measured value is automatically retained.

When the test leads are disconnected from the measurement object and a new measurement is started, the new measured value is retained.

[HOLD] flashes: Waiting for stabilization of the measured value
[HOLD] appears: The measured value is retained

Conceptual diagram of auto-hold (AC voltage)

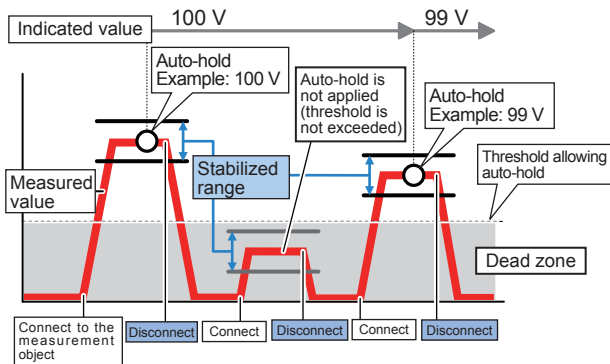

Negative Voltage Notification Function

You can check whether P(+) and N(-) are connected in reverse while measuring the open-circuit voltage of solar battery string. When the voltage is -1 V or lower, red and white of the backlight flash alternately.

Ground Fault Detection

Connecting the black test lead to the ground and red test lead to N(-) or P(+) of the measurement object and measuring the voltage allows a simple ground fault detection.

3.7 Making Measurements in BPD TEST Mode

To determine open fault and deterioration of bypass diodes connected to a solar panel, measure the bypass diode and bypass route resistance.

WARNING

Observe the following to prevent an electric shock, short-circuit, or damage to the instrument.

- **Do not measure under a live circuit condition.** Doing so could damage the instrument or cause an accident that might result in injury or death. Always turn off power to the measurement object before starting.
- **When measuring a bypass diode, dangerous voltage is applied to the measurement terminals.** To prevent an electric shock, do not touch the test leads.



- Press the **MEASURE** key fully down until a live circuit indicator lights up. If the button is not pressed down fully, a proper measurement cannot be made.
- After use, set the rotary switch in OFF.

Lock Function

This function is used to avoid applying a measuring signal to equipment. This function will prevent the test from starting even if the rotary switch is set in BPD TEST and the **MEASURE** key is pressed.

Canceling the lock function



- 1 Set the rotary switch in BPD TEST.**
RELEASE key flashes.

3

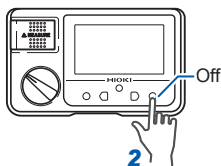

- 2 Press**  .
Pressing this key unlocks the instrument and switches the display to the measurement screen.

The screen is locked 1 minute after the last measurement or operation again.

Measuring Bypass Diode

CAUTION



To avoid electrical accidents, disconnect the solar battery module from the commercial power circuit before measuring.

Clusters with breakdown voltage 100 V or lower cannot be judged correctly.

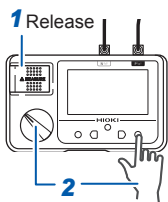

1 Release the **MEASURE** key.

2 Set the rotary switch in BPD TEST.

Press  to cancel the lock function.(p. 39)

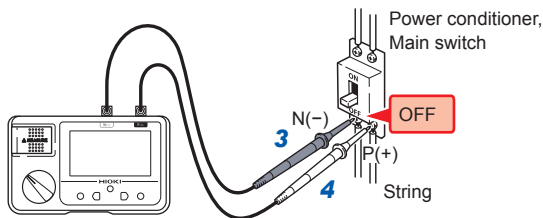

3 Connect the black test lead to N(-) of the measurement object.

4 Connect the red test lead to P(+) of the measurement object.

If the measurement object has an AC voltage or its polarity is reversed, red and white flash alternately on the backlight.

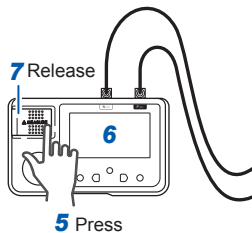

- 5 Press the MEASURE key.**
Starts a measurement.
To make a continuous measurement, raise the **MEASURE** key.
- 6 Check the judgment and displayed values.**

- 7 Release the MEASURE key with the test leads connected to the measurement object.**
Ends the measurement.

- During measurement, do not switch over to other modes.
- The screen is locked 1 minute after the last measurement. To continue the measurement, release the lock function. (p. 39)
- If negative voltage notification function is engaged, no measurement starts. Verify the test lead connections once again.
- If the solar panel is not generating power due to the shielding of the light, continuous measurement and negative voltage notification functions will not be activated.
- The R_{BPR} value will flash if the insolation varies during measurement (for example, due to the movement of clouds). In this case, it will not be possible to accurately measure the bypass route resistance. Repeat measurement under conditions of consistent insolation

Press the **MEASURE** key once per string for measurements. If the result is FAIL, verify the test lead connections once again.

- 8 Measure all strings.**
Repeat the above procedure from 3 to 7.

After measurements are completed

- 1** Reconnect the lightning arrester connection if disconnected.
- 2** Turn on all the disconnecter devices of the strings.
- 3** Turn on the main switch of the connection box.

3.8 Bluetooth® Communication Function

The instrument supports Bluetooth® low energy.

When the Bluetooth® function is enabled, you can review measurement data and create measurement reports on mobile devices (iPhone, iPad, iPad mini, iPod Touch, and Android™ devices).

For more information about this functionality, see the help function in the application software GENNECT Cross.

3

- 1 Install the GENNECT Cross on your mobile device. (p.44)**



- 2 Enable the Bluetooth® function on the instrument.**



Bluetooth PRESS 1sec

- 3 Launch GENNECT Cross and pair it with the instrument. (p.45)**

- 4 Select the general measurement function of GENNECT Cross and make measurements.**



Installing the Smartphone Application Software GENNECT Cross

Search for “GENNECT Cross” on the App Store from your iPhone, iPad or other Apple devices, or on Google Play™ from your Android device. Then download and install the GENNECT Cross. You will need an Apple ID to download the app from the App Store, or a Google account to download the app from Google Play. For more information about how to register an account, contact the store at which you purchased your device.



- Because the instrument emits radio waves, use in a country or region where it has not been approved may be subject to fines or other penalties as a violation of applicable laws or regulations. For more information, see the attached “Precautions Concerning Use of Equipment that Emits Radio Waves” or go to our website.
- The availability of the instrument is limited to certain countries. For more information, contact your authorized Hioki distributor or reseller.
- Bluetooth® communications range varies greatly with distance from obstructions (walls, metal obstruction, etc.) as well as distance from the floor or ground. To ensure stable measurement, verify adequate signal strength.
- Although this application software is provided free of charge, downloading or use of the application software may incur Internet connection charges. Such charges are the sole responsibility of the user.
- This application software is not guaranteed to operate on all mobile devices.

Pairing the Application Software

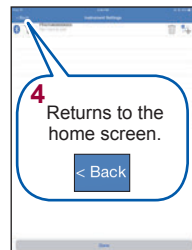
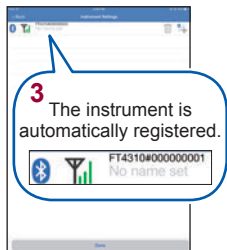
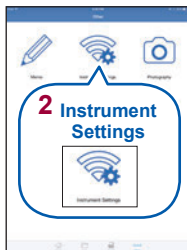

- When the application software is launched for the first time (before being paired with any instrument), the connection setup screen will be displayed.
- While the mobile device is displaying the connection setup screen, simply move it close to the instrument to automatically pair it with the instrument (the application software can be paired with up to 8 instruments).
- Allow about 5 to 30 seconds for the instrument to pair with the application software after being turned on. If the instrument fails to pair within 1 minute, relaunch GENNECT Cross and cycle the instrument's power.
- Pairing will be skipped when the instrument is started next time after the instrument has registered.

3

Making Measurements with the Bluetooth® Function

On the home screen, select the standard measurement function from the options, standard measurement, logging or waveform display, to start a measurement. For more information about each function, see the help function in the GENNECT Cross.

The values displayed by the instrument may be different from the values displayed by the application software due to communication delays or differences in the update timing.

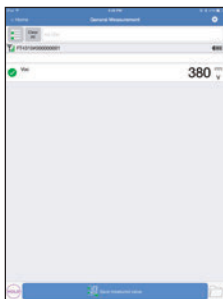

Standard measurement

Measured values of multiple channels are saved.

4

Specifications

4.1 General Specifications

4

Operating environment	Indoors, outdoors, Pollution Degree 2, altitude up to 2000 m (6562 ft.)
Operating temperature and humidity	<p>Temperature: -10°C (14°F) to 65°C (149°F)</p> <p>Humidity:</p> <p>less than 40°C (104°F), 80% RH or less (no condensation)</p> <p>40°C (104°F) or higher but less than 45°C (113°F), 60% RH or less (no condensation)</p> <p>45°C (113°F) or higher but less than 50°C (122°F), 50% RH or less (no condensation)</p> <p>50°C (122°F) or higher but less than 55°C (131°F), 40% RH or less (no condensation)</p> <p>55°C (131°F) or higher but less than 60°C (140°F), 30% RH or less (no condensation)</p> <p>60°C (140°F) to 65°C (149°F), 25% RH or less (no condensation)</p>
Storage temperature and humidity	<p>-20°C (-4°F) to 65°C (149°F), 80% RH or less (no condensation)</p>
Dustproofness and waterproofness	IP40 (EN 60529)
Drop proof	On concrete: 1 m
Standards	<p>Safety: EN61010</p> <p>EMC: EN61326</p>
Power supply	<p>LR6 Alkaline battery \times 6</p> <p>Rated supply voltage: 1.5 V DC \times 6</p> <p>Power supply voltage range: 6.75 V to 10.35 V DC</p> <p>Maximum rated power: 18 VA</p>

Continuous operating time (Voc)	When LR6 alkaline battery × 6 are used (at 23°C, as a referential) Approx. 45 hours (Comparator, LCD backlight, Bluetooth®: Off) Approx. 18 hours (Comparator, LCD backlight, Bluetooth®: On)
Possible number of measurements (BPD TEST)	LR6 Alkaline battery × 6 (at 23°C, as a referential) Approx. 3000 times (Comparator, LCD backlight, Bluetooth®: Off)
Interface	Bluetooth®
Dimensions	Approx. 152W × 92H × 69D mm (5.98"W × 3.62"H × 2.72"D)
Mass	Approx. 650 g (22.9 oz.) (including batteries, excluding test leads)
Product warranty period	3 years
Fuse	3 A/1000 V fuse to protect from IGBT short-circuit fault (Cut-off capacity 30 kA, fast acting, φ10 × 38 mm: SIBA GmbH) Note: Replacement by user not allowed
Accessories	Refer to "Verifying Package Contents" (p. 1)
Options	Refer to "Options" (p. 2)

4.2 Input/Output/Measurement Specifications

Standard Specifications

Measurement function	Abbreviation	Measurement function
	Voc	Open-circuit voltage measurement
	BPD TEST	Bypass diode measurement
	SELF CHECK	Self-check
Function configuration	SELF CHECK/OFF/Voc/BPD TEST	
Input terminal	P(+) terminal: Connected to positive terminal of PV string N(-) terminal: Connected to negative terminal of PV string	
Maximum input voltage	1000 V DC	
Maximum rated voltage to earth	600 V DC (No measurement category)	

(1) Voc mode

Measurement item	Open-circuit voltage
Displayed item	Open-circuit voltage (Reference value and comparison value when comparison display is enabled)
Measurement range	0 V to 1000 V DC (Displayed up to 1200 V DC)
Response time	Within 1 sec.

Comparison display	<p>Displays the difference from the measurement voltage with the auto-hold enabled for the first time or immediately after reset. Valid only in the auto-hold state. Displayed range: -100 V to 100 V Maximum count: 100 counts Overrange display: [>100 V] or [<-100 V] is displayed.</p>
Auto-hold	<p>Setting method: Enable by placing the instrument's MEASURE key in the raised position or press and hold the MEASURE key on a test-lead with remote switch.</p> <hr/> <p>Functionality: When both the below conditions are met, measured value is automatically held.</p> <ul style="list-style-type: none"> • Measurement voltage: 20 V or higher • Fluctuation range of measurement voltage for 1 second: 20 V or less <p>Auto-hold update: A signal meeting the above Auto-hold conditions is input after a measurement voltage less than 20 V is input.</p>

(2) BPD TEST mode

Measurement item	<p>Bypass diode comparator judgment/Bypass route resistor/Open-circuit voltage/Short-circuit current/ Applied current</p>
Displayed item	<p>Screen 1: Bypass route resistor, open-circuit voltage, short-circuit current, and applied current Screen 2: The number of bypass diode measurements</p>
Measurement object	<p>Open-circuit voltage: 1000 V DC or less Rated current: 2 A to 12 A DC Crystal system string (Strings with a breakdown voltage of 100 V DC or less cannot be measured.)</p>
Measurement method	<p>Short-circuit and pulse voltage application</p>

Duration of shorting between terminals	10 ms or less
Output pulse	Voltage: 100 V DC or less Pulse width: 5 ms or less Limiting current: Measured short-circuit current + 1 A or less Maximum: 13 A
Judgment method	Detected peak current \geq Measured short-circuit current + additional current \times 0.8: PASS Detected peak current $<$ Measured short-circuit current + additional current \times 0.8: FAIL R_{BPR} condition can be added to the conditions above with comparator setting.
Measurement time	2 seconds or less (3 seconds or less when measurement voltage is 10 V or less)
Current measurement method	Peak value detection
Measuring range for bypass route resistance	0 Ω to 15 Ω The R_{BPR} value will flash if insulation (short-circuit current) varies during measurement.

(3) COUNT mode

Measurement item	Displays the number of bypass diode measurements
Number of measurements	Counts the number of measurements from power on to power off. Resets the count to 0 when the power is turned off or auto power save. Maximum count: 199 More than 200 counts: [>199 V] flashes

(4) SELF CHECK mode

Measurement item	IGBT and capacitor discharge switch tests	
Capacitor discharge switch: Short-circuit	Tests that capacitor discharge switch is not short-circuited. Fail: [Err5] is displayed.	
IGBT: Short-circuit	Tests that IGBT is not short-circuited. Fail: [Err4] or [oPn] is displayed.	

Accuracy specifications

Conditions of guaranteed accuracy	Guaranteed accuracy period	1 year
	Guaranteed accuracy period from adjustment made by Hioki	1 year
	Temperature and humidity for guaranteed accuracy	23°C±5°C (73°F±9°F), 80% RH or less
	Power voltage range with accuracy guarantee	6.4 V to 10.35 V DC (One or more battery levels appear)
	Temperature characteristic	Measurement accuracy × 0.1/°C is added (other than 23°C±5°C).

(1) Open-circuit voltage measurement

Range (displayed range)	1000 V (0 V to ±1200 V)
Accuracy range	0 V to ±1000V
Accuracy	±0.2% rdg.±3 dgt.
Input impedance	1 MΩ or higher
Maximum count	1200 counts
Overrange display	[>1200 V] or [<-1200 V] is displayed.

(2) Short-circuit current measurement

Range (displayed range)	15.0 A (0.0 A to 15.0 A)
Accuracy range	0.0 A to 15.0 A
Accuracy	$\pm 3\%$ rdg. ± 3 dgt.
Input impedance	0.5 Ω or lower
Maximum count	150 counts (The short-circuit current display will flash if the value is greater than 13.0 A but less than or equal to 15.0 A.)
Overrange display	[>15.0 A] or [<0.0 A] is displayed.

(3) Bypass route resistance measurement

Range (displayed range)	15 Ω (0.0 Ω to 15.0 Ω)
Accuracy range	0.0 Ω to 15.0 Ω
Accuracy	$\pm 5\%$ rdg. ± 5 dgt.
Maximum count	150 counts
Overrange display	[>15.0 Ω] is displayed.
Conditions of guaranteed accuracy	During pure resistance measurement after the self-check has been performed Accuracy is not guaranteed while the bypass route resistance display is flashing.

4.3 Function Specifications

Key input	Refer to “ MEASURE key” (p. 15), “Operation keys” (p. 16), and “Model L9788-10 Test Lead with Remote Switch (Red)” (p. 19)	
Auto power save (APS)	Automatically turns off the power 15 minutes±1 minutes after the last measurement (measurement voltage is 5 V or less for Voc mode) with the power on. Recovering from auto power save: Set the rotary switch in OFF to turn off the power and then turn on the power once again.	
Indication	Semi-transmissive FSTN LCD, positive Refer to “Display” (p. 17)	
Battery indicator	Battery voltage	Battery level
	7.95 V±0.2 V or higher	3
	7.35 V±0.2 V to 7.95 V±0.2 V	2
	6.75 V±0.2 V to 7.35 V±0.2V	1
	6.75 V±0.2 V or less	0 (Battery shape flashes)
<ul style="list-style-type: none"> • Hysteresis Low battery level remains even if battery voltage increases but the power is not turned on once again. • Measurements cannot be carried out when battery level is 0. ([bAt Lo] is displayed and automatically turns off the power.) 		

Live circuit indicator	<ul style="list-style-type: none"> • Voc mode, SELF CHECK +20 V DC or higher or -1 V DC or less: Flashes Other than the above: Off • BPD TEST mode MEASURE key is pressed: Lights up MEASURE key is released: +20 V DC or higher or -1 V DC or less: Flashes Other than the above: Off
Backlight	<p>White</p> <p>Automatic light-off function available (The backlight will turn off 3 minutes \pm30 seconds after the last measurement (or in Voc mode, after the measured voltage falls to 5 V or less) or after the last operation.)</p>
Automatic polarity judgment function	<p>When measurement voltage is -1 V or less:</p> <ul style="list-style-type: none"> • Buzzer sounds, red backlight flashes, and white backlight lights up. • Auto-hold is disabled. • Bypass diode measurement does not start. <p>When measurement voltage is 70 V_{0-P} AC or higher:</p> <ul style="list-style-type: none"> • Bypass diode measurement does not start. • Buzzer sounds and red backlight lights up. <p>When measurement voltage is over -1 V to 10 V, and when output pulse with limiting current of 0.1 A or less is generated and measurement voltage is 90 V or higher:</p> <ul style="list-style-type: none"> • Bypass diode measurement does not start. • Buzzer sounds and red backlight lights up.

Comparator

- Voc
Threshold value can be set in 1 V increments from 0 V to 20 V for the absolute value of Voc diff.
Voc diff \geq Threshold value: FAIL
Voc diff $<$ Threshold value: PASS
 - BPD TEST mode
Threshold value can be set in 0.5 Ω increments from 0 Ω to 15 Ω for R_{BPR} .
 $R_{BPR} \geq$ Threshold value: FAIL
 $R_{BPR} <$ Threshold value, and
Detected peak current $<$ Measured short-circuit current + additional current \times 0.8: FAIL
Detected peak current \geq Measured short-circuit current + additional current \times 0.8: PASS
Judgment is available only when the auto-hold is enabled.
-

4.4 Interface Specifications

Interface	Bluetooth® 4.0LE ( Bluetooth®)
Antenna power	Maximum +0 dBm (1 mW)
Communication distance	5 m (line of sight)
Communication profile	GATT (Generic Attribute Profile)
Supported Android devices	Android4.3 or later (Bluetooth® low energy enabled devices)
Supported iOS devices	iOS10 or later (Bluetooth® low energy enabled devices)

4.5 Factory Settings

	Settings state	Setting backup
Auto power save	Enabled	N/A
Comparator	Enabled Voc diff: 10 V R_{BPR} : 2.5 Ω	Available (On/Off, preset)
Bluetooth® setting	Enabled	Available (On/Off)

 **WARNING**

Touching any of the high-voltage points inside the instrument is very dangerous. Customers are not allowed to modify, disassemble, or repair the instrument. Doing so may cause a fire, an electric shock, or a injury.

Calibrations

The calibration period varies depending on the status of the instrument or installation environment. We recommend that the calibration period be determined in accordance with the status of the instrument or installation environment. Please contact your Hioki distributor to have your instrument periodically calibrated.

Precautions when transporting the instrument

When transporting the instrument for repair or any other purpose, be sure to observe the following precautions:

- To avoid damage to the instrument, remove the batteries from the instrument. Moreover, be sure to pack in a double carton. Damage that occurs during transportation is not covered by the warranty.
- When sending the instrument for repair, be sure to include details of the problem.

Disposal

Handle and dispose of the instrument in accordance with local regulations.

Cleaning

- To clean the instrument, wipe it gently with a soft cloth moistened with water or mild detergent.
- Wipe the LCD gently with a soft, dry cloth.
- Wipe the dust from metal parts of alligator clips with a soft cloth to avoid any impact on the measurements.

5.1 Troubleshooting

Before Returning for Repair

If damage is suspected, check the “Troubleshooting” section below before contacting your authorized Hioki distributor or reseller.

Symptom	Check Items	Remedy and Reference
Measurements cannot be performed in BPD TEST mode.	Is the function to prevent the application of voltage by mistake locked?	Release the lock function. (p. 39)
Pressing the MEASURE key in BPD TEST mode enables the lock function that has been released.	Does the battery have sufficient charge? Are you using alkaline batteries?	Replace the batteries with new alkaline batteries. (p. 22)
	Has 1 minute lapsed after the last operation?	Release the lock function again. (p. 39)
The MEASURE key of test lead with remote switch is not working.	Is the plug of the test lead with remote switch fully inserted?	Fully insert the plug to the limit without any gaps. (p. 24)
Measured value is not displayed correctly.	Is there a broken connection in a test lead?	Check the continuity of the test lead with a tester.
	Are the test leads securely connected?	Check the connection between the test leads and the instrument, and check the connection of the tips of the test leads.
The batteries run out immediately.	Are you using alkaline batteries?	Replace the batteries with alkaline batteries. (p. 22)

Symptom	Check Items	Remedy and Reference
The power is not turning on.	Does the battery have sufficient charge?	Replace the batteries with new alkaline batteries. (p. 22)
	Have the batteries been installed properly?	Install the batteries in the proper orientation. (p. 22)

Error Displays and Remedies

When an error is displayed on the LCD screen, repair is necessary. Contact your authorized Hioki distributor or reseller.

Error indication	Description	Remedy and Reference
Err 1	Zero-adjustment error (resistance value of 3 Ω or greater during the self-check)	Check whether the test lead is unplugged.
Err 2	Failure of EEPROM that holds measured data (If you encounter an EEPROM error, reset the instrument to its factory defaults.)	Turn off power and turn on the power once again.
Err 3	Corrupted adjustment data	Repair is required.
Err 4	IGBT short-circuit fault	Repair is required.
Err 5	Discharge switch short-circuit fault	Repair is required.

Err6	Discharge capacitor life (Displayed once 800,000 cycles are reached.)	Repair is required.
Err8	Bluetooth® is broken	Repair is required.
Err ACU	AC voltage input	Verify that you have connected the instrument properly.
bAt Lo	Low battery voltage	Replace the batteries. (p. 22)
Err Con	1 VΩ or greater input during the self-check	
oPn	Bypass diode is open or input is open	Check whether the test lead is connected.

Appx. 1 Measurement Principles

Measurement Principles for Bypass Diodes with an Open Fault

1 Measure a short-circuit current of a solar panel

2 Apply current to a solar panel

Applied current (I_B) = Short-circuit current (I_A) + 1 A current

- If short-circuit current (I_A) < applied current (I_B), the bypass diode is working correctly (OK).
- If short-circuit current (I_A) = applied current (I_B), the bypass diode has an open fault.

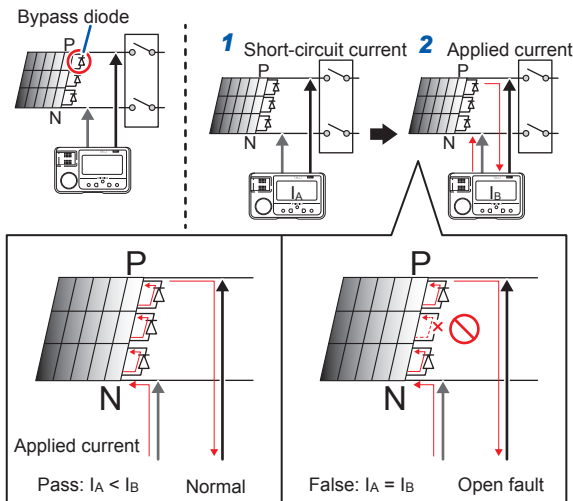

Measurement Principles for Bypass Diodes with a Short-circuit Fault

- 1** Measure an open-circuit voltage of a reference solar panel (= reference voltage)
- 2** Measure an open-circuit voltage of another solar panel (= measurement object voltage)
 - If reference voltage (V_A) = measurement object voltage (V_B), the bypass diode is working correctly (OK).
 - If reference voltage (V_A) > measurement object voltage (V_B), the bypass diode has a short-circuit fault.

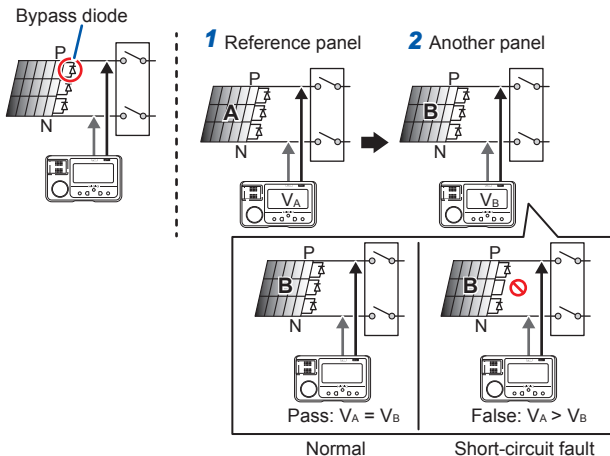

Warranty Certificate

HIOKI

Model	Serial No.	Warranty period Three (3) years from date of purchase (___ / ___)
-------	------------	--

This product passed a rigorous inspection process at Hioki before being shipped.

In the unlikely event that you experience an issue during use, please contact the distributor from which you purchased the product, which will be repaired free of charge subject to the provisions of this Warranty Certificate. This warranty is valid for a period of three (3) years from the date of purchase. If the date of purchase is unknown, the warranty is considered valid for a period of three (3) years from the product's date of manufacture. Please present this Warranty Certificate when contacting the distributor. Accuracy is guaranteed for the duration of the separately indicated guaranteed accuracy period.

- Malfunctions occurring during the warranty period under conditions of normal use in conformity with the Instruction Manual, product labeling (including stamped markings), and other precautionary information will be repaired free of charge, up to the original purchase price. Hioki reserves the right to decline to offer repair, calibration, and other services for reasons that include, but are not limited to, passage of time since the product's manufacture, discontinuation of production of parts, or unforeseen circumstances.
- Malfunctions that are determined by Hioki to have occurred under one or more of the following conditions are considered to be outside the scope of warranty coverage, even if the event in question occurs during the warranty period:
 - Damage to objects under measurement or other secondary or tertiary damage caused by use of the product or its measurement results
 - Malfunctions caused by improper handling or use of the product in a manner that does not conform with the provisions of the Instruction Manual
 - Malfunctions or damage caused by repair, adjustment, or modification of the product by a company, organization, or individual not approved by Hioki
 - Consumption of product parts, including as described in the Instruction Manual
 - Malfunctions or damage caused by transport, dropping, or other handling of the product after purchase
 - Changes in the product's appearance (scratches on its enclosure, etc.)
 - Malfunctions or damage caused by fire, wind or flood damage, earthquakes, lightning, power supply anomalies (including voltage, frequency, etc.), war or civil disturbances, radioactive contamination, or other acts of God
 - Damage caused by connecting the product to a network
 - Failure to present this Warranty Certificate
 - Failure to notify Hioki in advance if used in special embedded applications (space equipment, aviation equipment, nuclear power equipment, life-critical medical equipment or vehicle control equipment, etc.)
 - Other malfunctions for which Hioki is not deemed to be responsible

***Requests**

- Hioki is not able to reissue this Warranty Certificate, so please store it carefully.
- Please fill in the model, serial number, and date of purchase on this form.

16-01 EN

HIOKI E.E. CORPORATION

81 Koizumi, Ueda, Nagano 386-1192, Japan
TEL: +81-268-28-0555
FAX: +81-268-28-0559

- Please visit our website at www.hioki.com for the following:
 - Regional contact information
 - The latest revisions of instruction manuals and manuals in other languages.
 - Declarations of Conformity for instruments that comply with CE mark requirements.
- All reasonable care has been taken in the production of this manual, but if you find any points which are unclear or in error, please contact your supplier or the International Sales and Marketing Department at Hioki headquarters.
- In the interests of product development, the contents of this manual are subject to revision without prior notice.
- The content of this manual is protected by copyright.
No reproduction, duplication or modification of the content is permitted without the authorization of HIOKI E.E.CORPORATION.

HIOKI

HEADQUARTERS

81 Koizumi, Ueda, Nagano 386-1192, Japan
TEL +81-268-28-0562 FAX +81-268-28-0568
os-com@hioki.co.jp
(International Sales Division)

www.hioki.com

HIOKI USA CORPORATION

www.hiokiusa.com hioki@hiokiusa.com

HIOKI (Shanghai) SALES & TRADING CO., LTD.

www.hioki.cn info@hioki.com.cn

HIOKI SINGAPORE PTE.LTD.

www.hioki.com info-sg@hioki.com.sg

HIOKI KOREA CO., LTD.

www.hiokikorea.com info-kr@hioki.co.jp

HIOKI INDIA ENGINEERING PRIVATE LIMITED

www.hioki.com hioki@hioki.in

1704EN