



OF-500 OptiFiber™

Certifying OTDR

Users Manual

PN 1779484

September 2002, Rev. 3 10/04

© 2002-2004 Fluke Corporation. All rights reserved. Printed in USA.

All product names are trademarks of their respective companies.

LIMITED WARRANTY AND LIMITATION OF LIABILITY

Each Fluke Networks product is warranted to be free from defects in material and workmanship under normal use and service. The warranty period is one year and begins on the date of purchase. Parts, accessories, product repairs and services are warranted for 90 days. This warranty extends only to the original buyer or end-user customer of a Fluke Networks authorized reseller, and does not apply to disposable batteries, cable connector tabs, cable insulation-displacement connectors, or to any product which, in Fluke Networks' opinion, has been misused, altered, neglected, contaminated, or damaged by accident or abnormal conditions of operation or handling. Fluke Networks warrants that software will operate substantially in accordance with its functional specifications for 90 days and that it has been properly recorded on non-defective media. Fluke Networks does not warrant that software will be error free or operate without interruption.

Fluke Networks authorized resellers shall extend this warranty on new and unused products to end-user customers only but have no authority to extend a greater or different warranty on behalf of Fluke Networks. Warranty support is available only if product is purchased through a Fluke Networks authorized sales outlet or Buyer has paid the applicable international price. Fluke Networks reserves the right to invoice Buyer for importation costs of repair/replacement parts when product purchased in one country is submitted for repair in another country.

Fluke Networks' warranty obligation is limited, at Fluke Networks' option, to refund of the purchase price, free of charge repair, or replacement of a defective product which is returned to a Fluke Networks authorized service center within the warranty period.

To obtain warranty service, contact your nearest Fluke Networks authorized service center to obtain return authorization information, then send the product to that service center, with a description of the difficulty, postage and insurance prepaid (FOB Destination). Fluke Networks assumes no risk for damage in transit. Following warranty repair, the product will be returned to Buyer, transportation prepaid (FOB Destination). If Fluke Networks determines that failure was caused by neglect, misuse, contamination, alteration, accident or abnormal condition of operation or handling, or normal wear and tear of mechanical components, Fluke Networks will provide an estimate of repair costs and obtain authorization before commencing the work. Following repair, the product will be returned to the Buyer transportation prepaid and the Buyer will be billed for the repair and return transportation charges (FOB Shipping Point).

THIS WARRANTY IS BUYER'S SOLE AND EXCLUSIVE REMEDY AND IS IN LIEU OF ALL OTHER WARRANTIES, EXPRESS OR IMPLIED, INCLUDING BUT NOT LIMITED TO ANY IMPLIED WARRANTY OF MERCHANTABILITY OR FITNESS FOR A PARTICULAR PURPOSE. FLUKE NETWORKS SHALL NOT BE LIABLE FOR ANY SPECIAL, INDIRECT, INCIDENTAL OR CONSEQUENTIAL DAMAGES OR LOSSES, INCLUDING LOSS OF DATA, ARISING FROM ANY CAUSE OR THEORY.

Since some countries or states do not allow limitation of the term of an implied warranty, or exclusion or limitation of incidental or consequential damages, the limitations and exclusions of this warranty may not apply to every buyer. If any provision of this Warranty is held invalid or unenforceable by a court or other decision-maker of competent jurisdiction, such holding will not affect the validity or enforceability of any other provision.

6/01

Fluke Networks
PO Box 777
Everett, WA 98206-0777
USA

Table of Contents

Title	Page
Overview of Features	1
Accessing the Technical Reference Handbook	2
Registration	2
Contacting Fluke Networks	3
Unpacking	3
Model OF-500-01	3
Model OF-500-02	4
Model OF-500-10	4
Model OF-500-15	5
Model OF-500-35	6
Safety Information	7
Powering the Tester	10
Charging the Battery	10
Checking the Battery Status	10
Changing the Language	12

Removing and Installing the Module.....	12
Verifying Operation	13
Basic Features	14
Front Panel Features	14
Side and Top Panel Features	16
The HOME Screen.....	18
Using the Setup Menus.....	20
Using the Online Help.....	22
Fiber ID Options.....	22
Checking the Tester’s Status	23
Preparing to Save Tests.....	24
Cleaning and Inspecting Fiber Connectors and Adapters.....	25
Testing Your Patch Cords and Launch Fiber.....	26
Using the OTDR	26
About Launch and Receive Fibers.....	26
Selecting Auto or Manual OTDR Mode	27
OTDR Connection Quality	28
Running the OTDR Test	29
Comparing OTDR Traces.....	36
Using the ChannelMap Function	37
Using the FiberInspector Option	42
Using the Loss/Length Option.....	47
About Smart Remotes.....	47
About Setting the Reference	48
Setting the Number of Adapters and Splices	49
Using Mandrels for Testing Multimode Fiber	51
Testing in Smart Remote Mode	52
Testing in Loopback Mode.....	58

Testing in Far End Source Mode	64
Using the Power Meter Option.....	69
Overview of Memory Functions.....	72
Memory Capacity.....	72
Clearing the Internal Memory.....	73
About LinkWare and LinkWare Stats Software	73
Maintenance	73
Updating the Tester’s Software	74
Updating via the USB or Serial Port.....	75
Updating via a Memory Card Created with LinkWare	75
Optical Connector Care.....	77
Replacing Patch Cords and Launch Fibers.....	77
Replacing the Battery.....	77
Cleaning.....	78
Storage	78
Calibration.....	78
If Something Seems Wrong.....	79
Getting Help.....	79
Signs of a Bad OTDR Connector.....	82
Options and Accessories	83
Specifications	87
Environmental and Regulatory Specifications	87
OTDR Specifications	88
Power Meter Specifications: OFTM-5611, 5612, 5631, 5632	92
Power Meter Specifications: OFTM-5611, 5612, 5631, 5632 (cont.)	93
Loss/Length Specifications	94
Power	98
Traceable Calibration Period.....	98

Certifications and Compliance	98
Memory for Test Results	98
Serial Interfaces	99
Keyboard Port.....	100
Video Port for FiberInspector Probe.....	100
Dimensions (with module and battery installed).....	100
Weight (with module and battery installed).....	100
Display	100
Fan	100
FiberInspector Probe Specifications.....	101

Index

List of Figures

Figure	Title	Page
1.	Battery Pack Features.....	11
2.	Removing the Module.....	13
3.	Front Panel Features.....	14
4.	Connectors.....	16
5.	Home Screen for OTDR with Loss/Length Option	18
6.	The SETUP Screen.....	20
7.	OTDR Port Connection Quality Gauge	28
8.	Equipment for OTDR Testing	29
9.	Connecting the OTDR to Installed Fiber (no receive fiber)	31
10.	Connecting the OTDR to Installed Fiber (with receive fiber)	32
11.	Connecting the OTDR to Spooled Cable	33
12.	OTDR Trace Screen	34
13.	Equipment for ChannelMap Testing	37
14.	ChannelMap Test Connections.....	39
15.	ChannelMap Diagram Features.....	40
16.	Equipment for FiberInspector Tests	43
17.	Using the FiberInspector Probe	45

18.	FiberInspector Image Examples.....	46
19.	Example of How to Determine the NUMBER OF ADAPTERS Setting.....	50
20.	Wrapping a Patch Cord Around a Mandrel.....	51
21.	Equipment for Loss/Length Testing in Smart Remote Mode.....	52
22.	Smart Remote Mode Reference Connections.....	55
23.	Smart Remote Mode Test Connections.....	57
24.	Equipment for Loss/Length Testing in Loopback Mode.....	59
25.	Loopback Mode Reference Connections.....	61
26.	Loopback Mode Test Connections.....	63
27.	Equipment for Loss Testing in Far End Source Mode.....	64
28.	Far End Source Mode Reference Connections.....	67
29.	Far End Source Mode Test Connections.....	68
30.	Equipment for Power Meter Tests.....	69
31.	Connections for Monitoring Optical Power.....	71
32.	Traces Showing Good and Bad OTDR Connectors.....	82

List of Tables

Table	Title	Page
1.	International Electrical Symbols	7
2.	Troubleshooting the Tester	80
3.	Options	83
4.	Accessories	84
5.	RS-232 Interface Cable Connections	99
6.	9-to-25-Pin Adapter	100

OF-500 OptiFiber Certifying OTDR

Note

While this manual describes specific operating procedures for the OptiFiber tester, the fiber test methods described are provided only as guidelines. Your test methods may vary.

Overview of Features

The OF-500 OptiFiber™ Certifying OTDR (hereafter referred to as the tester) is a hand-held Optical Time Domain Reflectometer (OTDR) that locates and characterizes reflective and loss events in multimode and singlemode fibers. The tester is optimized for use on the shorter fiber runs typically installed in premises (building and campus) networks. Typical test ranges are up to 7 km at 1300 nm for multimode fiber and up to 20 km for singlemode fiber.

The tester offers the following features:

- Automated OTDR trace and event analysis help you identify and locate faults on multimode (850 nm and 1300 nm; 50 μm and 62.5 μm) and singlemode (1310 nm and 1550 nm; 9 μm) fiber.
- Displays OTDR results in summary format, as a table of events, or as an interpretive OTDR trace. PASS/FAIL results are based on factory-installed limits or limits you specify.
- ChannelMap™ function provides an intuitive diagram of the connectors and segment lengths in a channel.
- Optional FiberInspector™ Video Probe lets you inspect fiber endfaces and save the images.

- Optional modules add power meter and loss/length test set functions to the standard OTDR.
- Saves hundreds of test results on a removable memory card or in internal memory.
- Context-sensitive online help gives you quick access to operating instructions and fiber troubleshooting information.
- LinkWare™ software lets you upload test results to a PC and create professional-quality test reports. The LinkWare Stats option generates browsable, graphical reports of cable test statistics.

Accessing the Technical Reference Handbook

The OF-500 OptiFiber Technical Reference Handbook provides additional information on the tester. The handbook is available on the OptiFiber Product CD included with your tester and on the OptiFiber product page on the Fluke Networks website.

Registration

Registering your product with Fluke Networks gives you access to valuable information on product updates, troubleshooting tips, and other support services. To register, fill out the online registration form on the Fluke Networks website at www.flukenetworks.com/registration.

Contacting Fluke Networks

Note

If you contact Fluke Networks about your tester, have the tester's software and hardware version numbers available if possible.

Visit the Fluke Networks website at www.flukenetworks.com. Send email to support@flukenetworks.com.

To call us:

- Australia: 61 (2) 8850-3333 or 61 3 9329 0244
- Beijing: 86 (10) 6512-3435
- Brazil: 11 3044 1277
- Canada: 1-800-363-5853
- Europe: +44 1923 281 300
- Hong Kong: 852 2721-3228
- Japan: +81-3-3434-0181
- Korea: 82 2 539-6311
- Singapore: +65-6738-5655
- Taiwan: (886) 2-227-83199
- USA: 1-800-283-5853
- Anywhere in the world: +1-425-446-4519

Visit our website for a complete list of phone numbers.

Unpacking

The OF-500 OptiFiber packages come with the accessories listed below. If something is damaged or missing, contact the place of purchase immediately.

Model OF-500-01

- OF-500 OptiFiber tester with battery pack
- OFTM-5610 multimode OTDR module
- 62.5/125 μm multimode launch fiber, 100 m, SC/SC
- SC/SC adapter
- Carrying strap
- Memory card
- USB cable for PC communications
- AC adapter
- Users Manual
- Product Manuals CD
- LinkWare Software CD

Model OF-500-02

- OF-500 OptiFiber tester with battery pack
- OFTM-5611 multimode OTDR module with power meter option
- 62.5/125 μm multimode launch fiber, 100 m, SC/SC
- One 62.5/125 μm multimode patch cord, 2 m, SC/SC
- One 62.5/125 μm multimode patch cord, 0.3 m, SC/SC
- SC/SC adapter
- Soft protective case for tester
- Carrying strap
- Memory card
- USB cable for PC communications
- AC adapter
- Users Manual
- Product Manuals CD
- LinkWare Software CD

Model OF-500-10

- OF-500 OptiFiber tester with battery pack
- OFTM-5612 multimode OTDR module with power meter and loss/length options
- OFTM-5352 FiberInspector Video Probe (250X/400X) with adapter tip kit
- 62.5/125 μm multimode launch fiber, 100 m , SC/SC
- Two 62.5/125 μm multimode patch cords, 2 m, SC/SC
- One 62.5/125 μm multimode patch cord, 0.3 m, SC/SC
- Two gray mandrels for 62.5/125 μm fiber with 3 mm jackets
- SC/SC adapter
- Soft protective case for tester
- Carrying strap
- Soft carrying case for accessories
- Hard carrying case for tester
- Memory card
- USB memory card reader
- USB cable for PC communications
- AC adapter
- Users Manual
- Product Manuals CD
- LinkWare Software CD

Model OF-500-15

- OF-500 OptiFiber tester with battery pack
- OFTM-5612 multimode OTDR module with power meter and loss/length options
- Smart Remote with multimode fiber module
- OFTM-5352 FiberInspector Video Probe (250X/400X) with adapter tip kit
- 62.5/125 μm multimode launch fiber, 100 m , SC/SC
- Two 62.5/125 μm multimode patch cords, 2 m, SC/SC
- One 62.5/125 μm multimode patch cord, 0.3 m, SC/SC
- Two gray mandrels for 62.5/125 μm fiber with 3 mm jackets
- SC/SC adapter
- Soft protective case for tester
- OptiFiber carrying strap
- Smart Remote carrying strap
- Soft carrying case for accessories
- Hard carrying case for tester
- Memory card
- USB memory card reader
- USB cable for OptiFiber tester
- Mini-B USB cable for OptiFiber Smart Remote
- Two ac adapters
- OptiFiber Users Manual
- OptiFiber Product Manuals CD
- Smart Remote Users Manual
- Smart Remote Product CD
- LinkWare Software CD



Model OF-500-35

- OF-500 OptiFiber tester with battery pack
- OFTM-5612 multimode OTDR module with power meter and loss/length options
- OFTM-5632 singlemode OTDR module with power meter and loss/length options
- OFTM-5352 FiberInspector Video Probe (250X/400X) with adapter tip kit
- 62.5/125 μm multimode launch fiber, 100 m , SC/SC
- 9/125 μm singlemode launch fiber, 130 m , SC/SC
- Two 62.5/125 μm multimode patch cords, 2 m, SC/SC
- One 62.5/125 μm multimode patch cord, 0.3 m, SC/SC
- Two 9/125 μm singlemode patch cords, 2 m, SC/SC
- One 9/125 μm singlemode patch cord, 0.3 m, SC/SC
- Two gray mandrels for 62.5/125 μm fiber with 3 mm jackets
- SC/SC adapter
- Soft protective case for tester
- Carrying strap
- Soft carrying case for accessories
- Hard carrying case for tester
- Memory card
- USB cable for PC communications
- AC adapter
- Users Manual
- Product Manuals CD
- LinkWare Software CD

Safety Information

Table 1 shows the international electrical symbols used on the tester or in this manual.

Table 1. International Electrical Symbols

	Warning: Risk of fire, electric shock, or personal injury.
	Warning or Caution: Risk of damage or destruction to equipment or software. See explanations in the manuals.
	Warning: Class 1 laser (OUTPUT port). Risk of eye damage from hazardous radiation.

Warning

To avoid possible eye damage caused by hazardous radiation and to avoid possible fire, electric shock, or personal injury:

- Never look directly into optical connectors. Some sources produce invisible radiation that can permanently damage your eyes.
- Never run any tests that activate the tester's outputs unless a fiber is attached to the output.
- Do not open the case; no user-serviceable parts are inside.
- Do not modify the tester.
- Do not use magnification to view the optical outputs without proper filtering.

- Use of controls, adjustments, or procedures not stated herein might result in hazardous radiation exposure.
- Use only the ac adapter provided to charge the battery or power the tester.
- Do not use the tester if it is damaged. Inspect the tester before use.
- If this equipment is used in a manner not specified by the manufacturer, the protection provided by the equipment may be impaired.
- Never connect the tester to an active network, except when using the power meter. Doing so causes unreliable test results and can disrupt network operations.
- If the tester shows an error because the power reading is too high, immediately disconnect the source from the tester. The tester is not designed for measuring higher power levels, such as produced by CATV, optical amplifiers, and cellular systems.
- Avoid touching reflective surfaces (such as metal) to the end of a fiber cable plugged into the OTDR when the OTDR is operating. An open fiber connector end face has about a 4% reflection. Holding a reflective surface near the connector end face may cause much greater than a 4% reflection, which may damage the photodetector in the OTDR.

⚠ Caution

To avoid damaging the tester or cables under test and to avoid data loss:

- Always turn the tester off before removing or installing a module.
- Never connect the OTDR port to an optical source. Doing so can damage the OTDR receiver.

- Use proper cleaning procedures to clean all fiber connectors before every use. Neglecting this step or using improper procedures can cause unreliable test results and may permanently damage the connectors.
- Use a Fluke Networks FiberInspector Video Microscope to periodically inspect the OTDR and loss/length option's OUTPUT connectors for scratches and other damage.
- Do not use a video microscope to inspect the power meter or loss/length option's INPUT connector. This connector has different dimensions than the OUTPUT connector, and may be damaged by a fiber inspection probe.
- Read the instructions for splice machines before using the OTDR to monitor splicing procedures. The OTDR can interfere with the light injection detection techniques used by some splicers.
- To avoid unreliable test results, connect the ac adapter or replace the battery as soon as the low battery indication appears.
- You may use a PC to move or copy test record (.tst) files from a memory card, but do not rename the .tst files. Doing so may result in loss of data.
- Never remove the memory card while the memory card's LED is on. Doing so can corrupt the data on the card.

Powering the Tester

You can power the tester with the ac adapter included or with the removable lithium ion battery pack.

Press **Ⓞ** to turn the tester on.

Charging the Battery

Before you rely on battery power for the first time, charge the battery for about 2 hours with the tester turned off.

You can also charge the battery when it is detached from the tester, as shown in Figure 1.

A fully-charged battery lasts about 8 hours during typical use. The battery typically takes about 4 hours to fully charge when the tester is turned off.

Notes

You do not need to fully discharge the battery before recharging it.

The battery will not charge if its temperature is outside the range of 32 °F to 113 °F (0 °C to 45 °C).

Checking the Battery Status

Many of the tester's screens show a battery status icon near the lower-right corner.

To see more information about the battery status, press **FUNCTIONS**; then select **Battery Status**. Press **HELP** for detailed information about the battery status screen.

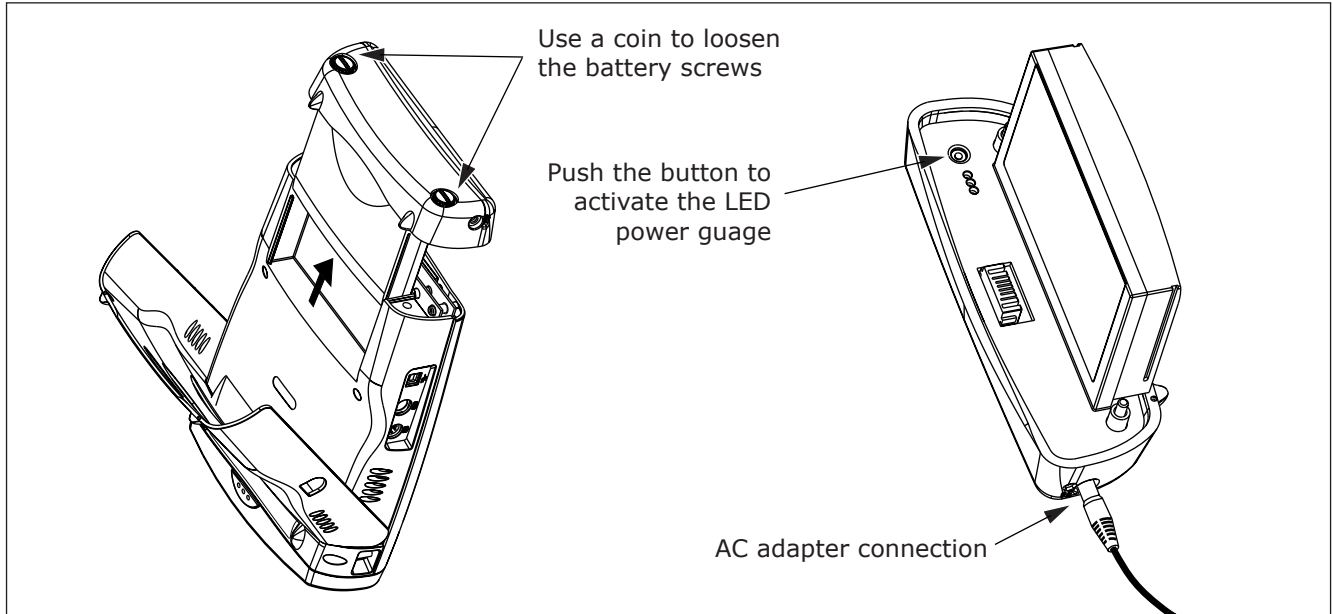









Figure 1. Battery Pack Features

ajt20f.eps

Changing the Language

To change the tester's language, do the following:

- 1 Press .
- 2 Press  once to select the **System** tab.
- 3 Press  to select **LANGUAGE**; then press .
- 4 Use   to select the desired language; then press .
- 5 Restart the tester to apply the new language.

Additional languages for the tester may be available with software updates available on the Fluke Networks website. Use LinkWare software to install or remove languages. See "Updating the Tester's Software" on page 74 for details.

Removing and Installing the Module

The tester's capabilities depend on which test module is installed. Figure 2 shows how to remove the module.

Caution

To avoid corrupting the tester's software, always turn the tester off before removing or installing a module.

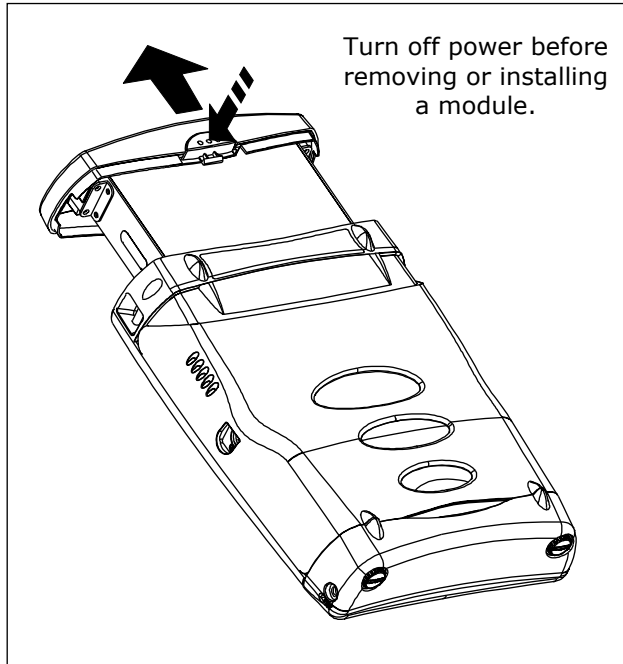

ajt56f.eps

Figure 2. Removing the Module

Verifying Operation

The tester performs a basic self-test when you turn it on. If the tester reports an error or does not turn on, refer to “If Something Seems Wrong” on page 79.

The tester shows the model number of the installed module in the upper-right corner of the screen. If the screen shows **No Module Installed**, **Problem with Module**, or **The module needs a software update** refer to “If Something Seems Wrong” on page 79.

Basic Features

The following sections describe the tester's basic features and introduce the tester's menu system.

Front Panel Features

Figure 3 describes the tester's front panel features.

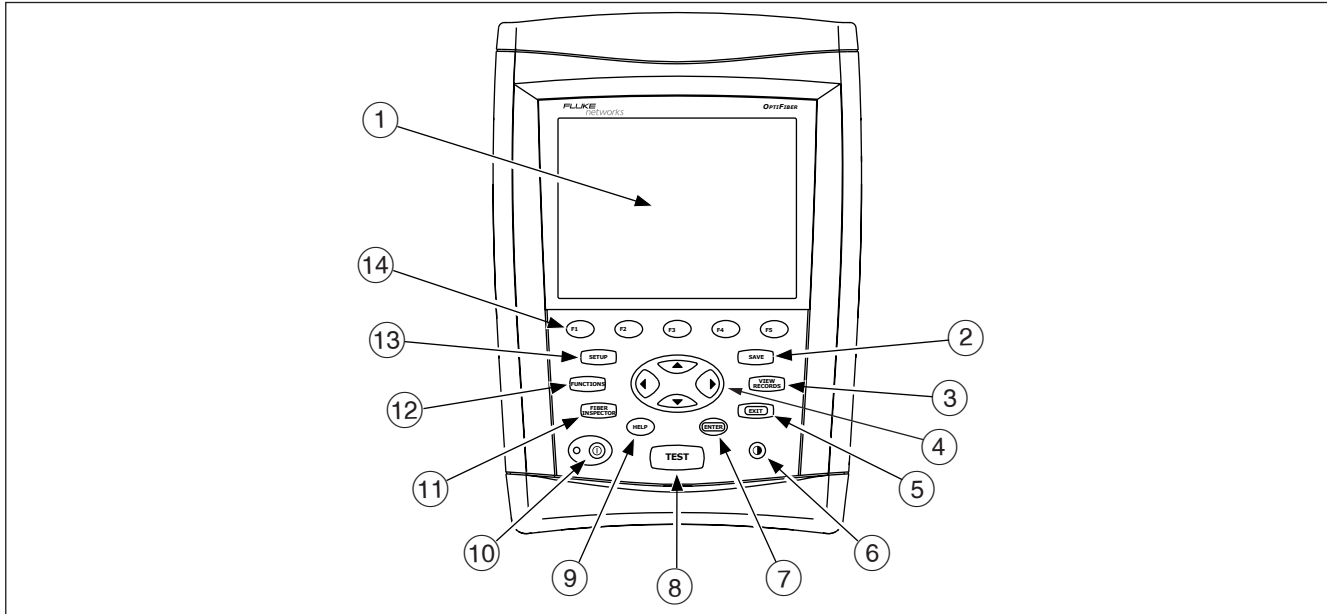

Figure 3. Front Panel Features

ajt12f.eps





- ① LCD display with backlight and adjustable brightness.
- ② **SAVE**: Saves test results on the removable memory card or in internal memory.
- ③ **VIEW RECORDS**: Shows the test records saved on the memory card or in internal memory.
- ④ : Navigation keys let you move the cursor or highlighted area on the screen and increment or decrement alphanumeric values.
- ⑤ **EXIT**: Exits the current screen.
- ⑥ : Lets you adjust the display brightness.
- ⑦ **ENTER**: Selects the highlighted item on the screen.
- ⑧ **TEST**: Starts the currently selected fiber test. The test that will run is shown in the upper-left corner of the display. To change the test, press  **Change Test** from the **HOME** screen or select a test from the **FUNCTIONS** menu.
- ⑨ **HELP**: Shows a help topic related to the current screen. To see the help index, press **HELP** again.
- ⑩ : On/off key.
- ⑪ **FIBER INSPECTOR**: Activates the optional FiberInspector video probe, which lets you inspect fiber endfaces and save the images with test results.
- ⑫ **FUNCTIONS**: Shows a list of additional test, configuration, and status functions.
- ⑬ **SETUP**: Shows the menus you use to configure the tester.
- ⑭ : The five softkeys provide functions related to the current screen. The current functions are shown on the screen above the keys.

Figure 3. Front Panel Features (cont.)

Side and Top Panel Features

Figure 4 describes the tester's connectors and other features on the side and top panels.

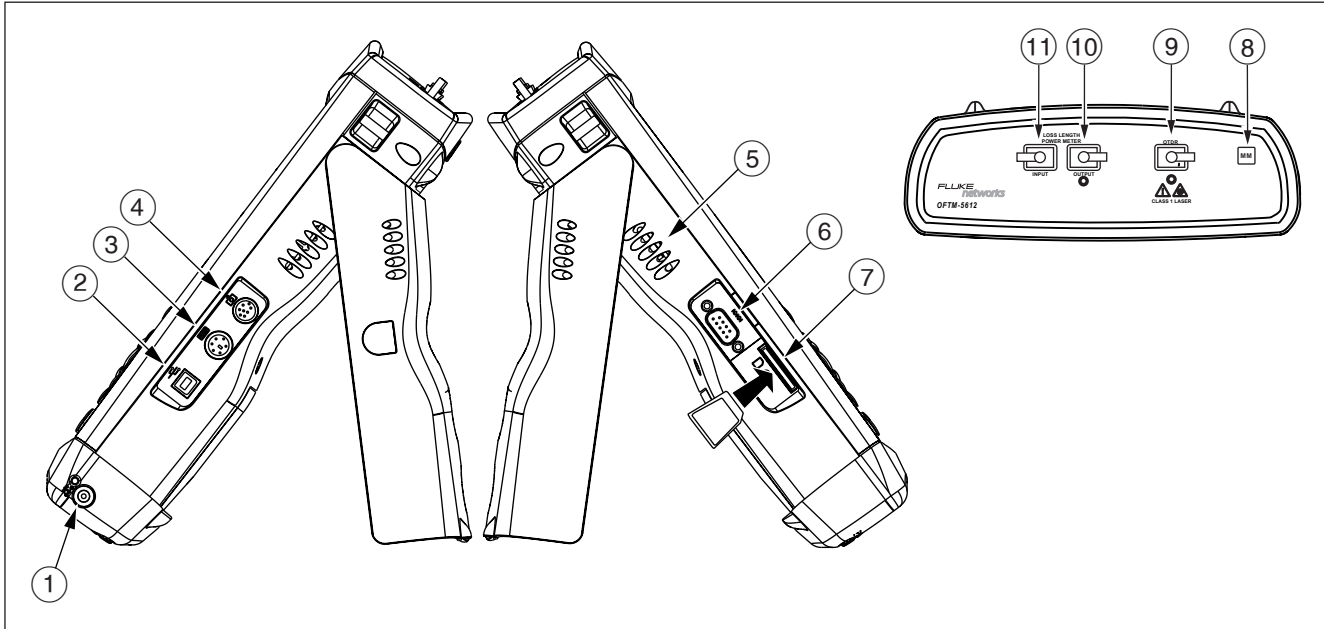

Figure 4. Connectors

ajt14f.eps

- ① Connector for the ac adapter. The LED turns on when the adapter is connected to ac power.
- ② USB port for uploading test reports to a PC and downloading software updates from a PC to the tester. See the LinkWare documentation for details on using the USB port.
- ③ Six-pin mini DIN connector for an optional external PS2 keyboard.
- ④ Eight-pin mini DIN connector for the optional FiberInspector video probe.
- ⑤ Fan vents.
- ⑥ RS-232C serial port for uploading test reports to a PC and downloading software updates from a PC to the tester. See the LinkWare documentation for details on using the serial port.
- ⑦ Slot for the removable memory card. The LED lights when the tester is writing to or reading from the memory card.
- ⑧ Multimode (MM) or singlemode (SM) label for the module.
- ⑨ SC connector for the OTDR. The LED lights when the laser is active.
- ⑩ SC output connector. Transmits optical signals for loss/length tests.
- ⑪ SC input connector. Receives optical signals for power measurements and loss/length tests.

 **Warning**

Never look directly into optical connectors. Some sources produce invisible radiation that can permanently damage your eyes.

Figure 4. Connectors (cont.)

The HOME Screen

The HOME screen shows important test and job settings you might need to change to configure the tester for your needs. Figure 5 describes a typical home screen.

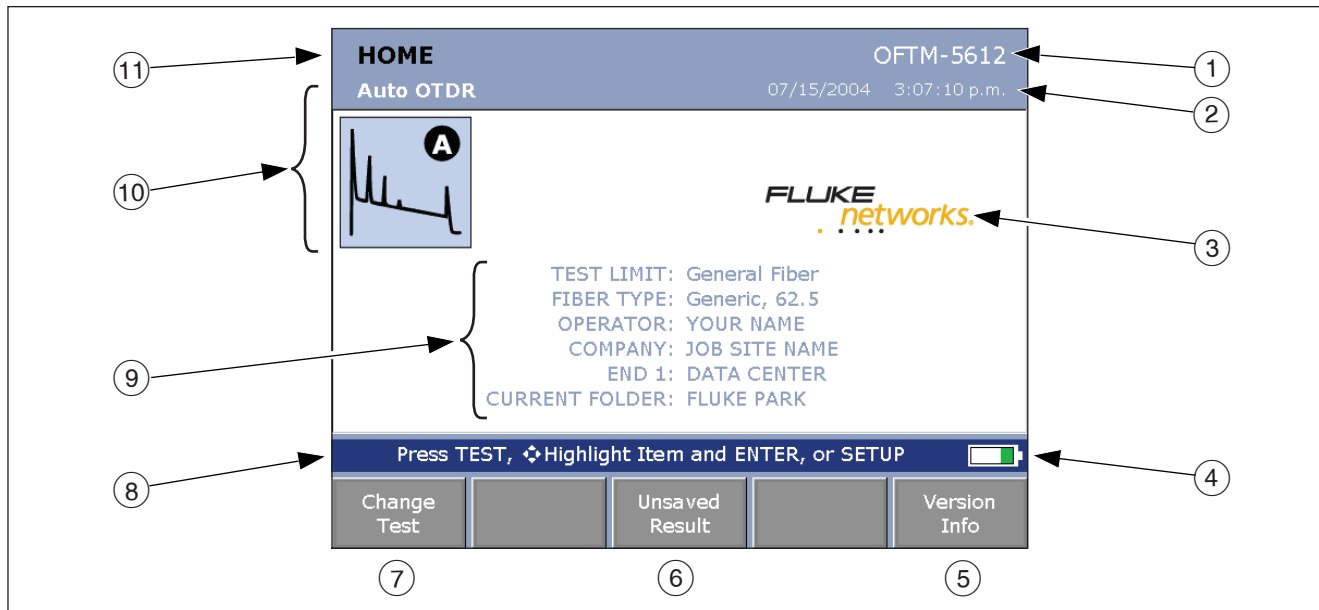

Figure 5. Home Screen for OTDR with Loss/Length Option

ajt13f.eps

- ① Model number of the installed module.
- ② The current date and time.
- ③ Owner's logo. See the OptiFiber Technical Reference Handbook (on the Product Manuals CD) or the LinkWare online help for information on changing the logo.
- ④ Battery status icon. For more information about the battery, press **FUNCTIONS**; then select **Battery Status**.
- ⑤ Press **F5** to see the hardware and software versions and calibration dates for the tester and the installed module.
- ⑥ If the last test run was not saved, you can press **F3** **Unsaved Result** to see the test's results.
- ⑦ Press **F1** **Change Test** to switch test modes. See ⑩.
- ⑧ Action prompts. For most screens, this area prompts you on what keys to press.
- ⑨ Important test and job settings. To change these settings, use **←** **→** **↶** **↷** to highlight a setting; then press **ENTER**. Selecting **TEST LIMIT** or **FIBER TYPE** lets you change the item. Selecting the limit's or type's name lets you see that item's settings. You may also access the tester's settings by pressing **SETUP**.
- ⑩ The test mode, which determines what type of test will run when you press **TEST**. The available modes depend on which module is installed. To change the test mode, press **F1** **Change Test**.
- ⑪ The name of the current screen.

Figure 5. Home Screen for OTDR with Loss/Length Option (cont.)

Using the Setup Menus

To access the tester's settings, press **SETUP**. Figure 6 introduces the **SETUP** menus.

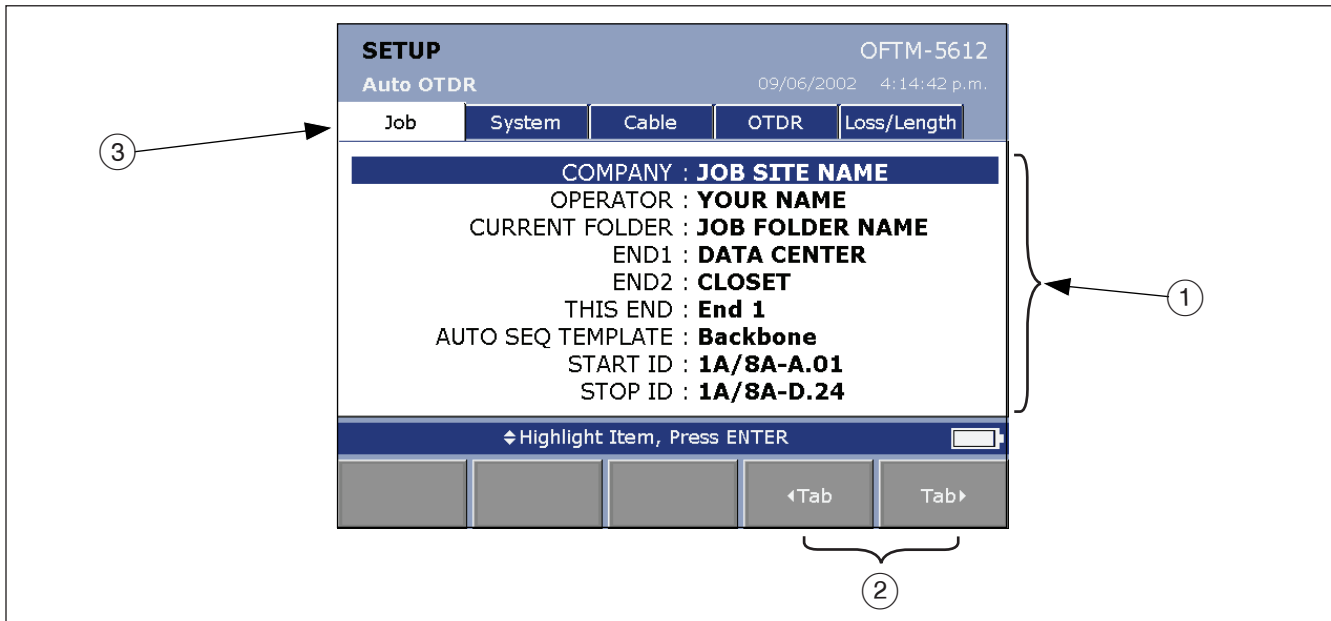

Figure 6. The SETUP Screen

- ① The settings available on the current tab.

Note

To see details about a setting, highlight the setting; then press **HELP**.

- ② Use **F4** Tab and **F5** Tab to move among tabs on the **SETUP** screen.

- ③ Tabs for the setup menus:

- **Job** settings apply to the fiber installation you are testing and are stored with saved test results. Use these settings to identify the job site, set up cable ID lists, and identify which end of the cabling you are testing.
- **System** settings let you localize the tester and set other user preferences, such as the power down timeout and camera type.

- The **Cable** tab lets you select the type of fiber cable you will test and define some cable characteristics for loss/length tests. You can also change the index of refraction if you do not want to use the default values.

Note

Select a fiber type before selecting a test limit. The fiber type determines which test limits are available.

- The **OTDR** tab lets you select a test limit and wavelength for OTDR tests and enable launch fiber compensation. You can also change settings for Manual OTDR mode.
- The **Loss/Length** tab appears if the installed module includes the loss/length or power meter option (you can run loss tests in Far End Source mode with the power meter option). Use this tab to configure the loss/length test. See "Using the Loss/Length Option" on page 47 for details.

Different or additional tabs may be available depending on the installed module.

Figure 6. The Setup Screen (cont.)

Using the Online Help

When you press **HELP**, the tester shows a help topic that relates to the current screen. Blue, underlined words are links to other topics.

Note

The help files are stored in the mainframe (rather than the module) and may describe features not present in the installed module

To go to a linked topic (blue, underlined words), use the left or right arrow keys to highlight the words; then press **ENTER**.

To see an index of all help topics, press **HELP** any time you are in the help system.

Fiber ID Options

You can create or select fiber IDs as follows:

- You can create an ID after you press **SAVE**. You can also highlight a used or unused ID in a list; then press **ENTER** to edit it into a new ID. The next time you press **SAVE**, the tester increments the last character of the ID you created (the auto increment feature).
- You can create a list of sequential fiber IDs by configuring a template on the **Job** tab in Setup. Select the IDs from the **AUTO SEQ IDs** list after you press **SAVE**.
- You can create ID lists in LinkWare software; then download them to the tester. Select the IDs from the **DOWNLOAD IDs** list after you press **SAVE**.
- After you press **SAVE**, you can use an ID already assigned to a record stored in the current folder. This lets you overwrite existing results or add new results to an existing record. Select the ID from the **IDs IN CURRENT FOLDER** list after you press **SAVE**.

Checking the Tester's Status

The following Quick Steps help you verify that the tester is ready for use.

Quick Steps: Checking the Tester's Status

❑ Check the battery status

Look at the battery icon in the lower-left corner of the screen or press **FUNCTIONS**; then select **Battery Status**.

A fully-charged battery lasts about 8 hours during typical use.

❑ Check the space available on the memory card

Insert the memory card you will use, press **FUNCTIONS**; then select **Memory Status**.

To see the status of the internal memory, press **F1** from the **MEMORY STATUS** screen.

To view or delete stored records, press **VIEW RECORDS**.

To format the memory card press **FUNCTIONS**; then select **Format Memory Card**.

❑ Verify that the installed module can run the tests you need

The module's model number is shown in the upper-right corner of the screen.

To review module capabilities, press **HELP** twice; then select "modules" in the OptiFiber online help index.

Preparing to Save Tests

The following Quick Steps summarize how to configure settings that apply to saved test results.

Quick Steps: Preparing to Save Tests

❑ Set up a job folder

- 1 Insert a memory card into the tester.
- 2 Press **SETUP**; then select **CURRENT FOLDER** on the **Job** tab.
- 3 Select an existing folder on the memory card, or press **F1** **New Folder** to create a new folder.

❑ Enable or disable the SAVE WARNING

Press **SETUP**; then select **SAVE WARNING** on the **System** tab to enable or disable the warning about an unsaved test.

❑ Enter COMPANY and OPERATOR names on the Job tab

COMPANY is the customer name, job site, job work order, or other job identifier.

OPERATOR is the name of the OptiFiber user.

❑ Create a list of sequential fiber IDs (See “Fiber ID Options” on page 22 for other ID options.)

- 1 Select **AUTO SEQ TEMPLATE** on the **Job** tab.
- 2 Press **F1** **Change Template** to select an ID template.
- 3 Press **F2** **Edit Start** or **F3** **Edit Stop** to create the start and stop IDs; then press **F5** **Sample List** to see what the list will look like.
- 4 Press **SAVE** when you are finished.

❑ Identify the ends of the cabling

- 1 Enter names for **END 1** and **END 2** on the **Job** tab. For example, one end could be **TELECOM ROOM** and the other could be **WORK AREA**.
- 2 Set **THIS END** to the end you will test from first.

Cleaning and Inspecting Fiber Connectors and Adapters

Always clean and inspect fiber connectors before making connections. Use 99 %-pure isopropyl alcohol and optical-grade wipes or swabs to clean connectors as follows:

- **Connector ends:** Wipe the end of the ferrule with a swab or wipe lightly moistened with alcohol. Dry with a dry swab or wipe.
- **Bulkhead connectors:**

Note

Use a 2.5 mm foam swab for cleaning the tester's optical connectors.

- 1 Dip the tip of a foam swab in alcohol; then touch the swab to a dry wipe.
- 2 Touch a new, dry swab to the alcohol spot on the wipe.

- 3 Push the swab into the connector; twist it around 3 to 5 times against the endface, then remove and dispose of the swab.
 - 4 Dry the connector with a dry swab by twisting it around in the connector 3 to 5 times.
- Inspect connectors with a fiber microscope, such as the Fluke Networks FiberInspector Video Probe before making connections. See "Using the FiberInspector Option" on page 42 for details.
 - Periodically clean fiber adapters with a swab and alcohol. Dry adapters with a dry swab before use.
 - Always cover unused connectors with dust caps or plugs. Clean dust plugs periodically with a swab or wipe and alcohol.

Testing Your Patch Cords and Launch Fiber

You should test your patch cords and launch fiber before each job. Use another set of known-good patch cords to set a reference and run an Autotest on each patch cord and launch fiber. Use Smart Remote mode to test two patch cords at a time, or Loopback mode to test one patch cord. For SC/SC patch cords, you can also use the method described in TIA/EIA TSB140.

You should also use a fiber microscope, such as the FiberInspector video probe, to inspect the patch cord and launch fiber connectors for damage at least once a day.

Using the OTDR

The OTDR helps you identify and locate faults on fiber cabling. It also measures length, event loss, and overall loss of the cabling and provides PASS/FAIL results based on a selected test limit.

About Launch and Receive Fibers

Launch and receive fibers let the tester measure the loss and reflectance of the first and last connectors in the cabling, and include those connectors in ORL (optical return loss) measurements. Without launch and receive fibers, no backscatter is available before the first connector and after the last, so the tester cannot measure the connectors' characteristics.

If the first or last connection in the cabling is bad, and you do not use launch and receive fibers, the OTDR test may pass because it does include measurements from the bad connection.

OVERALL LOSS and **FIBER LENGTH** include the loss and length of the launch and receive fibers, unless you use the launch fiber compensation function. See the online help or the Technical Reference Handbook for details on launch fiber compensation.

Fluke Networks recommends that you use launch and receive fibers. You should also use launch/receive fiber compensation to remove the effects of these fibers from the OTDR measurements.

Selecting Auto or Manual OTDR Mode

Note

You should use Auto OTDR mode when certifying cabling with the OTDR.

From the **HOME** screen, press  **Change Test**. Select **Auto OTDR** or **Manual OTDR** from the popup menu.

In **Auto OTDR** mode, the tester automatically selects an appropriate range, resolution, and pulse width based on the length and overall loss of the cabling. This mode is the easiest to use, provides the most comprehensive view of the events on the cabling, and is the best choice for most applications.

Manual OTDR mode lets you change the range, resolution, and pulse width to optimize the OTDR for displaying specific events. See the online help or the Technical Reference Handbook for details.

OTDR Connection Quality

When you run an OTDR test, the tester determines the quality of OTDR port connection (Figure 7).

If the gauge is in the **Poor** range, you should clean the OTDR port and the fiber connector. Use a video microscope, such as the FiberInspector video probe, to inspect the port and fiber connector for scratches and other damage. If a connector on the tester is damaged, contact Fluke Networks for service information.

A poor OTDR connection increases the connector's deadzone, as shown in Figure 32 on page 82. The deadzone can hide faults near the OTDR connector.

A poor connection also decreases the light available for testing the fiber. The weakened test signal causes a noisier trace, poor event detection, and decreased dynamic range.

The port connection quality rating is saved with OTDR result details.

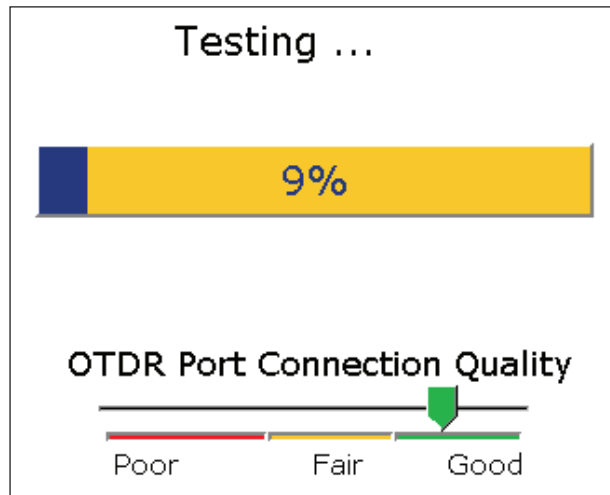

Figure 7. OTDR Port Connection Quality Gauge

ajt67f.eps

Running the OTDR Test

Figure 8 shows the equipment needed for using the OTDR.

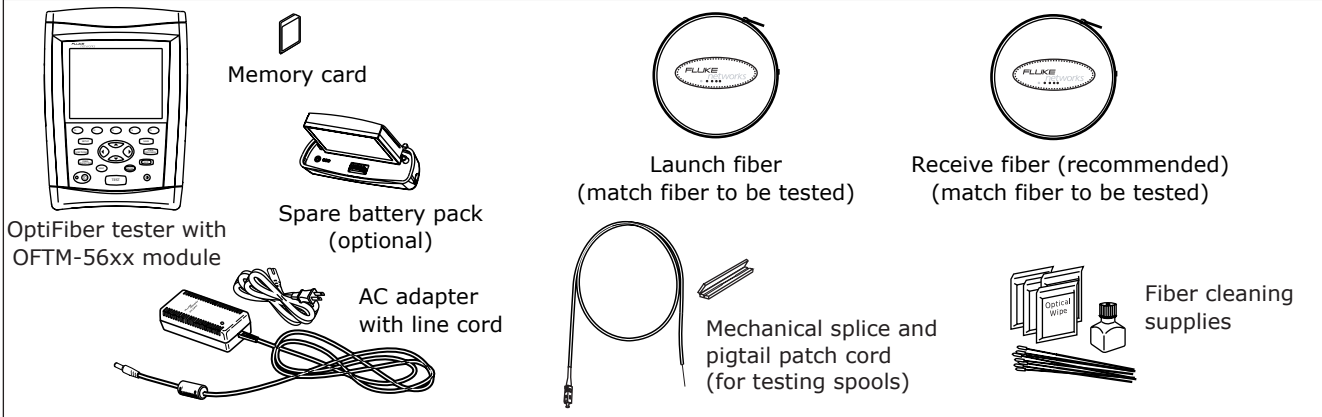

Figure 8. Equipment for OTDR Testing

ajt42f.eps

Quick Steps: Using the OTDR

- 1 Select Auto OTDR mode: On the **HOME** screen, press **F1** **Change Test**; then select **Auto OTDR**.
 - 2 Compensate for the launch/receive fibers, if desired: Press **FUNCTIONS**; then select **Set Launch Fiber Compensation**. Press **HELP** for details on the compensation screens.
 - 3 Choose settings for the fiber to be tested. Set the following on the **Cable** tab:
 - **FIBER TYPE**: Select the fiber type to be tested.
 - **MANUAL CABLE SETTINGS** (index of refraction and backscatter coefficient): Disable to use the values defined in the selected fiber type, which are suitable for most applications.
 - 4 Configure the OTDR test. Press **SETUP**; then select the following on the **OTDR** tab:
 - **TEST LIMIT**: Select an appropriate limit.
 - **WAVELENGTH**: Select one or both wavelengths.
 - **LAUNCH COMPENSATION**: Enable if you want to use the launch fiber compensation settings.
 - **OTDR PLOT GRID**: Enable to see a measurement grid on the OTDR plot.
 - 5 Clean all connectors that will be used.
 - 6 Connect the tester's OTDR port to the cabling, as shown in Figure 9, 10, or 11.
 - 7 Press **TEST** to start the OTDR test. Figure 12 describes the OTDR trace screen.
 - 8 To save the results, press **SAVE**, select or create a fiber ID; then press **SAVE** again.
- For bi-directional testing, do the following:
- 1 Set **THIS END** to **END 1** on the **Job** tab in Setup.
 - 2 Test all the cabling from **END 1**.
 - 3 Change **THIS END** to **END 2**; then test all the cabling from the other end. Save the results with the same fiber IDs as results from the first test direction. The ID will be in the **IDS IN CURRENT FOLDER** list.

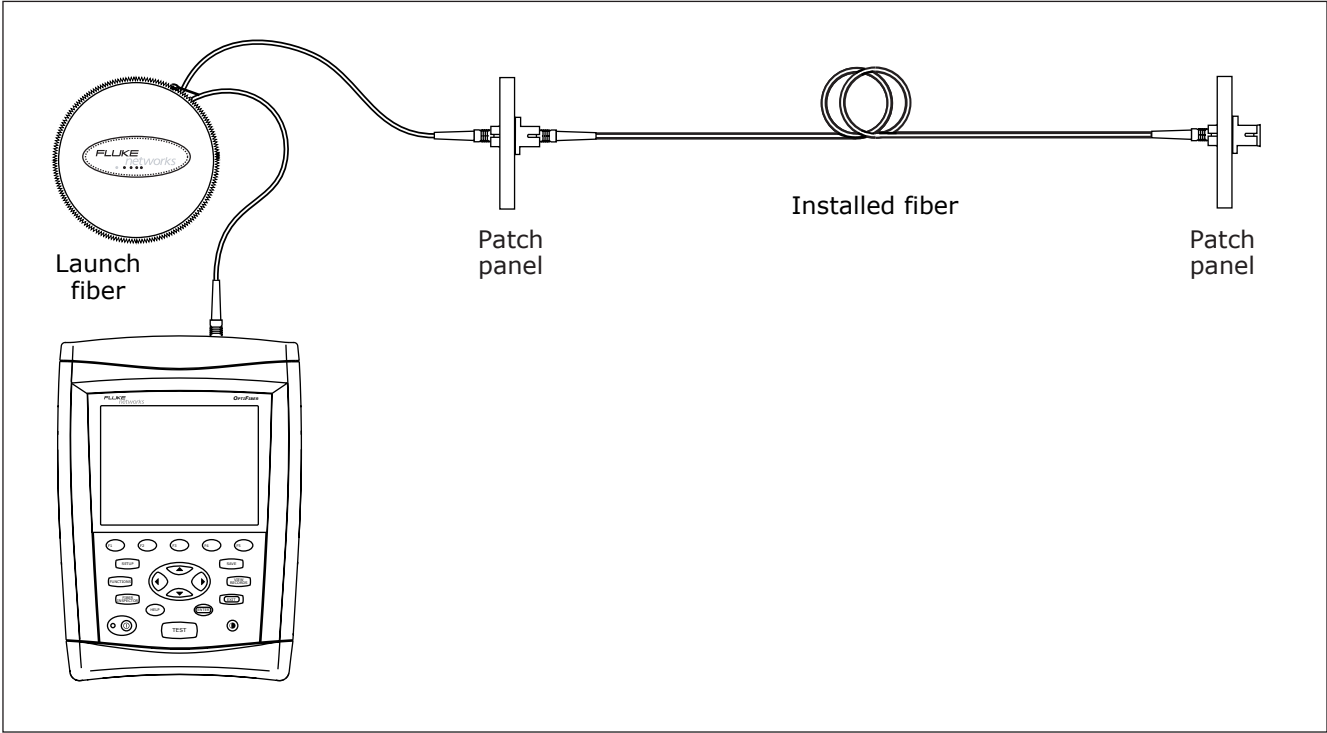

Figure 9. Connecting the OTDR to Installed Fiber (no receive fiber)

ajt32f.eps

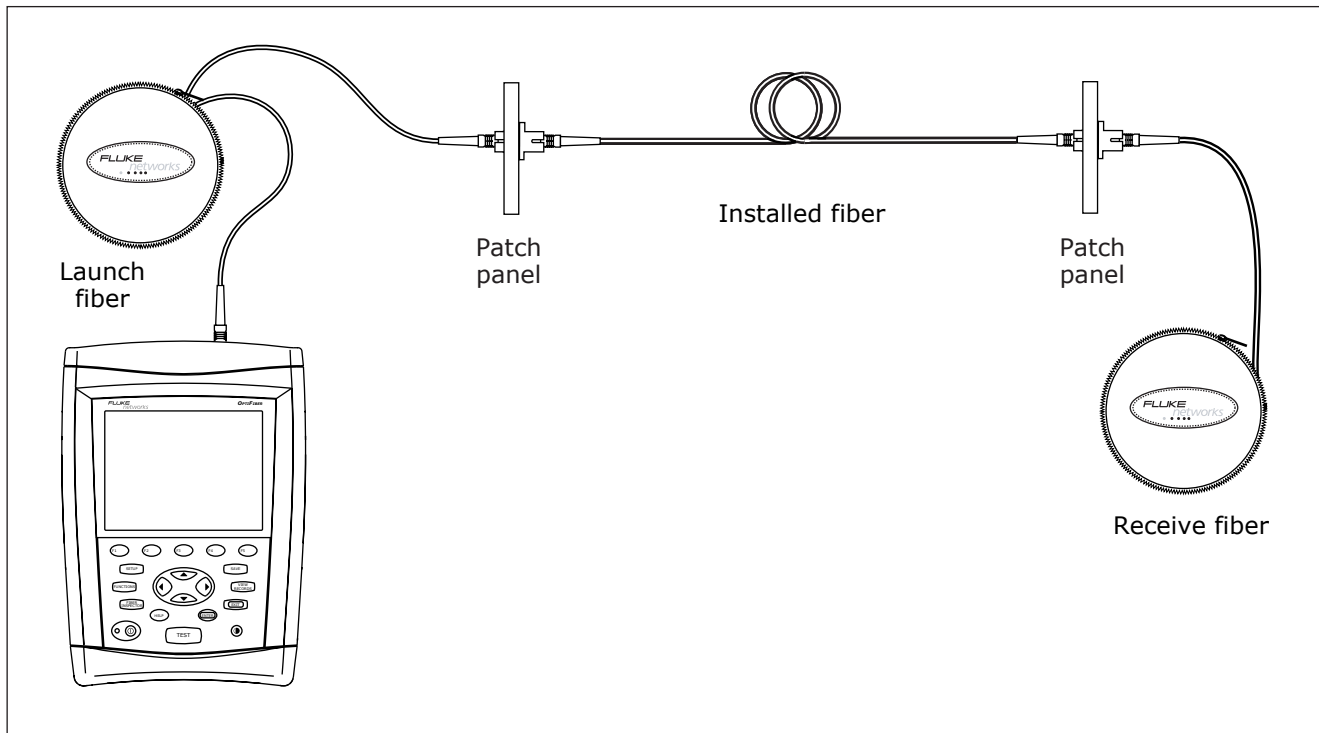

Figure 10. Connecting the OTDR to Installed Fiber (with receive fiber)

ajt01f.eps

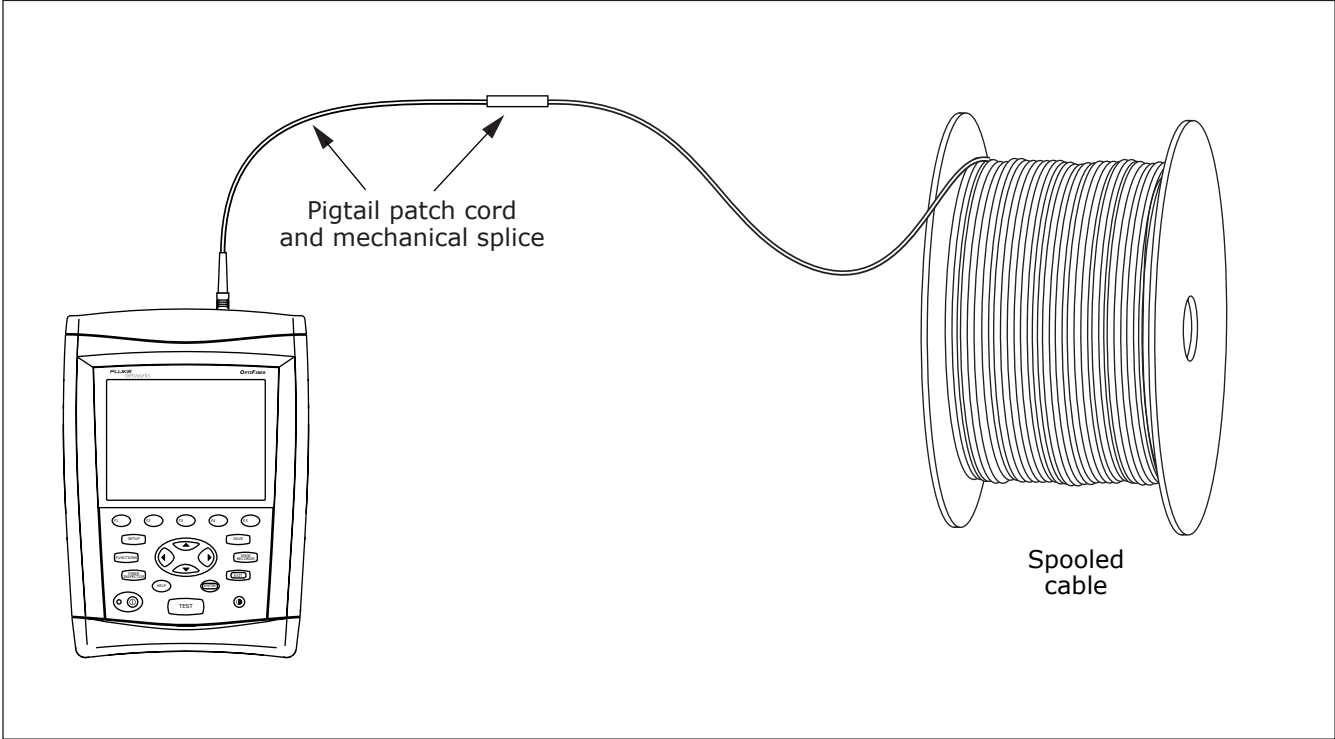
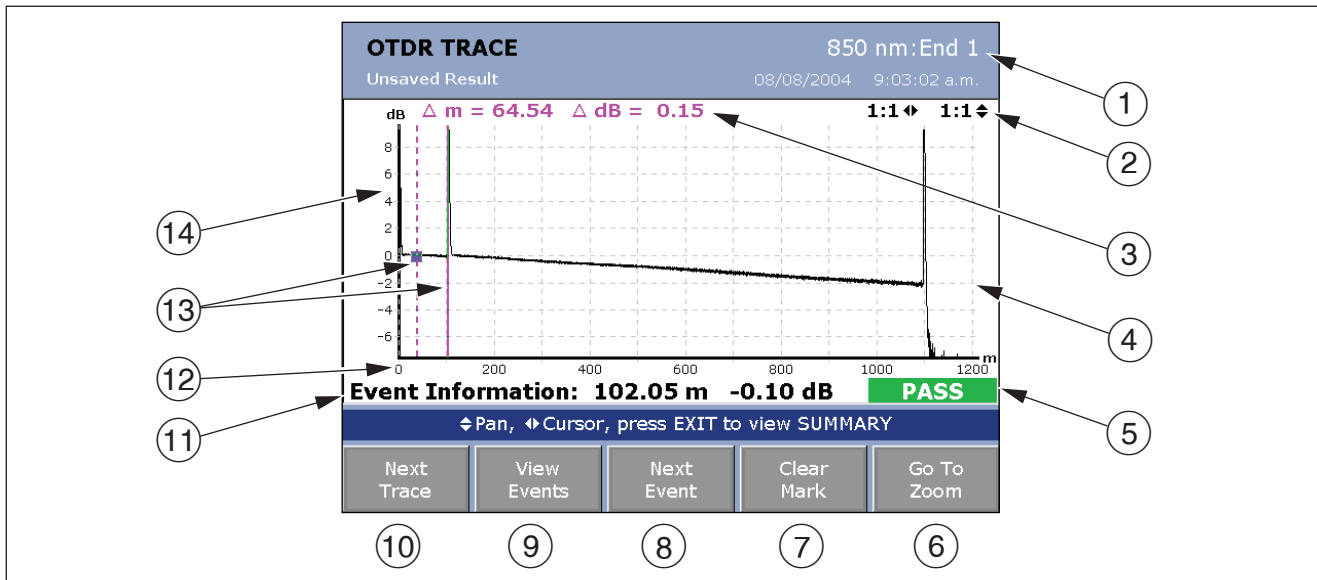

Figure 11. Connecting the OTDR to Spooled Cable

ajt33f.eps



ajt16f.eps

Figure 12. OTDR Trace Screen

- | | |
|--|--|
| <p>① Wavelength for the trace and the End setting on the Job tab in SETUP. If the test ran at two wavelengths, press F1 to switch wavelengths. You can set the wavelengths on the OTDR tab in Setup.</p> <p>② Magnification factors for the trace. See the online help for details on zooming.</p> <p>③ The distance (m or ft) and the power loss (dB) between the cursor and the measurement marker (⑪).</p> <p>④ OTDR plot grid. You can enable or disable the grid on the OTDR tab in SETUP.</p> <p>⑤ PASS/FAIL status appears if the cursor is on an event. The status may refer to the event or the fiber segment before the event. If the event looks ok, press F3 View Details from the EVENT TABLE screen or the SUMMARY screen to see results for the segment.</p> <p>⑥ Press F5 to change the arrow keys' function from moving the cursor to zooming to moving the trace if trace overlay is active (page 36). The navigational cue above the softkey labels describes the arrow keys' current function.</p> | <p>⑦ Key for setting and clearing the measurement cursor.</p> <p>⑧ Moves the cursor to the next event on the trace. If you use ← to move the cursor, F3 changes to Previous Event and moves the cursor to the previous event.</p> <p>⑨ Displays the event table.</p> <p>⑩ For dual-wavelength tests, press F1 to switch wavelengths.</p> <p>⑪ Event information appears if the cursor is on an event. Otherwise, the distance to the cursor is shown.</p> <p>⑫ Scale for the distance along the cabling under test.</p> <p>Tip: The distance scale represents the distance along the fiber, which may be different from the distance along the cable jacket. To adjust the length measurements to represent cable jacket length, change the index of refraction until the measured length matches the jacket length.</p> <p>⑬ Measurement marker and cursor.</p> <p>⑭ Decibel scale for the OTDR backscatter.</p> |
|--|--|

Figure 12. OTDR Trace Screen (cont.)

Comparing OTDR Traces

The trace overlay function lets you see two OTDR traces at the same time. This lets you do the following:

- Compare a link's current trace with a past trace to see if the link has changed.
- Compare traces from links in the same run to check for differences.

To compare two traces, do the following:

- 1 Run an OTDR test; then press **F1** **View Trace**.
or
View an OTDR trace from a saved record.
This trace is the **Comparison Trace**.

- 2 Press **FUNCTIONS**. This brings up the **OTDR FUNCTIONS** menu.
- 3 Select **New Reference Trace**.
- 4 On the **VIEW RECORDS** screen, select a record. Only records with OTDR traces are shown.
The test's trace becomes the **Reference Trace** on the **OTDR FUNCTIONS** menu.
- 5 Press **EXIT**.

The reference trace stays on the plot until you turn off the trace overlay function.

Using the ChannelMap Function

The ChannelMap™ function creates a map of the cabling under test. The map shows the fiber links and connections in the cabling. This function is optimized for resolving connections as close as 1 m apart on multimode fiber and 2 m apart on singlemode fiber.

Reflective events that do not appear to be connectors are not shown on the map. Loss events are also not shown.

Figure 13 shows the equipment needed for ChannelMap tests.

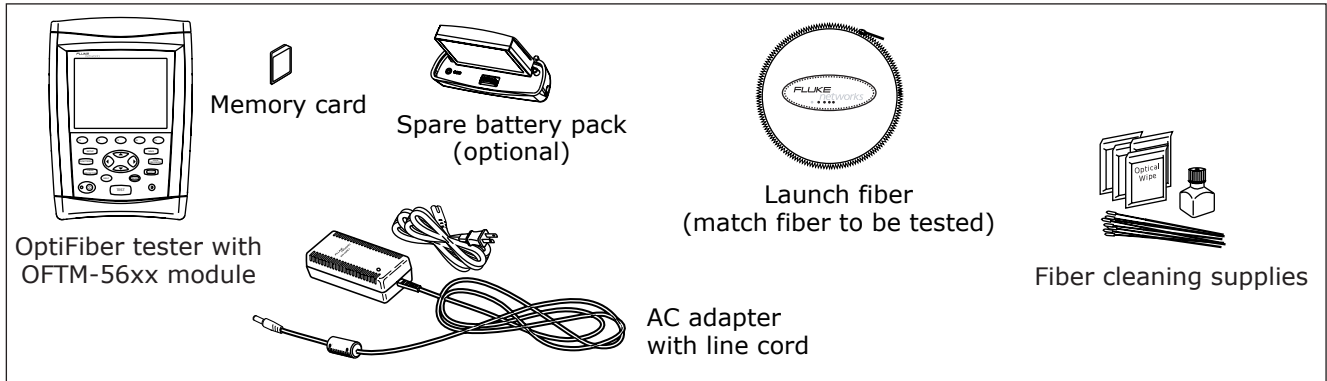

Figure 13. Equipment for ChannelMap Testing

ajt48f.eps

Quick Steps: Using the ChannelMap Function

- 1 Select ChannelMap mode: On the **HOME** screen, press **F1** **Change Test**; then select **ChannelMap**.
- 2 Select a fiber type on the **Cable** tab in Setup. You do not need to select a test limit for ChannelMap tests.
- 3 Clean all connectors that will be used.
- 4 Connect the launch fiber to the OTDR port and the channel to be mapped. Refer to Figure 14.
- 5 Press **TEST**. Figure 15 describes the features of the ChannelMap diagram.
- 6 To save the results, press **SAVE**, select or create a fiber ID; then press **SAVE** again.

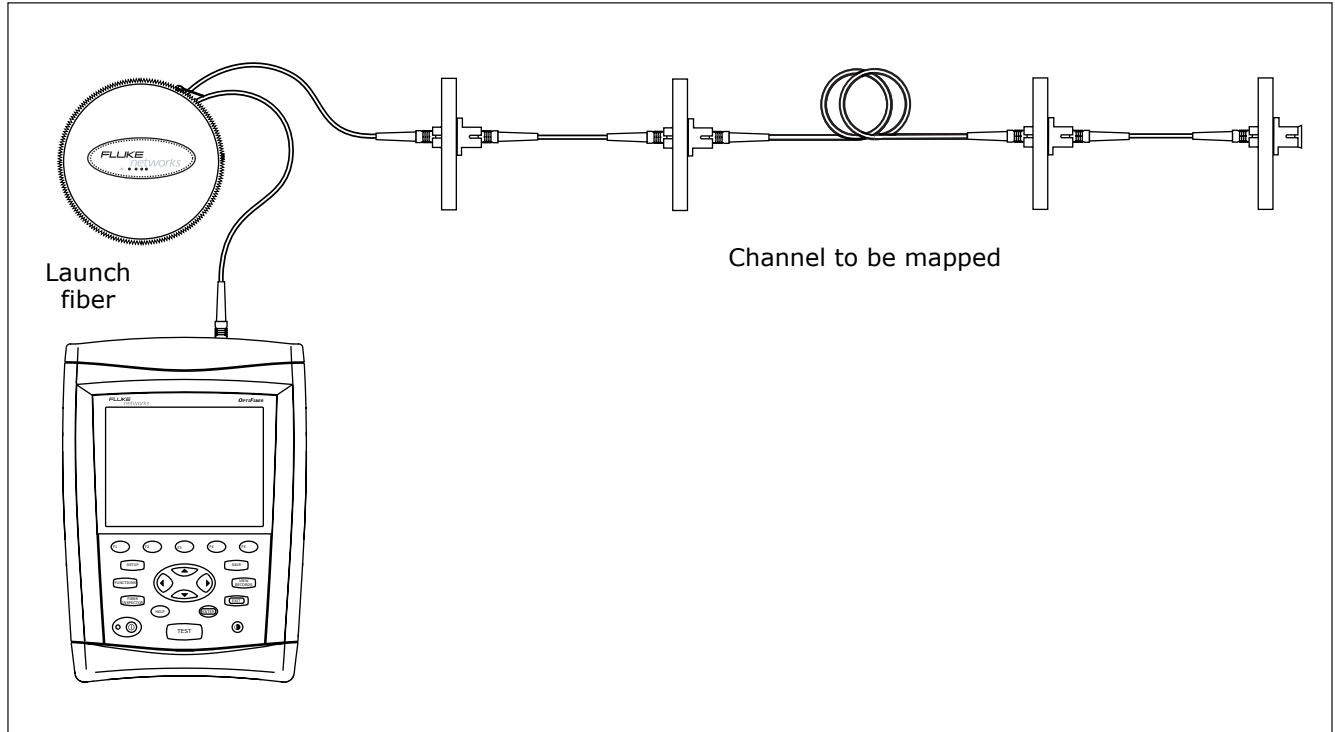
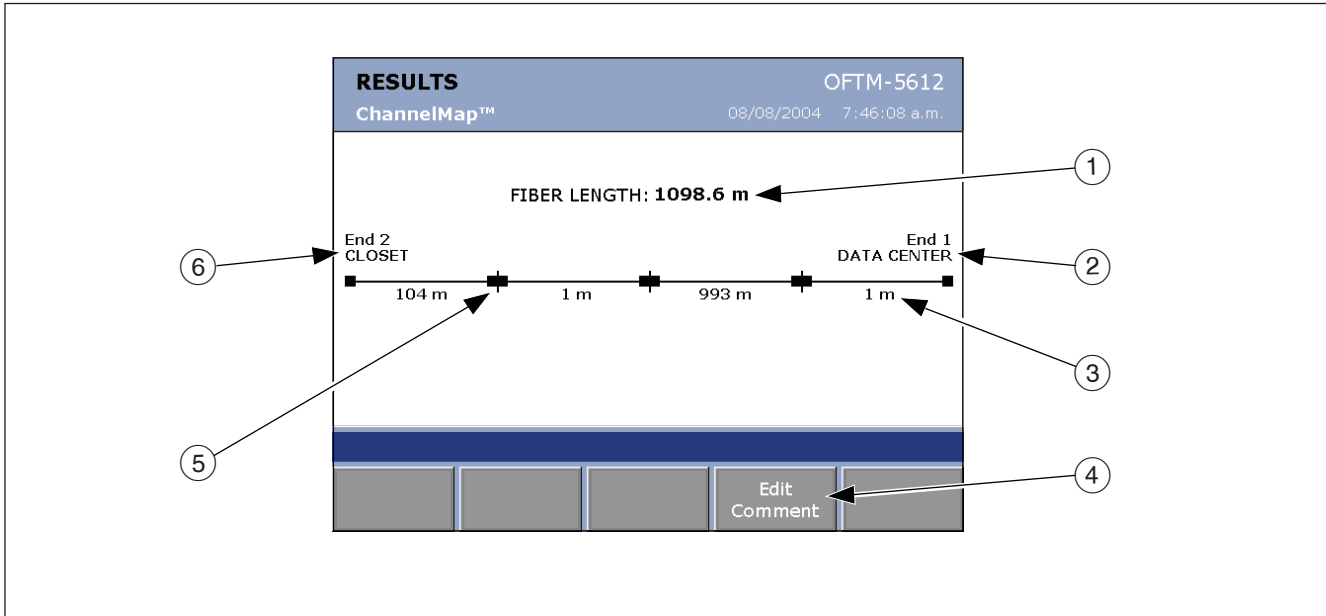

Figure 14. ChannelMap Test Connections

ajt55f.eps



ajt25f.eps

Figure 15. ChannelMap Diagram Features

- ① The length of the channel, including the launch fiber.

Note

*The **FIBER LENGTH** shown is the actual length of the channel rounded to the nearest meter or foot (not the sum of the displayed segment lengths).*

- ② The far end of the channel. The name is set by the **END 1** or **END 2** setting on the **Job** tab in Setup.

- ③ The length of a segment or patch cord rounded to the nearest meter or foot.

- ④ Press **F4** to add a comment to the ChannelMap results.

- ⑤ A reflective event, usually a connector. Could also be a mechanical splice or a reflective fault such as a sharp bend or a crack in the fiber.

- ⑥ The near end of the channel. The name is set by the **END 1** or **END 2** setting on the **Job** tab in Setup.

Figure 15. ChannelMap Diagram Features (cont.)

Using the FiberInspector Option

The OFTM-5352 FiberInspector™ Video Probe connects to an OptiFiber fiber tester to let you inspect the ends of fiber optic connectors. The probe's 250X and 400X magnifications reveal dirt, scratches, and other defects that can cause poor performance or failures in fiber optic networks.

The 250X magnification shows dirt and other defects on the fiber endface and surrounding ferrule. The 400X magnification allows a more detailed inspection of the cladding and core.

Figure 16 shows the equipment needed for using the FiberInspector probe.

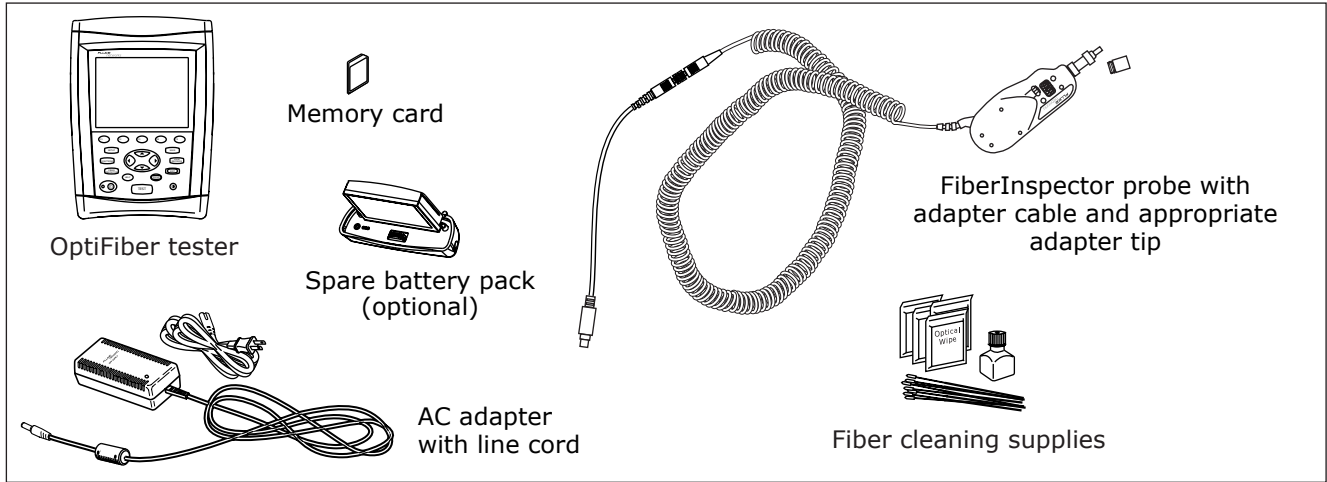



Figure 16. Equipment for FiberInspector Tests

ajt43f.eps

Quick Steps: Using the FiberInspector Probe

- 1 On the **System** tab in Setup, set **CAMERA TYPE** to match the magnification you will use. This selects the correct size for the core size scale.
- 2 Use the adapter cable provided to connect the probe to the video input jack on the side of the tester.
- 3 Screw an adapter tip that matches the connector type being inspected onto the fiber probe.
- 4 Clean the connector to be inspected.
- 5 Press . If the message "**Camera Image Unavailable**" appears check the connections between the probe and the tester.
- 6 Place the probe on the fiber connector. Turn the larger ring on the probe to focus the image. Turn the smaller ring to change magnification. Refer to Figure 17.



The tester's softkeys provide additional functions. Press  **More** to see other softkey functions.
- 7 To save the image, press , select or create a fiber ID; then press  again.

Figure 18 shows some typical FiberInspector images.

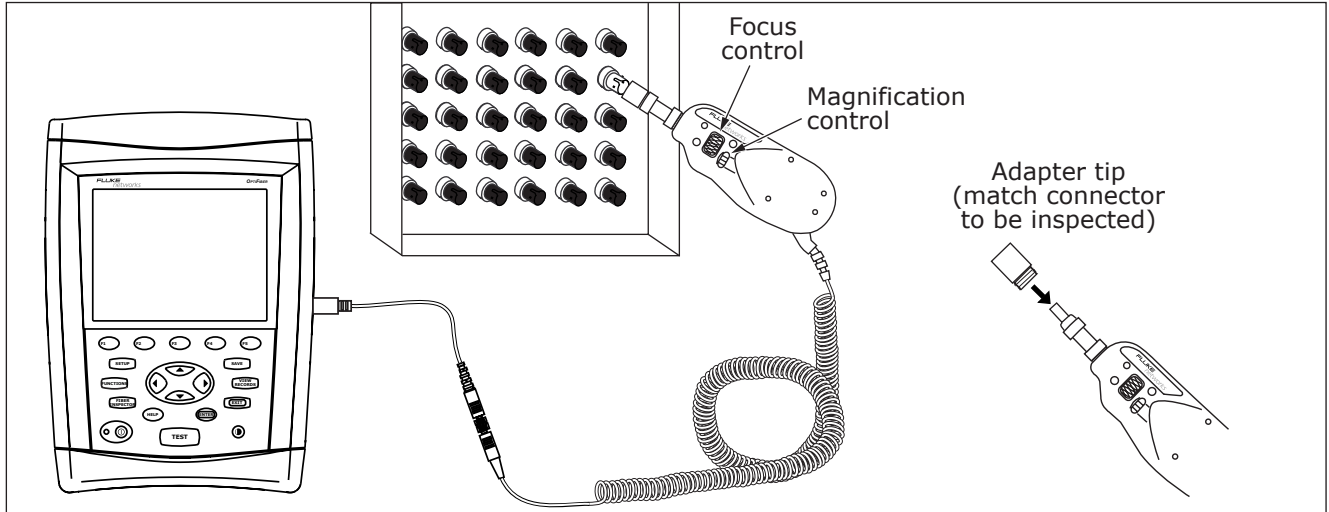
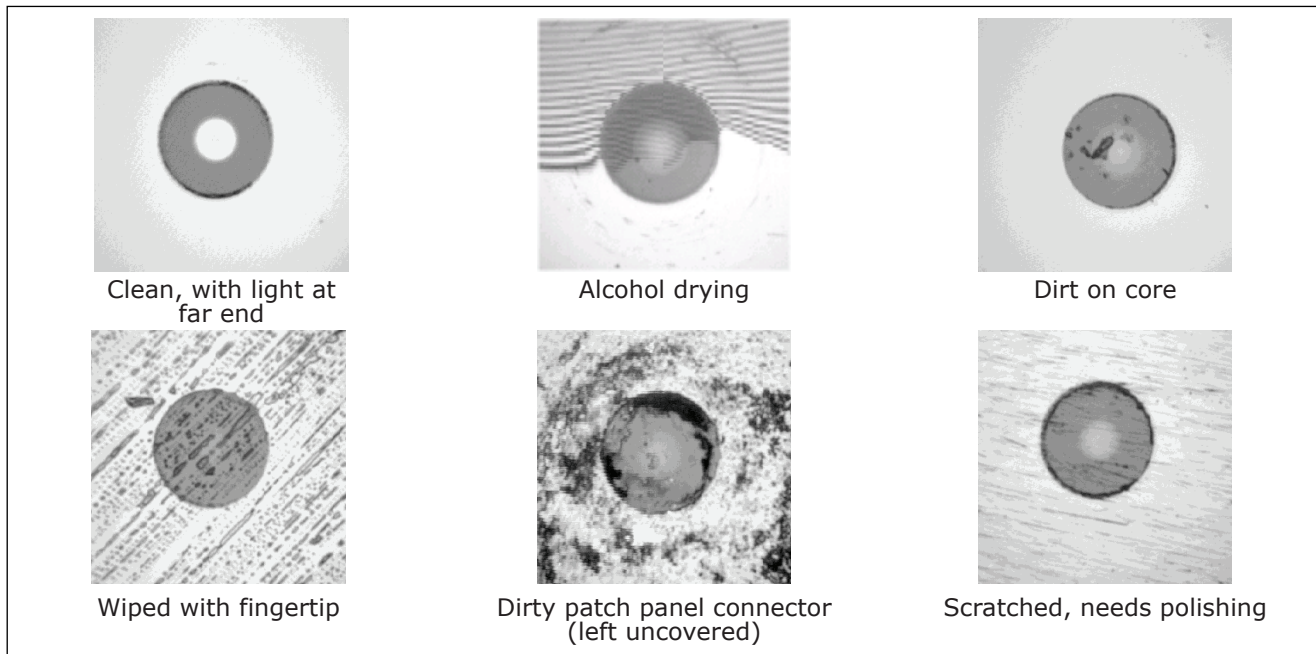

Figure 17. Using the FiberInspector Probe

ajt57f.eps



ajt23f.eps

Figure 18. FiberInspector Image Examples (250X on multimode fiber)

Using the Loss/Length Option

The loss/length measurement option provides the following features, in addition to the OTDR module features described earlier:

- Measures optical power loss, length, and propagation delay on dual-fiber cabling. Provides PASS/FAIL results based on limits you enter or on factory-installed limits.
- FindFiber™ feature helps you identify and verify optical connections.

About Smart Remotes

You can use the following as the remote for loss/length testing and FindFiber tests in Smart Remote mode:

- A second OptiFiber tester with the loss/length option
- A Fluke Networks DTX Series CableAnalyzer™ smart remote with a multimode or singlemode fiber module. The DTX remote can also be used as a manually-controlled source for testing in Far End Source mode. You can buy a DTX smart remote separately for this purpose. See the Fluke Networks website or contact Fluke Networks for details.

Note

The OptiFiber tester must have software version 1.6.6 or later to work with a DTX smart remote. OptiFiber software updates are available on the Fluke Networks website.

About Setting the Reference

Setting a reference lets the tester automatically subtract out the losses due to patch cords and the main and remote tester.

Note

Always let your test equipment warm up for 5 minutes before setting a reference.

For the most accurate test results, you should set the reference at these times:

- At the beginning of each day using the remote end setup (Figures 22 through 29) you will use that day. The tester reminds you to set the reference if the reference is more than 12 hours old.
- Anytime you reconnect a patch cord to the tester or other source.
- Anytime the tester warns you that the reference is out of date.

The tester requires you to set the reference at these times:

- Anytime you change the loss/length module in the main or remote tester.
- Anytime you start using a different remote tester.
- Thirty days after the reference was previously set.

The tester warns you if the reference value is outside of an acceptable range.

To see the reference information for the current remote end setup, select **Set Loss/Length Reference** from the Functions menu; then press  **View Settings**.

See the sections "Testing in Smart Remote Mode", "Testing in Loopback Mode", and "Testing in Far End Source Mode" for details on setting the reference for each mode.

Setting the Number of Adapters and Splices

The **NUMBER OF ADAPTERS** and **NUMBER OF SPLICES** settings are on the **Loss/Length** tab in Setup. These settings do not apply to all test limits.

Test limits that include maximum values for the loss per km, loss per connector, and loss per splice use a calculated limit for loss. Only limits with all three values use a calculated loss limit. The **OVERALL LOSS** value should be **N/A** in these limits. If a loss value is entered, it is ignored.

To see the limit's values, select **TEST LIMIT** on the **Loss/Length** tab; then press **F1** **View Limit**.

If the selected limit uses a calculated loss limit, enter the number of adapters and splices that will be added to the fiber path after the reference is set.

Figure 19 shows an example of how to determine the **NUMBER OF ADAPTERS** setting.

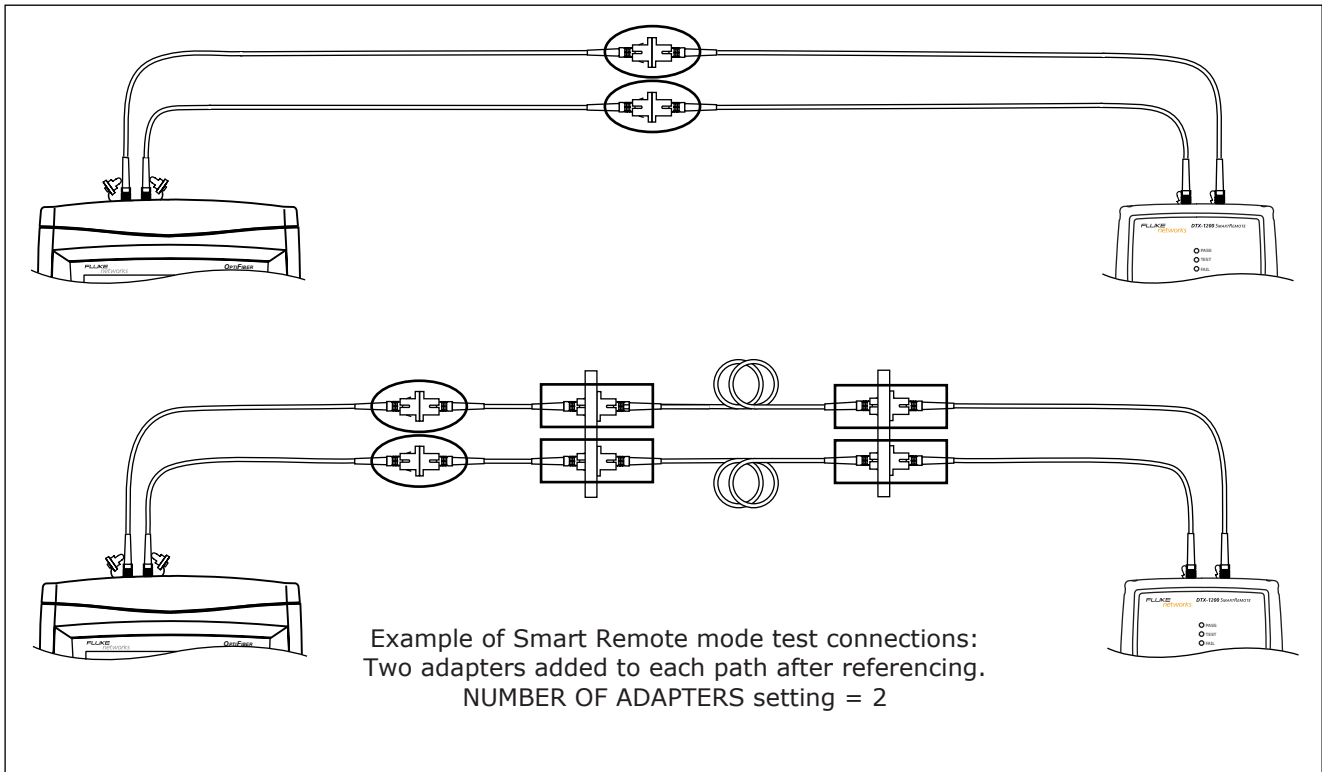

Figure 19. Example of How to Determine the NUMBER OF ADAPTERS Setting

ajt22f.eps

Using Mandrels for Testing Multimode Fiber

You should use mandrels when testing multimode fiber with the OFTM-561x modules. Mandrels can improve measurement repeatability and consistency. They also allow the use of LED light sources to certify 50 μm and 62.5 μm fiber links for current and planned high bit-rate applications, such as Gigabit Ethernet and 10 Gigabit Ethernet.

The gray mandrels included with the OFTM-561x modules are compliant with TIA/EIA-568-B for 62.5 μm fiber with a 3 mm jacket.

Mandrels for 50 μm fiber are available from Fluke Networks. Refer to the appropriate standard for mandrel requirements if you follow other standards. The OF-500 Technical Reference Handbook provides a partial list of mandrel requirements for TIA and ISO standards.

Figure 20 shows how to wrap the fiber around a mandrel. Place mandrels on the tester's output fibers, as shown in Figures 22 through 29.

In the reference and test connection diagrams shown on the tester, mandrels are indicated by a loop in the fiber.

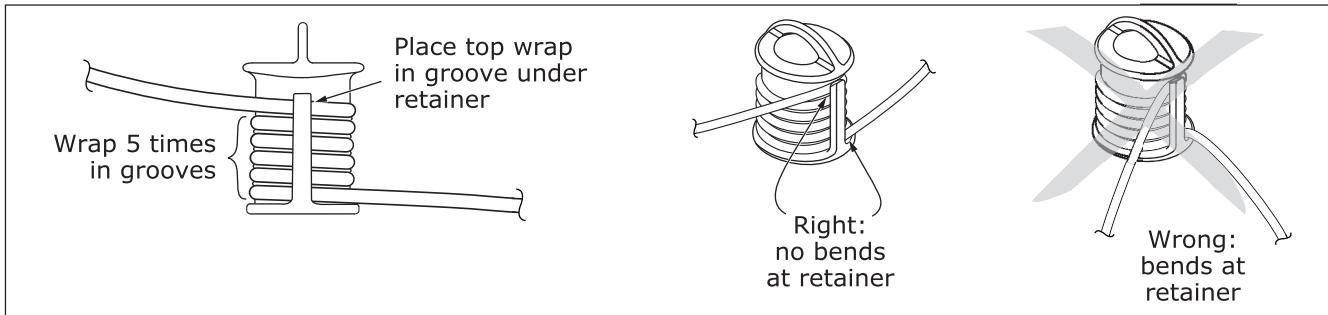

Figure 20. Wrapping a Patch Cord Around a Mandrel

ajt02f.eps

Testing in Smart Remote Mode

Use Smart Remote mode to test and certify dual-fiber cabling. In this mode, the tester measures loss, length, and propagation delay on two fibers at two wavelengths in one or both directions.

Figure 21 shows the equipment needed for testing in Smart Remote mode.

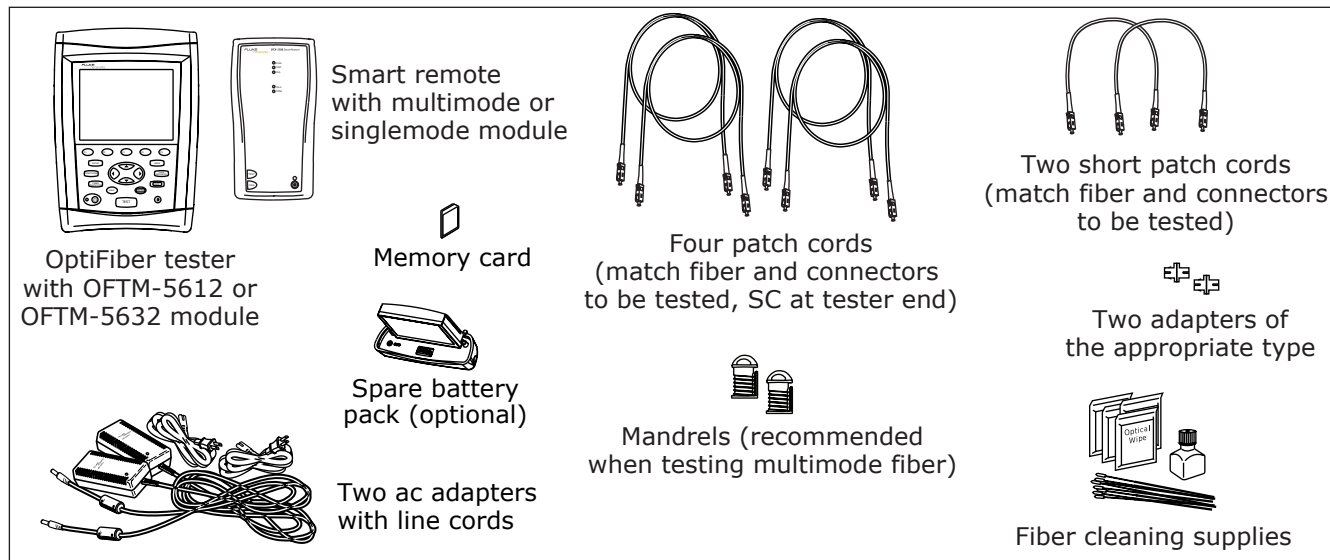

Figure 21. Equipment for Loss/Length Testing in Smart Remote Mode

ajt44f.eps

Quick Steps: Loss/Length Testing in Smart Remote Mode

- 1 Turn on all test equipment and let it warm up for 5 minutes.
- 2 **On the main tester:** On the **HOME** screen, press **F1** **Change Test**; then select **Loss/Length**.
- 3 **On the main tester:** press **SETUP**; then set the following on the **Cable** tab:
 - **FIBER TYPE:** Select the fiber type to be tested.
 - **MANUAL CABLE SETTINGS** (index of refraction and backscatter coefficient): Disable to use the values defined in the selected fiber type, which are suitable for most applications.
- 4 **On the main tester:** set the following on the **Loss/Length** tab in Setup:
 - **TEST LIMIT:** Select an appropriate limit.
 - **REMOTE END SETUP:** Set to **Smart Remote**.
 - **THIS UNIT:** Set to **Main**.
 - **BI-DIRECTIONAL:** Enable this if you want to save bi-directional results.
- **TEST METHOD:** Refers to the number of adapters that are represented in the loss results. Select Method B (multimode) or A.1 (singlemode) if you use the reference and test connections shown in this manual. See the online help or the Technical Reference Handbook for details.
- **CONNECTOR TYPE:** Select connector type used in the cabling to be tested. Select **General** if the exact type is not listed.
- **NUMBER OF ADAPTERS** and **NUMBER OF SPLICES:** Enter the number of adapters and splices that will be added to each direction of the fiber path after the reference is set. See "Setting the Number of Adapters and Splices" on page 49 for details.
- 5 **For an OptiFiber Smart Remote:** set the following on the **Loss/Length** tab in Setup
 - **REMOTE END SETUP:** Set to **Smart Remote**.
 - **THIS UNIT:** Set to **Remote**.

-continued-

Quick Steps: Loss/Length Testing in Smart Remote Mode (cont.)

- 6 Clean the connectors on the tester and the patch cords.
- 7 **On the main tester:** press **FUNCTIONS**; then select **Set Loss/Length Reference**. Connect the reference patch cords as shown on the screen and in Figure 22; then press **ENTER**.
- 8 **Optional:** From the **TEST SETUP** screen, you can enter patch cord lengths to meet TSB-140 reporting requirements:

Use **←** to highlight a patch cord number, press **ENTER**; then enter a length. Press **SAVE** when you are done.
- 9 Press **F3** **OK** to leave the **TEST SETUP** screen.
- 10 **Optional:** To enter the length of the third, short patch cord used in the modified Method B connections shown in this manual, press **F2** **Test Setup** from the **Loss/Length HOME** screen.

-continued-

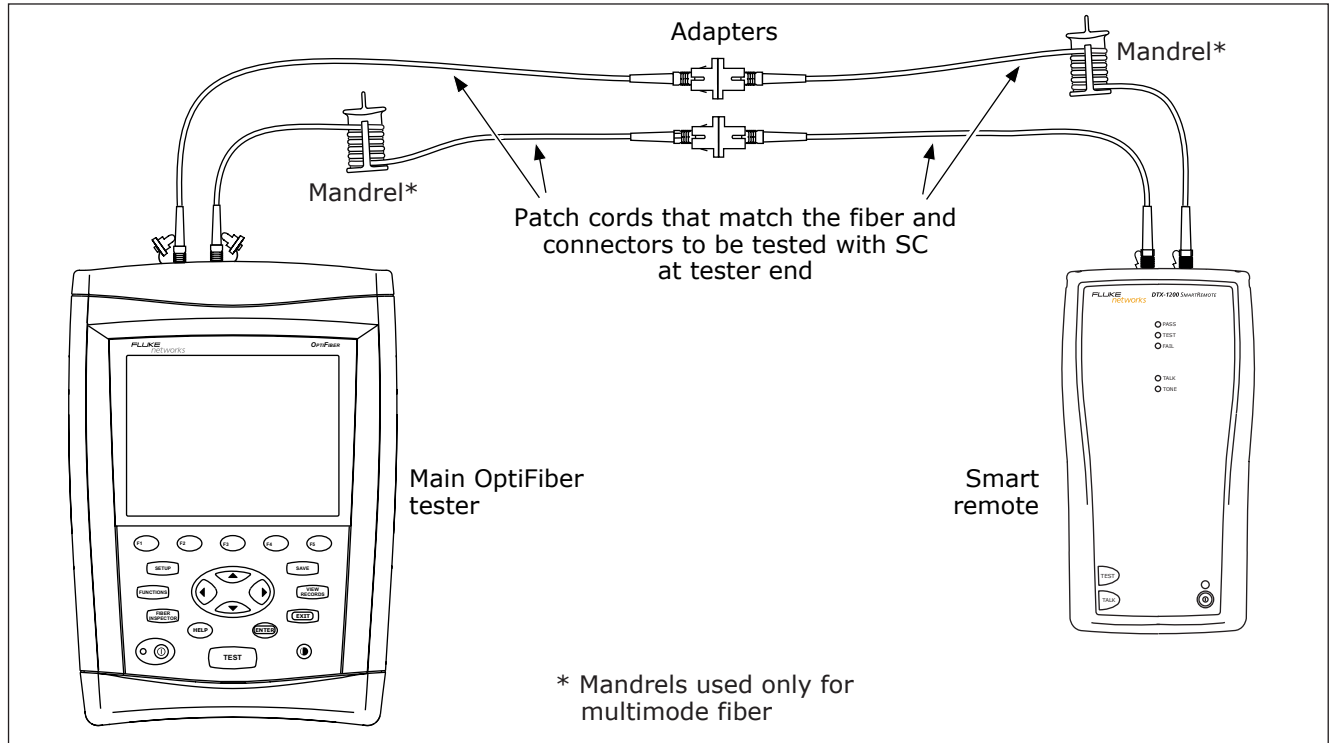

Figure 22. Smart Remote Mode Reference Connections

Quick Steps: Loss/Length Testing in Smart Remote Mode (cont.)

11 Clean the connectors on the cabling to be tested; then connect the reference patch cords and the short patch cords to the cabling, as shown in Figure 23.

12 Press **TEST** to start the loss/length test.

If **Open** or **Unknown** appears as the status, try the following:

- Verify that all connections are good.
- For an OptiFiber smart remote verify that the remote tester is set to **Remote** on its **Loss/Length** tab in Setup.

- Verify that the remote tester is still active. For an OptiFiber smart remote you may need to press **F1** **Start** on the remote tester to reactivate the tester.

- Try different connections to the cabling until the test continues. See "Using FindFiber in Smart Remote Mode" in the online help or Technical Reference Handbook for details on FindFiber messages.

- Use a visible light source to verify fiber continuity.

13 To save the results, press **SAVE**, select or create a fiber ID for the INPUT fiber; then press **SAVE**.

14 Select or create a fiber ID for the OUTPUT fiber; then press **SAVE**.

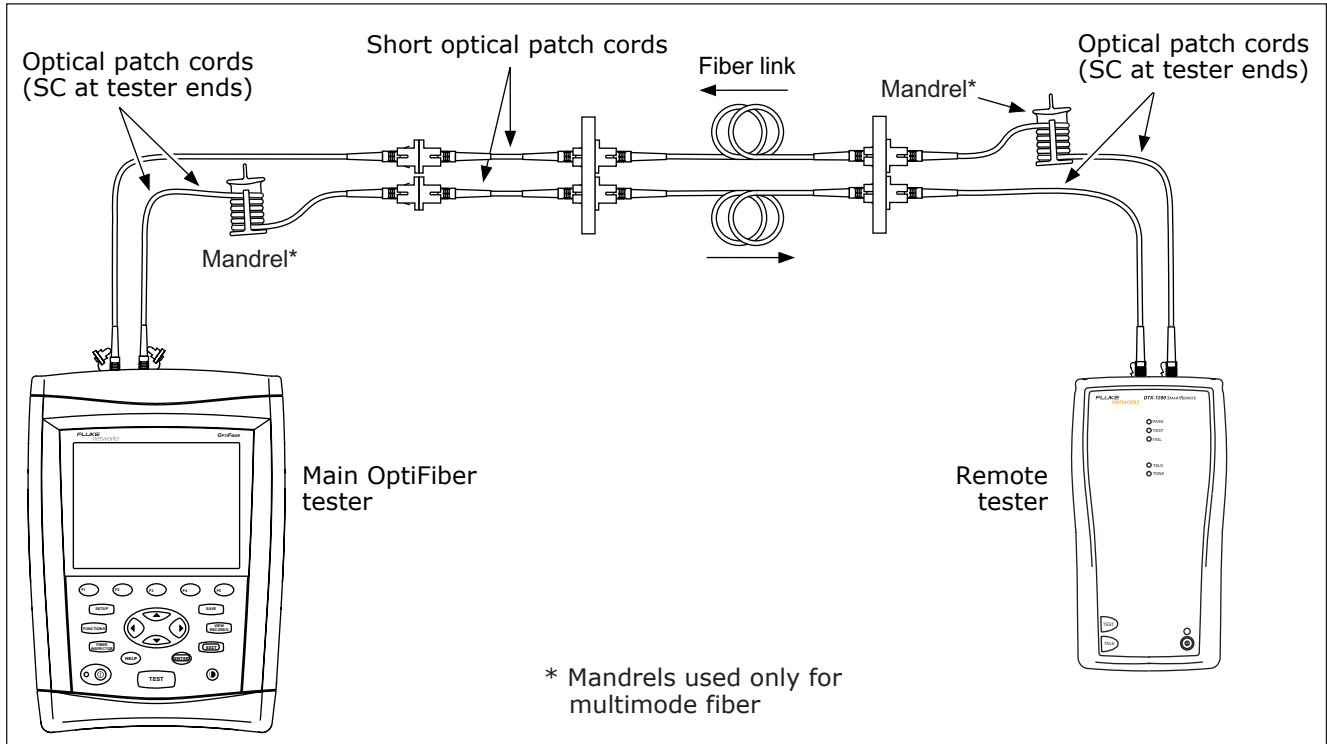

Figure 23. Smart Remote Mode Test Connections

Testing in Loopback Mode

Use Loopback mode to test spools of cable, segments of uninstalled cable, patch cords, and launch fibers.

In this mode, the tester measures loss, length, and propagation delay at two wavelengths in one or both directions.

Figure 24 shows the equipment needed for testing in Loopback mode.

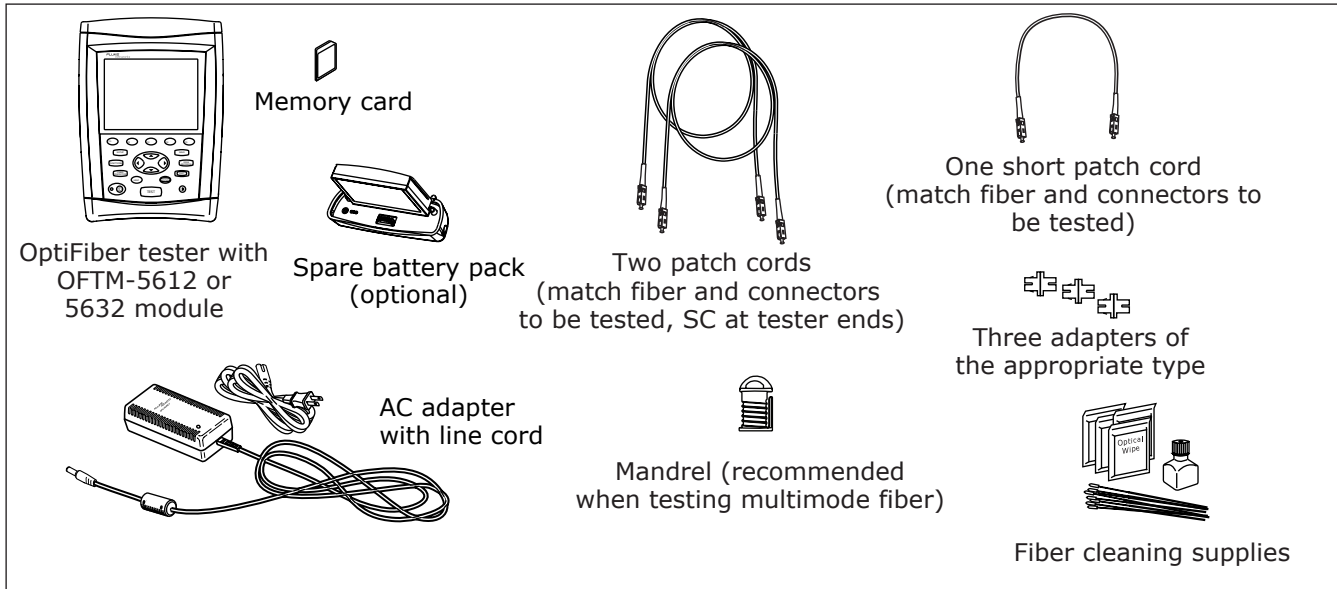

Figure 24. Equipment for Loss/Length Testing in Loopback Mode

ajt45f.eps

Quick Steps: Loss/Length Testing in Loopback Mode

- 1 Turn on the tester and let it warm up for 5 minutes.
- 2 On the **HOME** screen, press **F1** **Change Test**; then select **Loss/Length**.
- 3 Choose settings for the fiber to be tested. Press **SETUP**; then set the following on the tester's **Cable** tab:
 - **FIBER TYPE**: Select the fiber type to be tested.
 - **MANUAL CABLE SETTINGS** (index of refraction and backscatter coefficient): Disable to use the values defined in the selected fiber type, which are suitable for most applications.
- 4 Set the following on the tester's **Loss/Length** tab in Setup:
 - **TEST LIMIT**: Select an appropriate limit.
 - **REMOTE END SETUP**: Set to **Loopback** mode.
 - **THIS UNIT**: Set to **Main**.
 - **BI-DIRECTIONAL**: Enable this setting if you want to save bi-directional results.
- **TEST METHOD**: Refers to the number of adapters that are represented in the loss results. Select Method B (multimode) or A.1 (singlemode) if you use the reference and test connections shown in this manual. See the online help or the Technical Reference Handbook for details.
- **CONNECTOR TYPE**: Select connector type used in the cabling to be tested. Select **General** if the exact type is not listed.
- **NUMBER OF ADAPTERS** and **NUMBER OF SPLICES**: Enter the number of adapters and splices that will be added to the fiber path after the reference is set. See "Setting the Number of Adapters and Splices" on page 49 for details.
- 5 Clean the connectors on the tester and the patch cords.
- 6 Press **FUNCTIONS**; then select **Set Loss/Length Reference**. Connect the reference patch cords as shown on the screen and in Figure 25; then press **ENTER**.

-continued-

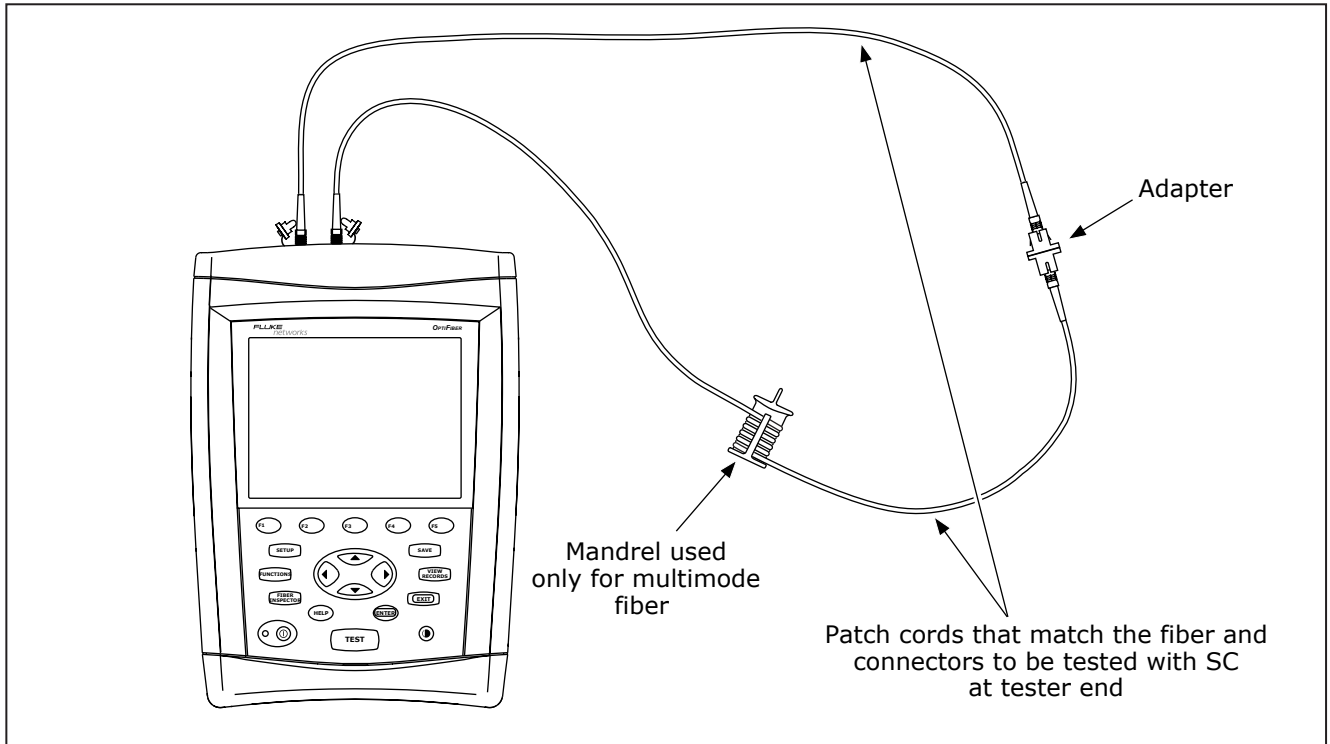



Figure 25. Loopback Mode Reference Connections

ajt06f.eps

Quick Steps: Loss/Length Testing in Loopback Mode (cont.)

7 Optional: From the **TEST SETUP** screen, you can enter patch cord lengths to meet TSB-140 reporting requirements:



Use  to highlight a patch cord number, press ; then enter a length. Press  when you are done.

8 Press  **OK** to leave the **TEST SETUP** screen.

9 Optional: To enter the length of the third, short patch cord used in the modified Method B connections shown in this manual, press  **Test Setup** from the **Loss/Length HOME** screen.

10 Clean the connectors on the cabling to be tested; then connect the reference patch cords and the short patch cord to the cabling, as shown in Figure 26.

11 Press  to start the loss/length test.

12 To save the results, press , select or create a fiber ID; then press .

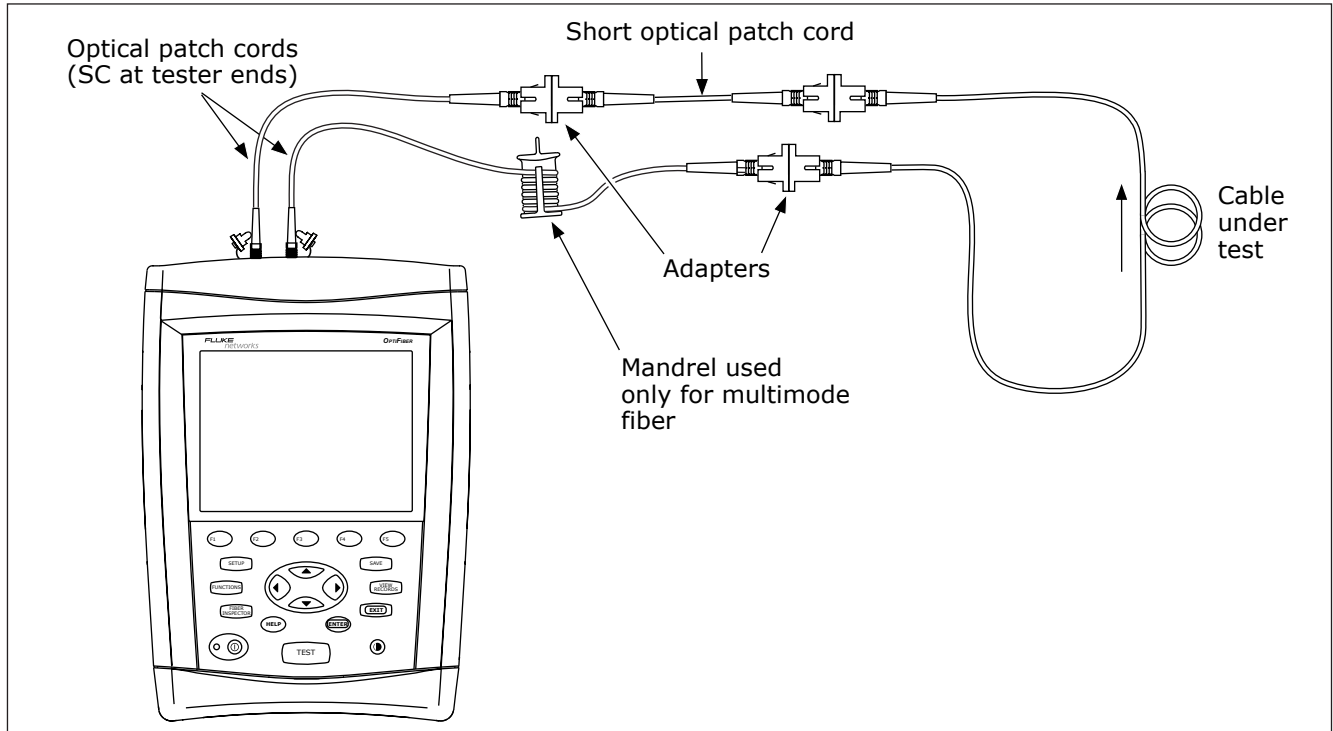

Figure 26. Loopback Mode Test Connections

ajt09f.eps

Testing in Far End Source Mode

Use Far End Source mode to measure power or power loss at one wavelength on individual fibers. A Far End Source mode record can store dual-wavelength results from both directions.

Far End Source mode requires a stand-alone optical source, such as a Fluke Networks DTX Smart Remote with a fiber module, a SimpliFiber® source, or a LS-1310/1550 Laser Source. Far End Source mode is available on the OFTM-56x1 and OFTM-56x2 modules. Figure 27 shows the equipment needed for testing in Far End Source mode.

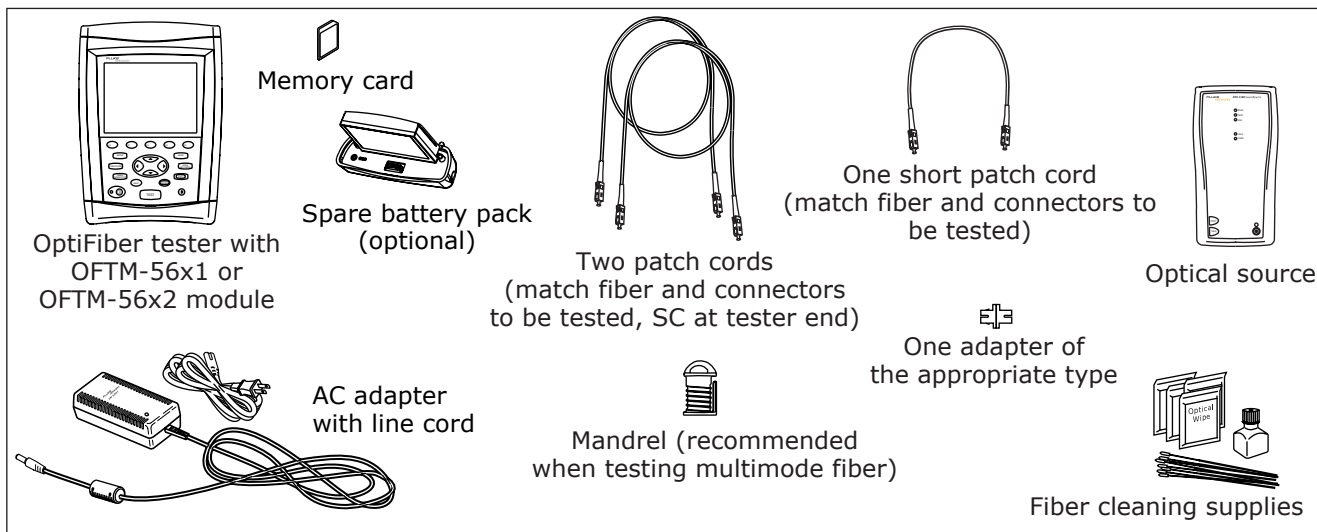

Figure 27. Equipment for Loss Testing in Far End Source Mode

ajt46f.eps

Quick Steps: Loss Testing in Far End Source Mode

- 1 Turn on all test equipment and let it warm up for 5 minutes.
 - 2 Verify the source is set to the correct wavelength and to continuous-wave output.
 - 3 On the **HOME** screen, press **F1** **Change Test**; then select **Loss/Length**.
 - 4 Choose settings for the fiber to be tested. Press **SETUP**; then set the following on the **Cable** tab:
 - **FIBER TYPE:** Select the fiber type to be tested.
 - **MANUAL CABLE SETTINGS** (index of refraction and backscatter coefficient): Disable to use the values defined in the selected fiber type, which are suitable for most applications.
 - 5 Set the following on the **Loss/Length** tab in Setup:
 - **TEST LIMIT:** Select an appropriate limit.
 - **REMOTE END SETUP:** Set to **Far End Source** mode.
- **THIS UNIT:** Set to **Main**.
 - **BI-DIRECTIONAL:** Does not apply to Far End Source mode.
 - **TEST METHOD:** Select the method used for making reference and test connections. This setting does not affect test results, but is saved with results. See the online help or the Technical Reference Handbook for details.
 - **CONNECTOR TYPE:** Select the connector type used in the cabling to be tested. Select **General** if the exact type is not listed.
 - **NUMBER OF ADAPTERS** and **NUMBER OF SPLICES:** Enter the number of adapters and splices that will be added to the fiber path after the reference is set. See “Setting the Number of Adapters and Splices” on page 49 for details.

-continued-

Quick Steps: Loss Testing in Far End Source Mode (cont.)

- 6 Clean the connectors on the tester and the patch cords.
- 7 Press **FUNCTIONS**; then select **Set Loss/Length Reference**. Connect the reference patch cords as shown on the screen and in Figure 28; then press **ENTER**.
- 8 Clean the connectors on the cabling to be tested; then connect the reference patch cords and the short patch cord to the cabling, as shown in Figure 29.
- 9 Press **TEST** to start the loss/length test.
- 10 To save the results, press **SAVE**, select or create a fiber ID; then press **SAVE**.

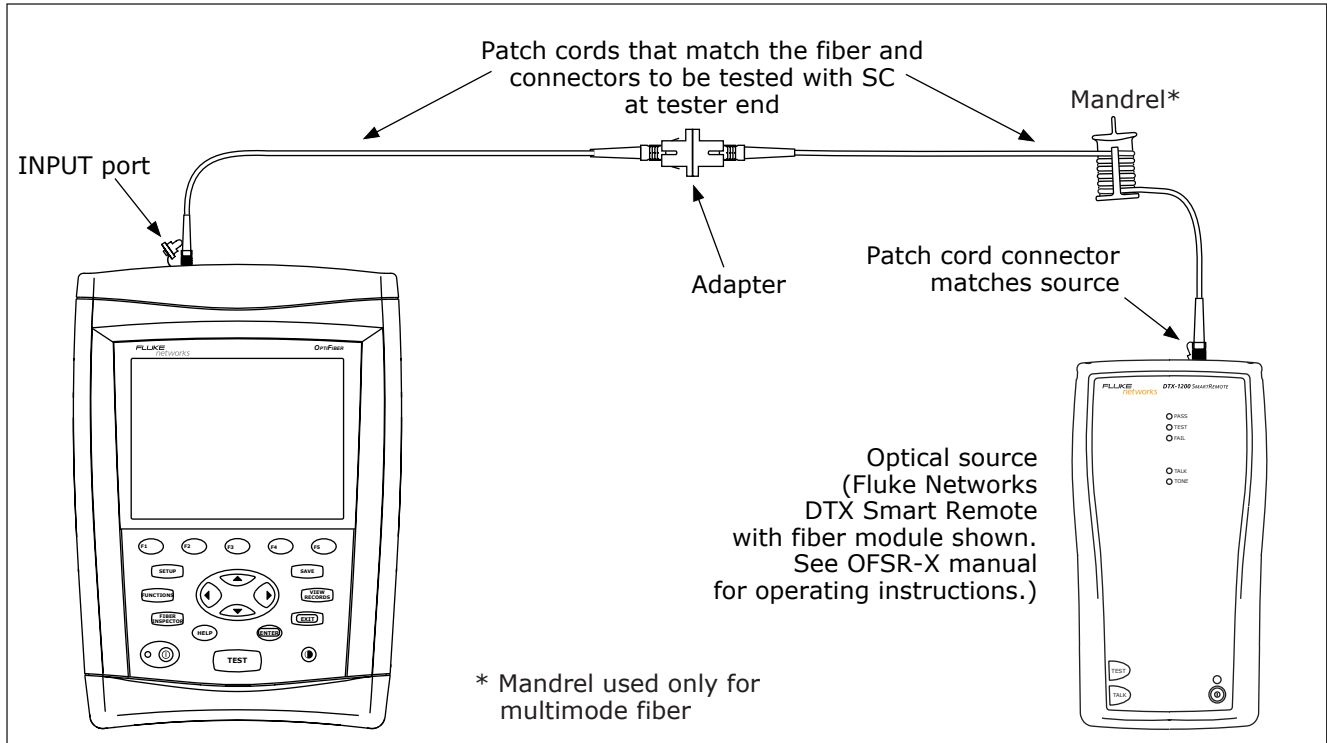

Figure 28. Far End Source Mode Reference Connections

ajt07f.eps

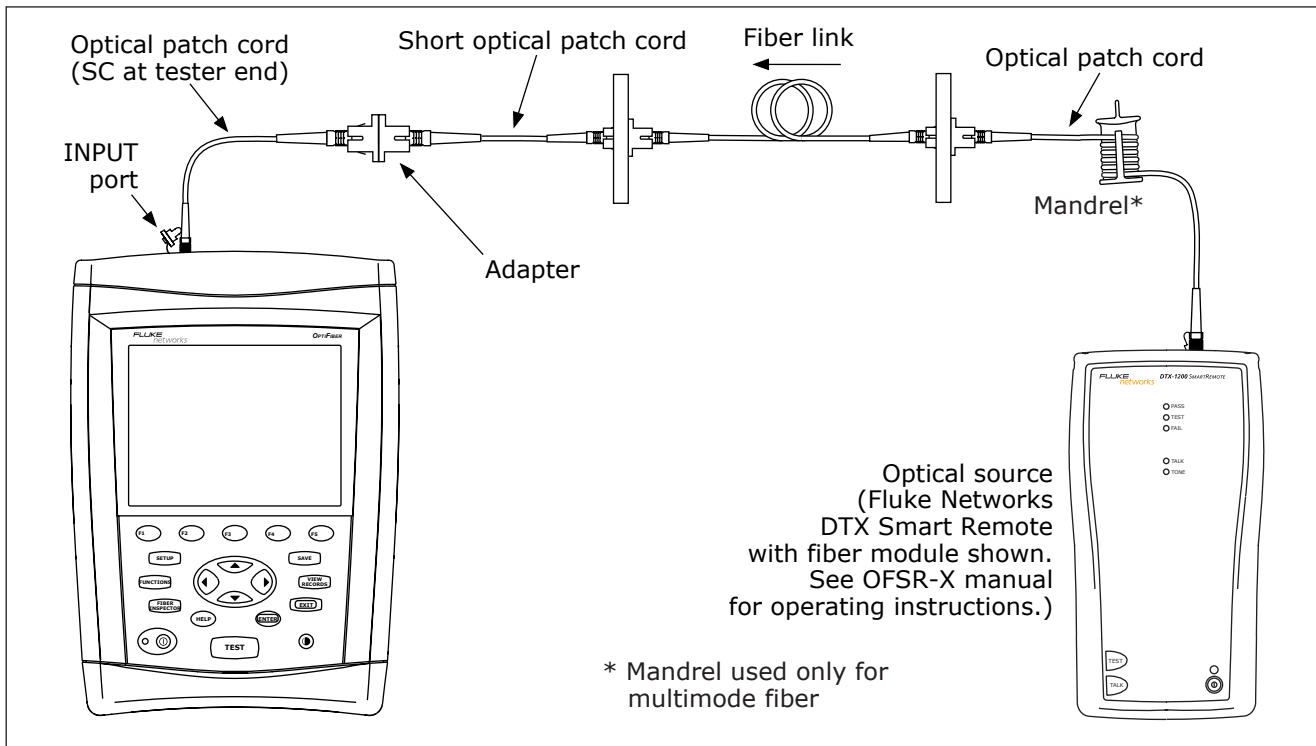

Figure 29. Far End Source Mode Test Connections

ajt10f.eps

Using the Power Meter Option

The power meter option lets you monitor the output power produced by a source such as an optical network interface card or optical test equipment. You can also monitor the power received at the end of the cabling.

You can monitor power at 850 nm, 1300 nm, 1310 nm, and 1550 nm.

The power meter option is available with OFTM-5611, OFTM-5612, OFTM-5631, and OFTM-5632 modules.

Figure 30 shows the equipment needed for using the power meter.

Note

The power meter option also lets you measure loss in Far End Source mode.

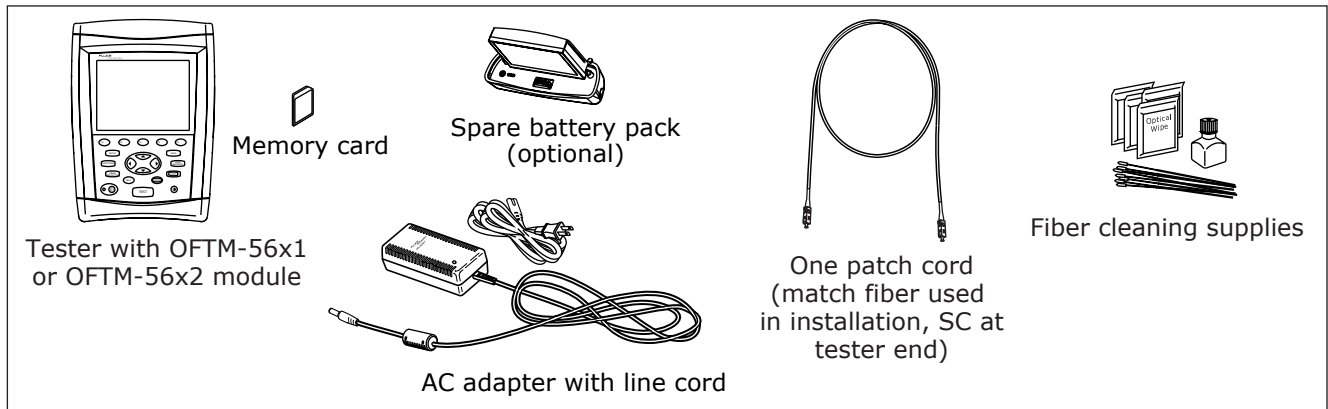

Figure 30. Equipment for Power Meter Tests

ajt47f.eps

Quick Steps: Using the Power Meter

- 1 Select Power Meter mode: On the **HOME** screen, press **F1** **Change Test**; then select **Power Meter**. You do not need to select a fiber type or test limit.
- 2 Clean all connectors that will be used.
- 3 Use the patch cord to connect the source to the tester's INPUT port as shown in Figure 31.
- 4 Turn on the source.
- 5 Press **TEST**; then select the appropriate wavelength. To change the wavelength after starting the test, press **F2** **Change Wavelength**.
- 6 To save the results, press **SAVE**, select or create a fiber ID; then press **SAVE** again.

Caution

If the tester shows an error because the power reading is too high, immediately disconnect the source from the tester. The tester is not designed for measuring higher power levels, such as produced by CATV, optical amplifiers, and cellular systems.

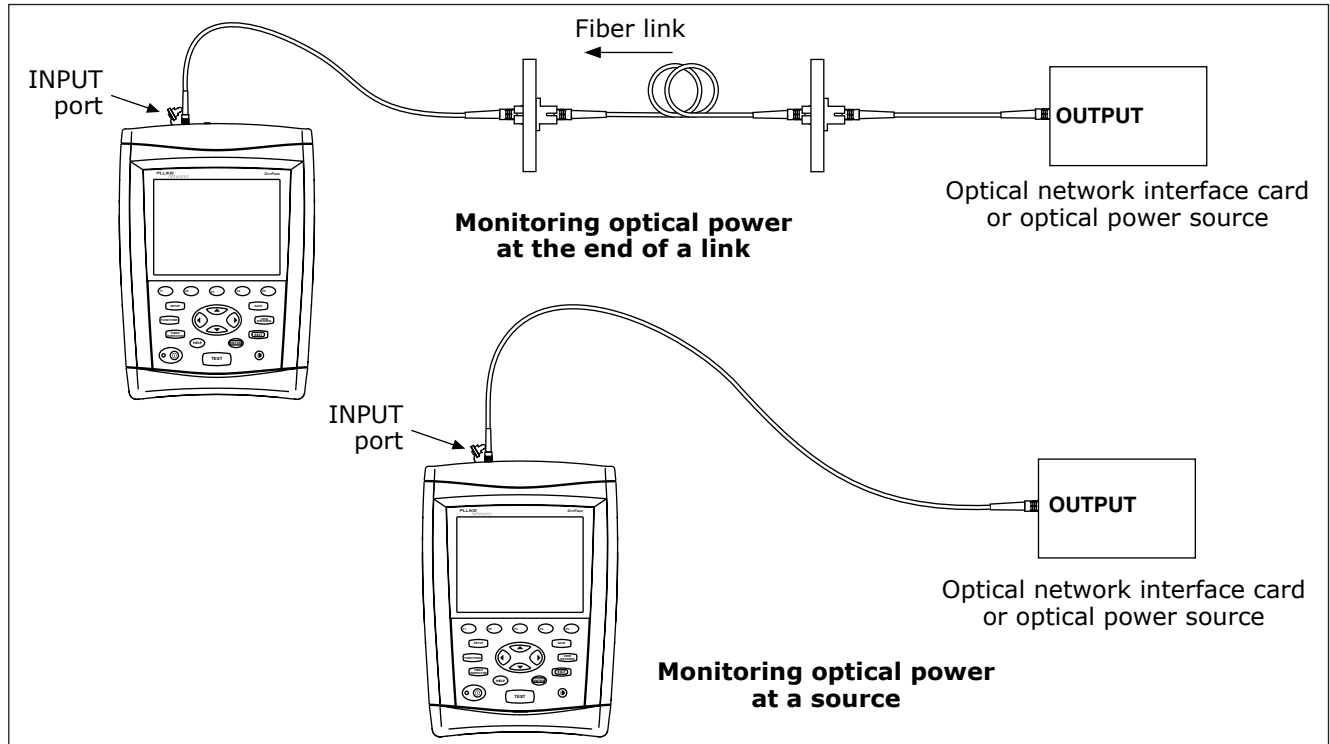

Figure 31. Connections for Monitoring Optical Power

ajt11f.eps

Overview of Memory Functions

You can save test results on a removable memory card or in the tester's internal memory. The tester can use multimedia cards (MMC) or secure digital cards (SD).

To select a location for saving tests, press **SETUP** then select **CURRENT FOLDER** on the **Job** tab.

Tip: To avoid confusion regarding the location of test records, save test results on a memory card whenever possible.

You can save results from any fiber test, except the real time trace.

Each test record can hold bi-directional results from each type of test (except ChannelMap, which you run in just one direction). The test direction assigned to saved results is determined by the **THIS END** setting (in Setup) used when the test was run.

You can save the last test you ran anytime before you run another test. This excludes FiberInspector images and power meter results, which you must save at the time of viewing.

If **SAVE WARNING** on the **System** tab is enabled, the tester warns you if you are about to do something that will delete an unsaved test from temporary memory. The unsaved test is retained in temporary memory even if you turn off the tester or remove the battery pack.

Memory Capacity

The number of test records you can save in a given amount of memory space depends on what you save in the records. For example, records that include video probe endface images take more memory than records without images.

The maximum amount of internal memory available for test results depends on the space taken by the tester's software and custom limits.

Notes

Memory card folders can store a maximum of 500 records each.

Loss/length tests in Smart Remote mode take up two records—one for each fiber.

To see the memory space available, press **FUNCTIONS**; then select **Memory Status**. Press **F1** to switch between the memory card and internal memory status.

Clearing the Internal Memory

To clear the internal memory, which moves records to the memory card, do the following:

- 1 On the **System** tab in Setup, set the **CURRENT FOLDER** to the desired location on the memory card.
- 2 Press **FUNCTIONS**; then select **Empty Internal Memory**.

About LinkWare and LinkWare Stats Software

LinkWare™ Cable Test Management software lets you upload OptiFiber test records to PC, view test results, add ANSI/TIA/EIA-606-A administration information to records, and organize, customize, and print test reports.

Details about using LinkWare software are provided in the LinkWare Getting Started Guide and the online help available under Help on the LinkWare menu.

The LinkWare Stats Statistical Report option for LinkWare software provides statistical analysis of cable test reports and generates browsable, graphical reports. LinkWare software includes a demo version of LinkWare Stats. Contact Fluke Networks or visit the Fluke Networks website for more information on LinkWare Stats.

Maintenance

Warning

To avoid possible fire, electric shock, personal injury, or damage to the tester:

- Do not open the case. No user-serviceable parts are inside.
- Replacing electrical parts yourself will void the test tool's warranty and might compromise its safety features.
- Use only specified replacement parts for user-replaceable items.
- Use only Fluke Networks authorized service centers.

Caution

Replacing electrical parts yourself might void the test tool's calibration and compromise its accuracy. If the calibration is void, cable manufacturers might not extend their warranty to the cabling you install.

Updating the Tester's Software

Keeping your tester's software current gives you access to new features and the latest test limits. Software updates are available on the Fluke Networks website.

The software update procedure also lets you install or remove languages. Additional languages for the tester may be available with software updates.

To see the software version installed in your tester and module exit to the **HOME** display; then press  **Version Info**.

To determine if your tester needs a software update visit the Fluke Networks website to see if an update is available.

You can update an OptiFiber tester's software with LinkWare via a PC or with the tester's software update function via a memory card.

Caution

To avoid unexpected loss of power, connect the ac adapter to the tester when updating the software.

Note

Updating the software does not affect test records saved in internal memory, but may affect factory-installed fiber types or test limits.

You may install multiple languages; however, adding languages decreases the internal memory available for saving test results.

Changes to the update procedure may be posted on the OptiFiber software page on the Fluke Networks website.

Updating via the USB or Serial Port

- 1 Install the latest version of LinkWare software on your PC. LinkWare is available on the Fluke Networks website.
- 2 Download the OptiFiber update file ("upgrade.ofu") from the Fluke Networks website, or contact Fluke Networks to get the update by other means. You can access the software page at www.flukenetworks.com/support. Save the file to your hard drive.
- 3 Connect the tester's serial or USB port to the PC. Install a module in the OptiFiber mainframe, then turn on the tester.
- 4 Select **Utilities > OptiFiber Utilities > Software Update** from the LinkWare menu, locate and select the .ofu (OptiFiber update) file; then click **Open**. LinkWare makes initial choices on which software to install based on the versions currently installed in the mainframe and the module. Generally, you should not change these choices except to select languages to install or remove.
- 5 Click **Start** to start the update process.

- 6 The OptiFiber tester reboots after the update is complete. To verify the update, press  **Version Info** from the **HOME** screen.
- 7 If you have additional modules to update, install each module in the tester and repeat steps 4, 5, and 6.

Updating via a Memory Card Created with LinkWare

Caution



Do not use the Windows® operating system to copy the update file to a memory card. The file must be unzipped first. Use LinkWare software to create a memory card for updating the tester.

- 1 Install the latest version of LinkWare software on your PC. LinkWare is available on the Fluke Networks website.
- 2 Download the OptiFiber update file ("upgrade.ofu") from the Fluke Networks website, or contact Fluke Networks to get the update by other means. You can access the software page at www.flukenetworks.com/support. Save the file to your hard drive.
- 3 Put a memory card into the PC's memory card drive.

- 4 On the LinkWare menu select **Utilities > OptiFiber Utilities > Create Software Update MMC**.
- 5 Locate and select the .ofu file you downloaded; then click **Open**.
- 6 Locate and select the memory card drive; then click **OK**. LinkWare unzips the update file and copies the files to the memory card.

Caution

If you remove the memory card from the MMC reader before the files are completely copied the Windows operating system may report an error and OptiFiber shows the message “Bad update file”. If this happens, repeat steps 4 through 6; then leave the card in the reader for a minute or so to ensure the files are completely copied.

- 7 Put the memory card into the OptiFiber tester.
- 8 Install a module in the OptiFiber mainframe, then turn on the tester.
- 9 Press  on OptiFiber; then select **Install Software Update**. The tester makes initial choices on which software to install based on the versions currently installed in the mainframe and the module. Generally, you should not change these choices except to select languages to install or remove.
- 10 Press  **Start** to start the update process.
- 11 The OptiFiber tester reboots after the update is complete. To verify the update, press  **Version Info** from the **HOME** screen.
- 12 If you have additional modules to update, insert each module and repeat steps 9, 10, and 11.

Optical Connector Care

- Periodically clean and inspect the tester's optical connectors as described on page 25.
- Cover the connectors with the dust plugs when no cable is connected.
- Periodically clean the dust plugs with a lint-free swab or wipe and isopropyl alcohol.

Replacing Patch Cords and Launch Fibers

Choose replacement patch cords and launch and receive fibers that meet the following requirements:

- Core and cladding size: match the fiber to be tested
- Connector polish: PC or UPC for patch cords; UPC for launch fibers
- Patch cord length: minimum 2 m; maximum 5 m
- Launch and receive fiber length: 100 m minimum for multimode; 130 m minimum for singlemode

To ensure optimum performance from your tester, get replacement patch cords and launch fibers from Fluke Networks.

Replacing the Battery

Replace the lithium ion battery pack when its life becomes noticeably shorter. The battery is normally good for up to 400 charge/discharge cycles.



Dispose of the lithium ion battery pack in accordance with local regulations.

An internal lithium battery maintains the tester's clock and other settings when you remove the battery pack. This battery typically lasts about 5 years. When the battery begins to fail, the tester will lose the current date and time when you remove the battery pack. If the lithium battery fails, send the tester to a Fluke Networks service center for a replacement.

Cleaning

Clean the display with glass cleaner or isopropyl alcohol and a soft, lint-free cloth. Clean the case with a soft cloth dampened with water or water and a mild soap.

⚠ Caution

To avoid damaging the display or the case, do not use solvents or abrasive cleansers.

Storage

- Before storing the tester or an extra battery for an extended period, charge the battery to between 70 % and 90 % of full charge (2 or 3 LEDs lit on the battery's gauge). Check the battery every 4 months and recharge if necessary.
- Keep a battery attached to the tester during storage. Removing the battery for long periods shortens the life of the lithium battery that maintains the clock.
- See "Environmental and Regulatory Specifications" on page 87 for storage temperatures.

Calibration

The tester requires a traceable calibration once a year to ensure that it meets or exceeds the published accuracy specifications. Contact an authorized Fluke Networks Service Center for information on getting your tester calibrated.

To see when the tester last received a traceable calibration, press  **Version Info** from the **HOME** display.

If Something Seems Wrong

If something seems wrong with the tester, refer to Table 2.

If the problem continues, refer to “Getting Help” below.





Tip: Online help is available for many error messages. Press  when an error message appears to see information about the error.

Getting Help

If Table 2 does not help you solve a problem with the tester, contact Fluke Networks for additional help. If possible, have the tester’s serial number, software and hardware versions, and calibration date available. Press  **Version Info** from the **HOME** display to see this information.

For warranty information, refer to the warranty at the beginning of this manual. If the warranty has lapsed, contact Fluke Networks for repair prices.

Table 2. Troubleshooting the Tester

Symptom 1: The keypad does not respond.
Press and hold  until the tester turns off. Then turn the tester on again. If the problem persists, try updating the tester's software.
Symptom 2: System error occurs.
Press  OK, or press  for more information. If the tester does not recover, press and hold  until the tester turns off. If the error recurs, update the tester's software. If the tester already has the latest software, contact Fluke Networks for assistance.
Symptom 3: A module is installed, but the message "No Module Installed" or "Problem with Module" shows on the screen.
The module and mainframe may have incompatible software versions. Install the latest software version in the module and mainframe. Verify that the module is pushed completely into the mainframe. Inspect the module and mainframe connectors for contamination or damage.
Symptom 4: The tester will not turn on, even with the ac adapter connected.
The battery may be completely discharged. Let the battery charge for a few minutes with the tester off.
Symptom 5: The tester will not turn on even though the battery is charged.
The battery's safety switch has tripped. Connect the ac adapter for a few minutes to reset the switch.

-continued-

Table 2. Troubleshooting the Tester (cont.)

Symptom 6: The noise level on the OTDR trace has increased or the OTDR connector reflection has a large deadzone. (See Figure 32.)
The fiber endface in the OTDR connector may be dirty or damaged. Clean the connector and inspect the endface with a fiber video microscope. If an endface is damaged, contact Fluke Networks for service information.
Symptom 7: The reference patch cords and adapters are good, but the reference power level is too low.
Clean the tester's INPUT and OUTPUT connectors and use a fiber microscope to inspect the endfaces. If an endface is damaged, contact Fluke Networks for service information.
Symptom 8: A loss/length test produces a negative loss reading.
There is a problem with the reference. Set the reference and test the cabling again. See "Diagnosing Loss/Length Test Failures" in the online help or Chapter 6 of the Technical Reference Handbook for details.
Symptom 9: Test results appear to be incorrect.
The tester may not be configured correctly. If you are using Manual OTDR mode, try testing in Auto OTDR mode. In the Technical Reference Handbook see "Diagnosing OTDR Test Failures" in Chapter 3, "Diagnosing Loss/Length Test Failures" in Chapter 6, and "Power Meter Results" in Chapter 7 for information on how misconfigurations may affect your test results. This information is also provided in the online help.
Symptom 10: The message "Selected test limit or fiber type is not valid with this test" appears.
You need to select a different test limit or fiber type. For details, press  when the message appears.

Signs of a Bad OTDR Connector

Figure 32 shows traces from OTDRs with good and poor OTDR port connections. The tester's OTDR Port

Connection Quality gauge (page 28) lets you know if the connection is poor. Use a fiber microscope to inspect the connector for dirt and damage. If the connector is damaged, contact Fluke Networks for service information.

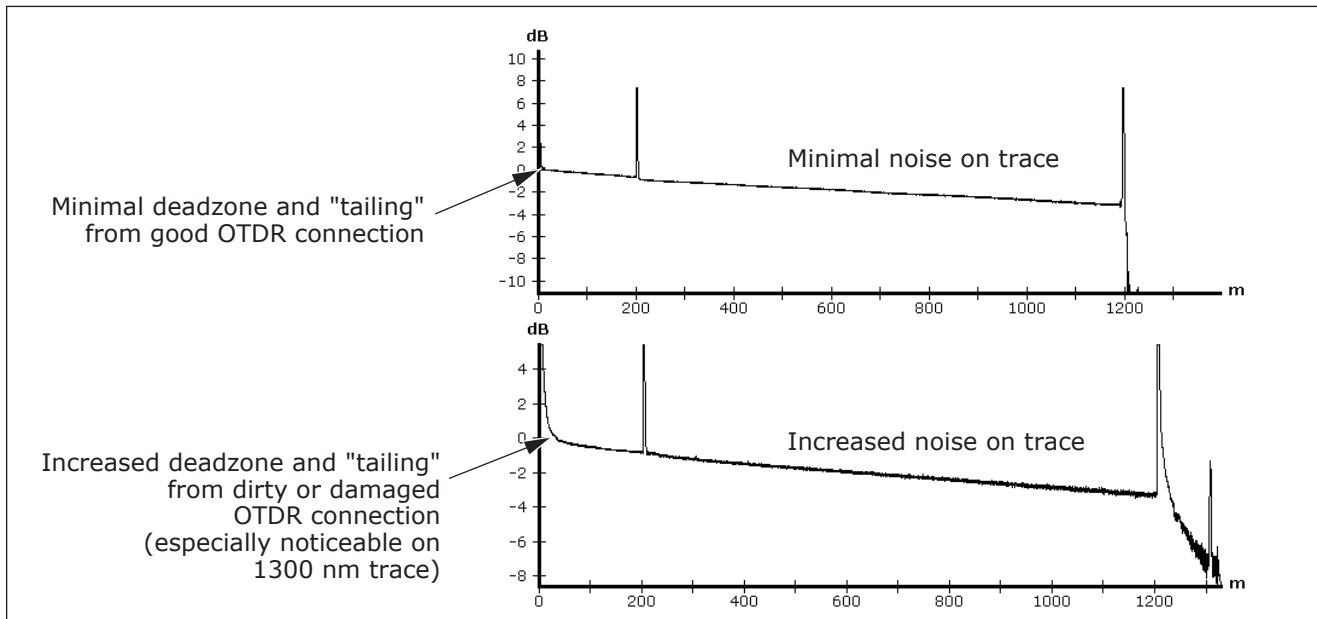

Figure 32. Traces Showing Good and Bad OTDR Connectors

ajt34f.eps

Options and Accessories

To order options and accessories (Tables 3 and 4), contact Fluke Networks.

For the latest list of OptiFiber options and accessories and a complete list of fiber test accessories visit the Fluke Networks website at www.flukenetworks.com.

Table 3. Options

Option	Fluke Networks Model Number
Multimode OTDR module	OFTM-5610
Multimode OTDR module with power meter option	OFTM-5611
Multimode OTDR module with power meter and loss/length options	OFTM-5612
Singlemode OTDR module	OFTM-5630
Singlemode OTDR module with power meter option	OFTM-5631
Singlemode OTDR module with power meter and loss/length options	OFTM-5632
FiberInspector™ Video Probe, 250X and 400X magnifications	OFTM-5352
DTX Smart Remote with multimode module	OFSR-MMREM
Singlemode module for DTX Smart Remote	OFSR-SFM
Multimode module for DTX Smart Remote	OFSR-MFM

Table 4. Accessories

Accessory	Fluke Networks Model Number
32 MB Secure Digital memory card	DTX-SMC32
64 MB Secure Digital memory card	DTX-SMC64
32 MB MultiMedia memory card	DSP-MMC32
Carrying case for up to 8 memory cards	MMC CASE
Memory card reader with USB interface	DSP-MCR-U
Launch fiber, multimode, 62.5 μm , 100 m	NFK1-LAUNCH
Launch fiber, multimode, 50 μm , 100 m	NFK2-LAUNCH
Launch fiber, singlemode, 9 μm , 130 m	NFK3-LAUNCH
Mandrel kit: two mandrels for 50 μm /125 μm fiber with 3 mm jackets; two mandrels for 62.5 μm /125 μm fiber with 3 mm jackets	NF-MANDREL-KIT
Mandrel for 50 μm /125 μm	NF-MANDREL-50
Mandrel for 62.5 μm /125 μm	NF-MANDREL-625
External keyboard	OPV-KB

-continued-

Table 4. Accessories (cont.)

Accessory	Fluke Networks Model Number
AC adapter with line cord (specify country)	OPV-PS
Lithium ion battery pack	OFBP-LI
Soft protective case	OFCC-SCASE
Hard carrying case	OFCC-HCASE
Memory card softcase	MMC-CASE
Fiber optic cleaning kit	NF430
MT-RJ adapter tip for FiberInspector Video Probe	NF360
LC adapter tip for FiberInspector Video Probe	NF362
MU adapter tip for FiberInspector Video Probe	NF364
E2000 adapter tip for FiberInspector Video Probe	NF366

-continued-

Table 4. Accessories (cont.)

Accessory	Fluke Networks Model Number
SimpliFiber® 1310 Source (SC)	8251-11
SimpliFiber® 1550 Source (SC)	8251-12
SimpliFiber® 850/1300 Source (SC)	8251-13
LinkWare™ Cable Test Management Software CD	LinkWare
LinkWare Stats Statistical Report Option	LinkWare-Stats

Specifications

Specifications apply at 23 °C (73 °F), unless otherwise noted.

Environmental and Regulatory Specifications

Operating temperature*	32 °F to 104 °F (0 °C to 40 °C)
Storage temperature	-4 °F to +140 °F (-20 °C to +60 °C)
Operating relative humidity (% RH without condensation)	95 % (50 °F to 95 °F; 10 °C to 35 °C) 75 % (95 °F to 104 °F; 35 °C to 40 °C) uncontrolled < 50 °F (< 10 °C)
Vibration	Random, 2 g, 5 Hz-500 Hz
Shock	1 m drop test with and without module
Safety	CSA C22.2 No. 1010.1: 1992 EN 61010-1 1 st Edition + Amendments 1, 2
Altitude	3000 m
EMC	EN 61326-1
Laser safety	Class I CDRH Complies to EN 60825-2
FDA registration number	0220836
* Real Time Trace function used for no more than 5 minutes in a 15-minute period. Maximum ambient temperature is 35 °C for continuous use of the Real Time Trace function.	

OTDR Specifications

Specification	OFTM-5610, 5611, 5612 Multimode Modules	OFTM-5630, 5631, 5632 Singlemode Modules
Testing speed	< 10 s for two wavelengths at 2 km with 25 cm resolution < 30 s for two wavelengths at 400 m with 3 cm resolution	< 12 s for two wavelengths at 10 km with 1 m resolution < 30 s for two wavelengths at 400 m with 3 cm resolution ¹
Output/input connector	SC with UPC polish	SC with UPC polish (laser-hardened)
Emitter type	Fabry-Perot laser diode	Fabry-Perot laser diode
Laser classification	Class 1	Class 1
Output wavelengths	850 nm ±20 nm 1300 nm ±20 nm	1310 nm ±20 nm 1550 nm ±20 nm
Fiber types tested	50/125 μm or 62.5/125 μm multimode	9/125 μm singlemode
1. For Auto OTDR mode. Manual OTDR mode: < 100 s.		

-continued-

OTDR Specifications (cont.)

Specification	OFTM-5610, 5611, 5612 Multimode Modules	OFTM-5630, 5631, 5632 Singlemode Modules
Event deadzones²	850 nm: 0.7 m typical; 1 m maximum 1300 nm: 1.5 m typical; 2 m maximum	1310/1550 nm: 3 m typical; 3.5 m maximum
Attenuation deadzones³	850 nm: 4.5 m typical; 5.5 m maximum 1300 nm: 10.5 m typical; 15 m maximum	1310/1550 nm: 10.5 m typical; 15 m maximum
Maximum range⁴	850 nm: 3 km 1300 nm: 7 km	1310 nm: 20 km 1550 nm: 20 km
<p>2. Per Telcordia standards (measured at 1.5 dB below reflection peak) for typical connector with PC polish (reflectance < -27 dB multimode and < -50 dB singlemode) using narrowest pulse width (4 ns at 850 nm; 8 ns otherwise) at near end (100 m, which excludes dispersion).</p> <p>3. Per Telcordia standards (measured at ± 0.5 dB beyond backscatter) for typical connector with PC polish (reflectance of < -27 dB multimode and < -50 dB singlemode) using 40 ns pulse width (20 ns at 850 nm) at near end (100 m, which excludes dispersion).</p> <p>4. Distance ranges for typical fiber loss. Manual mode provides a nominal 8 km range for multimode and a 30 km range for singlemode; however, the typical ranges for measuring loss are shown here.</p>		

-continued-

OTDR Specifications (cont.)

Specification	OFTM-5610, 5611, 5612 Multimode Modules	OFTM-5630, 5631, 5632 Singlemode Modules
Dynamic range ⁵	850 nm: >10 dB 1300 nm: >10 dB	1310 nm: > 11 dB 1550 nm: > 9 dB
Output power	850 nm: > 110 mW-pk 1300 nm: > 22 mW-pk	1310 nm: > 38 mW-pk 1550 nm: > 30 mW-pk
Loss threshold ⁶	0.2 dB	0.2 dB
Distance accuracy ⁷	±1 m ±0.005 % of distance ±50 % of resolution ± index of refraction error ± event location error	±1 m ±0.005 % of distance ±50 % of resolution ± index of refraction error ± event location error
Linearity ⁸	±0.07 dB/dB	±0.05 dB/dB
Sampling resolution	3 cm to 50 cm	3 cm to 1 m
<p>5. Displayed dynamic range. Add 0.7 dB to compare to Telcordia dynamic range. Add 2.3 dB to compare to the dynamic range of a signal with a signal-to-noise ratio of 1.</p> <p>6. 6 dB above the noise floor.</p> <p>7. Does not apply to event table.</p> <p>8. Not applicable to OTDR tests using the narrowest pulse width (4 ns at 850 nm; 8 ns otherwise).</p>		

-continued-

OTDR Specifications (cont.)

Specification	OFTM-5610, 5611, 5612 Multimode Modules	OFTM-5630, 5631, 5632 Singlemode Modules
Reflectance accuracy ^{9,10}	± 4 dB	± 4 dB
Optical return loss accuracy ^{9,10}	± 4 dB	± 4 dB
Minimum pulse width ¹¹	850 nm: 4 ns 1300 nm: 8 ns	8 ns
<p>9. Not applicable to OTDR tests using the narrowest pulse width (4 ns at 850 nm; 8 ns otherwise).</p> <p>10. Not applicable to hidden events. Upper limit of -40 dB reflectance typical at the near end (100 m).</p> <p>11. Pulse widths for Manual OTDR mode are given in the Technical Reference Handbook.</p>		

Power Meter Specifications: OFTM-5611, 5612, 5631, 5632

Testing speed, worst case	4.5 s (Far End Source mode)
Input connector	SC
Detector type	InGaAs
Calibrated wavelengths	850 nm, 1310 nm, 1550 nm
Power measurement range	1300/1310 nm and 1550 nm: 0 dBm to -60 dBm 850 nm: 0 dBm to -52 dBm
Display resolution	dB or dBm: 0.01 Linear (μ W): >400: 1 >40: 0.1 >4: 0.01 >0.4: 0.001 \leq 0.4: 0.0001

-continued-

Power Meter Specifications: OFTM-5611, 5612, 5631, 5632 (cont.)

Power measurement uncertainty (accuracy)	$\pm 0.25 \text{ dB}^1$
Measurement linearity (18 °C to 28 °C constant temperature)	1300/1310 nm and 1550 nm: $\pm 0.1 \text{ dB}^2$ 850 nm: $\pm 0.15 \text{ dB}^3$
Re-calibration period	1 year
Display update rate	1 reading per second
<p>1. Under the following conditions:</p> <ul style="list-style-type: none"> • Power level: -20 dBm, continuous wave • At 850 nm: 62.5/125 μm fiber with 0.275 NA • At 1310 nm and 1550 nm: 9 /125 μm • Ambient temperature: 23 °C ± 5 °C 	
<p>2. Linearity for 1300 nm, 1310 nm, and 1550 nm:</p> <ul style="list-style-type: none"> • Between 0 dBm and -55 dBm: $\pm 0.1 \text{ dB}$ • < -55 dBm: $\pm 0.2 \text{ dB}$ 	
<p>3. Linearity for 850 dBm:</p> <ul style="list-style-type: none"> • Between -15 dBm and -52 dBm: $\pm 0.15 \text{ dB}$ typical performance • Between 0 dBm and -15 dBm: $\pm 0.5 \text{ dB}$ typical performance 	

Loss/Length Specifications

Specification	OFTM-5612 Multimode Modules	OFTM-5632 Singlemode Modules
Testing speeds (excluding referencing times)	Far End Source mode: 4.5 s Loopback mode: 5 s typical Smart Remote detection: 3 s Smart Remote mode, unidirectional: 15 s Smart Remote mode, bi-directional: 30 s plus time to swap fibers	Far End Source mode: 4.5 s Loopback mode: 5 s typical Smart Remote detection: 3 s Smart Remote mode, unidirectional: 15 s Smart Remote mode, bi-directional: 30 s plus time to swap fibers
Output/input connectors	SC/SC	SC/SC
Fiber types tested	9/125 μm to 62.5/125 μm multimode	9/125 μm singlemode
Output wavelengths	Multimode LED source: 850 nm and 1300 nm	Laser source: 1310 nm and 1550 nm
Laser classification	Class 1	Class 1
Maximum length measurement	5 km of 50 μm or 62.5 μm multimode fiber (3 km at 850 nm; 7 km at 1300 nm)	20 km of 9 μm singlemode fiber

-continued-

Loss/Length Specifications (cont.)

Specification	OFTM-5612 Multimode Modules	OFTM-5632 Singlemode Modules
Length measurement accuracy	± 1.5 m plus ± 2 % of length	± 1.5 m plus ± 2 % of length
Propagation time accuracy	± 15 ns plus ± 2 % of propagation time	± 15 ns plus ± 2 % of propagation time
Output power (nominal)	> -20 dBm	> -8 dBm
Output power stability over 8-hour period (after 5 minute warmup)	± 0.1 dB at 73 °F (23 °C)	± 0.1 dB at 73 °F (23 °C)
Detector type	InGaAs	InGaAs

-continued-

Loss/Length Specifications (cont.)

Specification	OFTM-5612 Multimode Modules and OFTM-5632 Singlemode Modules
Calibrated wavelengths	850 nm, 1310 nm, 1550 nm
Power measurement range	850 nm: 0 dBm to -52 dBm 1300/1310 nm and 1550 nm: 0 dBm to -60 dBm
Display Resolution	dB or dBm display: 0.01 Linear display (μ W): <ul style="list-style-type: none"> >400: 1 >40: 0.1 >4: 0.01 >0.4: 0.001 0.4: 0.0001

-continued-

Loss/Length Specifications (cont.)

Specification	OFTM-5612 Multimode Modules	OFTM-5632 Singlemode Modules
Power measurement uncertainty (accuracy)	$\pm 0.25 \text{ dB}^1$	$\pm 0.25 \text{ dB}^1$
Measurement linearity (18 °C to 28 °C constant temperature)	1300 nm: $\pm 0.1 \text{ dB}^2$ 850 nm: $\pm 0.15 \text{ dB}^3$	$\pm 0.1 \text{ dB}^2$
Dynamic Range for main-remote communication and nominal length measurement	12 dB	22 dB
Re-calibration period	1 year	1 year
Display update rate	1 reading per second	1 reading per second
<p>1. Under the following conditions:</p> <ul style="list-style-type: none"> • Power level: -20 dBm, continuous wave • At 850 nm: 62.5/125 μm fiber with 0.275 NA • At 1310 nm and 1550 nm: 9 /125 μm • Ambient temperature: 23 °C ± 5 °C <p>2. Linearity for 1300 nm, 1310 nm, and 1550 nm:</p> <ul style="list-style-type: none"> • Between 0 dBm and -55 dBm: $\pm 0.1 \text{ dB}$ • < -55 dBm: $\pm 0.2 \text{ dB}$ <p>3. Linearity for 850 dBm:</p> <ul style="list-style-type: none"> • Between -15 dBm and -52 dBm: $\pm 0.15 \text{ dB}$ typical performance • Between 0 dBm and -15 dBm: $\pm 0.5 \text{ dB}$ typical performance 		

Power

Battery type	Lithium ion battery pack, 7.2 V
Battery life	8 hr Auto OTDR operation with OFTM-5612 module, dual wavelength, 1 test run and saved every 5 minutes, no FiberInspector probe attached, 150 m of fiber
Charge time	6 hours maximum from total discharge

Traceable Calibration Period

To ensure maximum accuracy of test results, have the tester calibrated at a Fluke Networks authorized service center every 12 months.

Certifications and Compliance

 Conforms to relevant European Union directives.

 Listed by the Canadian Standards Association.

Memory for Test Results

Test results can be stored on a removable MultiMediaCard (MMC), Secure Digital (SD) memory card, or in internal memory. Memory card capacity depends on the type of records saved. Typical capacity for a 16 MB card is over 400 OTDR tests.

The amount of internal memory available for test results depends on the space used by the tester's software and custom test limits.

To see the memory space available for different record types on an installed memory card or in internal memory, press ; then select **Memory Status**.

Serial Interfaces

The tester has a USB client interface and an EIA/TIA-232 (RS-232; DB9) interface for uploading test results to a PC and updating the tester's software.

The RS-232 serial port connects to a PC with a null-modem cable. Tables 5 and 6 and show the pin connections for the cable and the 9-to-25-pin adapter available from Fluke Networks.

Table 5. RS-232 Interface Cable Connections

Tester End (female DB9)		Direction	PC End (female DB9)	
Signal Name	Pin		Pin	Signal Name
Data carrier detect	1	←	4	Data terminal ready
Receive data	2	←	3	Transmit data
Transmit data	3	→	2	Receive data
Data terminal ready	4	→	1	Data carrier detect
Signal ground	5	↔	5	Signal ground
Not connected	6		6	Not connected
Request to send	7	→	8	Clear to send
Clear to send	8	←	7	Request to send
Not connected	9		9	Not connected

Table 6. 9-to-25-Pin Adapter

9-pin Connector	25-pin Connector
3	2
2	3
7	4
8	5
6	6
5	7
1	8
4	20
9	22
Shell	Shell

Keyboard Port

Six-pin mini DIN (PS/2)

Video Port for FiberInspector Probe

NTSC input jack

Dimensions (with module and battery installed)

10.6 in x 7.5 in x 2.5 in (26.9 cm x 19.1 cm x 6.4 cm)

Weight (with module and battery installed)

4.5 lb (1.9 kg)

Display

Six-inch diagonal, full VGA, passive color, transmissive LCD with backlight.

Fan

The fan turns on when the module temperature reaches about 95 °F (35 °C) and turns off at about 86 °F (30 °C).

FiberInspector Probe Specifications

Magnification	Switchable between 250X and 400X
Camera type	0.33 in (8.38 mm) CCD with adjustable focus
Light source	LED
Connection to OptiFiber tester	8-pin mini DIN to NTSC video port
Power source	Powered by the OF-500 OptiFiber tester
Lighting technique	Coaxial
Dimensions	1.8 in x 1.7 in x 5.5 in (45.7 mm x 43.2 mm x 140 mm) (length depends on adapter tip)
Weight	0.4 lb (180 g)
Temperature range	Operating: 32 °F to 104 °F (0 °C to 40 °C) Storage: 14 °F to 140 °F (-10 °C to +60 °C)
Humidity range	Operating: 0 % to 45 % RH non-condensing Storage: 0 % to 95 % RH non-condensing
Certifications	 (when used with the OF-500 OptiFiber tester)

—A—

- ac adapter, 10
- accessories
 - optional, 83
 - standard, 3
- Auto OTDR mode, 27

—B—

- battery
 - backup battery, 77
 - charging, 10
 - replacement, 77
 - storage, 78

—C—

- calibration, 78
- cautions, 7
- ChannelMap, 37
 - connections, 39
 - diagram features, 41
 - equipment, 37
 - running the test, 38
- charging the battery, 10
- cleaning
 - display and case, 78
 - fiber connectors, 25
- connectors
 - mainframe, 16
 - maintenance, 77
 - optical connector maintenance, 25
 - OTDR, 16, 28

- power meter, 69
- customer support
 - contacting Fluke Networks, 3
 - if something seems wrong, 79

—D—

- DTX Smart Remote, 47

—F—

- Far End Source mode
 - equipment, 64
 - reference connections, 67
 - test connections, 68
 - test setup, 65, 66
- fiber ID options, 22
- FiberInspector
 - equipment, 43

- image examples, 46
 - using, 44
- Fluke Networks (contacting), 3
- formatting a memory card, 23
- front panel, 14

—H—

- help (customer support), 79
- help screens, 22
- HOME screen, 18

—I—

- ID options, 22
- index of refraction, 30, 53, 60, 65

—K—

- keys, 14

—L—

- language, 12
- launch/receive fiber
 - compensation, 27
 - purpose, 26
 - replacement, 77

- Loopback mode
 - equipment, 58
 - reference connections, 61
 - test connections, 63
 - test setup, 60

- loss/length
 - Far End Source mode, 64
 - Loopback mode, 58
 - Smart Remote mode, 52
- loss/length option, 47

—M—

- maintenance, 73
- mandrels, 51
- manual, 2
- Manual OTDR mode, 27
- memory
 - capacity, 72
 - card or internal, 72
 - clearing internal memory, 73
 - formatting a memory card, 23
- module
 - power meter, 69
 - removing, installing, 12

—N—

- n (index of refraction), 30, 53, 60, 65
- No Module Installed, 80
- NUMBER OF ADAPTERS, 49
- NUMBER OF SPLICES, 49

—O—

- online help, 22
- Open (Smart Remote mode), 56
- options, 83
- OTDR
 - Auto/Manual mode, 27
 - comparing traces, 36
 - connection quality, 28
 - equipment, 29
 - running the test, 30

—P—

- parts, 83
- patch cords
 - replacement, 77
 - testing, 26
- power meter, 69
- powering the tester, 10
- Problem with Module, 80

problems (with the tester), 79

—R—

receive fiber. *See* launch/receive fiber

receive/launch fiber
 compensation, 27

records, 72

reference

- Far End Source mode, 66
- Loopback mode, 60
- Smart Remote mode, 54
- viewing, 48
- when to set, 48

registration, 2

remote, 47

replacement parts, 83

—S—

safety information, 7

SAVE WARNING, 72

saving test results, 72

self-test, 13

serial port, 99

service, 79

SETUP menu, 20

Smart Remote mode

equipment, 52

reference connections, 55

test connections, 57

test setup, 53

software

 updates, 74

 version, 19

specifications, 98

status check, 23

storage, 78

—T—

Technical Reference Handbook, 2

test mode, 19

trace overlay, 36

troubleshooting the tester, 79

—U—

Unknown (Smart Remote mode), 56

updating the software, 74

USB port, 99

—V—

version, 19

—W—

warnings, 7, 73

