



# DTX Compact OTDR™

Optical Time Domain Reflectometry Modules

Users Manual

PN 2823896

May 2007

©2007 Fluke Corporation. All rights reserved. Printed in USA.

All product names are trademarks of their respective companies.

## LIMITED WARRANTY AND LIMITATION OF LIABILITY

Each Fluke Networks product is warranted to be free from defects in material and workmanship under normal use and service. The warranty period for the mainframe is one year and begins on the date of purchase. Parts, accessories, product repairs and services are warranted for 90 days, unless otherwise stated. Ni-Cad, Ni-MH and Li-Ion batteries, cables or other peripherals are all considered parts or accessories. The warranty extends only to the original buyer or end user customer of a Fluke Networks authorized reseller, and does not apply to any product which, in Fluke Networks' opinion, has been misused, abused, altered, neglected, contaminated, or damaged by accident or abnormal conditions of operation or handling. Fluke Networks warrants that software will operate substantially in accordance with its functional specifications for 90 days and that it has been properly recorded on non-defective media. Fluke Networks does not warrant that software will be error free or operate without interruption.

Fluke Networks authorized resellers shall extend this warranty on new and unused products to end-user customers only but have no authority to extend a greater or different warranty on behalf of Fluke Networks. Warranty support is available only if product is purchased through a Fluke Networks authorized sales outlet or Buyer has paid the applicable international price. Fluke Networks reserves the right to invoice Buyer for importation costs of repair/replacement parts when product purchased in one country is submitted for repair in another country.

Fluke Networks warranty obligation is limited, at Fluke Networks option, to refund of the purchase price, free of charge repair, or replacement of a defective product which is returned to a Fluke Networks authorized service center within the warranty period.

To obtain warranty service, contact your nearest Fluke Networks authorized service center to obtain return authorization information, then send the product to that service center, with a description of the difficulty, postage and insurance prepaid (FOB destination). Fluke Networks assumes no risk for damage in transit. Following warranty repair, the product will be returned to Buyer, transportation prepaid (FOB destination). If Fluke Networks determines that failure was caused by neglect, misuse, contamination, alteration, accident or abnormal condition of operation or handling, or normal wear and tear of mechanical components, Fluke Networks will provide an estimate of repair costs and obtain authorization before commencing the work. Following repair, the product will be returned to the Buyer transportation prepaid and the Buyer will be billed for the repair and return transportation charges (FOB Shipping point).

THIS WARRANTY IS BUYER'S SOLE AND EXCLUSIVE REMEDY AND IS IN LIEU OF ALL OTHER WARRANTIES, EXPRESS OR IMPLIED, INCLUDING BUT NOT LIMITED TO ANY IMPLIED WARRANTY OR MERCHANTABILITY OR FITNESS FOR A PARTICULAR PURPOSE. FLUKE NETWORKS SHALL NOT BE LIABLE FOR ANY SPECIAL, INDIRECT, INCIDENTAL OR CONSEQUENTIAL DAMAGES OR LOSSES, INCLUDING LOSS OF DATA, ARISING FROM ANY CAUSE OR THEORY.

Since some countries or states do not allow limitation of the term of an implied warranty, or exclusion or limitation of incidental or consequential damages, the limitations and exclusions of this warranty may not apply to every buyer. If any provision of this Warranty is held invalid or unenforceable by a court or other decision-maker of competent jurisdiction, such holding will not affect the validity or enforceability of any other provision.

4/04

Fluke Networks  
PO Box 777  
Everett, WA 98206-0777  
USA

# Table of Contents

<b>Title</b>	<b>Page</b>
Overview of Features .....	1
Registration .....	1
Contacting Fluke Networks .....	2
Safety Information .....	2
Installing the DTX Compact OTDR Module .....	4
Using the Cradle .....	6
Software Requirements .....	6
OTDR Module Features .....	7
Cleaning Connectors and Adapters .....	8
OTDR Test Settings .....	9
Using the OTDR .....	15
About Launch and Receive Fibers and Launch Compensation .....	16
Running the OTDR Test .....	17
Viewing the OTDR Trace .....	22
Using the Visual Fault Locator .....	26
Maintenance .....	29
Inspecting the OTDR Ports .....	29
Cleaning the OTDR Ports .....	29
Certifications, Compliance, and Regulatory Information .....	30

**DTX Compact OTDR Modules**  
Users Manual

---

Index ..... 31

# List of Figures

Figure		Page
1	Installing the OTDR Module .....	5
2	Using the Cradle.....	6
3	OTDR Module Features .....	7
4	Equipment for the OTDR Test .....	15
5	Connecting the OTDR to Installed Fiber (no receive fiber).....	18
6	Connecting the OTDR to Installed Fiber (with receive fiber) .....	19
7	Connecting the OTDR to Spooled Cable.....	20
8	OTDR Results Screen .....	21
9	OTDR Trace Screens (launch compensation disabled).....	22
10	Typical OTDR Trace Features .....	24
11	Equipment for Using the Visual Fault Locator .....	27
12	Using the Visual Fault Locator.....	28
13	Cleaning the OTDR Ports .....	29



# DTX Compact OTDR Modules

## Overview of Features

The optional DTX Compact OTDR™ Optical Time Domain Reflectometry modules are used with a DTX Series CableAnalyzer™ to locate and characterize reflective and loss events in optical fibers. The modules offer the following features:

- Automated OTDR trace and event analysis help you locate and analyze reflective and loss events on multimode (850 nm and 1300 nm; 50 μm and 62.5 μm) and singlemode (1310 nm and 1550 nm; 9 μm) fiber.
- Display OTDR results in summary format, as a table of events, or as an OTDR trace. PASS/FAIL results are based on factory-installed limits or limits you specify.
- Visual fault locator helps you locate breaks, bad splices, bends, and check fiber continuity and polarity.

## Registration

Registering your product with Fluke Networks gives you access to valuable information on product updates, troubleshooting tips, and other support services. To register, fill out the online registration form on the Fluke Networks website at [www.flukenetworks.com/registration](http://www.flukenetworks.com/registration).

## Contacting Fluke Networks

 [www.flukenetworks.com](http://www.flukenetworks.com)

 [support@flukenetworks.com](mailto:support@flukenetworks.com)

 +1-425-446-4519





- Australia: 61 (2) 8850-3333 or 61 (3) 9329 0244
- Beijing: 86 (10) 6512-3435
- Brazil: 11 3044 1277
- Canada: 1-800-363-5853
- Europe: +44-(0)1923 281 300
- Hong Kong: 852 2721-3228
- Japan: 03-3434-0510
- Korea: 82 2 539-6311
- Singapore: +65-6799-5566
- Taiwan: (886) 2-227-83199
- USA: 1-800-283-5853

Visit our website for a complete list of phone numbers.

## Safety Information

Table 1 describes the international electrical symbols used on the tester and in this manual.

**Table 1. International Electrical Symbols**

	Warning or Caution: risk of damage or destruction to equipment or software. See explanations in the manual.
	Warning: Risk of electric shock.
	Warning: Class 1 laser (OUTPUT port). Risk of eye damage from hazardous radiation.
	This equipment not for connection to public communications networks, such as active telephone systems.
	Do not put products containing circuit boards into the garbage. Dispose of circuits boards in accordance with local regulations.



 **Warning**

To avoid possible eye damage caused by hazardous radiation and to avoid possible fire, electric shock, or personal injury:

- Never look directly into optical connectors. Some sources produce invisible radiation that can permanently damage your eyes.
- Never run any tests that activate the OTDR or VFL outputs unless a fiber is attached to the port.
- Do not use magnification to view the optical outputs without proper filtering.
- Use of controls, adjustments, or procedures not stated herein might result in hazardous radiation exposure.

 **Caution**

To avoid damaging the tester or cables under test, to avoid data loss, and to ensure maximum accuracy of test results:

- Turn off the tester before attaching or removing modules.
- Leave the module bay covers in place when a module is not installed.

- Use proper cleaning procedures to clean all fiber connectors before every use. Neglecting this step or using improper procedures can cause unreliable test results and may permanently damage the connectors.
- Cover all connectors with protective caps when not in use.
- For modules that support two wavelengths, never run a test with a fiber connected to the unused port. Reflections from the fiber can affect measurements on the port being used.
- Never connect the OTDR port to an optical source. Doing so can damage the OTDR receiver.
- Never connect the OTDR to an active network. Doing so causes unreliable test results and can disrupt network operations.
- Avoid touching reflective surfaces (such as metal) to the end of a fiber cable plugged into the OTDR when the OTDR is operating. An open fiber connector end face has about a 4% reflection. Holding a reflective surface near the connector end face may cause much greater than a 4% reflection, which may damage the photodetector in the OTDR.

- **Read the instructions for splice machines before using the OTDR to monitor splicing procedures. The OTDR can interfere with the light injection detection techniques used by some splicers.**

## **Installing the DTX Compact OTDR Module**

### **Caution**

**To avoid damaging the DTX mainframe or the OTDR module and to ensure proper operation:**

- **Turn off the tester before removing or attaching modules.**
- **Leave the module bay cover in place when a module is not installed.**

To install the module, refer to Figure 1 and do the following:

- ① Turn off the tester.
- ② Remove and discard the standard bail.
- ③ Install the bail included with the DTX Compact OTDR module. This new bail has a keyed hole at the bottom where the OTDR module locks onto the bail.
- ④ Remove the module bay cover or the module currently attached to the tester.
- ⑤ Slide the OTDR module onto the tester.
- ⑥ Push the locking pin into the keyed hole in the bail; then turn the pin 1/4 turn to the right to lock the module onto the bail.

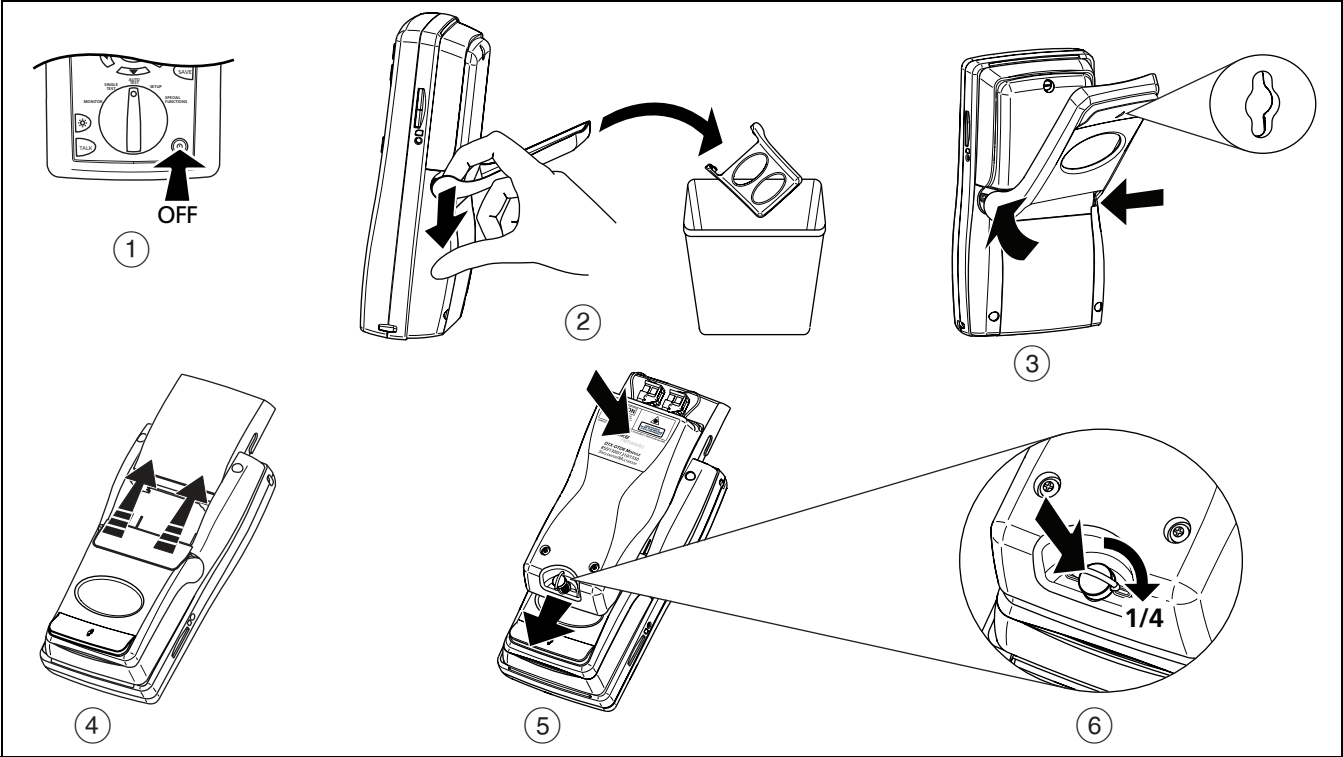
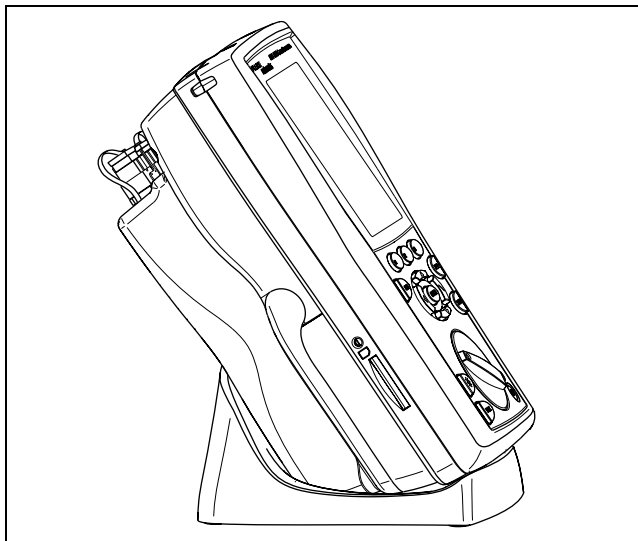

Figure 1. Installing the OTDR Module

amd157f.eps

## Using the Cradle

Figure 2 shows how to use the cradle to stand the tester up on a flat surface when a DTX Compact OTDR module is attached.



amd165.eps

**Figure 2. Using the Cradle**

## Software Requirements

The following software supports the DTX Compact OTDR module. Software upgrades are available on the Fluke Networks website.

- DTX software: version 2.0 or higher.
- LinkWare™ software: version 3.0 or higher.

See the *DTX CableAnalyzer Users Manual* for instructions on updating the tester's software.

### Notes

*Update the software with the OTDR module attached to the tester.*

*If your tester's software version is lower than 2.0, you will need to do the software update procedure twice.*

## OTDR Module Features

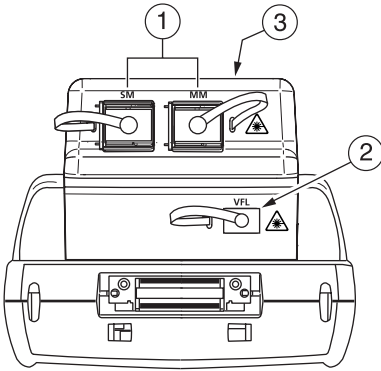

**Warning**

Never look directly into optical output connectors (1) and (2). Some sources produce invisible radiation that can permanently damage your eyes.

amd155f.eps

- ① OTDR ports for singlemode (left) and multimode (right) fiber. The ports have removable SC connector adapters with protective caps.
- ② Visual fault locator (VFL) output with universal fiber connector and protective cap. The connector accepts 2.5 mm ferrules.
- ③ Laser safety label (shown below):

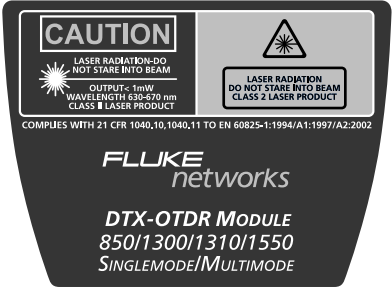

amd156f.eps

Figure 3. OTDR Module Features

## Cleaning Connectors and Adapters

Always clean and inspect fiber connectors before making connections. Use fiber optic solvent and optical-grade wipes or swabs to clean connectors as follows:

### Cleaning Bulkhead Connectors

- 1 Touch the tip of a fiber optic solvent pen or swab soaked in solvent to a lint-free dry wipe or fiber cleaning card.
- 2 Touch a new, dry swab to the solvent spot on the wipe or card. Push the swab into the connector, twist it around 3 to 5 times against the end-face, then remove and dispose of the swab.
- 3 Dry the connector with a dry swab by twisting it around in the connector 3 to 5 times.
- 4 Inspect connectors with a fiber microscope, such as the Fluke Networks FiberInspector™ Video Microscope before making connections.

### Cleaning Fiber Adapters

Periodically clean fiber adapters with a swab and fiber optic solvent. Dry with a dry swab before use.

### Cleaning Connector Ends

- 1 Touch the tip of a fiber optic solvent pen or swab soaked in solvent to a lint-free dry wipe or fiber cleaning card.
- 2 Wipe the connector end-face across the solvent spot, then back and forth once across the dry area of the wipe or card.



*Note*

*Some connector styles, such as VF-45, may require a different cleaning method.*

Always cover unused connectors with protective caps. Clean caps periodically with a swab or wipe and fiber optic solvent.

## OTDR Test Settings

To access the OTDR test settings described in Table 2 (except the Auto/Manual setting),

turn the rotary switch to **SETUP**; then select **Fiber OTDR**. Use   to move among the tabs of settings.

**Table 2. OTDR Test Settings**

Setting	Description
<b>Auto/Manual</b>	Press  <b>Change Test</b> from the main Autotest screen. In <b>Auto</b> mode, the tester selects certain settings based on the length and overall loss of the cabling. <b>Manual</b> mode lets you select the settings to optimize the trace for displaying specific events.
Job settings	Before running a test you will save, you may want to set up a storage location and enter <b>Operator</b> , <b>Site</b> , and <b>Company</b> names. See the <i>DTX CableAnalyzer Users Manual</i> or <i>Technical Reference Handbook</i> for details.
<b>OTDR Port</b>	Select <b>Multimode</b> or <b>Singlemode</b> to view or edit those settings.
<b>Test Limit</b>	The tester compares the OTDR test results to the selected test limit to produce <b>PASS/FAIL</b> results. You can select factory-installed limits or custom limits. Selecting <b>Custom</b> lets you create a test limit. See the <i>Technical Reference Handbook</i> for details.
<b>Fiber Type</b>	Select a fiber type that is appropriate for the fiber you will test. You can select factory-installed fiber types or custom types. Selecting <b>Custom</b> lets you create a fiber type. See the <i>Technical Reference Handbook</i> for details.

-continued-

Table 2. OTDR Test Settings (cont.)

Setting	Description
<b>Wavelength</b>	<p>You can test cabling at one or all the wavelengths supported by the installed module and the selected test limit.</p> <p style="text-align: center;"><i>Note</i></p> <p style="text-align: center;"><i>If you select the dual-wavelength setting, be sure to select a fiber type and test limit that supports both wavelengths.</i></p>
<b>Launch Compensation</b>	Lets you remove the effects of launch and receive fibers from OTDR results. See page 16.
<b>Testing From</b>	The cable end where the tester is located. Based on this setting, the tester labels OTDR results as <b>End 1</b> or <b>End 2</b> to indicate which end of the cabling you tested.
<b>End 1, End 2</b>	Names you assign to the ends of the cabling. The names are saved with OTDR results.
<b>Fiber Characteristics</b>	When <b>Fiber Characteristics</b> is set to <b>User Defined</b> , the <b>n</b> and <b>Backscatter</b> values can be edited by the user. When the <b>Fiber Characteristics</b> is set to <b>Default</b> , the tester uses the values defined in the current <b>Fiber Type</b> .



Table 2. OTDR Test Settings (cont.)

Setting	Description
<b>n</b>	Index of refraction, which is used to calculate length. The default <b>n</b> values defined in the fiber types are suitable for most applications. Minor differences between the default <b>n</b> and a fiber's actual <b>n</b> usually do not make enough difference in length to fail a fiber. Increasing <b>n</b> decreases measured length.
<b>Backscatter</b>	<p><b>Backscatter</b> is the backscatter coefficient, which indicates the amount of light the fiber reflects back to the OTDR (using a 1 ns pulse). This value is used to calculate event reflectance for OTDR tests.</p> <p>Enter the backscatter coefficient of the fiber under test, if known.</p>
<b>Range</b> (Manual OTDR mode only)	<p>The range setting determines the maximum distance shown on the trace. Select the range that is nearest to, but not less than, the distance to the event you want to study. If the tester does not correctly identify the end event, run the OTDR test again using the next higher range.</p> <p><b>Manual:</b> Lets you select the range.</p> <p><b>Auto:</b> The tester selects the range that is nearest to, but not less than the end of the fiber. These ranges are not limited to the fixed ranges provided.</p>

-continued-

Table 2. OTDR Test Settings (cont.)

Setting	Description
<b>Averaging Time</b> (Manual OTDR mode only)	<p>The averaging time sets the number of measurements averaged together to create the final trace. Longer times reduce noise on the trace which increases dynamic range and accuracy and reveals more details, such as smaller non-reflective events. Shorter times decrease test time, but produce a noisier trace with less dynamic range and decreased visibility of events.</p> <p><b>Auto:</b> Adjusts the test parameters for a typical test time of 15 seconds per wavelength. This setting is used for <b>Auto OTDR</b> mode and is the default for <b>Manual OTDR</b> mode.</p> <p><b>Auto Test Time:</b> Adjusts the test parameters for a typical test time of 5 seconds per wavelength. This setting speeds up testing but provides less accuracy and increased deadzones.</p> <p><b>Auto Deadzone:</b> Adjusts the test parameters to minimize deadzones, which reveals more detail in and around reflective events. This usually takes longer than testing with <b>Auto</b> or <b>Auto Test Time</b> selected.</p> <p>Testing with <b>Auto</b>, <b>Auto Test Time</b>, or <b>Auto Deadzone</b> selected can take up to 3 minutes per wavelength, depending on the fiber's characteristics.</p> <p>Manual time selections: Lets you set the test time to 15 seconds, 30 seconds, 1 minute, or 3 minutes per wavelength. The tester adjusts the test parameters to meet the selected time.</p>

Table 2. OTDR Test Settings (cont.)

Setting	Description
<b>Pulse Width</b> (Manual OTDR mode only)	<p>The pulse width affects the deadzones of the trace and the dynamic range.</p> <p>Narrower pulses let you see more detail in and around reflective events and help you see events that are close together (hidden events). However, narrower pulses limit the OTDR's range and produce traces with more background noise between events. With narrower pulses, you may not be able to distinguish small loss events from the noise on the trace. The backscatter level may be so low that it does not appear on the trace.</p> <p>Wider pulses raise the backscatter level, which lets you measure longer fibers and provides a better signal-to-noise ratio around events. This helps you see smaller loss events and measure their loss more accurately, but increases the deadzones of events.</p> <p><b>Auto:</b> The tester selects the narrowest pulse that still reveals loss events.</p>

-continued-

Table 2. OTDR Test Settings (cont.)

Setting	Description
<b>Loss Threshold</b> (Manual OTDR mode only)	<p><b>User Defined</b> lets you set the threshold (in decibels) for reporting loss events. Events at or above the threshold are included in the event table. The range for this setting is 0.01 dB to 1.50 dB inclusive.</p> <p>For smaller threshold values (0.01 dB to 0.3 dB), the tester reduces noise on the trace by taking more measurements for averaging or by using wider pulse widths. Therefore, smaller values may increase test times or deadzones on the trace.</p> <p><b>Auto</b> sets the threshold to the default value of 0.15 dB.</p> <p style="text-align: center;"><i>Note</i></p> <p><i>Setting a loss threshold does not guarantee that all events at or above the threshold will be found. The fiber's characteristics or using a manual <b>Averaging Time</b> or <b>Pulse Width</b> may also limit which events are found.</i></p> <p>If the loss threshold is set to less than 0.15 dB, the tester may find many false events due to inherent imperfections in the fiber.</p>

## Using the OTDR

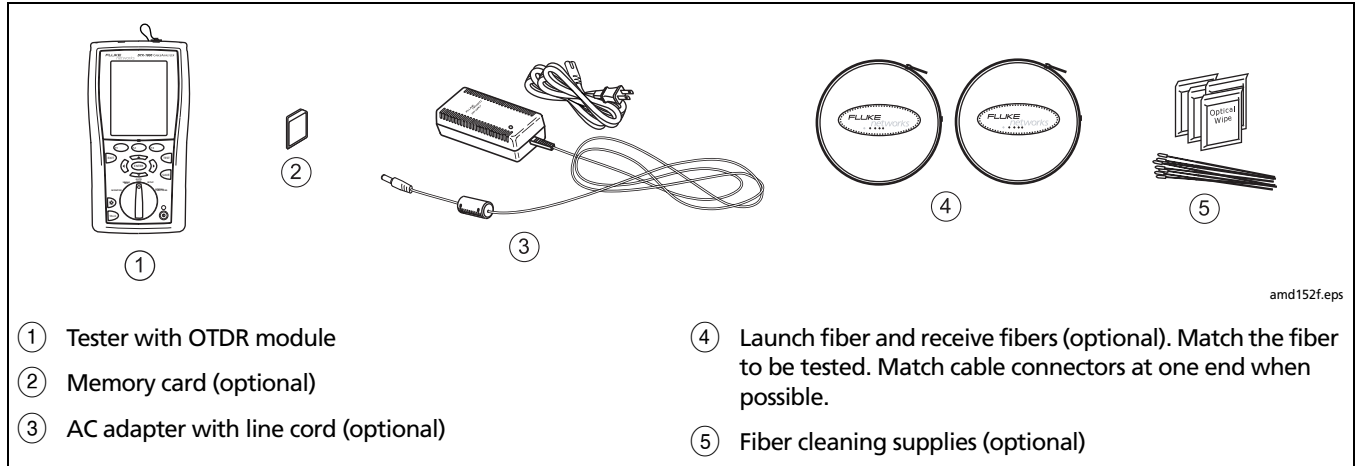

Figure 4. Equipment for the OTDR Test

## About Launch and Receive Fibers and Launch Compensation

The optional launch and receive fibers let the tester measure the loss and reflectance of the first and last connectors in the cabling. If the first or last connection in the cabling is bad, and you do not use launch and receive fibers, the OTDR test may pass because it does include measurements from the bad connection.

**Overall Loss** and **Length** include the loss and length of the launch and receive fibers, unless launch compensation was enabled during the test.

Fluke Networks recommends that you use launch and receive fibers. You should also use launch compensation to remove the effects of these fibers from the OTDR measurements.



To use launch compensation:

- 1 Turn the rotary switch to **SETUP**, select **Fiber OTDR**; then select the **OTDR Port** to be used (multimode or singlemode).
- 2 Turn the rotary switch to **SPECIAL FUNCTIONS**; then select **Set Launch Fiber Compensation**.





- 3 On the **Set Launch Method** screen highlight the type of compensation you want to do.
- 4 Connect the fibers to the tester's OTDR port as shown on the screen; then press .

### Note

*If the **OTDR Port Connection Quality** gauge is in the **Poor** range, you should clean the OTDR port and the fiber connector and run the compensation function again.*

- 5 The tester shows the end of the launch fiber and the beginning of the receive fiber (if you selected receive fiber compensation) on the **Event Table**. You can manually select the launch and receive events if necessary by highlighting events and using the softkeys.
- 6 Press ; then press  **OK**.
- 7 If you need to disable launch compensation, turn the rotary switch to **SETUP**, select **Fiber OTDR**; then set **Launch Compensation** on tab 2 to **Disable**.

## Running the OTDR Test

- 1 Select Auto OTDR mode: Turn the rotary switch to **AUTOTEST**, press  **Change Test**; then select **Auto**.
- 2 Choose settings for the test. Turn the rotary switch to **SETUP**; then select **Fiber OTDR**. See Table 2 on page 9.
- 3 Clean all connectors that will be used.
- 4 Connect the tester's OTDR port to the cabling, as shown in Figure 5, 6, or 7.
- 5 Press . Figures 8 and 9 describe the OTDR results and trace screens.
- 6 To save the results, press ; then do one of the following:
  - To save the results in a new record, create an ID or select an unused ID from the **Auto Sequence** ID list or the **List** of downloaded IDs; then press . IDs that already contain OTDR results from the same end are preceded with a "\$".
  - To save the results with existing OTDR results from the other end of the link, or with fiber loss or network connectivity results from the same link, enter the ID of the existing results or select the ID from the **Auto Sequence** ID list or the **List** of downloaded IDs; then press .

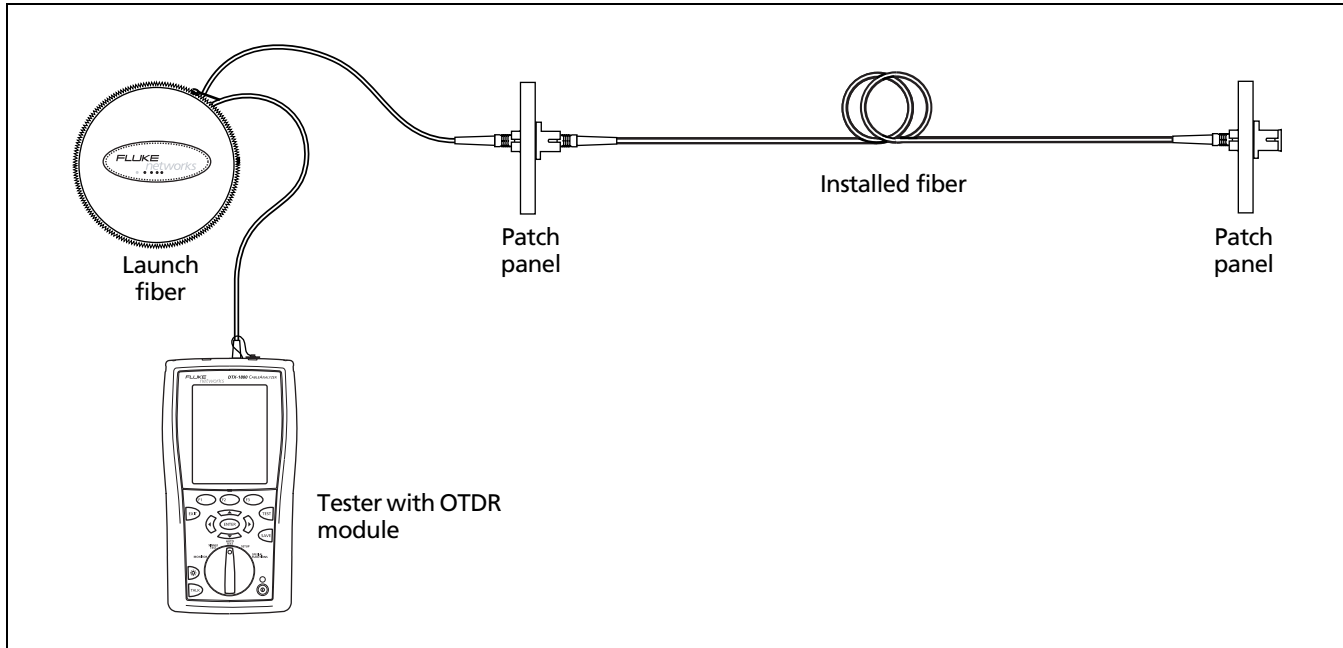

**Figure 5. Connecting the OTDR to Installed Fiber (no receive fiber)**

amd101f.eps



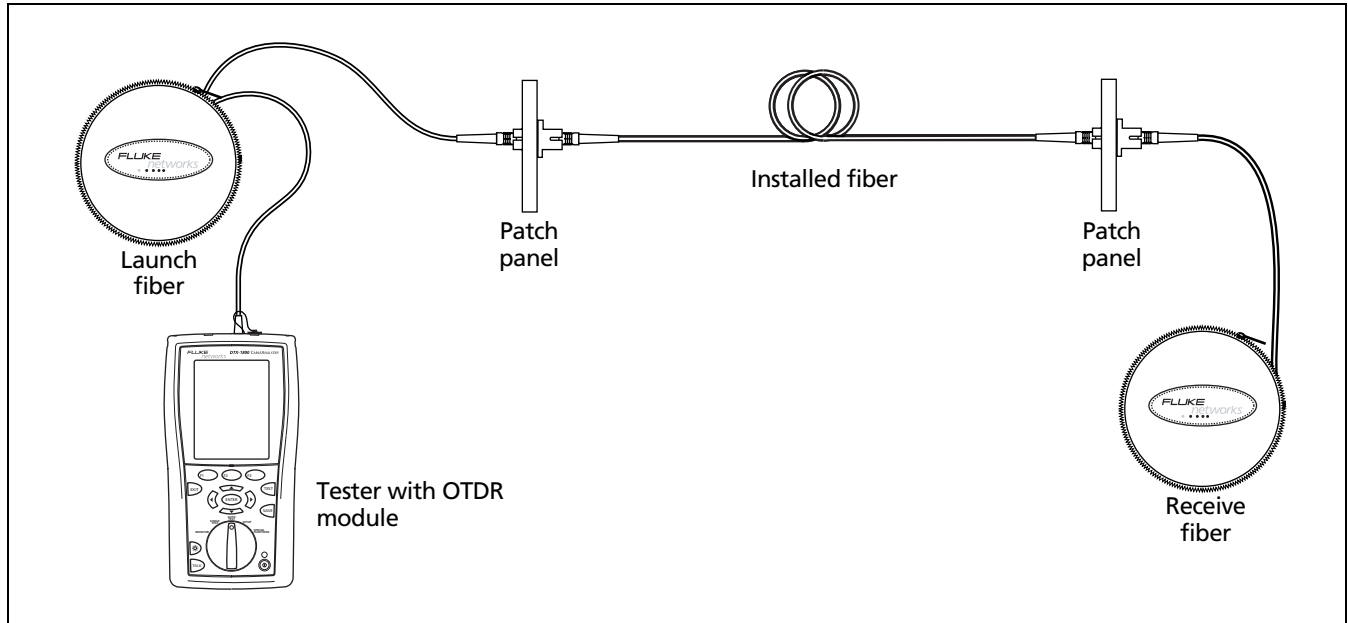

amd116f.eps

Figure 6. Connecting the OTDR to Installed Fiber (with receive fiber)

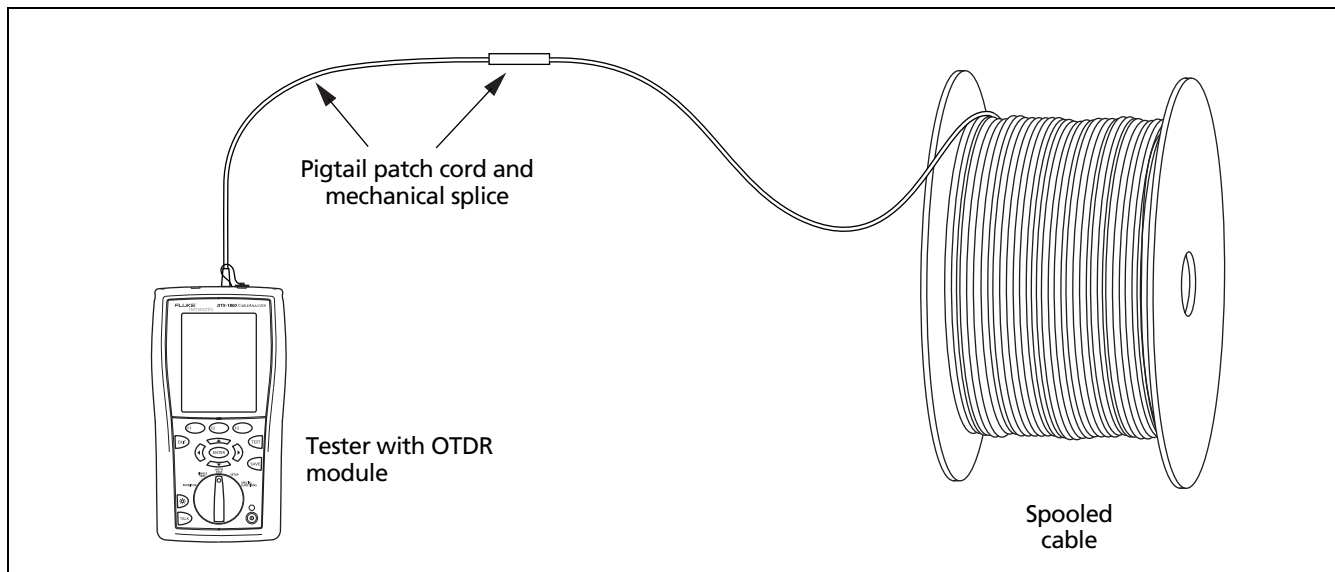

amd122f.eps

**Figure 7. Connecting the OTDR to Spooled Cable**

OTDR Results		FAIL
General Fiber		
Multimode 50		
Dual 850/1300 nm		
End 2: CLOSET		
✓ Length		1054.3 m
✓ Overall Loss		3.63 dB
✗ Largest Event		1.21 dB
View Trace		
View Events		
View Limits		

amd153f.eps

① Overall result for the test:  
**PASS:** All measurements are within limits.  
**FAIL:** One or more measurements exceed the limit.

② The limit, fiber type, wavelengths, and fiber end number (1 or 2) used for the test. See Table 2 on page 9.

③ Measurements taken and each measurement's status:  
**✓:** The measured value is within the limit.  
**i:** The measurement has no PASS/FAIL limit in the selected test limit and is provided for informational purposes.  
**✗:** The measurement exceeds the limit.

④ Shows the OTDR trace.

⑤ Shows the **Event Table**.

⑥ Shows the limits used for the test.

Figure 8. OTDR Results Screen

## Viewing the OTDR Trace

To see the OTDR trace, press (F1) **View Trace** from the OTDR Results or Event Table screen.

Figure 9 describes the readouts and navigational features on the OTDR screen. Figure 10 describes the features of a typical OTDR trace.

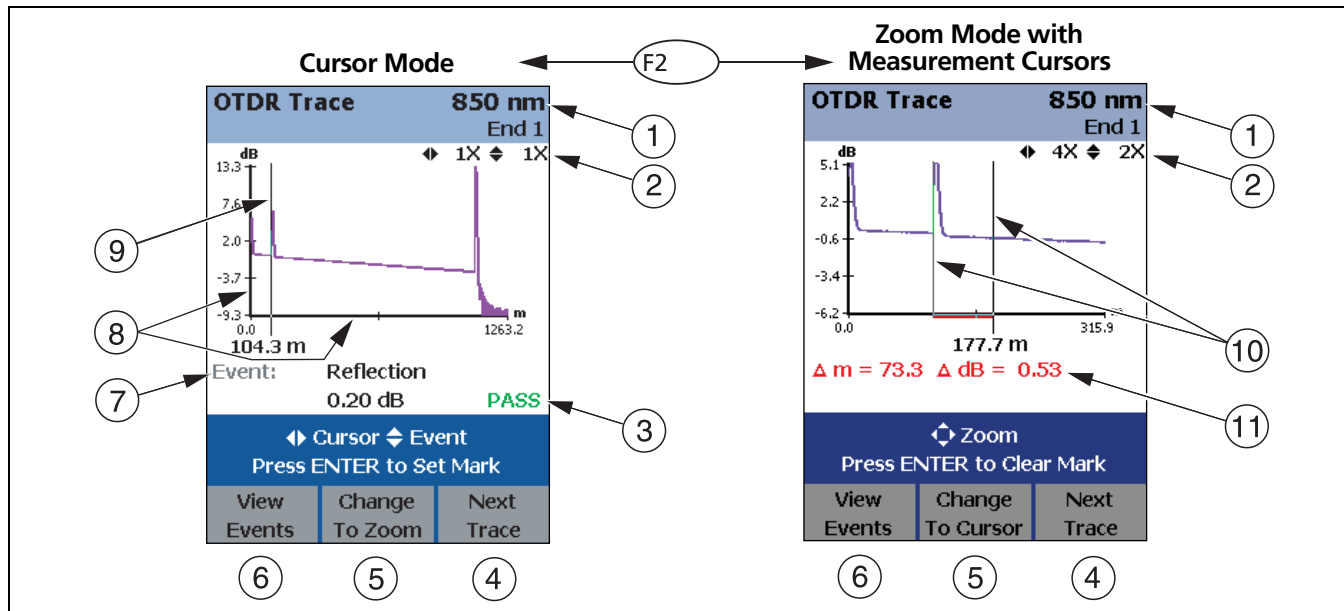

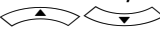

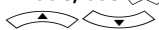
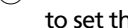

Figure 9. OTDR Trace Screens (launch compensation disabled)

amd123f.eps

- ① Wavelength for the trace and the **End** setting selected in Setup. If the test ran at two wavelengths, press **F3** **Next Trace** to switch wavelengths. You can set the wavelengths in Setup.
- ② Horizontal and vertical zoom factors for the trace. In zoom mode, use  to zoom horizontally and  to zoom vertically.
- ③ Event PASS/FAIL status appears if the cursor is on an event. To see details about the event, press **F1** **View Events**, then press **ENTER**.
- ④ For dual-wavelength tests, press **F3** to switch wavelengths.
- ⑤ Press **F2** to change the arrow keys functions from moving the cursor (⑨) to zooming. The navigational cue above the softkey labels describes the arrow keys' current function.
- ⑥ Press **F1** to see the **Event Table**.
- ⑦ Event information appears if the cursor is on an event. Otherwise, the distance to the cursor is shown.
- ⑧ Horizontal scale for the distance along the cabling under test. Vertical scale for the OTDR backscatter measurements in decibels.
- ⑨ Cursor. See ⑤. In cursor mode, use  to move the cursor left or right. Use  to move the cursor to next or previous event.
- ⑩ To use the measurement marker and cursor, press **ENTER** to set the marker; then use  to move the cursor.
- ⑪ The distance (**m** or **ft**) and the power loss (**dB**) between the cursor and the measurement marker.

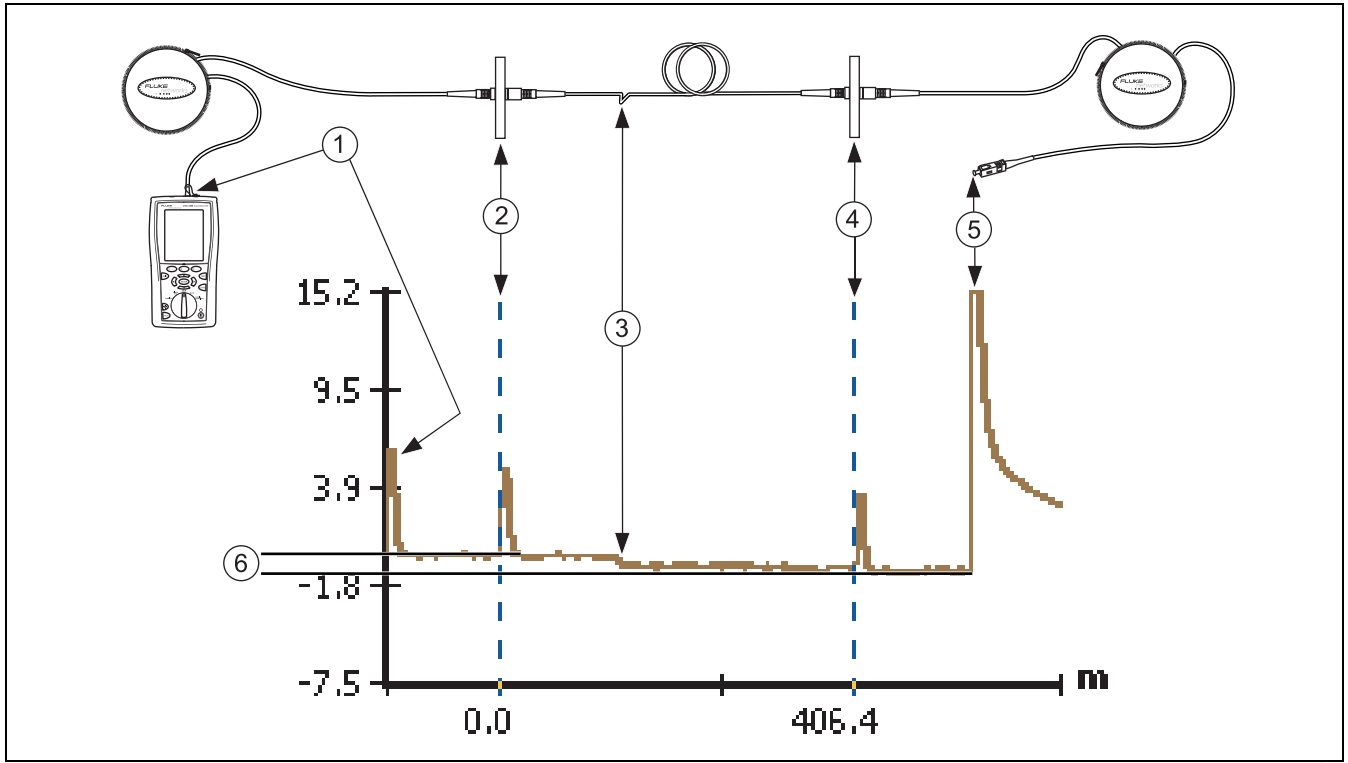

Figure 10. Typical OTDR Trace Features

amd125f.eps

- ① Reflective event caused by the OTDR port connection.
- ② Reflective event caused by the first connection in the cabling. This trace was produced using launch fiber compensation, so the end of the launch fiber is marked with a dotted line and is the 0 m point for length measurements.
- ③ Small event caused by a sharp bend in the fiber.
- ④ Reflective event caused by the last connection in the cabling. The dotted line marks the end of the fiber under test and the beginning of the receive fiber.
- ⑤ Reflective event caused by the end of the receive fiber.
- ⑥ Overall loss of the cabling. Since launch and receive fiber compensation was used, the overall loss excludes the loss of the launch and receive fibers.

## Using the Visual Fault Locator

The DTX Compact OTDR module includes a visual fault locator that helps you do the following:

- Quickly check fiber continuity. Trace fibers to determine the polarity of duplex connections and identify connections between patch panels.
- Locate breaks and bad splices. These faults scatter the locator's light, causing a red glow in the affected area.
- Reveal high-loss bends. If the locator's light is visible around a bend in a fiber, the bend is too sharp.
- Reveal problems in connectors. A damaged fiber inside a connector causes a red glow in the connector.
- Optimize mechanical splices and pre-polished connectors: Before sealing the splice or connector, adjust the fiber alignment for minimal glow where the fibers meet. (Follow the manufacturer's assembly instructions for splices and connectors.)

Figure 11 shows the equipment needed for using the visual fault locator.

The visual fault locator port accepts connectors with 2.5 mm ferrules (SC, ST, or FC). To connect to other ferrule sizes, use a patch cord with the appropriate connector at one end and a SC, ST, or FC connector at the tester end.



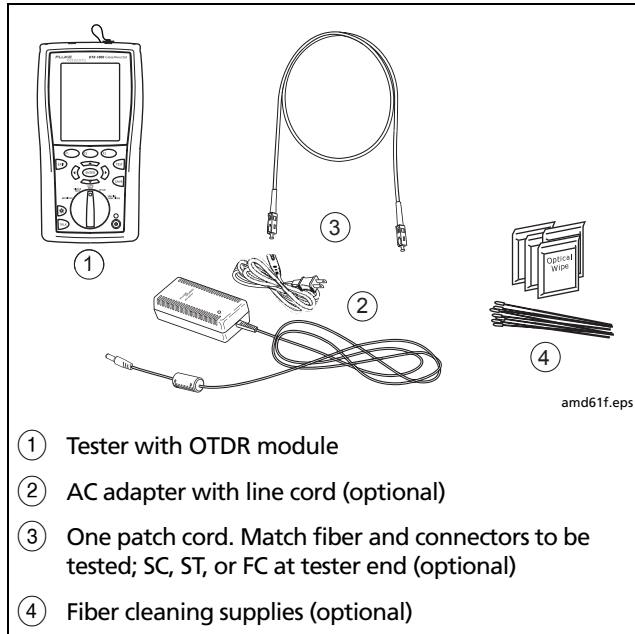

- ① Tester with OTDR module
- ② AC adapter with line cord (optional)
- ③ One patch cord. Match fiber and connectors to be tested; SC, ST, or FC at tester end (optional)
- ④ Fiber cleaning supplies (optional)

Figure 11. Equipment for Using the Visual Fault Locator

To use the visual fault locator (refer to Figure 12):

- 1 Clean the connectors on the patch cord, if used, and the fiber to be tested.
- 2 Connect the fiber directly to the tester's VFL port or connect using the patch cord.
- 3 Turn the rotary switch to **SINGLE TEST**. If necessary, press **F1** **Change Media** then set the media type to **Fiber OTDR**.
- 4 To turn on the VFL, press **F3** **Start**. To switch between pulse and continuous wave modes, press **F2**.
- 5 Look for the red light to locate fibers or faults, as shown in Figure 12.
- 6 View the VFL's light indirectly by holding a white card or paper in front of the fiber connector emitting the light.

*Note*

*The locator's light may not be visible through dark-colored fiber jackets.*

- 7 To turn off the VFL, press **F3** **Stop**.

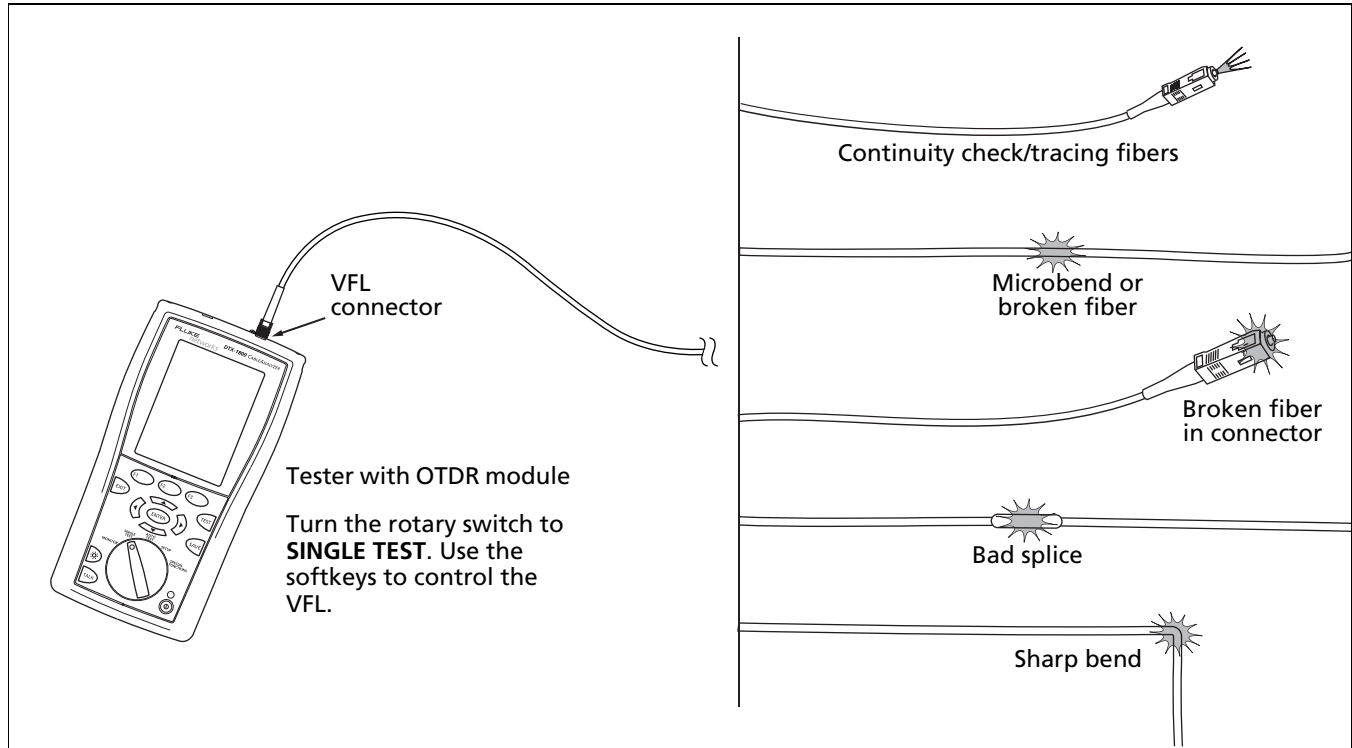

etw01.eps

Figure 12. Using the Visual Fault Locator

## Maintenance

Follow the maintenance procedures given in the *DTX Series CableAnalyzer Users Manual*.

### Inspecting the OTDR Ports

Periodically inspect the OTDR port with a fiber microscope, such as the Fluke Networks FiberInspector Video Microscope.

### Cleaning the OTDR Ports

To clean the OTDR ports, use a dry, optical-grade wipe. Figure 13 shows how to remove the OTDR adapter to access the connector ferrule.

If the port is very dirty, wipe the end of the ferrule with an optical-grade wipe lightly moistened with fiber optic solvent. Dry with a dry wipe.

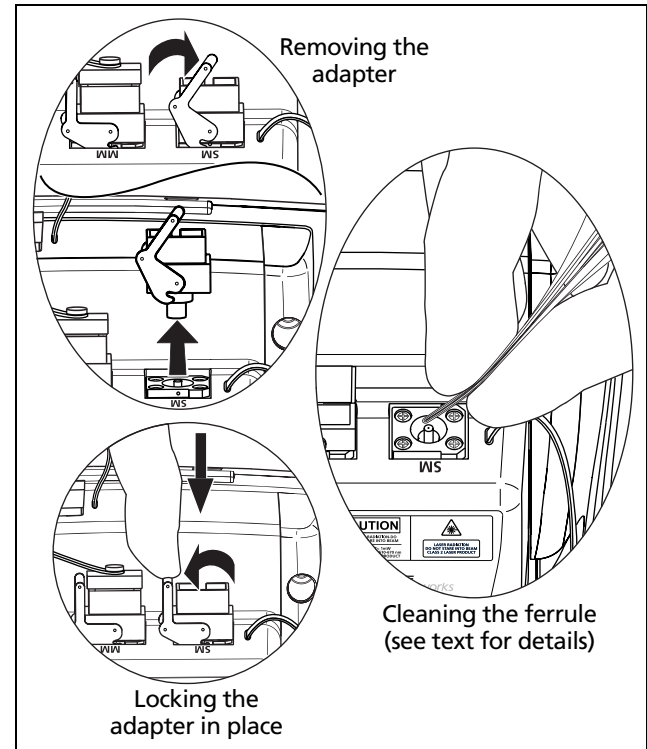

Figure 13. Cleaning the OTDR Ports

amd59f.eps

## **Certifications, Compliance, and Regulatory Information**



Conforms to relevant Australian standards

N10140



Conforms to relevant European Union directives.



Listed by the Canadian Standards Association.

**Laser  
safety**

Class 1 CDRH  
Complies to EN 60825-2

# Index

## –A–

Auto mode, 9  
Averaging Time, 12

## –B–

Backscatter, 11

## –C–

cautions, 3  
certifications and compliance, 30  
cleaning

- connectors and adapters, 8
- OTDR connector, 29

connections

- launch + receive fiber test connections, 19
- launch fiber test connections, 18
- spool, 20

cradle, 6  
customer support, 2

## –E–

End 1, End 2, 10

## –F–

features, 7  
Fiber Characteristics, 10  
Fiber Type, 9  
Fluke Networks, 2

## –H–

help (contacting Fluke Networks), 2

## –I–

index of refraction, 11  
installation, 4

**-L-**

Launch Compensation, 10, 16  
launch/receive fibers  
    connections, 19  
    purpose, 16  
Loss Threshold, 14

**-M-**

maintenance, 29  
Manual mode, 9  
manual OTDR settings, 11, 12, 13, 14

**-N-**

n, 11

**-O-**

OTDR  
    results screen, 21  
    running the test, 17  
    saving results, 17  
    settings, 9  
    test connections, 18  
    trace, 22  
    trace features, 25  
OTDR Port, 9

**-P-**

Pulse Width, 13

**-R-**

Range, 11  
receive fiber  
    purpose, 16  
    test connections, 19  
registration, 1

**-S-**

safety information, 2, 3, 30  
saving results, 17  
settings, 9  
software requirements, 6

**-T-**

Test Limit, 9  
Testing From, 10  
trace  
    features, 25  
    screen, 22

**-V-**

visual fault locator (VFL), 26

**-W-**

warnings, 3

Wavelength, 10

