

# Data center solution guide

Transforming data center networks for AI,  
IoT and 400G/800G+

**EXFO**

# Introduction

## About EXFO

EXFO develops smarter test, monitoring and analytics solutions for the global communications industry. We are trusted advisers to fixed and mobile network operators, hyperscalers and leaders in the manufacturing, development and research sector. They count on us to deliver superior visibility and insights into network performance, service reliability and user experience. Building on 35+ years of innovation, EXFO's unique blend of equipment, software and services enable faster, more confident transformations related to 5G, cloud-native and fiber-optic networks.

## About this guide

This document provides technicians, managers and industry professionals with a comprehensive guide to testing optical networks across the data center environment. It contains solutions for ultra longhaul and subsea DCI, right down to short range optical links connecting server racks within data halls. For ease of navigation, interactive features will help you move through chapters and explore supporting material for items under the spotlight.

We hope you enjoy this guide as another exciting year rolls out for data centers!

---

## No. 1 worldwide in fiber optic test solutions

+95% of top CSPs worldwide use EXFO solutions  
5000+ audits of quality of service and performance

## Market outlook 2025

The data center market in 2025 is poised for continued strong growth, driven by ongoing digital transformation across industries. Increasing demand for AI, machine learning, and IoT is fueling the need for scalable, secure, and high-performance data centers.

Emerging technologies and mission-critical applications like remote surgery and real-time analytics are also shaping the market, with a growing emphasis on reliable connections and low-latency data processing. Sustainability remains a key focus, as data centers face pressure to minimize their environmental footprint.

Overall, the data center market in 2025 is poised for sustained expansion, driven by technological advancements and increasing digitalization. However, competition is intensifying, and success in this space will depend on delivering high-quality services, improving efficiency, and reducing costs to remain competitive in the market.

# Contents

## Types and sizes

Types and sizes

## Network architecture

Spine and leaf

Multilayer spine and leaf with planes and pods

Component testing - Active and passive

Link testing - Active and passive

## Infrastructure

Fiber forms, sizes and cable grades

Fiber cable construction

Fiber connectors

Racks and fiber management

Switches and transceivers

## Standards

Standards

## Testing

Testing

Longhaul and subsea data center interconnect (DCI)

Metro and edge DCI

Campus DCI

Meet-me-room (MMR) to colocation space

Main distribution area (MDA) to equipment distribution area (EDA)

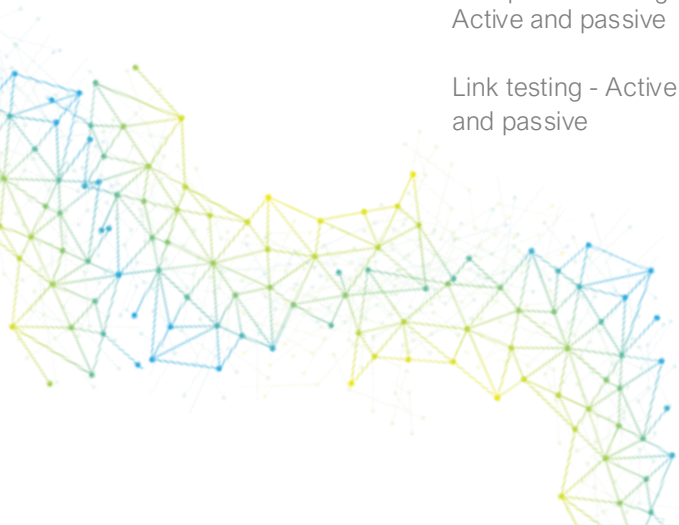

## Types and sizes



### Private hyperscale

Hyperscale data centers are usually purpose-built facilities owned by large public cloud, social media and gaming companies. They are often located outside of major metropolitan areas and would typically house more than 5,000 servers covering at least 10,000 square feet of land. The network architecture is designed to easily scale whilst maintaining high-speed switching between servers and storage units. These massive data centers are expected to increase in size and number as we welcome new technologies such as blockchain, AI and ML.



### Colocation wholesale and retail

Colocation data centers rent space and power for tenants to host IT infrastructure in a certified and highly secure environment. They are typically located inside major metropolitan areas and are often classified as being for wholesale purposes meaning they host few clients or retail which targets many smaller hosts. Colocation is an attractive option both from a cost and an ecosystem perspective as hosts can connect to other tenants, cloud and service providers present at the site.



## Types and sizes



### Enterprise off-premise

Larger enterprises may own private data centers to support their business operations and maintain certain workloads in-house. This is more common for organizations that store sensitive data requiring higher levels of security and compliance. These facilities can range in size but are usually sufficiently large that they require dedicated sites and staff to manage them.



### Enterprise on-premise

Most organizations will house some server and storage devices on-premise to support localized applications and data sets. These rooms or areas within a building will vary in size depending on individual needs and infrastructure decisions. An emerging trend is for organizations to create hybrid public and private networks with application specific workloads hosted where it makes most sense.



### Edge

Edge data centers are smaller, decentralized facilities providing compute and storage closer to where data is generated. They often house equipment owned by larger organizations to cache content to address latency issues and improve user experience. Edge data centers can take many forms of ownership from tower companies to communication service providers re-purposing central offices and headends (CORD and HERD).

# Spine and leaf

Spine and leaf architecture consists of two switching layers designed to optimize server-to-server communication within a data center. The leaf layer aggregates traffic from servers that connect to the spine layer in a full mesh topology. This provides redundancy, load balancing, predictable latency, and excellent scalability as both leaf and spine switches can be added to support network growth.

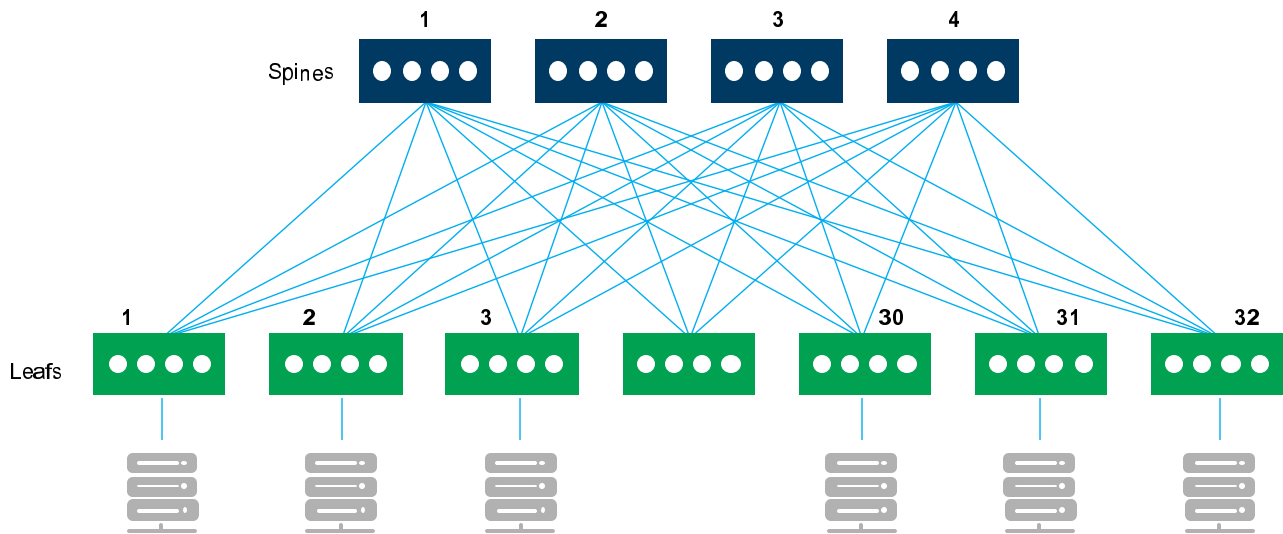

# Multilayer spine and leaf with planes and pods

Larger networks may require additional layers of switches to allow for sufficient ports to connect servers and storage units. These are often organized into server pods and spine planes to optimize traffic paths across the switching fabric. Large public cloud providers have pioneered different designs to accommodate network expansion and management.

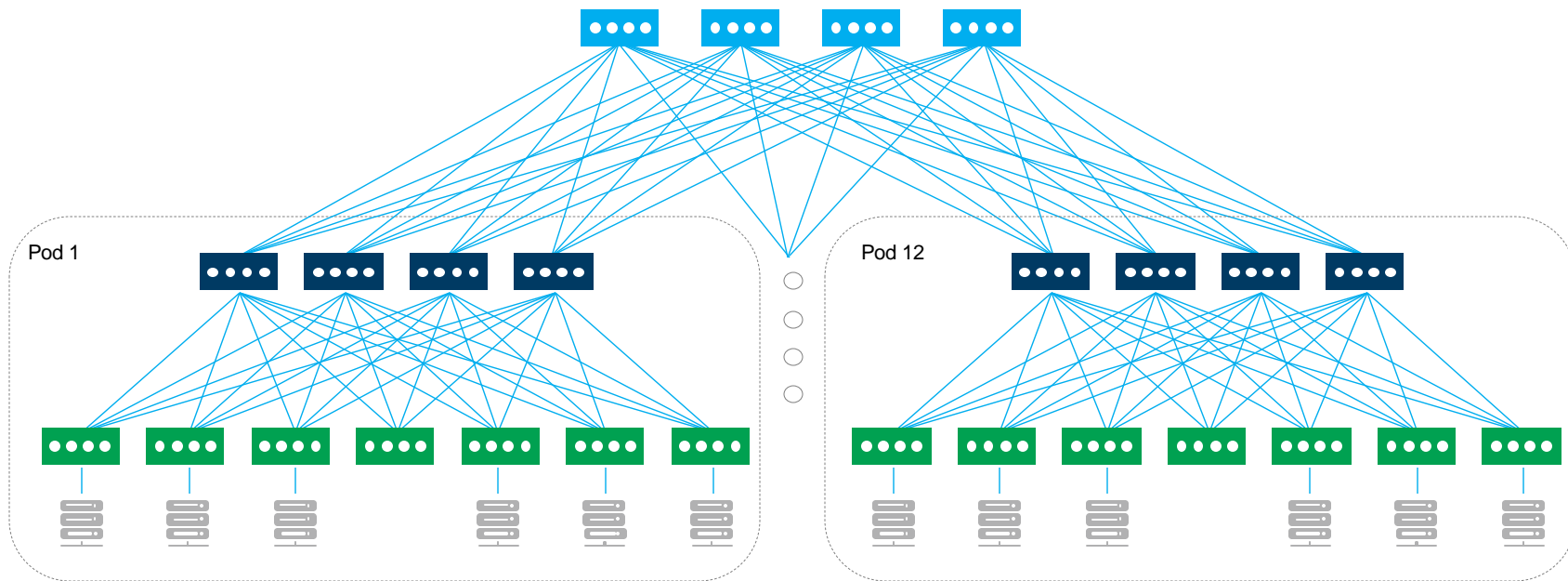



# Component testing - Active and passive

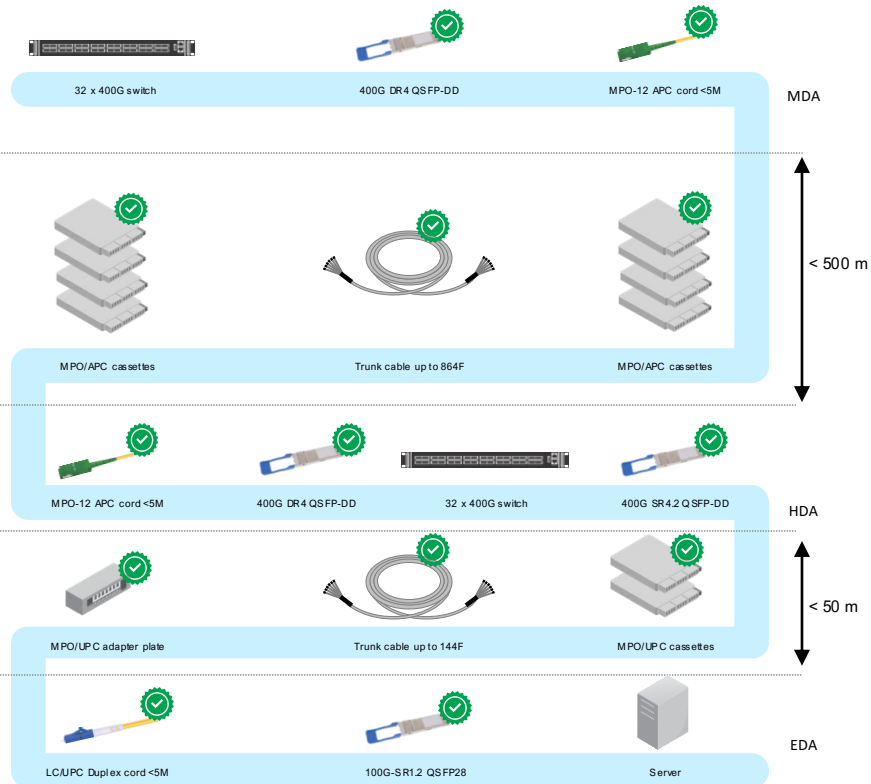
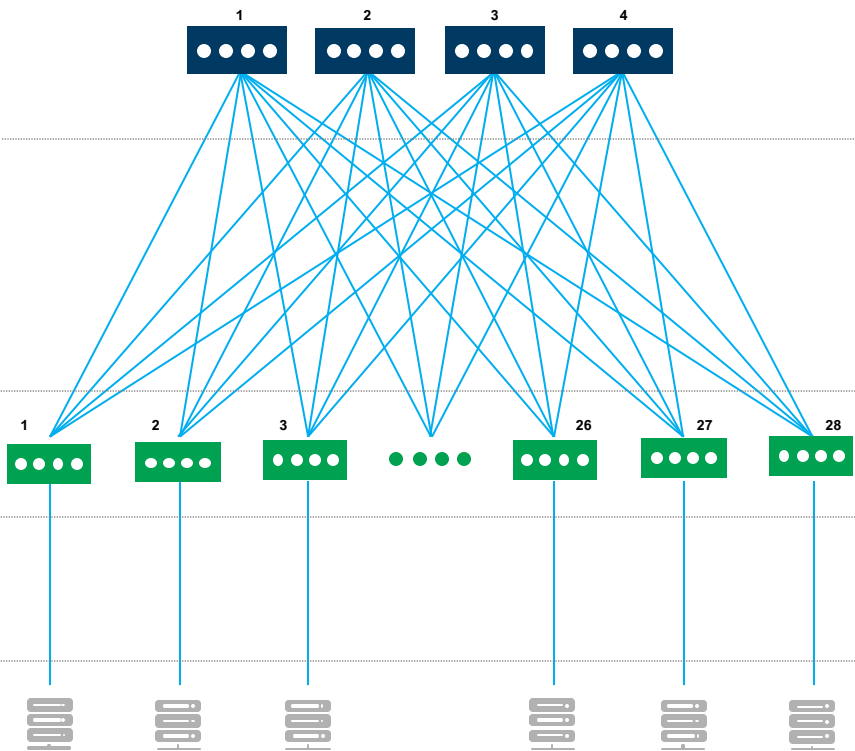

# Link testing - Active and passive

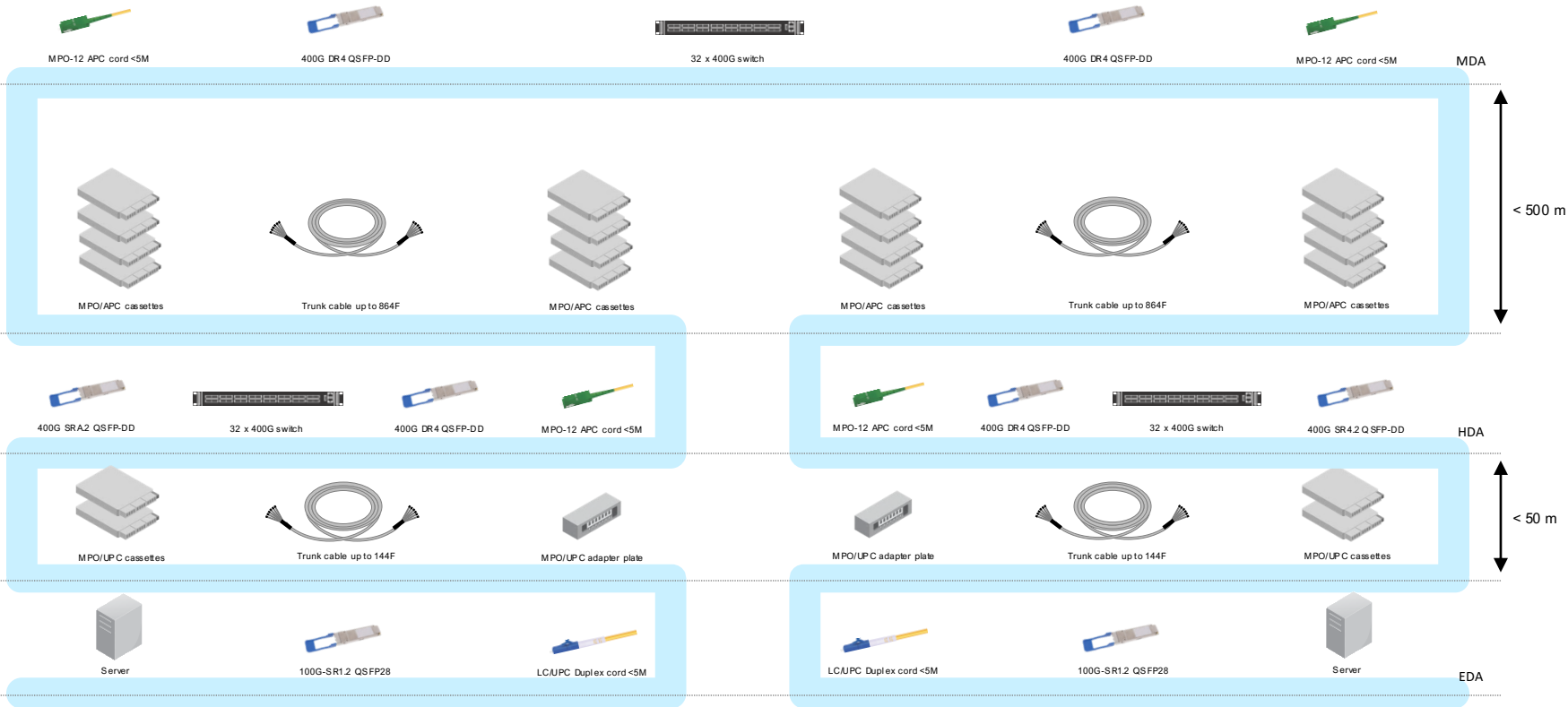

# Fiber forms, sizes and cable grades

## Forms



### Single

Optical fiber has a core and cladding layer made from silica glass. This is coated in plastic buffer layers for protection and color coding.



### Ribbon

Optical fibers can be bonded together in ribbons for ease of handling and installation. Modern techniques allow for individual fibers usually in groups of 12 to be bonded in a web to increase cable density.

## Sizes and cable grades

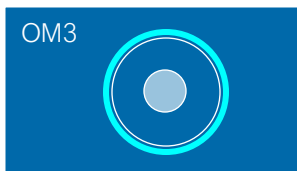

- 50-µm core size
- Aqua cable jacket
- Model bandwidth 2,000 MHz·km at 850 nm

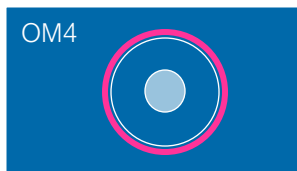

- 50-µm core size
- Violet cable jacket
- Model bandwidth 4,700 MHz·km at 850 nm

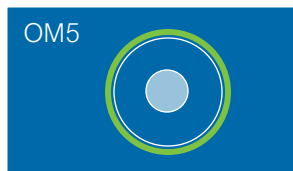

- 50-µm core size
- Lime cable jacket
- Optimized for SWDM between 850 and 953 nm

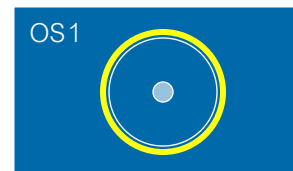

- 9-µm core size
- Yellow cable jacket
- Indoor use with tight buffered construction

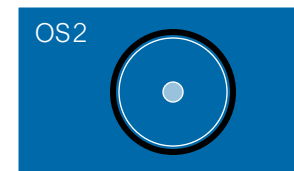

- 9-µm core size
- Black cable jacket
- Outdoor use for low-water-peak applications

# Fiber cable construction

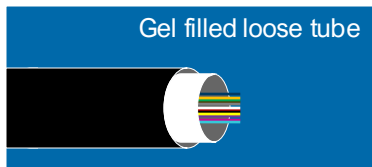

- Outdoor use
- Water-resistant gel
- Single or multi tube
- < 250 μm fiber buffer

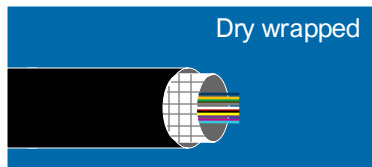

- Outdoor use
- Water blocking tape
- High density fiber
- < 250 μm fiber buffer

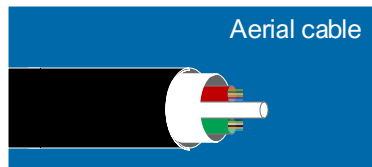

- Outdoor use
- Gel filled or dry
- Strength member
- < 250 μm fiber buffer

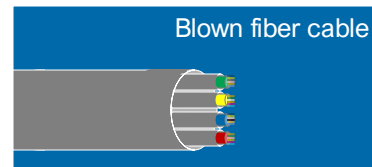

- Outdoor use
- HDPE tubes
- Compressed air installation
- < 250 μm fiber buffer

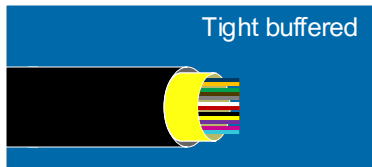

- Indoor use
- Tight buffered
- Aramid protective yarn
- 900 μm fiber buffer

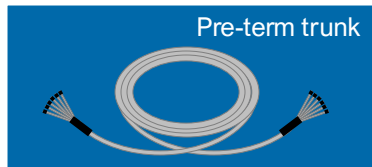

- Indoor use
- Hydra design
- Pre-connectorized
- < 3 mm cable jacket

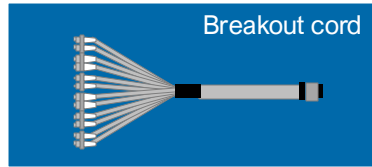

- Indoor use
- Breakout design
- Pre-connectorized
- < 3 mm cable jacket

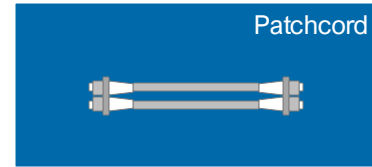

- Indoor use
- Pre-connectorized
- < 3 mm cable jacket

# Optical fiber connectivity

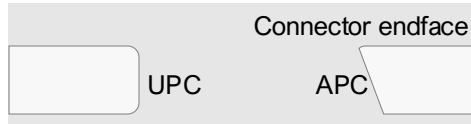

Connector endfaces are polished to provide ultra physical contact (UPC) or angled physical contact (APC). APC has historically been reserved for singlemode fiber to reduce back reflection and return loss but multimode is now possible.

Duplex		Base-8/12		Base-16		Base-24	
<p><b>LC</b></p> <ul style="list-style-type: none"> <li>• Lucent connector</li> <li>• 1.25 mm ferrule</li> <li>• Also available in simplex</li> </ul>		<p><b>MPO-8</b></p> <ul style="list-style-type: none"> <li>• Multi-fiber push on</li> <li>• Single row 8 fibers</li> <li>• Alignment pins</li> </ul>		<p><b>MPO-16</b></p> <ul style="list-style-type: none"> <li>• Multi-fiber push on</li> <li>• Single row 16 fibers</li> <li>• Alignment pins</li> </ul>		<p><b>MPO-24</b></p> <ul style="list-style-type: none"> <li>• Multi-fiber push on</li> <li>• Double row 12 fibers</li> <li>• Alignment pins</li> </ul>	
<p><b>MDC</b></p> <ul style="list-style-type: none"> <li>• VSFF</li> <li>• 1.25 mm ferrule</li> <li>• Native duplex</li> </ul>		<p><b>MPO-12</b></p> <ul style="list-style-type: none"> <li>• Multi-fiber push on</li> <li>• Single row 12 fibers</li> <li>• Alignment pins</li> </ul>		<p><b>SN-MT-16</b></p> <ul style="list-style-type: none"> <li>• VSFF</li> <li>• Single row 16 fibers</li> <li>• Alignment pins</li> </ul>		<p><b>SN-MT-24</b></p> <ul style="list-style-type: none"> <li>• VSFF</li> <li>• Double row 12 fibers</li> <li>• Alignment pins</li> </ul>	
<p><b>SN</b></p> <ul style="list-style-type: none"> <li>• VSFF</li> <li>• 1.25 mm ferrule</li> <li>• Native duplex</li> </ul>		<p><b>MMC-12</b></p> <ul style="list-style-type: none"> <li>• VSFF</li> <li>• Single row 12 fibers</li> <li>• Alignment pins</li> </ul>		<p><b>MMC-16</b></p> <ul style="list-style-type: none"> <li>• VSFF</li> <li>• Single row 16 fibers</li> <li>• Alignment pins</li> </ul>		<p><b>MMC-24</b></p> <ul style="list-style-type: none"> <li>• VSFF</li> <li>• Double row 12 fibers</li> <li>• Alignment pins</li> </ul>	
<p><b>CS</b></p> <ul style="list-style-type: none"> <li>• VSFF</li> <li>• 1.25 mm ferrule</li> <li>• Native duplex</li> </ul>							

# Racks and fiber management

## Panels and enclosures

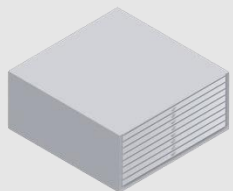

- Rack mountable
- Fixed or cassette ready
- Density dependent on fiber connector style

## Cassette

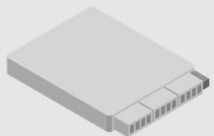

- Pre-connectorized
- MPO-12/24/36/48 connector on rear
- Duplex or MPO-8/12/16 connector on front

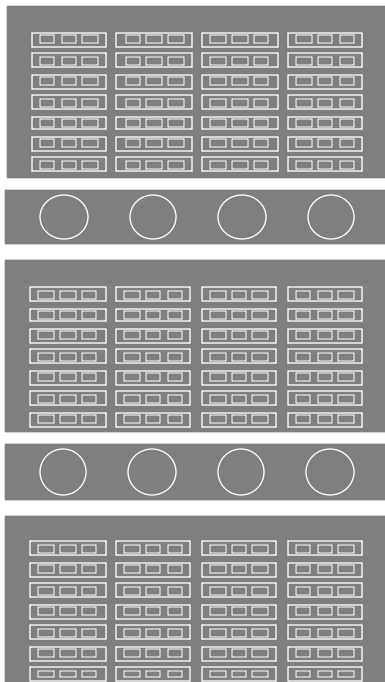

## Splice tray

- Pre-connectorized
- Splice ready
- Duplex or MPO-8/12/16 connector on front



## Adapter plate

- Pass through
- Cross connects
- Duplex or MPO

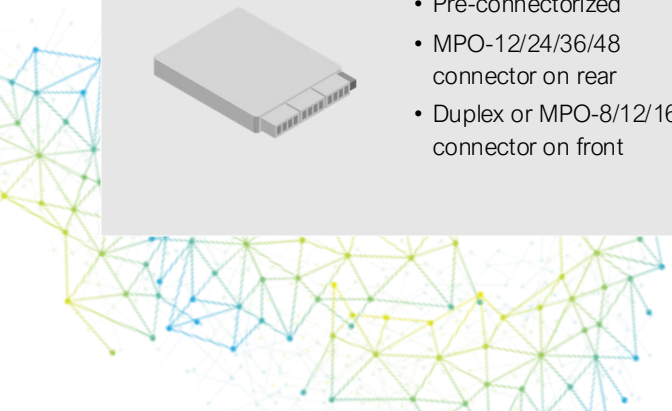
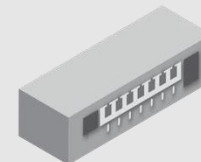

# Switches and transceivers

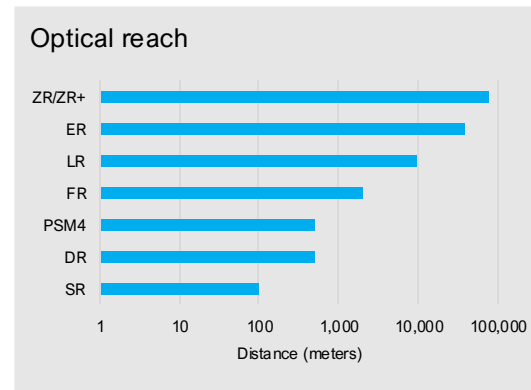
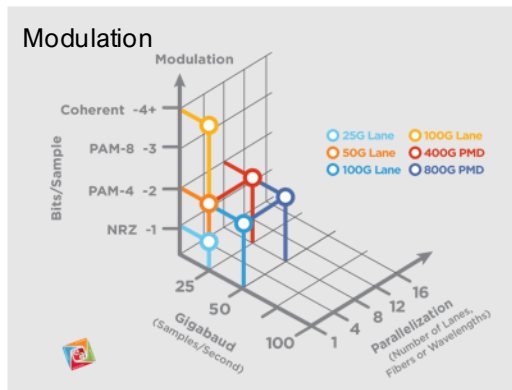
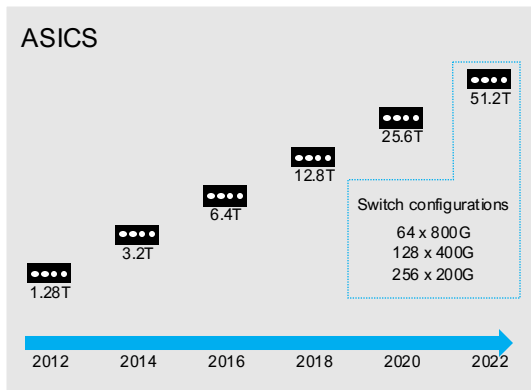

- 100M to 100G
- NRZ to PAM4
- MSA
- 50 m to 10 km reach



- 40G to 400G
- NRZ to coherent
- MSA
- 100 m to 80 km reach



- 200G, 400G
- NRZ to coherent
- OSFP MSA
- 100 m to 10 km reach



- 100G, 200G, 400G
- Coherent
- OpenROADM MSA, OpenZR+
- 80 km to 1000 km reach

## Standards



### ANSI/TIA 568.3: Optical Fiber Cabling and Components Standard

This American standard covers premise optical fiber cabling, components and test procedures. It specifies cable, connectors, connecting hardware, patch cords and test and measurement. Tier-1 and Tier-2 fiber cabling certification and inspection is described alongside recommended test equipment.

### ANSI/TIA 942: Telecommunications Infrastructure Standard for Data Centers

The American standard specifies minimum requirements and guidelines for the design and installation of a data center or computer room. It provides a comprehensive understanding of power systems, mechanical systems, architecture, security, cabling systems and network design.



### ANSI/BISCI 002: Data Center Design and Implementation Best Practices

This American standard features 17 chapters and 9 appendices spread over 550 pages. It covers design methodology and site selection right the way through to network maintenance. The content can be applied to modular, containerized, edge and hyperscale data centers.

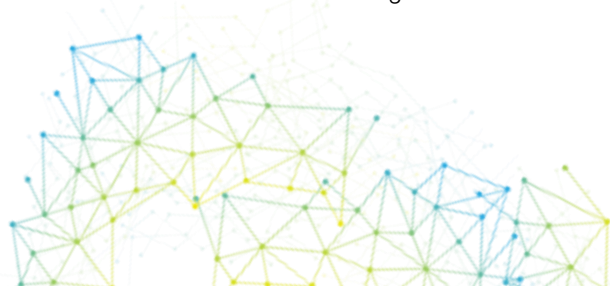



## Standards



### **ISO/IEC 11801-5: Generic cabling for customer premises Part 5: Data centres**

This international standard specifies generic cabling within and to the computer room spaces of data center premises, or computer room spaces within other types of building. Additionally, those premises can include office spaces (for which generic cabling is specified in ISO/IEC 11801-2) or industrial spaces (for which generic cabling is specified in ISO/IEC 11801-3).

### **ISO/IEC 14763-2: Implementation and operation of customer premises cabling Part 2: Planning and installation**

This international standard specifies requirements for the planning, installation and operation of telecommunications cabling and cabling infrastructures including cabling, pathways, spaces and telecommunications bonds in support of generic cabling standards and associated documents.

### **ISO/IEC 14763-3: Implementation and operation of customer premises cabling Part 3: Testing of optical fibre cabling**

This international standard specifies systems and methods for the inspection and testing of installed optical fiber cabling designed in accordance with premises cabling standards including ISO/IEC 11801, ISO/IEC 24764, ISO/IEC 24702 and ISO/IEC 15018. It covers basic and extended test requirements.

# Standards



## EN 50173-5: Generic cabling systems – Part 5: Data centre spaces

This European standard specifies generic cabling within computer room spaces in data center premises, or data center spaces within other types of buildings. It covers balanced cabling and optical fiber cabling addressing network structure, performance requirements and verification procedures.

## EN 50600: Data centre facilities and infrastructures

This is a European standard for data center infrastructure, covering aspects of design, power, cooling systems, security, and sustainability. It is a multipart document and is considered one of the most comprehensive sets of standards available.



# Standards



## IEEE 802.3: Ethernet Standards for Physical and Data Link Media Access Control

This is a set of standard specifications for ethernet transmission which defines the physical layer and the media access control (MAC) of the data link layer for wired ethernet networks. Publications cover data rates ranging from 10 Mbit/s to 400 Gbit/s with specifications for distances, loss and reflectance.

## INCITS/T11: Fibre Channel standards for Physical Variants

This is a set of standards for specifying physical variants and interfaces; framing, signaling, and link services; upper-level protocol mappings; switch models and protocols; management functions and protocols. Publications cover data rates ranging from 133 Mbit/s to 256 Gbit/s with specifications for distances, loss and reflectance.

## Multi-Source Agreement (MSA)

MSA is an agreement among multiple manufacturers to make products that are compatible across vendors to establish a competitive market for interoperable products. This has been a vehicle used by industry to develop optical components for new technologies such as pluggable transceivers. Innovation within high-speed short range and coherent optics have benefited from this in recent years.

# Standards



## ITU-T Y.1564: Ethernet Service Activation Test Methodology

This standard defines a test methodology that may be used in assessing the proper configuration and performance of an Ethernet network to deliver Ethernet-based services. This out-of-service test targeted at service providers specifies Ethernet-based services measuring bandwidth, latency, frame delay variation (packet jitter) and loss.



## IETF RFC 2544: Benchmarking Methodology for Network Interconnect Devices

This specification defines a specific set of tests that vendors can use to measure and report the performance characteristics of network devices. It specifies procedures for measuring throughput, round-trip latency, burst and frame loss.

## IETF RFC 6349: Framework for TCP Throughput Testing

This specification describes a practical methodology for measuring end-to-end TCP throughput in a managed IP network. It offers extended layer 4 testing using path MTU detection, round-trip latency and TCP throughput to determine user experience.

# Testing



Longhaul and subsea DCI >

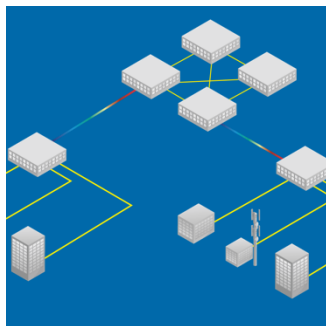

Metro and edge DCI >

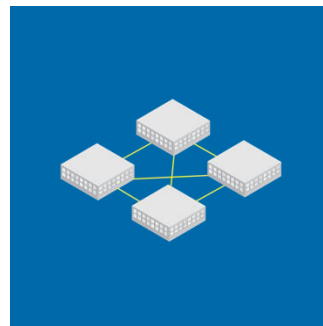

Campus DCI >



## OUTSIDE PLANT

## INSIDE PLANT

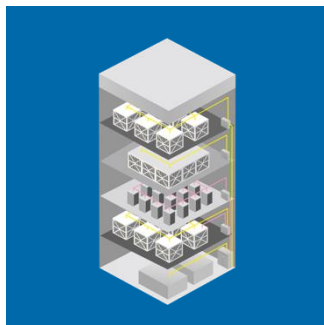

MMR to colocation space >

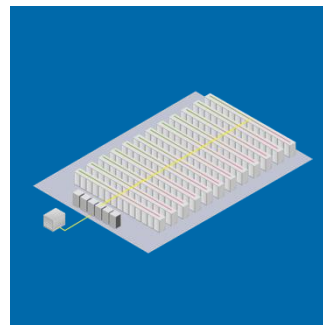

MDA to EDA >

# Longhaul and subsea data center interconnect (DCI)

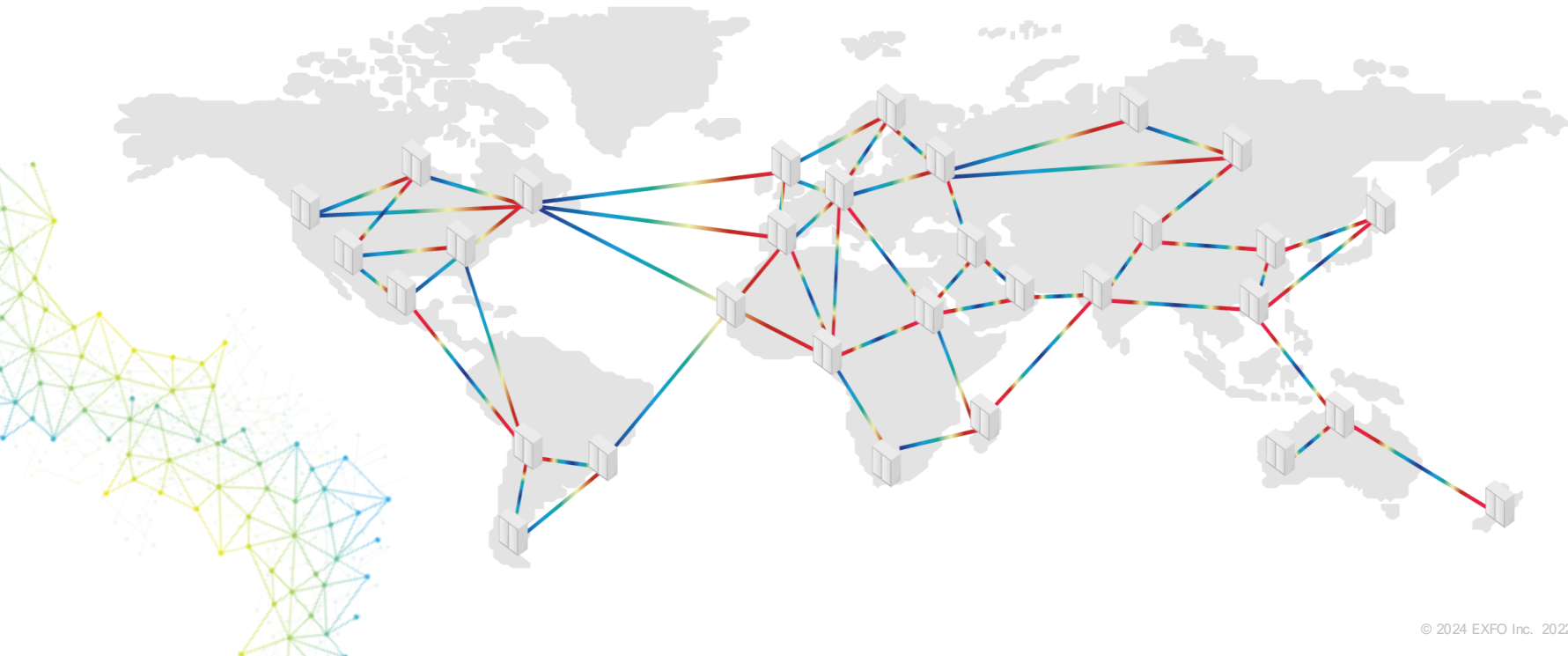

- > 1. Link loss
- 2. Event mapping
- 3. Dispersion
- 4. Inspection
- 5. DWDM
- 6. BERT
- 7. Protocol
- 8. Monitoring
- 9. Test management



# Longhaul and subsea DCI

- [1. Link loss](#)
- [2. Event mapping](#)
- [3. Dispersion](#)
- [4. Inspection](#)
- [5. DWDM](#)
- [6. BERT](#)
- [7. Protocol](#)
- [8. Monitoring](#)
- [9. Test management](#)



## Construction – Fiber characterization

Use case	Challenge	Product spotlight
<p><b>1</b> <a href="#">Link insertion loss, return loss and length</a></p>	<p>Measuring insertion and return loss on long-distance links is the first step of the fiber characterization process. Minimizing loss, especially over the first few kilometer is critical due to high-powered optics and signal amplification. EXFO's FTBx-945 offers fully automated bidirectional testing to predefined limits.</p>	<div style="text-align: center;">  <p>FTBx-945 in FTB-4 Pro (pair)</p> </div> <div style="display: flex; justify-content: center; gap: 20px; margin-top: 10px;"> <div style="background-color: #007bff; color: white; border-radius: 10px; padding: 5px 15px; text-decoration: none;">Product page</div> <div style="background-color: #007bff; color: white; border-radius: 10px; padding: 5px 15px; text-decoration: none;">Spec sheet</div> </div>
<p><b>2</b> <a href="#">Event mapping, fiber attenuation and fault detection</a></p>	<p>Due to amplification (RAMAN/EDFA) bad connections and splices have a magnifying effect on network performance. Poor quality events on the fiber will degrade optical-signal-to-noise-ratio (OSNR) resulting in bit error rates. FTB-7600E offers ultra-high dynamic range with 256,000 sampling points for accuracy.</p>	<div style="text-align: center;">  <p>FTB-7600E in FTB-4 Pro</p> </div> <div style="display: flex; justify-content: center; gap: 20px; margin-top: 10px;"> <div style="background-color: #007bff; color: white; border-radius: 10px; padding: 5px 15px; text-decoration: none;">Product page</div> <div style="background-color: #007bff; color: white; border-radius: 10px; padding: 5px 15px; text-decoration: none;">Spec sheet</div> </div>

# Longhaul and subsea DCI

- > 1. Link loss
- 2. Event mapping
- 3. Dispersion
- 4. Inspection
- 5. DWDM
- 6. BERT
- 7. Protocol
- 8. Monitoring
- 9. Test management

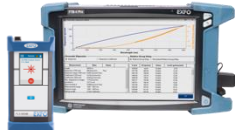
## Construction – Fiber characterization



Use case	Challenge	Product spotlight
<p><b>3</b> <b>Optical dispersion and fiber quality</b></p>	<p>The final step in fiber characterization is to measure optical chromatic dispersion (CD) and polarization mode dispersion (PMD). This will allow for accurate engineering of the system design to guarantee service delivery. EXFO's FTBx-570 is the industry's only solution for fast single-ended CD/PMD testing.</p>	<div style="text-align: center;">  <p>FTBx-570 in FTB-4 Pro with FLS-5834B</p> </div> <div style="display: flex; justify-content: center; gap: 20px; margin-top: 10px;"> <div style="background-color: #007bff; color: white; border-radius: 15px; padding: 5px 15px; text-decoration: none;"><a href="#">Product page</a></div> <div style="background-color: #007bff; color: white; border-radius: 15px; padding: 5px 15px; text-decoration: none;"><a href="#">Spec sheet</a></div> </div>
<p><b>4</b> <b>Connector endface analysis</b></p>	<p>High-powered optics are susceptible to reflections caused by damaged or dirty connectors. This will result in both insertion and return loss issues which will impact system budgets and network performance. EXFO's FIP-435 offers fully automated connector analysis to industry standards.</p>	<div style="text-align: center;">  <p>FIP-435B</p> </div> <div style="display: flex; justify-content: center; gap: 20px; margin-top: 10px;"> <div style="background-color: #007bff; color: white; border-radius: 15px; padding: 5px 15px; text-decoration: none;"><a href="#">Product page</a></div> <div style="background-color: #007bff; color: white; border-radius: 15px; padding: 5px 15px; text-decoration: none;"><a href="#">Spec sheet</a></div> </div>



# Longhaul and subsea DCI

- > 1. Link loss
- 2. Event mapping
- 3. Dispersion
- 4. Inspection
- 5. DWDM
- 6. BERT
- 7. Protocol
- 8. Monitoring
- 9. Test management



## Operation – Network performance and fault resolution

Use case	Challenge	Product spotlight
<p><b>5 DWDM spectrum and channel verification</b></p>	<p>Good OSNR is necessary for transport links supporting dense division wavelength multiplexing (DWDM). This allows for multiple data streams to be transmitted down each fiber providing a massive increase in bandwidth. EXFO's FTBx-5255 offers in-service Pol-Mux OSNR for 100/200/400G+.</p>	<div style="text-align: center;">  <p>FTBx-5255 in FTB-4 Pro</p> </div> <div style="display: flex; justify-content: center; gap: 10px; margin-top: 10px;"> <div style="background-color: #007bff; color: white; border-radius: 10px; padding: 5px 15px; text-decoration: none;">Product page</div> <div style="background-color: #007bff; color: white; border-radius: 10px; padding: 5px 15px; text-decoration: none;">Spec sheet</div> </div>
<p><b>6 Bit-error-rate test (BERT)</b></p>	<p>Long-distance links comprising multiple network elements and complex optical fiber infrastructure can cause errors in the transmission channel. EXFO's BERT test applications will verify error-free transmission from 1G to 400G for coherent and non-coherent transports links.</p>	<div style="text-align: center;">  <p>FTBx-88480 in FTB-4 Pro with BERT apps</p> </div> <div style="display: flex; justify-content: center; gap: 10px; margin-top: 10px;"> <div style="background-color: #007bff; color: white; border-radius: 10px; padding: 5px 15px; text-decoration: none;">Product page</div> <div style="background-color: #007bff; color: white; border-radius: 10px; padding: 5px 15px; text-decoration: none;">Spec sheet</div> </div>

# Longhaul and subsea DCI

>	1. Link loss	2. Event mapping	3. Dispersion	4. Inspection	5. DWDM	6. BERT	7. Protocol	8. Monitoring	9. Test management
---	--------------	------------------	---------------	---------------	---------	---------	-------------	---------------	--------------------

## Operation – Network performance and fault resolution

Use case	Challenge	Product spotlight
<p><b>7 Bandwidth (throughput), latency, frame loss and frame delay variation (jitter)</b></p>	<p>Networks support multiple applications requiring different levels of performance. ITU Y.1564 provides a standardized methodology to verify defined parameters of the service-level agreement (SLA). EXFO's EtherSAM validates network configuration and performance parameters from 1G to 400G.</p>	 <p>FTBx-88480 in FTB-4 Pro with EtherSAM</p> <p><a href="#">Product page</a></p> <p><a href="#">Spec sheet</a></p>
<p><b>8 Fiber monitoring and fault detection</b></p>	<p>Long-distance fibers carry huge amounts of traffic, so high availability is of critical importance. Without real-time analysis operators must react to problems from different sources making it difficult to assign responsibility. EXFO's RTU-2 offers secure, always-on remote monitoring and precision fault detection.</p>	 <p>RTU-2</p> <p><a href="#">Product page</a></p> <p><a href="#">Spec sheet</a></p>
<p><b>9 Workflow and test management</b></p>	<p>Data center testing requires significant coordination to ensure tests are conducted efficiently and correctly. EXFO's Exchange software platform guides technicians through the test process storing results for analytics, reporting and business intelligence.</p>	

# Metro and edge DCI

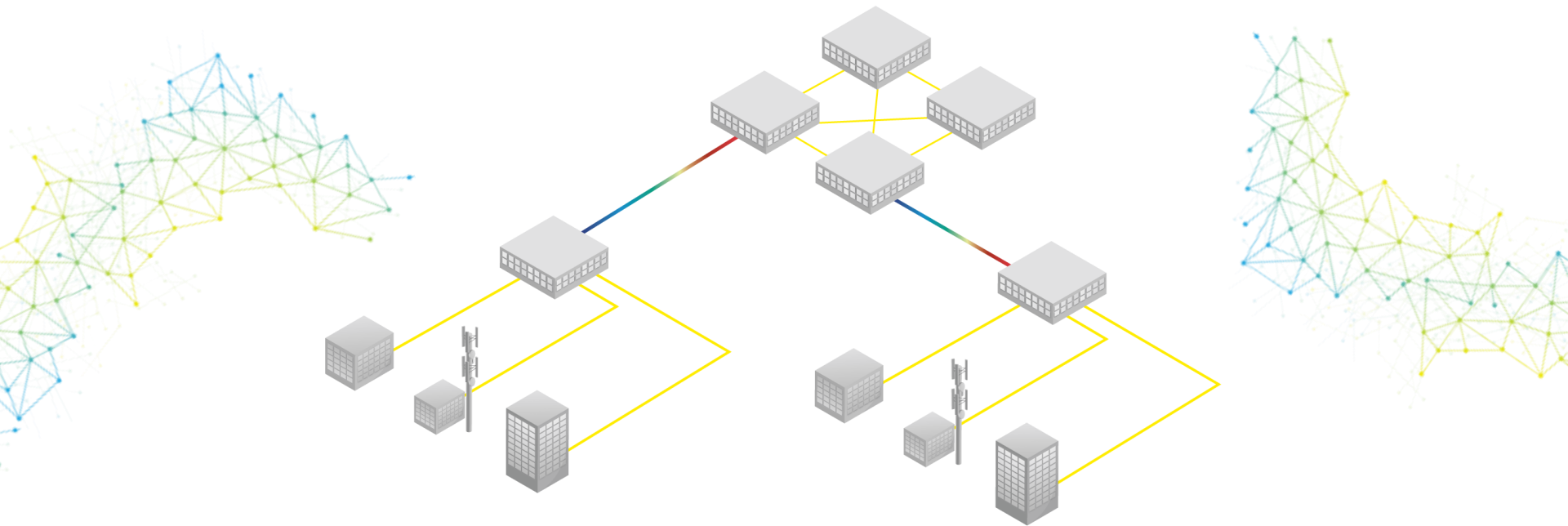

- > 1. Link loss
- 2. Event mapping
- 3. Dispersion
- 4. Inspection
- 5. DWDM
- 6. BERT
- 7. Protocol
- 8. Monitoring
- 9. Test management



# Metro and edge DCI

- >
- 1. Link loss
- 2. Event mapping
- 3. Dispersion
- 4. Inspection
- 5. DWDM
- 6. BERT
- 7. Protocol
- 8. Monitoring
- 9. Test management



## Construction – Fiber characterization

Use case	Challenge	Product spotlight
<p><b>1 Link insertion loss, return loss and length</b></p>	<p>The planning and construction of inner-city cabling between sites is expensive and complex. Once the cables have been installed loss testing provides the basis for performance to be measured against specification. EXFO's FTBx-945 offers automated bidirectional testing to predefined limits.</p>	 <p>FTBx-945 in FTB-1v2/Pro (pair)</p> <div style="display: flex; justify-content: center; gap: 10px;"> <a href="#" style="background-color: #0070C0; color: white; border-radius: 10px; padding: 5px 15px; text-decoration: none;">Product page</a> <a href="#" style="background-color: #0070C0; color: white; border-radius: 10px; padding: 5px 15px; text-decoration: none;">Spec sheet</a> </div>
<p><b>2 Event mapping, fiber attenuation and fault detection</b></p>	<p>In addition to loss testing, event mapping is often completed to further characterize the link. This measures the loss, reflectance and location of connectors, splices, bends and breaks. EXFO's FTBx-740C offers fully automated analysis across C-band DWDM and 18 CWDM wavelengths.</p>	 <p>FTBx-740C in FTB-1v2/Pro with iOLM</p> <div style="display: flex; justify-content: center; gap: 10px;"> <a href="#" style="background-color: #0070C0; color: white; border-radius: 10px; padding: 5px 15px; text-decoration: none;">Product page</a> <a href="#" style="background-color: #0070C0; color: white; border-radius: 10px; padding: 5px 15px; text-decoration: none;">Spec sheet</a> </div>

# Metro and edge DCI

- > 1. Link loss
- 2. Event mapping
- 3. Dispersion
- 4. Inspection
- 5. DWDM
- 6. BERT
- 7. Protocol
- 8. Monitoring
- 9. Test management



## Construction – Fiber characterization

Use case	Challenge	Product spotlight
<p><b>3</b> <b>Optical dispersion and fiber quality</b></p>	<p>Longer metro links may require engineering to manage dispersion issues. This is especially true on inner-city links comprising segments made up of older fibers. EXFO's FTB-5700 is a unique single-ended test solution for measuring both chromatic and polarization dispersion.</p>	<div style="text-align: center;">  <p>FTB-5700 in FTB-2/Pro</p> </div> <div style="display: flex; justify-content: center; gap: 20px; margin-top: 10px;"> <a href="#" style="background-color: #007bff; color: white; border-radius: 10px; padding: 5px 15px; text-decoration: none;">Product page</a> <a href="#" style="background-color: #007bff; color: white; border-radius: 10px; padding: 5px 15px; text-decoration: none;">Spec sheet</a> </div>
<p><b>4</b> <b>Connector endface analysis</b></p>	<p>Routes between regional and edge sites carry diverse workloads potentially using wavelength division multiplexing technologies to maximum fiber capacity. This will require high-quality terminations into end locations. EXFO's FIP-435 offers fully automated connector analysis to industry standards.</p>	<div style="text-align: center;">  <p>FIP-435 B</p> </div> <div style="display: flex; justify-content: center; gap: 20px; margin-top: 10px;"> <a href="#" style="background-color: #007bff; color: white; border-radius: 10px; padding: 5px 15px; text-decoration: none;">Product page</a> <a href="#" style="background-color: #007bff; color: white; border-radius: 10px; padding: 5px 15px; text-decoration: none;">Spec sheet</a> </div>

# Metro and edge DCI

- > 1. Link loss
- 2. Event mapping
- 3. Dispersion
- 4. Inspection
- 5. DWDM
- 6. BERT
- 7. Protocol
- 8. Monitoring
- 9. Test management



## Operation – Network performance and fault resolution

Use case	Challenge	Product spotlight
<p><b>5 DWDM spectrum and channel verification</b></p>	<p>Routes between regional data centers may use DWDM to maximize fiber capacity. With different services and customers operating on a single fiber troubleshooting issues on specific channels can be difficult. EXFO's FTBx-5255 offers in-service channel power verification and fault detection (OTDR-based) from a single port.</p>	 <p>FTBx-5205 in FTB-1v2/Pro with iOLM</p> <div style="display: flex; justify-content: center; gap: 10px;"> <div style="background-color: #007bff; color: white; border-radius: 15px; padding: 5px 15px; text-decoration: none;">Product page</div> <div style="background-color: #007bff; color: white; border-radius: 15px; padding: 5px 15px; text-decoration: none;">Spec sheet</div> <div style="background-color: #007bff; color: white; border-radius: 15px; padding: 5px 15px; text-decoration: none;">Virtual demo</div> </div>
<p><b>6 Bit-error-rate test (BERT)</b></p>	<p>Metro and edge links are expected to deliver high throughput and low latency. This is made possible by guaranteeing error-free transmission through network elements and fiber infrastructure. EXFO's BERT test applications will verify error-free transmission from 1G to 400G for coherent and non-coherent transports links.</p>	 <p>FTBx-88480 in FTB-1v2/Pro with BERT apps</p> <div style="display: flex; justify-content: center; gap: 10px;"> <div style="background-color: #007bff; color: white; border-radius: 15px; padding: 5px 15px; text-decoration: none;">Product page</div> <div style="background-color: #007bff; color: white; border-radius: 15px; padding: 5px 15px; text-decoration: none;">Spec sheet</div> </div>

# Metro and edge DCI

- > 1. Link loss
- 2. Event mapping
- 3. Dispersion
- 4. Inspection
- 5. DWDM
- 6. BERT
- 7. Protocol
- 8. Monitoring
- 9. Test management

## Operation – Network performance and fault resolution

Use case	Challenge	Product spotlight
<p><b>7</b> <b>Bandwidth (throughput), latency, frame loss and frame delay variation (jitter)</b></p>	<p>Networks support multiple applications requiring different levels of performance. ITU Y.1564 provides a standardized methodology to verify defined parameters of the service-level agreement (SLA). EXFO's EtherSAM validates network configuration and performance parameters from 1G to 400G.</p>	 <p>FTBx-88480 in FTB-1v2/Pro with EtherSAM</p> <div style="display: flex; justify-content: center; gap: 10px;"> <a href="#" style="background-color: #0056b3; color: white; border-radius: 10px; padding: 5px 15px; text-decoration: none;">Product page</a> <a href="#" style="background-color: #0056b3; color: white; border-radius: 10px; padding: 5px 15px; text-decoration: none;">Spec sheet</a> </div>
<p><b>8</b> <b>Fiber monitoring and fault detection</b></p>	<p>Metro and edge interconnection traffic is growing as more data center sites come online. Without real-time analysis operators must react to problems from different sources making it difficult to assign responsibility. EXFO's OTH-7000 offers compact and scalable monitoring with flexible expansion capabilities.</p>	 <p>OTH-7000</p> <div style="display: flex; justify-content: center; gap: 10px;"> <a href="#" style="background-color: #0056b3; color: white; border-radius: 10px; padding: 5px 15px; text-decoration: none;">Product page</a> <a href="#" style="background-color: #0056b3; color: white; border-radius: 10px; padding: 5px 15px; text-decoration: none;">Spec sheet</a> </div>
<p><b>9</b> <b>Workflow and test management</b></p>	<p>Data center testing requires significant coordination to ensure tests are conducted efficiently and correctly. EXFO's Exchange software platform guides technicians through the test process storing results for analytics, reporting and business intelligence.</p>	

# Campus DCI

- > 1. Link loss
- 2. Event mapping
- 3. Inspection
- 4. Optical power
- 5. BERT
- 6. Transceiver
- 7. Test management

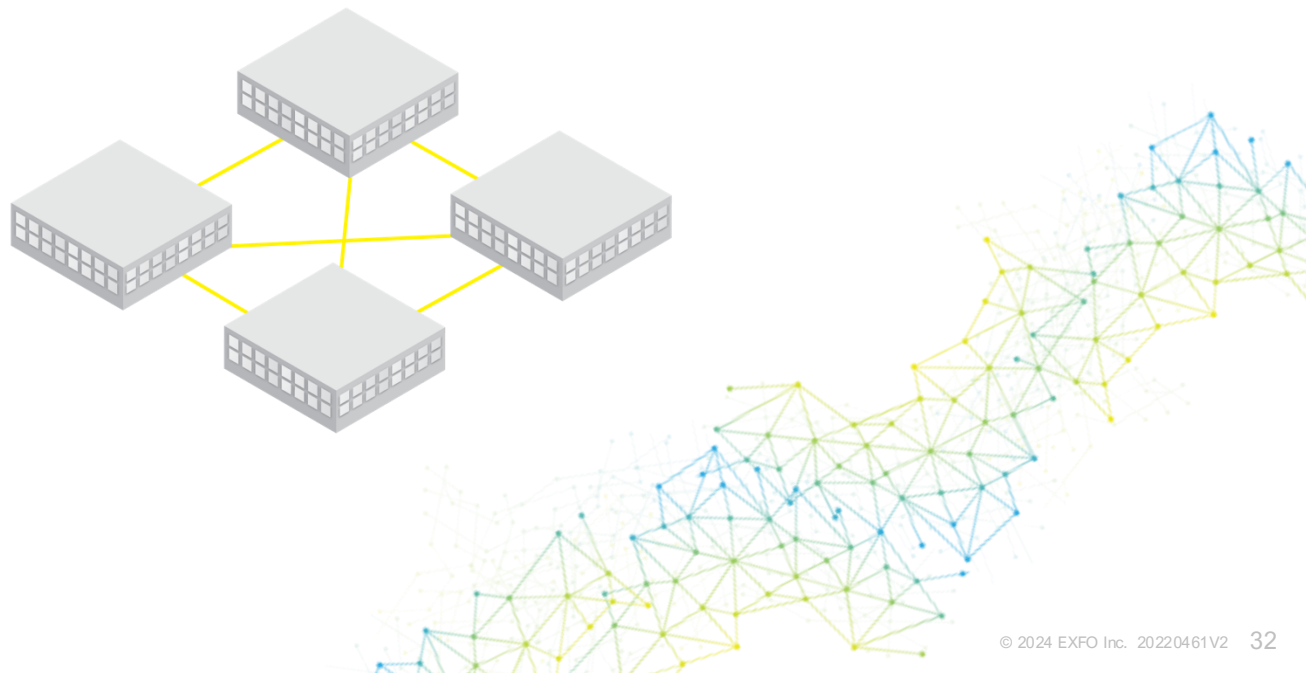





# Campus DCI

- [1. Link loss](#)
- [2. Event mapping](#)
- [3. Inspection](#)
- [4. Optical power](#)
- [5. BERT](#)
- [6. Transceiver](#)
- [7. Test management](#)

## Construction – Fiber characterization

Use case	Challenge	Product spotlight
<p><b>1 Link insertion loss, polarity and fiber length</b></p>	<p>Multiple cables containing up to 6192 fibers are used to interconnect buildings on a campus. These high-speed links form the backbone of the network infrastructure supporting localized data center traffic. EXFO's MAX-945 offers rapid Tier-1 certification on duplex fibers to ISO and TIA standards.</p>	 <p>MAX-945 (pair)</p> <div style="display: flex; justify-content: center; gap: 10px;"> <a href="#" style="background-color: #007bff; color: white; border-radius: 10px; padding: 5px 15px; text-decoration: none;">Product page</a> <a href="#" style="background-color: #007bff; color: white; border-radius: 10px; padding: 5px 15px; text-decoration: none;">Spec sheet</a> </div>
<p><b>2 Event mapping, fiber attenuation and fault detection</b></p>	<p>In addition to Tier-1 certification, OTDR-based testing measures the loss, reflectance and location of connectors, splices, bends and breaks. This is often recommended for external cabling due to the increased complexity of installation. EXFO's MAX-720D with iCERT offers fully automated Tier-2 certification to standards.</p>	 <p>MAX-720D with iCERT</p> <div style="display: flex; justify-content: center; gap: 10px;"> <a href="#" style="background-color: #007bff; color: white; border-radius: 10px; padding: 5px 15px; text-decoration: none;">Product page</a> <a href="#" style="background-color: #007bff; color: white; border-radius: 10px; padding: 5px 15px; text-decoration: none;">Spec sheet</a> </div>

# Campus DCI

- > 1. Link loss
- 2. Event mapping
- 3. Inspection**
- 4. Optical power
- 5. BERT
- 6. Transceiver
- 7. Test management



## Construction – Fiber characterization

Use case	Challenge	Product spotlight
<b>3 Connector endface analysis</b>	Most campus backbones will carry high-speed data up to 400G using short-range optics. These systems use complex modulation schemes such as PAM-4 which are less tolerant to connector reflections. EXFO's FIP-500 offers a unique solution to inspect single, duplex and MPO connectors in-and-out of adapters to IEC standards.	 FIP-500 <a href="#">Product page</a> <a href="#">Spec sheet</a> <a href="#">Virtual demo</a>

# Campus DCI

- > 1. Link loss
- 2. Event mapping
- 3. Inspection
- 4. Optical power
- 5. BERT
- 6. Transceiver
- 7. Test management



## Operation – Network performance and fault resolution

Use case	Challenge	Product spotlight
<p><b>4 Measure power and locate fiber faults</b></p>	<p>Resolving issues on upper-layer links is critical to the overall performance of the switching fabric. Faults can stem from system optics and fiber cabling issues such as damaged connectors, splices, bends, or breaks. EXFO's Optical Explorer (OX1) is the industry's first fiber multimeter designed for ease of operation and rapid fault detection.</p>	<div style="text-align: center;">  <p>Optical Explorer (OX1)</p> </div> <div style="display: flex; justify-content: flex-end; gap: 10px; margin-top: 10px;"> <div style="background-color: #00a0e3; border-radius: 10px; padding: 5px 15px; text-align: center; color: white;">Product page</div> <div style="background-color: #00a0e3; border-radius: 10px; padding: 5px 15px; text-align: center; color: white;">Spec sheet</div> <div style="background-color: #00a0e3; border-radius: 10px; padding: 5px 15px; text-align: center; color: white;">Virtual demo</div> </div>
<p><b>5 Bit-error-rate test (BERT)</b></p>	<p>Network optics are often subject to network upgrades to support increased data rates. Measuring link performance helps reassure the operator that the physical infrastructure will support the chosen speeds. EXFO's EtherBERT test application measures throughput and latency to verify error-free transmission at multiple frame sizes from 1G to 400G.</p>	<div style="text-align: center;">  <p>FTBx-88480 in FTB-1v2/Pro with EtherBERT</p> </div> <div style="display: flex; justify-content: flex-end; gap: 10px; margin-top: 10px;"> <div style="background-color: #00a0e3; border-radius: 10px; padding: 5px 15px; text-align: center; color: white;">Product page</div> <div style="background-color: #00a0e3; border-radius: 10px; padding: 5px 15px; text-align: center; color: white;">Spec sheet</div> </div>

# Campus DCI

- > 1. Link loss
- 2. Event mapping
- 3. Inspection
- 4. Optical power
- 5. BERT
- 6. Transceiver**
- 7. Test management

## Operation – Network performance and fault resolution

Use case	Challenge	Product spotlight
<p><b>6 Identify defective transceivers</b></p>	<p>Literally thousands of pluggable transceivers must operate efficiently at the top of the switching fabric to maximize performance and minimize power consumption. Operators often replace suspect or faulty transceivers to return service and are left with many quarantined devices. EXFO iOptics offers an automated test sequence for fault identification of transceivers and/or patchcords with minimal configuration.</p>	 <p>FTBx-88480 in FTB-1v2/Pro with iOptics</p> <div style="display: flex; justify-content: center; gap: 20px;"> <a href="#" style="background-color: #007bff; color: white; padding: 5px 15px; border-radius: 10px;">Product page</a> <a href="#" style="background-color: #007bff; color: white; padding: 5px 15px; border-radius: 10px;">Spec sheet</a> </div>
<p><b>7 Workflow and test management</b></p>	<p>Data center testing requires significant coordination to ensure tests are conducted efficiently and correctly. EXFO's Exchange software platform guides technicians through the test process storing results for analytics, reporting and business intelligence.</p>	

# Meet-me-room (MMR) to colocation space

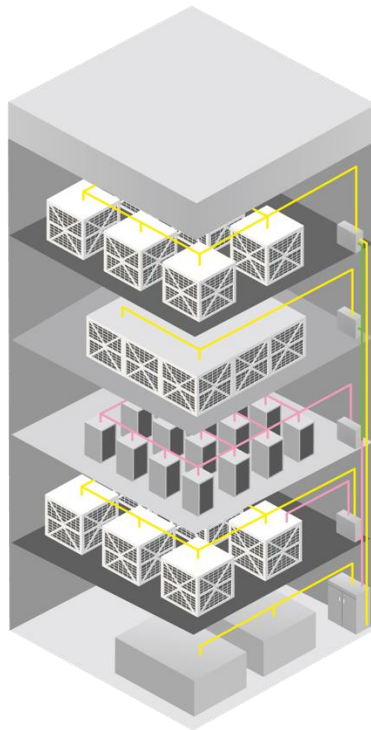

- > 1. Link loss
- 2. Event mapping
- 3. Inspection
- 4. Optical power
- 5. BERT
- 6. Fiber tracing
- 7. Test management



# MMR to colocation space

- [1. Link loss](#)
- [2. Event mapping](#)
- [3. Inspection](#)
- [4. Optical power](#)
- [5. BERT](#)
- [6. Fiber tracing](#)
- [7. Test management](#)

## Construction – Fiber characterization

Use case	Challenge	Product spotlight
<p><b>1</b> <a href="#">Link insertion loss, polarity and fiber length</a></p>	<p>The distribution network within a colocation facility often follows structured cabling principles to allow for rapid connection to and between tenants. This infrastructure provides the basis for delivering services to clients. EXFO's MAX-945 offers rapid Tier-1 certification on duplex fibers to ISO and TIA standards.</p>	<div style="text-align: center;">  <p>MAX-945 (pair)</p> </div> <div style="text-align: right; margin-top: 10px;"> <a href="#">Product page</a>  <a href="#">Spec sheet</a> </div>
<p><b>2</b> <a href="#">Event mapping, fiber attenuation and fault detection</a></p>	<p>Larger colocation facilities with more complex routes may require additional OTDR-based testing. This allows users to measure the loss, reflectance and location of events such as connectors, splices, bends and breaks. EXFO's MAX-720D with iCERT offers fully automated Tier-2 certification to standards.</p>	<div style="text-align: center;">  <p>MAX-720D with iCERT</p> </div> <div style="text-align: right; margin-top: 10px;"> <a href="#">Product page</a>  <a href="#">Spec sheet</a> </div>

# MMR to colocation space

- >
- 1. Link loss
- 2. Event mapping
- 3. Inspection
- 4. Optical power
- 5. BERT
- 6. Fiber tracing
- 7. Test management



## Construction – Fiber characterization

Use case	Challenge	Product spotlight
<p><b>3 Connector endface analysis</b></p>	<p>Termination points between the MMR and colo space interconnect customers through structured cabling to service providers and other tenants. These routes may pass through cross-connections which are busy areas susceptible to contamination. EXFO's FIP-500 offers a unique solution to inspect single, duplex and MPO connectors in-and-out of adapters to IEC standards.</p>	 <p>FIP-500</p> <div style="display: flex; flex-direction: column; gap: 10px;"> <a href="#" style="background-color: #0070C0; color: white; border-radius: 10px; padding: 5px 15px; text-decoration: none;">Product page</a> <a href="#" style="background-color: #0070C0; color: white; border-radius: 10px; padding: 5px 15px; text-decoration: none;">Spec sheet</a> <a href="#" style="background-color: #0070C0; color: white; border-radius: 10px; padding: 5px 15px; text-decoration: none;">Virtual demo</a> </div>

# MMR to colocation space

- > 1. Link loss
- 2. Event mapping
- 3. Inspection
- 4. Optical power
- 5. BERT
- 6. Fiber tracing
- 7. Test management

## Operation – Network performance and fault resolution



Use case	Challenge	Product spotlight
<p><b>4 Measure power and locate fiber faults</b></p>	<p>Keeping clients connected to service providers and tenants is often the responsibility of the colocation operator or their contractors. Resolving issues swiftly is therefore critical to client satisfaction. EXFO's Optical Explorer (OX1) is the industry's first fiber multimeter designed for ease of operation and rapid fault detection.</p>	 <p>Optical Explorer (OX1)</p> <div style="display: flex; flex-direction: column; gap: 10px;"> <a href="#" style="background-color: #00AEEF; border-radius: 15px; padding: 5px 15px; text-decoration: none; color: white;">Product page</a> <a href="#" style="background-color: #00AEEF; border-radius: 15px; padding: 5px 15px; text-decoration: none; color: white;">Spec sheet</a> <a href="#" style="background-color: #00AEEF; border-radius: 15px; padding: 5px 15px; text-decoration: none; color: white;">Virtual demo</a> </div>
<p><b>5 Bit-error-rate test (BERT)</b></p>	<p>Commissioning fiber links for tenants should involve performance validation because these routes can involve multiple connections. This provides a birth certificate that can be used as a reference to resolve future issues. EXFO's EtherBERT test application validates optical parameters and throughput to verify error-free transmission at multiple frame sizes from 1 to 400 G/bits.</p>	 <p>FTBx-88480 in FTB-1v2/Pro with EtherBERT</p> <div style="display: flex; flex-direction: column; gap: 10px;"> <a href="#" style="background-color: #00AEEF; border-radius: 15px; padding: 5px 15px; text-decoration: none; color: white;">Product page</a> <a href="#" style="background-color: #00AEEF; border-radius: 15px; padding: 5px 15px; text-decoration: none; color: white;">Spec sheet</a> </div>



# MMR to colocation space

- > 1. Link loss
- 2. Event mapping
- 3. Inspection
- 4. Optical power
- 5. BERT
- 6. Fiber tracing**
- 7. Test management

## Operation – Network performance and fault resolution

Use case	Challenge	Product spotlight
<p><b>6 Identify cables in cross connect for patching</b></p>	<p>Cross connections within optical distribution frames enable quick and easy reconfiguration of the network. However, locating cable runs can become difficult as records become outdated. EXFO's LFD-300B identifies live and dark fibers with tone detection for cable tracing.</p>	 <p>LFD-300B</p> <div style="display: flex; justify-content: center; gap: 20px;"> <a href="#" style="border: 1px solid #0056b3; border-radius: 15px; padding: 5px 15px; color: white; text-decoration: none;">Product page</a> <a href="#" style="border: 1px solid #0056b3; border-radius: 15px; padding: 5px 15px; color: white; text-decoration: none;">Spec sheet</a> </div>
<p><b>7 Workflow and test management</b></p>	<p>Data center testing requires significant coordination to ensure tests are conducted efficiently and correctly. EXFO's Exchange software platform guides technicians through the test process storing results for analytics, reporting and business intelligence.</p>	

# Main distribution area (MDA) to equipment distribution area (EDA)

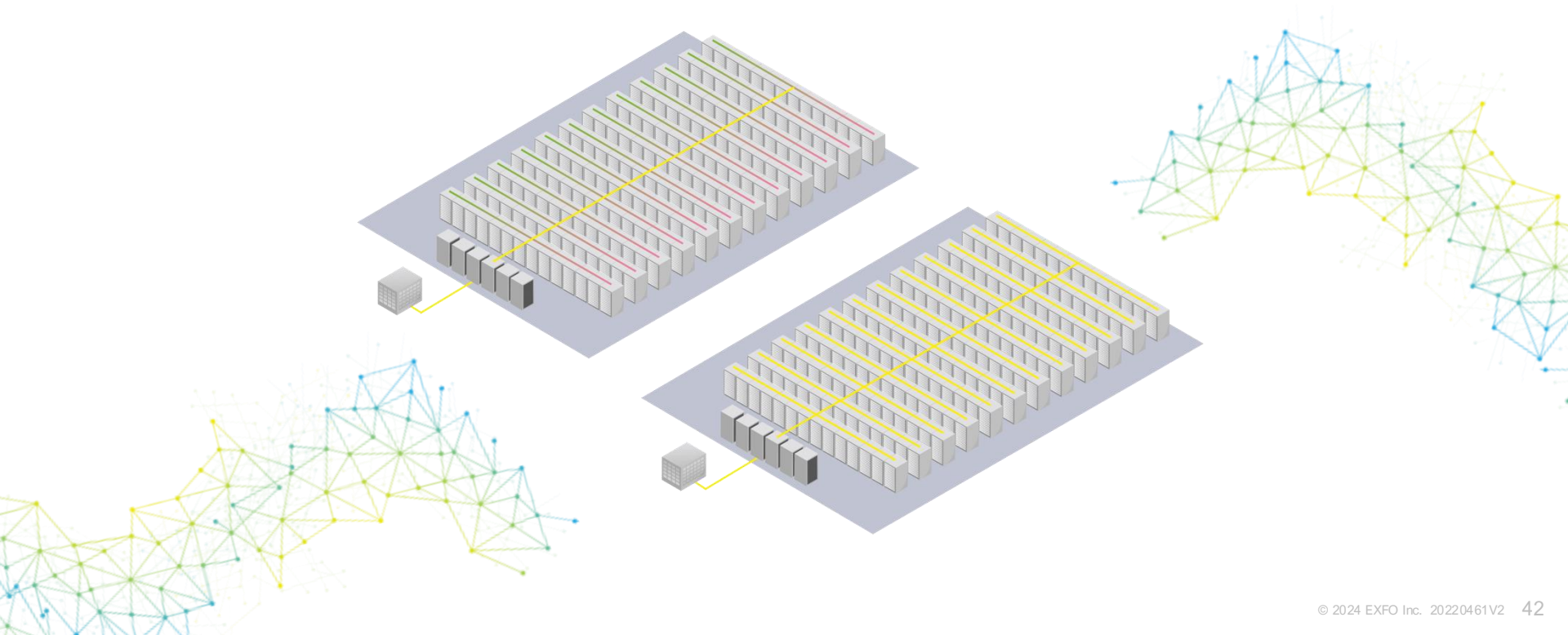

- > 1. Link loss
- 2. Event mapping
- 3. Inspection
- 4. Optical power
- 5. Fiber tracing
- 6. BERT
- 7. Transceivers
- 8. AOCs
- 9. Test management



# MDA to EDA

- > 1. Link loss
- 2. Event mapping
- 3. Inspection
- 4. Optical power
- 5. Fiber tracing
- 6. BERT
- 7. Transceivers
- 8. AOCs
- 9. Test management

## Construction – Fiber characterization

Use case	Challenge	Product spotlight
<p><b>1 Link insertion loss, polarity and fiber length</b></p>	<p>Connecting server racks to spine and leaf fabrics requires massive volume of fibers and cables. This is often done through structured cabling which is tested to ensure permanent links meet low loss performance budgets. EXFO PXM/LXM offers rapid Tier-1 certification of MPO terminated cables.</p>	 <p>PXM/LXM</p> <div style="display: flex; flex-direction: column; gap: 5px;"> <a href="#" style="background-color: #0070c0; color: white; border-radius: 10px; padding: 5px 15px; text-decoration: none;">Product page</a> <a href="#" style="background-color: #0070c0; color: white; border-radius: 10px; padding: 5px 15px; text-decoration: none;">Spec sheet</a> <a href="#" style="background-color: #0070c0; color: white; border-radius: 10px; padding: 5px 15px; text-decoration: none;">Virtual demo</a> </div>
<p><b>2 Event mapping, fiber attenuation and fault detection</b></p>	<p>In addition to Tier-1 certification, OTDR-based testing measures the loss, reflectance and location of connectors, splices, bends and breaks. This is recommended for more complex routes with cross-connections. EXFO's MAX-720D with iCERT offers fully automated Tier-2 certification to standards.</p>	 <p>MAX-720 D with iCERT</p> <div style="display: flex; flex-direction: column; gap: 5px;"> <a href="#" style="background-color: #0070c0; color: white; border-radius: 10px; padding: 5px 15px; text-decoration: none;">Product page</a> <a href="#" style="background-color: #0070c0; color: white; border-radius: 10px; padding: 5px 15px; text-decoration: none;">Spec sheet</a> </div>

# MDA to EDA

- > 1. Link loss
- 2. Event mapping
- 3. Inspection**
- 4. Optical power
- 5. Fiber tracing
- 6. BERT
- 7. Transceivers
- 8. AOCs
- 9. Test management



## Construction – Fiber characterization

Use case	Challenge	Product spotlight
<p><b>3 Connector endface analysis</b></p>	<p>Distributing fiber cables to server racks presents massive connectivity challenges. Cable breakouts and transitions may involve multiple connector types from duplex to MPO-8/12/16/24. EXFO's FIP-500 offers a unique solution to inspect single, duplex and multi-fiber connectors in-and-out of adapters to IEC standards.</p>	<div style="text-align: center;">  <p>FIP-500</p> </div> <div style="margin-top: 10px;"> <a href="#" style="background-color: #0070C0; color: white; border-radius: 10px; padding: 5px 15px; display: inline-block; margin-bottom: 5px;">Product page</a>  <a href="#" style="background-color: #0070C0; color: white; border-radius: 10px; padding: 5px 15px; display: inline-block; margin-bottom: 5px;">Spec sheet</a>  <a href="#" style="background-color: #0070C0; color: white; border-radius: 10px; padding: 5px 15px; display: inline-block;">Virtual demo</a> </div>

# MDA to EDA

- > 1. Link loss
- 2. Event mapping
- 3. Inspection
- 4. Optical power
- 5. Fiber tracing
- 6. BERT
- 7. Transceivers
- 8. AOCs
- 9. Test management



## Operation – Network performance and fault resolution

Use case	Challenge	Product spotlight
<p><b>4 Measure power and locate fiber faults</b></p>	<p>Physical layer faults in data centers are either related to system optics or the network cabling. Isolating the cause is time-consuming and network outage is costly. EXFO's Optical Explorer (OX1) is the industry's first fiber multimeter designed for ease of operation and rapid fault detection.</p>	 <p>Optical Explorer (OX1)</p> <div style="display: flex; justify-content: center; gap: 10px;"> <a href="#" style="background-color: #0070c0; color: white; border-radius: 10px; padding: 5px 15px; text-decoration: none;">Product page</a> <a href="#" style="background-color: #0070c0; color: white; border-radius: 10px; padding: 5px 15px; text-decoration: none;">Spec sheet</a> <a href="#" style="background-color: #0070c0; color: white; border-radius: 10px; padding: 5px 15px; text-decoration: none;">Virtual demo</a> </div>
<p><b>5 Identify cables between racks</b></p>	<p>Optical distribution frames and racks can contain 10,000s of fibers and 1000s of cables. Keeping track of connections and maintaining records can become overwhelming making moves, adds and changes complex. EXFO offers a unique solution that allows users to inject and detect tones on fiber cables without disconnection or service interruption.</p>	 <p>LFD-300B/TG-300B</p> <div style="display: flex; justify-content: center; gap: 10px;"> <a href="#" style="background-color: #0070c0; color: white; border-radius: 10px; padding: 5px 15px; text-decoration: none;">Product page</a> <a href="#" style="background-color: #0070c0; color: white; border-radius: 10px; padding: 5px 15px; text-decoration: none;">Spec sheet</a> </div>

# MDA to EDA

>	1. Link loss	2. Event mapping	3. Inspection	4. Optical power	5. Fiber tracing	<b>6. BERT</b>	7. Transceivers	8. AOCs	9. Test management
---	--------------	------------------	---------------	------------------	------------------	----------------	-----------------	---------	--------------------



## Operation – Network performance and fault resolution

Use case	Challenge	Product spotlight
<p><b>6 Bit-error-rate test (BERT)</b></p>	<p>Network cabling connecting server racks can be a mixture of copper, multimode and singlemode fiber that should be technology agnostic. These links are often subject to upgrades to support high data rates and may require ethernet or fiber channel validation. EXFO's EtherBERT or FCBERT applications verify error-free transmission.</p>	 <p>FTBx-88460 in FTB-1v2/Pro with EtherBERT</p> <p><a href="#">Product page</a></p> <p><a href="#">Spec sheet</a></p>
<p><b>7 Identify defective transceivers</b></p>	<p>Larger data centers rely on hundreds of thousands of pluggable transceivers operating efficiently to deliver hyperscale cloud services. Operators often replace suspect or faulty transceivers to return service and are left with many quarantined devices. EXFO iOptics offers an automated test sequence for fault identification of transceivers and patchcords with minimal configuration.</p>	 <p>FTBx-88480 in FTB-1v2/Pro with EtherBERT</p> <p><a href="#">Product page</a></p> <p><a href="#">Spec sheet</a></p>

# MDA to EDA

- > 1. Link loss
- 2. Event mapping
- 3. Inspection
- 4. Optical power
- 5. Fiber tracing
- 6. BERT
- 7. Transceivers
- 8. AOCs
- 9. Test management

## Operation – Network performance and fault resolution

Use case	Challenge	Product spotlight
<p><b>8 Identify defective AOCs</b></p>	<p>Active Optical Cables (AOCs) are treated as consumable items primarily used to connect switches to servers as an alternative to transceivers and equipment cords. Discarding these cables when links fail can be extremely costly. EXFO iOptics offers a test sequence to validate both the opto-electrical properties and communication channel.</p>	 <p>FTBx-88480 in FTB-1v2/Pro with iOptics</p> <div style="display: flex; flex-direction: column; gap: 5px;"> <a href="#" style="background-color: #0070c0; color: white; border-radius: 10px; padding: 5px 15px; text-decoration: none;">Product page</a> <a href="#" style="background-color: #0070c0; color: white; border-radius: 10px; padding: 5px 15px; text-decoration: none;">Spec sheet</a> <a href="#" style="background-color: #0070c0; color: white; border-radius: 10px; padding: 5px 15px; text-decoration: none;">Solution brief</a> </div>
<p><b>9 Workflow and test management</b></p>	<p>Data center testing requires significant coordination to ensure tests are conducted efficiently and correctly. EXFO's Exchange software platform guides technicians through the test process storing results for analytics, reporting and business intelligence.</p>	

# Glossary

AI	artificial intelligence
AMPU	average margin per user
API	application programming interface
CNF	containerized network function
CSP	communications service providers
EDA	equipment distribution area
eMBB	enhanced mobile broadband communications
IoT	Internet of Things
LLC	low latency communications
LTE	long term evolution (4G)
M2M	machine to machine
MDA	main distribution area
MEC	mobile edge compute
ML	machine learning
MMR	meet-me-room
mMTC	massive machine type communications

NFV	network function virtualization
NFVI	network function virtualization infrastructure
NPS	net promoter score
OTT	over the top
PNF	physical network function
QoE	quality of experience
QoS	quality of service
SLA	service level agreement
SP	service provider
UR	ultra reliable
VNF	virtualized network function
VoIP	Voice over IP
VoLTE	Voice or LTE

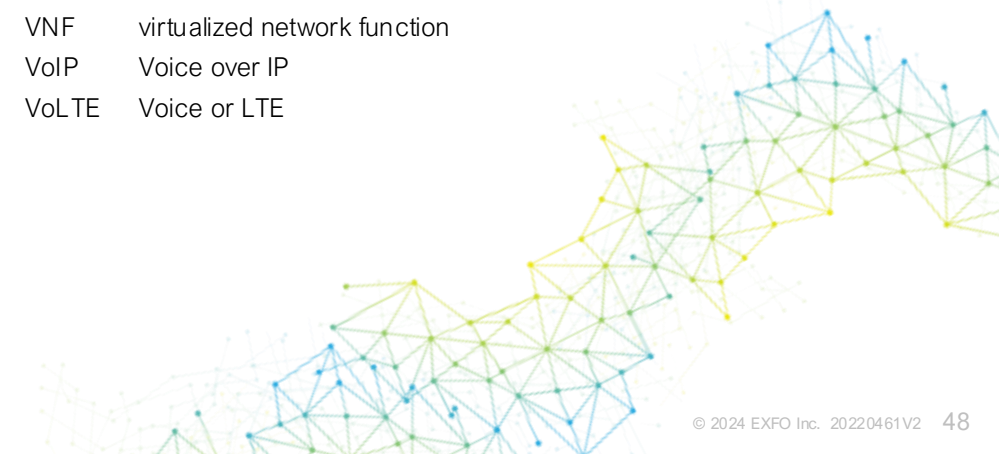



## EXFO corporate headquarters

---

400 Godin Avenue, Quebec City (Quebec) G1M 2K2 CANADA  
T +1 418 683-0211

---

Toll-free (USA and Canada)

**1 800 663-3936**

[info@EXFO.com](mailto:info@EXFO.com)

[EXFO.com](https://EXFO.com)

